



MultiFiber™ Pro

Optical Power Meter and Fiber Test Kits

Getting Started Guide

PN 4094934

May 2012, Rev. 3 8/2015

©2012-2015 Fluke Corporation

All product names are trademarks of their respective companies.

LIMITED WARRANTY AND LIMITATION OF LIABILITY

Fluke Networks mainframe products will be free from defects in material and workmanship for one year from the date of purchase, unless stated otherwise herein. Parts, accessories, product repairs and services are warranted for 90 days, unless otherwise stated. Ni-Cad, Ni-MH and Li-Ion batteries, cables or other peripherals are all considered parts or accessories. This warranty does not cover damage from accident, neglect, misuse, alteration, contamination, or abnormal conditions of operation or handling. Resellers are not authorized to extend any other warranty on Fluke Networks' behalf.

To obtain service during the warranty period, contact your nearest Fluke Networks authorized service center to obtain return authorization information, then send your defective product to that Service Center with a description of the problem.

For a list of authorized resellers, visit www.flukenetworks.com/wheretobuy.

THIS WARRANTY IS YOUR ONLY REMEDY. NO OTHER WARRANTIES, SUCH AS FITNESS FOR A PARTICULAR PURPOSE, ARE EXPRESSED OR IMPLIED. FLUKE NETWORKS IS NOT LIABLE FOR ANY SPECIAL, INDIRECT, INCIDENTAL OR CONSEQUENTIAL DAMAGES OR LOSSES, ARISING FROM ANY CAUSE OR THEORY.

Since some states or countries do not allow the exclusion or limitation of an implied warranty or of incidental or consequential damages, this limitation of liability may not apply to you.

4/15

Fluke Networks
PO Box 777
Everett, WA 98206-0777
USA

Contents

Accessing the Users Manual.....	1
 Safety	1
Contacting Fluke Networks.....	2
Meter and Source Features	2
Battery Installation, Life, and Status	3
Meter Display Features	4
Source Display Features	7
User Preferences	8
Polarity Detection.....	9
Auto Wavelength Function.....	9
How to Clean MTP/MPO Connectors.....	9
How to Measure Optical Power	10
How to Measure Loss.....	11
Set the Reference.....	11
Set the Limit	13
Measure Loss	14
Memory Functions.....	16

Accessing the Users Manual

This guide provides basic information to help you get started using the MultiFiber™ Pro meter and source. For additional information, see the *MultiFiber Pro Users Manual* on the Fluke Networks website.

Safety

Warning

To prevent possible eye damage caused by hazardous radiation, do not look directly into optical connectors (see page 2). Some sources produce invisible radiation that can permanently damage your eyes.

Caution

To prevent damage to fiber connectors, to prevent data loss, and to ensure maximum accuracy of test results, use proper cleaning procedures to clean all fiber connectors before every use. Cover all connectors with protective caps when not in use.

Read the additional safety information in the *MultiFiber Pro Users Manual* before you use the meter or source.

Contacting Fluke Networks



www.flukenetworks.com



support@flukenetworks.com



1-800-283-5853, +1-425-446-5500



Fluke Networks

PO Box 777

Everett, WA 98206-0777

USA

Fluke Networks operates in more than 50 countries worldwide. For more contact information, go to our website.

Meter and Source Features

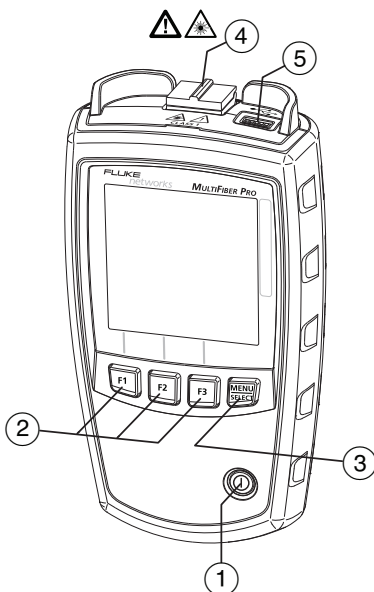

Battery Installation, Life, and Status

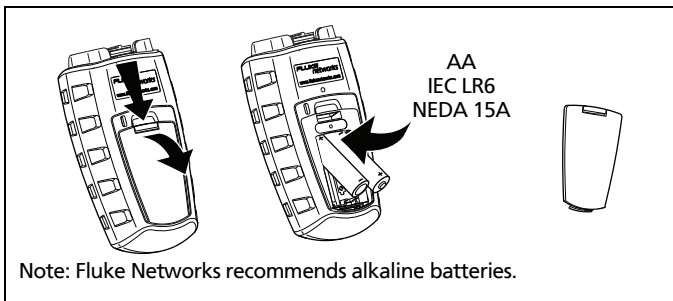

GUE02.EPS

The batteries operate for 30 hours minimum in the meter and source.

- ① **Ⓞ**: On/off key.
- ② **F1** **F2** **F3**: Softkeys. The function for each key shows above the key.
- ③ **MENU SELECT**: Meter: Press **MENU SELECT** to select power measurement or loss measurement mode. For access to a menu of test settings and the **VIEW RECORD** mode, hold down **MENU SELECT** for 2.5 seconds.
Source: To see modes for the source, hold down **MENU SELECT** for 2.5 seconds.
- ④ MTP/MPO connector with self-closing, protective cover.

⚠ Caution

For correct measurements, connect only APC connectors to the singlemode sources. Connect only non-APC connectors to the multimode source. You can connect APC or non-APC connectors to the meter.

- ⑤ USB port for uploading test records to a PC. You can also use the port to install software updates.

Meter Display Features

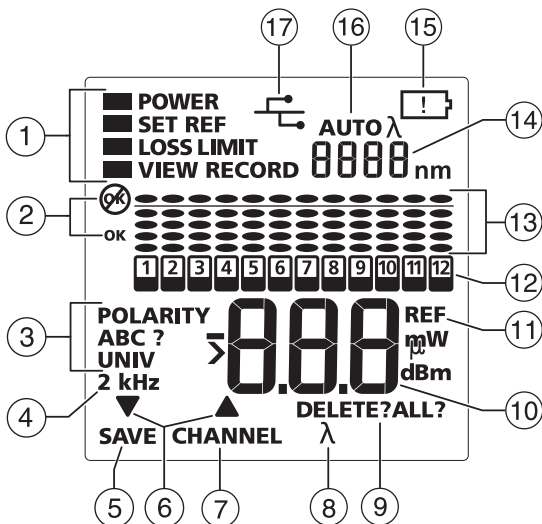





GUE03.EPS

① Modes for the meter and settings for tests. To select the **POWER**, **SET REF**, or **LOSS** measurement modes, press . To change settings for measurements or to view records, hold down for 2.5 seconds, then use \blacktriangledown \blacktriangle and to make selections.

- **POWER:** Use this mode to measure optical power. See "How to Measure Optical Power" on page 10.
- **SET REF:** Use this mode to set the reference for loss measurements. See "Set the Reference" on page 11.
- **LOSS:** Use this mode to measure loss. See "Measure Loss" on page 14.
- **LOSS LIMIT:** Use this mode to set the limit for loss measurements. See "Set the Limit" on page 13.
- **VIEW RECORD:** Use this mode to see and delete saved results. See "Memory Functions" on page 16.

- ② **OK**: There is a problem with a measurement, or you tried to save a measurement, but the memory is full.
OK: All measurements are satisfactory, or the meter saved the results.
- ③ **POLARITY**: The polarity of the connections between the meter and source:
 - **A, B, C**: The connections use a standard method, A, B, or C. See the Users Manual.
 - **POLARITY ?**: The connections do not use a standard method, one or more fibers are not connected, or **SCAN ALL** is off on the source.
 - **UNIV**: Shows when modules have the Corning Plug & Play™ Universal Systems method of polarity management.
- ④ **2 kHz**: The meter detects a 2 kHz modulated optical signal. This function helps you identify fibers at patch panels.
- ⑤ **SAVE**: When **SAVE** shows, you can press **F1** to save the power or loss measurement or the reference value.
- ⑥ **▼▲**: The arrow icons show when you can use **F1** ▼ or **F2** ▲ to scroll through selections or change settings.
- ⑦ **CHANNEL**: When you measure power or loss, press **F2** to scroll through the measurements for the channels.
- ⑧ **λ**: When the source is not in auto wavelength mode, press **F2** λ to change the wavelength.
- ⑨ **DELETE**: In **VIEW RECORD** mode, use **F3** **DELETE** to delete the selected record or all records. See "Memory Functions" on page 16.
- ⑩ Numeric display with units for loss (**dB**) and power measurements (**mW**, **μW**, **dBm**).
- ⑪ **REF** (reference): Shows when you save the reference level. See "Set the Reference" on page 11.

- ⑫ : Channel indicator. When the source's **SCAN ALL** function is on, the channel indicator is on the channel that you select. When the source's **SCAN ALL** function is off, the indicator stays on the channel you select on the source. The numbers for the channels flash in sequence when the meter measures power or loss.
- ⑬ The bargraphs show relative value of the loss or power measurement for each channel. For power measurements, see 10. For loss measurements, see page 15.
- ⑭ Numeric display for the wavelength.
- ⑮ : When the batteries are low, the low battery icon flashes.
- ⑯ **AUTO** λ shows when the source transmits a wavelength identifier, and the meter changes its wavelength setting to agree with the source. When only λ shows, you must press  λ on the meter to select the correct wavelength. See page "Polarity Detection" on page 9.
- ⑰ : This icon shows when the meter is connected to a PC through the USB port.

Source Display Features

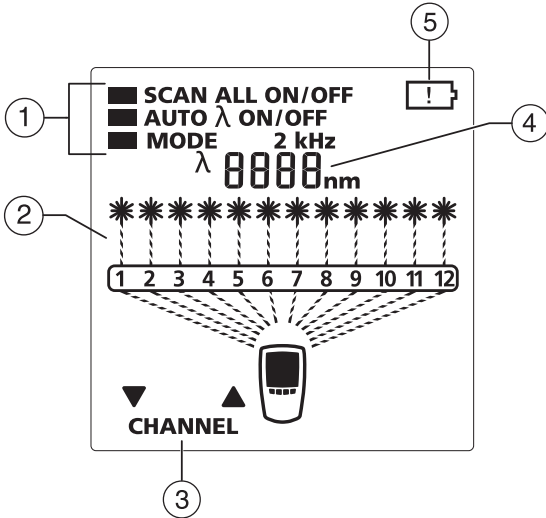

GUE04.EPS

- ① Modes for the source (to see the menu, hold down **MENU/SELECT** for 2.5 seconds):
 - **SCAN ALL ON:** The source changes the channel automatically.
 - **SCAN ALL OFF:** You press **F1** ▼ or **F2** ▲ to change the channel.
 - **AUTO λ ON:** The source transmits a wavelength identifier that a MultiFiber Pro meter can read.
 - **AUTO λ OFF:** The source does not transmit a wavelength identifier.
 - **MODE 2 kHz:** The output is a 2 kHz modulated optical signal. Use this mode to identify fibers at patch panels.
- ② Shows the channel that is active.
- ③ **CHANNEL:** When **SCAN ALL** is **OFF**, press **F1** ▼ or **F2** ▲ to change the channel.

- ④ Numeric display for the wavelength.
- ⑤ : When the batteries are low, the low battery icon flashes.

User Preferences

- 1 For the meter: Make sure the meter is in power or loss measurement mode.
For the source: Make sure the source is in signal output mode.
- 2 Hold down **F1** and **F3** together for 2.5 seconds.
- 3 To change a setting, press **F2** ▲. Or press **F1** if ▼ shows.
- 4 To see the next setting, press .
- 5 To save the settings and exit setup mode, hold down **F1** and **F3** for 2.5 seconds.

oFF oN	Turn the backlight off or on.
-- 10 20 30 60	The meter and source turn off automatically if you do not press any keys for the selected period of minutes. To disable this function, select the dashes (--).

ñt h dAY Yr hr ñn	Meter only: Month (ñt h), day (dAY), year (Yr), hour (hr), and minutes (ñn). The meter includes the date and time with measurements you save. The hour is in 24-hour format. To see the date and time in saved records, look at the records in LinkWare PC software.
Sof FAC	Sof : The software version number. FAC : Meter only. The factory calibration date.

Polarity Detection

You can use the MultiFiber Pro meter and source to see the polarity of MTP/MPO patch cords and cables. The signals from the source include the channel numbers. The meter compares the transmitted numbers to the numbers of the channels that received the signals. The meter can then show the polarity of the connections. See item ③ on page 5.

Auto Wavelength Function

The signal from the source includes an identifier that tells the meter which wavelength to measure. The source transmits the auto wavelength signal unless it is in **2 kHz** mode. When you select **2 kHz** mode, the source's **AUTO λ** setting automatically changes to **OFF**.

How to Clean MTP/MPO Connectors

Always clean and inspect endfaces in fiber connectors before you make connections. Fluke Networks recommends that you use a mechanical cleaner, such as the Fluke Networks IBC™ OneClick Cleaner, to clean connectors.

How to Measure Optical Power

A power measurement shows the optical power level from a source such as an optical network interface card or optical test equipment.

To measure power

- 1 Clean and inspect all connectors.
- 2 On the meter, press **MENU SELECT** to make **POWER** show.
- 3 Make the connections shown on page 11.
- 4 On the meter, press **F3** λ to select the wavelength of the source if necessary.
- 5 To see the power measurement for the next channel, press **F2** **CHANNEL**.

The bargraphs show the difference (in dB) between the level of power on each channel and the maximum power of all 12 channels:

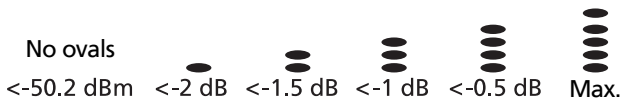

At regular intervals, the meter finds the maximum power level again and adjusts the bargraphs as necessary.

- 6 To save the measurements, make sure the meter has done a scan through all 12 channels, then press **F1** **SAVE**. The meter briefly shows the record number and **OK**. The record number shown is for fiber number 12 in the cable.

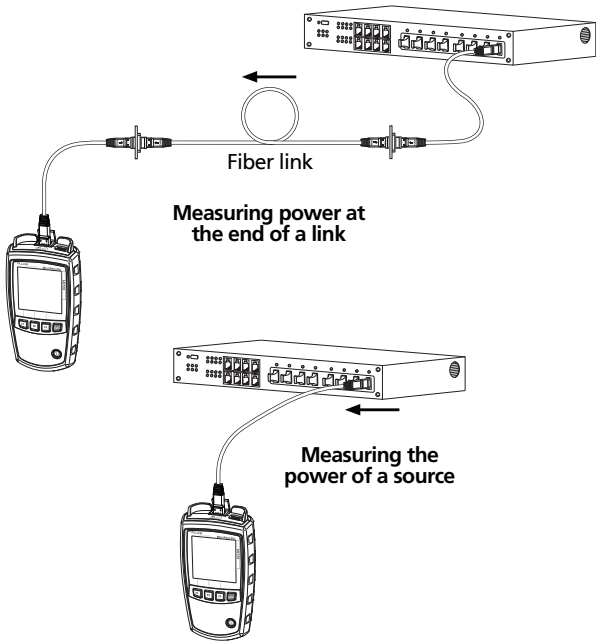

Connections for Power Measurements

GUE23.EPS

How to Measure Loss

The loss measurement shows how much optical power is lost in a link's fiber and connectors.

Set the Reference

For the most accurate test results, you should set the reference at these times:





- At the beginning of each day.
- Anytime you reconnect a test cord to the source.
- Anytime you see a negative loss measurement.

To set the reference

Caution

For correct measurements, connect only APC connectors to the singlemode sources. Connect only non-APC connectors to the multimode source.

For singlemode links with APC connectors, you must use Type A test cords and adapters. Type A components correctly align the angles in the connectors.

- 1 Clean the connectors on the meter, source, and a test cord.
- 2 Turn on the meter and source and let them warm up for 10 minutes. Allow more time if the equipment has been stored above or below ambient temperature.
- 3 Make connections to set the reference. The figure on page 13 shows reference connections for links with unpinned connectors. The Users Manual shows connections for links with other types of connectors and for fiber modules.
- 4 On the source, hold down  for 2.5 seconds to see the setup menu, then select these settings:
 - **SCAN ALL: ON**
 - **MODE: 2 kHz** does not show
- 5 On the meter, press  to make **SET REF** show.
- 6 If necessary, press  **CHANNEL** to see the power measurement for each channel.
- 7 To save the reference measurements, press  **SAVE**. The meter saves the measurements and the display briefly shows **rEF**, **OK** and **REF**. Then the meter goes into loss measurement mode.

If the display shows **Err** and **OK**, the power level is too low on one or more channels. This can be caused by a bad connection or incorrect settings on the source. See the Users Manual.

Caution

Do not disconnect test cord 1 from the source after you set the reference.

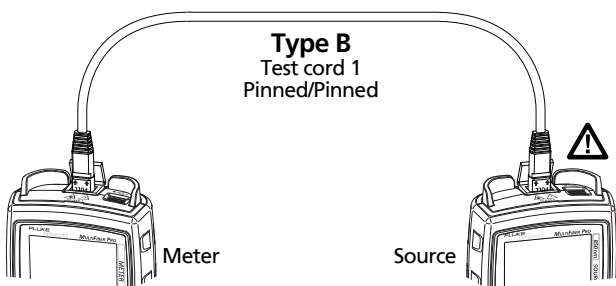



Reference Connections for Multimode Permanent Links with Unpinned MTP/MPO Connectors

Set the Limit

The meter compares loss measurements to a limit to give a status of **OK** or **OK** to the measurements. If a measurement for a channel exceeds the limit, **OK** flashes, the bargraph for that channel flashes, and the bargraph shows an oval above the limit line on the display.

To set the limit

- 1 On the meter, hold down  for 4 seconds to see the setup menu, press  to put the cursor next to **LOSS LIMIT**, then press  to put the meter in the loss limit mode.

-continued-

- 2 While **LOSS LIMIT** shows, press **F1** ▼ or **F2** ▲ to decrease or increase the limit value. To change the value quickly, hold down the key.
- 3 To save the setting and exit setup mode, press **MENU SELECT**, then hold down **MENU SELECT** for 2.5 seconds

Measure Loss

- 1 Set the reference as described on page 11.
- 2 Make sure the limit is correct. To see the limit, hold down **MENU SELECT** for 2.5 seconds, press **F1** ▼ to put the cursor next to **LOSS LIMIT**, then press **MENU SELECT**.
- 3 Clean and inspect the connectors on the link and on the required test cords.
- 4 Disconnect the test cord from the meter, then make the appropriate connections. The figure on page 15 shows connections for a link with unpinned connectors. The Users Manual shows connections for other types of links and connectors and for fiber modules.

Caution

Do not disconnect test cord 1 from the source. If you do, you must set the reference again to make sure the loss measurements are reliable.

For singlemode links with APC connectors, you must use Type A test cords and adapters. Type A components correctly align the angles in the connectors.

- 5 On the source, select these settings:
 - **SCAN ALL: ON**
 - **MODE: 2 kHz** does not show

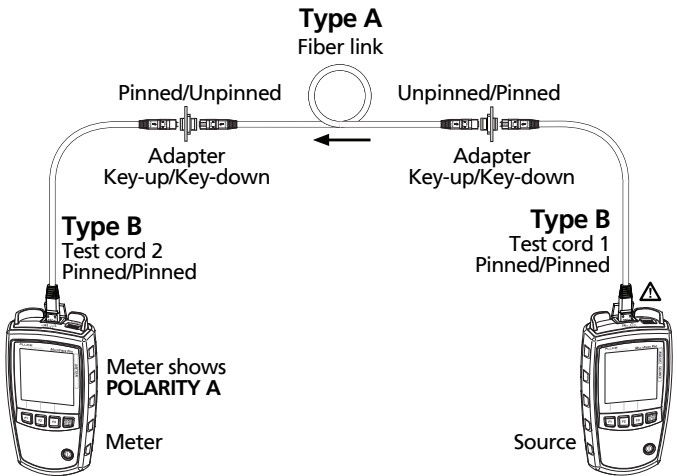



Connections for Loss Measurements on Type A Multimode Permanent Links with Unpinned MTP/MPO Connectors

- 6 On the meter, press  to make **LOSS** show.

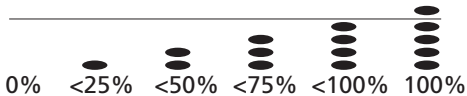
The bargraphs show the level of power loss relative to the limit you set:



- When all ovals are below the line for a channel, the measurement for that channel is below the limit you set.
- If the loss for a channel exceeds the limit, the oval above the line is on, and  and the bargraph for that channel flashes.
- If the loss is negative by more than -0.09 dB,  and the measurement flash on the meter. This can occur if there was a bad connection or some other problem when you set the reference. See the Users Manual.

-continued-

- 7 To save the measurements, make sure the meter has done a scan through all 12 channels, then press **F1** **SAVE**. The meter briefly shows the record number and **OK**. The record number shown is for the number 12 fiber on the cable.

Memory Functions

- The meter stores the loss or power measurements for up to 250 12-fiber cables.
- If memory is full, the meter shows **OK** and **FULL** when you try to save measurements.
- To view records, hold down **F3** for 2.5 seconds, press **F2** to put the cursor next to **VIEW RECORD**, then press **F3**.
- To scroll through the measurements for each fiber in a cable, press **F1** ▼ or **F2** ▲.
- To scroll through the measurements for the same fiber number in each cable, press **F1** ▼ or **F2** ▲ to select a fiber, then hold down **F1** ▼ or **F2** ▲. In this mode, the record number increases or decreases by 12.
- To delete a set of 12 records, press **F3** **DELETE**, then hold down **F3** until **OK** shows.
- To delete all records, hold down **F3** until the display shows **DELETE ALL?**, release **F3**, then hold down **F3** until **OK** shows.
- To exit the delete mode and not delete the records, press **F1**, **F2**, or **MENU/SELECT**.
- Deleted records show - - - in the numeric display.
- To upload records to a PC, use LinkWare™ PC software and the USB cable provided. See the Users Manual. You can download LinkWare PC from the Fluke Networks website.