



# NUC 15 Pro+

## NUC15CRS

## NUC15CRS-B

Technical Product Specifications (TPS)

Regulatory Model: NUC15CRS

## COPYRIGHT INFORMATION

No part of this manual, including the products and software described in it, may be reproduced, transmitted, transcribed, stored in a retrieval system, or translated into any language in any form or by any means, except documentation kept by the purchaser for backup purposes, without the express written permission of ASUSTeK COMPUTER INC. ("ASUS").

ASUS PROVIDES THIS MANUAL "AS IS" WITHOUT WARRANTY OF ANY KIND, EITHER EXPRESS OR IMPLIED, INCLUDING BUT NOT LIMITED TO THE IMPLIED WARRANTIES OR CONDITIONS OF MERCHANTABILITY OR FITNESS FOR A PARTICULAR PURPOSE. IN NO EVENT SHALL ASUS, ITS DIRECTORS, OFFICERS, EMPLOYEES OR AGENTS BE LIABLE FOR ANY INDIRECT, SPECIAL, INCIDENTAL, OR CONSEQUENTIAL DAMAGES (INCLUDING DAMAGES FOR LOSS OF PROFITS, LOSS OF BUSINESS, LOSS OF USE OR DATA, INTERRUPTION OF BUSINESS AND THE LIKE), EVEN IF ASUS HAS BEEN ADVISED OF THE POSSIBILITY OF SUCH DAMAGES ARISING FROM ANY DEFECT OR ERROR IN THIS MANUAL OR PRODUCT.

Products and corporate names appearing in this manual may or may not be registered trademarks or copyrights of their respective companies, and are used only for identification or explanation and to the owners' benefit, without intent to infringe.

SPECIFICATIONS AND INFORMATION CONTAINED IN THIS MANUAL ARE FURNISHED FOR INFORMATIONAL USE ONLY, AND ARE SUBJECT TO CHANGE AT ANY TIME WITHOUT NOTICE, AND SHOULD NOT BE CONSTRUED AS A COMMITMENT BY ASUS. ASUS ASSUMES NO RESPONSIBILITY OR LIABILITY FOR ANY ERRORS OR INACCURACIES THAT MAY APPEAR IN THIS MANUAL, INCLUDING THE PRODUCTS AND SOFTWARE DESCRIBED IN IT.

Copyright © 2025 ASUSTeK COMPUTER INC. All Rights Reserved.

## LIMITATION OF LIABILITY

Circumstances may arise where because of a default on ASUS' part or other liability, you are entitled to recover damages from ASUS. In each such instance, regardless of the basis on which you are entitled to claim damages from ASUS, ASUS is liable for no more than damages for bodily injury (including death) and damage to real property and tangible personal property; or any other actual and direct damages resulted from omission or failure of performing legal duties under this Warranty Statement, up to the listed contract price of each product.

ASUS will only be responsible for or indemnify you for loss, damages or claims based in contract, tort or infringement under this Warranty Statement.

This limit also applies to ASUS' suppliers and its reseller. It is the maximum for which ASUS, its suppliers, and your reseller are collectively responsible.

UNDER NO CIRCUMSTANCES IS ASUS LIABLE FOR ANY OF THE FOLLOWING: (1) THIRD-PARTY CLAIMS AGAINST YOU FOR DAMAGES; (2) LOSS OF, OR DAMAGE TO, YOUR RECORDS OR DATA; OR (3) SPECIAL, INCIDENTAL, OR INDIRECT DAMAGES OR FOR ANY ECONOMIC CONSEQUENTIAL DAMAGES (INCLUDING LOST PROFITS OR SAVINGS), EVEN IF ASUS, ITS SUPPLIERS OR YOUR RESELLER IS INFORMED OF THEIR POSSIBILITY.

## SERVICE AND SUPPORT

Visit our multi-language website at <https://www.asus.com/support/>.

# Contents

Package Contents .....	8
<b>1. Product Specification</b>	
1.1 Specifications .....	9
1.2 Feature Summary .....	13
<b>2. Product Introduction</b>	
2.1 Board Layout.....	17
2.2 Front View .....	18
2.3 Rear View .....	18
2.4 Block Diagram.....	21
2.5 Feature Descriptions .....	22
2.5.1 Graphics Subsystem .....	22
2.5.2 Real-Time Clock Subsystem.....	24
2.5.3 Hardware Management Subsystem.....	26
<b>3. Technical references</b>	
3.1 Signal Tables for the Connectors and Header .....	28
3.1.1 M.2 2280 Module Connector .....	29
3.1.2 M.2 2242 Module Connector .....	30
3.1.3 M.2 2230 Module Connector .....	31
3.1.4 BIOS Security Jumper .....	33
3.1.5 Intel® Management Engine BIOS Extension (Intel® MEBX) Reset Header .....	35
3.1.6 Fan Header Current Capability.....	36
3.1.7 Power Supply Connector.....	36
3.2 Mechanical Considerations .....	37
3.2.1 Chassis Dimensions.....	37
3.2.2 Form Factor .....	38
3.3 Thermal Considerations.....	39
3.4 Environmental.....	39
<b>4. BIOS Support</b>	
4.1 Introduction.....	41
4.2 BIOS Updates .....	42
4.2.1 BIOS Recovery .....	42
4.3 Boot Options .....	43
4.3.1 Boot Device Selection During Post.....	43
4.3.2 Power Button Menu.....	43

4.4	Hard Disk Drive Password Security Feature .....	45
4.5	BIOS Security Features.....	46
4.6	BIOS Error Messages .....	48

# About This Document

This technical product specification includes information on the following NUC SKUs and only applies to the standard ASUS NUC15CR with BIOS identifiers CRARL579.XXXX and CRARLV57.XXXX:

- **NUC Mini PC**  
Memory, M.2 solid state drive, and Windows 11 64-bit Operating System included in the NUC system
- **NUC Kit (barebones)**  
Memory, M.2 solid state drive, and operating system not included

---

**NOTE:** Memory, M.2 solid state drive, and operating system are purchased separately for this SKU.

---

- **Technical Product Specification (TPS)**  
Specifies the board layout, components, connectors, power requirements, environmental limits, integration features, and BIOS features.

## Audience

This technical product specification is intended to provide information about the NUC Mini PC and NUC Kit to vendors, system integrators, and other engineers and technicians who need this level of information. For steps to setup the NUC Mini PC or NUC Kit, refer to the User Guide located at [www.asus.com/support](http://www.asus.com/support).

## How This Document is Organized

This guide contains the following parts:

- **Chapter 1: Product Specification**

This chapter provides an overview of the specifications of the NUC system.

- **Chapter 2: Product Introduction**

This chapter provides you with the figures, layouts, physical description of the system, and detailed features.

- **Chapter 3: Technical references**

This chapter details technical references and considerations.

- **Chapter 4: BIOS Support**

This chapter provides an overview of BIOS features.

## Conventions Used in This Guide

To highlight key information in this manual, some text are presented as follows:

---

**IMPORTANT!** This message contains vital information that must be followed to complete a task.

---

---

**NOTE:** This message contains additional information and tips that can help complete tasks.

---

---

**WARNING!** This message contains important information that must be followed to keep you safe while performing certain tasks and prevent damage to your NUC system's data and components.

---

## Other common notation

#	Used after a signal name to identify an active-low signal (such as USBP0#)
GB	Gigabyte (1,073,741,824 bytes)
GB/s	Gigabytes per second
Gb/s	Gigabits per second
KB	Kilobyte (1024 bytes)
Kb	Kilobit (1024 bits)
kb/s	1000 bits per second
MB	Megabyte (1,048,576 bytes)
MB/s	Megabytes per second
Mb	Megabit (1,048,576 bits)
Mb/s	Megabits per second
TDP	Thermal Design Power
xxh	An address or data value ending with a lowercase h indicates a hexadecimal value.
x.x V	Volts. Voltages are DC unless otherwise specified.
x.x A	Amperes.

## Production Identification Information

### ASUSTeK NUC Product NUC 15 Pro Identification Information

Product Name	NUC 15 Pro
NUC15CRS-B	Kit
NUC15CRS	Mini PC

## Where to Find More Information

Refer to the following sources for additional information and for product and software updates.

### ASUS website

The ASUS website ([www.asus.com](http://www.asus.com)) provides updated information on ASUS hardware and software products.

# Package Contents

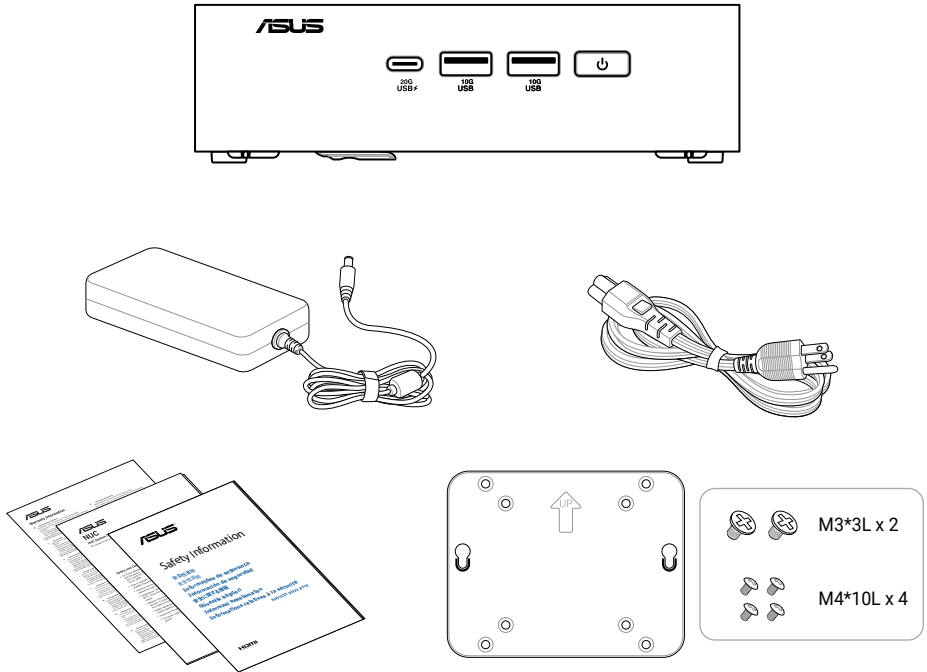

---

## NOTE:

- The most up-to-date and accurate product specifications are available on [www.asus.com](http://www.asus.com) for download.
  - Product and accessory images are for illustrative purposes only. The actual appearance and specifications may vary depending on the model.
  - The bundled power adapter may vary depending on the model and the country (or region) of sale.
  - Some bundled accessories may vary depending on the model. For details on these accessories, refer to their respective user manuals.
  - If the device or its components fail or malfunction during normal and proper use within the warranty period, bring the warranty card to the ASUS Service Center for replacement of the defective components.
-

# 1. Product Specification

## 1.1 Specifications

### Mini PC SKUs

The NUC Mini PC is a small form factor PC system. The NUC Mini PC comes with RAM, storage, and operating system pre-installed.

ASUS Project Code	NUC15CRS
Product Name	NUC 15 Pro+ Mini-PC
Processor	Intel® Core™ Ultra 9 285H, cTDP 65W Intel® Core™ Ultra 7 265H, cTDP 65W Intel® Core™ Ultra 7 255H, cTDP 65W Intel® Core™ Ultra 5 235H, cTDP 65W Intel® Core™ Ultra 5 225H, cTDP 65W
Chipset	Integrated
Graphics	Intel® Arc™ GPU <small>* Intel® Arc™ GPU requires using 2 x SODIMM.</small>
AC Cord	US, EU, CN, TW, JP, or No Cord
Memory	2 x SODIMM, Up to DDR5-5600 or 2 x CSODIMM, Up to DDR5-6400, 48GB*2
Storage	1 x M.2 2280 PCIe Gen5x4, supports 128GB~4TB NVMe SSD 1 x M.2 2242 PCIe Gen4x4, supports 128GB~2TB NVMe SSD
Wireless Network	Intel® Wi-Fi 7 BE201, Bluetooth® 5.4
LAN	Intel® Ethernet Controller I226-V/LM, 2.5G <small>* Intel® Ethernet Controller I226-LM included on vPro enabled systems.</small>
Audio	-
TPM	fTPM
Card Reader	-
HDMI CEC	Yes, 2 ports on back panel
Front I/O Ports	1 x USB 3.2 Gen2x2 Type-C® 2 x USB 3.2 Gen2 Type-A
Back I/O Ports	2 x Thunderbolt™ 4 Type-C® w/ DisplayPort 2.1 1 x USB 3.2 Gen 2 Type-A 1 x USB 2.0 Type-A 2 x HDMI 2.1 (TMDS) 1 x RJ45 LAN 1 x DC-in 1 x Kensington Lock
Side I/O Ports	-

(continued on next page)

<b>ASUS Project Code</b>	<b>NUC15CRS</b>
<b>Power Supply</b>	19.5VDC, 7.69A, 150W Power Adapter (Core Ultra 9) 19VDC, 6.32A, 120W Power Adapter (Core Ultra 5/7)
<b>Dimensions (W x D x H)</b>	144mm x 112mm x 41mm
<b>Weight (grams)</b>	689g
<b>OS</b>	Windows 11 64-bit

## Kit SKUs

The NUC Kit is a small form factor PC barebones kit. The NUC Kit consists of the processor, chipset, memory slot, wireless, Bluetooth, M.2 storage slot, integrated heat sink and fan.

**NOTE:** RAM, storage and operating system is not included.

ASUS Project Code	NUC15CRS-B
Product Name	NUC 15 Pro+ Kit
Processor	Intel® Core™ Ultra 9 285H, cTDP 65W Intel® Core™ Ultra 7 265H, cTDP 65W Intel® Core™ Ultra 7 255H, cTDP 65W Intel® Core™ Ultra 5 235H, cTDP 65W Intel® Core™ Ultra 5 225H, cTDP 65W
Chipset	Integrated
Graphics	Intel® Arc™ GPU * Intel® Arc™ GPU requires using 2 x SODIMM.
AC Cord	US, EU, UK, AU, CN, TW, JP, or No Cord * Availability of AC cord will vary depending on region or processor.
Memory	2 x SODIMM, Up to DDR5-5600 or 2 x CSODIMM, Up to DDR5-6400, 48GB*2
Storage	1 x M.2 2280 PCIe Gen5x4, supports 128GB~4TB NVMe SSD 1 x M.2 2242 PCIe Gen4x4, supports 128GB~2TB NVMe SSD
Wireless Network	Intel® Wi-Fi 7 BE201, Bluetooth® 5.4
LAN	Intel® Ethernet Controller I226-V/LM, 2.5G * Intel® Ethernet Controller I226-LM included on vPro enabled systems
Audio	-
TPM	fTPM
Card Reader	-
HDMI CEC	Yes, 2 ports on back panel
Front I/O Ports	1 x USB 3.2 Gen2x2 Type-C® 2 x USB 3.2 Gen2 Type-A
Back I/O Ports	2 x Thunderbolt™ 4 Type-C® w/ DisplayPort 2.1 1 x USB 3.2 Gen 2 Type-A 1 x USB 2.0 Type-A 2 x HDMI 2.1 (TMDS) 1 x RJ45 LAN 1 x DC-in 1 x Kensington Lock
Side I/O Ports	-
Power Supply	19.5VDC, 7.69A, 150W Power Adapter (Core Ultra 9) 19VDC, 6.32A, 120W Power Adapter (Core Ultra 5/7)

(continued on next page)

<b>ASUS Project Code</b>	<b>NUC15CRS-B</b>
<b>Dimensions (W x D x H)</b>	144mm x 112mm x 41mm
<b>Weight (grams)</b>	689g
<b>OS</b>	Windows 11 64-bit Ubuntu 24.04 LTS 64-bit RedHat Enterprise Linux 64-bit

## 1.2 Feature Summary

The tables below summarizes the major features of the NUC system.

<b>Board Dimensions</b>	4.0in x 4.0in (104.1mm x 101.6mm)
<b>Chassis Dimensions</b>	Pro+ Chassis: 144mm x 112mm x 41mm (including feet)
<b>Processor</b>	ASUS NUC Boards, Kits, and Mini PCs NUC15CRS Standard products have a soldered-down processor from the list below. <ul style="list-style-type: none"> <li>• Intel® Core™ Ultra 9 Processor 285H</li> <li>• Intel® Core™ Ultra 7 Processor 265H with Intel® vPro® Technology</li> <li>• Intel® Core™ Ultra 7 Processor 255H</li> <li>• Intel® Core™ Ultra 5 Processor 235H with Intel® vPro® Technology</li> <li>• Intel® Core™ Ultra 5 Processor 225H</li> </ul>
<b>Memory</b>	Two 262-pin 1.1 V DDR5 SDRAM Small Outline Dual Inline Memory Module (SO DIMM) sockets. <ul style="list-style-type: none"> <li>• Support for DDR5 5200/5600 MHz SODIMMs*</li> <li>• Support for DDR5 6400 MHz CSODIMMs*</li> <li>• Support for 16 Gb and 24 Gb technology</li> <li>• Support for up to 96 GB of system memory with two SODIMMs using 48 GB memory modules</li> <li>• Support for non-ECC memory</li> <li>• Support for 1.1 V JEDEC memory only</li> </ul> <p>* 2 Gb, 4 Gb and 8Gb memory technology (SDRAM Density) is not supported</p>
<b>Graphics</b>	Integrated graphics support for processors with Intel® Graphics Technology: <ul style="list-style-type: none"> <li>• Supports up to quad 4K60Hz displays (2 x DP/USB Type-C® + 2 x HDMI 2.1 TMDS)</li> <li>• Supports a single 8K60Hz panel, supported by joining two pipes of Displayport (TBT4) over a single port</li> <li>• HDR (High Dynamic Range) support</li> <li>• Four display pipes – supporting blending, color adjustments, scaling, and dithering</li> <li>• Support for HDCP 1.4 and 2.3</li> <li>• Codecs supported are detailed in <b>Graphics Subsystem</b> section</li> <li>• Supporting Persistent Display Emulation on HDMI ports only</li> </ul>
<b>Audio</b>	The processor supports four High-Definition audio streams on four digital ports simultaneously. The processor supports the following audio formats over HDMI and DisplayPort: AC-3 Dolby Digital, Dolby Digital Plus, DTS-HD, LPCM, 192 Khz/24 bit, 6 Channel, and Dolby TrueHD, DTS-HD Master Audio. More information about software and drivers can be found at <a href="https://www.asus.com/support/Download-Center/">https://www.asus.com/support/Download-Center/</a>

(continued on next page)

Storage	<p>One M.2 PCIe Gen5 connector supporting M.2 22x80 (key type M) for NVMe only</p> <p>One M.2 PCIe Gen4 connector supporting M.2 22x42 (key type M) for NVME only</p>
Communication	<p>Intel® Wi-Fi 7 BE201 M.2 2230 module</p> <ul style="list-style-type: none"> <li>• 802.11be 2x2 with 320MHz channel support + Bluetooth® v5.4</li> <li>• Maximum transfer speed up to 5.76 Gbps</li> <li>• Intel® AMT/vPro support on Ultra 5 vPro and Ultra 7 vPro SKUs only</li> </ul> <p>Gigabit (10/100/1000/2500 Mbps) LAN subsystem using the Intel® i226-LM Gigabit Ethernet Controller (vPro SKUs) and Intel® i226-V Gigabit Ethernet Controller (non-vPro SKUs)</p> <ul style="list-style-type: none"> <li>• PCIe Gen3 8GT/s support for x1 width (Lane)</li> <li>• Single-port integrated multi-gigabit (up to 2.5G) - standard IEEE 802.3 Ethernet interface for 2500BASE-T, 1000BASE-T, 100BASE-TX, 10BASE-T-E connections (IEEE 802.3, 802.3u, 802.3bz, and 802.3ab)</li> <li>• Full wake up support (S4 WOL not supported)</li> <li>• Supports for packets up to 9.5 KB (Jumbo Frames)</li> </ul> <p>To obtain drivers visit <a href="https://www.asus.com/support/Download-Center/">https://www.asus.com/support/Download-Center/</a></p>
Thunderbolt™	<p>2 x Thunderbolt™ ports (back panel)</p> <ul style="list-style-type: none"> <li>• USB4 compliant</li> <li>• 15W (5V/3A) port bus power</li> <li>• Thunderbolt networking</li> <li>• Protocol support: <ul style="list-style-type: none"> <li>- PD Modes Supported: TBT4, USB4, USB3, DP-alt/MF</li> <li>- TBT4 Tx/Rx rates: 40G (2x 20.625), 20G (2x 10.3125)</li> <li>- PCI Express Tunneling: 32 Gbps (PCI Express* 3.0 x4 compliant)</li> <li>- USB4 Tx/Rx rates: 40G (2x 20), 20G (2x 10)</li> <li>- USB3 Native: USB 3.2 Gen 2 x1 (10G)</li> <li>- USB3 Tunneling: USB 3.2 Gen 2 x1 (10G)</li> <li>- USB2: 480 Mbps</li> <li>- DP2.1, UHBR20</li> <li>- DisplayPort Tunneling: <ul style="list-style-type: none"> <li>Port 1: 2 streams (~35 Gbps, Thunderbolt 4 certified)</li> <li>Port 2: 2 stream (~35 Gbps, Thunderbolt 4 certified)</li> </ul> </li> </ul> </li> </ul> <p>For more information about the location of the Thunderbolt™ ports see <b>Front view</b> and <b>Rear view</b> section</p>
USB Ports and Headers	<p>2 x USB 4 ports via Type C/Thunderbolt™ (on back panel, shared with Thunderbolt™ as described above)</p> <p>3 x USB 3.2 Gen 2 ports (2 front panel and 1 back panel)</p> <p>1 x USB 2.0 port (1 back panel)</p> <p>2 x USB 2.0 Headers (internal)</p> <p>1 x Serial Port 1x9 1.25mm pitch header (black)</p> <p>For more information about the location of the Thunderbolt™ ports see <b>Front view</b> and <b>Rear view</b> section</p> <p>For more information about the pinout of the USB ports and headers see <b>Signal Tables for the Connectors and Header</b> section.</p>

(continued on next page)

<b>TPM</b>	Intel® Platform Trust Technology (Intel® PTT) supported on all SKUs - TPM 2.0 Compliant More information about TPM and Intel® PTT is available on <a href="https://www.asus.com/support/">https://www.asus.com/support/</a>
<b>Power</b>	AC Adapter <ul style="list-style-type: none"> <li>• Core Ultra 5 and Core Ultra 7 ships with a 120W 19V adapter</li> <li>• Core Ultra 9 ships with a 150W 19.5V adapter</li> </ul> Internal Power Header <ul style="list-style-type: none"> <li>• 4-pos/dual row (2x2) right-angled header</li> </ul> Power Input <ul style="list-style-type: none"> <li>• 12VDC to 20VDC +/- 5% with DC voltage protection</li> </ul>
<b>Operating Temperature</b>	ASUS BIOS provides options to select an External Ambient Temperature Tolerance. Users can select 0°C-35°C, 0°C-40°C, or User Defined. Each option impacts system power, performance, and cooling settings.
<b>BIOS</b>	ASUS BIOS resident in the Serial Peripheral Interface (SPI) Flash device Support for Advanced Configuration and Power Interface (ACPI), Plug and Play, and System Management BIOS (SMBIOS)
<b>Operating System (Mini PCs only)</b>	ASUS NUC Mini PC NUC15CR ships with: <ul style="list-style-type: none"> <li>• Windows® 11 Pro 64-bit <b>or</b></li> <li>• Windows® 11 Home 64-bit preinstalled.</li> </ul> For a full list of latest supported operating systems, Please visit <a href="http://www.asus.com/support">www.asus.com/support</a> .
<b>Other Supported Operating System (Mini PC &amp; Kit)</b>	Microsoft Windows: Windows 11 Home Windows 11 Pro Windows 11 IoT Enterprise LTSC Linux: Ubuntu 22.04 LTS Ubuntu 23.10 Red Hat Enterprise Linux v9.2  <small>* These are the validated and supported operating systems list for Kit/Mini PC, they may not be included in pre-built systems sold directly by ASUS.</small>
<b>Hardware Monitor Subsystem</b>	Hardware monitoring subsystem including: Voltage sense to detect out of range power supply voltages Thermal sense to detect out of range thermal values One processor fan header Fan sense input used to monitor fan activity Fan speed control

## Additional features

<b>Replaceable Lids</b>	ASUS NUC Pro Mini PCs and Kits NUC15CR ship with a replaceable lid that allows you to replace the cover of the NUC with a full range of cosmetic and functional lids.
<b>HDMI CEC API</b>	Built-in support for HDMI CEC is available on the HDMI port, which may be enabled in the BIOS for display power control, as well as via a WMI supporting other HDMI CEC functions.
<b>Sustained Operation</b>	Qualified for 24x7 sustained operation.
<b>Auto RTC Reset</b>	A Real-Time Clock (RTC) reset will be triggered after three consecutive unsuccessful boot attempts.
<b>Delayed AC Start</b>	Short delay after AC power is applied before unit is ready to power on to protect the system against voltage fluctuations in environments where multiple devices are being powered on simultaneously.
<b>Reflectivity</b>	All surfaces meet 20GE (20 Gloss Level/Gloss Units) of shininess by measurement of Glanz.
<b>Kensington Security Slot</b>	Available on the left side of the chassis when viewed from the front.
<b>Cable Locking Arm</b>	ASUS NUC Pro Mini PCs and Kits NUC15CR ship with a cable locking arm on the back panel of the chassis. The cable locking arm reduces stress on the power adapter cable in certain positions and prevents unintended losses of power
<b>VESA Mount</b>	ASUS NUC Mini PCs and Kits NUC15CR ship with a VESA mount and screws for attaching the system to compatible screens and monitors

# 2. Product Introduction

## 2.1 Board Layout

The illustration below shows the location of the major components on the motherboard.

### Top view

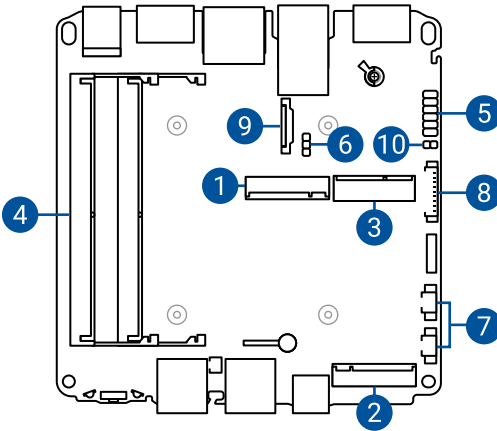

- 1 M.2 2242 module connector (Key Type M) (NVMe only)
- 2 M.2 2280 module connector (Key Type M) (NVMe only)
- 3 M.2 2230 module connector (Key Type E)
- 4 DDR5 CSODIMM/SODIMM sockets
- 5 Front panel header
- 6 BIOS security jumper
- 7 USB 2.0 headers
- 8 Serial port connectors
- 9 PCIe x1 Custom Solution header
- 10 Intel® Management Engine BIOS Extension (Intel® MEBX) Reset Header

### Bottom view

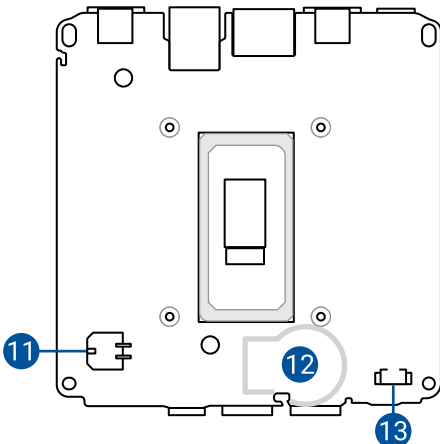

- 11 12-20 V DC 2x2 power connector
- 12 CMOS battery
- 13 CPU fan connector

## 2.2 Front View

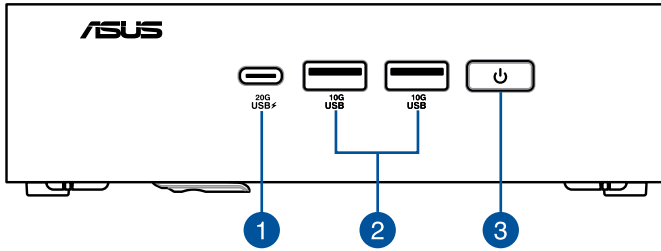

## 2.3 Rear View

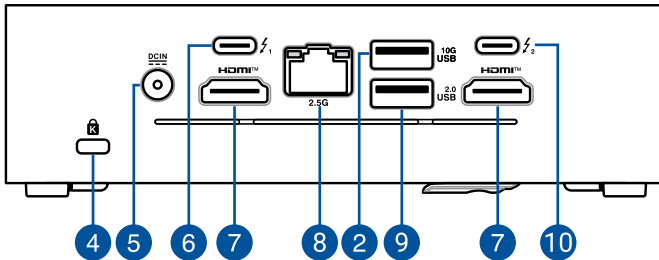

- |   |                         |    |  |
|---|-------------------------|----|--|
| 1 | USB 20Gbps Type-C® port | 6  | Thunderbolt™ 4 Type-C® port 1 with DisplayPort 2.1 |
| 2 | USB 10Gbps port         | 7  | HDMI™ HDMI™ port                                   |
| 3 | Power button            | 8  | 2.5G LAN Port                                      |
| 4 | Kensington lock         | 9  | USB 2.0 port                                       |
| 5 | Power input             | 10 | Thunderbolt™ 4 Type-C® port 2 with DisplayPort 2.1 |

## Display resolution table:

### Single Display

	HDMI 1	Type-C® TBT/ DP 1	Type-C® TBT/ DP 2	HDMI 2
HDMI 1 (2.1 TMDS)	4K (3840 x 2160 @60Hz)	-	-	-
Type-C® TBT/DP 1	-	5K (5120 x 3200 @60Hz)	-	-
Type-C® TBT/DP 2	-	-	5K (5120 x 3200 @60Hz)	-
HDMI 2(2.1 TMDS)	-	-	-	4K (3840 x 2160 @60Hz)
Both Type-C® TBT/DP 1 & 2	-	8K (7680 x 4320 @60Hz)		-

### Dual Displays

	HDMI 1	Type-C® TBT/ DP 1	Type-C® TBT/ DP 2	HDMI 2
HDMI 1 (2.1 TMDS) + Type-C® TBT/DP 1	4K (3840 x 2160 @60Hz)	5K (5120 x 3200 @60Hz)	-	-
HDMI 1 (2.1 TMDS) + Type-C® TBT/DP 2	4K (3840 x 2160 @60Hz)	-	5K (5120 x 3200 @60Hz)	-
HDMI 1 (2.1 TMDS) + HDMI 2(2.1 TMDS)	4K (3840 x 2160 @60Hz)	-	-	4K (3840 x 2160 @60Hz)
Type-C® TBT/DP 1 + Type-C® TBT/DP 2	-	5K (5120 x 3200 @60Hz)	5K (5120 x 3200 @60Hz)	-
Type-C® TBT/DP 1 + HDMI 2 (2.1 TMDS)	-	5K (5120 x 3200 @60Hz)	-	4K (3840 x 2160 @60Hz)
Type-C® TBT/DP 2 + HDMI 2 (2.1 TMDS)	-	5K (5120 x 3200 @60Hz)	-	4K (3840 x 2160 @60Hz)

### Triple Displays

	HDMI 1	Type-C® TBT/ DP 1	Type-C® TBT/ DP 2	HDMI 2
HDMI 1 (2.1 TMDS) + Type-C® TBT/DP 1 + Type-C® TBT/DP 2	4K (3840 x 2160 @60Hz)	4K (3840 x 2160 @60Hz)	4K (3840 x 2160 @60Hz)	-
HDMI 2 (2.1 TMDS) + Type-C® TBT/DP 1 + Type-C® TBT/DP 2	-	4K (3840 x 2160 @60Hz)	4K (3840 x 2160 @60Hz)	4K (3840 x 2160 @60Hz)
HDMI 1 (2.1 TMDS) + Type-C® TBT/DP 1 + HDMI 2 (2.1 TMDS)	4K (3840 x 2160 @60Hz)	5K (5120 x 3200 @60Hz)	-	4K (3840 x 2160 @60Hz)
HDMI 1 (2.1 TMDS) + Type-C® TBT/DP 2 + HDMI 2 (2.1 TMDS)	4K (3840 x 2160 @60Hz)	-	5K (5120 x 3200 @60Hz)	4K (3840 x 2160 @60Hz)

## Quad Displays

	HDMI 1	Type-C® TBT/ DP 1	Type-C® TBT/ DP 2	HDMI 2
HDMI 1 (2.1 TMDS) + Type-C® TBT/DP 1 + Type-C® TBT/DP 2 + HDMI 2 (2.1 TMDS)	4K (3840 x 2160 @60Hz)	4K (3840 x 2160 @60Hz)	4K (3840 x 2160 @60Hz)	4K (3840 x 2160 @60Hz)

## Daisy Chain Quad Displays

	HDMI 1	Type-C® TBT/ DP 1	Type-C® TBT/ DP 2	HDMI 2
HDMI 1 (2.1 TMDS) + Type-C® TBT/DP 1 (daisy chain) + HDMI 2 (2.1 TMDS)	4K (3840 x 2160 @60Hz)	4K (3840 x 2160 @60Hz) 4K (3840 x 2160 @60Hz)	-	4K (3840 x 2160 @60Hz)
HDMI 1 (2.1 TMDS) + Type-C® TBT/DP 2 (daisy chain) + HDMI 2 (2.1 TMDS)	4K (3840 x 2160 @60Hz)	-	4K (3840 x 2160 @60Hz) 4K (3840 x 2160 @60Hz)	4K (3840 x 2160 @60Hz)
Type-C® TBT/DP 1 (daisy chain) + Type-C® TBT/DP 1(daisy chain)	-	4K (3840 x 2160 @60Hz) 4K (3840 x 2160 @60Hz)	4K (3840 x 2160 @60Hz) 4K (3840 x 2160 @60Hz)	-

## LAN port LED indications:



Link LED	
Status	Description
OFF	No link
GREEN	Linked
BLINKING	Data activity

Speed LED	
Status	Description
OFF	100 Mbps / 10 Mbps connection
YELLOW	1 Gbps connection
GREEN	2.5 Gbps connection

# 2.4 Block Diagram

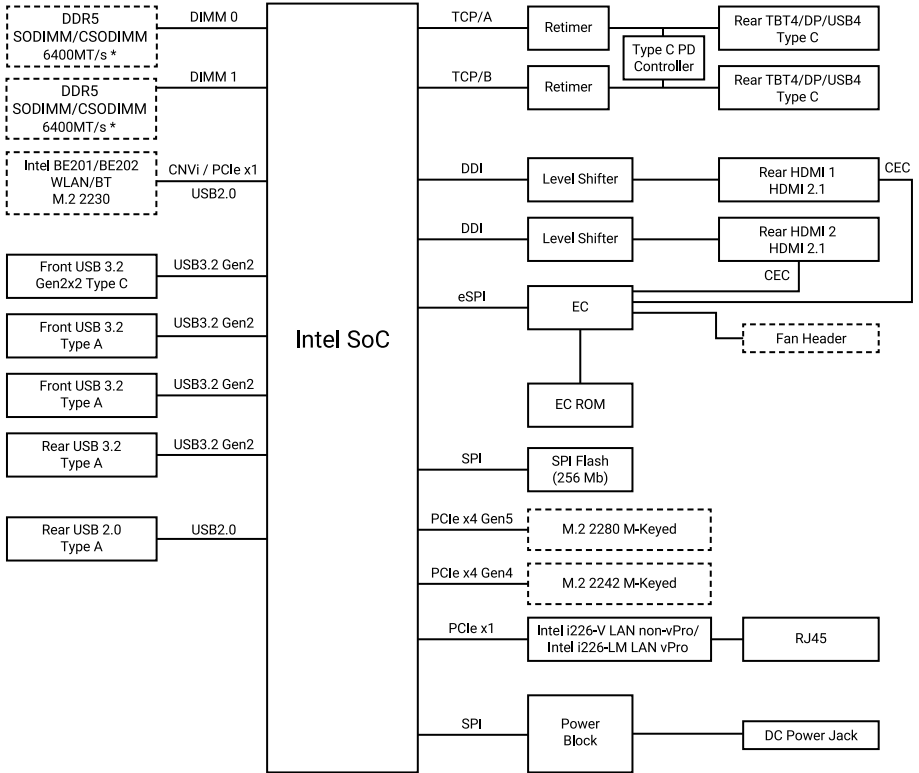

## 2.5 Feature Descriptions

### 2.5.1 Graphics Subsystem

ASUS NUC Boards NUC15CR with Core™ Ultra Processors (Core™ Ultra 9/7/5) support Intel® Arc™ Graphics, while the NUC15CR with Core™ Processors (Core™ 3/5/7) support Intel® Graphics.

#### Intel® Arc™ Graphics

Intel® Arc™ Graphics implements a high-performance and low-power HW acceleration for video decoding operations for multiple video codecs.

The HW decode is exposed by the graphics driver using the following APIs:

- Direct3D 9 Video API (DXVA2), Direct3D11 Video API, Direct3D12 Video API, Intel Media SDK, MFT (Media Foundation Transform) filters, and Intel VA API.
- Intel® Arc™ Graphics supports full HW accelerated video decoding for AVC/HEVC/VP9/JPEG and AVI.

Intel® Core™ / Core™ Ultra Processors implement a low-power low-latency fixed function encoder and high-quality customizable encoder with hardware assisted motion estimation engine which supports AVC, MPEG-2, HEVC, and VP9. The HW encode is exposed by the graphics driver using the following APIs:

- Intel® Media SDK and MFT (Media Foundation Transform) filters.
- Intel® Arc™ Graphics supports full HW accelerated video encoding for AVC/HEVC/VP9/AV1 and JPEG.

There is hardware support for image processing functions such as De-interlacing, Film cadence detection, Advanced Video Scaler (AVS), detail enhancement, gamut compression, HD adaptive contrast enhancement, skin tone enhancement, total color control, Chroma de-noise, SFC (Scalar and Format Conversion), memory compression, Localized Adaptive Contrast Enhancement (LACE), spatial de-noise, Out-Of-Loop De-blocking (from AVC decoder), and 16 bpc support for de-noise / de-mosaic. The HW video processing is exposed by the graphics driver using the following APIs:

- Direct3D 9 Video API (DXVA2), Direct3D 11 Video API, OneVPL, MFT (Media Foundation Transform) filters, Intel® Graphics Control Library, and Intel VA API.

The Intel® Core™ / Core™ Ultra Processors with integrated graphics support the following transcoding features:

- High performance high quality flexible encoder for video editing and video archiving, lower-power low latency encoder for video conferencing, wireless display, and game streaming, lossless memory compression for media engine to reduce media power, high-quality Advanced Video Scaler (AVS) and low power Scaler and Format Converter.

---

**NOTE:**

- Resolution support is subject to memory bandwidth availability
  - Single 8K at 60 Hz display, supported by monitors that accept dual DP input for tiled screen
- 

## Intel® Graphics for Intel Core™ processors

Intel® Graphics for 15<sup>th</sup> Gen Intel Processors features the following:

- DirectX 12.1 support
- OpenGL 4.6 support
- OpenCL 3.0 support
- Vulkan support
- Max HDMI resolution 4096x2304 at 60Hz
- Max DP resolution 7680x4320 at 60Hz

## Display emulation

Display emulation is supported using the HDMI ports so that the system may be remotely accessed in a headless configuration or be capable of tolerating display connectivity interruptions without the operating system redetecting and rearranging the overall display layout. The display emulation feature may be enabled in BIOS Setup with the following checkboxes:

- “Virtual display emulation”: provides a 1280x1024 virtual display when no displays are connected to the system and provides an additional 1280x1024 virtual display if one display is attached to the system. If two displays are attached to the HDMI ports these displays will be enabled and no virtual displays will be provided.
- “Persistent display emulation”: emulates that both displays are always connected to the system no matter their actual connection status. The EDID information from each display will remain programmed through S3, S4, S5 and G3 power states until the feature is disabled.
- When “Persistent display emulation” is enabled another drop-down menu (“Inconsistent Display Device”) will become visible that allows the user to select the behavior of the system when the display device EDID is inconsistent with the EDID stored by the system.
  - “Block boot” (default selection): the BIOS will display a warning message with options and will wait indefinitely for a user selection.
  - “Countdown”: the BIOS will display a warning message with options and will wait 10 seconds before booting.

---

**NOTE:** When using “Persistent display emulation” it would be expected behavior for the system not to properly drive displays different than those connected when the feature was enabled, as the EDID parameters of the initially connected displays are still being driven by the system. In order to retrain the system for different displays, the persistent display emulation feature must be disabled in the BIOS, the system rebooted, and then the persistent display emulation feature must be reenabled.

---

## 2.5.2 Real-Time Clock Subsystem

A coin-cell battery (CR2032) powers the real-time clock and CMOS memory. When the computer is not plugged into a wall socket, the battery has an estimated life of three years. When the computer is plugged in, the standby current from the power supply extends the life of the battery. The clock is accurate to  $\pm 13$  minutes/year at 25 °C with 3.3 VSB applied via the power supply 5 V STBY rail.

---

**NOTE:**

- If the battery and AC power fail, date and time values will be reset and the user will be notified during the POST.
  - When the voltage drops below a certain level, the BIOS Setup program settings stored in CMOS RAM (for example, the date and time) might not be accurate. Replace the battery with an equivalent one. Please refer to **Board Layout** section for the location of the battery.
  - System can power on from G3/AC power loss state without the Real-Time Clock battery.
-

## Button cell and coin battery notice

1. Remove and immediately recycle or dispose of used batteries according to local regulations and keep out of reach of children. Do not incinerate or dispose of batteries in household trash.
2. If ingested or inserted inside any part of the body, call a local poison control center for treatment information. Even used batteries may cause serious injury or death.
3. This product uses CR2032 type batteries with a nominal voltage of 3V.
4. Do not attempt to recharge non-rechargeable batteries.
5. Do not forcibly discharge, recharge, disassemble, heat above the battery manufacturer's specified temperature rating, or incinerate. Doing so may result in injury or chemical burns caused by venting, leakage, or explosion.
6. When installing batteries, ensure that the polarity (+ and -) is correct.
7. Do not mix old and new batteries, or batteries of different brands or types (such as alkaline, carbon-zinc, or rechargeable batteries).
8. Remove and immediately recycle or dispose of batteries from equipment not used for an extended period of time according to local regulations.
9. Always completely secure the battery compartment. If the battery compartment cannot be securely closed, stop using the product, remove the batteries, and keep the batteries out of reach of children.

<b>⚠ WARNING</b>	
<ul style="list-style-type: none"><li>• <b>INGESTION HAZARD:</b> This product contains a button cell or coin battery.</li><li>• <b>DEATH</b> or serious injury can occur if ingested.</li><li>• A swallowed button cell or coin battery can cause <b>Internal Chemical Burns</b> in as little as <b>2 hours</b>.</li><li>• <b>KEEP</b> new and used batteries <b>OUT OF REACH of CHILDREN</b>.</li><li>• <b>Seek immediate medical attention</b> if a battery is suspected to be swallowed or inserted inside any part of the body.</li></ul>	

---

### NOTE:

- If the battery and AC power fail, date and time values will be reset and the user will be notified during the POST.
  - When the voltage drops below a certain level, the BIOS Setup program settings stored in CMOS RAM (for example, the date and time) might not be accurate. Replace the battery with an equivalent battery.
-

## 2.5.3 Hardware Management Subsystem

### Fan monitoring

Fan monitoring can be implemented using third-party software.

### System states and power states

Please refer to the table below for ACPI states supported by the processor.

State	Description
G0/S0/C0	<b>Full On:</b> CPU operating. Individual devices may be shut to save power. The different CPU operating levels are defined by Cx states.
G0/S0/Cx	<b>Cx State:</b> CPU manages C-states by itself and can be in lower power states.
G1	<b>Suspend-To-RAM (STR):</b> The system context is maintained in system DRAM, but power is shut to non-critical circuits. Memory is retained and refreshes continue. All external clocks are shut off; RTC clock and international oscillator clocks are still toggling.
G1/S4	<b>Suspend-To-Disk (STD):</b> The context of the system is maintained on the disk. All power is then shut to the system except to the logic required to resume. Externally appears the same as S5 but may have different wake events.
G2/S5	<b>Soft Off:</b> System context not maintained. All power is shut except for the logic required to restart. A full boot is required when waking.
G3	<b>Mechanical Off:</b> System context not maintained. All power shut except for the RTC. No "Wake" events are possible because the system does not have any power. This state occurs if the user removes the batteries, turns off a mechanical switch, or if the system power supply is at a level that is insufficient to power the "waking" logic.

### Wake-up devices and events

Please refer to the table below for devices or specific events that can wake the computer from specific states.

Devices/events that wake up the system...	...from this sleep state	Comments
Power switch	S0iX, S4, S5	-
RTC alarm	S0iX, S4, S5	Option for monitor to remain in sleep state
LAN	S0iX, S5	"S5 WOL after G3" is supported; monitor to remain in sleep state
Bluetooth	S0iX	-
USB	S0iX, S4, S5	Wake S4, S5 controlled by BIOS option (not after G3)
PCIe	S0iX, S4	Via WAKE; monitor to remain in sleep state
HDMI CEC	S0iX, S4, S5	Wake S4, S5 controlled by BIOS option

---

**NOTE:**

- S4 implies operating system support only.
  - Will not wake from Deep S4/S5. USB S4/S5 Power is controlled by BIOS. USB S5 wake is controlled by BIOS. USB S4 wake is controlled by OS driver, not just BIOS option.
  - Windows Fast startup will block wake from LAN and USB from S5.
  - WoL from S4 via Magic Packet is not supported.
  - The use of these wake-up events from an ACPI state requires an operating system that provides full ACPI support. In addition, software, drivers, and peripherals must fully support ACPI wake events.
-

# 3. Technical references

## 3.1 Signal Tables for the Connectors and Header

---

### **IMPORTANT!**

Only the following connectors and headers have overcurrent protection:

- Rear USB Type A and USB Type-C®
- Front USB Type A and USB Type-C®
- DC Vin jack

All other connectors and headers are not overcurrent protected and should connect only to devices inside the computer's chassis, such as fans and internal peripherals. Do not use these connectors or headers to power devices external to the computer's chassis. A fault in the load presented by the external devices could cause damage to the computer, the power cable, and the external devices themselves.

Furthermore, improper connection of serial port header single wire connectors may eventually overload the overcurrent protection and cause damage to the board.

---

## 3.1.1 M.2 2280 Module Connector

SSD support is provided via PCIe Gen5x4 NVMe on CPU attached. Please see the table below for M.2 2280 connector signals.

<b>M.2 2280 Module (Mechanical Key M) Connector</b>			
<b>Pin</b>	<b>Signal Name</b>	<b>Pin</b>	<b>Signal Name</b>
74	3.3V (4A total for pins 74, 72, 70, 18, 16, 14, 12, 4, 2 (0.5A per pin))	75	GND
72	3.3V (4A total for pins 74, 72, 70, 18, 16, 14, 12, 4, 2 (0.5A per pin))	73	GND
70	3.3V (4A total for pins 74, 72, 70, 18, 16, 14, 12, 4, 2 (0.5A per pin))	71	GND
68	SUSCLK(32kHz) (O)(0/3.3V)	69	PEDET (NC-PCIe)
66	Connector Key	67	N/C
64	Connector Key	65	Connector Key
62	Connector Key	63	Connector Key
60	Connector Key	61	Connector Key
58	N/C	59	Connector Key
56	N/C	57	GND
54	PEWAKE# (I/O)(0/3.3V) or N/C	55	REFCLKP
52	CLKREQ# (I/O)(0/3.3V) or N/C	53	REFCLKN
50	PERST# (O)(0/3.3V) or N/C	51	GND
48	N/C	49	PETp0
46	N/C	47	PETn0
44	N/C	45	GND
42	N/C	43	PERp0
40	N/C	41	PERn0
38	DEVSLP (O)	39	GND
36	N/C	37	PETp1
34	N/C	35	PETn1
32	N/C	33	GND
30	N/C	31	PERp1
28	N/C	29	PERn1
26	N/C	27	GND
24	N/C	25	PETp2
22	N/C	23	PETn2
20	N/C	21	GND
18	3.3V (4A total for pins 74, 72, 70, 18, 16, 14, 12, 4, 2 (0.5A per pin))	19	PERp2
16	3.3V (4A total for pins 74, 72, 70, 18, 16, 14, 12, 4, 2 (0.5A per pin))	17	PERn2

(continued on next page)

<b>M.2 2280 Module (Mechanical Key M) Connector</b>			
<b>Pin</b>	<b>Signal Name</b>	<b>Pin</b>	<b>Signal Name</b>
14	3.3V (4A total for pins 74, 72, 70, 18, 16, 14, 12, 4, 2 (0.5A per pin))	15	GND
12	3.3V (4A total for pins 74, 72, 70, 18, 16, 14, 12, 4, 2 (0.5A per pin))	13	PETp3
10	DAS/DSS# (I/O)/LED1# (I)(0/3.3V)	11	PETn3
8	N/C	9	GND
6	N/C	7	PERp3
4	3.3V (4A total for pins 74, 72, 70, 18, 16, 14, 12, 4, 2 (0.5A per pin))	5	PERn3
2	3.3V (4A total for pins 74, 72, 70, 18, 16, 14, 12, 4, 2 (0.5A per pin))	3	GND
		1	GND

### 3.1.2 M.2 2242 Module Connector

SSD support is provided via PCIe Gen4x4 NVMe on CPU attached. Please see the table below for M.2 2242 connector signals.

<b>M.2 2242 Module (Mechanical Key M) Connector</b>			
<b>Pin</b>	<b>Signal Name</b>	<b>Pin</b>	<b>Signal Name</b>
74	3.3V (4A total for pins 74, 72, 70, 18, 16, 14, 12, 4, 2 (0.5A per pin))	75	GND
72	3.3V (4A total for pins 74, 72, 70, 18, 16, 14, 12, 4, 2 (0.5A per pin))	73	GND
70	3.3V (4A total for pins 74, 72, 70, 18, 16, 14, 12, 4, 2 (0.5A per pin))	71	GND
68	SUSCLK(32kHz) (O)(0/3.3V)	69	PEDET (NC-PCIe)
66	Connector Key	67	N/C
64	Connector Key	65	Connector Key
62	Connector Key	63	Connector Key
60	Connector Key	61	Connector Key
58	N/C	59	Connector Key
56	N/C	57	GND
54	PEWAKE# (I/O)(0/3.3V) or N/C	55	REFCLKP
52	CLKREQ# (I/O)(0/3.3V) or N/C	53	REFCLKN
50	PERST# (O)(0/3.3V) or N/C	51	GND
48	N/C	49	PETp0
46	N/C	47	PETn0
44	N/C	45	GND
42	N/C	43	PERp0

(continued on next page)

<b>M.2 2242 Module (Mechanical Key M) Connector</b>			
<b>Pin</b>	<b>Signal Name</b>	<b>Pin</b>	<b>Signal Name</b>
40	N/C	41	PERn0
38	DEVSLP (0)	39	GND
36	N/C	37	PETp1
34	N/C	35	PETn1
32	N/C	33	GND
30	N/C	31	PERp1
28	N/C	29	PERn1
26	N/C	27	GND
24	N/C	25	PETp2
22	N/C	23	PETn2
20	N/C	21	GND
18	3.3V (4A total for pins 74, 72, 70, 18, 16, 14, 12, 4, 2 (0.5A per pin))	19	PERp2
16	3.3V (4A total for pins 74, 72, 70, 18, 16, 14, 12, 4, 2 (0.5A per pin))	17	PERn2
14	3.3V (4A total for pins 74, 72, 70, 18, 16, 14, 12, 4, 2 (0.5A per pin))	15	GND
12	3.3V (4A total for pins 74, 72, 70, 18, 16, 14, 12, 4, 2 (0.5A per pin))	13	PETp3
10	DAS/DSS# (I/O)/LED1# (I)(0/3.3V)	11	PETn3
8	N/C	9	GND
6	N/C	7	PERp3
4	3.3V (4A total for pins 74, 72, 70, 18, 16, 14, 12, 4, 2 (0.5A per pin))	5	PERn3
2	3.3V (4A total for pins 74, 72, 70, 18, 16, 14, 12, 4, 2 (0.5A per pin))	3	GND
		1	GND

### 3.1.3 M.2 2230 Module Connector

Wi-Fi module is supported by the M.2 2230 slot. Please see the table below for M.2 2230 connector signals.

<b>M.2 2230 Module (Mechanical Key E) Connector</b>			
<b>Pin</b>	<b>Signal Name</b>	<b>Pin</b>	<b>Signal Name</b>
74	3.3V	75	GND
72	3.3V	73	WT_CLKP
70	UIM_POWER_SRC/GPIO1/PEWAKE1#	71	WT_CLKN
68	CLKREQ1#	69	GND
66	PERST1#	67	WTD0P

(continued on next page)

## M.2 2230 Module (Mechanical Key E) Connector

Pin	Signal Name	Pin	Signal Name
64	REFCLK0	65	WTD0N
62	ALERT#/A4WP_IRQ# (I)(0/3.3)	63	GND
60	I2C CLK/A4WP_I2C_CLK (O)(0/3.3)	61	WT_D1P
58	I2C DATA/A4WP_I2C_DATA (I/O)(0/3.3)	59	WT_D1N
56	W_DISABLE1# (O)(0/3.3V)	57	GND
54	W_DISABLE2# (O)(0/3.3V)	55	PEWAKE0# (I/O)(0/3.3V)
52	PERST0# (O)(0/3.3V)	53	CLKREQ0# (I/O)(0/3.3V)
50	SUSCLK(32kHz) (O)(0/3.3V)	51	GND
48	COEX1 (I/O)(0/1.8V)	49	REFCLKN0
46	COEX2(I/O)(0/1.8V)	47	REFCLKP0
44	COEX3(I/O)(0/1.8V)	45	GND
42	CLink_CLK (I/O)	43	PERn0
40	CLink_DATA (I/O)	41	PERp0
38	C-Link RESET* (I) (0/3.3V)	39	GND
36	UART RTS/BRI_DT (I) (0/1.8V)	37	PETn0
34	UART CTS (O) (0/1.8V)	35	PETp0
32	UART TXD/RGL_DT (I) (0/1.8V)	33	GND
30	Connector Key	31	Connector Key
28	Connector Key	29	Connector Key
26	Connector Key	27	Connector Key
24	Connector Key	25	Connector Key
22	UART RXD/BRI_RSP (O) (0/1.8V)	23	WGR_CLKP
20	UART WAKE# (O) (0/3.3V)	21	WGR_CLKN
18	GND/LNA_EN	19	GND
16	LED2#	17	WGR_D0P
14	PCM_OUT/I2SSD_OUT/CLKREQ0	15	WGR_D0N
12	PCM_IN/I2SSD_IN	13	GND
10	PCM_SYNC/I2SWS/RF_RESET_B	11	WGR_D1P
8	PCM_CLK/I2SSCK	9	WGR_D1N
6	LED1#	7	GND
4	3.3V	5	USB_D-
2	3.3V	3	USB_D+
		1	GND

## 3.1.4 BIOS Security Jumper

---

**CAUTION!** Do not move a jumper with the power on. Always turn off the power and unplug the power cord from the computer before changing the jumper setting. Otherwise, the board could be damaged.

---

The illustration below shows the location of the BIOS Security Jumper. The 3-pin jumper determines the BIOS Security program's mode.

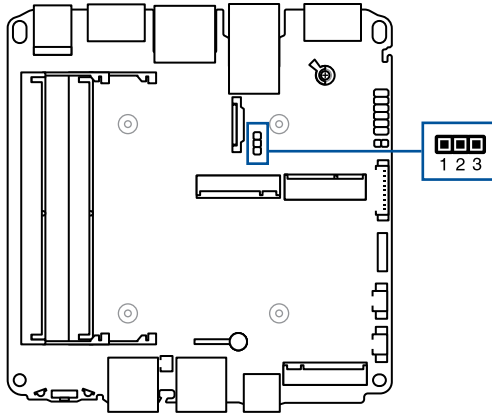

The table below describes the jumper settings for the three modes: normal, lockdown, and configuration.

BIOS Security Jumper Settings		
Function/ Mode	Jumper Setting	Configuration
Normal	1-2	The BIOS uses current configuration information and passwords for booting.
Lockdown	2-3	<p>The BIOS uses current configuration information and passwords for booting, except:</p> <ul style="list-style-type: none"> <li>• All POST Hotkeys are suppressed (prompts are not displayed and keys are not accepted. For example, F2 for Setup, F10 for the Boot Menu).</li> <li>• Power Button Menu is not available (see <b>Power Button Menu</b> section).</li> </ul> <p>BIOS updates are not available except for automatic Recovery due to flash corruption.</p>
Configuration	None	<p>BIOS Recovery Update process if a matching *.cap file is found. Recovery Update can be canceled by pressing the Esc key.</p> <p>If the Recovery Update was canceled or a matching *.cap file was not found, a Config Menu will be displayed. The Config Menu consists of the following (followed by the Power Button Menu selections):</p> <ul style="list-style-type: none"> <li>[1] Suppress this menu until the BIOS Security Jumper is replaced.</li> <li>[2] Clear BIOS User and Supervisor Passwords.</li> <li>[3] Clear Trusted Platform Module. <ul style="list-style-type: none"> <li><b>WARNING!</b> Data encrypted with the TPM will no longer be accessible if the TPM is cleared.</li> </ul> </li> <li>[F2] BIOS Setup Menu.</li> <li>[F4] BIOS Recovery.</li> </ul> <p>See <b>Power Button Menu</b> section.</p>

### 3.1.5 Intel® Management Engine BIOS Extension (Intel® MEBX) Reset Header

The Intel® MEBX reset header allows you to reset the CMOS values to the factory defaults in situations when the system may have become unresponsive, such as after a failed BIOS update. It achieves this by placing a low on the reset pin of the Real Time Clock (RTC).

Momentarily shorting pins 1 and 2 with a jumper will accomplish reset CMOS values to default.

---

#### CAUTION!

- Always turn off the power and unplug the power cord from the computer before installing an MEBX reset jumper. The jumper must be removed before reapplying power. The system must be allowed to reach end of POST before reset is complete. Otherwise, the board could be damaged.
- Care must be taken to avoid inadvertent shorting of the bottom cover screw to the header during bottom cover reassembly. Assemble the bottom cover before reapplying power to the system.

---

**NOTE:** After using the MEBX Reset, a “CMOS battery failure” warning will occur during the next POST. This is expected and does not indicate a component failure.

---

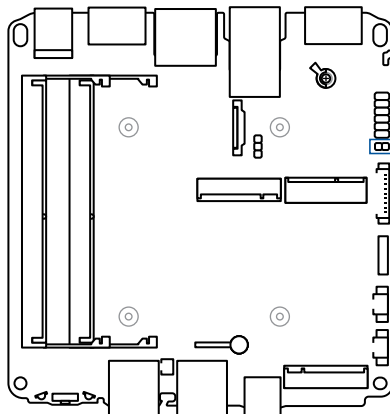

### 3.1.6 Fan Header Current Capability

The table below lists the pin signals and current capability of the CPU fan header. Connector is Molex part number 53398-0471, 1.25mm Pitch PicoBlade Header, Surface Mount, Vertical, Lead-Free, 4 Circuits.

Fan Header	
Pin	Signal Name
1	PWM
2	Tachometer
3	5V DC
4	GND

Fan Header	Maximum Available Current
Processor fan	1 A

### 3.1.7 Power Supply Connector

The board has the following power supply connectors:

- **External Power Supply** - The board can be powered through a 12-20 V DC connector on the back panel. The back-panel DC connector is compatible with a 5.5 mm/OD (outer diameter) and 2.5 mm/ID (inner diameter) plug, where the inner contact is +12-20 V DC and the shell is GND. The maximum current rating is 10 A.

---

**NOTE:** External power voltage, 12-20 ( $\pm 5\%$ ) V DC, is dependent on the type of power supply used. System power requirements will depend on actual system configurations chosen by the integrator, as well as end user expansion preferences. It is the system integrator's responsibility to ensure an appropriate power budget for the system configuration is properly assessed based on the system-level components chosen.

---

## 3.2 Mechanical Considerations

### 3.2.1 Chassis Dimensions

The illustration below illustrates the dimensions for the NUC15CRS chassis. Dimensions are given in millimeters. The chassis length is 112mm (front to back).

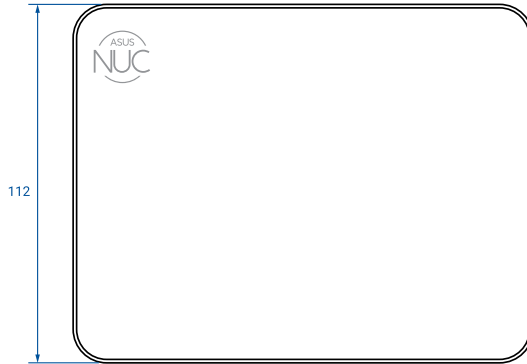

The illustration shows the height and width dimensions of the chassis. Dimensions are in millimeters. The chassis width is 144mm (side to side). The height from the bottom of the system to the top of the system including the rubber feet is 41mm.

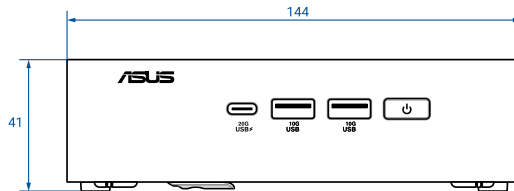

### 3.2.2 Form Factor

The board is designed to fit into a custom chassis. The illustration below illustrates the mechanical form factor for the board. Dimensions are given in millimeters. The outer dimensions are 107.50 millimeters (front to back from furthest excursion of rear HDMI to front Type C) by 101.60 millimeters (side to side). The mounting post centers are identified by the 95.00 and 90.50 millimeters measurements.

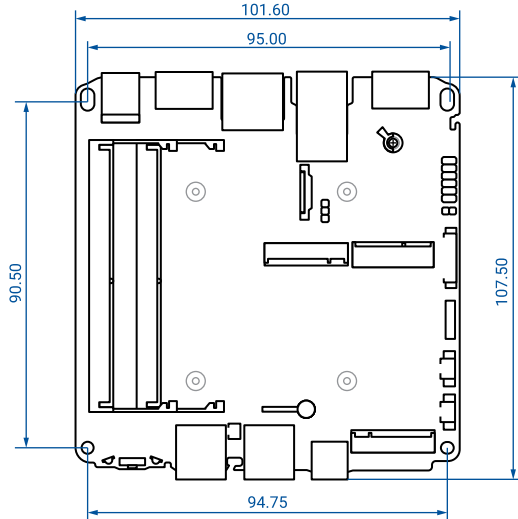

The illustration shows the height dimensions of the board. Dimensions are in millimeters. The tallest feature on the user accessible side of the board when in use is the M.2 retention feature, and on the CPU side is the thermal module.

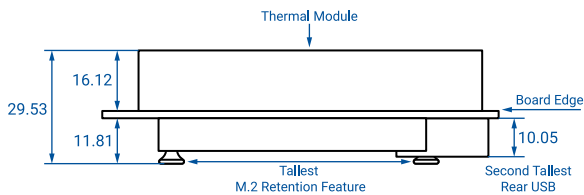

## 3.3 Thermal Considerations

### IMPORTANT!

- Failure to ensure appropriate airflow may result in reduced performance of both the processor and/or voltage regulator or, in some instances, damage to the system.  
All responsibility for determining the adequacy of any thermal or system design remains solely with the system integrator. ASUS makes no warranties or representations that merely following the instructions presented in this document will result in a system with adequate thermal performance.
- Ensure that the ambient temperature does not exceed the system's maximum operating temperature. Failure to do so could cause components to exceed their maximum case temperature and malfunction. For information about the maximum operating temperature, see the environmental specifications in **Environmental** section.
- Ensure that proper airflow is maintained in the processor voltage regulator circuit. Failure to do so may result in shorter than expected product lifetime.

## 3.4 Environmental

The table below lists the environmental specifications for the system.

**IMPORTANT!** If the external ambient temperature exceeds 40°C, further thermal testing is required to ensure components do not exceed their maximum operating temperature.

Parameter	Specification
<b>Temperature</b>	
Sustained Storage Limits (i.e. warehouse)	-20°C ~ +40°C
Short Duration Limits (i.e. shipping)	-40°C ~ +60°C
Ambient Operating - NUC Mini PC	Up to 0°C ~ +40°C
Ambient Operating - NUC Kit	Up to 0°C ~ +40°C
Ambient Operating - NUC Board	Up to 0°C ~ +50°C (Local ambient temperature inside the chassis)
Humidity	0°C ~ +92°C Non-condensing humidity as defined by temperature vs dew point. For more information please visit <a href="https://www.asus.com/ca-en/support/faq/1052552/">https://www.asus.com/ca-en/support/faq/1052552/</a>
<b>* Processor performance may automatically decrease when the system operates in the top 5°C of the ambient operating temperature ranges above.</b>	

*(continued on next page)*

Parameter	Specification																		
<b>Shock (Board)</b>																			
Unpackaged	50 g trapezoidal waveform																		
	Velocity change of 170 inches/s <sup>2</sup>																		
Packaged	Free fall package drop machine set to the height determined by the weight of the package.																		
	<table border="1"> <thead> <tr> <th>Product Weight (pounds)</th> <th>Non-palletized Product drop height (inches)</th> <th>Palletized drop heights (single product) (inches)</th> </tr> </thead> <tbody> <tr> <td>&lt;20</td> <td>36</td> <td>N/A</td> </tr> <tr> <td>21-40</td> <td>30</td> <td>N/A</td> </tr> <tr> <td>41-80</td> <td>24</td> <td>N/A</td> </tr> <tr> <td>81-100</td> <td>18</td> <td>12</td> </tr> <tr> <td>100-120</td> <td>12</td> <td>9</td> </tr> </tbody> </table>	Product Weight (pounds)	Non-palletized Product drop height (inches)	Palletized drop heights (single product) (inches)	<20	36	N/A	21-40	30	N/A	41-80	24	N/A	81-100	18	12	100-120	12	9
	Product Weight (pounds)	Non-palletized Product drop height (inches)	Palletized drop heights (single product) (inches)																
	<20	36	N/A																
	21-40	30	N/A																
	41-80	24	N/A																
81-100	18	12																	
100-120	12	9																	
<b>Shock (System)</b>																			
Unpackaged	25g trapezoidal waveform																		
	Velocity = 250 inches/sec, 2 shock table drops in each of 6 directions																		
<b>Vibration (Board)</b>																			
Unpackaged	Random profile 5 Hz @ 0.01 g <sup>2</sup> /Hz to 20 Hz @ 0.02 g <sup>2</sup> /Hz(slope up) 20 Hz to 500 Hz @ 0.02 g <sup>2</sup> /Hz (flat)																		
	Input acceleration is 3.13g RMS																		
<b>Vibration (System)</b>																			
Unpackaged	Random profile 5 Hz @ 0.001 g <sup>2</sup> /Hz to 20 Hz @ 0.01 g <sup>2</sup> /Hz(slope up) 20 Hz to 500 Hz @ 0.01 g <sup>2</sup> /Hz (flat)																		
	Input acceleration is 2.20g RMS																		
Packaged	Random Profile: 0.001 g <sup>2</sup> /Hz to 20 Hz @ 0.01 g <sup>2</sup> /Hz (slope up) 20 Hz to 500 Hz @ 0.01 g <sup>2</sup> /Hz (flat)																		
	Input acceleration is 2.20g RMS																		

**NOTE:**

- The operating temperature of the system may be determined by measuring the air temperature from the junction of the heatsink fins and fan, next to the attachment screw, in a closed chassis, while the system is in operation.
- Before attempting to operate this system, the overall temperature of the system must be above the minimum operating temperature specified. It is recommended that the system temperature be at least room temperature before attempting to power on the system. The operating and non-operating environment must avoid condensing humidity.

# 4. BIOS Support

## 4.1 Introduction

The system uses an AMI BIOS core that is stored in the Serial Peripheral Interface Flash Memory (SPI Flash) and can be updated through multiple methods (see **BIOS Updates** section). The SPI Flash contains the BIOS Setup program, POST, the PCI auto-configuration utility, LAN EEPROM information, and Plug and Play support. The SPI Flash includes a flash memory device of either 32MB or 64MB depending on SKU.

The NUC15CRS[x][x][x] product line has three BIOS options for different versions of the board, kit, or mini-pc. These BIOS options are not interchangeable between the two types of products, and they are "keyed" to the platform they are intended to be used with.

- The NUC15CRSU5 / NUC15CRSU7 / NUC15CRSU9 uses the CRARL579.XXXX structure and is intended for use with the boards using the Intel® Processor 225H, 255H or 285H.
- The NUC15CRSV5 / NUC15CRSV7 uses the CRARLV57.XXXX structure and is intended for use with boards using the Intel® Processor 235H or 265H.

The BIOS Setup program can be used to view and change the identification information and the BIOS settings for the system. The BIOS Setup program is accessed by pressing <F2> after the POST memory test beings and before the operating system boots.

## 4.2 BIOS Updates

The BIOS can be updated using one of the following methods:

- Express BIOS (Windows-based) Update
- F7 Update
- Power Button Menu Update
- UEFI Shell Update
- EZ Flash (BIOS Setup)

### 4.2.1 BIOS Recovery

It is unlikely that anything will interrupt a BIOS update; however, if an interruption occurs the BIOS could be unstable. The table below lists the drives and media types that can be used for BIOS recovery. The BIOS recovery media does not need to be made bootable.

Media Type	Can be used for BIOS recovery?
Hard disk drive (connected to SATA or USB)	Yes
USB flash drive	Yes
NVME SSD (M.2 interface)	Yes

---

**NOTE:** Supported file systems for BIOS recovery: NTFS (sparse, compressed, or encrypted files are not supported), FAT32, EXT.

---

## 4.3 Boot Options

In the BIOS Setup program, the user can choose to boot from a hard drive, removable driver, or the network. The default setting is for the hard drive to be the first boot device, the removable drive second, and the network third.

---

**NOTE:** The network can be selected as a boot device. This selection allows booting from the onboard LAN or a network add-in card with a remote boot ROM installed. Pressing the <F12> key during POST automatically forces booting from the LAN. To use this key during POST, the User Access Level in the BIOS Setup program's Security menu must be set to Full.

---

### 4.3.1 Boot Device Selection During Post

Pressing the <F10> key during POST causes a boot device menu to be displayed. The menu displays the list of available boot devices.

### 4.3.2 Power Button Menu

As an alternative to Configuration Mode or normal POST hotkeys, the user can use the power button to access a menu with BIOS and boot options. The Power Button Menu is accessible via the following sequence:

1. System is in S4/S5 (not G3).
2. User pushes the power button and holds it down for 3 seconds.
3. The Front Panel Power Button LED will be on for the first 3 seconds. After 3 seconds, the LED will begin to blink in the following pattern: 0.25 seconds off, 0.25 seconds on, 0.25 seconds off to signal the user to release the power button.
4. User releases the power button before the 4-second shutdown override.

If this boot path is taken, the BIOS will use default settings, ignoring settings in VPD where possible. At the point where Setup Entry/Boot would be in the normal boot path, the BIOS will display the following prompt and wait for a keystroke:

If an unrecognized key is hit, then the BIOS will do nothing and wait for another keystroke. If one of the listed hotkeys is hit, the BIOS will follow the indicated boot path. Password requirements must still be honored.

Power Button Menu Options		
Keystroke	Option	Description
[ESC]	Normal Boot	-
[F2]	BIOS Setup Menu	-
[F3]	Disable Fast Boot	<b>NOTE:</b> Will only be displayed if at least one Fast Boot optimization is enabled. If Disable Fast Boot is selected, the BIOS will disable all Fast Boot optimizations and reset the system.
[F4]	BIOS Recovery	The BIOS will search for a matching .CAP file from the \EFI\Intel folder in the supported media with the supported file system. If a matching recovery capsule is found, the BIOS will display the following: <b>BIOS will Recover to &lt;BIOSID&gt; in 20 seconds.</b> <b>[ESC] Cancel Recovery</b> Recovery will proceed if not canceled via the ESC key within 20 seconds. The BIOS shall display the recovery progress. If a BIOS .CAP file was not detected (or the BIOS Recovery was canceled) then the BIOS will reset the system and continue normally to POST.
[F5]	Restore BIOS Settings	The BIOS will restore the current setup settings and the current defaults to the build time defaults in the case of a boot issue caused by setup variable changes.
[F7]	Update BIOS	BIOS Update during the BDS phrase. The BIOS will update independent of any OS loading and provides a menu UI accessible during boot up. This is not a recovery tool and will not overwrite a corrupt BIOS or ME firmware.
[F9]	Remote Assistance	<b>NOTE:</b> Will only be displayed if Remote Assistance is supported.
[F10]	Enter Boot Menu	-
[F12]	Network Boot	-

## 4.4 Hard Disk Drive Password Security Feature

The Hard Disk Drive Password Security feature blocks read and write access to the hard disk drive until the correct password is given. Hard disk drive passwords are set in BIOS Setup and are prompted for BIOS POST. For convenient support for resuming from S3, the system BIOS will automatically unlock drives on resume from S3. Valid password characters are A-Z, a-z, and 0-9. Passwords may be up to 32 characters in length.

The User hard disk drive password, when set, will be required on each power cycle until the Master Key or User hard disk drive password is submitted.

The Master Key hard disk drive password, when set, will not lock the drive. The Master Key hard disk drive password exists as an unlock override if the User hard disk drive password is forgotten. Only the User hard disk drive password, when set, will cause a hard disk to be locked on a system power cycle. The table below shows the effects of setting the hard disk drive passwords.

Password Set	Password During Boot
Neither	None
Master only	None
User only	User only
Master and User Set	User

During every POST, if a User hard disk drive password is set, POST execution will pause with the following prompt to force the User to enter the Master Key or the User hard disk drive password:

**“Enter Hard Disk Drive Password:”**

Upon successful entry of the Master Key or User hard disk drive password, the system will continue with normal POST.

If the hard disk drive password is not correctly entered, the system will go back to the above prompt. The User will have three attempts to correctly enter the hard disk drive password. After the third unsuccessful attempt, the system will halt with the following message:

**“Hard Disk Drive Password Entry Error”**

A manual power cycle will be required to resume system operation.

## 4.5 BIOS Security Features

The BIOS includes security features that restrict access to the BIOS Setup program and who can boot the computer. A Supervisor and User password can be set for the BIOS Setup program and for booting the computer, with the following restrictions:

- The Supervisor password gives unrestricted access to view and change all the Setup options in the BIOS Setup program. This is Supervisor Mode.
- The User password gives restricted access to view and change Setup options in the BIOS Setup program. This is User Mode.
- If only the Supervisor password is set, pressing the <Enter> key at the password prompt of the BIOS Setup program allows the user restricted access to Setup.
- If both the Supervisor and User passwords are set, users can enter either the Supervisor or User password to access Setup. Users have access to Setup regardless of which password is used.
- Setting the User password restricts who can boot the computer. The password prompt will be displayed before the computer boots. If only the Supervisor password is set, the computer boots without asking for a password. If both passwords are set, the user can enter either password to boot the computer.
- For enhanced security, use different passwords for the Supervisor and User passwords.
- Valid password characters are A-Z, a-z, 0-9, and special characters. Passwords may be up to 20 characters in length.
- To clear a set password, enter a blank password after entering the existing password.

The table below shows the effects of setting the Supervisor password and User password. This table is for reference only and is not displayed on the screen.

<b>Password Set</b>	<b>Neither</b>	<b>Supervisor only</b>	<b>User only</b>	<b>Supervisor and User set</b>
<b>Supervisor Mode</b>	Any user can change all options	Can change all options	N/A	Can change all options
<b>User Mode</b>	Any user can change all options	Can change a limited number of options	Can change all options	Can change a limited number of options
<b>Setup Options</b>	None	Supervisor Password	Enter Password Clear User Password	Supervisor Password Enter Password
<b>Password to Enter Setup</b>	None	Supervisor	User	Supervisor or User
<b>Password During Boot</b>	None	None	User	Supervisor or User

## 4.6 BIOS Error Messages

The table below lists the error messages and provides a brief description of each.

Error Message	Explanation
CMOS Battery Failure	The battery may be losing power. Replace the battery soon.
CMOS Checksum Error	The CMOS checksum is incorrect. CMOS memory may have been corrupted. Run Setup to reset values.
Memory Size Decreased	Memory size has decreased since the last boot. If no memory was removed, then the memory may be bad.
CMOS Timer Not Set	The battery may be losing power. Replace the battery soon.
Processor Overheated	Processor overheated in previous boot.
Auto RTC Reset	The system triggers RTC clear to recover the system back to the normal condition from consecutive boot failure.