



Grandstream Networks, Inc.

GWN78xx Switches Series

User Manual



INTRODUCTION

The Grandstream GWN78xx series includes a range of managed network switches designed to support scalable, secure, and high-performance business networks for enterprises of all sizes. Each series within the GWN78xx family offers specific functionalities:

- **GWN780x Series:** Layer 2+ managed switches, ideal for small-to-medium businesses needing advanced traffic segmentation and prioritization.
- **GWN781x Series:** Layer 3 managed switches, providing enhanced routing capabilities for medium-to-large enterprises.
- **GWN782x Series:** Layer 3 multi-gigabit switches, suited for medium-to-large businesses requiring high data throughput and advanced network management.
- **GWN783x Series:** Aggregation switches, designed for enterprises needing high-capacity, scalable infrastructure for large network environments.

All models in the GWN78xx series support advanced VLAN for flexible traffic segmentation, QoS for network traffic prioritization, IGMP/MLD Snooping for performance optimization, and comprehensive security capabilities. PoE models are available to power IP phones, IP cameras, Wi-Fi access points, and other PoE endpoints.

The GWN78xx series can be managed through multiple methods, including a local web user interface, command-line interface (CLI), and integration with Grandstream's GDMS Networking and GWN Manager platforms, providing complete end-to-end network management options.

Whether deployed in small-to-medium businesses, larger enterprises, or as part of aggregation networks, the GWN78xx series delivers enterprise-grade performance and reliability for diverse network needs.

PRODUCT OVERVIEW

Technical Specifications

- **GWN7801(P)/GWN7802(P)/GWN7803(P)**

	GWN7801	GWN7801P	GWN7802	GWN7802P	GWN7803	GWN7803P
Network Protocol	IPv4, IPv6, IEEE 802.3, IEEE 802.3i, IEEE 802.3u, IEEE 802.3ab, IEEE 802.3z, IEEE 802.3x, IEEE 802.3af/at, IEEE 802.1p, IEEE 802.1Q, IEEE 802.1w, IEEE 802.1d, IEEE 802.1s					
Gigabit Ethernet Ports	8		16		24	
Gigabit SFP Ports	2		4			
Console	1					
Number of PoE Ports	/	8	/	16	/	24
Integrated Power Supply	30W	150W	30W	270W	30W	400W
Max Output Power per PoE Port	/	30W	/	30W	/	30W

Max Total PoE Output Power	/	120W	/	240W	/	360W
PoE Standards	/	IEEE 802.3af/at	/	IEEE 802.3af/at	/	IEEE 802.3af/at
Auxiliary Ports	1x Reset Pinhole					
Forwarding Mode	Store-and-forward					
Total non-blocking throughput	10Gbps		20Gbps		28Gbps	
Switching Capability	20Gbps		40Gbps		56Gbps	
Forwarding Rate	14.88M packets per second		29.76M packets per second		41.66M packets per second	
Packet Buffer	4.1MB					
Switching	<ul style="list-style-type: none"> ● 8K static, dynamic and filtering MAC addresses ● 4K VLANs, port-based VLAN, IEEE 802.1Q VLAN tagging, voice VLAN ● VLAN virtual interface ● 8 link aggregation groups ● Spanning tree, 16 instances for MSTP 					
Multicast	IGMP Snooping, MLD Snooping					
QoS/ACL	<ul style="list-style-type: none"> ● Auto detection and prioritization of voice/video/RTP/SIP/other latency-sensitive packets ● Port priority ● Priority mapping ● Queue scheduling, including SP, WRR ● Traffic shaping ● Rate limit ● 1.5K ACL for Ethernet, IPv4 and IPv6 					
DHCP	Option 82, 60,160 and 43					
Maintenance	CPU and memory monitoring, SNMP, RMON, LLDP&LLDP-MED, backup and restore, syslog, alert, diagnostics including Ping, Traceroute, port mirroring					
Security	<ul style="list-style-type: none"> ● User hierarchical management and password protection, HTTPS, SSH, Telnet ● 802.1X authentication ● AAA authentication including RADIUS, TACACS+ ● Storm control ● Port isolation, port security, sticky MAC ● Filtering MAC address ● IP source guard, DoS attack prevention, ARP inspection ● DHCP Snooping ● Loop protection including BPDU protection ● Kensington Security Slot (Kensington Lock) support 					
Mounting	Desktop, wall-mount, or rack-mount (rack-mount brackets included)					

LEDs	1x tri-color LED for device tracking and status indication					
	10x green LEDs for data ports	10x green LEDs for data ports, 8x yellow-color LEDs for PoE ports	20x green LEDs for data ports	20x green LEDs for data ports, 16x yellow-color LEDs for PoE ports	28x green LEDs for data ports	28x green LEDs for data ports, 24x yellow-color LEDs for PoE ports
Fan	/	/	/	1	/	2
Environmental	Operation: 0°C to 45°C, humidity 10-90% RH(Non-condensing) Storage: -10°C to 60°C, humidity: 5% to 95%(Non-condensing)					
Dimensions	300mm(L)*175mm(W)*44(H)			440mm(L)*200mm(W)*44mm(H)		
Unit Weight(TBD)	1.8Kg	2Kg	2.6Kg	3Kg	2.7Kg	3.3Kg
Package Content	Switch, 1x 1.2m(10A) AC Cable, 1x Ground Cable, 4x Rubber Feet, 2x Lug Ear		Switch, 1x 1.2m(10A) AC Cable, Rack-mounting Standard Brackets, 1x Ground Cable, 4x Rubber Feet, 2x Lug Ear			
Compliance	FCC, CE, RCM, IC, UKCA					

GWN780x Technical Specifications

o **GWN7806(P)**

	GWN7806	GWN7806P
Network Protocols	IPv4, IPv6, IEEE 802.3, IEEE 802.3i, IEEE 802.3u, IEEE 802.3ab, IEEE 802.3z, IEEE 802.3ae, IEEE 802.3az, IEEE 802.3ad, IEEE 802.3x, IEEE 802.3af/at, IEEE 802.1p, IEEE 802.1Q, IEEE 802.3AB, IEEE 802.1p, IEEE 802.1D, IEEE 802.1s, IEEE 802.1w, IEEE 802.1x	
Gigabit Ethernet Ports	48	
SFP+ Ports	6	
	<i>Note: Support DAC cable, and must be ≤ 5m</i>	
Maximum no. of Supported Modules	SM-10G: 6 MM-10G: 6 RJ45-10G: 3	
	<i>Note: RJ45-10G modules must be interval inserted</i>	
Console	1	
PoE Standards	/	IEEE 802.3af/at
Number of PoE Ports	/	48
Integrated Power Supply	60W	470W

Max Output Power per PoE Port	/	30W
Max Total PoE Output Power	/	400W
Auxiliary Ports	1x Reset Pinhole	
Forwarding Mode	Store-and-forward	
Total non-blocking throughput	108Gbps	
Switching Capability	216Gbps	
Forwarding Rate	160.702Mpps	
Packet Buffer	16MB	
Network Latency	<4μs	
Switching	<ul style="list-style-type: none"> ● 32K static, dynamic and filtering MAC addresses ● 4K VLANs, port-based VLAN, IEEE 802.1Q VLAN tagging, voice VLAN ● VLAN virtual interface ● GVRP (pending) ● 27 link aggregation ● Spanning tree, 64 instances for STP/RSTP/MSTP 	
Routing	Static routing	
Multicast	<ul style="list-style-type: none"> ● IGMP Snooping ● MLD Snooping ● MVR (pending) 	
QoS/ACL	<ul style="list-style-type: none"> ● Port priority ● Priority mapping ● Queue scheduling, including SP, WRR, WFQ, SP-WRR, and SP-WFQ ● Traffic shaping ● Rate limit ● 4K ACL for Ethernet, IPv4 and IPv6 	
DHCP	DHCP server, DHCP relay, DHCP Option 82, 60, 160 and 43	
Maintenance	CPU and memory monitoring, SNMP, RMON, LLDP&LLDP-MED, backup and restore, syslog, diagnostics including Ping, Traceroute, port mirroring, UDLD(TBD) and copper test	
Security	<ul style="list-style-type: none"> ● User hierarchical management and password protection, HTTPS, SSH, Telnet ● 802.1X authentication ● AAA authentication including RADIUS, TACACS+ ● Storm control 	

	<ul style="list-style-type: none"> ● Port isolation, port security, sticky MAC ● Filtering MAC address ● IP source guard, DoS attack prevention, ARP inspection ● DHCP Snooping ● Loop protection including BPDU protection, root protection(pending) and loopback protection(pending) ● Kensington Security Slot (Kensington Lock) support 	
Mounting	Desktop, wall-mount, or rack-mount (rack-mount brackets included)	
LEDs	<p>1x tri-color LED for device tracking and status indication</p> <p>54x green-color LEDs for data transferring</p> <p>48x yellow-color LEDs for PoE powered (GWN7806P)</p>	
Fan	3	
Environmental	<p>Operation: 0°C to 45°C, humidity 10-90% RH (Non-condensing)</p> <p>Storage: -10°C to 60°C, humidity: 10% to 90% (Non-condensing)</p>	
Dimensions	440mm(L)x301mm(W)x44mm(H)	
Unit Weight	4.0Kg	5.1Kg
Package Content	Switch, 1x 1.2m(10A) AC Cable, 1x 25cm Ground Cable, 4x Rubber Footpads, 2x Rack-Mounting Kits, 8x Screws(PM 3*6), 1x Power Cord Anti-Trip, 1x Quick Installation Guide, 1x Console Cable(Optional)	
Compliance	FCC, CE, RCM, IC, UKCA	

GWN7806 Technical Specifications

○ **GWN7811(P)/GWN7812P/GWN7813(P)/GWN7816(P)**

	GWN7811	GWN7811P	GWN7812P	GWN7813	GWN7813P	GWN7816	GWN7816P
Network Protocol	IPv4, IPv6, IEEE 802.3, IEEE 802.3i, IEEE 802.3u, IEEE 802.3ab, IEEE 802.3z, IEEE 802.3ae, IEEE 802.3az, IEEE 802.3ad, IEEE 802.3x, IEEE 802.3af/at/bt, IEEE 802.1p, IEEE 802.1Q, IEEE 802.1d, IEEE 802.1s, IEEE 802.1w, IEEE 802.1x						
Gigabit Ethernet Ports	8		16		24		48
Gigabit SFP Ports	2			4			6
Console	1						
Number of PoE Ports	/	8	16	/	24	/	48
External Redundant Power Supply (RPS)	/	/	/	12V/5A (60W)	54V (300W)	/	/
Hot swap PSU	/					Support 1 Hot swap PSU (Purchased Separately)	

Max Output Power per PoE Port	/	30W	30W	/	60W (1-8, PoE++) 30W (9-24)	/	60W(1-8, PoE++) 30W (9-48)
Max Total PoE Output Power	/	120W	240W	/	360W	/	740W with 1 PSU
PoE Standards	/	IEEE 802.3af/at	IEEE 802.3af/at	/	IEEE 802.3af/at/bt	/	IEEE 802.3af/at/bt
Auxiliary Ports	1x Reset Pinhole						
Forwarding Mode	Store-and-forward						
Total non-blocking throughput	28Gbps		56Gbps		64Gbps		108Gbps
Switching Capability	56Gbps		112Gbps		128Gbps		216Gbps
Forwarding Rate	41.644Mpps		83.328Mpps		95.232Mpps		160.704Mpps
Packet Buffer	12MB					16Mb	
Switching	<ul style="list-style-type: none"> ● 16K static, dynamic and filtering MAC addresses ● 4K VLANs, port-based VLAN, IEEE 802.1Q VLAN tagging, voice VLAN ● VLAN virtual interface ● GVRP (pending) ● 8 link aggregation groups for GWN7811(P)/GWN7812P/GWN7813(P) and 27 for GWN7816(P) ● Spanning tree, STP/RTSP/MSTP/PVST(+), 32 instances for GWN7811(P)/GWN7812P/GWN7813(P) and 64 for GWN7816(P) 						
Routing	<ul style="list-style-type: none"> ● Static routing ● Dynamic routing, including RIP, RIPng, OSPF and OSPFv3 ● Policy routing (pending) 						
Multicast	<ul style="list-style-type: none"> ● IGMP Snooping with IGMPv2 and IGMPv3 ● MLD Snooping with MLDv1 and MLDv2 ● MVR (pending) 						
QoS/ACL	<ul style="list-style-type: none"> ● Auto detection and prioritization of voice/video/RTP/SIP/other latency-sensitive packets ● Port priority ● Priority mapping ● Queue scheduling, including SP, WRR, WFQ, SP-WRR, and SP-WFQ ● Traffic shaping ● Rate limit ● 2K (GWN7811(P)/GWN7812P/GWN7813(P)) and 4K (GWN7816(P)) ACL for Ethernet, IPv4 and IPv6 						
DHCP	DHCP Server, DHCP Relay, Option 82, 60,160, and 43						
Maintenance	CPU and memory monitoring, fault detection and alarm for power supply and fan, SNMP, RMON, LLDP&LLDP-MED, backup and restore, syslog, diagnostics including Ping, Traceroute, port mirroring, UDLD(pending) and copper						

	test						
Security	<ul style="list-style-type: none"> • User hierarchical management and password protection, HTTPS, SSH, Telnet • 802.1X authentication • AAA authentication including RADIUS, TACACS+ • Storm control • Port isolation, port security, sticky MAC • Filtering MAC address • IP source guard, DoS attack prevention, ARP inspection • DHCP Snooping • Loop protection including BPDU protection, root protection (pending), and loopback protection (pending) • Kensington Security Slot (Kensington Lock) support 						
Mounting	Desktop/ Wall-Mount Desktop, wall-mount, or rack-mount (rack-mount brackets included)				Desktop, or Rail-Mount (rack-mounting kits included)		
System LEDs	1x tri-color LED for device tracking and status indication 2x bi-color LEDs for per power supply PSU1/2 green-color LEDs for data transferring yellow-color LEDs for PoE powered (GWN781x(P))						
Fan	/	/	2	/	3	4	
Environmental	Operation: 0°C to 45°C, humidity 10-90% RH (Non-condensing) Storage: -10°C to 60°C, humidity: 5% to 95% (Non-condensing) and 10% to 90% (Non-condensing) for GWN7816(P)						
Dimensions	300mm(L)*176mm(W)*44mm(H)		440mm(L)*200mm(W)*44mm(H)		440mm(L)* 300mm(W) *44mm(H)	440mm(L)x 300mm(W) x44mm(H)	440mm(L)x 380mm(W) x44mm(H)
Unit Weight (TBD)	1.8KG	2KG	3KG	3KG	2.7KG	4.7Kg	6Kg
Compliance	FCC, CE, RCM, IC, UKCA						

GWN781x Technical Specifications

o GWN7821P/GWN7822P

	GWN7821P	GWN7822P
Network Protocol	IPv4, IPv6, IEEE 802.3, IEEE 802.3i, IEEE 802.3u, IEEE 802.3ab, IEEE 802.3z, IEEE 802.3ae, IEEE 802.3az, IEEE 802.3ad, IEEE 802.3x, IEEE 802.3af/at/bt, IEEE 802.1p, IEEE 802.1Q, IEEE 802.1d, IEEE 802.1w, IEEE 802.1s, IEEE 802.1x	
Gigabit Ethernet Ports	8x 2.5G	16x 1G, 8x 2.5G
10 Gigabit SFP+ Ports	2	4
Maximum no. of Supported Modules	SM-10G: 2 MM-10G: 2 RJ45-10G: 2	SM-10G: 4 MM-10G: 4 RJ45-10G: 2
	/	<i>Note: RJ45-10G modules must be interval inserted</i>
Console	1	

Number of PoE Ports	8	24
Link Aggregation Groups	5	14
Integrated Power Supply	280W (54V/5.19A)	420W (54V/7.78A)
External Redundant Power Supply (RPS)	/	54V (300W)
Max Output Power per PoE Port	60W	30W for ports 1-16, 60W for ports 17-24
Max Total PoE Output Power	240W	360W
PoE Standards	IEEE 802.3af/at/bt	
Surge Protection	± 6KV CM and DM for power ± 4KV CM for network ports	
ESD	± 12KV for contact discharge	
Auxiliary Ports	1x Reset Pinhole	
Forwarding Mode	Store-and-forward	
Total non-blocking throughput	40Gbps	76Gbps
Switching Capability	80Gbps	152Gbps
Forwarding Rate	59.52Mpps	113.088Mpps
Packet Buffer	12Mb	
Network Latency	<4μs	
Switching	<ul style="list-style-type: none"> • 16K MAC addresses, including static, dynamic and filtering MAC address • 4K VLANs, port-based VLAN, IEEE 802.1Q VLAN tagging, MAC-based VLAN, Protocol-based VLAN, voice VLAN • Private VLAN (pending) • VLAN virtual interface • Spanning tree, 32 instances for STP/RTSP/MSTP/PVST(+) 	
Routing	<ul style="list-style-type: none"> • Static routing • Dynamic routing, including RIP, RIPng, OSPF, OSPFv3, IS-IS (pending) and BGP (pending) • Policy routing • Routing policy (pending) 	
Multicast	<ul style="list-style-type: none"> • IGMP Snooping with IGMPv2 and IGMPv3 • MLD Snooping with MLDv1 and MLDv2 • MVR (pending) 	
QoS/ACL	<ul style="list-style-type: none"> • Port priority • Priority mapping • Queue scheduling, including SP, WRR, WFQ, SP-WRR and SP-WFQ 	

	<ul style="list-style-type: none"> • Traffic shaping • Rate limit • 2K ACL for Ethernet, IPv4 and IPv6 	
DHCP	DHCP server, DHCP relay, Option 82, 60, 160, and 43	
Maintenance	CPU and memory monitoring, SNMP, RMON, LLDP&LLDP-MED, backup and restore, syslog, diagnostics including Ping, Traceroute, mirroring, UDLD(pending) and copper test	
System LEDs	1x tri-color LED for device tracking and status indication	
Power Supply LEDs	/	2x green-color LEDs for power supply (PWR & RPS)
PoE Powered LEDs	8x yellow-color LEDs	24x yellow-color LEDs
Data Transferring LEDs	10x green-color LEDs	28x green-color LEDs
Fan	2	
Environmental	<ul style="list-style-type: none"> • Operation: 0°C to 45°C, humidity 10% to 90% RH(Non-condensing) • Storage: -10°C to 60°C, humidity: 10% to 90% RH(Non-condensing) 	
Dimensions	330mm(L) x 175mm(W) x 44mm(H)	440mm(L) x 300mm(W) x 44mm(H)
Unit Weight	2.17Kg	4.69Kg
Package Contents	1x Switch	
	1x 1.2m(10A) AC Cable	
	1x 25cm Ground Cable	
	4x Rubber Footpads	
	1x Power Cord Anti-Trip	
	8x Screws (KM 3*6)	
	1x Quick Installation Guide	
	1x Console Cable (Optional)	
	2x Extended Rack-Mounting Kits	2x Rack-Mounting Kits
	/	1x RPS, External Redundant Power Supply(Optional)
Compliance	FCC, CE, RCM, IC	

GWN782x Technical Specifications

o GWN7830/GWN7831/GWN7832

	GWN7830	GWN7831	GWN7832
--	----------------	----------------	----------------

Network Protocol	IPv4, IPv6, IEEE 802.3, IEEE 802.3i, IEEE 802.3u, IEEE 802.3ab, IEEE 802.3z, IEEE 802.3ae, IEEE 802.3az, IEEE 802.3ad, IEEE 802.3x, IEEE 802.1p, IEEE 802.1Q, IEEE 802.3AB, IEEE 802.1D, IEEE 802.1s, IEEE 802.1w, IEEE 802.1x		
Gigabit Ethernet Ports	2	4x Combo	/
Gigabit SFP Ports	6	4x Combo, 20x SFP	/
10 Gigabit SFP+ Ports	4		12
Console	1		
Integrated Power Supply	30W	60W	
External Redundant Power Supply(RPS)	/	12V/60W	
Auxiliary Ports	1x Reset Pinhole		
Forwarding Mode	Store-and-forward		
Total non-blocking throughput	48Gbps	64Gbps	120Gbps
Switching Capability	96Gbps	128Gbps	240Gbps
Forwarding Rate	71.424Mpps	95.232Mpps	80.352Mpps
Packet Buffer	12MB		16MB
Switching	<ul style="list-style-type: none"> ● 16K static, dynamic and filtering MAC addresses ● Spanning tree, 32 instances for STP/RSTP/MSTP 		<ul style="list-style-type: none"> ● 32K static, dynamic and filtering MAC addresses ● Spanning tree, 64 instances for STP/RSTP/MSTP
	<ul style="list-style-type: none"> ● 4K VLANs, port-based VLAN, IEEE 802.1Q VLAN tagging, voice VLAN ● VLAN virtual interface ● GVRP(pending) ● 8 link aggregation 		
Routing	<ul style="list-style-type: none"> ● Static routing ● Dynamic routing, including RIP, RIPng, OSPF and OSPFv3 ● Policy routing (pending) 		
Multicast	<ul style="list-style-type: none"> ● IGMP Snooping with IGMPv2 and IGMPv3 ● MLD Snooping with MLDv1 and MLDv2 ● MVR (pending) 		
QoS/ACL	<ul style="list-style-type: none"> ● Port priority ● Priority mapping 		

	<ul style="list-style-type: none"> • Queue scheduling, including SP, WRR, WFQ, SP-WRR and SP-WFQ • Traffic shaping • Rate limit 		
	<table border="1"> <tr> <td>2K ACL for Ethernet, IPv4 and IPv6</td> <td>4K ACL for Ethernet, IPv4 and IPv6</td> </tr> </table>	2K ACL for Ethernet, IPv4 and IPv6	4K ACL for Ethernet, IPv4 and IPv6
2K ACL for Ethernet, IPv4 and IPv6	4K ACL for Ethernet, IPv4 and IPv6		
DHCP	DHCP server, DHCP relay, Option 82, 60, 160 and 43		
Maintenance	CPU and memory monitoring, fault detection and alarm for power supply and fan, SNMP, RMON, LLDP&LLDP-MED, backup and restore, syslog, diagnostics including Ping, Traceroute, port mirroring, UDLD(TBD) and copper test		

GWN783x Technical Specifications

INSTALLATION

Before deploying and configuring a GWN78xx switch, the device needs to be properly powered up and connected to the network. This section describes detailed information on the installation, connection, and warranty policy of the GWN78xx switch.

Package Content

o GWN7801(P)/GWN7802(P)/GWN7803(P)

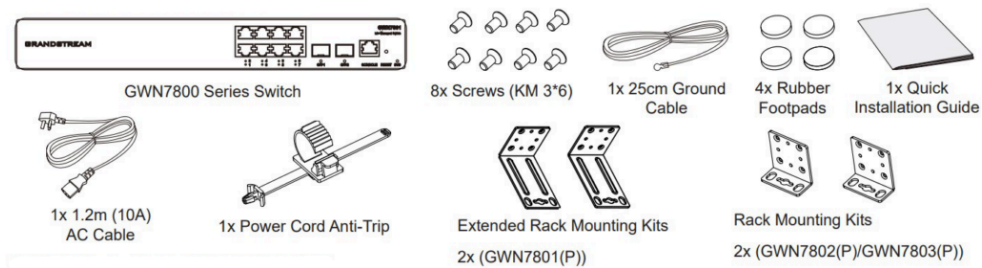

GWN780x Package Contents

o GWN7806(P)

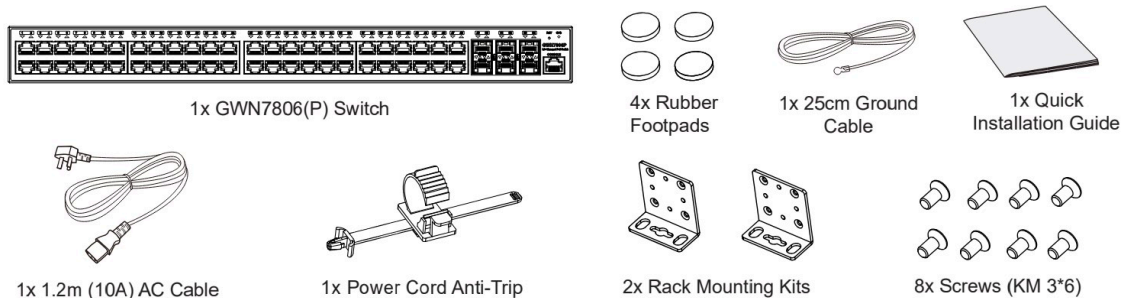

GWN7806P Package Contents

o GWN7811(P)/GWN7812P/GWN7813(P)/GWN7816(P)

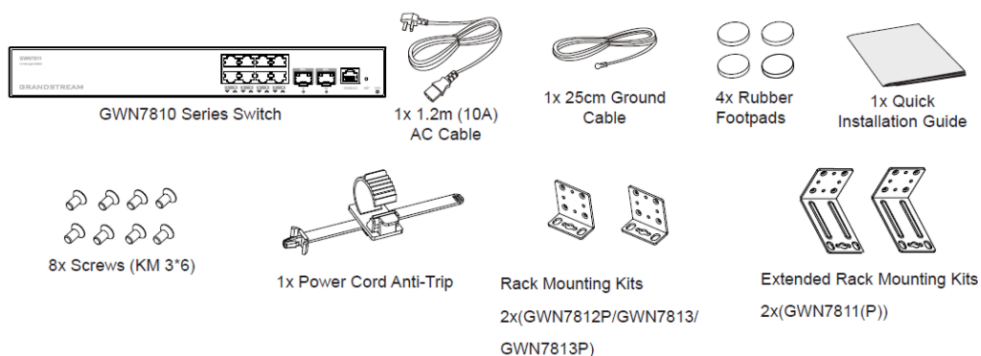

GWN7811P GWN7812p and GWN7813P Package Content

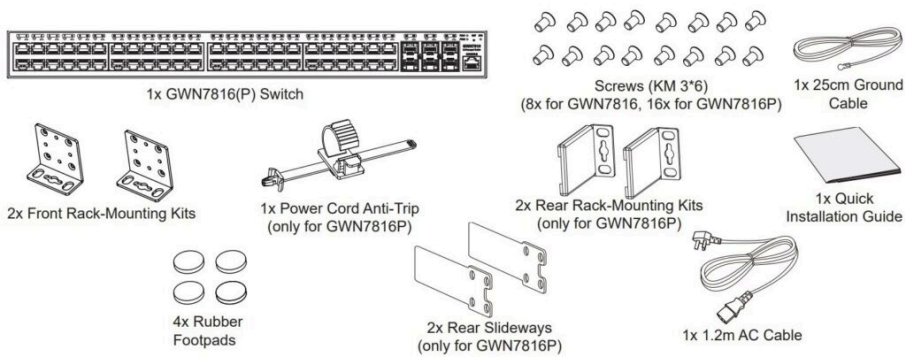

GWN7816P Package Content

o GWN7821(P)/GWN7822(P)

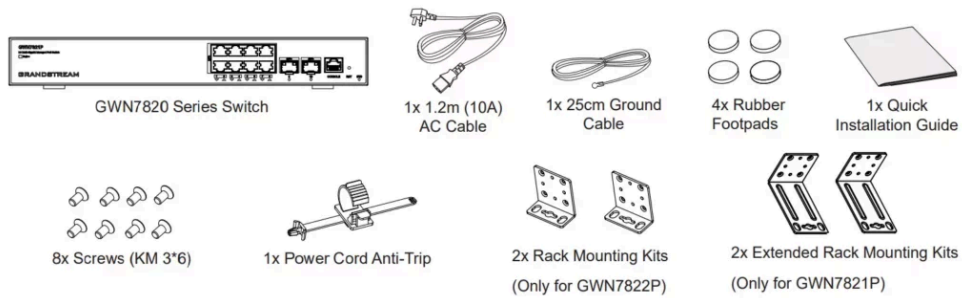

GWN782x Package Content

o GWN7830/GWN7831/GWN7832

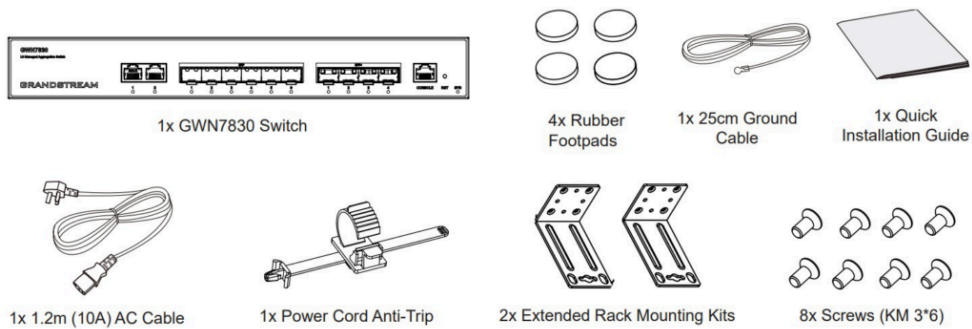

GWN7830 Package Content

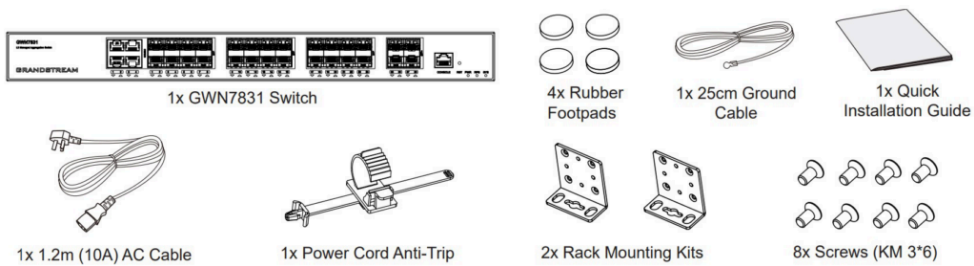

GWN7831 Package Content

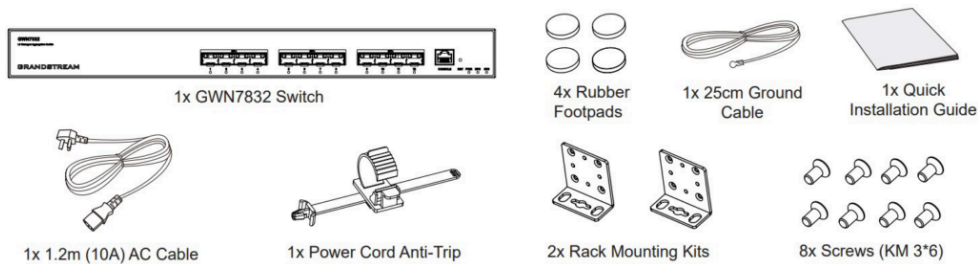

GWN7832 Package Content

GWN78xx Ports

o GWN7801/GWN7801P

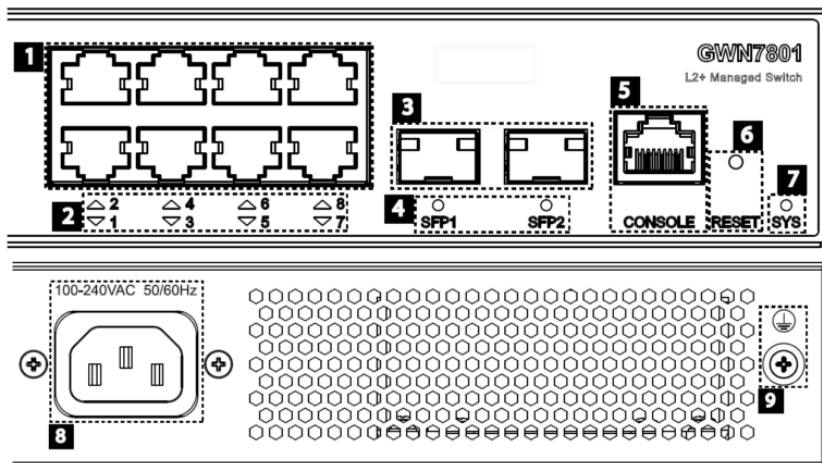

GWN7801GWN7801P Ports

No.	Port & LED	Description
1	Port 1-8	8x Ethernet RJ45 (10/100/1000Mbps), used for connecting terminals. Note: GWN7801P Ethernet ports support PoE and PoE+.
2	1-8	Ethernet ports' LED indicators
3	Port SFP1/2	2x 1000Mbps SFP ports
4	SFP 1/2	SFP ports' LED indicators
5	CONSOLE	1x Console port, used for connecting managing PC
6	RESET	Factory Reset pinhole. Press for 5 seconds to reset factory default settings
7	SYS	System LED indicator
8	100-240 VAC 50-60Hz	Power socket
9		Lightning protection grounding post

GWN7801(P) Ports and LEDs

o GWN7802/GWN7802P

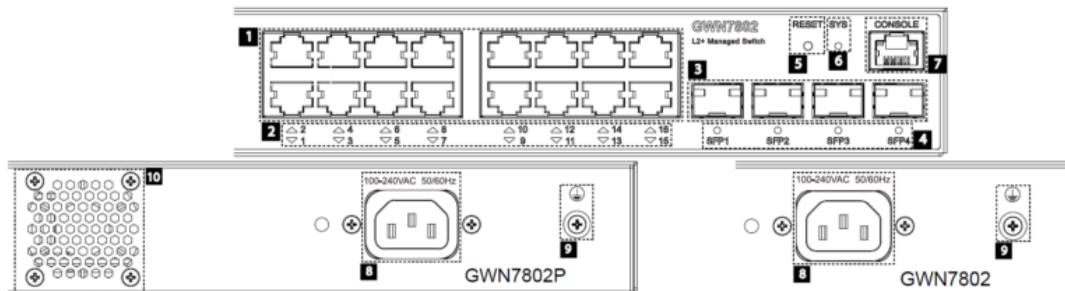

GWN7802GWN7802P Ports

No.	Port & LED	Description
-----	------------	-------------

1	Port 1-16	16x Ethernet RJ45 (10/100/1000Mbps), used for connecting terminals. Note: GWN7802P Ethernet ports support PoE and PoE+.
2	1-16	Ethernet ports' LED indicators
3	Port SFP1/2/3/4	4x 1000Mbps SFP ports
4	SFP 1/2/3/4	SFP ports' LED indicators
5	RESET	Factory Reset pinhole. Press for 5 seconds to reset factory default settings
6	SYS	System LED indicator
7	CONSOLE	1x Console port, used for connecting managing PC
8	100-240 VAC 50-60Hz	Power socket
9		Lightning protection grounding post
10	Fan	1x Fan

GWN7802(P) Ports and LEDs

o GWN7803/GWN7803P

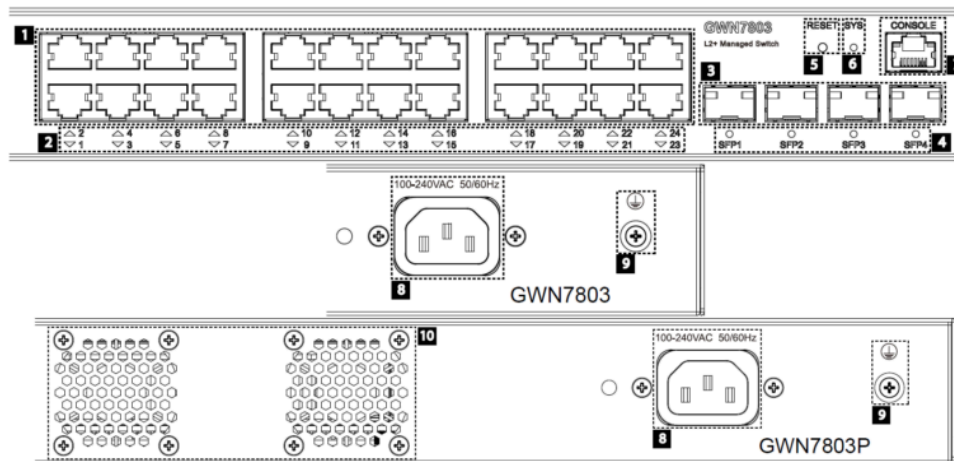

GWN7803GWN7803P Ports

No.	Port & LED	Description
1	Port 1-24	24x Ethernet RJ45 (10/100/1000Mbps), used for connecting terminals. Note: GWN7803P Ethernet ports support PoE and PoE+.
2	1-24	Ethernet ports' LED indicators
3	Port SFP1/2/3/4	4x 1000Mbps SFP ports
4	SFP 1/2/3/4	SFP ports' LED indicators
5	RESET	Factory Reset pinhole. Press for 5 seconds to reset factory default settings
6	SYS	System LED indicator

7	CONSOLE	1x Console port, used for connecting managing PC
8	100-240 VAC 50-60Hz	Power socket
9		Lightning protection grounding post
10	Fan	2x Fan

GWN7803(P) Ports and LEDs

o GWN7806(P)

Front Panel

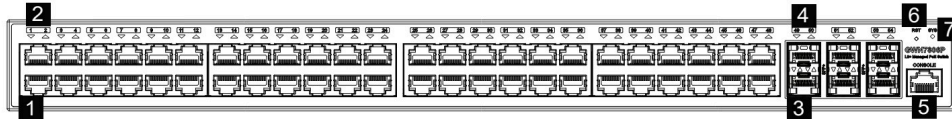

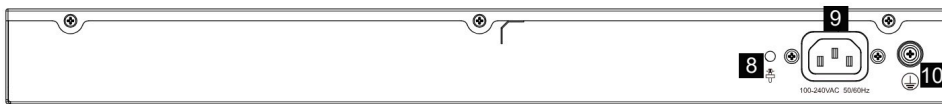

Back Panel

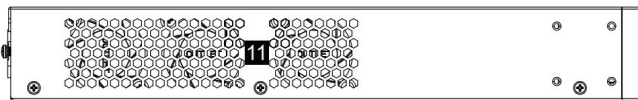

Side Panel



GWN7806P Ports

No.	Port & LED	Description
1	Port 1-48	48x Ethernet RJ45(10/100/1000Mbps), used for connecting terminals <i>Note:</i> GWN7806P Ethernet ports support PoE/PoE+
2	1-48	Ethernet ports' LED indicators
3	Port SFP+ 49-54	6x 10Gbps SFP+ ports
4	SFP+ 49-54	SFP+ ports' LED indicators
5	Console	1x Console port, used to connect a PC directly to the switch and manage it
6	RST	Factory Reset pinhole. Press for 5 seconds to reset the factory default settings
7	SYS	System LED indicator
8		Power cord anti-trip hole
9	100-240 VAC 50-60Hz	Power socket
10		Grounding terminal

11	Fan	3x Fans
----	-----	---------

GWN7806(P) Ports

o **GWN7811/GWN7811P**

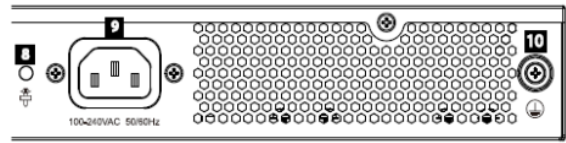
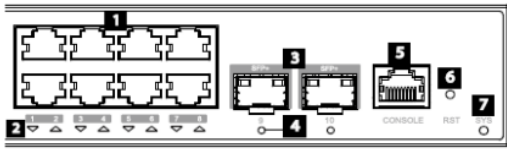

GWN7811/GWN7811P Ports

No.	Port & LED	Description
1	Port 1-8	Ethernet RJ45 (10/100/1000Mbps), used for connecting terminals. Note: GWN7811P Ethernet ports support PoE and PoE+.
2	1-8	Ethernet ports' LED indicators
3	Port 9-10	2x 10Gbps SFP+ ports
4	9-10	SFP+ ports' LED indicators
5	CONSOLE	1x Console port, used for connecting managing PC
6	RST	Factory Reset pinhole. Press for 5 seconds to reset factory default settings
7	SYS	System LED indicator
8		Power cord anti-trip hole
9	100-240VAC 50-60Hz	Power socket
10		Grounding terminal

GWN7811/GWN7811P Ports

o **GWN7812P**

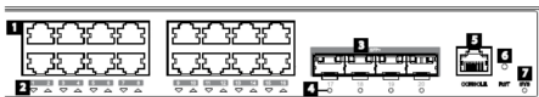

GWN7812P Ports

No.	Port & LED	Description
1	Port 1-16	Ethernet RJ45 (10/100/1000Mbps), used for connecting terminals. Note: Support PoE and PoE+.
2	1-16	Ethernet ports' LED indicators
3	Port 17-20	4x 10Gbps SFP+ ports

4	17-20	SFP+ ports' LED indicators
5	CONSOLE	1x Console port, used for connecting managing PC
6	RST	Factory Reset pinhole. Press for 5 seconds to reset factory default settings
7	SYS	System LED indicator
8		Power cord anti-trip hole
9	100-240VAC 50-60Hz	Power socket
10		Grounding terminal
11	Fan	2x Fans

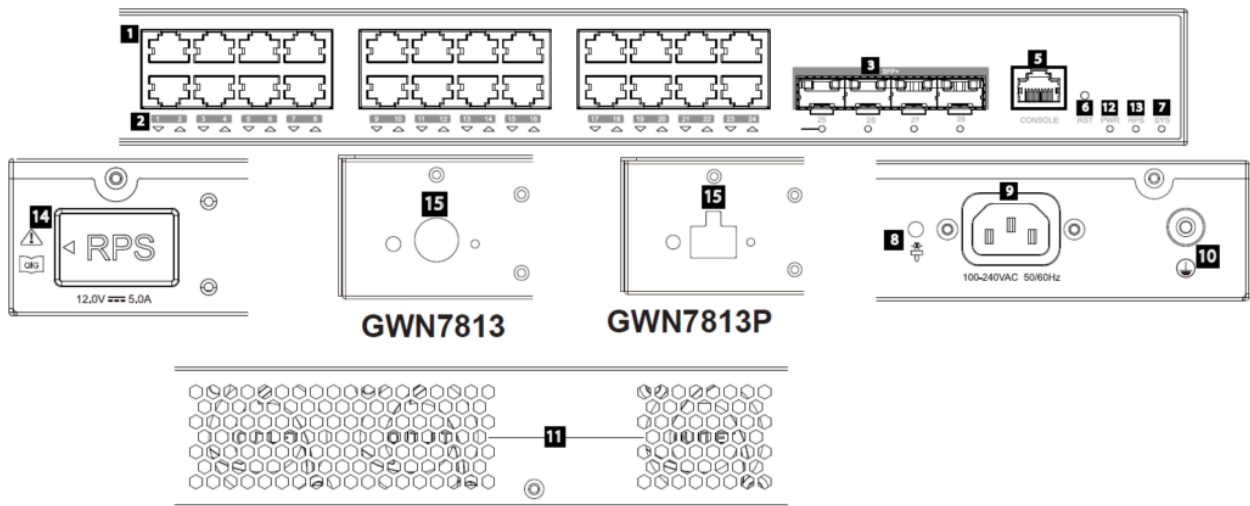

GWN7812P Ports

o GWN7813/GWN7813P



GWN7813GWN7813P Ports

No.	Port & LED	Description
1	Port 1-24	Ethernet RJ45 (10/100/1000Mbps), used for connecting terminals. Note: port 1-8 support PoE++ and port 9-24 support PoE/PoE+.
2	1-24	Ethernet ports' LED indicators
3	Port 25-28	4x 10Gbps SFP+ ports
4	25-28	SFP+ ports' LED indicators
5	CONSOLE	1x Console port, used for connecting managing PC
6	RST	Factory Reset pinhole. Press for 5 seconds to reset factory default settings

7	SYS	System LED indicator
8		Power cord anti-trip hole
9	100-240VAC 50-60Hz	Power socket
10		Grounding terminal
11	Fan	3x Fans
12	PWR	Internal power supply LED indicator
13	RPS	Secondary external power supply LED indicator
14		External power supply rubber plug
15		External RPS power outlet

GWN7813/GWN7813P Ports

o GWN7816/GWN7816P

Front Panel

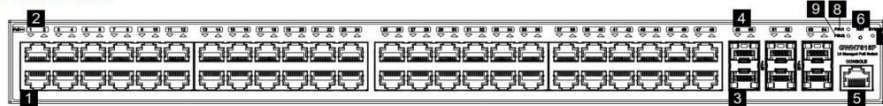

Back Panel

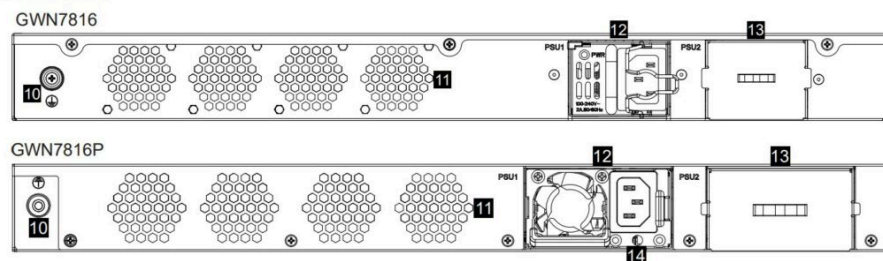

GWN7816GWN7816P Ports

No.	Port & LED	Description
1	Port 1-48	48x Ethernet RJ45 (10/100/1000Mbps), used for connecting terminals. <i>Note: GWN7816P Ethernet ports support PoE/PoE+, and port 1-8 support PoE++.</i>
2	1-48	Ethernet ports' LED indicators
3	Port 49-54	6x 10Gbps SFP+ ports
4	49-54	SFP+ ports' LED indicators
5	CONSOLE	1x Console port, used for connecting managing PC

6	RST	Factory Reset pinhole. Press for 5 seconds to reset factory default settings
7	SYS	System LED indicator
8	PSU 1	Standard hot swapping power supply unit LED indicator
9	PSU 2	Secondary hot swapping power supply unit LED indicator
10		Grounding terminal
11	Fan	4x Fans
12		Standard hot swapping power supply unit 1
13		Dummy panel of secondary hot swapping power supply unit 2, which can be removed to insert PSU2
14		Power cord anti-trip hole

GWN7816/GWN7816P Ports

o GWN7821P/GWN7822P

GWN7821P

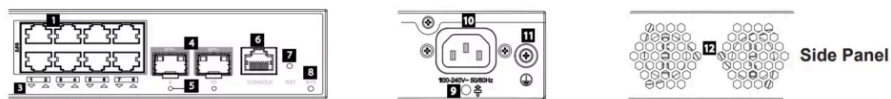



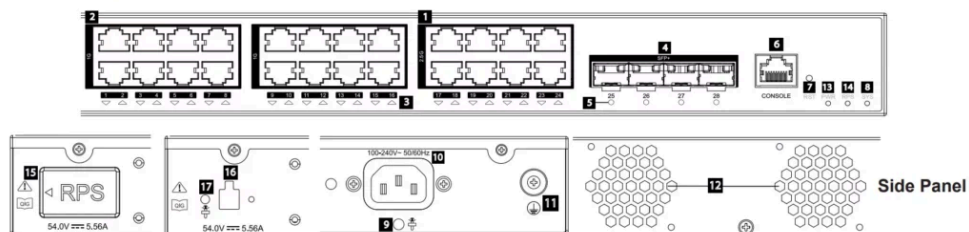

GWN7822P



GWN782x Ports

No.	Port & LED	Description
1	GWN7821P: Port 1-8 GWN7822P: Port 17-24	2.5G Ethernet RJ45, used for connecting terminals. <i>Note: 2.5G Ethernet ports support PoE++.</i>
2	GWN7822P: Port 1-16	1G Ethernet RJ45, used for connecting terminals. <i>Note: 1G Ethernet ports 1-16 support PoE+.</i>
3	GWN7821P: 1-8 GWN7822P: 1-24	Ethernet ports' LED indicators.
4	GWN7821P: Port 9-10 GWN7822P: Port 25-28	GWN7821P: 2x 10Gbps SFP+ ports. GWN7822P: 4x 10Gbps SFP+ ports.

5	GWN7821P: 9-10 GWN7822P: 25-28	SFP+ ports' LED indicators.
6	CONSOLE	1x Console port, used for connecting managing PC.
7	RST	Factory Reset pinhole. Press for 5 seconds to reset factory default settings.
8	SYS	System LED indicator.
9		Power cord anti-trip hole
10	100-240VAC 50-60Hz	Power socket.
11		Grounding terminal
12	Fan	2x Fans.
13	PWR	Internal power supply LED indicator.
14	RPS	Secondary external power supply LED indicator.
15		External power supply rubber plug
16		External RPS power outlet
17		External RPS power cord anti-trip hole

GWN782x Ports

o GWN7830

Front Panel

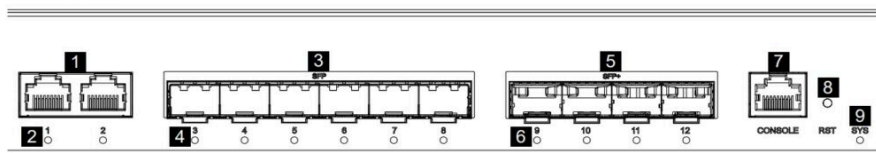

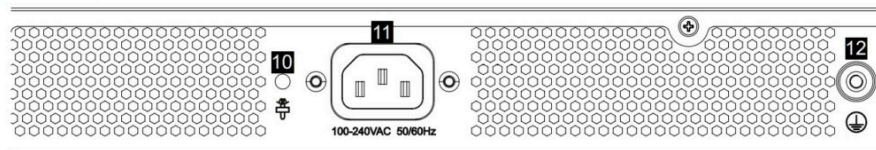

Back Panel



GWN7830 Ports

No.	Port & LED	Description
-----	------------	-------------

1	Ports 1-2	2x 10/100/1000Mbps Ethernet ports
2	1-2	Ethernet ports' LED indicators
3	Ports 3-8	6x 1Gbps SFP ports
4	3-8	SFP ports' LED indicators
5	Ports 9-12	4x 10Gbps SFP+ ports
6	9-12	SFP+ ports' LED indicators
7	Console	1x Console port, used to connect a PC directly to the switch and manage it.
8	RST	Factory Reset pinhole, press for 5 seconds to reset factory default settings
9	SYS	System LED indicator
10		Power cord anti-trip hole
11	100-240VAC 50-60Hz	Power socket
12		Grounding terminal



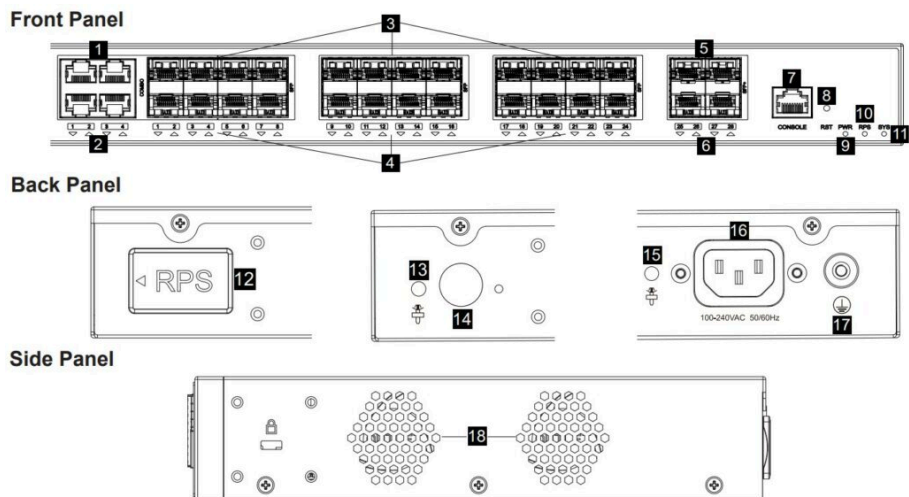

GWN7830 Ports

o GWN7831



GWN7831 Ports

No.	Port & LED	Description
1	Ports 1-4	4x 10/100/1000Mbps Ethernet ports
2	1-4	Ethernet ports' LED indicators
3	Ports 1-24	24x 1Gbps SFP ports <i>Note: SFP 1-4 and Port 1-4 combine 4 Combo ports.</i>

4	1-24	SFP ports' LED indicators
5	Ports 25-28	4x 10Gbps SFP+ ports
6	25-28	SFP+ ports' LED indicators
7	Console	1x Console port, used to connect a PC directly to the switch and manage it.
8	RST	Factory Reset pinhole, press for 5 seconds to reset factory default settings
9	PWR	Internal power supply LED indicator
10	RPS	Secondary external power supply LED indicator
11	SYS	System LED indicator
12		External power supply rubber plug
13		Power cord anti-trip hole
14		External RPS power outlet
15		Power cord anti-trip hole
16	100-240VAC 50-60Hz	Power socket
17		Grounding terminal
18	Fan	2x Fans

GWN7831 Ports

o GWN7832

Front Panel

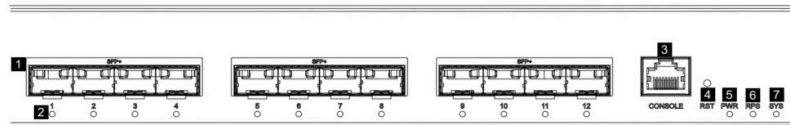



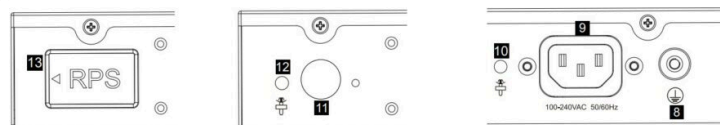

Back Panel

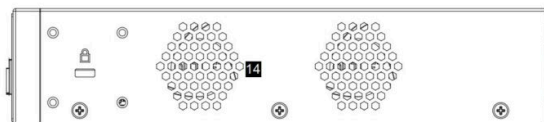

Side Panel



GWN7832 Ports

No.	Port & LED	Description
1	Ports 1-12	12x 10Gbps SFP+ ports
2	1-12	SFP+ ports' LED indicators
3	Console	1x Console port, used to connect a PC directly to the switch and manage it.
4	RST	Factory Reset pinhole, press for 5 seconds to reset factory default settings
5	PWR	Internal power supply LED indicator
6	RPS	Secondary external power supply LED indicator
7	SYS	System LED indicator
8		Grounding terminal
9	100-240VAC 50-60Hz	Power socket
10		Power cord anti-trip hole
11		External RPS power outlet
12		External RPS power cord anti-trip hole
13		External power supply rubber plug
14	Fan	2x Fans

GWN7832 Ports

Note:

External RPS (Redundant Power Supply) is sold separately.

Install on the Desktop

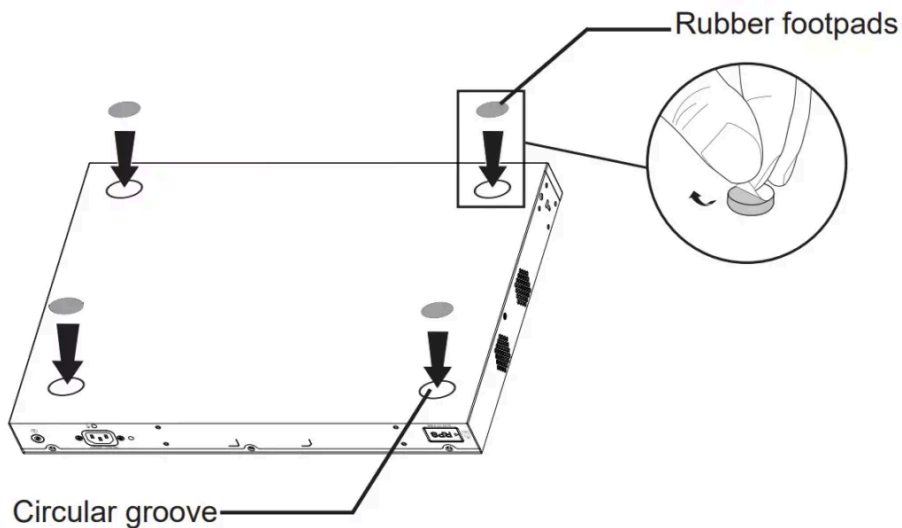

Desktop Installation

1. Place the bottom of the switch on a sufficiently large and stable table.
2. Peel off the rubber protective paper of the four footpads one by one, and stick them in the corresponding circular grooves at the four corners of the bottom of the case.
3. Flip the switch over and place it smoothly on the table.

Install on 19" Standard Rack

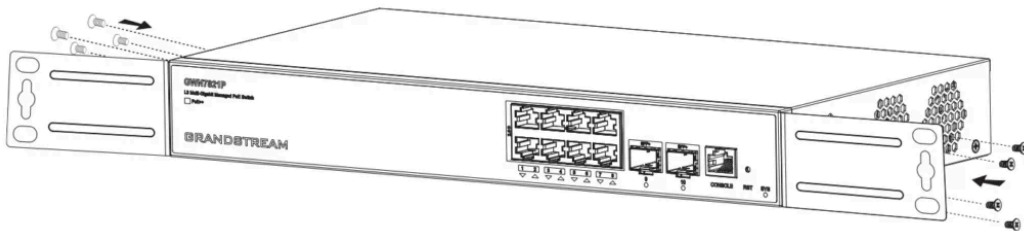

Install on 19 Standard Rack

1. Check the grounding and stability of the rack.
2. Install the two L-shaped rack-mounting in the accessories on both sides of the switch, and fix them with the screws provided (KM 3*6).

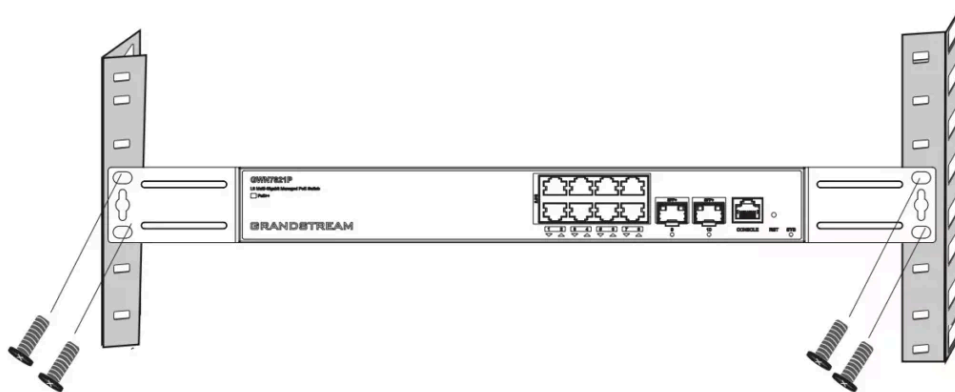

Install on 19 Standard Rack

3. Place the switch in a proper position in the rack and support it with the bracket.
4. Fix the L-shaped rack-mounting to the guide grooves at both ends of the rack with screws (prepared by yourself) to ensure that the switch is stably and horizontally installed on the rack.

Powering and Connecting GWN78xx

○ Grounding the Switch

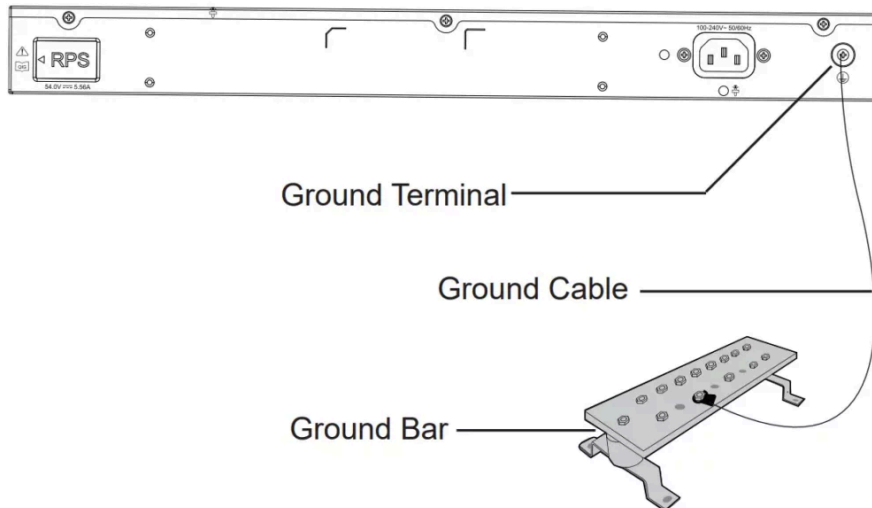

Grounding the Switch

1. Remove the ground screw from the back of the switch, and connect one end of the ground cable to the wiring terminal of the switch.
2. Put the ground screw back into the screw hole, and tighten it with a screwdriver.
3. Connect the other end of the ground cable to another device that has been grounded or directly to the terminal of the ground bar in the equipment room.

○ Powering on the Switch

Connect the power cable and the switch first, then connect the power cable to the power supply system of the equipment room.

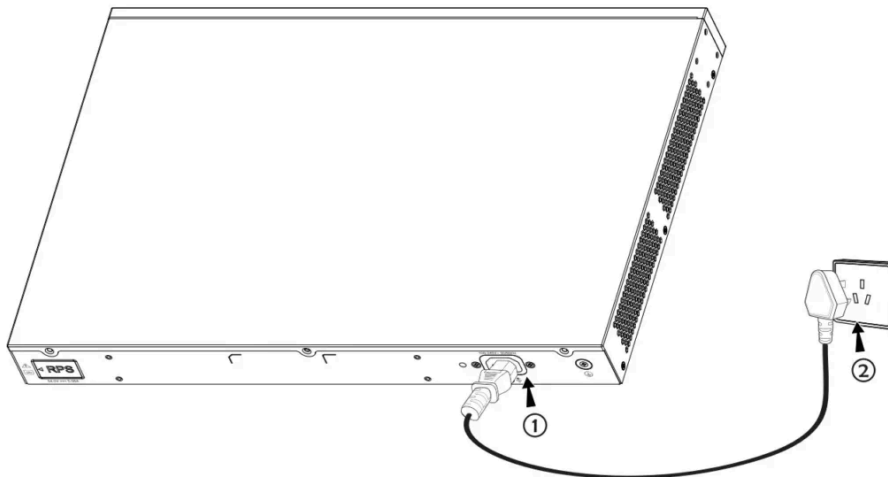

Powering on the Switch

○ Connecting Power Cord Anti-trip (Optional)

In order to protect the power supply from accidental disconnection, it's recommended to purchase a power cord anti-trip for installation.

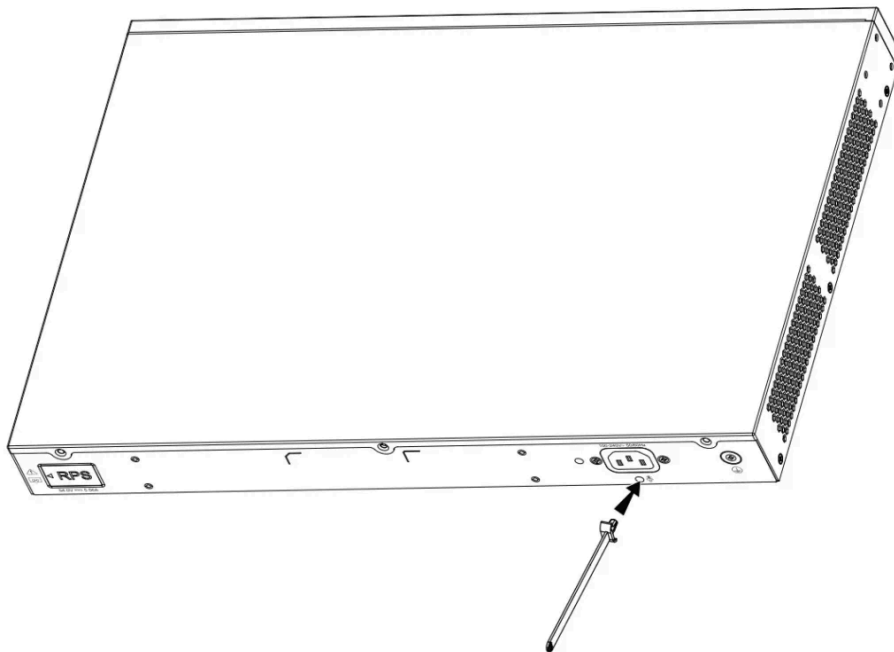

Connecting Power Cord Anti trip

1. Place the smooth side of the fixing strap towards the power outlet and insert it into the hole on the side of it.

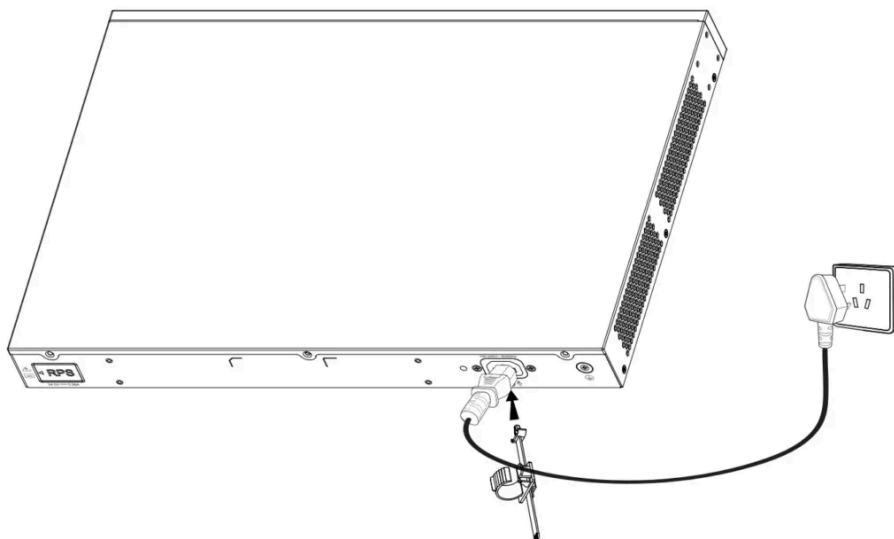

Connecting Power Cord Anti trip

2. After plugging the power cord into the power outlet, slide the protector over the remaining strap until it slides over the end of the power cord.
3. Wrap the strap of the protective cord around the power cord and lock it tightly. Fasten the straps until the power cord is securely fastened.

- **Connect to RJ45 Port**

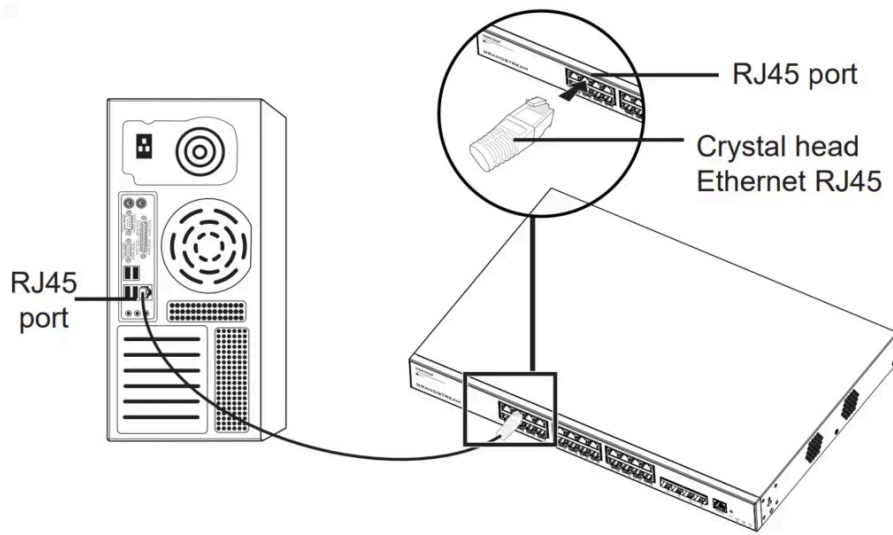

Connect to RJ45 Port

1. Connect one end of the network cable to the switch, and the other end to the peer device.
2. After powered on, check the status of the port indicator. If on, it means that the link is connected normally; if off, it means the link is disconnected, please check the cable and the peer device whether is enabled.

o **Connect to SFP+ Port**

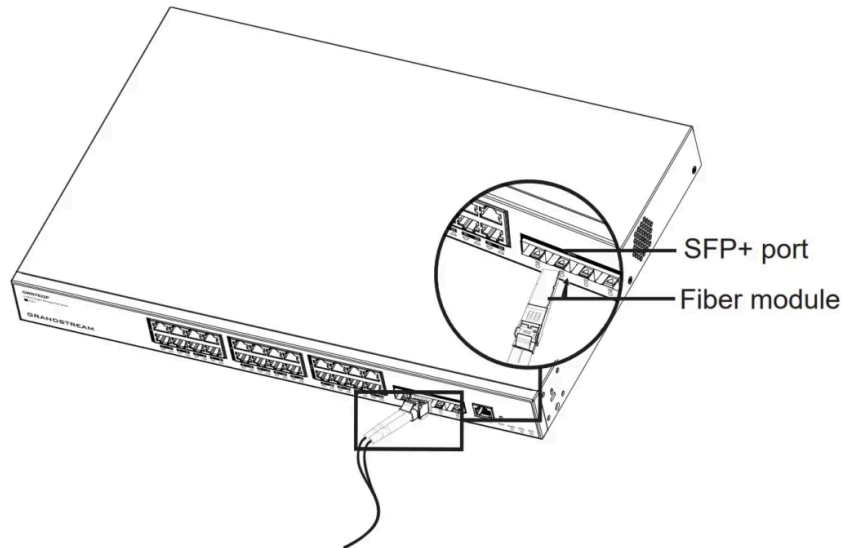

Connect to SFP+ port

The installation process of the fiber module is as follows:

1. Grasp the fiber module from the side and insert it smoothly into the switch's SFP+ port slot until the module is securely seated in close contact with the switch.
2. When connecting, ensure the correct alignment of the Rx and Tx ports of the SFP+ fiber module. Insert one end of the fiber cable into the corresponding Rx and Tx ports, and connect the other end to the corresponding ports on the other device.
3. After powering on the switch, check the status of the port indicator. If the indicator is on, the link is connected normally. If the indicator is off, the link is disconnected. Please check the cable and verify whether the peer device is enabled.

Notes:

Please select the optical fiber cable according to the module type: The multi-mode module corresponds to the multi-mode optical fiber. The single-mode module corresponds to the single-mode optical fiber. Ensure the optical fiber cable has the same wavelength for connection. Select an appropriate optical module based on the actual networking requirements to meet various transmission distance needs.

Warning: The laser in first-class laser products is harmful to the eyes. Do not look directly at the optical fiber connector.

o **Connect to the Console Port**

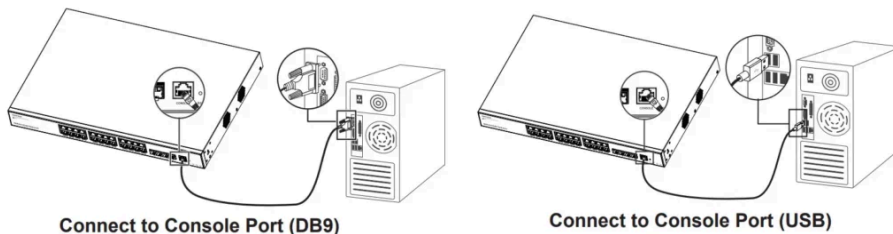

Connect to the Console Port

1. Connect the RJ45 end of the console cable to the console port of the switch.
2. Connect the other end of the console cable to the DB9 male connector or USB port to the PC.

Safety Compliances

The GWN78xx Network Switch complies with FCC/CE and various safety standards. The GWN78xx power adapter is compliant with the UL standard. Use the universal power adapter provided with the GWN78xx package only. The manufacturer’s warranty does not cover damages to the device caused by unsupported power adapters.

Warranty

If GWN78xx Network Switch was purchased from a reseller, please contact the company where the device was purchased for replacement, repair or refund. If the device was purchased directly from Grandstream, contact our Technical Support Team for an RMA (Return Materials Authorization) number before the product is returned. Grandstream reserves the right to remedy the warranty policy without prior notification.

GETTING STARTED

LED Indicators

The front panel of the GWN78xx has LED indicators for power and interface activities, the table below describes the LED indicators’ status.

LED Indicator	Status	Description
System Indicator	Off	Power off
	Solid green	Booting
	Flashing green	Upgrade
	Solid blue	Normal use
	Flashing blue	Provisioning
	Solid red	Upgrade failed
	Flashing red	Factory reset
Port Indicator	Off	<ul style="list-style-type: none"> • For all ports: port off • For SFP/SFP+ ports: port failure
	Solid green	Port connected and there is no activity
	Flashing green	Port connected and data is transferring
	Solid yellow	Ethernet port connected, and there is no activity and PoE powered

	Flashing yellow	Ethernet port connected, data is transferring and PoE powered
	Alternately flashing yellow and green	Ethernet port failure
PWR/RPS Indicator	Off	Uninserted or failure
	Solid Green	<ul style="list-style-type: none"> ○ In use ○ Inserted but not used (only for RPS)

LED Indicators

Note

During the boot sequence, the LED indicator transitions through multiple color states

Access & Configure

Note

If no DHCP server is available, the GWN78xx default IP address is 192.168.0.254.

Login Using the Console Port

1. Use the console cable to connect the console port of switch and the serial port of PC.
2. Open the terminal emulation program of PC (e.g. SecureCRT), enter the default username and password to login. (The default administrator username is "admin" and the default random password can be found at the sticker on the GWN78xx switch).

Note

The baud rate needs to be set to 115200.

Login Remotely Using SSH

1. Enter "**cmd**" in PC/Start.
2. Enter **ssh <gwn78xx_IP>** in the cmd window.
3. Enter the default username and password to login. (The default administrator username is "admin" and the default random password can be found at the sticker on the GWN78xx switch).

Note:

Supports SSH and TELNET in #Mode (EXEC mode).

GWN Switches support also [Web CLI](#).

Configure Using GDMS Networking

Type <https://www.gdms.cloud> in the browser, and enter the account and password to login the cloud platform. If you don't have an account, please register first or ask the administrator to assign one for you.

Login Using the Web UI

The GWN78xx embedded Web server responds to HTTPS GET/POST requests. Embedded HTML pages allow users to configure the device through a Web browser such as Microsoft Edge, Mozilla Firefox, or Google Chrome.

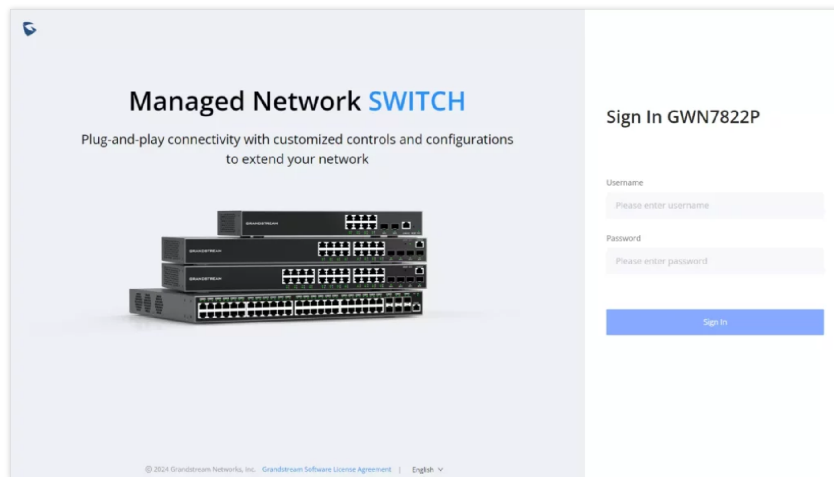

Login Using the Web UI

1. A PC uses a network cable to correctly connect any RJ45 port of the switch.
2. Set the Ethernet (or local connection) IP address of the PC to 192.168.0.x ("x" is any value between 1-253), and the subnet mask to 255.255.255.0, so that it is in the same network segment with switch IP address. If DHCP is used, this step could be skipped.
3. Type the switch's default management IP address **https://<GWN78xx_IP>** in the browser, and enter the username and password to log in. (The default administrator username is "admin" and the default random password can be found at the sticker on the GWN78xx switch).

CLI Access

In addition to the web-based configuration, the GWN78xx series can also be configured using a Command Line Interface (CLI). For detailed instructions on using the CLI, please refer to the [GWN78xx CLI User Guide](#).

Web GUI Languages

The GWN78xx web GUI supports many languages including **English, Simplified Chinese, Spanish, French** etc.

To change the default language, select the displayed language at the bottom of the web GUI either before or after logging in.

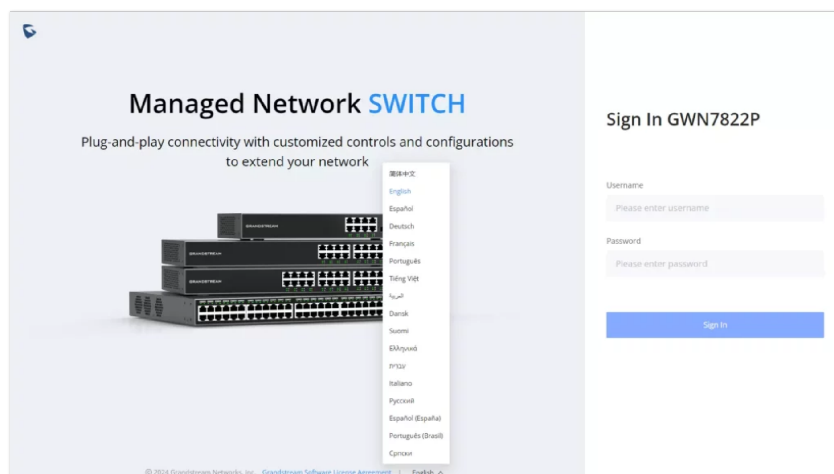

Web GUI Languages Login Page

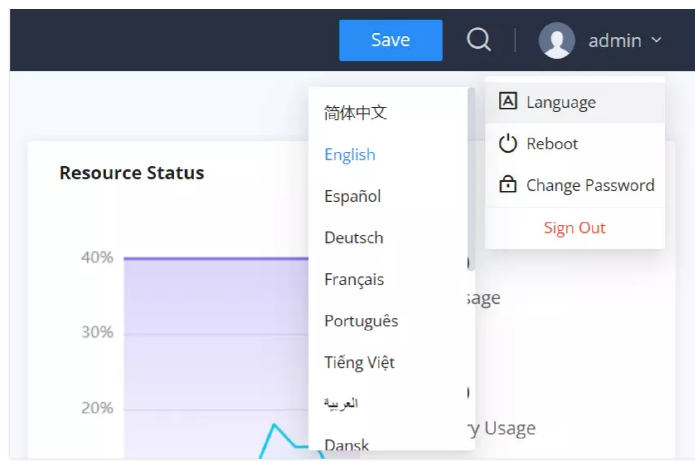

WEB GUI Start page

Note:

When the Web GUI language is manually changed from the login page or within the interface, the selected language will be saved in the device's configuration. This preference will persist across sessions, reboots, and browsers, regardless of the system's regional or browser settings.

Search

In case it's hard to go through every single section, GWN78xx Switches have search functionality to help the user find the right configuration, settings or parameters, etc.

On the top of the page, there is a search icon, the user can click on it and then enter the keyword relevant to his search, then he will get all the possible locations of that keyword.

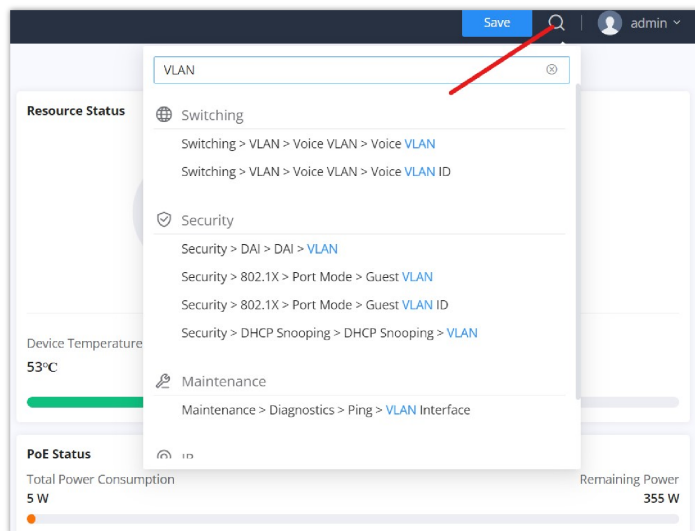

Search part 1

It's also possible to search through menus and sub-menus, and once the user clicks on the search result, they will jump directly to the specified page, please see the figure below:

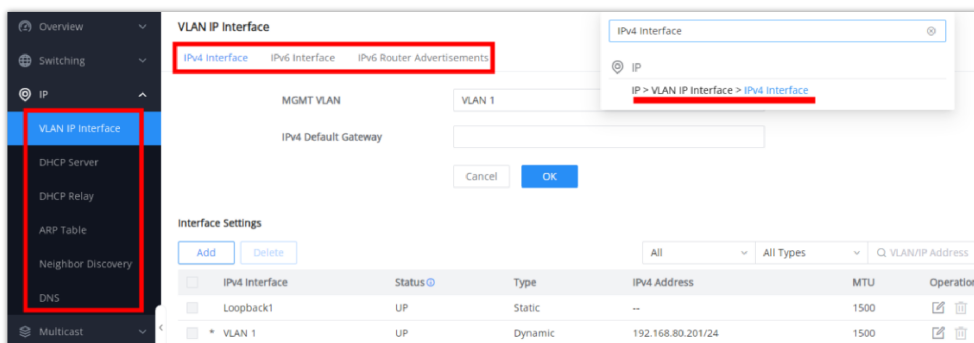

Search part 2

OVERVIEW

Overview is the first section that displays System information in the first page “**System Info**” and Port status on the second page “**Port Info**”. This section provides the user with a general and global view about the GWN78xx system and ports status for easy monitoring.

System Info

System Info is the first page after a successful login to the GWN78xx Web Interface. It provides an overall view of the GWN78xx Switch information presented in a Dashboard style for easy monitoring including basic info, Resources Status, PoE Status and System Events.

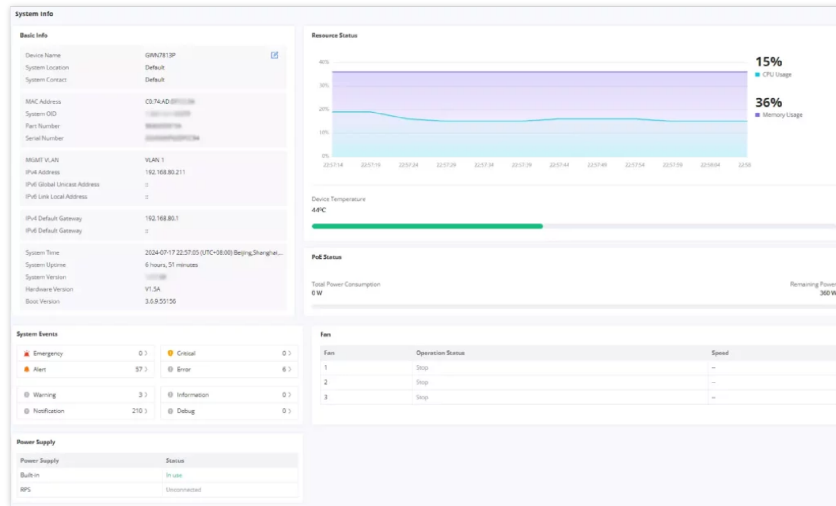

System Info page

To name the device please click on , then enter the desired name.

Basic Info	Displays Device and System general information that includes (Device name, MAC Address, Default Gateway, System Time, System Version etc.)
Resource Status	Displays in real time the usage of CPU and Memory.
PoE Status	Shows the Total Power Consumption and the remaining Power in mA.
System Events	Displays the total number of events for each category (Emergency, Alert, Warning etc). <i>Note: Clicking on any events category will redirect you to the Diagnostics page for further details.</i>
Fan	Displays the fans operation status and speed.
Power Supply	Shows the status of the built-in power supply as well as the RPS (Redundant Power Supply).

System Info page

Port Info

This page on the GWN switches provides comprehensive port statistics, PoE power supply information, and detailed port and neighbor information. It helps users monitor network performance and manage connected devices efficiently.

- o **Port Info**

The “Port Info” section visually displays the status and speed of each port, using different colors for speeds and states. Users can quickly identify active, inactive, or problematic ports and their PoE power status.

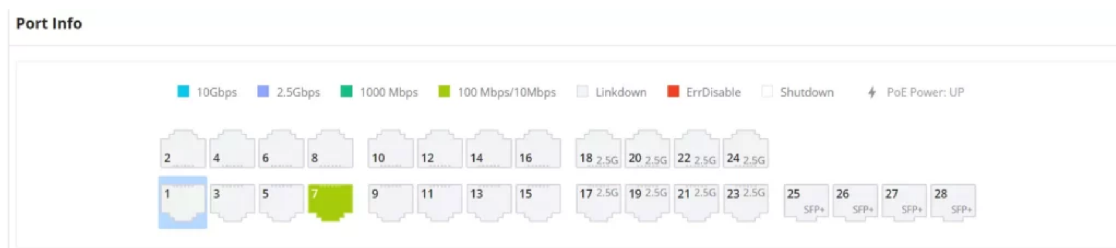

Port Info page 1

o **Basic Info and Neighbor Info**

The "Basic Info" section shows specific details for a selected port, including its status and settings. The "Neighbor Info" section provides information about the device connected to the port, such as hostname and current traffic rates.

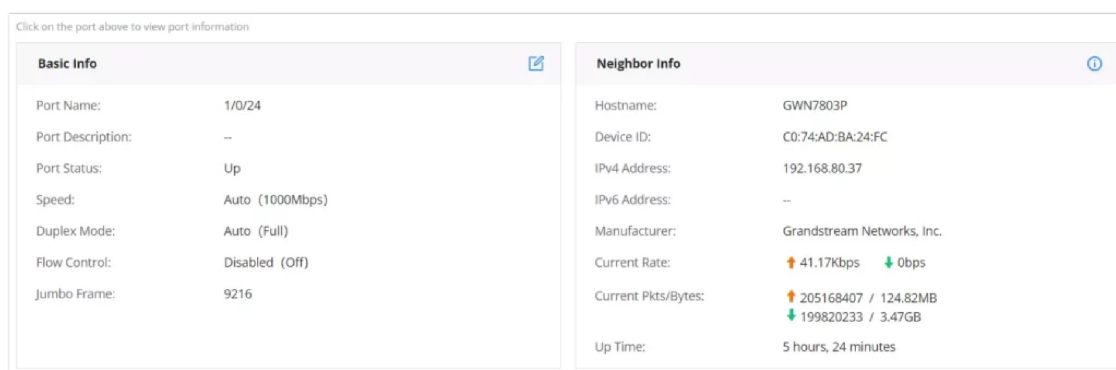

Port Info page 2

o **Statistics**

The "Statistics" section offers detailed metrics on network traffic through the switch. It includes data on octets, packets, and discards, which is crucial for monitoring performance and troubleshooting.

o **PoE Power Supply / Fiber Info**

If the selected port is PoE-capable, the "PoE Power Supply" section shows power supply status and usage. If the port is SFP, the "Fiber Info" section displays details like signal loss, temperature, RX, and TX power.

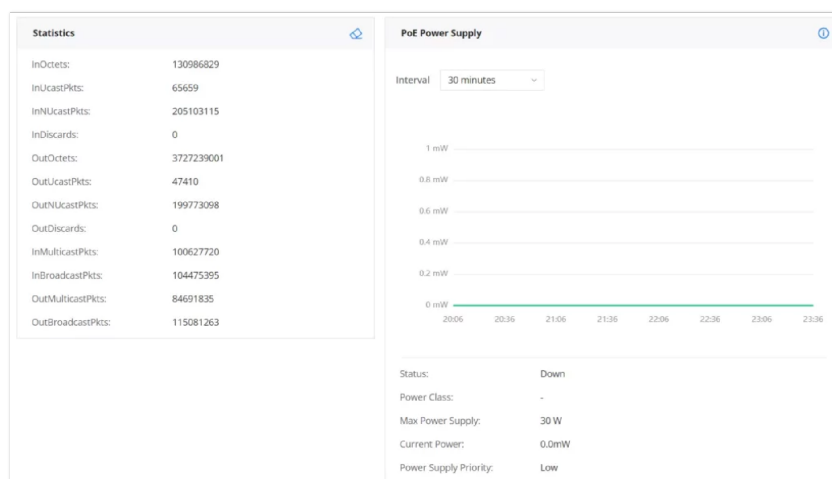

Port Info page 3

The following table explains the color mode and the symbols used:

	Grey: Linkdown
	White: shutdown

	Green: Ethernet RJ45 port with 1000 Mbps speed
	Light green: Ethernet RJ45 port with 100 Mbps/10 Mbps speed
	Red: ErrDisable
	Green: SFP/SFP+ Port set to 1000Mbps
	Purple: SFP Port set to 2.5Gbps
	Blue: SFP+ port set to 10Gbps
	Symbol: PoE Power is enabled.

Port Info

Note: a PoE symbol and color code combination is also possible. Ex:  in this case, the port is using 1000 Mbps speed and also using PoE at the same time.

Icons Description:

- **Basic Info:** The edit icon forwards users to the Port Basic Settings page, where they can modify the port settings such as Description, Speed, Duplex Mode, and Flow Control, or enable/disable the port.
- **Neighbor Info:** The details icon forwards users to the LLDP/LLDP-MED Neighbor Info page. Here, users can view additional information about the connected devices, including chassis ID, port ID, device name, system description, and survival time.
- **PoE Power Supply / Fiber Info:** The details icon forwards users to the respective detailed pages. For PoE, it forwards to the PoE Interface page showing detailed information about PoE settings for each port. For Fiber, it forwards to the Fiber Module page, displaying comprehensive fiber details such as signal loss, temperature, RX, and TX power.
- **Statistics:** The clear icon clears the displayed statistics.

SWITCHING

Switching section is used to configure ports settings, link Aggregation, VLAN, Spanning Tree etc.

Port Basic Settings

On this page, you can configure the basic parameters for GWN78xx Switch ports, like disabling or enabling the port, adding Description, specifying the speed by default is Auto, Duplex Mode, and Flow Control. There is also a filter on in case you want to edit only the Copper ports which are the Gigabit Ethernet ports or Fiber ports which are the SFP+ ports.

To configure a port, please navigate to **Web UI** → **Switching** → **Port Basic Settings**.

Port Basic Settings						
Port	Port Type	Description	Status	Link Status	Speed	
1/0/1	Copper	GWN76xx	Enabled	Down	Auto	
1/0/2	Copper	Guests	Enabled	Down	Auto	
1/0/3	Copper	--	Enabled	Down	Auto	
1/0/4	Copper	--	Enabled	Down	Auto	
1/0/5	Copper	--	Enabled	Down	Auto	
1/0/6	Copper	--	Enabled	Down	Auto	
1/0/7	Copper	--	Enabled	Down	Auto	
1/0/8	Copper	--	Enabled	Down	Auto	
1/0/9	Copper	--	Enabled	Down	Auto	

Port Basic Settings

To configure a port, click on the "Edit" icon under the operation column.

Port Basic Settings > Edit Port

Port: 1/0/28

Port Type: SFP+

Description: 0-128 characters

Port Enable: Enable Disabled

Scheduled enabled:

Auto Detect:

Speed:

DAC Cable:

Duplex Mode: Full

Jumbo Frame: Valid range is 1518-10000

Flow Control: Disabled Enabled
Flow Control setting will not take effect if Duplex Mode is set to "Half".

Port Basic Settings Edit port

Users can define schedules for specific ports, this is to enable precise control over when configurations are applied. These schedules dictate the exact times during which port settings will take effect.

Port Basic Settings > Edit Port

Port: 1/0/2

Port Type: Copper

Description: 0-128 characters

Port Enable: Enable Disabled

Scheduled enabled:

Speed:

Duplex Mode:

Jumbo Frame: Valid range is 1518-12288

Flow Control: Disabled Enabled Auto
Flow Control setting will not take effect if Duplex Mode is set to "Half".

Port Basic Settings scheduled enabled

Port	The selected Port to be configured, it can be either Gigabit Ethernet port or SFP port.
Port Type	Displays the Port Type (Copper or SFP).

Description	It is used to configure the information description of this interface , which can be a description of usage, etc., with a maximum of 128 characters, and the characters limited to input are numbers 0-9 , letters az / AZ and special characters.
Port Enable	Set whether to enable the interface. <i>it is enabled by default.</i>
Scheduled enabled	From the drop-down list, select the schedule for when the port (including physical and LAG ports) will be enabled.
Speed	Set the rate of the interface: <ul style="list-style-type: none"> • Ethernet port (Copper): the options are {Auto, 10Mbps, 100Mbps, 1000Mbps}, The default is auto-negotiation. • SFP/SFP+ port: the options are: <ul style="list-style-type: none"> • GWN7801P Pro 2.5G SFP: 100Mbps, 1000Mbps, 2.5Gbps. Default: 2.5Gbps • GWN7802P Pro/GWN7803(PL/PH) Pro SFP+: 100Mbps, 1000Mbps, 2.5Gbps, 10Gbps. Default: 10Gbps • GWN7806PL/PH Pro SFP+: 100Mbps, 1000Mbps, 10Gbps. Default: 10Gbps Notes: <ul style="list-style-type: none"> • <i>When set to Auto, the rate of the interface is automatically negotiated between the interface and the peer port .</i> • <i>When configuring a fixed speed, ensure the peer port is set to the same value. Otherwise, the port may not function properly.</i>
Duplex Mode	Set the duplex mode of the interface. The GE ports options are { auto-negotiation, full-duplex, half-duplex}. The default is auto-negotiation. <ul style="list-style-type: none"> • Auto-negotiation: The duplex state of an interface is determined by the auto-negotiation between the interface and the peer port. • Duplex: the interface send and receive data packets. • Half-duplex: interface can only send/ receive packets. Notes: <ul style="list-style-type: none"> • <i>Optical ports only support full-duplex mode.</i> • <i>When setting Duplex Mode manually (Duplex or Half-duplex), ensure the same mode is configured on the peer port. Otherwise, the port may not work normally.</i>
Jumbo Frame	Specify the Jumbo Frame, the valid range is 1518-12288. Default is 9216
Flow Control	Set the flow control on the interface, the options are {Disabled, Enabled, Auto}. <i>The default is Disabled.</i> After enabling it, if the local device is congested, it will send a message to the peer device to notify the peer device to temporarily stop sending packets, after receiving the message, the peer device will temporarily stop sending packets to the local and vice versa. Thus, the occurrence of packet loss is avoided. Note: <i>The optical port does not support auto-negotiation mode.</i>

Port Basic Settings – Edit port

Port Group

The port group feature allows administrators to logically bundle specific ports together under one group with a corresponding group ID, this can be useful when classifying the switch ports for identifying the usage of each set of ports, for example, ports 1 to 8 can be set with ID 20, these will be the ports connecting Security devices.

Port group settings can facilitate quick batch settings for port group ports.

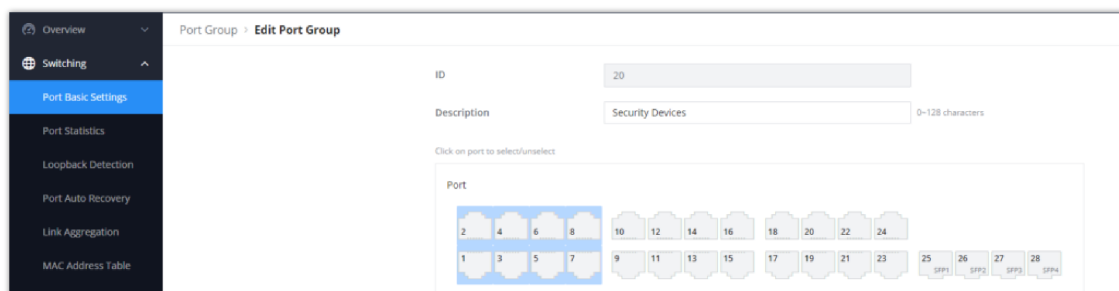

Port Group

Once the Port Group is created, it can ease up the process of selecting and tagging/untagging VLAN ports individually, Under **Switching** → **VLAN**, select the port group to be used for your VLAN

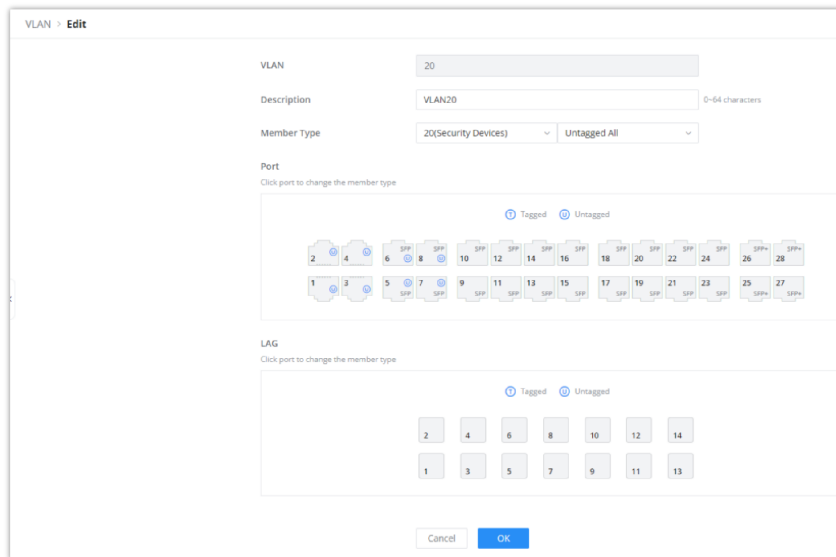

Port Group Selection

In addition, users can disable/enable specific ports based on the port group created, instead of going through each individual port selection separately:

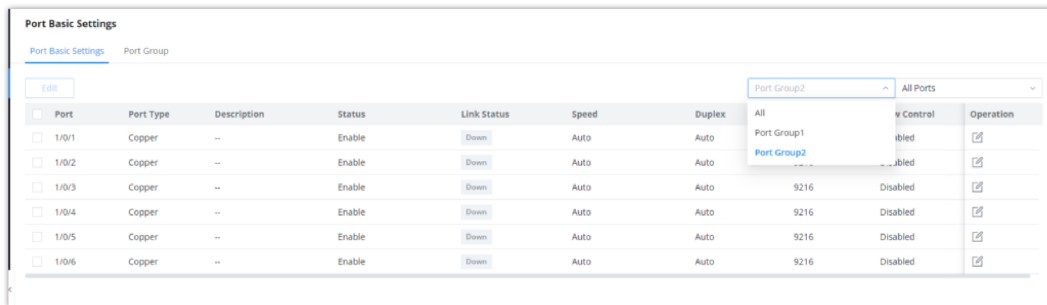

Delete Port Group

Port Statistics

For monitoring or even sometimes troubleshooting, the Port Statistics displays in real time the flow of data with different units like Octets, Packets, Transmission Rate, and OutErrPackets. The option to clear all the statistics or a specific port is supported as well.



Port Statistics part 1

To view even more details like Etherlike (SNMP), RMON, and port Private MIB information.

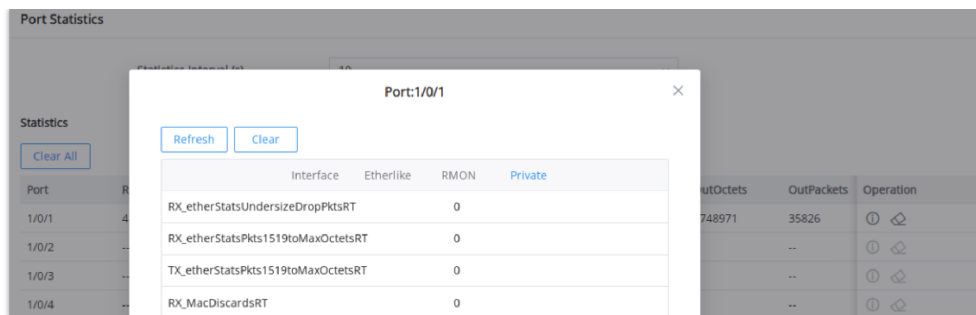

Port Statistics part 2

Loopback Detection

By enabling the loop detection function of the interface, the interface periodically sends detection packets to check whether the packets are returned to the device, and then determines whether there is a loop in the device. If a loop is detected, the port is automatically shut down to eliminate the loop and ensure the normal operation of the network environment.

Note:

Interface Loopback Detection is not effective. If STP is enabled, because STP protection overrides interface Loopback Detection.

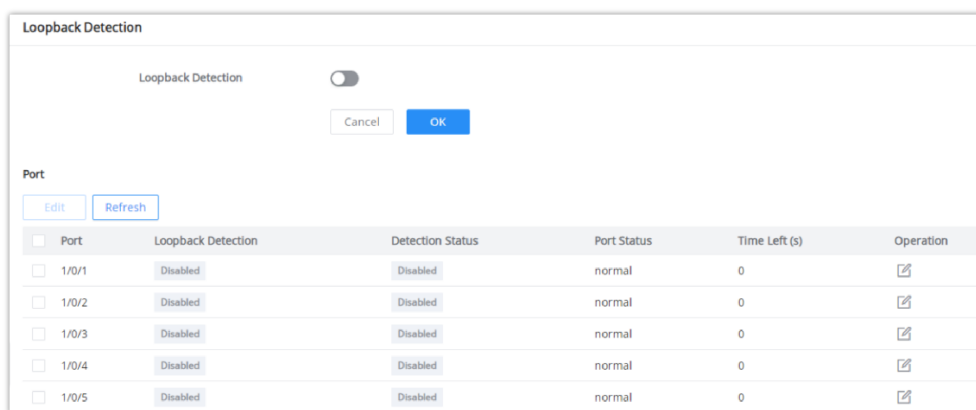

Loopback Detection

Port Auto Recovery

Port Auto Recovery helps recover a port after a specific delay that can be specified by the user. When the following functions of the port trigger the port down, the port automatically returns to the up state after the delay time:

Examples:

- **ARP packet detection:** If the ARP rate in DAI exceeds the set value, the current port will be shut down.
- **STP BPDU Guard:** In spanning tree, the port enables BPDU Guard. When this function is triggered, the port will be shut down.
- **Port Loop:** When the port is self-looping and spanning tree is enabled, the port will be shut down.
- **ACL:** When the ACL rule is matched and the action is shutdown, the port will be shut down.
- **Port Security:** When the number of port MAC addresses exceeds the set number, the port will be shut down.

Note

When the recovery time is up and the port is back up, if the condition that triggers the down occurs again, the port will be shut down again.

Port Auto Recovery

Recovery Items

- All
- ARP Packet Detection
- DHCP Rate Limit
- Unicast Storm Control
- Port Loop
- Port Security
- STP BPDU Guard
- Broadcast Storm Control
- Unknown Multicast Storm Control
- ACL

Delay Time (s): Valid range is 30-86400.

Port

Port	ErrDisable Reason	Time Left (s)	Operation
1/0/1	--	0	
1/0/2	--	0	
1/0/3	--	0	

Port Auto Recovery

Link Aggregation

LAG means Link Aggregation Group which groups some physical ports together to make a single high-bandwidth data path. Thus it can implement traffic load sharing among the member ports in a group to enhance the connection reliability.

Link Aggregation Group

There are two load balance modes on the GWN78xx Switches, either based on the MAC Address or based on the IP – MAC Address. And in terms of the type of LAG, there are either the static option or to use the LACP or Link Aggregation Control Protocol both of them are supported.

Link Aggregation

Group | LAG Settings | LACP

Load Balance Mode:

LAG	Description	Type	Link Status	Active Member	Inactive Member	Operation
LAG1	--	Static	Down	--	--	
LAG2	--	Static	Down	--	--	
LAG3	--	Static	Down	--	--	
LAG4	--	Static	Down	--	--	
LAG5	--	Static	Down	--	--	
LAG6	--	Static	Down	--	--	

Link Aggregation Group

Load Balancing Mode	<p>Select your Load balance mode.</p> <p>MAC address – Aggregated group will balance the traffic based on different MAC addresses. Therefore, the packets from different MAC addresses will be sent to different links.</p> <p>IP/Mac Address – Aggregated group will balance the traffic based on MAC addresses and IP addresses. Therefore, the packets from same MAC addresses but different IP addresses will be sent to different links.</p>
Edit Group	<p>Name: Enter the name of the LA Group.</p> <p>Type: Use the drop down menu to specify the type for LAG.</p> <ul style="list-style-type: none"> ● Static– The static aggregated port sends packets over active member without detecting or negotiating with remote aggregated port. ● LACP– The LACP aggregated ports place member into active only after negotiated with remote aggregated port for best reliability. <p>GE: Click on port to check / uncheck which ones will be part of this LAG.</p>

LAG Port Settings

On this page, the user can Enable the Link Aggregation Group and add a Description as well as specify the speed and the flow control for LAG.

Port	Description	Status	Link Status	Speed	Jumbo Frame	Flow Control	Operation
<input checked="" type="checkbox"/> LAG1	--	Enable	Down	1000Mbps	9216	Disabled	
<input type="checkbox"/> LAG2	--	Enable	Down	1000Mbps	9216	Disabled	
<input type="checkbox"/> LAG3	--	Enable	Down	1000Mbps	9216	Disabled	
<input type="checkbox"/> LAG4	--	Enable	Down	1000Mbps	9216	Disabled	
<input type="checkbox"/> LAG5	--	Enable	Down	1000Mbps	9216	Disabled	
<input type="checkbox"/> LAG6	--	Enable	Down	1000Mbps	9216	Disabled	

Link Aggregation Port Settings

Port	The selected LAG to be configured.
Description	It is used to configure the information description for this LAG , which can be a description of usage, etc., with a maximum of 128 characters, and the characters limited to input are numbers 0-9 , letters az / AZ and special characters.
Port Enable	Set whether to enable the interface. <i>it is enabled by default.</i>
Speed	Set the rate of the interface, the options are {Auto, 10Mbps, 100Mbps, 1000Mbps}. <i>The default is auto-negotiation.</i> Note: <i>When set to Auto, the rate of the interface is automatically negotiated between the interface and the peer port</i>
Jumbo Frame	Specify the jumbo frame, valid range is 1518-12288. Default value is 9216
Flow Control	Set the flow control on the interface, the options are { Disabled, Enabled, Auto}. <i>The default is Disabled</i> After enabling it, if the local device is congested, it will send a message to the peer device to notify the peer device to temporarily stop sending packets, after receiving the message, the peer device will temporarily stop sending packets to the local and vice versa. Thus, the occurrence of packet loss is avoided.

Link Aggregation Settings

LACP

LACP or Link Aggregation Control Protocol is based on the priority, and the user can enable a system priority or even specify the priority for each port individually.

Port	Port Priority	Timeout	Operation
<input type="checkbox"/> 1/0/1	1	Long	
<input type="checkbox"/> 1/0/2	22	Long	
<input type="checkbox"/> 1/0/3	1	Long	
<input type="checkbox"/> 1/0/4	1	Long	
<input type="checkbox"/> 1/0/5	65	Long	
<input type="checkbox"/> 1/0/6	1	Long	
<input type="checkbox"/> 1/0/7	1	Long	

System Priority	Set the system priority of LACP, the value range is an integer from 1-65535, <i>the default is 32768.</i>
Edit LACP	<p>Port: Select the switch LAG interface to be configured</p> <p>Port Priority:Set the LACP protocol priority of the port , the value range is an integer from 1 to 65535 , <i>the default is 1.</i></p> <p>Note: <i>The smaller the priority value of the port , the higher the LACP priority of the port.</i></p> <p>Timeout: Set the timeout time for receiving LACP packets, the options are { Short, Long} , <i>the default is Short.</i></p> <ul style="list-style-type: none"> ● Short mode: the default timeout period for receiving LACP protocol packets is 3 seconds. ● Long mode: the default timeout period for receiving LACP protocol packets is 90 seconds .

Link Aggregation – LACP

MAC Address Table

The MAC address table records the correspondence between the MAC addresses of other devices learned by the switch and the interfaces, as well as information such as the VLANs to which the interfaces belong. When forwarding a packet, the device queries the MAC address table according to the destination MAC address of the packet. If the MAC address table contains an entry corresponding to the destination MAC address of the packet, it directly forwards the packet through the outbound interface in the entry. If the MAC address table does not contain an entry corresponding to the destination MAC address of the packet , the device will use broadcast mode to forward the packet on all interfaces in the VLAN to which it belongs except the receiving interface.

The entries in the MAC address table are divided into **Dynamic Address**, **Static MAC Address**, **Black hole Address** and **Port Security Address**.

Dynamic Address

the MAC address table is established based on the automatic learning of the source MAC address in the data frame received by the device. If the MAC address entry does not exist in the MAC address table, the device adds the new MAC address and the interface and VLAN corresponding to the MAC address as a new entry into the MAC address table. GWN78xx Switch will update the entry by resetting the aging time.

Aging Time:

Dynamic MAC address entries are not always valid . Each entry has a lifetime. The entries that cannot be updated after reaching the lifetime will be deleted. This lifetime is called the Aging Time. If the record is updated before reaching the lifetime, the aging time of the entry will be recalculated.

Notes

- The value range is 0 or 60-1 000000, **the default is 300**. If it is set to 0, it means that dynamic MAC address entries will not be aged
- Dynamic table entries are lost after system restart.

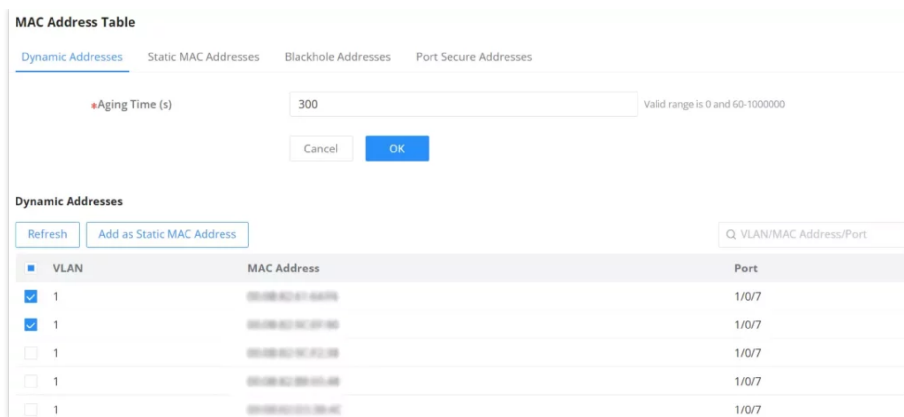

Dynamic MAC Address Table

Click on the **“Refresh”** button to update the table, or click on the **“Add Static MAC Address”** button to add the entry to the static MAC address.

Static MAC Address

This section allows the user to manually assign a MAC address to the MAC table. The configuration result will be displayed on the table listed on the lower side of this web page.

Note

The static MAC address must be unicast.

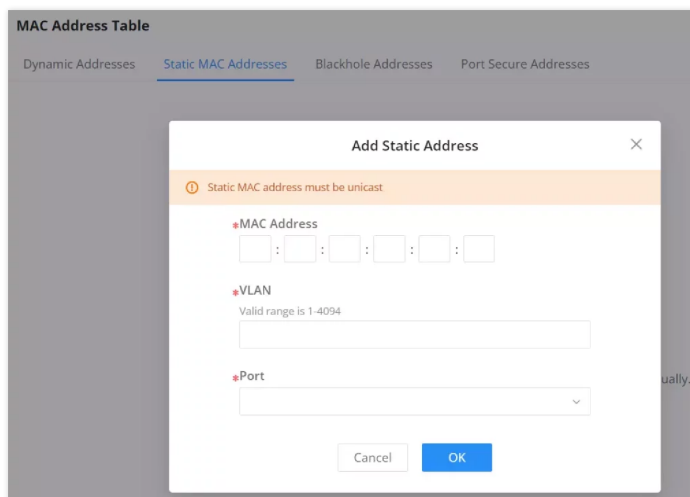

Static MAC Address

MAC Address	Enter the MAC address that will be forwarded
VLAN	This is the VLAN group to which the MAC address belongs.
Port	Select the port where received frame of matched destination MAC address will be forwarded to.

Static MAC Address

Black Hole Address

If a MAC address is not trusted or insecure, The user can block the traffic of certain MAC Addresses and discard them by adding them to the Black Hole Address Table.

Click on the **“Add”** button then enter the MAC Address and the VLAN.

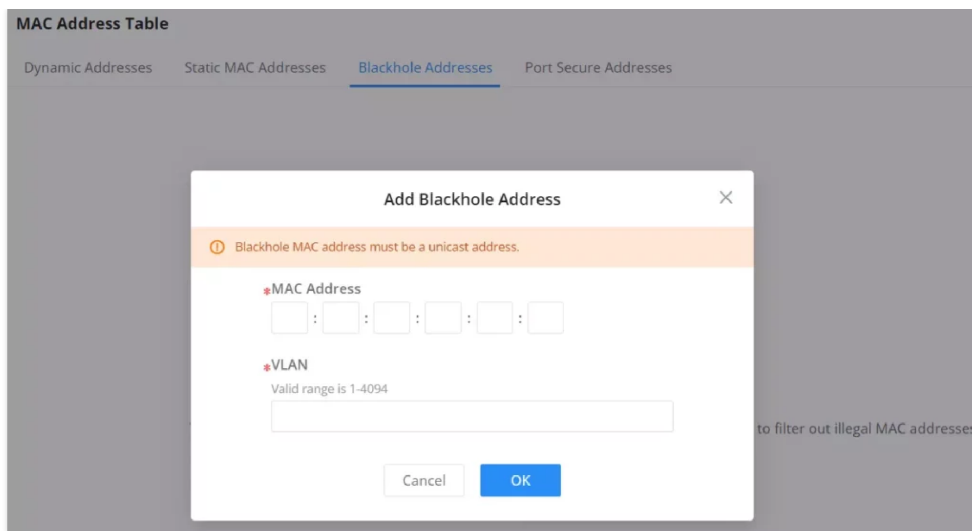

Black Hole Address

Port Security Address

After enabling port security in **Security** → **Port Security**, the addresses will be displayed in the **MAC Address Table** → **Port Security Address** synchronously.

The list shows the interface name, VLAN, and MAC address.

Note

To edit, delete or add security addresses, please navigate to **Security** → **Port Security**.

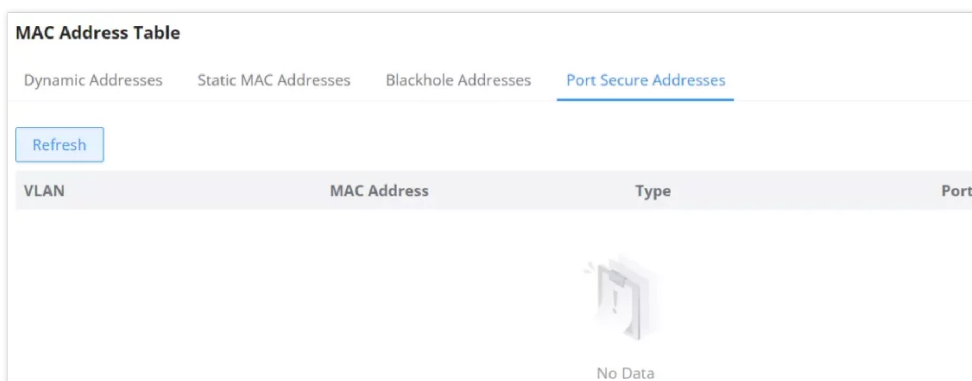

Port Security Address

VLAN

A virtual local area network, virtual LAN or VLAN, is a group of hosts with a common set of requirements that communicate as if they were attached to the same broadcast domain, regardless of their physical location. A VLAN has the same attributes as a physical local area network (LAN), but it allows for end stations to be grouped together even if they are not located on the same network switch. VLAN membership can be configured through software instead of physically relocating devices or connections.

A user can click on “**Add**” button to add a new VLAN, also it’s possible to create many VLANs at the same time by specifying a range, for example (7-9) will create VLAN 7,8 and 9, or create different separated VLANs, for example (11,89) will create VLAN 11 and 89.

Note:

VLAN ID valid range is from 2 to 4094. VLAN 0,1 and 4095 are reserved for the system.

VLAN					
VLAN	Description	Tagged Port	Untagged Port	Operation	
1	Default	--	1/0/1-1/0/6,1/0/8,1/0/18-1/0/28,LAG2-...		
7	Support	1/0/24	1/0/7		
9	Sales	1/0/24	1/0/9-1/0/16		
11	Guests	1/0/24	1/0/17,LAG1,LAG5		

VLAN tab

Add VLAN

***VLAN IDs**
Valid range is 2-4094. Example: "5-8, 11" will associate VLANs 5, 6, 7, 8 and 11.

Cancel
OK

Add a VLAN

If the VLAN is already created there is also the option to modify it by clicking on modify button for more options and settings like Description, Tagged and Untagged ports and LAGs.

VLAN > **Edit**

VLAN:

Description: 1-64 alphanumeric characters and special characters .@_

Member Type:

Port
Click port to change the member type

Tagged
 Untagged

2

4

6

8

10

12

14

16

18

20

22

24

1

3

5

7

9

11

13

15

17

19

21

23

25 SFP1

26 SFP2

27 SFP3

28 SFP4

LAG
Click port to change the member type

Tagged
 Untagged

Cancel
OK

Edit VLAN

VLAN	The specified VLAN ID
Description	Enter a brief comment for the VLAN ID.
Member Type	Select from the drop-down list: <ul style="list-style-type: none"> ● Remove All: remove all ports GE/LAG from this VLAN ● Tagged All: Tag all ports GE/LAG to this VLAN ● Untagged All: Untag all ports GE/LAG from this VLAN
GE	Select individually which ports are tagged, untagged or unselected. <i>Note:</i> <ul style="list-style-type: none"> ● Unselected ports will not be part of the VLAN ● Tagged ports expects tagged frames (Trunk port) like connecting a switch with another switch. ● Untagged ports expects non-tagged frames (Access port) like connecting a switch with end device.
LAG	Select individually which LAGs are tagged, untagged or unselected.

Edit VLAN

Please refer to the table below for more details about Tagged and Untagged Ports.

Port Type	Receiving Packets		Forwarding Packets
	Untagged Packets	Tagged Packets	Tagged Packets
Untagged	When untagged packets are received, the port will add the default VLAN tag, i.e. the PVID of the ingress port, to the packets.	If the VID of packet is allowed by the port, the packet will be received. If the VID of packet is forbidden by the port, the packet will be dropped.	The packet will be forwarded after removing its VLAN tag
Tagged			The packet will be forwarded with its current VLAN tag

VLAN Tagged and Untagged

VLAN Port Settings

The Port Settings page allows for configuring VLAN on each port and LAG by specifying the Link Type (Trunk, Access, Hybrid, or QinQ) as well as the default VLAN or PVID, the user can also enable Ingress Filtering for the selected port, also the accepted Frame Type (All, Tag Only and Untag only) and more.

VLAN Port Settings Link types

VLAN Port Settings VLAN Translation

Port Settings > Edit

Port: 1/0/2

Link Type: Hybrid

PVID: 1 Valid range is 1-4094

Accept Frame Type: All Tag Only Untag Only

TPID: 0x8100

Ingress Filtering:

VLAN Translation:

MAC VLAN:

Protocol VLAN:

Protocol Template: Protocol Template: VLAN: 802.1p:

VLAN Port Settings Protocol Template

Port	Shows the selected Port.
Link Type	<p>Select the Link Type:</p> <ul style="list-style-type: none"> ● Hybrid: Used for connection between switches, or switch and computer. ● Access: used to connect the switch and the user terminal. ● Trunk: used for interconnecting switches or connecting switches and routers, and can carry data frames of multiple different VLANs. ● QinQ: This is an extended VLAN tagging technique where an additional VLAN tag is added, also known as “double tagging.” It allows Layer 2 tunneling and is often used by service providers to transport customer VLANs.
PVID	Enter the default VLAN ID.
Accept Frame Type	<p>Specifies which types of Ethernet frames are accepted by the port. Options vary depending on the selected Link Type:</p> <p>Hybrid:</p> <ul style="list-style-type: none"> ● All: Accept both tagged and untagged frames (default). ● Tag Only: Accept only tagged VLAN frames; untagged packets will be dropped. ● Untag Only: Accept only untagged frames; tagged frames will be dropped. <p>Access:</p> <ul style="list-style-type: none"> ● All: Only this option is available. Untagged traffic is mapped to the configured PVID. <p>Trunk:</p> <ul style="list-style-type: none"> ● All: Accept both tagged and untagged frames; untagged frames are assigned to the PVID (default behavior). ● Tag Only: Accept only tagged frames; untagged traffic will be dropped (disables native VLAN). <p>QinQ:</p> <ul style="list-style-type: none"> ● All: Only this option is available due to double tagging structure. <p><i>Note: Setting Tag Only is the recommended method to disable native VLAN behavior on trunk and hybrid ports, providing better traffic control and increased security.</i></p>
Ingress Filtering	<p>Set whether to enable the inbound filtering function of the interface.</p> <p>Ingress Filtering is only available for Hybrid port, and it’s enabled by default.</p> <p><i>Note: Ingress filtering is a method used by enterprises and internet service providers (ISPs) to prevent suspicious traffic from entering a network.</i></p>
VLAN Translation	Allows translating one VLAN ID to another at the port level. It’s useful for scenarios where different parts of the network use different VLAN IDs but need to communicate with each other.
MAC VLAN	Allows the switch to assign VLANs based on the MAC address of the incoming traffic. It can be used for more dynamic VLAN assignment, where devices can be automatically placed into specific VLANs based on their MAC addresses.

Protocol VLAN	Allows VLAN assignments based on the protocol type in the frame, such as IP or ARP. It enables grouping traffic from certain protocols into specific VLANs for easier network management.
----------------------	---

VLAN Port Settings

VLAN Port Members

On this page, the user can define both Tagged and Untagged VLANs (members) for each port individually.

Note

Example: Enter "5-8, 11" to associate 5 VLANs of "5, 6, 7, 8 and 11".

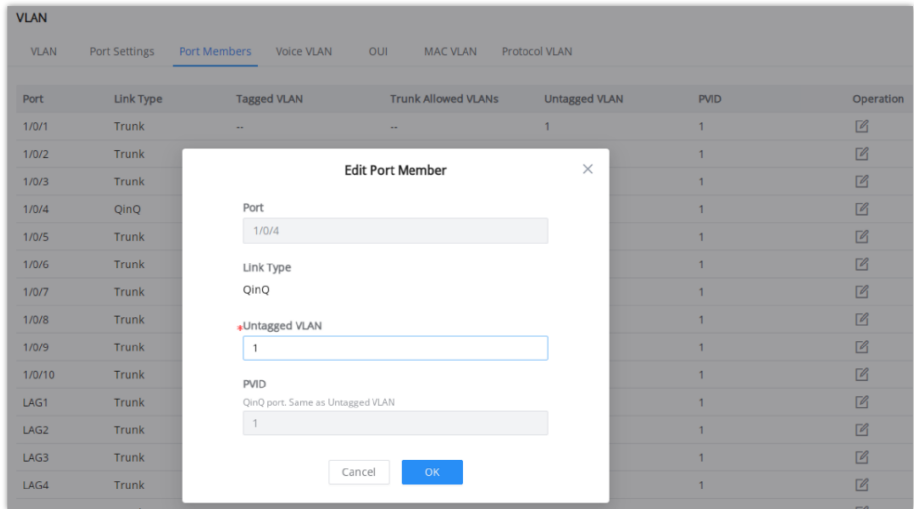

VLAN Port Members QinQ

Trunk Allowed VLANs allow the configuration of VLANs that do not yet exist on the switch and are only effective for configured VLANs.

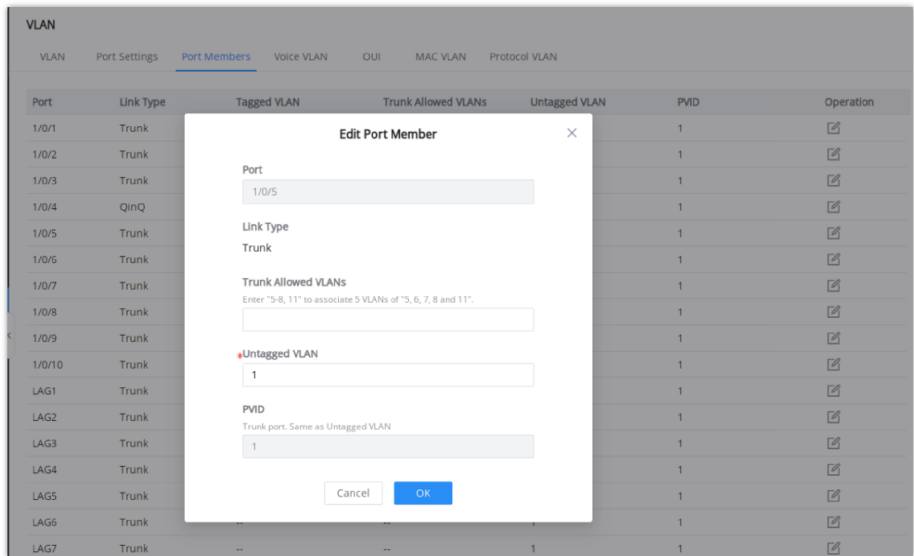

VLAN Port Members Trunk

Port	Link Type	Tagged VLAN	Trunk Allowed VLANs	Untagged VLAN	PVID	Operation
1/0/1	Trunk	--	--	1	1	[Edit]
1/0/2	Trunk	2-16	2-298	1	1	[Edit]
1/0/3	Trunk	--	--	1	1	[Edit]
1/0/4	QinQ	--	--	1	1	[Edit]
1/0/5	Trunk	--	--	1	1	[Edit]

VLAN Port Members

Voice VLAN

A voice VLAN (virtual local area network) is a dedicated VLAN specifically designed to carry voice traffic, such as IP phone calls. By isolating voice traffic from other types of network traffic, voice VLANs help ensure that voice calls are prioritized and experience minimal latency or jitter. This is critical to maintaining clear and uninterrupted voice communications.

Voice VLAN advantages:

- **Improved voice quality:** By isolating voice traffic from other types of network traffic, voice VLANs help reduce the latency and jitter that can cause choppy or distorted audio during voice calls.
- **Reduced congestion:** By prioritizing voice traffic, voice VLANs help prevent other types of network traffic from interfering with voice calls, even during periods of heavy network usage.
- **Simplified network management:** Voice VLANs can simplify network management by making it easier to troubleshoot and resolve voice-related issues.

For example, when an IP phone is connected to a GWN7820 switch port, the switch prioritizes traffic in the voice VLAN, ensuring that voice packets are forwarded before other types of packets.

The user can select more than one way to set up the voice VLAN:

- Auto Voice VLAN using LLDP
- Tagged OUI using LLDP
- Tagged OUI using VLAN Tag
- Untagged OUI

For more details, please visit this guide: [GWN78xx\(P\) – Voice VLAN Guide](#).

To configure Voice VLAN, please navigate to **Web UI → Switching → VLAN page → Voice VLAN tab**.

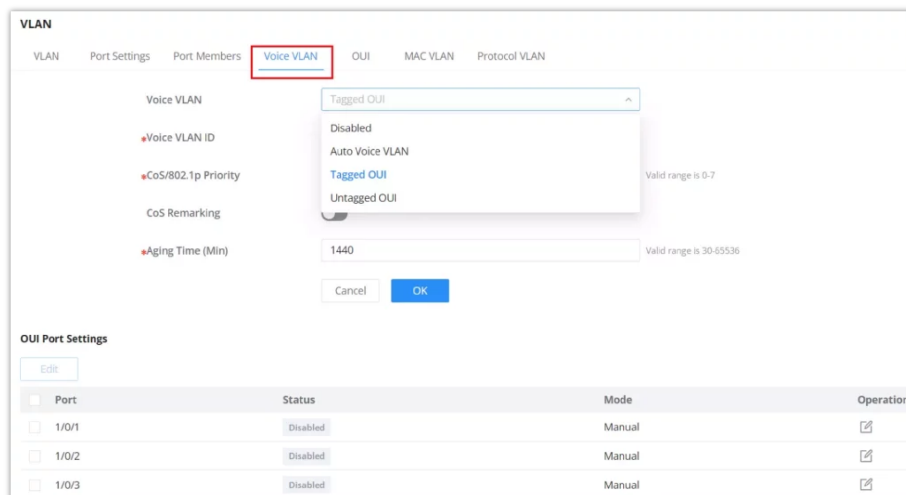

Voice VLAN

<p>Voice VLAN</p>	<p>Select from the drop-down list the Voice VLAN method:</p> <ul style="list-style-type: none"> ● Disabled ● Auto Voice VLAN ● Tagged OUI ● Untagged OUI <p><i>By default is disabled.</i></p>
<p>Voice VLAN ID</p>	<p>Select a VLAN as the voice VLAN from the VLAN list. <i>Note: The default VLAN 1 cannot be used as a voice VLAN.</i></p>
<p>CoS/802.1p Priority</p>	<p>Specify the CoS/802.1p Priority, Valid range is 0-7.</p>

If Auto Voice VLAN is selected	
DSCP	Specify the DSCP priority, an integer ranging from 0 to 63.
LLDP/LLDP MED Auto Config	If Auto Voice VLAN for Voice VLAN mode is selected, then you need to go to LLDP to set network policies. LLDP automatic configuration is added to voice VLANs to make it easier and faster for users to configure them with one click.
If Tagged or Untagged OUI is selected	
CoS	Set whether to enable CoS Remarking.
Aging Time	Set the aging time of the voice VLAN. <i>The value range is an integer from 30 to 65536 , and the default is 1440 minutes .</i>
Edit Port Settings	<p>Port: Displays the selected port.</p> <p>Status: Set whether to enable the voice VLAN function of the port. <i>it is disabled by default.</i></p> <p>Mode: Set the working mode of the voice VLAN on the port. <i>The default is manual.</i></p> <p>Note: <i>When set to " Manual ", the port must be added to the voice VLAN manually, and the LLDP function needs to be used.</i></p>

Voice VLAN

OUI

An OUI address is a unique identifier assigned by IEEE (Institute of Electrical and Electronics Engineers) to a device vendor. It comprises the first 24 bits of a MAC address. You can recognize which vendor a device belongs to according to the OUI address. The following table shows the OUI addresses of several manufacturers. There is also the option to add a custom one based on user needs.

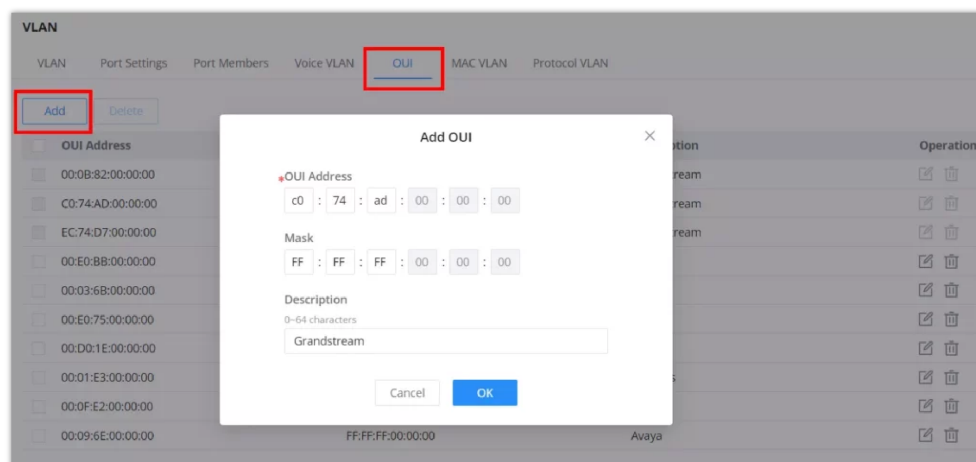

VLAN OUI

MAC VLAN

MAC VLAN is a networking technique where each VLAN is based on the source MAC address of incoming frames. Devices with the same MAC address share a VLAN. This segmentation enables isolated communication between devices within the same VLAN based on MAC addresses.

VLANs are divided according to the source MAC address of the data frame. Through the configured MAC address and VLAN mapping table, when the switch receives an untagged frame, it adds the specified VLAN Tag to the data frame based on the mapping table.

To add a MAC address to VLAN mapping, click on "Add" button then specify the MAC Address, Mask Length, VLAN and the priority (802.1p).

Note:

Only effective for Hybrid port.

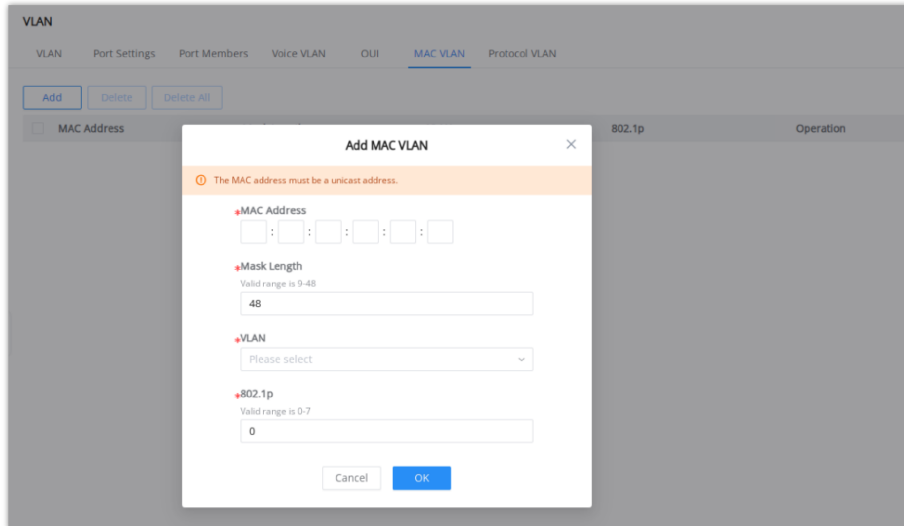

VLAN MAC VLAN

Protocol VLAN

VLANs are divided according to the protocol (family) type and encapsulation format to which the data frame belongs. Through the configured protocol domain and VLAN mapping table in the Ethernet frame, when the switch receives an untagged frame, it adds the specified VLAN Tag based on the mapping table.

Note:

Only effective for Hybrid port.

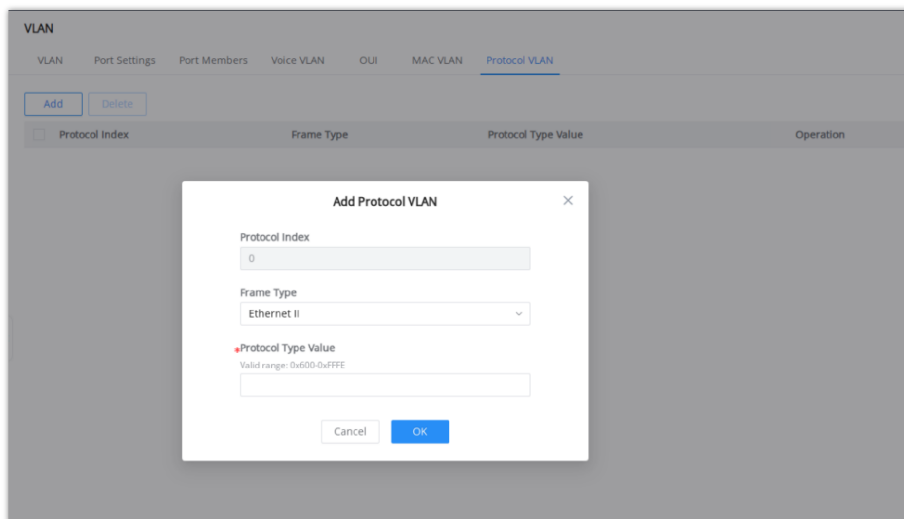

VLAN Protocol VLAN

PVLAN

Private VLAN (PVLAN) is supported on the GWN78xx switch series, offering enhanced traffic isolation within the same VLAN domain. This allows more granular segmentation and security, especially useful in shared environments like data centers, hotels, or enterprise access layers.

Note:

The PVLAN feature is supported on the following models: GWN7806(P), GWN7811(P), GWN7812P, GWN7813(P), GWN7816(P), GWN7821P, GWN7822P, GWN7830, GWN7831, GWN7832.

VLAN Settings

This tab allows assigning a PVLAN type to each VLAN.

1. Go to **Switching > PVLAN > VLAN Settings**.
2. Select a VLAN and click **Edit**.
3. Choose the VLAN type from:
 - **Primary**: Communicates with all other PVLAN types.
 - **Isolated**: Can only talk to Primary VLAN.
 - **Community**: Can talk to Primary and other VLANs in the same Community.
4. Click **OK** then **Save**.

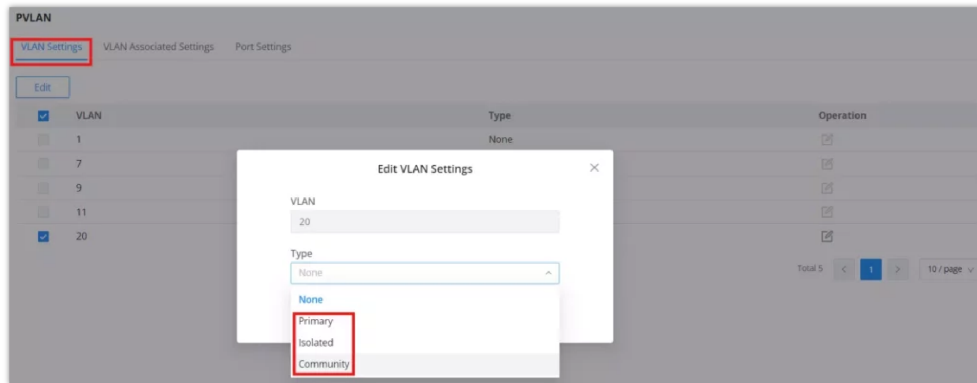

PVLAN VLAN Settings

Note:

PVLAN type assignment is required before using VLANs in association or port bindings.

VLAN Associated Settings

This section allows linking VLANs together in a PVLAN structure.

1. Go to **Switching > PVLAN > VLAN Associated Settings**.
2. Click **Add**, then set:
 - **Primary VLAN**: The main VLAN in this association.
 - **Isolated VLAN**: VLAN(s) that only communicate with the Primary.
 - **Community VLAN**: VLAN(s) that communicate with Primary and each other.
3. Use comma-separated lists (e.g., **11, 12**) or ranges (**20-24**) as needed.
4. Click **OK** to apply.

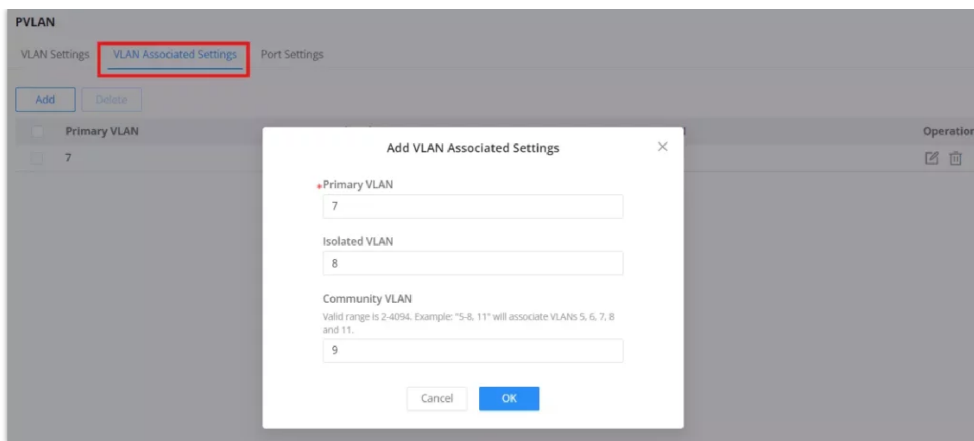

PVLAN VLAN Associated Settings

Note:

You must assign the correct PVLAN type to each VLAN in the previous tab, or association will fail (e.g., "Vlan-private type error").

Port Settings (PVLAN)

Here you bind switch ports to PVLAN roles.

1. Go to **Switching > PVLAN > Port Settings**.
2. Select a port and click **Edit**.
3. Choose the **Mode**:
 - o **Promiscuous**: Communicates with all other PVLAN port types.
 - o **Host**: Communicates only with Promiscuous ports.
 - o **Community**: Communicates with Promiscuous and other Community ports in the same VLAN.
 - o **Trunk Variants**: Used to forward tagged PVLAN traffic.
4. Click **OK** and then **Save**.

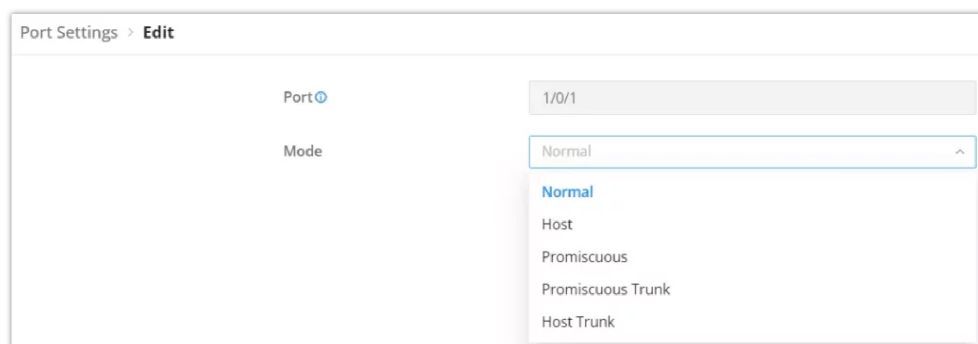

PVLAN VLAN Associated Settings

Note:

Do not configure Port Security, MAC Authentication, or 802.1X Authentication on the same port when PVLAN is enabled.

Spanning Tree

STP (Spanning Tree Protocol), Devices running STP discover loops in the network and block ports by exchanging information, in that way, a ring network can be disbranched to form a tree-topological ring-free network to prevent packets from being duplicated and forwarded endlessly in the network.

BPDU (Bridge Protocol Data Unit) is the protocol data that STP, RSTP and MSTP use. Enough information is carried in BPDU to ensure the spanning tree generation. STP is to determine the topology of the network via transferring BPDUs between devices.

This page allows a user to configure and display Spanning Tree Protocol (STP) property configuration including the STP Mode (STP, RSTP or MSTP), Path Cost, Bridge Priority, Max Hops, Hello and Max Aging time and Forward Delay Time.

The screenshot shows the 'Spanning Tree' configuration interface. It includes tabs for 'Global Settings', 'Port Settings', 'MST Instance', and 'MST Port Settings'. The 'Global Settings' tab is active, showing a list of configuration options with their current values and status. Below the settings is a 'Status' section with a refresh icon, displaying the current configuration values for Bridge ID, Root Bridge ID, Root Port, and Root Path Cost.

Spanning Tree Global Settings

Spanning Tree	Set whether to enable Spanning Tree.
Mode	<p>Set the operating mode of Spanning Tree (STP).</p> <ul style="list-style-type: none"> • STP: Standard Spanning Tree Protocol. Provides basic loop prevention but has slow convergence. Use only for compatibility with older or legacy network devices. • RSTP: Rapid Spanning Tree Protocol. Faster convergence than STP, suitable for most modern networks. Recommended as the default for typical deployments. • MSTP: Multiple Spanning Tree Protocol. Allows grouping of multiple VLANs into a single STP instance. Best suited for large networks with many VLANs that require efficient resource use. • PVST+: Per-VLAN Spanning Tree Plus. Runs one STP instance per VLAN, offering detailed control of loop prevention per VLAN. Good for networks with high segmentation. • RPVST(+): Rapid Per-VLAN Spanning Tree Plus. Combines the benefits of RSTP and PVST(+), offering fast convergence for each VLAN. Ideal for high-availability environments with VLAN-based traffic control.
Ignore VLAN in BPDU	This feature allows the switch to ignore VLAN-specific information in Bridge Protocol Data Units (BPDUs). This prevents VLAN configurations from influencing Spanning Tree Protocol (STP) decisions across multiple VLANs.
Path Cost	Specify the path cost method (Short, Long, or Legacy). <i>Default is Short.</i>
Bridge Priority	<p>Select the Bridge Priority, In an STP network, the device with the smallest bridge ID is elected as the root bridge.</p> <p><i>Default is 32768.</i></p> <p>Note: The valid range is 0~61440, which must be a multiple of 4096</p>
Max Hops	Select the Max Hops (the range is 1 – 40). <i>Default is 20</i>
Hello Time (s)	Specify the Hello Time in seconds (the range is 1 -10). <i>Default is 2.</i>

	<i>Note: The time interval at which the device running the STP protocol sends the configuration message BPDU , which is used by the device to detect whether the link is faulty.</i>
Max Aging Time (s)	Select The aging time of BPDU packets of the port (the range is 6 – 40). <i>Default is 20.</i>
Forward Delay Time (s)	Specify the Forward Delay Time in seconds (the range is 4 -30). <i>Default is 15.</i>

STP Global Settings

STP Port Settings

To configure STP on each port and LAG then navigate to **WEB UI → Spanning Tree → Port Settings**, then click on **“Edit”** button.

Port	Port Enable	Priority	Path Cost	Edge Port	BPDU Guard	BPDU Filter	Point-to-Point	Port Status	Operation
<input checked="" type="checkbox"/> 1/0/1	Enabled	128	4	Auto	Disabled	Disabled	Auto	Disabled	
<input type="checkbox"/> 1/0/2	Enabled	128	4	Auto	Disabled	Disabled	Auto	Disabled	
<input type="checkbox"/> 1/0/3	Enabled	128	4	Auto	Disabled	Disabled	Auto	Disabled	
<input type="checkbox"/> 1/0/4	Enabled	128	4	Auto	Disabled	Disabled	Auto	Disabled	
<input type="checkbox"/> 1/0/5	Enabled	128	4	Auto	Disabled	Disabled	Auto	Disabled	
<input type="checkbox"/> 1/0/6	Enabled	128	4	Auto	Disabled	Disabled	Auto	Disabled	
<input type="checkbox"/> 1/0/7	Enabled	128	4	Auto	Disabled	Disabled	Auto	Disabled	
<input type="checkbox"/> 1/0/8	Enabled	128	4	Auto	Disabled	Disabled	Auto	Disabled	
<input type="checkbox"/> 1/0/9	Enabled	128	4	Auto	Disabled	Disabled	Auto	Disabled	
<input type="checkbox"/> 1/0/10	Enabled	128	4	Auto	Disabled	Disabled	Auto	Disabled	
<input type="checkbox"/> 1/0/11	Enabled	128	4	Auto	Disabled	Disabled	Auto	Forwardline	

Spanning Tree Port Settings

For each port or LAG, the user can enable STP and specify the priority, Path Cost, Edge port, BPDU Guard and Filter and Point-To-Point.

Port Settings · Edit Port

Port: 1/0/1

Enable Spanning Tree

Priority: 128 Enter a value between 0-240 that is a multiple of 16

Path Cost: 0 Valid range is 0-65535

Edge Port: Auto Enabled Disabled

Root Protection

Loop Protection

BPDU Guard

BPDU Filter

Point-to-Point: Auto Enabled Disabled

Cancel OK

Spanning Tree Edit Port Settings

Port	Displays the selected GE/LAG Port.
Enable STP	Set whether to enable STP on this port.
Priority	Priority is an important basis for determining whether the port will be selected as the root port. The port with higher priority under the same conditions will be selected as the root port . The smaller the value , the higher the priority . An integer in the range of 0-240, with a step size of 16, and a default of 128 . <i>Note: The valid range is 0~240, which must be a multiple of 16</i>

Path Cost	<p>Set the path cost of the port on the specified spanning tree. The default value is 0, which means that path cost calculation is performed automatically.</p> <p>Note:The valid range of path cost depends on the path cost settings in Global Settings.If set to “Short” in Global Settings, the valid range is 0-65535; if set to “Long”, the valid range is 0-200000000; if set to “legacy”, the valid range is 0-200000.</p>
Edge Port	<p>Set whether to enable Edge Port or disable it, by default it's on auto.</p> <p>Notes:</p> <ul style="list-style-type: none"> • A port is considered as an edge port when it is directly connected to the user terminal or server, instead of any other switches or shared network segments. The edge port will not cause a loop upon network topology changes. • In the edge mode, the interface would be put into the Forwarding state immediately upon link up. While in auto mode it will detect if the port is an edge or not.
Root Protection	<p>Safeguards the root bridge by preventing designated ports from becoming the root port, thus protecting the current root bridge from being displaced by lower-priority BPDUs.</p>
Loop Protection	<p>Prevents Layer 2 loops by ensuring a blocking state on ports that stop receiving BPDUs, avoiding the formation of network loops.</p>
BPDU Guard	<p>Set whether to enable BPDU Guard.</p> <p>Note: BPDU Guard further protects your switch by turning this port into error state and shutdown if any BPDU received from this port.</p>
BPDU Filter	<p>Set whether to enable BPDU Filter.</p> <p>Note: Drop all BPDU packets and no BPDU will be sent.</p>
Point-to-Point	<p>Select Point-to-Point option (Auto, Enabled or Disabled). <i>Default is Auto.</i></p> <p>Note: determines the STP of link type for this port automatically if set to Auto.</p>

STP Port Settings

Multiple Spanning Tree Instances

MST or Multiple Spanning Tree Instance allows traffic of different VLAN to be mapped into different MST Instances. GWN78xx Switch supports up to 16 independent MST instances (0~15) where each instance can be associated with many VLANs.

Spanning Tree

Global Settings Port Settings **MST Instance** MST Port Settings

Region Name: C0:74:AD: [input field] 1-32 alphanumeric characters and special characters :_~

Revision Level: 0 Valid range is 0-65535

Cancel OK

MSTI	VLAN	Priority	Bridge Identifier	Designated Root Bridge	Root Port	Root Path Cost	Remaining Hops	Operation
0	1-4094	61440	61440-C0:74:AD:DF:CC:94	32767-C0:74:AD:C9:72:E9	1/0/24	4	20	[edit]
1	--	32768	61440-C0:74:AD:DF:CC:94	61440-C0:74:AD:DF:CC:94	1/0/24	0	20	[edit]
2	--	32768	61440-C0:74:AD:DF:CC:94	61440-C0:74:AD:DF:CC:94	1/0/24	0	20	[edit]
3	--	32768	61440-C0:74:AD:DF:CC:94	61440-C0:74:AD:DF:CC:94	1/0/24	0	20	[edit]
4	--	32768	61440-C0:74:AD:DF:CC:94	61440-C0:74:AD:DF:CC:94	1/0/24	0	20	[edit]

Multiple Spanning Tree Instances

MST Instance > **Edit MST Instance**

MSTI: 0

VLAN: 1-4094 Enter "5-8, 11" to associate 5 VLANs of "5, 6, 7, 8 and 11".

Priority: 61440 Enter a value between 0-61440 that is a multiple of 4096

Cancel OK

Bridge Identifier: 61440-C0:74:AD: [redacted]

Designated Root Bridge: 32767-C0:74:AD: [redacted]

Root Port: 1/0/24

Root Path Cost: 4

Remaining Hop: 20

MST Edit Port

MST Port Settings is used to configure the GE port / LAG group settings for each MST instance. The table displays the MST parameters for each port.

Spanning Tree

Global Settings Port Settings MST Instance MST Port Settings

MSTI: 0

Port Settings

Edit Refresh

Port	Path Cost	Priority	Role	Status	Mode	Type	Designated Bridge ID	Operation
<input checked="" type="checkbox"/> 1/0/1	4	128	Disabled Port	Disabled	STP	Boundary	0-00:00:00:00:00:00	
<input checked="" type="checkbox"/> 1/0/2	4	128	Disabled Port	Forwarding	STP	Boundary	61440-C0:74:AD: [redacted]	
<input type="checkbox"/> 1/0/3	4	128	Disabled Port	Disabled	STP	Boundary	0-00:00:00:00:00:00	
<input type="checkbox"/> 1/0/4	4	128	Disabled Port	Disabled	STP	Boundary	0-00:00:00:00:00:00	
<input type="checkbox"/> 1/0/5	4	128	Disabled Port	Disabled	STP	Boundary	0-00:00:00:00:00:00	
<input type="checkbox"/> 1/0/6	4	128	Disabled Port	Disabled	STP	Boundary	0-00:00:00:00:00:00	
<input type="checkbox"/> 1/0/7	4	128	Disabled Port	Disabled	STP	Boundary	0-00:00:00:00:00:00	

MST Port Settings

Click on "Edit" button to edit the MST Port Settings for each Port/LAG individually and also the user can even specify the Path Cost and Priority per Port/LAG as well.

MST Port Settings > **Edit MST Port Settings**

MSTI: 0

Port: 1/0/2

Path Cost: 0 Valid range is 0-65535

Priority: 128 Enter a value between 0-240 that is a multiple of 16

Cancel OK

Port Role: Disabled Port

Port Status: Forwarding

Mode: STP

Type: Boundary

Designated Bridge ID: 61440-C0:74:AD: [redacted]

Designated Port ID: 128.2

Designated Path Cost: 4

Remaining Hop: 20

MST Port Settings Edit port

PVST VLAN Settings

When Per VLAN Spanning tree protocol is selected as the STP protocol to be used, then the VLAN settings can be defined.

Spanning Tree						
Global Settings Port Settings VLAN Settings PVST Port Settings						
VLAN	Enable PVST	Bridge Priority	Hello Time (s)	Max Aging Time (s)	Forward Delay Time (s)	Operation
1	Enabled	32768	2	20	15	
7	Disabled	32768	2	20	15	

Total 2 < 1 > 10 / page

The below parameters are to be configured:

VLAN	Displays the VLAN on which the PVST rule will PVST protocol will be applied
Enable PVST	Enables/disables PVST per VLAN
Bridge Priority	Defines the bridge priority for the VLAN, valid range is 0-61440, default value is 32768. Note: All values should be a multiple of 4096
Hello Time (s)	Specify the Hello Time in seconds (the range is 1 -10). Default is 2. Note: The time interval at which the device running the STP protocol sends the configuration message BPDU , which is used by the device to detect whether the link is faulty.
Max Aging Time (s)	Select The aging time of BPDU packets of the port (the range is 6 – 40). Default is 20.
Forward Delay Time (s)	Specify the Forward Delay Time in seconds (the range is 4 -30). Default is 15.

PVST Port Settings

The PVST Port settings defines the priority and path cost for each port of the switch , per each vlan,

It also displays, for each port, its role, designated Bridge ID, designated Port ID, and designated Path Cost.

Spanning Tree									
Global Settings Port Settings VLAN Settings PVST Port Settings									
VLAN: 1									
Port Settings									
<input type="button" value="Edit"/> <input type="button" value="Refresh"/>									
Port	Path Cost	Priority	Role	Status	Designated Bridge ID	Designated Port ID	Designated Path Cost	Operation	
<input type="checkbox"/> 1/0/1	65535	128	Disabled Port	Disabled	0-00:00:00:00:00:00	0-0	65535		
<input type="checkbox"/> 1/0/2	65535	128	Disabled Port	Disabled	0-00:00:00:00:00:00	0-0	65535		
<input type="checkbox"/> 1/0/3	65535	128	Disabled Port	Disabled	0-00:00:00:00:00:00	0-0	65535		
<input checked="" type="checkbox"/> 1/0/4	65535	128	Disabled Port	Disabled	0-00:00:00:00:00:00	0-0	65535		
<input type="checkbox"/> 1/0/5	65535	128	Disabled Port	Disabled	0-00:00:00:00:00:00	0-0	65535		
<input type="checkbox"/> 1/0/6	65535	128	Disabled Port	Disabled	0-00:00:00:00:00:00	0-0	65535		
<input type="checkbox"/> 1/0/7	18	128	Designated Port	Forwarding	32769-EC:74:D7:3D:90:A4	128:7	18		
<input type="checkbox"/> 1/0/8	65535	128	Disabled Port	Disabled	0-00:00:00:00:00:00	0-0	65535		
<input type="checkbox"/> 1/0/9	65535	128	Disabled Port	Disabled	0-00:00:00:00:00:00	0-0	65535		
<input type="checkbox"/> 1/0/10	65535	128	Disabled Port	Disabled	0-00:00:00:00:00:00	0-0	65535		
<input type="checkbox"/> 1/0/11	65535	128	Disabled Port	Disabled	0-00:00:00:00:00:00	0-0	65535		
<input type="checkbox"/> 1/0/12	65535	128	Disabled Port	Disabled	0-00:00:00:00:00:00	0-0	65535		
<input type="checkbox"/> 1/0/13	65535	128	Disabled Port	Disabled	0-00:00:00:00:00:00	0-0	65535		
<input type="checkbox"/> 1/0/14	65535	128	Disabled Port	Disabled	0-00:00:00:00:00:00	0-0	65535		

The parameters to be defined are

Port	Displays the port, or ports that the settings will be applied on.
Priority	Displays the single port priority. valid range is 0-240 and the default value is 18. Note: The value must be a multiple of 16

Path Cost	Configures the port path cost for the port on the specified spanning tree. The value must be an integer between 0-65535. The default value is 0, which means the path cost calculation will be performed automatically.
------------------	---

IP

VLAN IP Interface

Hosts in different VLANs cannot communicate directly and need to be forwarded through routers or layer 3 switching protocols.

A VLAN interface is a virtual interface in Layer 3 mode and is mainly used to implement Layer 3 communication between VLANs, it does not exist on the device as a physical entity. Each VLAN corresponds to an interface by configuring an IP address for it, it can be used as the gateway address of each port in the VLAN so that packets between different VLANs can be forwarded to each other on Layer 3 routing through the VLAN interfaces. GWN switches support IPv4 interfaces as well as IPv6.

IPv4/IPv6 Interface

To add an IP Interface, please click on the **“Add”** button, refer to the figure below:

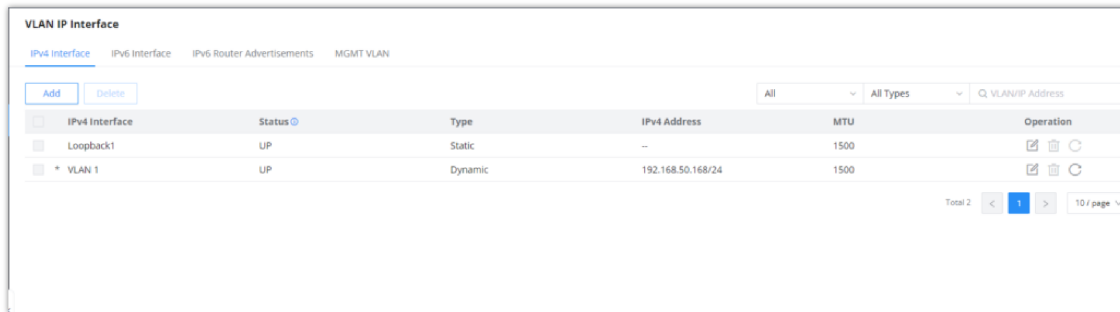

VLAN IP Interface MGMT VLAN

Use the **“refresh icon”** to request a new IP address from the DHCP server. This action will prompt a confirmation dialog; clicking **“OK”** will obtain a new IP address, which may change upon successful retrieval.

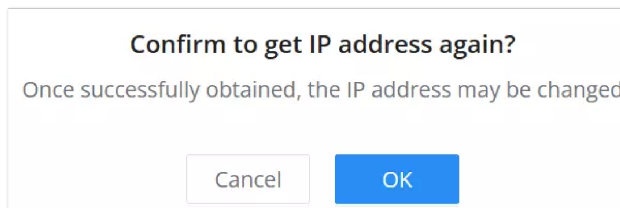

Refresh IP address

Address Type:

- **If DHCP is selected:** hosts will obtain IP addresses automatically from whatever DHCP pool configured from example like a router.

Edit IPv4 Interface

VLAN

IPv4 Address Type
 Static IP DHCP

*Gateway Priority
 Valid range is 2-255

*MTU
 Valid range is 1280-9216

Add VLAN IP Interface DHCP IPv4

IPv6 Interface > Edit IPv6 Interface

VLAN

IPv6 Enable

Link-Local Address Auto Generate Manually Configure

Global Unicast Address

*Gateway Priority Valid range is 2-255

*MTU Valid range is 1280-9216

Add VLAN IP Interface DHCP IPv6

Gateway Priority: valid range from 2 [very important] to 255 [least important],

MTU (Maximum Transmission Unit): valid range is 1280-9216.

- o **If Static IP is selected:** the user can specify the IPv4 or IPv6 manually.

Add IPv4 Interface

*VLAN
 Valid range is 1-4094.

IPv4 Address Type
 Static IP DHCP

*IPv4 Address

Mask

*Prefix Length
 Valid range is 8-30.

*MTU
 Valid range is 128-9216.

Add VLAN IP Interface

Note:

Gateway Usage Priority:

- Statically configured gateway (manually set) has the highest priority.
- Gateway with a specified priority (smaller priority value means higher priority).
- If priorities are the same, the gateway with the smaller VLAN ID will be used.

IPv6 Router Advertisements

IPv6 Router Advertisements (RAs) are messages sent by routers to provide information to devices on the network, such as the default gateway, DNS servers, and network prefixes. These advertisements help devices configure their IP addresses and routing automatically without the need for manual configuration. In the VLAN IP Interface section, you can configure RAs for each VLAN to manage IPv6 network settings.

IPv6 Interface	Interface Enable	Route Information	Timeout (s)	Lifetime (s)	Flag	Number	Operation
* VLAN 1	Disabled	Disabled	600	1800	--	0	
VLAN 7	Disabled	Disabled	600	1800	--	0	
VLAN 9	Disabled	Disabled	600	1800	--	0	

IPv6 Router Advertisement

In the Edit IPv6 Router Advertisements screen, you can customize settings for a specific VLAN. This includes enabling or disabling the interface, setting route information, and configuring timeouts and lifetimes for the advertisements. You can also define IPv6 addresses and prefixes, adjust flags for additional configurations, and set the priority of the default route. This allows for fine-tuning the behavior of the advertisements to suit your network requirements.

IPv6 Router Advertisements > Edit IPv6 Router Advertisements

VLAN: VLAN 1

Interface Enable:

Route Information:

Timeout (s): 600 (Valid range is 1-1800)

Lifetime (s): 1800 (Valid range is 0-9000)

Flag: M Flag O Flag

Default Route Priority: 中

IPv6 Address/Prefix1

IPv6 Address/Prefix: / 64 (Prefix range 1-128)

Valid Lifetime (s): 2592000 (Valid range is 0-4294967295)

Preferred Lifetime (s): 604800 (Valid range is 0-4294967295)

Flag: A Flag L Flag R Flag

Buttons: Cancel, OK, Add (+)

Edit IPv6 Router Advertisement

MGMT VLAN

When you assign an IP address to the management VLAN interface, the system synchronizes this IP configuration with the corresponding VLAN interface in the device's Layer 3 IP interface configuration. This ensures that the IP address used for managing the device is consistent with the VLAN's routing and switching setup.

For example, if you configure the management VLAN with an IP address 192.168.2.100 on VLAN 2, this IP will also be reflected in the IP interface configuration for VLAN 2, ensuring both management and routing functions are aligned.

VLAN IP Interface

IPv4 Interface | IPv6 Interface | IPv6 Router Advertisements | **MGMT VLAN**

MGMT VLAN: VLAN 2

IPv4 Address Settings

Address Type: Static IP DHCP

IP Address: 192.168.2.100 (IPv4 format)

Mask: Subnet Mask Mask Length

Mask Length: 24 (Valid range is 8-30)

Static Gateway: (IPv4 format)

IPv6 Address Settings

Enable:

Cancel OK

Management Address	
MGMT VLAN	VLAN 2
Status	DOWN
IPv4	
Address Type	Static
IP Address	192.168.2.100
Mask Length	24

MGMT VLAN

DHCP Server

When creating a VLAN IP Interface with a static IP, the user can link it with a DHCP Server for hosts to obtain IP addresses.

Please navigate to the **Web UI** → **IP** → **DHCP Server** page.

Step 1: Enable DHCP Server.

DHCP Server

DHCP Server | Address Table

DHCP Service:

Cancel OK

Address Pool Settings

Add Delete

Address Pool Name	Type	VLAN IPv4 Interface	Address Pool	Used	Remained	Operation
Guest network	Interface	VLAN 9	90.0.0.2-90.0.0.254	0	253	
7	Interface	VLAN 7	70.0.0.7-70.0.0.77	1	70	

DHCP Global Settings

Step 2: on **Address Pool Settings** section, click on **"Add"** button to add a new address pool.

Note:

- Global address pool is only used for IP address allocation to DHCP relay.
- When a VLAN is configured to use DHCP to automatically get an IP address, the system can now prioritize which **gateway** (the device routing traffic to other networks) to use.

Add a pool range for the DHCP Server, then select the interface (VLAN).

DHCP Server > Add Address Pool

Address Pool Name: Network_7_pool (1-64 characters)

Type: Interface

Interface: VLAN 7

IPv4 Pool: 70.0.0.2 - 70.0.0.254

Duration (min): 120 (Valid range is 1-11520)

DNS Server: 1.1.1.1 (Add +)

WINS Server: (Add +)

Netbios Node Type: (dropdown)

DHCP Option1

DHCP Option: (dropdown) (The range is 2-254 (excluding 50-54, 56, 58, 59, 61 and 82))

Type: Hex (dropdown)

Option Content: (text input) (0-256 characters, and must be even)

Buttons: Cancel, OK, Add +

DHCP Add Pool

In this section, the user can configure DHCP Options like the type, Service (for option 43), and option content. It's also possible to add more DHCP Options by clicking on the "Add" icon as shown below:

Duration (min): 120 (Valid range is 1-2880)

DNS Server: (text input) (Add +)

WINS Server: (text input) (Add +)

Netbios Node Type: (dropdown)

DHCP Option1

DHCP Option: 43 (dropdown) (The range is 2-254 (excluding 50-54, 56, 58, 59, 61 and 82))

Type: ASCII (dropdown)

Service: Custom (dropdown)

Option Content: (text input) (0-255 characters)

Buttons: Cancel, OK, Add +

DHCP Server Add Pool DHCP Options

The address table will displays the hosts (devices) MAC Addresses and the IP addresses when using the DHCP Server. Also it's possible make a entry a static one by clicking on "Add as Static Binding IP" button.

DHCP Server

DHCP Server [Address Table](#)

Buttons: Add, Refresh, Add as Static Binding IP, Delete

Search: IPV4 Address/Client Name/C...

Client Name (MAC Address)	IPv4 Address	Type	Remaining Lease (s)	Operation
CD:74:AD:93:0C:F8	70.0.0.32	Dynamic	6926	

Total 1 | Page 1 of 10

DHCP DHCP Server

DHCP Relay

DHCP relay on GWN78xx switch helps a network device pass DHCP messages between clients and servers that are on a completely different networks. When you have a DHCP server that needs to serve clients on different subnets (or VLANs). A DHCP relay agent is a network device that can route between the client's subnet and the server's subnet. The relay agent gets the broadcast request from the client and sends it to the server, putting its own interface address as the gateway address (giaddr) field in the packet. This way, the server can tell which subnet the client is on and assign a suitable IP address. The server then sends the reply back to the relay agent, which passes it to the client.

DHCP Relay

DHCP Relay	Set whether to enable the global DHCP relay function <i>the default is off.</i>
Polling	Set whether to enable the polling function of the DHCP relay <i>disabled by default.</i>
TTL	Set the TTL value of the DHCP request message after being forwarded by the DHCP relay layer 3. <i>the value is an integer from 1 to 16 , and the default is 4 .</i>
DHCP Server	
Interface	Select from the existing VLAN interfaces.
DHCP Server	Set the address of the DHCP server. <i>Note: The DHCP server address cannot be the interface IP address of the DHCP relay gateway , otherwise the DHCP client cannot obtain an IP address.</i>

DHCP Relay

ARP Table

Address Resolution Protocol ARP is a protocol used to resolve IP addresses to MAC addresses. In a local area network, when a host or three-layer network device has data to send to another host or three-layer network device, it needs to know the other party's network layer address (IP address) because IP addresses must be encapsulated into frames to be sent over the physical network, the sender also needs to know the receiver's actual physical address (MAC address), which requires a mapping from IP to MAC address. ARP implements the resolution of IP addresses into MAC addresses. A host or Layer 3 network device maintains an ARP table to store the relationship between IP addresses and MAC addresses. ARP entries include dynamic ARP entries and static ARP entries.

Dynamic ARP entry: It is automatically generated and maintained by the ARP protocol through ARP packets, can be aged out, can be updated by new ARP packets, and can be overwritten by static ARP entries. When the aging time is reached and the interface is down, the device immediately deletes the dynamic ARP entry in response.

Static ARP entry: A fixed mapping relationship between IP addresses and MAC addresses manually established by the network administrator, which will not be aged out and will not be overwritten by dynamic ARP entries, which can ensure the security of network communication. Static ARP entries can restrict the local device to use only the specified MAC address when communicating with the peer device with the specified IP address, in this case, the attack packet cannot modify the mapping relationship between the IP address and the MAC address in the ARP table of the local device thus the normal communication between the local device and the peer device is protected.

To configure the ARP Table, please navigate to **Web UI → IP → ARP Table**.

ARP Table

•Aging Time (s) Valid range is 15-21600.

ARP Table

All

<input type="checkbox"/>	VLAN	IP Address	MAC Address	Interface	Type	Expiration Time (s)	Operation
<input type="checkbox"/>	VLAN 1	192.168.80.1	c0:74:ad:23:aa:64	1/0/8	Dynamic	1113	
<input checked="" type="checkbox"/>	VLAN 1	192.168.80.88	e8:f4:08:3b:62:ff	--	Static	--	
<input checked="" type="checkbox"/>	VLAN 1	192.168.80.77	e8:f4:08:3b:62:fd	1/0/8	Dynamic	1176	

ARP Table

Aging time (seconds): Set the aging time of dynamic ARP entries. After the aging time expires, dynamic ARP entries are automatically deleted. The value range is an integer from 15 to 21600, and the default is 1200 seconds.

ARP Table

All

<input type="checkbox"/>	VLAN	IP Address	MAC Address	Interface	Type	Expiration Time (s)	Operation
<input type="checkbox"/>	VLAN 1	192.168.80.1	c0:74:ad:23:aa:64	1/0/8	Dynamic	1073	
<input type="checkbox"/>	VLAN 1	192.168.80.88	e8:f4:08:3b:62:ff	--	Static	--	
<input type="checkbox"/>	VLAN 1	192.168.80.77	e8:f4:08:3b:62:fd	1/0/8	Dynamic	1127	

ARP Table Operation

- Click on **"Link"** icon to make the dynamic entry as a static entry.
- Click on **"Delete"** icon to delete the static entry.
- Click on the **"Modify"** icon to modify the static entry

It's also possible to add a static ARP entry manually by clicking on the **"Add"** button, then specify the VLAN, IP Address, and MAC Address combination.

Add Static ARP

The MAC address must be an unicast one.

*VLAN

*IP Address
IPv4 format

*MAC Address
 : : : : :

Add Static ARP

Neighbor Discovery

Neighbor Discovery Protocol (NDP) is an important basic protocol in the IPv6 protocol system it replaces the ARP and ICMP router discovery of IPv4. It defines the use of ICMPv6 packets to achieve address resolution, neighbor unreachability detection, duplicate address detection, router discovery, redirection, ND proxy, and other functions.

IPv6 address auto-configuration and router discovery rely on two kinds of ICMPv6 messages: RS (Router Solicitation) and RA (Router Advertisement). Hosts send RS messages to ask routers on the same link to send RA messages right away. Routers send RA messages to let hosts know they are there and give them information like IPv6 prefixes, hop limit, MTU, and configuration flags.

To configure ND please navigate to **Web UI → IP → Neighbor Discovery**.

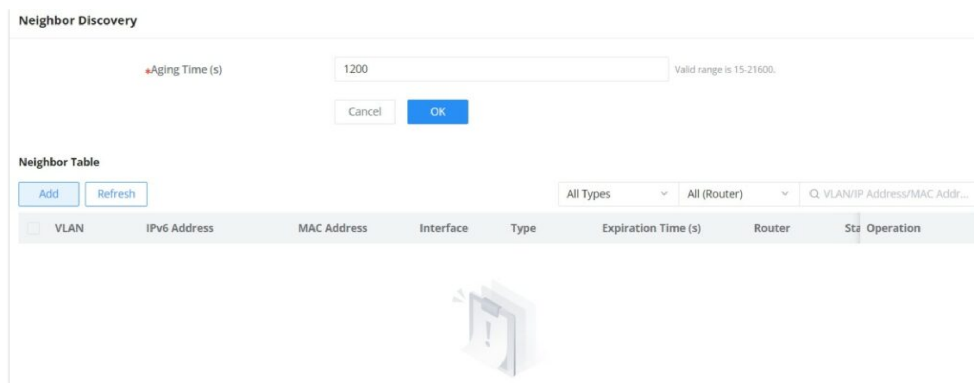

Neighbor Discovery

Aging time (seconds): Set the aging time of dynamic neighbor entries. After the aging time expires, the dynamic neighbor entry is automatically deleted. The value range is an integer from 15 to 21600, and the default is 1200 seconds.

Note:

Aging time applies only to dynamic entries.

Click on “**Refresh**” button to refresh the list for dynamic entries or click on “**Add**” button to add a static entry, refer to the figure below:

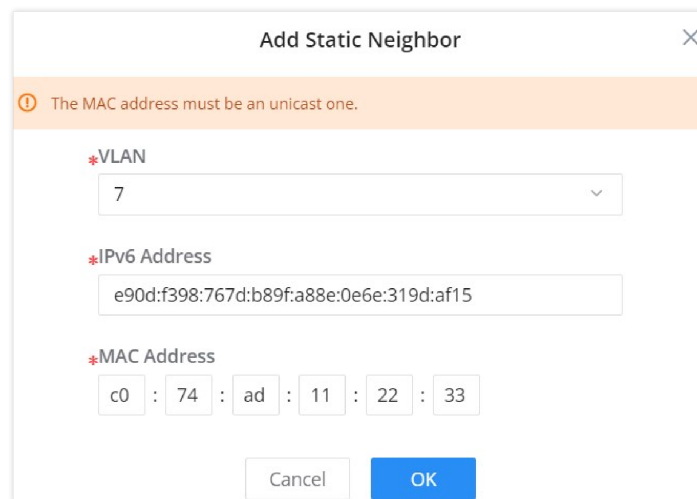

Add Static Neighbor

Select the VLAN from the drop-down list then enter the unicast IPv6 address and MAC address then click on “**OK**” button.

DNS

Domain Name System DNS provides translation services between domain names and IP addresses. GWN78xx Switches act as a DNS client. When users perform certain applications on the device (such as Telnet to a device or host), they can directly use a memorable and meaningful domain name, and resolve the domain name to the correct address through the domain name system.

DNS domain name resolution is divided into static domain name resolution and dynamic domain name resolution which can be used together when parsing domain names. If the static domain name resolution is unsuccessful, then dynamic domain name resolution will be used, since dynamic domain name resolution may take a certain amount of time and requires the cooperation of the domain name server, some commonly used domain names can be put into the static domain name resolution table, which can greatly improve the effect of domain name resolution.

Global Settings

On this page, the user can designate the switch as a DNS client to resolve DNS names to IP addresses through one or more configured DNS servers. It's enabled by default.

To configure DNS on GWN78xx switches, navigate to **Web UI** → **IP** → **DNS**, then click on the **Global Settings** tab.

DNS Global Settings

Up to 8 Domain Suffixes and 8 DNS Servers can be added. To add a Domain Suffix or DNS Server click on “+” icon and to delete click on “-” icon.

Note:

DNS servers are sorted from far to near according to the adding time, and the earliest added servers have the highest priority.

Domain Mapping Table

To add a static DNS or to view the Dynamic ones, click on the **Domain Mapping Table** tab.

Hostname	IP Address	Type	Expiration (s)	Operation
<input type="checkbox"/> grandstream.com	173.254.235.74	Static	--	
<input type="checkbox"/> pool.ntp.org	196.200.131.160	Dynamic	16	

DNS Domain Mapping Table

Click on “**Add**” button to add a new static DNS entry.

Add Static Domain

Note:

Up to 32 static domain names can be added.

The user can also select the dynamic domains and then click on “**Add as a static domain**” button or icon to make them as static ones.

MULTICAST

IP multicast is a technique for one-to-many communication over an IP infrastructure in a network. To avoid the incoming data broadcasting to all GE/LAG ports, multicast is useful to transfer the data/message to specified GE/LAG ports for IGMP snooping or MLD Snooping. When the Switch receives a message "subscribed" by the client, it must decide to transfer the data to specified GE/LAG ports according to the location of the client (subscribed member).

IGMP Snooping

As an IPv4 Layer 2 multicast protocol, IGMP snooping is the process of listening to Internet Group Management Protocol (IGMP) network traffic. The feature allows a network switch to listen in on the IGMP conversation between hosts and routers. By listening to these conversations the switch maintains a map of which links need which IP multicast streams. Multicasts may be filtered from the links which do not need them and thus controls which ports receive specific multicast traffic.

IGMP Snooping Global Settings

This page allows the user to enable/disable IGMP Snooping function, select snooping version, and enable/disable snooping report suppression also select the Multicast Forward Mode and what to do with Unknown Multicast Packet.

Note:

Unknown Multicast Packet: This option is associated with the same one MLD Snooping. Whatever option selected here will be the same as MLD Snooping and vice versa.

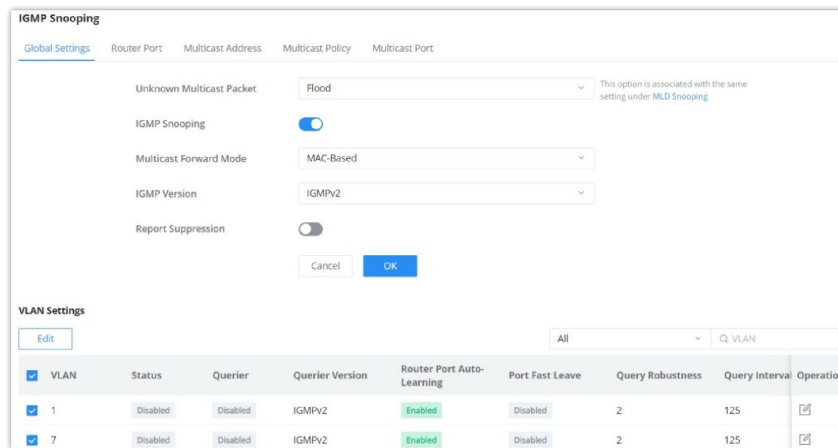

IGMP Snooping Global Settings

Unknown Multicast Packet	<p>Select an action for switch to handle with unknown multicast packet.</p> <ul style="list-style-type: none"> ● Drop: Drop the unknown multicast data. ● Flood: Flood the unknown multicast data. ● Forward to Router port: Forward the unknown multicast data to router port.
IGMP Snooping	Enable or disable Global IGMP Snooping
Multicast Forward Mode	<p>Set the Multicast Forward Mode.</p> <ul style="list-style-type: none"> ● MAC-Based: Forward using MAC address. ● IP-Based: Forward using IP address
IGMP Version	Select the IGMP Version.
Report Suppression	Enable or disable the switch to handle IGMP reports between router and host, suppressing bandwidth used by

IGMP Snooping Global Settings

The user can also Enable/Disable IGMP Snooping and IGMP Snooping Querier per VLAN and much more.

IGMP Snooping Edit VLAN

VLAN	Displays the selected VLAN
MLD Snooping	Click on the toggle button to enable MLD Snooping for the selected VLAN.
MLD Snooping Querier	Click the toggle button to enable the MLD Snooping Querier.
MLD Snooping Querier Version	Select from the drop-down list the MLD Snooping Querier Version.
Router Port Auto-Learning	Click on the toggle button to learn router port by MLD query.
Port Fast Leave	Select Enable/Disable Fast Leave feature for the desired port. <i>Note: If Fast Leave is enabled for a port, the switch will immediately remove this port from the multicast group upon receiving MLD leave messages.</i>
Query Robustness	Set a number which allows tuning for the expected packet loss on a subnet. <i>The valid range is 1-7</i>
Query Interval (s)	Set the interval of querier send general query.
Query Max Response Interval (s)	It specifies the maximum allowed time before sending a responding report. <i>Note: The valid range is 5-20 in seconds.</i>
Last Member Query Count	After querying for specified times and still not receiving any response from the subscribed member, GWN7806(P) series switches will stop transmitting data to the related GE port(s). <i>Note: The valid range is 1-7</i>
Last Member Query Interval (s)	Set The maximum time interval between counting each member query message with no responses from any subscribed member. <i>Note: The valid range is 1-25 in seconds</i>

IGMP Snooping Edit VLAN

IGMP Snooping Router Port

This page shows the IGMP querier router known to this switch. Click on "Add" to add another one or Click on "Edit" icon to modify already created one.

IGMP Snooping

Global Settings Querier Router Port Multicast Address Multicast Policy Multicast Port

Add Refresh Delete

VLAN	Static Router Port	Forbidden Port	Dynamic Port	Aging Time (s)	Operation
1	1/0/24	--	--	--	

Total 1 < 1 > 10 / page

IGMP Snooping Router Port

Router Port > Edit

VLAN 8

Static Router Port
Click on port to select/unselect

GE
 2 4 6 8
 1 3 5 7 1 2

LAG
 2 4 6 8
 1 3 5 7

Forbidden Port
Click on port to select/unselect

GE
 2 4 6 8
 1 3 5 7 1 2

Cancel OK

IGMP Snooping Router Port add or edit

IGMP Snooping Multicast Address

Dynamic multicast addresses will be listed here and the user can also add static multicast address entries based on VLAN by clicking on "Add" button or click "Edit" icon to edit.

IGMP Snooping

Global Settings Querier Router Port Multicast Address Multicast Policy Multicast Port

Add Refresh Delete

Q VLAN/Multicast Address/Member Port

VLAN	Multicast Address	Source IP Address	Member Port	Address Type	Aging Time (s)	Operation

IGMP Snooping Multicast Address page

Add IGMP Snooping Multicast Address

IGMP Snooping Multicast Policy

In this page, the user can add a Multicast Policy up to 128 Policy ID to Allow or Reject a range of Multicast Addresses.

IGMP Snooping Multicast Policy

IGMP Snooping Multicast Port

Once the Multicast Policy is created, the user is able to apply this policy on a port.

IGMP Snooping Multicast Port

MLD Snooping

MLD Snooping Global Settings

As an IPv6 Layer 2 multicast protocol, MLD Snooping maintains the outgoing port information of multicast packets by listening to the multicast protocol packets sent between Layer 3 multicast devices and user hosts, so as to manage and control multicast data . Forwarding of packets at the data link layer. When an MLD protocol packet transmitted between a host and an upstream Layer 3 device passes through a Layer 2 device, MLD Snooping analyzes the information carried in the packet, establishes and maintains a Layer 2 multicast forwarding table based on the information, and guides multicast data in the data stream.

Global Settings page give the user the ability to enable MLD Snooping as well as selecting Multicast Forward Mode etc.

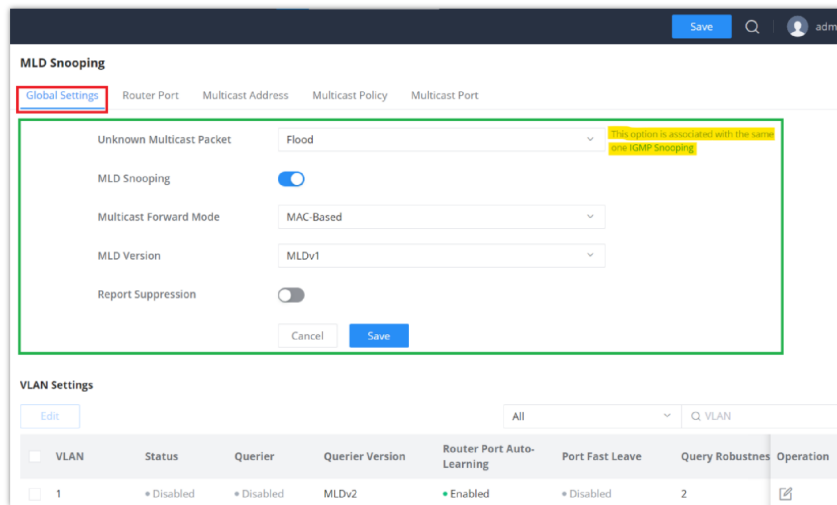

MLD Snooping Global Settings

Unknown Multicast Packet	<p>Select an action for switch to handle with unknown multicast packet.</p> <ul style="list-style-type: none"> ● Drop: Drop the unknown multicast data. ● Flood: Flood the unknown multicast data. ● Forward to Router port: Forward the unknown multicast data to router port. <p><i>Note: This option is associated with the same one IGMP Snooping.</i></p>
MLD Snooping	Enable or disable Global MLD Snooping
Multicast Forward Mode	<p>Set the Multicast Forward Mode.</p> <ul style="list-style-type: none"> ● MAC-Based: Forward using MAC address. ● IP-Based: Forward using IP address
MLD Version	Select the MLD Version.
Report Suppression	Enable or disable the switch to handle MLD reports between router and host, suppressing bandwidth used by MLD.

MLD Snooping Global Settings

Once Global MLD Snooping is enabled, then the user can enable more settings per VLAN.

Global Settings > Edit

VLAN: 1

MLD Snooping:

MLD Snooping Querier:

MLD Snooping Querier Version: MLDv2

Router Port Auto-Learning:

Port Fast Leave:

Query Robustness: 2 (The range is 1-7)

Query Interval (s): 125 (The range is 30-18000)

Query Max Response Interval (s): 10 (The range is 5-20)

Last Member Query Count: 2 (The range is 1-7)

Last Member Query Interval (s): 1 (The range is 1-25)

Cancel Save

MLD Snooping Edit VLAN

VLAN	Displays the selected VLAN
MLD Snooping	Click on the toggle button to enable MLD Snooping for the selected VLAN.
MLD Snooping Querier	Click the toggle button to enable the MLD Snooping Querier.
MLD Snooping Querier Version	Select from the drop-down list the MLD Snooping Querier Version.
Router Port Auto-Learning	Click on the toggle button to learn router port by MLD query.
Port Fast Leave	Select Enable/Disable Fast Leave feature for the desired port. <i>Note: If Fast Leave is enabled for a port, the switch will immediately remove this port from the multicast group upon receiving MLD leave messages.</i>
Query Robustness	Set a number which allows tuning for the expected packet loss on a subnet. <i>The valid range is 1-7</i>
Query Interval (s)	Set the interval of querier send general query.
Query Max Response Interval (s)	It specifies the maximum allowed time before sending a responding report. <i>Note: The valid range is 5-20 in seconds.</i>
Last Member Query Count	After quering for specified times and still not receiving any response from the subscribed member, the switch will stop transmitting data to the related GE port(s). <i>Note: The valid range is 1-7</i>
Last Member Query Interval (s)	Set The maximum time interval between counting each member query message with no responses from any subscribed member. <i>Note: The valid range is 1-25 in seconds</i>

MLD Snooping – Edit VLAN

MLD Snooping Router Port

If the router port is statically configured, the Layer 2 device will also forward the MLD report and leave message to the static router port. If a static member port is configured, the interface will be added as the outgoing interface in the forwarding table. After a Layer 2 multicast forwarding table entry is established on a Layer 2 device, when the Layer 2 device receives a multicast data packet, it searches for the forwarding table according to the VLAN to which the packet belongs and the destination

address of the packet (that is, the IPv6 multicast group address). Whether the item has the corresponding “outbound interface information”. If it exists, the packet is sent to all multicast group member ports; if it does not exist, the packet is discarded or broadcast in the VLAN.

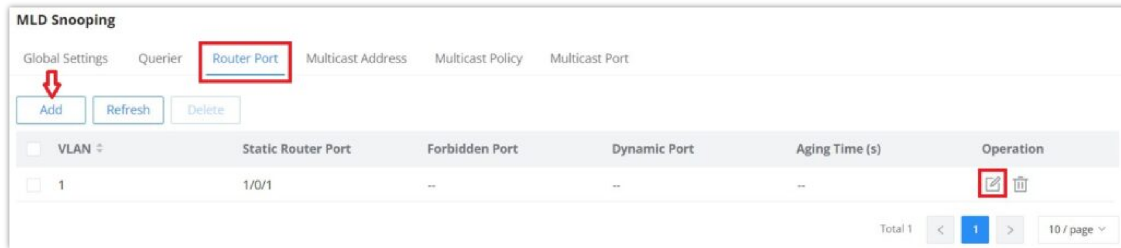

MLD Snooping Router Port page

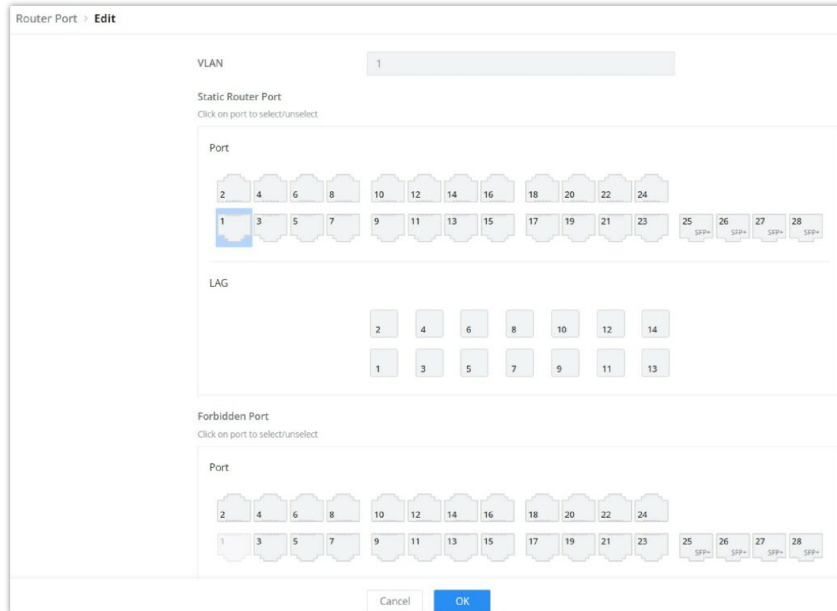

Add MLD Snooping Router Port

MLD Snooping Multicast Address

GWN78xx Switches do also support adding static multicast addresses by specifying the VLAN and member port.

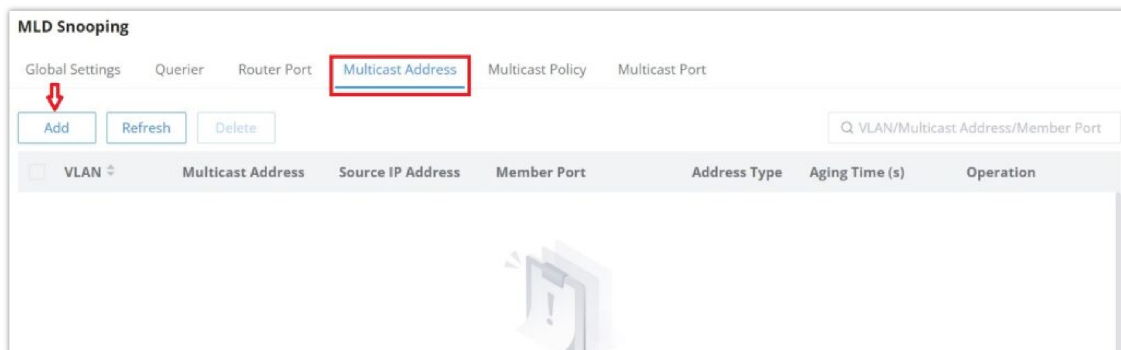

MLD Snooping Multicast Address page

Multicast Address > Edit

VLAN

Multicast Address IPv6 format

Click on port to select/unselect

Port

1 SFP+ 2 SFP+ 3 SFP+ 4 SFP+ 5 SFP+ 6 SFP+ 7 SFP+ 8 SFP+ 9 SFP+ 10 SFP+ 11 SFP+ 12 SFP+

LAG

1 2 3 4 5 6

Cancel OK

Add MLD Snooping Multicast Address

MLD Snooping Multicast Policy

Multicast Policy can be created in this page to allow or reject a range of IPv6 Multicast Addresses. Up to 128 Policy can be created.

MLD Snooping

Global Settings Querier Router Port Multicast Address Multicast Policy Multicast Port

Add Delete

Policy ID

1

Address Operation

52e:3aca:d24b:5603:7762:1380 - 0af:9449:7a70:ba96:24de:69e4

Total 1 < 1 > 10 / page

Edit

Multicast Policy ID

Action

Multicast Address IPv6 format

-

Cancel OK

MLD Snooping Multicast Policy

MLD Snooping Multicast Port

The multicast policy can be applied to the Gigabit Ethernet/LAG port, the user can also set the maximum number of multicast groups that the port is allowed to join and set the action when the port multicast exceeds the limit, the default is rejected.

MLD Snooping

Global Settings Querier Router Port Multicast Address Multicast Policy Multicast Port

Edit

Port

1/0/1 1/0/2 1/0/3 1/0/4 1/0/5 1/0/6 1/0/7 1/0/8 1/0/9 1/0/10 1/0/11 1/0/12 LAG1

Multicast Policy Operation

256 Reject 256 Reject

Edit

Port

Max Multicast Group Count Valid range is 1-256

Action

Multicast Policy

Multicast Policy ID

Cancel OK

MLD Snooping Multicast Port

ROUTING

Routing is a process in which the router selects the optimal path according to the destination address of the received data packet and forwards it to the next network node leading to the target network, and the last routing node under this path forwards the data to the target host. (Router refers to both a router in the traditional sense and an Ethernet switch running a routing protocol).

GWN78xx support IPv4 and IPv6 static routing.

Note:

Dynamic routing protocols, such as RIP, RIPng, OSPF, OSPFv3, BGP, and Route Policy, are supported only on Layer 3 models, specifically the GWN781x, GWN782x, and GWN783x series.

Routing Table

A routing table is like a map of the network that shows the best routes to each destination. It achieves this by storing information on how to reach different destinations on a network and with this table the router can decide where to forward packets that it receives from other devices.

To get to the Routing Table, please navigate to **Web UI → Routing → Routing Table**.

You can enable/disable Routing Forwarding option, which allows the switch to act as a Layer 3 device, enabling it to forward packets between different networks or VLANs based on the routing table entries.

Destination IP Address	Protocol Type	Priority	Cost	Next Hop	Outgoing Interface
0.0.0.0/0	DHCP	1	0	192.168.50.1	VLAN 1
192.168.50.0/24	Direct	0	0	0.0.0.0	VLAN 1

Routing Table

A routing table contains the following information for each entry: Destination IP address, Mask Length, Protocol Type, Priority, Next Hop, outgoing Interface and Flags.

A routing table gets populated over time with dynamic routing protocols like OSPF and RIP or static entries (manually configured by an administrator) or directly connected networks.

Static Routes

The static route is a special route that requires manual configuration by an administrator. Static routes have different purposes in different network environments:

- When the network structure is relatively simple, the network can work normally only by configuring static routes.
- In complex network environments, configuring static routes can improve network performance and ensure bandwidth for important applications, however, when the network fails or the topology changes, the static routes are not automatically updated and must be reconfigured manually.

To add a static route, please navigate to the **Web UI → Routing → Static Routes** page.

Static Routes						
IPv4 Static Routes		IPv6 Static Routes				
Add		Delete		Q Destination IP Address/Next...		
Destination IP Address	Mask Length	Priority	Next Hop	Outgoing Interface	Operation	
<input checked="" type="checkbox"/> 192.168.7.0	24	2	--	VLAN 1		
<input type="checkbox"/> 192.168.7.0	24	1	192.168.8.0	--		
<input type="checkbox"/> 192.168.80.0	24	1	192.168.7.0	--		

Static Routes

Click on "Add" button to add a new static route. then fill in the Destination IP Address with the mask length then select the next hop or the outgoing interface (VLAN) with specifying the priority.

Please refer to the figure below:

Add IPv4 Static Route

***Destination IP Address**

***Mask Length**

Valid range is 0-32.

Gateway

Next Hop Outgoing Interface

***Outgoing Interface**

***Priority**

The valid range is 1-255. The smaller the value, the higher the priority.

Add static route

Routing Information Protocol (RIP)

The **Routing Information Protocol (RIP)** is a distance-vector routing protocol used for routing data in small to medium-sized networks. This guide will walk you through configuring RIP on the GWN78xx series switch.

Note:

RIP is supported only on Layer 3 models, specifically the GWN781x, GWN782x, and GWN783x series.

RIP – Global Settings

To configure global RIP settings, navigate to **Routing → RIP → Global**.

1. **Enable RIP:** Toggle the switch to enable RIP.
2. **RIP Version:** Choose between **RIPv1** or **RIPv2**. RIPv2 is recommended for most modern networks.
3. **RIP Distance:** Set the administrative distance for RIP. The default is **120**.
4. **Timers:**
 - **Update Timer (s):** Sets the interval at which RIP updates are sent. The default is **30 seconds**.
 - **Agging Timer (s):** Determines how long a route remains valid before it is considered stale. The default is **180 seconds**.
 - **Garbage Collection Timer (s):** Defines the time to wait before deleting a stale route from the routing table. The default is **120 seconds**.

5. **External Route Import:** You can import routes from **Direct**, **Static**, and **OSPF** routes:

- **Metric of Direct Route:** Assign a metric for direct routes.
- **Metric of Static Route:** Assign a metric for static routes.
- **Metric of OSPF Route:** Assign a metric for OSPF routes.

RIP Distance: 120

Timer

- Update Timer (s): 30 (Valid range is 5-65535)
- Aging Timer (s): 180 (Valid range is 5-65535)
- Garbage Collection Timer (s): 120 (Valid range is 5-65535)

External Route Import

Route Type: Direct Static OSPF

- Metric of Direct Route: 1 (Valid range is 1-16)
- Metric of Static Route: 1 (Valid range is 1-16)
- Metric of OSPF Route: 1 (Valid range is 1-16)

Buttons: Cancel, OK

Status

```
Routing Protocol is "rip"
Sending updates every 30 seconds with +/-50%, next due in 17 seconds
Timeout after 180 seconds, garbage collect after 120 seconds
redistribute statistics add 3 del 0
Outgoing update filter list for all interface is not set
Incoming update filter list for all interface is not set
```

RIP Global Settings

Once you've made your configurations, click **OK** to apply the settings.

RIP – Interface Settings

To configure RIP on specific interfaces or VLANs, navigate to **Routing** → **RIP** → **Interface Settings**.

1. **Select the Interface:** You will see a list of VLANs or interfaces. Each interface shows its current status, IP address, RIP version, and other settings.

- To edit an interface, click on the **Edit** icon under the **Operation** column.

Interface	Status	Interface Address	RIP Tx Version	RIP Rx Version	RIPv2 Broadcast	Interface Suppression	Loop Protection	Authentication Type	Operation
<input checked="" type="checkbox"/> VLAN 1	Enabled	192.168.122.33/24	Default	Default	Disabled	Disabled	Split Horizon	Disabled	
<input type="checkbox"/> VLAN 7	Enabled	192.168.7.1/24	Default	Default	Enabled	Enabled	Split Horizon	Disabled	

Total 2 < 1 / page >

RIP Interface Settings

2. **Edit Interface:** After clicking **Edit**, a new window will appear where you can configure the following settings:

- **RIP:** Toggle RIP on or off for this interface.
- **RIP Tx Version:** Select the version of RIP for outgoing messages (**RIPv1** or **RIPv2**).
- **RIP Rx Version:** Select the version of RIP for incoming messages.
- **RIPv2 Broadcast:** Enable or disable broadcast for RIPv2.
- **Interface Suppression:** Enable or disable suppression of specific interfaces.
- **Loop Protection:** Choose between **Split Horizon** (to prevent loops by not sending updates back on the interface where they were received) or **Poison Reverse** (to mark a route as unreachable).
- **Authentication Type:** Set authentication for RIP packets to either **Disabled**, **Simple** (password-based), or **MD5** (more secure).

Interface Settings > **Edit Interface**

Interface	VLAN 1
Interface Address	192.168.122.33/24
RIP	<input checked="" type="checkbox"/>
RIP Tx Version	Default
RIP Rx Version	Default
RIPv2 Broadcast	<input type="checkbox"/>
Interface Suppression	<input type="checkbox"/>
Loop Protection	<input checked="" type="radio"/> Split Horizon <input type="radio"/> Poison Reverse
Authentication Type	<input checked="" type="radio"/> Disabled <input type="radio"/> Simple <input type="radio"/> MD5
<input type="button" value="Cancel"/> <input type="button" value="OK"/>	

RIP Edit interface

After making changes, click **OK** to save the settings.

RIP – Route Advertisement

To configure route advertisements, go to **Routing** → **RIP** → **Route Advertisement**.

RIP

Global Interface Settings **Route Advertisement** Neighbor Info

<input checked="" type="checkbox"/>	Destination Address	Mask Length	Operation
<input checked="" type="checkbox"/>	192.168.7.0	24	<input type="button" value="Delete"/>

Total 1 < 1 > 10 / page

RIP Route Advertisement

- Add a Route:** Click **Add** to enter a new route.
 - Destination Address:** Specify the destination network address that will be advertised.
 - Mask Length:** Set the subnet mask length for the destination network.
- Delete a Route:** To remove an advertised route, check the box next to the route and click **Delete**.

Route Advertisement > **Add Route Advertisement**

*Destination Address/Mask Length

192.168.7.0	/	24	<input type="button" value="Delete"/>	Mask length range 1-32
192.168.3.0	/	24	<input type="button" value="Delete"/>	

RIP Add Route Advertisement

Click **OK** to apply the changes.

RIP – Neighbor Info

Navigate to **Routing** → **RIP** → **Neighbor Info** to view detailed information about neighboring devices that are participating in the RIP protocol. This section displays:

- Interface:** The interface or VLAN participating in RIP.

- **Version:** The RIP version (RIPv1 or RIPv2).
- **Default Distance:** The default administrative distance for routes learned from neighbors.
- **Update Time:** The time of the last update from the neighbor.
- **Neighbor Address:** The IP address of the neighboring device.

Interface	Version	Default Distance	Update Time	Neighbor Address
No Data				

RIP Neighbor Info

Note:

If there are no RIP neighbors configured or detected, this section will display “No Data.”

Routing Information Protocol Next Generation (RIPng)

Just like **RIP**, **RIPng (RIP Next Generation)** is a distance-vector routing protocol, but it’s specifically designed for IPv6 networks. This section will guide you through configuring **RIPng** on the GWN78xx series switch.

Note:

RIPng is supported only on Layer 3 models, specifically the GWN781x, GWN782x, and GWN783x series.

RIPng – Global Settings

To configure the global settings for RIPng, navigate to **Routing** → **RIPng** → **Global**.

1. **Enable RIPng:** Toggle the switch to enable RIPng.
2. **RIPng Distance:** Set the administrative distance for RIPng routes. The default is **120**.
3. **Timers:**
 - **Update Timer (s):** Sets the interval at which RIPng updates are sent. The default is **30 seconds**.
 - **Agging Timer (s):** Determines how long a route remains valid before it is considered stale. The default is **180 seconds**.
 - **Garbage Collection Timer (s):** The interval before deleting a stale route from the routing table. The default is **120 seconds**.
4. **External Route Import:** You can import routes from **Direct**, **Static**, and **OSPFv3** routes:
 - **Metric of Direct Route:** Assign a metric for direct routes.
 - **Metric of Static Route:** Assign a metric for static routes.
 - **Metric of OSPFv3 Route:** Assign a metric for OSPFv3 routes.

RIPng Global settings

After making these configurations, click **OK** to apply the settings.

RIPng – Interface Settings

To configure **RIPng** on specific interfaces or VLANs, navigate to **Routing** → **RIPng** → **Interface Settings**.

1. **Select the Interface:** You will see a list of VLANs or interfaces. Each interface shows its current status, interface address, and settings.
 - o To edit an interface, click the **Edit** icon under the **Operation** column.

Interface	Status	Interface Address	Interface Suppression	Loop Protection	Operation
<input checked="" type="checkbox"/> VLAN 1	Enabled	2408:8640:8fe:f3:ee74:d7ff:fe3d:90a4/64 fe80::ee74:d7ff:fe3d:90a4	Enabled	Split Horizon	
<input type="checkbox"/> VLAN 7	Disabled	--	Disabled	Split Horizon	

RIPng Interface Settings

1. **Edit Interface:** After clicking **Edit**, a new window will appear, allowing you to configure:
 - o **RIPng:** Toggle to enable RIPng on this interface.
 - o **Interface Suppression:** Enable or disable suppression of RIPng advertisements on the interface.
 - o **Loop Protection:** Select **Split Horizon** or **Poison Reverse:**
 - o **Split Horizon:** Prevents a router from sending routing information back on the interface from which it was received. This is useful to prevent routing loops.
 - o **Poison Reverse:** Marks a route as unreachable when it's learned from a neighbor, which helps eliminate loops.

Explanation: **Split Horizon** is a simple technique to prevent loops by not advertising a route back to the neighbor that originally sent it. **Poison Reverse** takes this further by actively marking routes from the same source as unreachable, providing more robust loop prevention.

Interface Settings > **Edit Interface**

Interface	VLAN 1
Interface Address	2408:8640:8fe:f3:ee74:d7ff:fe3d:90a4/64 fe80::ee74:d7ff:fe3d:90a4
RIPng	<input checked="" type="checkbox"/>
Interface Suppression	<input checked="" type="checkbox"/>
Loop Protection	<input checked="" type="radio"/> Split Horizon <input type="radio"/> Poison Reverse

Cancel OK

RIPng Edit interface

After making changes, click **OK** to save the settings.

RIPng – Route Advertisement

To configure route advertisements, go to **Routing** → **RIPng** → **Route Advertisement**.

RIPng

Global Interface Settings Route Advertisement Neighbor Info

Add Delete

<input checked="" type="checkbox"/>	Destination IPv6 Address	Prefix Length	Operation
<input checked="" type="checkbox"/>	2001:db8:abcd:12::	64	

Total 1 < 1 > 10 / page

RIPng Route Advertisement

- Add a Route:** Click **Add** to create a new route.
 - Destination IPv6 Address:** Specify the destination IPv6 network.
 - Prefix Length:** Set the prefix length for the IPv6 network (e.g., /64).
- Delete a Route:** To remove an advertised route, check the box next to the route and click **Delete**.

Route Advertisement > **Add Route Advertisement**

*Destination IPv6 Address/Prefix 2001:db8:abcd:12:: / 64 Prefix range 1-128

Add

Cancel OK

RIPng Add Route Advertisement

Click **OK** to apply the changes.

RIPng – Neighbor Info

Navigate to **Routing** → **RIPng** → **Neighbor Info** to view detailed information about neighboring devices participating in RIPng routing. This section displays:

- Interface:** The interface or VLAN participating in RIPng.
- Version:** The RIPng version.
- Default Distance:** The administrative distance for routes learned from neighbors.
- Update Time:** The time of the last update from the neighbor.
- Neighbor Address:** The IPv6 address of the neighboring device.

Note:

If no RIPng neighbors are detected, this section will display "No Data."

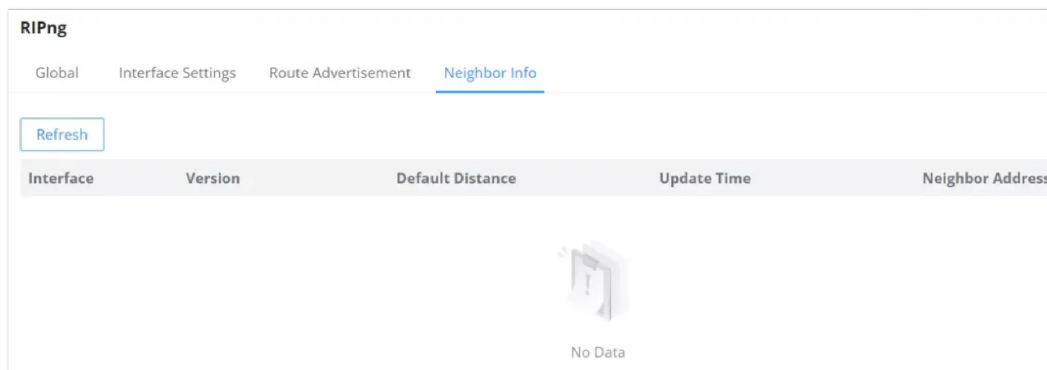

RIPng Neighbor Info

OSPF (Open Shortest Path First)

OSPF stands for Open Shortest Path First, it's a routing protocol and uses a link state routing algorithm, in other words it collects information about the state of each link in the network to build an overall map about the whole network topology. OSPF is an interior gateway protocol (IGP) same as RIP (Routing Information Protocol), it's a protocol based on distance vector algorithms. OSPF has many advantages over other routing protocols, such as RIP.

Some Advantages of OSPF protocol:

- OSPF can perform route summarization, which reduces the size of the routing table and improves scalability.
- OSPF supports IPv4 and IPv6.
- OSPF can split the network into areas, which are logical groups of routers that share the same link state information. This reduces the amount of routing information that needs to be exchanged and processed by each router.
- OSPF can use authentication to secure the exchange of routing information between routers.
- OSPF can deal with variable length subnet masks (VLSM), which allows for more efficient use of IP addresses and network design.

In this example, we will be using two GWN78xx switches directly connected (neighbors) and a router serving as a DHCP server. Please refer to the figure below:

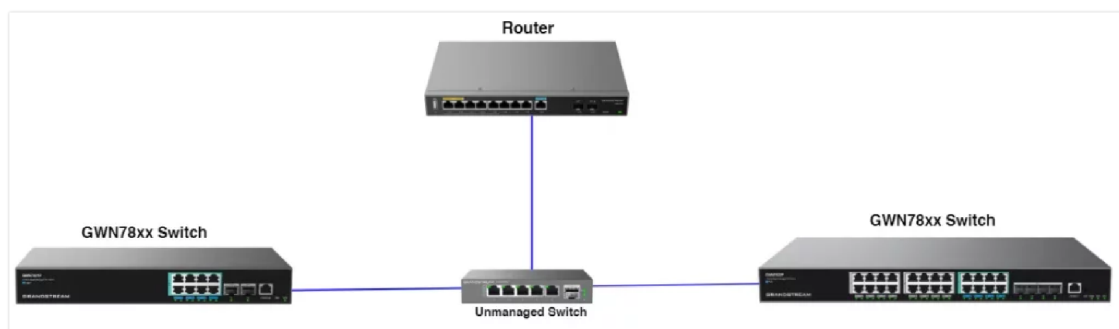

Example Two GWN78xx Switches

Note:

OSPF is supported only on Layer 3 models, specifically the GWN781x, GWN782x, and GWN783x series.

OSPF Global

To start using OSPF, please navigate to **Web UI** → **Routing** → **OSPF page** → **Global tab**:

Toggle ON OSPF and enter the Router ID (it can be any IPv4 address) then scroll down to the bottom of the page and click the "OK" button, please refer to the figure below:

Note:

If adjacency relationship has been established, OSPF process needs to be rebooted for the router ID to take effect. Caution: this action will invalidate OSPF routing and result in recalculation. Please use with caution.

The screenshot shows the OSPF Global configuration page. It includes tabs for Global, Area Settings, Interface Settings, NBMA Neighbor, Neighbor Info, and Database Info. The Global tab is active. Settings include: OSPF (checked), Router ID (192.168.80.211), Support RFC1583 (unchecked), Opaque LSA (unchecked), Advertise Maximum Metric (unchecked), Always Advertise Default Route (unchecked), Route Metric (unchecked), SPF Timer (Waiting Interval: 0, Minimum Interval: 50, Maximum Interval: 5000), and LSA Parameters (Transmission Delay: 5000).

OSPF Global

OSPF Area Settings

The Area Settings tab allows you to configure different OSPF areas. An OSPF area is a logical grouping of routers that exchange OSPF information.

Area ID	Area Type	No Summary	Conversion Type	Operation
0.0.0.0	None	Disabled	--	
2.2.2.2	Stub	Disabled	--	

OSPF Area Settings

To edit an Area Settings, click on the "Edit" button.

- o **Area ID:** The unique identifier for the OSPF area. Area 0.0.0.0 is the backbone area and must be configured in every OSPF network.
- o **Area Type:** Defines the type of the area. OSPF supports different area types, including:
 - o **None:** A normal OSPF area that supports all OSPF features.
 - o **Stub Area:** This does not allow external routes to be advertised into the area, reducing the size of the routing table.
 - o **Not-So-Stubby Area (NSSA):** Allows limited external routes, typically from an ASBR (Autonomous System Boundary Router) within the area.
- o **No Summary:** (only for Stub and NSSA) disables the summarization of routes, forcing the router to advertise specific routes rather than aggregated routes. This may be useful in certain network designs where precise routing information is required.

Area Settings > **Edit Area**

Area ID: 2.2.2.2

Area Type: None Stub NSSA

Cancel OK











OSPF Edit Area Settings

OSPF Interface Settings

On the Interface Settings tab, click on the **"Edit"** icon to enable the [VLAN IP Interface](#).

OSPF

Global Area Settings Interface Settings NBMA Neighbor Neighbor Info Database Info

Interface	Status	Interface Address	Area ID	Network Type	Interface Suppression	Ignore MTU Validation	LS In	Operation
VLAN 1	Enabled	192.168.80.211/24	0.0.0.0	Broadcast	Disabled	Disabled	5	 
VLAN 7	Enabled	70.0.0.1/24	0.0.0.0	Broadcast	Disabled	Disabled	5	 
VLAN 10	Enabled	10.0.0.1/8	0.0.0.0	Broadcast	Disabled	Disabled	5	 
VLAN 20	Enabled	20.0.0.1/24	0.0.0.0	Broadcast	Disabled	Disabled	5	 
VLAN 90	Enabled	90.0.0.1/24	0.0.0.0	Broadcast	Disabled	Disabled	5	 

OSPF Interface Settings

Toggle ON the OSPF on the selected interface then scroll down and click on the **"OK"** button.

Interface Settings > **Edit Interface**

Interface: VLAN 10

Interface Address: 10.0.0.1/24

OSPF:

Area ID: 0.0.0.0 Must be in IPv4 format or within range 0-4294967295

Network Type: Broadcast

Interface Suppression:

Ignore MTU Validation:

LSA Retransmission Interval (s): 5 Valid range is 3-65535

LSA Transmission Delay (s): 1 Valid range is 1-500

Fast Hello:

Hello Interval (s): 10 Valid range is 1-65535

Neighbor Expiration Interval (s): 40 Valid range is 1-65535

OSPF Interface Settings Edit Interface

OSPF NBMA Neighbor

In Non-Broadcast Multi-Access (NBMA) networks, OSPF cannot automatically discover neighbors as it does in broadcast networks. Therefore, you must manually configure the neighbors.

- o **Neighbor:** The IP address of the neighbor OSPF router that you want to manually add.
- o **Hello Interval (s):** The time interval between sending hello packets to this neighbor.
- o **Priority:** The priority assigned to the neighbor. This value influences the selection of the Designated Router (DR) and Backup Designated Router (BDR).
- o **Interface Address:** The local IP address of the interface that will communicate with the neighbor.

Click on the **"Add"** button to add a neighbor.

OSPF

Global Area Settings Interface Settings **NBMA Neighbor** Neighbor Info Database Info

Add

Neighbor	Hello Interval (s)	Priority	Interface Address	Operation
----------	--------------------	----------	-------------------	-----------

OSPF Neighbor Info

Then specify the Neighbor IP address (IPv4 format).

NBMA Neighbor > Add Neighbor

*Neighbor IPv4 format

*Hello Interval (s) Valid range is 1-65535

*Priority Valid range is 0-255

OSPF Neighbor Info Add neighbor

OSPF Neighbor Info

Please do the same steps on the second switch, then on the **Neighbor Info tab**, click on the **refresh** button for the adjacent (directly connected) switches to appear.

OSPF

Global Area Settings Interface Settings NBMA Neighbor **Neighbor Info** Database Info

Refresh

Neighbor ID	Priority	Status	Dead Time	Neighbor Address	Interface Address	Up Time	Operation
192.168.80.116	1	Full/DR	39.660s	192.168.80.116	vlan1:192.168.80.211	0000:00:35:12	<input type="button" value="Refresh"/>

OSPF Neighbor Info

Navigate to the Routing table **Web UI → Routing → Routing table** to confirm that the routing table contains routes to the previously created VLAN IP Interfaces on the other switch. Please refer to the figure below:

Routing Table

IPv4 Routing Table IPv6 Routing Table

Refresh All Types

Destination IP Address	Mask Length	Protocol Type	Priority	Next Hop	Outgoing Interface	Flags
0.0.0.0	0	DHCP	1	192.168.80.1	VLAN 1	SFA
192.168.80.0	24	Direct	0	0.0.0.0	VLAN 1	SFA
192.168.7.0	24	Static	1	0.0.0.0	VLAN 1	SFA
90.0.0.0	24	OSPF	110	192.168.80.211	VLAN 1	SFA
80.0.0.0	16	Static	1	0.0.0.0	VLAN 1	SFA
70.0.0.0	24	OSPF	110	192.168.80.211	VLAN 1	SFA
50.0.0.0	24	OSPF	110	192.168.80.211	VLAN 1	SFA
20.0.0.0	24	OSPF	110	192.168.80.211	VLAN 1	SFA
10.0.0.0	8	OSPF	110	192.168.80.211	VLAN 1	SFA

IPv4 Routing Table

OSPF Database Info

To check the **LSDB** (Link State DataBase), click on the **Database Info tab**, select the type (database) then click on the **Query** Button to see the Database info which is a list of all **LSA** (Link State Advertisements) that the OSPF routers use to get information about other routers running OSPF protocol and that is what helps to populate the routing table for the best route

to each destination.

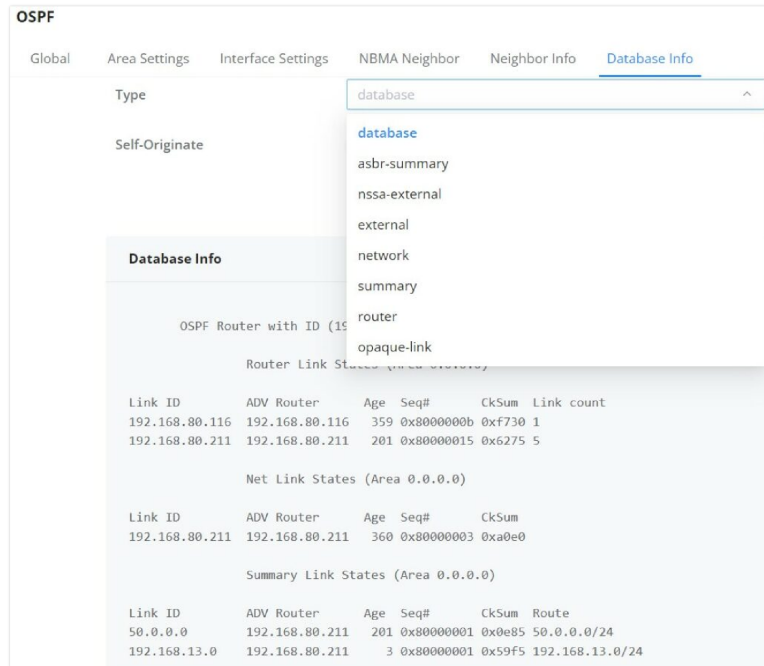

OSPF Database Info

OSPFv3

Building upon [OSPF](#), OSPFv3 (Open Shortest Path First Version 3) is specifically designed for IPv6 networks. While it shares many principles with OSPFv2, OSPFv3 introduces enhancements to accommodate IPv6 addressing and security features.

Key differences and advantages of OSPFv3 over OSPFv2:

- **IPv6 Support:** OSPFv3 is designed to support IPv6 natively, allowing for seamless integration into modern IPv6 networks.
- **Authentication:** OSPFv3 uses IPsec for authentication, providing enhanced security over OSPFv2, which uses built-in authentication methods like MD5.
- **Address Family Separation:** OSPFv3 separates the routing logic from the addressing, allowing for easier extension and support for multiple address families.
- **Link-State Advertisements (LSAs):** Introduces new LSAs to support IPv6 prefixes efficiently.

In this example, we will use two GWN78xx switches directly connected (neighbors) and a router serving as a DHCP server. Please refer to the figure below:

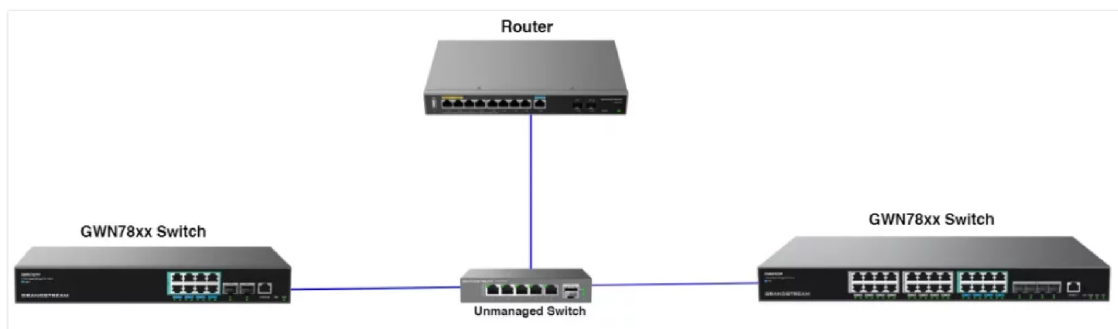

Example two GWN78xx Switches

Note:

OSPFv3 is supported only on Layer 3 models, specifically the GWN781x, GWN782x, and GWN783x series.

To start using OSPFv3, please navigate to **Web UI** → **Routing** → **OSPFv3**:

OSPFv3 Global

Toggle ON OSPFv3 and enter the Router ID (it can be any IPv4 address). Configure the SPF calculation intervals and LSA parameters as needed. Click the **“OK”** button to save the settings. Refer to the figure below:

Note:

If an adjacency relationship has been established, the OSPFv3 process needs to be rebooted for the Router ID to take effect. Caution: this action will invalidate OSPFv3 routing and result in recalculation. Please use with caution.

OSPFv3 Global Configuration

OSPFv3 Area Settings

On the Area Settings tab, click the **“Edit”** icon to add and configure areas by specifying the Area ID and Area Type.

Area ID	Area Type	No Summary	Operation
0.0.0.0	None	Disabled	
1.1.1.1	None	Disabled	

Total 2 < 1 > 10 / page v

OSPFv3 Area Settings

OSPFv3 Interface Settings

In the Interface Settings tab, click the **“Edit”** icon to enable the [VLAN IP Interface](#).

Interface	Status	Interface Address	Area ID	Network Type	Interface Suppression	MTU	Ignore MTU Valid	Operation
VLAN 1	Enabled	fe80::c274:adff:fedf:cc94	1.1.1.1	Broadcast	Disabled	1500	Disabled	
VLAN 7	Enabled	fe80::c274:adff:fedf:cc94	0.0.0.0	Broadcast	Disabled	1500	Disabled	

Total 2 < 1 > 10 / page v

OSPFv3 Interface Settings Edit Interface

Toggle ON OSPFv3 on the selected interface, then scroll down and click on the **“OK”** button.

Do the same steps on the second switch, then on the **Neighbor Info** tab, click on the **“Refresh”** button for the adjacent (directly connected) switches to appear.

Neighbor ID	Priority	Status	Dead Time	Neighbor Address	Interface Address	Up Time	Operation
No Data							

OSPFv3 Neighbor Info

OSPFv3 Database Info

To check the **LSDB** (Link State DataBase), click on the **Database Info** tab, select the type (database), then click on the **“Query”** Button to see the Database info, which is a list of all **LSAs** (Link State Advertisements) that the OSPFv3 routers use to get information about other routers running OSPFv3 protocol. This helps to populate the routing table for the best route to each destination.

Type	Self-Originate	Area Scoped Link State Database (Area 1.1.1.1)	I/F Scoped Link State Database (I/F vln7 in Area 0.0.0.0)	I/F Scoped Link State Database (I/F vln1 in Area 1.1.1.1)	AS Scoped Link State Database
Type	LSId	AdvRouter	Age	SeqNum	Payload
Area Scoped Link State Database (Area 1.1.1.1)					
Type	LSId	AdvRouter	Age	SeqNum	Payload
I/F Scoped Link State Database (I/F vln7 in Area 0.0.0.0)					
Type	LSId	AdvRouter	Age	SeqNum	Payload
I/F Scoped Link State Database (I/F vln1 in Area 1.1.1.1)					
Type	LSId	AdvRouter	Age	SeqNum	Payload
Lnk	0.0.0.3	1.1.1.1	1214	80000003	fe80::c274:adff:fedf:cc94
AS Scoped Link State Database					
Type	LSId	AdvRouter	Age	SeqNum	Payload

OSPFv3 Database Info

BGP

Border Gateway Protocol (BGP) is a path-vector routing protocol used to exchange routing information between different networks, or **Autonomous Systems (AS)**, across the internet. BGP is known as the protocol that powers the internet because it manages how packets are routed across large-scale, complex networks. It allows organizations to route traffic efficiently and ensures that data reaches its destination by selecting the most appropriate path.

Key Features of BGP:

- **Scalability:** BGP is capable of managing vast networks by sharing routing information across different autonomous systems.
- **Policy-based Routing:** BGP allows administrators to define policies and rules to control how routing decisions are made.
- **Redundancy:** BGP can provide multiple routes to the same destination, ensuring high availability.

BGP operates between routers within an **Autonomous System (Internal BGP or IBGP)** and between routers across different Autonomous Systems (**External BGP or EBGP**). BGP routers exchange routing information, which is used to build the routing tables that direct traffic between networks.

Note:

BGP is supported only on Layer 3 models, specifically the GWN781x, GWN782x, and GWN783x series.

BGP – Global Settings

The **Global Settings** tab in BGP allows you to configure key parameters that control how the BGP process operates on the router. These settings include defining your **Autonomous System (AS) Number**, **Router ID**, and preferences for route selection and stability.

In the **Global Settings**, you can:

- Set your **AS Number (AS ID)**, which identifies your network in BGP routing.
- Specify the **Router ID**, a unique identifier for the BGP router.
- Configure **Local Preference** to control route selection within your Autonomous System.
- Enable **Route Dampening** to stabilize the routing table by reducing the impact of route flapping.

For further details on how to configure each of these fields, please refer to the figure and table below.

BGP Global Settings

Field	Description	Example or Recommended Setting
BGP	Enables or disables BGP on the router.	Enabled
AS ID	Autonomous System (AS) number identifying your network.	Example: 65001
Router ID	Unique identifier for the router (typically an IP address).	Example: 10.0.0.1
Local Preference	Used to prefer one path over another within your AS. Higher values are preferred. If a BGP device obtains multiple routes with the same destination address but different next hops through different IBGP peers, the route with the higher local preference attribute value is preferred. Note: The local preference attribute is only valid between IBGP peers and is not advertised to other ASs.	Recommended: 100
Compare Router IDs	Compares router IDs when making routing decisions.	Enabled
Route Dampening	Stabilizes the network by reducing route flapping.	Enabled
Half-life (Min)	The time after which the penalty for route flapping is halved.	15 (default)

Reuse Threshold	The threshold at which a suppressed route can be reused.	750 (default)
Suppress Threshold	The penalty threshold at which a route is suppressed.	2000 (default)
Suppress Time (Min)	The time a route remains suppressed due to flapping.	60 (default)
AS_Path Attributes		
Ignore AS Path Attribute	Ignores the AS Path attribute when making routing decisions.	Enabled
Check First AS	Ensures BGP checks the first AS in the path for validation.	Enabled

BGP – Global Settings

BGP – Peer Settings

The **Peer Settings** tab allows you to configure peers for exchanging routing information with other BGP devices. These peers are critical for establishing communication between routers and sharing routing tables.

Navigate to **Routing** → **BGP** → **Peer Settings**, select **IPv4 Peer** or **IPv6 Peer** depending on your network configuration, and click **Add** to configure a new peer. In this tab, you can add, edit, or remove peers.

For detailed explanations of each field, refer to the figure and table below.

BGP Add peer

Field	Description
IPv4 Address	Enter the IPv4 address of the BGP peer you are establishing a connection with. (Example: 192.168.1.2)
AS ID	Enter the Autonomous System (AS) number of the peer. This is a unique identifier for a group of networks under a single administration. (Example: 65002)
Interface	Select the interface (VLAN or Loopback) through which the BGP session will be established. (Example: VLAN 1)

Description	Optional field to describe the peer for identification purposes. (Example: Peer with ISP Router 1)
TTL Related	Select EBGH Maximum Hop for general EBGH connections or GTSM Hops for scenarios requiring security against certain types of attacks. (Default: EBGH Maximum Hop)
EBGH Maximum Hop	Set the maximum number of hops allowed for EBGH neighbors. (Valid range: 1-255) (Example: 1)
Message Suppression	When enabled, prevents BGP updates from being sent to the peer. Useful for maintenance scenarios. (Default: Disabled)
Shutdown Session	Enables or disables the BGP session. When enabled, no updates are exchanged with the peer. (Default: Disabled)
Update Packet Timer (s)	Configures the interval for sending BGP update packets in seconds. (Valid range: 0-600) (Default: Disabled)
MD5	Enable MD5 authentication for the peer. It is recommended for securing the BGP session.
Secret	The MD5 key used for authentication with the peer. (Example: a password or shared secret, 1-64 characters long)
Keepalive Interval (s)	Time interval in seconds for sending keepalive messages to ensure the peer is active. Note: If the keepalive interval is higher than the hold interval, the session will fail. (Valid range: 1-21845) (Default: 60)
Hold Interval (s)	Time interval in seconds before the BGP session is terminated if no keepalive or update message is received from the peer. (Valid range: 3-65535) (Default: 180)
Connect Retry Interval (s)	Time interval in seconds to wait before retrying a connection if the BGP session fails. (Valid range: 1-65535) (Default: 120)

BGP – Add peer

BGP – Address Family Settings

The **Address Family Settings** tab allows you to configure routing for different address families (IPv4 and IPv6). You can aggregate routes or import routes using various routing protocols (RIP, OSPF, etc.). These configurations determine how the switch handles route advertisements and ensures efficient network communication.

Navigate to **Routing → BGP → Address Family Settings**. In this tab, users can select between **IPv4 Unicast Routing** and **IPv6 Unicast Routing**. You can also configure **Route Aggregation** and **Import Route** options to optimize routing policies.

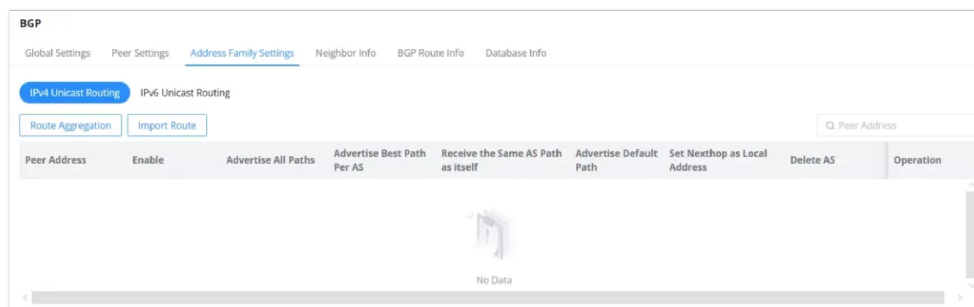

BGP Address Family Settings

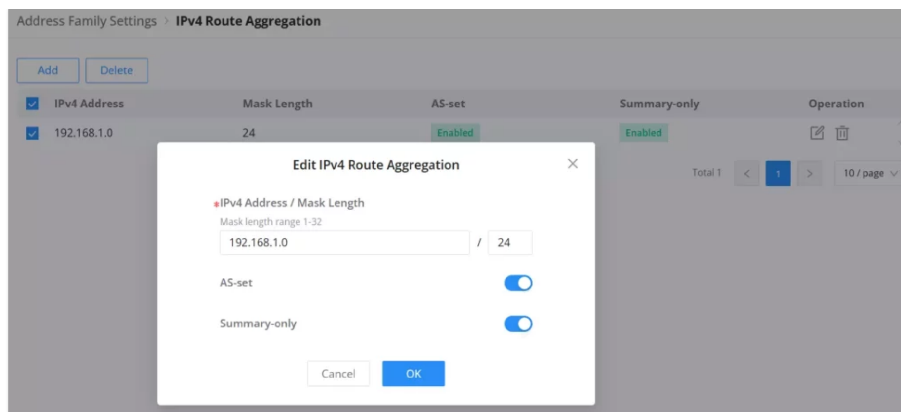

BGP Address Family Settings route aggregation

1. Click on **Route Aggregation**, then click **Add**.

2. Enter the following fields:

- **IPv4 Address / Mask Length:** Specify the IPv4 address and subnet mask length for the route to be aggregated. For example, `192.168.1.0/24` where `24` represents the subnet mask.
 - **Explanation:** Route aggregation allows the BGP router to represent multiple smaller networks as a single larger network to other BGP peers. This reduces the size of routing tables.
- **AS-set:** Toggle this option if you want to aggregate the AS numbers from the original routes.
 - **Explanation:** The **AS-set** option preserves the Autonomous Systems (AS) numbers from all the aggregated routes. This is helpful when you want to show all the AS paths through which the aggregated routes have passed.
- **Summary-only:** Toggle this option to advertise only the summary route (without advertising the more specific routes).
 - **Explanation:** The **Summary-only** option ensures that only the aggregate route is advertised to the BGP peers, and the more specific routes are hidden. This helps simplify the routing information shared with other peers.

3. Click **OK** to confirm and add the route aggregation.

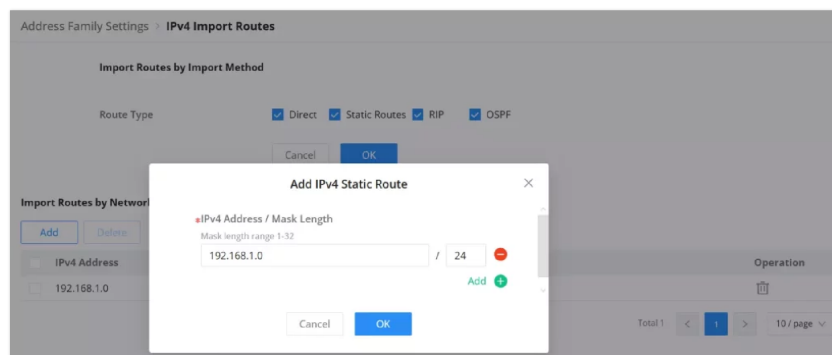

BGP Address Family Setting import routes

The **IPv4 Import Routes** section in the **Address Family Settings** allows you to import static routes, RIP, and OSPF routes into BGP. This is useful when you want to redistribute routes learned from other routing protocols or static routes into the BGP routing process.

To configure:

1. **Navigate to** Routing → BGP → Address Family Settings → Import Route.
2. **Select** the route types you want to import (Direct, Static Routes, RIP, OSPF).
3. **Click on Add** to specify a new route to be imported.
4. **Enter the IPv4 Address / Mask Length** for the static route. Example: `192.168.1.0/24`.
5. **Click OK** to confirm and import the route into BGP.

This ensures that the specified routes from other protocols are redistributed within the BGP routing domain.

BGP – Neighbor Info

The **Neighbor Info** tab in BGP provides details about established BGP peers and their status. You can view information such as the neighbor's IP address, BGP version, AS ID, received and sent messages, and the current state of communication between your device and its BGP peers.

To view BGP Neighbor Information:

1. **Navigate to** Routing → BGP → Neighbour Info.
2. **Select** either IPv4 or IPv6 Neighbor Info depending on the type of peer you have configured.
3. **Click Refresh** to update the list of BGP neighbors and view their details.

This section helps you monitor and troubleshoot BGP connections by showing real-time updates on message exchanges with BGP peers.

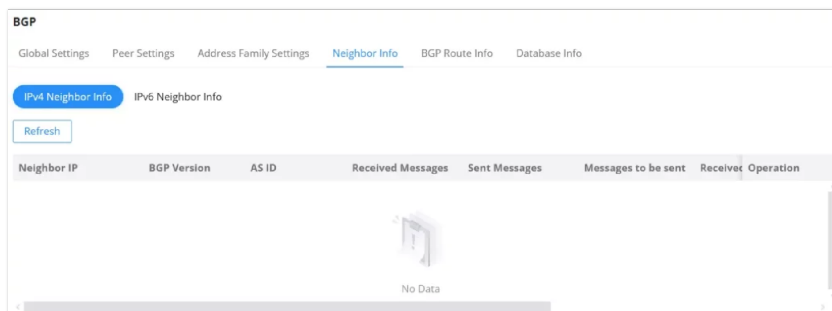

BGP Neighbor info

BGP – Route Info

The **BGP Route Info** tab displays detailed information about the routes that the BGP process has learned and is using. This information includes the network addresses, next hop addresses, and various metrics used to determine the best path for routing traffic.

To view BGP route information:

1. **Navigate to** Routing → BGP → BGP Route Info.
2. **Select** either IPv4 or IPv6 BGP Route Info depending on your routing configuration.
3. **Click Refresh** to update and display the current routing table.

The table provides important details like:

- o **Network:** The destination network address.
- o **Next Hop:** The next-hop IP address for the route.
- o **Metric:** A value that BGP uses to compare different paths.
- o **Weight and Path:** These values help in determining the best available path for routing.

This tab is crucial for network administrators to monitor how routes are advertised, selected, and updated within the BGP environment.

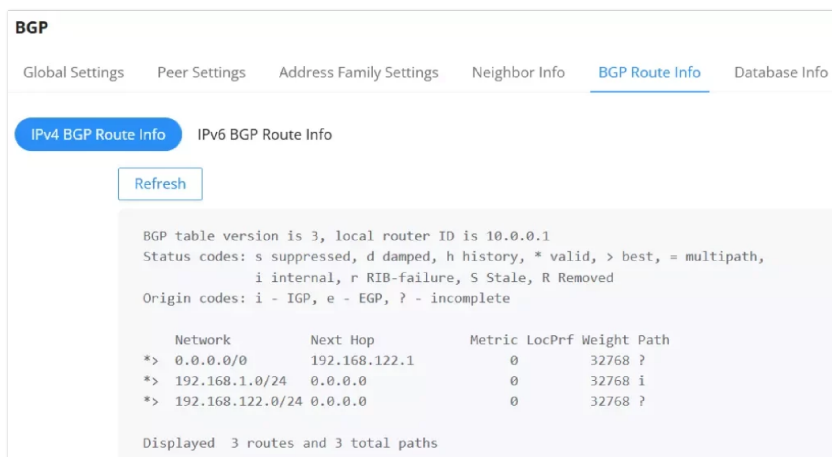

BGP – Database Info

The **BGP Database Info** tab provides detailed statistics and information about BGP neighbors, routes, and various metrics associated with BGP's operation.

To view BGP Database Information:

1. **Navigate to** Routing → BGP → Database Info.
2. **Select a Type** from the drop-down menu. The options include:
 - **dampening-parameters:** View information about dampening parameters used in BGP.
 - **dampening-paths:** View the paths that are dampened.
 - **dampening-flap-statistics:** View flap statistics to monitor route stability.
 - **nexthop-detail:** Get details about the next hop.
 - **advertised-routes:** View the routes advertised to other neighbors.
 - **prefix-counts:** See a count of prefixes.
 - **flap-statistics:** Additional route stability statistics.
 - **detail:** General details about the selected IP address.
3. **Enter the IP Address** of the neighbor for which you want to see the database information.
4. **Click OK** to view the detailed information related to the selected type.

This tab is useful for in-depth BGP troubleshooting and monitoring, providing granular data on BGP operations and neighbors.

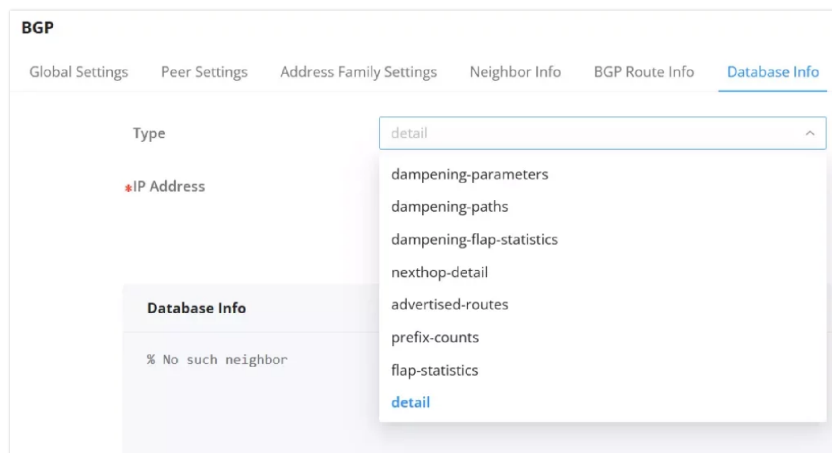

BGP Database Info

Route Policy

The **Route Policy** section is used to manage and apply filtering rules based on IPv4 and IPv6 Access Lists or Prefix Lists. BGP uses these rules to filter which routes are advertised or received from peers. This is essential for controlling routing behavior and ensuring only specific routes are allowed or denied according to network policies.

Note:

Route Policy is supported only on Layer 3 models, specifically the GWN781x, GWN782x, and GWN783x series.

Based on IPv4 Access List

The **IPv4 Access List** option allows users to create rules that filter routes by permitting specific routes based on the IPv4 address and mask length. These rules help to control which routes are advertised or received from BGP peers.

Example Configuration:

- **Name:** `Allow-Routes-OfficeNetwork`
- **Match Pattern:** **Allow** (permits the specified routes).
- **IPv4 Address/Mask Length:** `192.168.1.0/24`

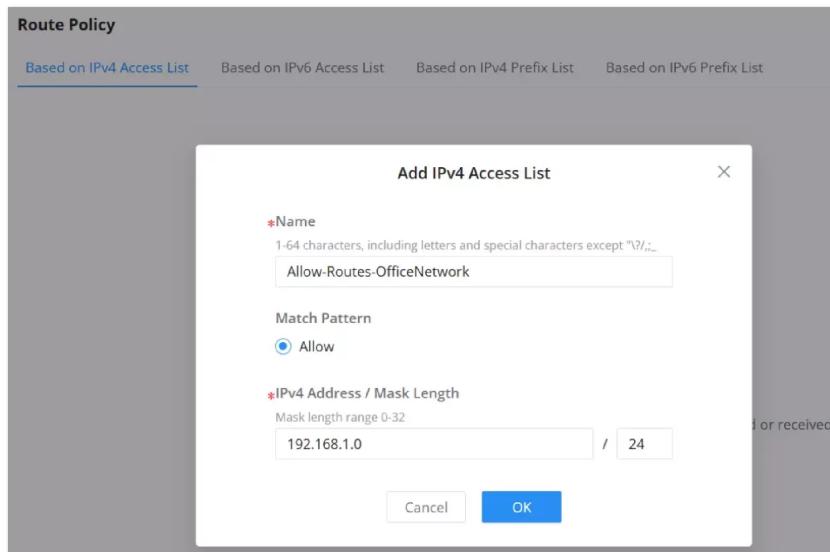

BGP Based on IPv4 Access List

This configuration allows routes from the `192.168.1.0/24` network to be advertised or received by the BGP peer.

To configure:

1. Navigate to **Routing** → **Route Policy** → **Based on IPv4 Access List**.
2. Click **Add**.
3. Specify the rule name (e.g., **Allow-Routes-OfficeNetwork**).
4. Choose the **Allow** match pattern.
5. Enter the **IPv4 Address/Mask Length**.
6. Click **OK** to save.

Based on IPv6 Access List

The **Based on IPv6 Access List** section is used to create filtering rules that allow specific IPv6 routes to be advertised or received by BGP peers. This feature is useful for controlling the flow of IPv6 routing information in a network.

To configure an IPv6 Access List:

1. Navigate to **Routing** → **Route Policy** → **Based on IPv6 Access List**.
2. Click **Add**.
3. Enter a **Name** for the rule (e.g., **Allow-Routes-IPv6OfficeNetwork**).
4. Select the **Allow** match pattern (only available option).
5. Enter the **IPv6 Address/Prefix Length** for the routes you want to match.
6. Click **OK** to save the rule.

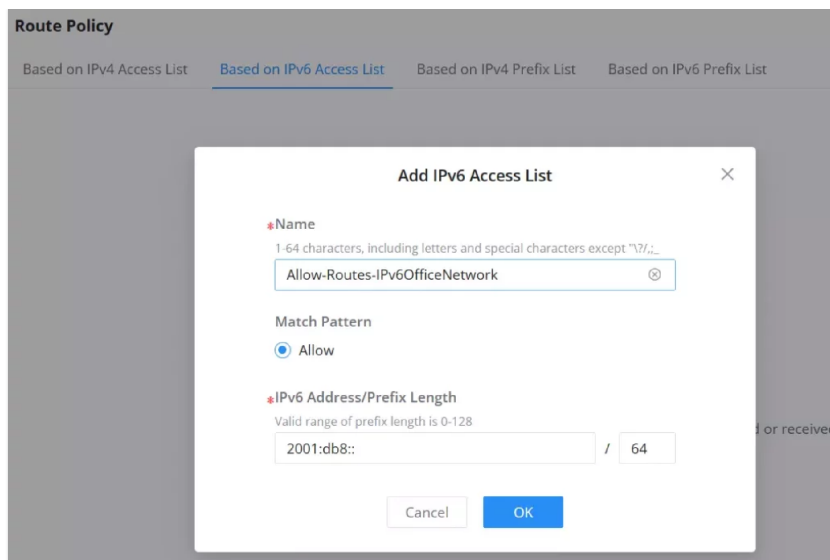

BGP Based on IPv6 Access List

Example Configuration:

- **Name:** Allow-Routes-IPv6OfficeNetwork
- **Match Pattern:** Allow (this will permit routes that match the IPv6 address and prefix length).
- **IPv6 Address/Prefix Length:** 2001:db8::/64

This configuration allows routes from the **2001:db8::/64** network to be advertised or received by the BGP peer.

For more complex configurations, additional rules can be created similarly.

Based on IPv4 Prefix List

The **Based on IPv4 Prefix List** section allows you to create filtering rules for specific IPv4 prefixes that are either allowed or denied from being advertised or received by BGP peers. This gives you control over which prefixes are part of your BGP routing policies.

To configure an IPv4 Prefix List:

1. Navigate to **Routing** → **Based on IPv4 Prefix List**.
2. Click **Add**.
3. Enter a **Name** for the rule (e.g., **Allow-Prefixes-OfficeNetwork**).
4. Assign a **Rule ID** (the smaller the ID, the higher its priority in matching).
5. Select the **Allow** match pattern.
6. Specify the **IPv4 Address Prefix** and the corresponding prefix length (e.g., **192.168.1.0/24**).
7. Click **OK** to save the rule.

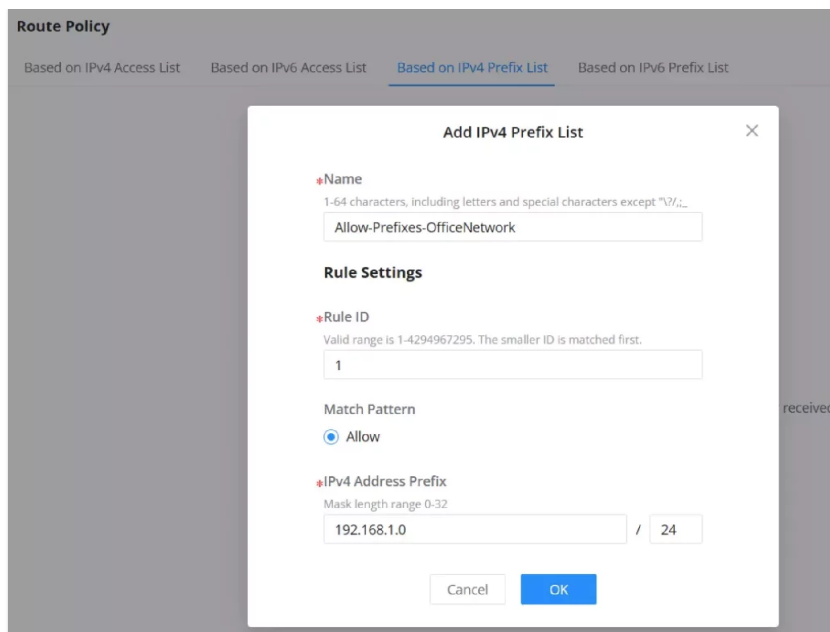

BGP Based on IPv4 Prefix List

Example Configuration:

- **Name:** Allow-Prefixes-OfficeNetwork
- **Rule ID:** 1
- **Match Pattern:** Allow
- **IPv4 Address Prefix:** 192.168.1.0/24

This configuration allows prefixes from the **192.168.1.0/24** network to be advertised or received by the BGP peer.

Based on IPv6 Prefix List

The **Based on IPv6 Prefix List** section allows you to create filtering rules for specific IPv6 prefixes that are either allowed or denied from being advertised or received by BGP peers. This ensures that only certain IPv6 prefixes are part of your BGP routing policies.

To configure an IPv6 Prefix List:

1. Navigate to **Routing** → **Route Policy** → **Based on IPv6 Prefix List**.
2. Click **Add**.
3. Enter a **Name** for the rule (e.g., **Allow-Prefixes-IPv6Network**).
4. Assign a **Rule ID** (the smaller the ID, the higher its priority in matching).
5. Select the **Allow** match pattern.
6. Specify the **IPv6 Address Prefix** and the corresponding prefix length (e.g., **2001:db8::/64**).
7. Click **OK** to save the rule.

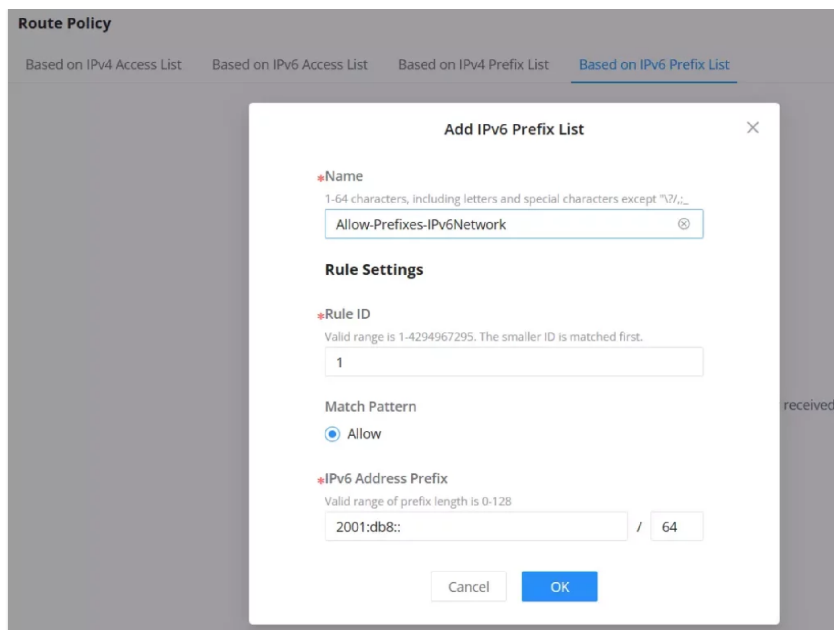

BGP Based on IPv6 Prefix List

Example Configuration:

- **Name:** Allow-Prefixes-IPv6Network
- **Rule ID:** 1
- **Match Pattern:** Allow
- **IPv6 Address Prefix:** 2001:db8::/64

This configuration allows prefixes from the **2001:db8::/64** network to be advertised or received by the BGP peer.

POE

Power Over Ethernet (PoE) refers to supplying power over an Ethernet network, also known as a local area network-based power supply system PoL or Active Ethernet.

Usually, the terminal devices of the access point need to use a DC power supply, but due to insufficient wiring, these devices need unified power management. At this time, the switch interface provides the power supply function, which can solve the above problems and realize the precise control of the port PoE power supply.

Note:

The GWN78xxP models support PoE Mode A.

Global

This page Displays the Power Supply Info like the number of PoE, Total and Remaining PoE Power, etc, and even the Supply Voltage.

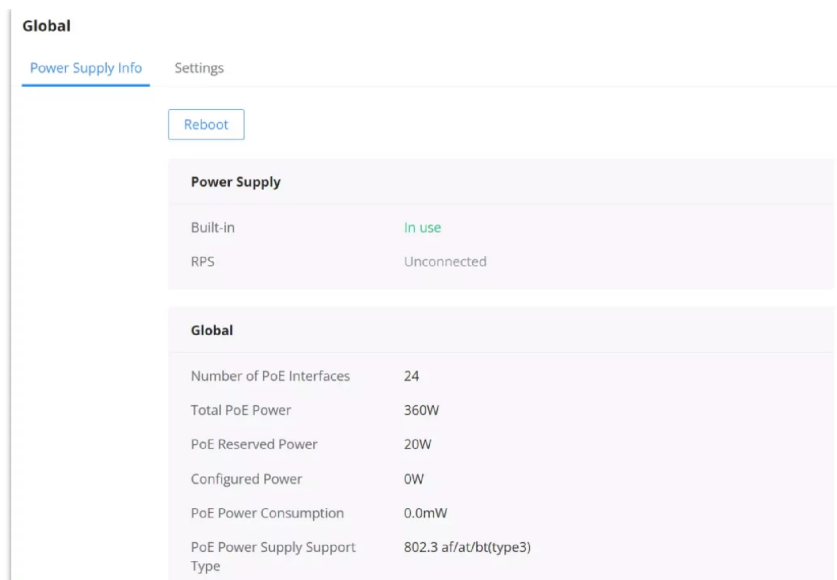

PoE Global

Click on  button to soft restart the PoE module function.

PoE Remaining power

PoE Remaining power(W): specify the total reserved power of the PoE power supply, the default is 20 W.

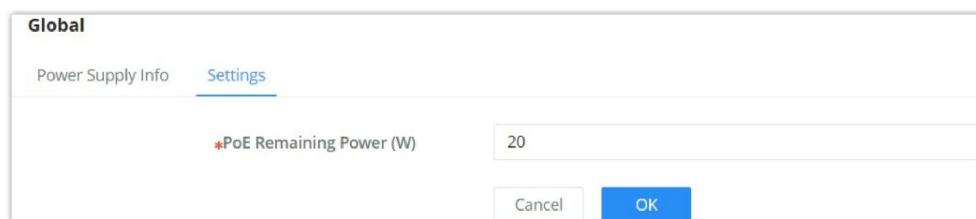

PoE Global Settings

Application scenarios:

The device will dynamically allocate power to each interface according to the power consumed by each interface. During the running process of each PD device, its power consumption will continue to change, and the system will periodically calculate the total power required by all currently connected PDs. Whether the upper limit of the available PoE power is exceeded, if it exceeds, the system will automatically power off the PD device on the interface with lower priority to ensure the normal operation of other devices. However, sometimes there will be a sudden surge in power consumption, the remaining available power of the system cannot support this surge in demand, and the system has not yet had time to calculate the total power consumption exceeding the limit, to disconnect the power supply of the interface with lower priority. When the PoE power supply is overloaded, the overload protection will be powered off, and all PD devices will be powered off. Use the PoE power-reserved command to reasonably set the reserved power of the system. In the event of a sudden surge in power demand, the reserved power of the system can support the sudden demand and ensure that the system has time to power off the devices on the interfaces with low priority. method to ensure the stable operation of other equipment.

Interface PoE configuration

Select the switch interface that supports the PoE power supply to be configured. Multiple choices are possible.

Click on the "Edit" button or icon to change the configuration per port including Power Supply Standard, Power Mode, Power Limit Mode, and Power Supply Priority.

Interface	Power Supply Standard	Power Mode	Power Supply Priority	Max Power Supply(W)	Power-Off Schedule	Current (mA)	Current (mA)	Operation
<input type="checkbox"/> 1/0/1	802.3bt	Auto	Low	60	None	0.0	0.0	
<input type="checkbox"/> 1/0/2	802.3bt	Auto	Low	30	None	90.0	4990.0	
<input type="checkbox"/> 1/0/3	802.3bt	Auto	Low	60	None	0.0	0.0	
<input type="checkbox"/> 1/0/4	802.3bt	Auto	Low	60	None	0.0	0.0	
<input type="checkbox"/> 1/0/5	802.3bt	Auto	Low	60	None	0.0	0.0	
<input type="checkbox"/> 1/0/6	802.3bt	Auto	Low	60	None	0.0	0.0	
<input type="checkbox"/> 1/0/7	802.3bt	Auto	Low	60	None	0.0	0.0	
<input type="checkbox"/> 1/0/8	802.3bt	Auto	Low	60	None	0.0	0.0	
<input type="checkbox"/> 1/0/9	802.3at	Auto	Low	30	None	0.0	0.0	
<input type="checkbox"/> 1/0/10	802.3at	Auto	Low	30	None	0.0	0.0	

PoE Interface page

Interface > **Edit**

Interface:

Power Supply Standard:

Power Mode:

Power Limit Mode:

Power Supply Priority:

Power-Off Schedule:

PoE Interface edit port

QoS

The popularity of the network and the diversification of services have led to a surge in Internet traffic, resulting in network congestion, increased forwarding delay, and even packet loss in severe cases, resulting in reduced service quality or even unavailability. Therefore, to carry out these real-time services on the network, it is necessary to solve the problem of network congestion. The best way is to increase the bandwidth of the network, but considering the cost of operation and maintenance, this is not realistic. The most effective solution is to apply a "Guaranteed" policies govern network traffic. QoS technology is developed under this background. QoS is quality of service, and its purpose is to provide end-to-end service quality assurance for various business needs. QoS is a tool for effectively utilizing network resources. It allows different traffic flows to compete for network resources unequally. Voice, video, and important data applications can be prioritized in network equipment.

Port Priority

On this page, the user can enable/disable port priority for each interface (port/LAG), supported modes are (CoS, DSCP, CoS-DSCP, or IP-Precedence).

Please navigate to **Web UI** → **QoS** → **Port Priority** page.

Port	Trust Mode	CoS	Remarking CoS	Remarking DSCP	Remarking IP Precedence	Operation
<input type="checkbox"/> 1/0/1	802.1p	6	Enabled	Disabled	Disabled	
<input checked="" type="checkbox"/> 1/0/2	None	0	Disabled	Disabled	Disabled	
<input checked="" type="checkbox"/> 1/0/3	None	0	Disabled	Disabled	Disabled	
<input checked="" type="checkbox"/> 1/0/4	None	0	Disabled	Disabled	Disabled	
<input type="checkbox"/> 1/0/5	None	0	Disabled	Disabled	Disabled	

QoS Port Priority

Then the user can click on the **"Edit"** button for further configuration per Port/LAG.

Edit Port Priority

Port
1/0/1

Trust Mode
802.1p

***CoS**
Valid range is 0-7.
6

Remarking CoS

Remarking DSCP

Remarking IP Precedence

Only either Rewrite DSCP or Rewrite IP Precedence can be selected. Both cannot be selected at the same time.

Edit Port Priority

Port	Displays the selected port GE/LAG.
Trust Mode	<p>Select the QoS operation mode:</p> <ul style="list-style-type: none"> ● None: no packet priority is trusted, and the interface default priority is used. ● CoS: Traffic is mapped to queues based on the CoS Queue Mapping, it can configured in QoS → Priority Mapping → CoS Mapping page. ● DSCP: All IP traffic is mapped to queues based on the DSCP field in the IP header. If the traffic is not IP traffic, it is mapped to the lowest priority queue. ● CoS-DSCP: All IP traffic is mapped to queues based on the DSCP field in the IP header. If the traffic is not IP traffic but has VLAN tag, mapped to queues based on the CoS value in the VLAN tag. it can configured in QoS → Priority Mapping → DSCP Mapping page. ● IP-Precedence: The IP precedence is a 3-bit field in TOS that threats high priority packets as more important than other packets. it can configured in QoS → Priority Mapping → IP Mapping page.
CoS	Set the CoS value of the interface, the value range is an integer from 0 to 7 (7 is the highest priority), <i>the default is 0.</i>
Remarking CoS	Set whether to enable Remarking CoS function of outgoing packets, <i>which is disabled by default.</i>
Remarking DSCP	Set whether to enable Remarking DSCP function of outgoing packets, <i>and it is disabled by default.</i>
Re-marking IP Precedence	<p>Set whether to enable Remarking IP Precedence function of outgoing packets, <i>and it is disabled by default.</i></p> <p><i>Note : Only one of DSCP and IP Precedence re-marking can be enabled.</i></p>

QoS Port Priority

Priority Mapping

Priority mapping is used to realize the conversion between the QoS priority carried in the packet and the internal priority of the device (also known as the local priority, which is the priority used by the device to differentiate the service level of the packet) so that the device provides the Differentiated QoS service quality. Users can use different QoS priority fields in different networks according to network planning.

- **CoS Mapping**

Shows the mapping relationship between queues and CoS remarking priorities.

The screenshot shows the 'Priority Mapping' configuration page with the 'CoS Mapping' tab selected. It features two side-by-side tables for mapping CoS values to queue priorities.

CoS	Queue
0	0
1	1
2	2
3	3
4	4
5	5
6	6

Queue	CoS
0	0
1	1
2	2
3	3
4	4
5	5
6	6

CoS Mapping

o **DSCP Mapping**

Shows the mapping relationship between DSCP values and queue priorities.

The screenshot shows the 'Priority Mapping' configuration page with the 'DSCP Mapping' tab selected. It displays a table for mapping DSCP values to queue priorities.

DSCP	Queue	DSCP	Queue	DSCP	Queue	DSCP	Queue	DSCP	Queue	DSCP	Queue	DSCP	Queue	DSCP	Queue
0[CS0]	0	8[CS1]	1	16[CS2]	2	24[CS3]	3	32[CS4]	4	40[CS5]	5	48[CS6]	6	56[CS7]	7
1	0	9	1	17	2	25	3	33	4	41	5	49	6	57	7
2	0	10[AF11]	1	18[AF21]	2	26[AF31]	3	34[AF41]	4	42	5	50	6	58	7
3	0	11	1	19	2	27	3	35	4	43	5	51	6	59	7
4	0	12[AF12]	1	20[AF22]	2	28[AF32]	3	36[AF42]	4	44	5	52	6	60	7
5	0	13	1	21	2	29	3	37	4	45	5	53	6	61	7
6	0	14[AF13]	1	22[AF23]	2	30[AF33]	3	38[AF43]	4	46[EF]	5	54	6	62	7

DSCP Mapping

o **IP Mapping**

Shows the mapping relationship between IP priority and queue.

The screenshot shows the 'Priority Mapping' configuration page with the 'IP Mapping' tab selected. It features two side-by-side tables for mapping IP priorities to queue priorities.

IP	Queue
0	0
1	1
2	2
3	3
4	4
5	5
6	6

Queue	IP
0	0
1	1
2	2
3	3
4	4
5	5
6	6

IP Mapping

Queue Scheduling

When congestion occurs in the network, the device will determine the processing order of forwarding packets according to the specified scheduling policy, so that high-priority packets are preferentially scheduled.

Queue scheduling algorithm: queue scheduling according to the switch interface.

- **Strict priority (SP, Strict Priority) scheduling:** The flow with the highest priority is served first, and the flow with the second highest priority is served until there is no flow at that priority. Each interface of the switch supports 8 queues (queues 0-7), queue 7 is the highest priority queue, and queue 0 is the lowest priority queue. **Disadvantage:** When congestion occurs, if there are packets in the high-priority queue for a long time, the packets in the low-priority queue cannot be scheduled, and data cannot be transmitted.
- **Weighted Round Robin (WRR, Weighted Round Robin) scheduling:** each priority queue is allocated a certain bandwidth, and provides services for each priority queue according to the priority from high to low. When the high-priority queue has used up all the allocated bandwidth, it is automatically switched to the next priority queue to serve it.
- **Weighted Fair Queuing (WFQ):** Based on ensuring fairness (bandwidth, delay) as much as possible, priority considerations are added, so that high-priority packets have more opportunities for priority scheduling than low-priority packets. WFQ can automatically classify flows by their "session" information (protocol type, source and destination IP addresses, source, and destination TCP or UDP ports, priority bits in the ToS field, etc.) Place each flow evenly into different queues, thus balancing the latency of the individual flows as a whole. When dequeuing, WFQ allocates the bandwidth that each flow should occupy at the egress according to the flow priority (Precedence) . The smaller the priority value is, the less bandwidth is obtained; otherwise, the more bandwidth is obtained.
- **SP-WRR:** the switch schedules packets in the SP scheduling group preferentially, and when the SP scheduling group is empty, schedules the packets in the WRR scheduling group. Queues in the SP scheduling group are scheduled with the SP queue scheduling algorithm. Queues in the WRR scheduling group are scheduled with WRR.
- **SP-WFQ:** the switch schedules packets of queues in the WFQ group based on their minimum guaranteed bandwidth settings, then uses SP queuing to schedule the queues in the SP scheduling group, then uses WFQ to schedule the queues in the WFQ scheduling group in a round robin fashion according to their weights.

Queue Scheduling										
Edit										
Port	Queuing Algorithm	Weight								Operation
		0	1	2	3	4	5	6	7	
<input checked="" type="checkbox"/> 1/0/1	Weighted Fair Queuing(WFQ)	90	95	100	105	110	115	120	127	
<input type="checkbox"/> 1/0/2	Weighted Round Robin (WRR)	1	20	30	50	70	90	100	127	
<input type="checkbox"/> 1/0/3	SP-WFQ	0	30	40	55	77	99	111	127	
<input type="checkbox"/> 1/0/4	SP-WRR	0	30	44	50	77	99	111	127	
<input type="checkbox"/> 1/0/5	Strict Priority (SP)	--	--	--	--	--	--	--	--	

Queue Scheduling

Queue Scheduling > **Edit**

Port:

Queuing Algorithm:

Scheduled according to WFQ. The weight of each queue is set by bytes

Queue ID	Weight
0	<input type="text" value="90"/>
1	<input type="text" value="95"/>
2	<input type="text" value="100"/>
3	<input type="text" value="105"/>
4	<input type="text" value="110"/>
5	<input type="text" value="115"/>
6	<input type="text" value="120"/>
7	<input type="text" value="127"/>

Queue Scheduling Edit port

Queue Shaping

When the packet sending rate is higher than the receiving rate, or the interface rate of the downstream device is lower than the interface rate of the upstream device, network congestion may occur. If the size of the service traffic sent by users is not limited, the continuous burst of service data from a large number of users will make the network more congested. To make

the limited network resources serve users more effectively, it is necessary to restrict the service flow of users.

Port	Queue								Operation
	0	1	2	3	4	5	6	7	
1/0/1	100000	--	--	--	--	--	--	--	
1/0/2	--	--	--	--	--	--	--	--	
1/0/3	--	--	--	--	--	--	--	--	
1/0/4	--	--	--	--	--	--	--	--	
1/0/5	--	--	--	--	--	--	--	--	
1/0/6	--	--	--	--	--	--	--	--	
1/0/7	--	--	--	--	--	--	--	--	
1/0/8	--	--	--	--	--	--	--	--	

Queue Shaping

To configure a port, click on the “**Edit**” icon under the operation column.

Maximum Rate/CIR (Kbps): Configures the maximum rate of shaping. The value must be an integer between 16-1000000 Kbps and must be multiples of 16. By default, it’s the port rate.

Queue Shaping > **Edit**

Port: 1/0/2













Queue ID	Enable	Maximum Rate/CIR (Kbps)
0	<input checked="" type="checkbox"/>	<input type="text" value="1000000"/>
1	<input type="checkbox"/>	<input type="text"/>
2	<input type="checkbox"/>	<input type="text"/>
3	<input type="checkbox"/>	<input type="text"/>
4	<input type="checkbox"/>	<input type="text"/>
5	<input type="checkbox"/>	<input type="text"/>
6	<input type="checkbox"/>	<input type="text"/>
7	<input type="checkbox"/>	<input type="text"/>

Configuration of Maximum Rate

Rate Limit

Interface rate limit can limit the total rate of all packets sent or received on an interface. The interface rate limit also uses the token bucket to control the flow. If an interface rate limit is configured on an interface of the device, all packets sent through this interface must first be processed through the token bucket of the interface rate limiter. If there are enough tokens in the token bucket, the packet can be sent; otherwise, the packet will be discarded or cached.

To configure Rate Limit, please navigate to **Web UI** → **QoS** → **Rate Limit**.

Port	Ingress	Ingress CIR (Kbps)	Ingress CBS (Byte)	Egress	Egress CIR (Kbps)	Egress CBS (Byte)	Operation
1/0/1	Enabled	1000000	2147483647	Enabled	1000000	53247	
1/0/2	Disabled	--	--	Disabled	--	--	
1/0/3	Disabled	--	--	Disabled	--	--	
1/0/4	Disabled	--	--	Disabled	--	--	
1/0/5	Disabled	--	--	Disabled	--	--	
1/0/6	Disabled	--	--	Disabled	--	--	
1/0/7	Disabled	--	--	Disabled	--	--	
1/0/8	Disabled	--	--	Disabled	--	--	
1/0/9	Disabled	--	--	Disabled	--	--	
1/0/10	Disabled	--	--	Disabled	--	--	
1/0/11	Disabled	--	--	Disabled	--	--	
1/0/12	Disabled	--	--	Disabled	--	--	

Rate Limit

To configure a port, click on the “**Edit**” icon under operation column, then set the CIR and CBS for both Ingress and Egress.

CIR (Committed Information Rate): the guaranteed average transmission rate or the minimum guaranteed traffic delivered in the network.

CBS (Committed Burst Size): the average volume of burst traffic that can pass through an interface.

Rate Limit > **Edit**

Port:

Ingress:

• Ingress CIR (Kbps): Enter a value between 16-1000000 that is a multiple of

• Ingress CBS (Byte): Valid range is 32768-2147483647

Egress:

• Egress CIR (Kbps): Enter a value between 16-1000000 that is a multiple of

• Egress CBS (Byte): Valid range is 678-53247

Rate Limit Edit a port

SECURITY

GWN78xx Switches series support many tools and features to enhance the security of the device against misconfiguration or attacks.

Storm Control

Traffic suppression can limit the rate of broadcast, unknown multicast, unknown unicast, known multicast, and known unicast packets by configuring thresholds, preventing broadcast, unknown multicast packets, and unknown unicast packets from generating broadcast storms. Large traffic impact of known multicast packets and known unicast packets.

Storm control can block the traffic of broadcast, unknown multicast and unknown unicast packets by blocking packets or shutting down ports. The device supports storm control for the above three types of packets on the interface according to the packet rate, byte rate, and percentage. During a detection interval, the device monitors the average rate of three types of packets received on the interface and compares it with the configured maximum threshold. When the packet rate is greater than the configured maximum threshold, the device performs storm control on the interface and executes the Configured storm control actions. Storm control actions include blocking packets and shutting down / shutdown interfaces.

- If packets are blocked, when the average rate of receiving packets on the interface is less than the specified minimum threshold, storm control will release the blocking of the packets on the interface.
- If the action is to shut down / shutdown the interface, you need to manually run the command to bring up the interface, or enable the interface state to automatically return to UP, it's also possible to use the **Auto Recovery** function to bring up the interface automatically.

Storm Control

Unit:

IFG: Include Exclude

Port

Port	Status	Broadcast	Broadcast Threshold	Unknown Multicast	Unknown Multicast Threshold	Unknown Unicast	Unknown Unicast Threshold	Ac	Operation
1/0/1	Enabled	Enabled	10000	Enabled	10000	Enabled	10000	Dr	
1/0/2	Disabled	--	--	--	--	--	--	Dr	
1/0/3	Disabled	--	--	--	--	--	--	Dr	
1/0/4	Disabled	--	--	--	--	--	--	Dr	

Storm Control page

Storm Control > **Edit**

Port:

Storm Control:

Broadcast:

*Threshold (Kbps):

Unknown Multicast:

*Threshold (Kbps):

Unknown Unicast:

*Threshold (Kbps):

Action: Drop Disabled

Storm Control edit port

Unit	<p>Select Unit:</p> <ul style="list-style-type: none"> • kbps: Storm control rate will be calculated by octet-based. • pps: Storm control rate will be calculated by packet-based.
IFG	<p>Select IFG (Inter Frame Gap):</p> <ul style="list-style-type: none"> • Excluded: Exclude IFG when count ingress storm control rate. • Included: Include IFG when count ingress storm control rate.
Storm Control → Edit	
Port	Displays the selected port.
Storm Control	Select whether to enable Storm Control on the selected port or not.
Broadcast	<p>Set whether to enable the storm threshold setting for broadcast packets. If Enabled Please enter a Treshhold (Kbps).</p> <p><i>Note: The valid range is 16~1000000, which must be a multiple of 16. Default is 10000.</i></p>
Unknown Multicast	<p>Set whether to enable the storm threshold setting for the Unknown Multicast packets If Enabled Please enter a Treshhold (Kbps).</p> <p><i>Note: The valid range is 16~1000000, which must be a multiple of 16. Default is 10000.</i></p>
Unknown Unicast	<p>Set whether to enable the storm threshold setting for the Unknown Unicast packets. If Enabled Please enter a Treshhold (Kbps).</p> <p><i>Note: The valid range is 16~1000000, which must be a multiple of 16. Default is 10000.</i></p>

Action	Select the state of setting <ul style="list-style-type: none"> ● Drop: Packets exceed storm control rate will be dropped. ● Shutdown: Port exceeds storm control rate will be shutdown.
---------------	---

Storm Control

Port Security

By converting the MAC address learned by the interface into secure MAC addresses (including secure dynamic MAC address, secure static MAC address and Sticky MAC) , port security prevents illegal users from communicating with the switch through this interface, thereby enhancing the security of the device.

Security MAC addresses are divided into: Secure Dynamic MAC, Secure Static MAC and Sticky MAC.

Secure Dynamic MAC Address	If enabled but the Sticky MAC function is not enabled.	If the device is restarted, the entries will be lost and need to be relearned.
Secure Static MAC Address	Static MAC address manually configured when port security is enabled.	The entries will not be aged, and will not be lost after a reboot.
Sticky MAC Address	The MAC address converted after the port security is enabled and the Sticky MAC function is enabled at the same time	The entries will not be aged , and the addresses will not be lost after restarting the device.

Secure MAC Address Types

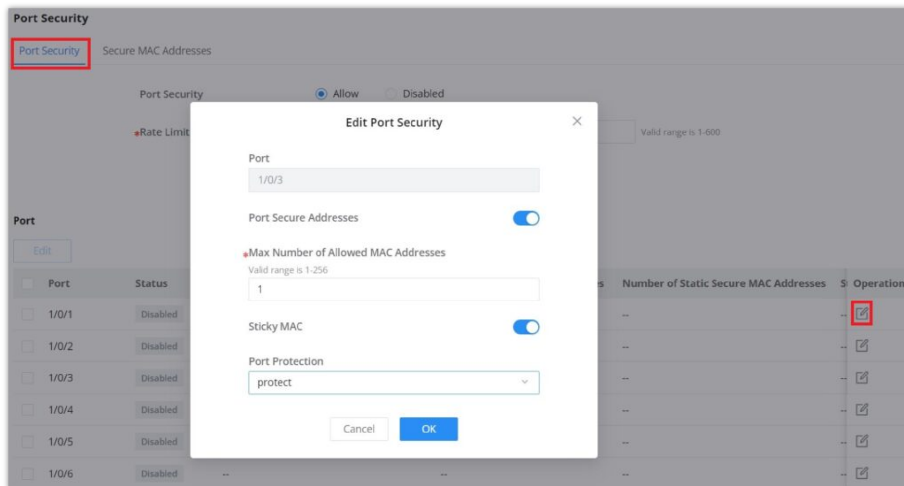

Port Security

Port Security	Click Allow to set the port security function to be enabled globally , by default is disabled.
Rate Limit (packet/s)	Set the rate at which the port MAC address is learned. The value is an integer from 1 to 600, the default is 100.
Edit Port Security	
Port	Displays the selected ports.
Port Security Address	Click to enable Port Security Address, by default is disabled.
Maximum MAC Number	Set the maximum number of MAC addresses to be learned by the interface , the value range is an integer from 1 to 256 , and the default is 1 . After the maximum number is reached , if the switch receives a packet whose source MAC address does not exist, regardless of whether the destination MAC

	address exists, the switch considers that there is an attack by an illegal user, and will protect the interface according to the port protection configuration (Protect, Restrict or Shutdown).
Sticky MAC	When the port security is enabled, the Sticky MAC function can be enabled, by default it's disabled . When enabled, the interface will convert the learned secure dynamic MAC address into a Sticky MAC. If the maximum number of MAC addresses has been reached, the MAC address in the non-sticky MAC entry learned by the interface will be discarded , and a trap alarm will be reported according to the interface protection mode configuration.
Port Protection	<p>Set the protection action when the number of MAC addresses learned by the interface reaches the maximum number or static MAC address flapping occurs .</p> <p>There are three modes (Protect, Restrict or Shutdown), the default is Protect.</p> <ul style="list-style-type: none"> ● Protect: Only discard the packets whose source MAC address does not exist, and does not report an alarm. ● Restrict: Discard packets with nonexistent source MAC addresses and report an alarm. ● Shutdown: The interface state is set to error-down and an alarm is reported. <p><i>Note: By default, an interface will not automatically recover after being shut down, and the interface can only be enabled by the network administrator under the interface. If you want the shut down interface to be restored automatically , you can enable Port Auto Recovery function to automatically restore the interface status to Up.</i></p>

Port Security

Port Isolation

With the port isolation function, the isolation between ports in the same VLAN can be realized. As long as the user adds the port to the isolation group, the Layer 2 data isolation between the ports in the isolation group can be realized. The port isolation function provides users with a safer and more flexible networking solution.

Note:

Due to software limitations, only one isolation group is currently supported, and the port isolation function is disabled by default, that is, the port is added to the default isolation group . After joining , two-way isolation is performed between ports .

Port Isolation	
Port	Isolation Status/Operation
1/0/1	<input type="checkbox"/>
1/0/2	<input checked="" type="checkbox"/>
1/0/3	<input type="checkbox"/>
1/0/4	<input type="checkbox"/>
1/0/5	<input type="checkbox"/>
1/0/6	<input checked="" type="checkbox"/>
1/0/7	<input type="checkbox"/>
1/0/8	<input type="checkbox"/>
1/0/9	<input type="checkbox"/>
1/0/10	<input type="checkbox"/>

Port Isolation

ACL

Access control list (ACL) is a collection of one or more rules. A rule is a judgment statement that describes the matching conditions of a packet. These conditions can be the source address, destination address, port number, etc. of the packet. ACL is essentially a packet filter, and the rule is the filter element of the filter. The device matches packets based on these rules, filters out specific packets , and allows or organizes the packets to pass through according to the processing policy of the service module that applies the ACL.

Notes:

- One ACL supports setting multiple rules . When the rule settings (except the rule number) are identical, it will prompt " This rule already exists"
- If there is no match after all the rules are traversed , the Deny message will be sent directly .

IPv4/IPv6 ACL

To add an IPv4 or IPv6 ACL rule, navigate to **Security → ACL → IPv4 tab or IPv6 tab**, then click on **"Add"** button to add an IPv4/IPv6 based ACL rule.

ACL IPv4IPv6

The rules action can be defined in one of the four ways below:

- **Drop:** This action denies or blocks traffic that matches the specified ACL rule, which prevents the packet from being forwarded through the network.
- **Allow:** This action permits traffic that matches the ACL rule, allowing the packet to pass through and continue to its destination.
- **Shut Down:** This action disables the interface or port that the traffic is passing through if the ACL rule is triggered, effectively stopping all traffic on that interface.
- **Redirect to Interface:** This action forwards the traffic matching the ACL rule to a different interface than it was originally destined for, often used for traffic monitoring, load balancing, or security purposes.

ACL IPv4IPv6 Advanced Settings

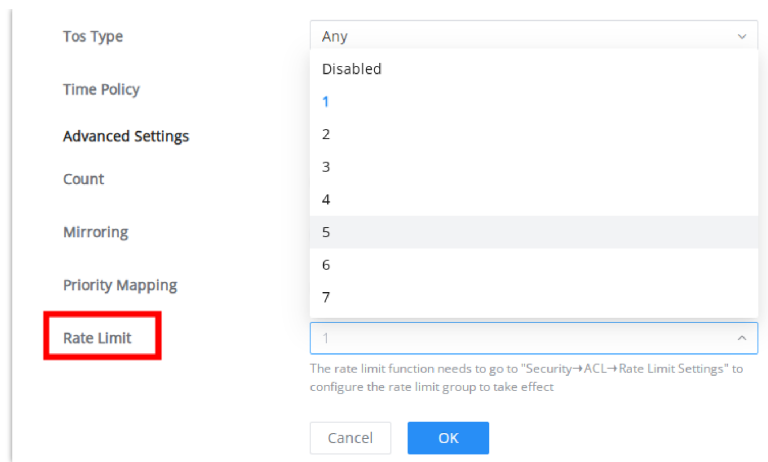

ACL IPv4IPv6 Rate Limit

Note

The rate limit function needs to go to **“Security → ACL → Rate Limit Settings”** to configure the rate limit group to take effect.

Configuring an ACL-based RSPAN

To perform an ACL-based RSPAN, please follow the below steps:

- Select an image group in ACL Image

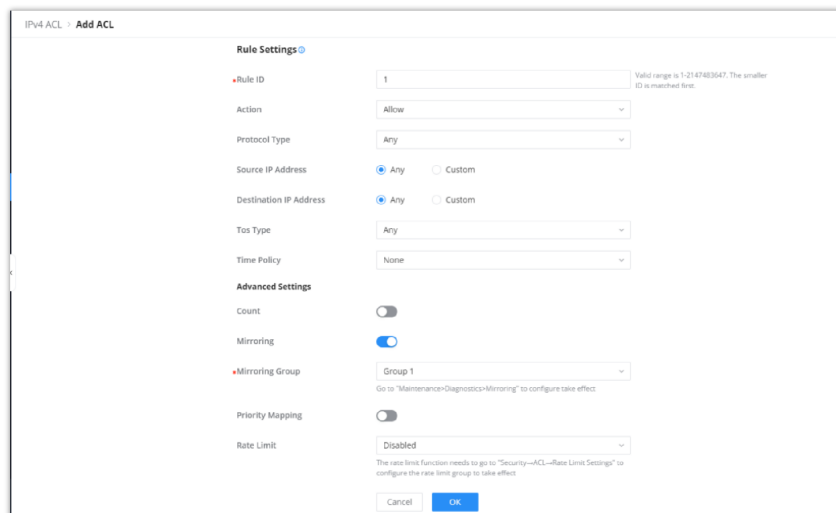

ACL Based RSPAN

- Then, under **ACL → VLAN Binding ACL**, select the corresponding port/VLAN binding ACL.

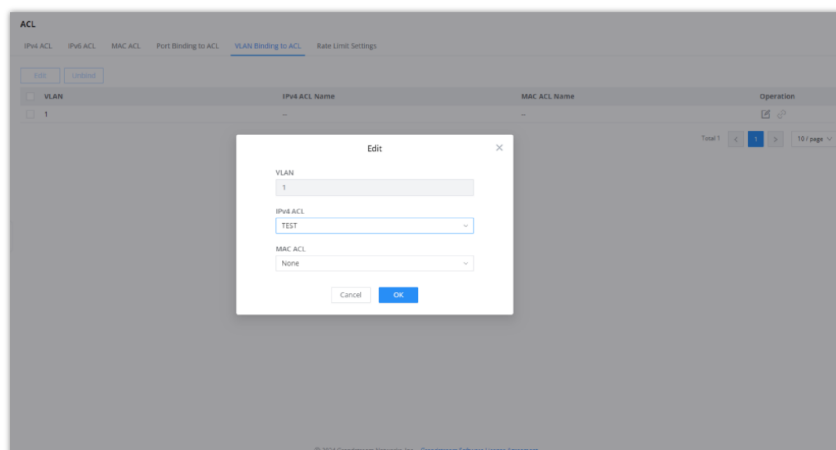

IPv4 ACL VLAN

- Then go to **Diagnostics → Mirroring → Setup Mirroring Group**. If you select RSPAN, you can only use it as a source switch and you need to set the output port and remote VLAN.

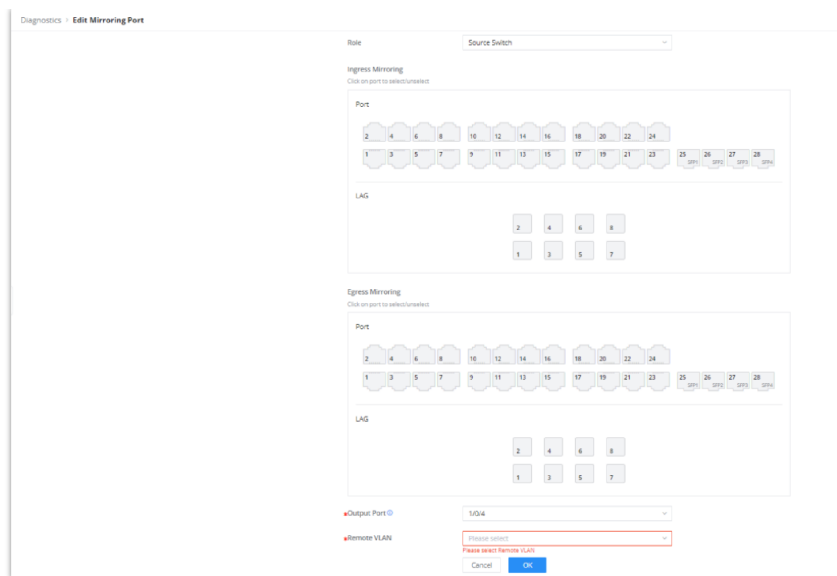

Setup Mirroring Group

MAC ACL

To add an ACL based on the MAC address, on the MAC ACL tab, click on the **"Add"** button to add an ACL rule, then configure the **Source MAC Address** and the **Destination MAC Address** accordingly. Please refer to the figure below:

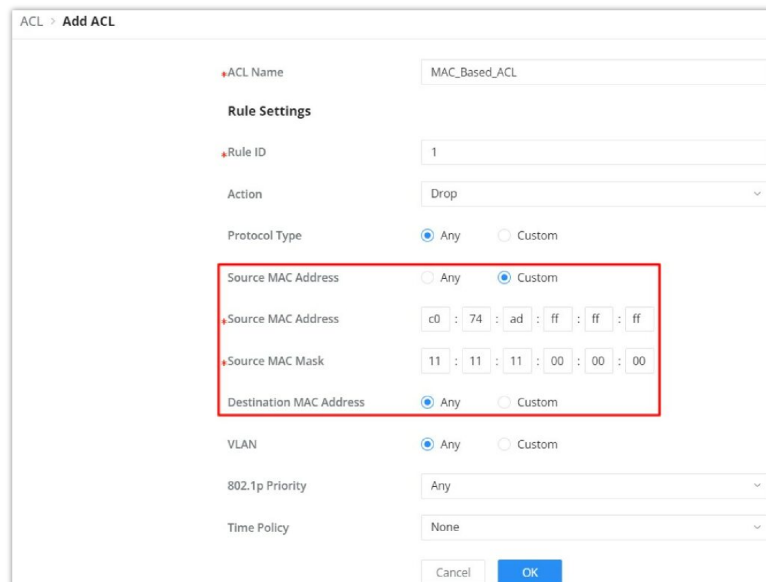

MAC address based ACL

Port Binding to ACL

ACL Binding lets the user bind MAC ACL or IP ACL to certain ports GE/LAG.

To apply IP/MAC ACL rules on multiple ports, select the ports first then click on the **"Edit"** button, then select the IP and MAC ACL rule from the drop-down list.

To apply the ACL rule on a specific port, click on the **"Edit icon"** on the right side of the page as shown below:

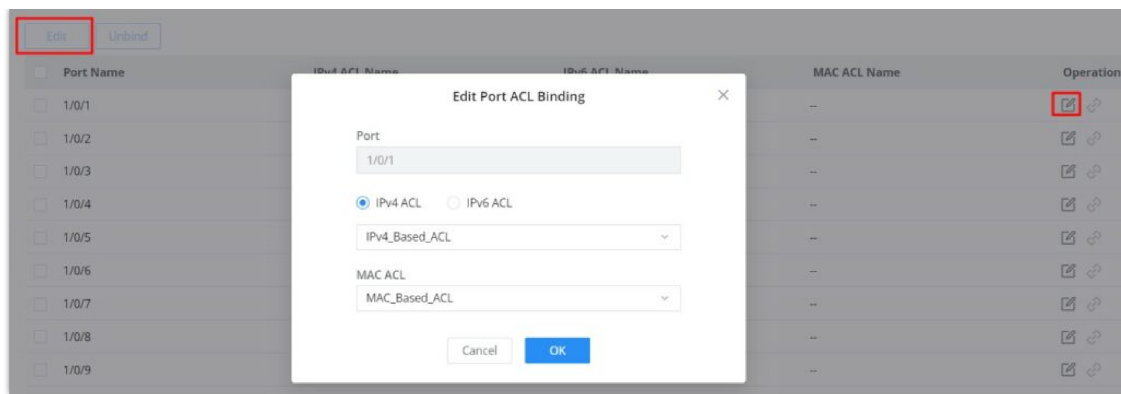

ACL Binding

VLAN Binding to ACL

On this page, the users can bind the IP/MAC ACL rule to a VLAN(s), to apply the ACL rules to multiple VLANs, first check the VLANs from the list then click on the "Edit" button, select the ACL rule from the drop-down list under IP/MAC ACL.

For example: if the IP/MAC ACL rule is configured with a rate limit, and then bound to a VLAN, the bandwidth limit will be applied to the specified VLAN.

refer to the figure below:

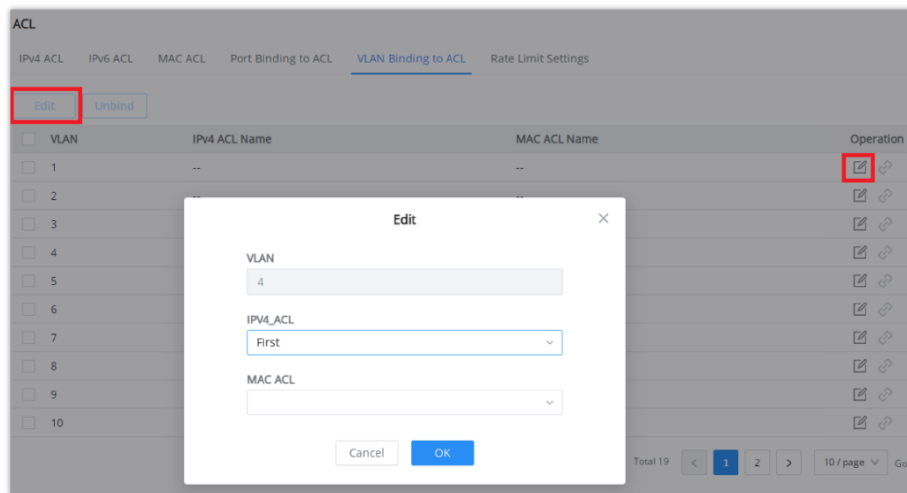

VLAN Binding to ACL

Rate Limit Settings

The Rate Limit Settings section in ACL (Access Control List) allows users to configure rate limiting for up to 128 groups. Rate limiting helps manage and control the amount of traffic sent or received on the network, preventing congestion and ensuring fair usage. This feature is crucial for maintaining optimal network performance and avoiding overloads.

Rate Limit Group ID	Rate Limit Type	Burst Threshold	Rate Threshold	Operation
1	By packet	20000 pps	150000 pps	
2	By byte	8388480 Bps	125000 KBps	
3	--	--	--	
4	--	--	--	
5	--	--	--	
6	--	--	--	
7	--	--	--	
8	--	--	--	
9	--	--	--	
10	--	--	--	

ACL Rate Limit Settings

The users can configure up to 128 groups, by clicking on the "Edit icon" under the operation column.

- Click on the **"Edit icon"** under the Operation column to configure a group.
- Select the **Rate Limit Type** to determine if the limit will be by **packet or byte**.
- Specify the **Burst Packet/Byte**, which sets the maximum number of packets or bytes allowed to be sent in a burst.
- Set the **Rate Threshold**, which defines the maximum rate of packets or bytes per second.

The 'Edit' dialog box contains the following fields and options:

- Rate Limit Group ID:** A text input field containing the value '1'.
- Rate Limit Type:** Two radio button options: 'By packet' (selected) and 'By byte'.
- *Burst Packet (pps):** A text input field containing '20000'. Below it, the text 'Valid range is 1-65535' is displayed.
- *Rate Threshold (pps):** A text input field containing '150000'. Below it, the text 'Valid range is 1-262143' is displayed.
- Buttons:** 'Cancel' and 'OK' buttons at the bottom.

ACL Edit Rate Limit Group

IP Source Guard

IP source guard is a source IP address filtering technology based on the Layer 2 interface. It can prevent malicious hosts from forging IP addresses of legitimate hosts to impersonate legitimate hosts, and also ensure that unauthorized hosts cannot access by specifying their IP addresses. network or attack the network. IPSG uses the binding table (source IP address, source MAC address, VLAN to which it belongs, and the binding of the inbound interface) to match and check the IP packets received on the Layer 2 interface. Only the packets matching the binding table are allowed to pass through.

Note:

It's recommended to enable first DHCP Snooping by navigating to **Security** → **DHCP Snooping**.

To enable IP Source Guard, first navigate to the **Security** → **IP Source Guard** page, then select the port and click on **"Edit"** to configure the port.

The screenshot shows the 'IP Source Guard' configuration page with the 'Port Protection' tab selected. The table below represents the data shown in the screenshot:

Port	IP Source Guard	Verification Type	Number of Quaternary Bindings	Operation
<input type="checkbox"/> 1/0/1	Disabled	IP	1	
<input checked="" type="checkbox"/> 1/0/2	Enabled	IP	--	
<input type="checkbox"/> 1/0/3	Disabled	IP	--	

IP Source Guard

Then, select the **Verification Type** where either the verification will be based on IP addresses or both IP and MAC addresses. **Max Entries** limits the number of IP/MAC addresses (e.g. devices) where 0 indicates no limit.

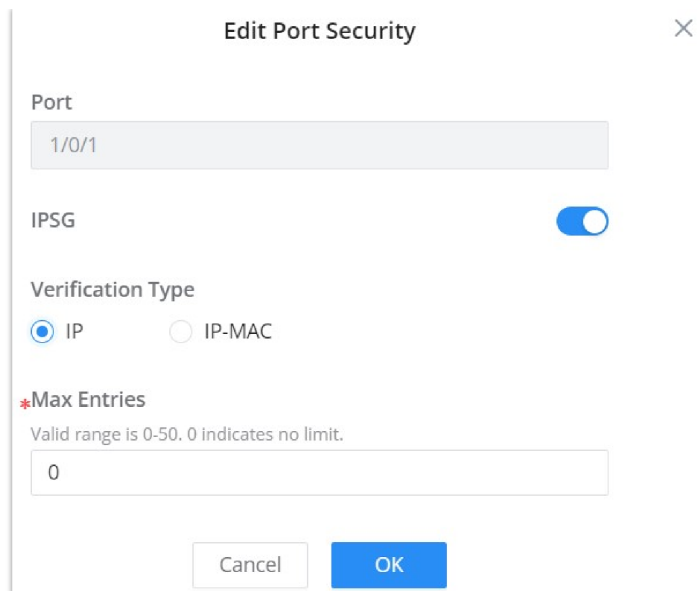

Edit Port Security

Port: 1/0/1

IPSG:

Verification Type: IP IP-MAC

*Max Entries: 0
Valid range is 0-50. 0 indicates no limit.

Buttons: Cancel, OK

IP Source Guard Edit port

This page displays the dynamic binding (port, IP, MAC, VLAN) generated when DHCP Snooping is enabled on the GWN78xx switches, also the user can add static binding by clicking on the **"Add"** button as shown below:

Note:

Dynamic entries require enabling **DHCP Snooping**.

To import or export the list click on the **import or export button** respectively.

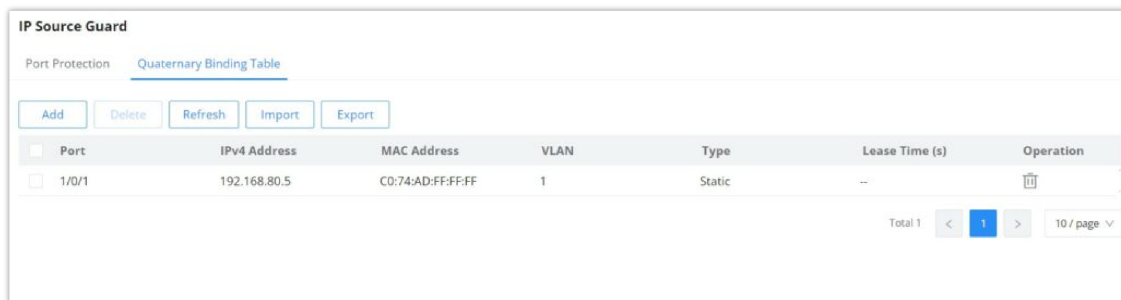

IP Source Guard

Port Protection Quaternary Binding Table

Buttons: Add, Delete, Refresh, Import, Export

Port	IPv4 Address	MAC Address	VLAN	Type	Lease Time (s)	Operation
<input type="checkbox"/> 1/0/1	192.168.80.5	C0:74:AD:FF:FF:FF	1	Static	--	

Total 1 | Page 1 of 10

Quaternary Binding Table

The binding requires specifying the port, IP Address and its mask, MAC address and its mask, and the VLAN ID. This information will be used to verify the traffic and make sure all the traffic is generated by legitimate users.

Add Quaternary Binding ✕

***Port**

***IP Address**
IPv4 format

***Mask** ⓘ
IPv4 format

MAC Address
The MAC address must be a unicast address.
 : : : : :

***Mask**
 : : : : :

***VLAN**
Valid range is 1-4094

Add Quaternary Binding

IPv6 Source Guard

IPv6 Source Guard is similar to [IP Source Guard](#) (based on IPv4), the only difference is that IPv6 Source Guard filters IPv6 addresses.

IPv6 Source Guard					
Port Protection		Quaternary Binding Table			
<input type="button" value="Edit"/>					
Port	IPv6 Source Guard	Verification Type	Number of Quaternary Bindings	Operation	
<input type="checkbox"/> 1/0/1	Disabled	IPv6	--	<input type="button" value="Edit"/>	
<input checked="" type="checkbox"/> 1/0/2	Enabled	IPv6	--	<input type="button" value="Edit"/>	
<input type="checkbox"/> 1/0/3	Disabled	IPv6	--	<input type="button" value="Edit"/>	

IPv6 Source Guard

To enable IPv6 Source Guard on a port, select the port and click on the "Edit" button under the operation column, then select the **Verification Type** and specify the **Max Entries**.

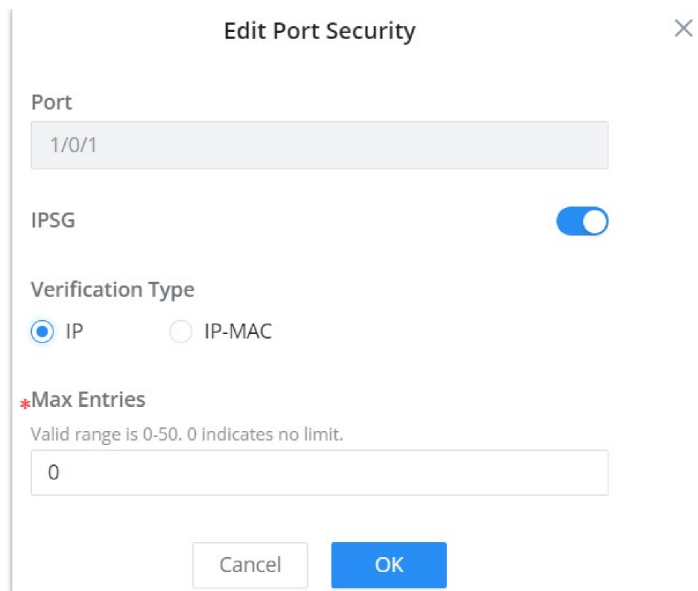

Edit Port Security

Port: 1/0/1

IPSG:

Verification Type: IP IP-MAC

*Max Entries: 0
Valid range is 0-50. 0 indicates no limit.

Cancel OK

IPv6 Source Guard Edit port

On this tab, the user can see the list of binding both static and dynamic (DHCP Snooping must enabled).

To add a static entry, click on the "Add" button, it's also possible to import or export the list as shown below:

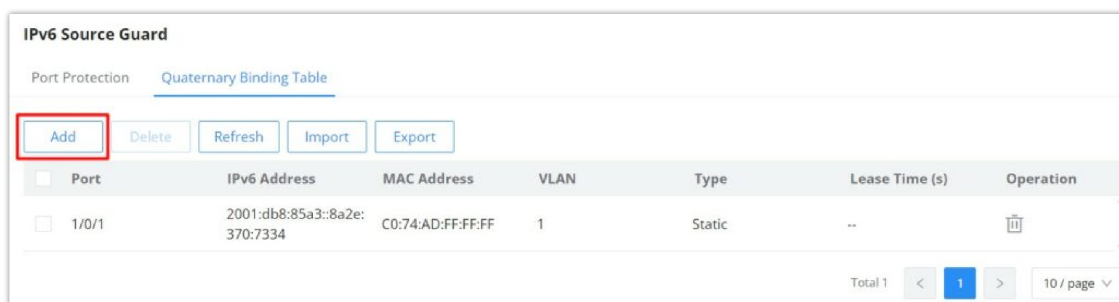

IPv6 Source Guard

Port Protection Quaternary Binding Table

Add Delete Refresh Import Export

Port	IPv6 Address	MAC Address	VLAN	Type	Lease Time (s)	Operation
<input type="checkbox"/> 1/0/1	2001:db8:85a3::8a2e:370:7334	C0:74:AD:FF:FF:FF	1	Static	--	

Total 1 < 1 > 10 / page

IPv6 Quaternary Binding Table

Specify the binding (port, IP address, MAC Address, and VLAN), then click on the "OK" button to save.

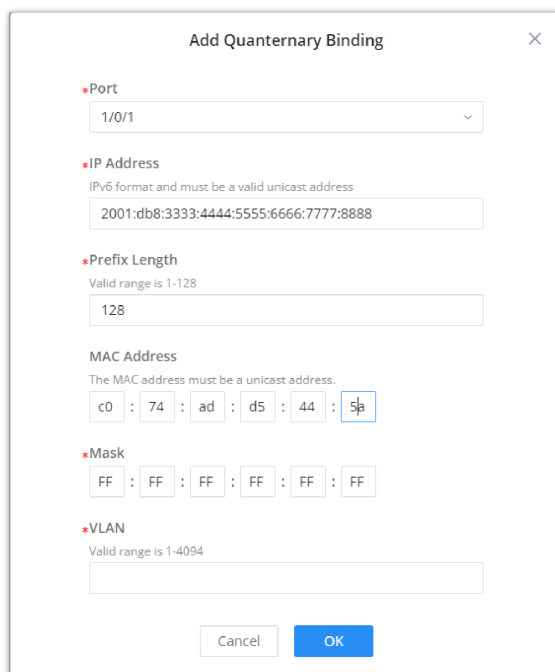

Add Quaternary Binding

*Port: 1/0/1

*IP Address: 2001:db8:3333:4444:5555:6666:7777:8888
IPv6 format and must be a valid unicast address

*Prefix Length: 128
Valid range is 1-128

MAC Address: c0 : 74 : ad : d5 : 44 : 5a
The MAC address must be a unicast address.

*Mask: FF : FF : FF : FF : FF : FF

*VLAN:
Valid range is 1-4094

Cancel OK

IPv6 Quaternary Binding edit port

Anti Attack

In the network, there are a large number of malicious attack packets targeting the CPU and various types of packets that need to be normally sent to the CPU. Malicious attack packets targeting the CPU will cause the CPU to be busy processing attack packets for a long time, thereby causing interruption of other services or even system interruption; a large number of normal packets will also lead to high CPU usage and performance degradation, thus affecting the normal business.

In order to protect the CPU and ensure that the CPU can process and respond to normal services, the switch provides a local attack defense function, which is aimed at the packets sent to the CPU. It operates normally to avoid the mutual influence of various services when the device is attacked.

Attack defense is an important network security feature. It analyzes the content and behavior of the packets sent to the CPU for processing, determines whether the packets have attack characteristics, and configures certain preventive measures against the packets with attack characteristics. Defense attacks are mainly divided into malformed packet attack defense, fragmented packet attack defense, and flood attack defense.

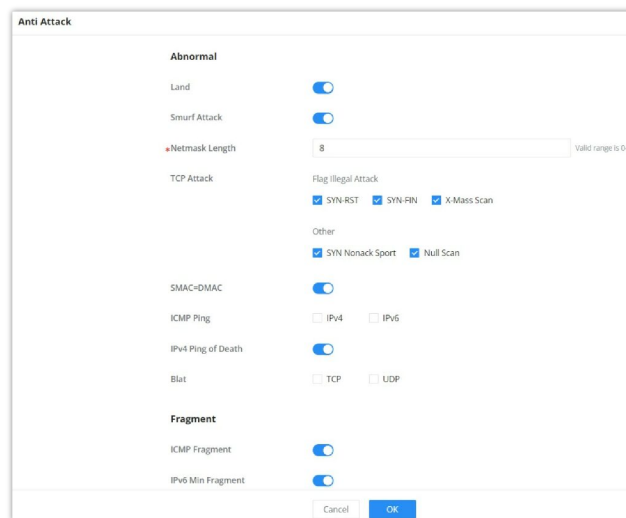

Anti Attack

Dynamic ARP Inspection (DAI)

To defend against man-in-the-middle attacks and prevent data of legitimate users from being stolen by the man-in-the-middle, you can enable dynamic ARP inspection. The device compares the source IP, source MAC, interface, and VLAN information corresponding to the ARP packet with the information in the binding table. If the information matches, it means that the user who sent the ARP packet is legitimate, and the user is allowed. If the ARP packet passes, otherwise it is considered an attack and the ARP packet is discarded.

Dynamic ARP inspection can be enabled in the interface view, or VLAN view. When enabled in the interface view, the binding table matching check is performed on all ARP packets received by the interface; when enabled in the VLAN view. Then, the binding table matching check is performed on the ARP packets belonging to the VLAN received by the interface that joins the VLAN.

When the device discards a large number of ARP packets that do not match the binding table, if you want the device to alert the network administrator in the form of an alarm, you can enable the dynamic ARP inspection discarded packet alarm function. When the number of discarded ARP packets exceeds the alarm threshold, the device generates an alarm.

DAI

DAI Statistics

DAI

VLAN Valid range is 1-4094. Example: "5-8, 11" will associate VLANs 5, 6, 7, 8 and 11.

Port

<input type="checkbox"/>	Port	Trust Port	Source MAC Address Verification	Destination MAC Address Verification	IP Address Verification	Speed (pps)	Operation
<input type="checkbox"/>	1/0/1	Disabled	Enabled	Enabled	Enabled	0	<input type="button" value="↻"/>
<input type="checkbox"/>	1/0/2	Disabled	Disabled	Disabled	Disabled	0	<input type="button" value="↻"/>
<input type="checkbox"/>	1/0/3	Disabled	Disabled	Disabled	Disabled	0	<input type="button" value="↻"/>

DAI page

DAI > **Edit**

Port

Trust Port

Source MAC Address Verification

Destination MAC Address Verification

IP Address Verification

All-Zero Address Forbid Allow

Rate (pps) Valid range is 0-50

DAI Edit port

The statistics about DAI activities will be listed here for each port GE/LAG with the options of refreshing the statistics or clearing specified port data.

DAI

DAI Statistics

<input checked="" type="checkbox"/>	Port	Forwarding Packets	Source MAC Address Verification Failures	Destination MAC Address Verification Failures	Source IP Address Verification Failures	Des	Operation
<input checked="" type="checkbox"/>	1/0/1	0	0	0	0	0	<input type="button" value="↻"/>
<input checked="" type="checkbox"/>	1/0/2	0	0	0	0	0	<input type="button" value="↻"/>
<input checked="" type="checkbox"/>	1/0/3	0	0	0	0	0	<input type="button" value="↻"/>
<input checked="" type="checkbox"/>	1/0/4	0	0	0	0	0	<input type="button" value="↻"/>
<input checked="" type="checkbox"/>	1/0/5	0	0	0	0	0	<input type="button" value="↻"/>
<input checked="" type="checkbox"/>	1/0/6	0	0	0	0	0	<input type="button" value="↻"/>
<input checked="" type="checkbox"/>	1/0/7	0	0	0	0	0	<input type="button" value="↻"/>
<input checked="" type="checkbox"/>	1/0/8	0	0	0	0	0	<input type="button" value="↻"/>
<input checked="" type="checkbox"/>	1/0/9	0	0	0	0	0	<input type="button" value="↻"/>
<input checked="" type="checkbox"/>	1/0/10	0	0	0	0	0	<input type="button" value="↻"/>
<input checked="" type="checkbox"/>	1/0/11	0	0	0	0	0	<input type="button" value="↻"/>

DAI Statistics

RADIUS

RADIUS is a distributed, client /server information exchange protocol that can protect the network from unauthorized access. It is often used in various network environments that require high security and allow remote users to access it. This protocol defines the UDP-based RADIUS packet format and its transmission mechanism and specifies destination UDP ports 1812 and 1813 as the default authentication and accounting port numbers, respectively.

Radius provides access services through authentication and authorization and collects and records the use of network resources by users through accounting. The main features of RADIUS protocol are client/server mode, secure message exchange mechanism, and good expansibility.

RADIUS

Buttons: Add, Delete

Server Address	UDP Port	Priority	Max Retransmission Count	Timeout (s)	Operation
<input checked="" type="checkbox"/> 192.168.5.5					<input type="checkbox"/> <input type="checkbox"/>

•RADIUS Server Address: 192.168.5.5

•UDP Port: 1812

•Priority: 16

•Shared Key: password

•Max Retransmission Count: 1

•Timeout (s): 10

Buttons: Cancel, Save

RADIUS

Note:

While RADIUS shared keys can be configured via the Web UI, only the CLI supports input of pre-encrypted password strings (e.g., \$6\$...) for secure deployment and automation. For CLI usage and formatting guidelines, refer to the GWN78xx CLI User Guide.

TACACS+

TACACS+ (Terminal Access Controller Control System Protocol) is a security protocol with enhanced functions based on the TACACS protocol. This protocol is similar in function to the RADIUS protocol and uses the client/server mode to implement the communication between the NAS and the TACACS+ server.

TACACS+ is a centralized, client /server structure information exchange protocol, which uses TCP protocol for transmission, and the TCP port number is 49. The authentication, authorization, and accounting servers provided by TACACS+ are independent of each other and can be implemented on different servers. It is mainly used for authentication, authorization, and accounting of access users who access the Internet through point-to-point protocol PPP or virtual private dial-up network VPDN and management users who perform operations.

TACACS+ is similar to RADIUS protocol : (1) both adopt client /server mode in structure; (2) both use shared keys to encrypt the transmitted user information ; (3) both have better flexibility and expansibility. TACACS+ has more reliable transmission and encryption characteristics and is more suitable for security control.

TACACS+

Buttons: Add, Delete

Server Address	TCP Port	Priority	Timeout (s)	Operation
<input checked="" type="checkbox"/> 192.168.5.11	49	3	5	<input type="checkbox"/> <input type="checkbox"/>

•TACACS+ Server Address: 192.168.5.11

•TCP Port: 49

•Priority: 3

•Shared Key: password

•Timeout (s): 5

Buttons: Cancel, Save

TACACS+

Note:

While TACACS+ shared keys can be configured via the Web UI, only the CLI supports input of pre-encrypted password strings (e.g., \$6\$...) for secure deployment and automation. For CLI usage and formatting guidelines, refer to the GWN78xx CLI User Guide.

AAA

Access control is used to control which users can access the network and which network resources can be accessed. AAA is short for Authentication, Authorization, and Accounting, and provides a management framework for configuring access control on NAS (Network Access Server) devices.

As a management mechanism of network security, AAA provides services in a modular manner:

- Authentication , confirming the identity of users accessing the network , and judging whether the visitor is a legitimate network user;
- Authorization , giving different users Different permissions limit the services that the user can use;
- Billing , record all operations during the user’s use of network services, including the type of service used, start time, data flow, etc., to collect and record the user’s The usage of network resources, and can realize the charging requirements for events and traffic, and also monitor the network.

AAA adopts a client /server structure. The AAA client runs on the access device, usually referred to as a NAS device, and is responsible for verifying user identity and managing user access; the AAA server is a collective name for the authentication server, authorization server, and accounting server. Responsible for centralized management of user information. AAA can be implemented through a variety of protocols. Currently, devices support AAA based on RADIUS or TACACS + protocol. In practical applications, the RADIUS protocol is most commonly used.

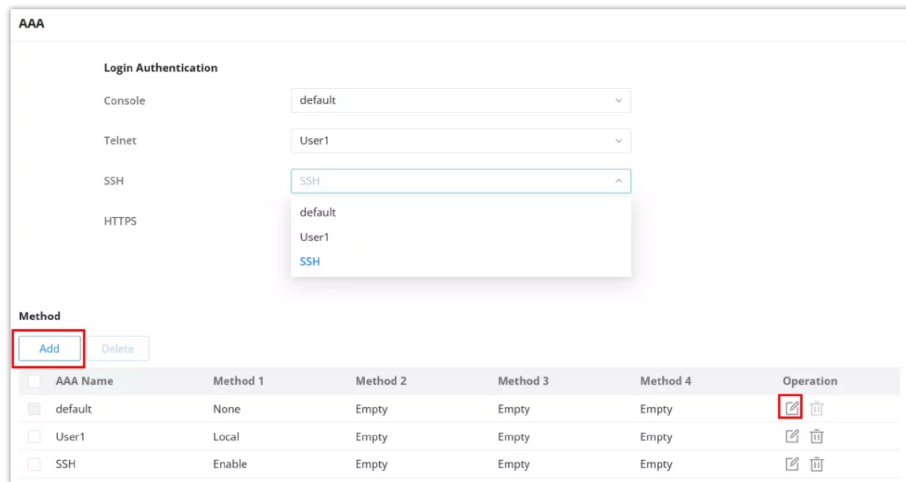

AAA

To add a method click on the “Add” button and to modify a method click on the “Modify” icon as shown above:

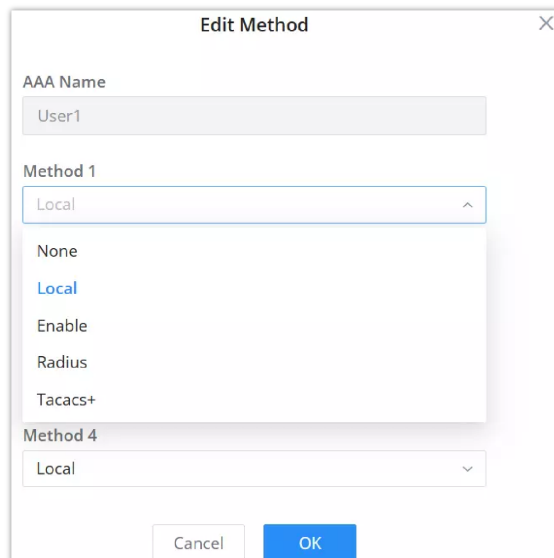

AddEdit a method

Method	Description	Applicability
--------	-------------	---------------

None	No authentication is performed. Users can log in without a username or password. This setting should generally be avoided due to security risks.	Console, Telnet, SSH, Web UI
Local	Uses the local user database on the switch for authentication. User credentials are stored directly on the switch.	Console, Telnet, SSH, Web UI
Enable	Requires users to enter an enable password to gain elevated privileges (admin access). This provides an additional layer of security after initial authentication. Note: <i>The password for user mode to enter privileged mode must be set using CLI.</i>	Console, Telnet, SSH
RADIUS	Utilizes a RADIUS server for authentication. RADIUS (Remote Authentication Dial-In User Service) is used for centralized Authentication, Authorization, and Accounting management.	Console, Telnet, SSH, Web UI
TACACS+	Utilizes a TACACS+ server for authentication. TACACS+ (Terminal Access Controller Access-Control System Plus) offers more granular control over authorization and is used for centralized AAA management.	Console, Telnet, SSH, Web UI

AAA Methods

Identity Authentication Management

The Identity Authentication Management feature on Grandstream GWN switches provides a robust method for securing network access through 802.1X and MAC-based authentication. It allows administrators to configure and manage user authentication settings, ensuring only authorized devices can connect to the network, thereby enhancing overall network security and control.

The 802.1X protocol is a port-based network access control protocol. Port-based network access control refers to verifying user identities and controlling their access rights at the port level of LAN access devices. The 802.1X protocol is a Layer 2 protocol and does not need to reach Layer 3. It does not require high overall performance of the access device, which can effectively reduce network construction costs. Authentication packets and data packets are separated by logical interfaces to improve security.

Port Mode

To enable 802.1x and MAC authentication, please navigate to **Security** → **Identity Authentication Management**, then Toggle on **"802.1X Authentication"** and **"MAC Authentication"**, and click on the **"OK"** button to save.

On this page also, you can specify a **user ID format for MAC-based** and enable a **Guest VLAN**. This ensures these devices remain isolated from the main network while still maintaining limited network connectivity through the Guest VLAN. The Guest VLAN ID directs unauthenticated users to a designated network segment, providing controlled and secure access.

Identity Authentication Management

Port Mode | Port | Authentication Sessions | Local User of MAC-based

802.1X Authentication

MAC Authentication

User ID format of MAC-based: XXXXXXXXXXXX

Guest VLAN

Guest VLAN ID: 7

Cancel OK

Port

Edit

Port	User Authentication Mode	Authentication Method / Method	Guest VLAN	Authorized VLAN	Operation
<input type="checkbox"/> 1/0/1	Port-Based	802.1X / Radius	Disabled	Static	
<input type="checkbox"/> 1/0/2	MAC-Based	MAC Authentication / Local	Disabled	Static	
<input type="checkbox"/> 1/0/3	Single User	802.1X / Radius	Enabled	Static	
<input type="checkbox"/> 1/0/4	MAC-Based	--	Disabled	Static	

Identity Authentication Management Port Mode

To enable it on a port, select port(s) from the list then click on “**Edit**” button or click on “**Edit icon**” on the right side under operation column.

Note: a RADIUS server must first be added under *Security → RADIUS*.

Port Mode Edit port

Port	The specific port being configured. This field shows the port number (e.g.
User Authentication Mode	The mode of user authentication to be used on this port. Options include: MAC-Based
Guest VLAN	Enables or disables the Guest VLAN for this port. If enabled
Authorized VLAN	Specifies the VLAN ID that authenticated users will be assigned to. This ensures that authorized devices are placed in the correct network segment.
Authentication Methods(x) <i>Note: click on “Add+” to add another method.</i>	
Authentication Method1	Select the authentication method, two options: <ul style="list-style-type: none"> • 802.1X: it will use 802.1x authentication, RADIUS must be first added. • MAC Authentication: it will use local MAC Addresses under Security → Identity Authentication Management page → Local User of MAC-based or RADIUS depending on the selected method.
Method	<ul style="list-style-type: none"> • If MAC Authentication is selected, the user can add two methods: Radius and Local. • If 802.1x is selected, the user can only select radius. <p><i>Note: When Radius is selected, the switch includes the Calling-Station-Id attribute in the Access-Request message, containing the MAC address of the connected device. This allows RADIUS servers to apply identity-based policies and track client devices using their hardware address.</i></p>

Port Mode – Edit port

Port

On this tab, the users can enable on which ports the authentication will take effect, select the port(s) and then click on “**Edit**” button or icon to configure the port(s) as shown below:

Identity Authentication Management								
Port Mode	Port	Authentication Sessions	Local User of MAC-based					
<input type="button" value="Edit"/>								
<input type="checkbox"/>	Port	Port Control	Reauthentication	Max User Count	Reauthentication Timer	Inactive Timer	Quiet Timer	Operation
<input type="checkbox"/>	1/0/1	Force authentication	Enabled	256	3600	60	60	
<input type="checkbox"/>	1/0/2	Auto	Enabled	256	3600	60	60	
<input type="checkbox"/>	1/0/3	Force unauthentication	Enabled	256	3600	60	60	
<input type="checkbox"/>	1/0/4	Disable	Disabled	256	3600	60	60	

Identity Authentication Management port page

To enable the authentication on the port(s), under Port Control (Disable, Force authentication, Force unauthentication, Auto) select Auto or Force authentication and then save the configuration.

Identity Authentication Management > **Edit**

Port: 1/0/1

Port Control: Force authentication

Reauthentication: Enabled

Max User Count: 256 (Valid range is 1-256)

Common Timer

Reauthentication Time (s): 3600 (Valid range is 300-2147483647)

Inactive Interval (s): 60 (Valid range is 60-65535)

Quiet Time (s): 60 (Valid range is 0-65535)

802.1X Parameters Settings

Resend EAP Request (s): 30 (Valid range is 1-65535)

Supplicant Timeout (s): 30 (Valid range is 1-65535)

Identity Authentication Management port edit port

Note:

The 802.1X must be also configured on the device connected to the GWN78xx switch port.

Example of 802.1X configuration on GXV3480 IP Video phone.

802.1X Mode	
< 802.1X Mode	✓
802.1X Mode	EAP-MD5 >
802.1X Identity	hope
802.1X Secret

8021X Mode on GXV3480

Authentication Sessions

On this tab, the authenticated devices will be listed here with more details. Please refer to the figures below:

Identity Authentication Management

Port Mode Port Authentication Sessions Local User of MAC-based

[Refresh](#) [Clear All](#)

Session ID	Port	MAC Address	Status	Configuration		
				VLAN	Session Time (s)	Inactive Time (s)
						

Authentication Sessions

There are three status (Authorized, Locked, Guest):

[Refresh](#) [Clear All](#)

Session ID	Port	MAC Address	Status
000000091184 7958	1/0/6	C0:74:AD:03:CA:80	Authorized

Authentication Sessions Status Authorized

000000091184 7958	1/0/6	C0:74:AD:03:CA:80	Locked
----------------------	-------	-------------------	--------

Authentication Sessions Status Locked

000000091184 7958	1/0/6	C0:74:AD:03:CA:80	Guest
----------------------	-------	-------------------	-------

Authentication Sessions Status Guest

Local User of MAC-based

The "Local User of MAC-based" feature in Grandstream GWN switches provides a way to add and manage users based on their MAC addresses. This feature ensures that only devices with specified MAC addresses are granted network access, enhancing security and control over network resources.

Identity Authentication Management

Port Mode Port Authentication Sessions Local User of MAC-based

[Add](#) [Delete](#) [Delete All](#)

<input type="checkbox"/>	MAC Address	Port Control	VLAN	Reauthentication Time (s)	Inactive Time (s)	Operation
<input type="checkbox"/>	C0:74:AD:01:92:94	Force Unauthorized	--	--	--	✎ 🗑
<input type="checkbox"/>	C0:74:AD:03:CA:80	Force Authorized	1	3600	60	✎ 🗑

Local User of MAC based

Add local User of MAC based

MAC Address	The MAC address of the local user must be a unicast one.
Port Control	<ul style="list-style-type: none"> • Force Authorized: Forces the port to authorize the device with the specified MAC address, allowing it access to the network. • Force Unauthorized: Forces the port to not authorize the device, preventing it from accessing the network.
VLAN	Valid range is 1-4094.
Reauthentication Time (s)	Valid range is 300-2147483647.
Inactive Time (s)	Valid range is 60-65535.

Add local User of MAC-based

DHCP Snooping

DHCP snooping ensures that DHCP clients obtain IP addresses from legitimate DHCP servers, and records the correspondence between IP addresses and MAC addresses of DHCP clients to prevent DHCP attacks on the network.

In order to ensure the security of network communication services, the DHCP Snooping technology is introduced, and a firewall is established between the DHCP Client and the DHCP Server to defend against various attacks against DHCP in the network.

When the device reboots, the dynamic binding table for the IP source guard is automatically restored.

Note: Associated with the "Entries Fixed for DHCPv6 Snooping" option of DHCPv6 Snooping.

Users can configure fixed entries for DHCP Snooping, ensuring that when the device reboots, the dynamic binding table for IP source guard is automatically restored after a fixed duration defined in seconds. Note that this is linked to the 'Entries Fixed for DHCPv6 Snooping' option in DHCPv6 Snooping.

To enable the DHCP Snooping feature on GWN78xx switches, navigate to Security → DHCP Snooping, then enable DHCP Snooping, to make the DHCP snooping enabled on a VLAN, specify the VLANs or a VLAN range for example 5-8 means VLANs from 5 to 8, click "**OK**" button to save. Please refer to the figure below:

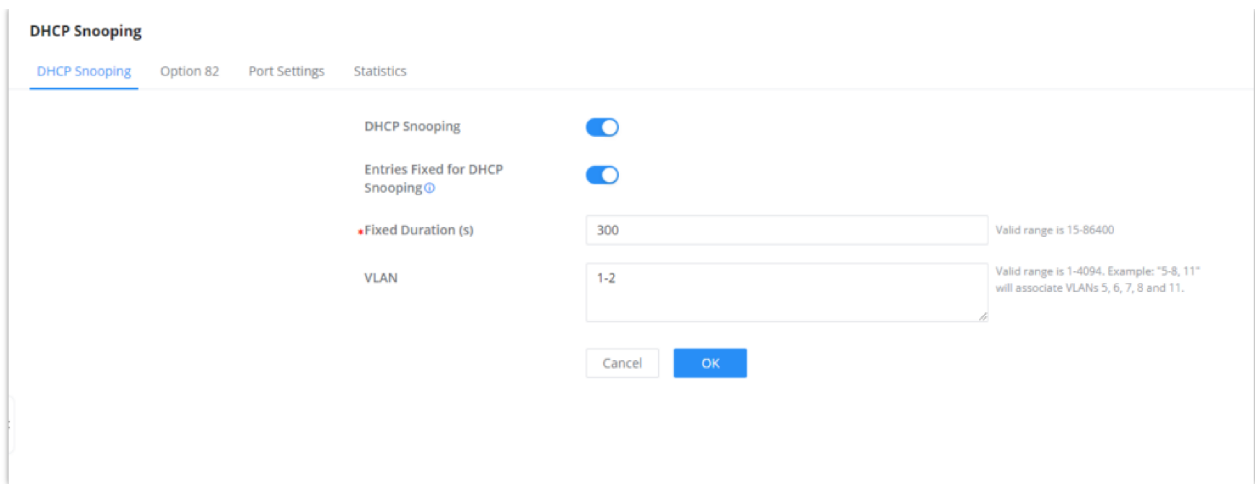

DHCP Snooping General page

DHCP Snooping Option 82

Option 82 is called the relay agent information option and is inserted by the DHCP relay agent when forwarding client-originated DHCP packets to a DHCP server.

To identify the device accessed by the client, the user specifies the Remote ID, the format can be either Normal (standard) or **Private**:

- **Normal Format:** is generally used when interoperability between different vendors' equipment is required, for GWN78xx switches by default the MAC Address of the switch will be used, but any other characters in the range of 1-63 can be used.
- **Private Format:** is specific to the vendor's ecosystem and may not be compatible with other vendors' equipment (check the vendor-specific format).

Option 82 is used to identify both the Circuit ID and Remote ID of the specific port, this can be used to identify the VLAN, interface, and other information where the client is located. To define this information, go to DHCP Snooping → Option 82, choose a specific port:

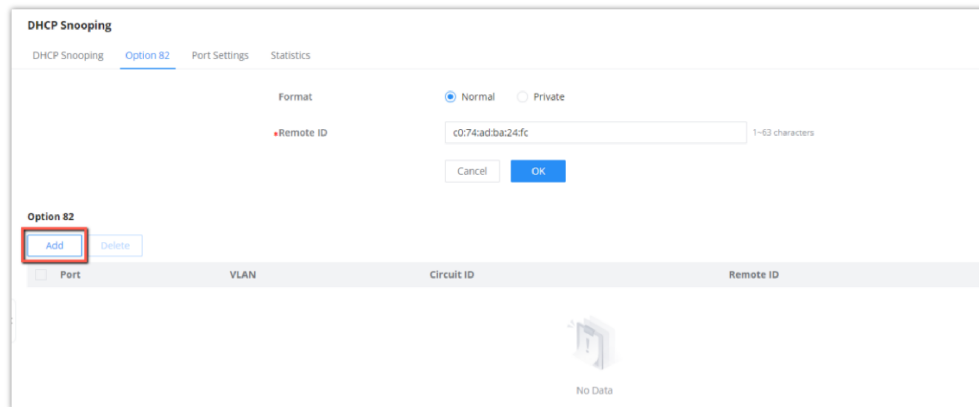

DHCP Snooping Option 82

Then, select a port, VLAN and Format, and specify the Circuit ID and Remote ID:

Add Option 82 ✕

Port

VLAN

Format
 Normal Private

*Circuit ID
1~63 characters

Remote ID
0~63 characters

DHCP Snooping Option 82 Add Circuit

Note

Please note that the Remote ID per port is different from the global remote ID of the switch.

DHCP Snooping Port Settings

On this page, the user can configure the trusted port(s) that will allow DHCP messages, all other ports that are not trusted will discard the DHCP messages, this way GWN78xx will protect users from rogue DHCP servers that are plugged into untrusted ports.

To configure a port(s), either select the port(s) and click on the “**Edit**” button or click on the “**Edit icon**” under the operation column as seen below:

DHCP Snooping							
DHCP Snooping Option 82 Port Settings Statistics							
Edit	Port	Trust Mode	Chaddr Verification	Speed(pps)	Option 82	Option 82 Mode	Operation
<input checked="" type="checkbox"/>	1/0/1	Enabled	Disabled	0	Enabled	Keep	
<input type="checkbox"/>	1/0/2	Disabled	Disabled	0	Disabled	Drop	
<input type="checkbox"/>	1/0/3	Disabled	Disabled	0	Disabled	Drop	
<input type="checkbox"/>	1/0/4	Disabled	Disabled	0	Disabled	Drop	
<input type="checkbox"/>	1/0/5	Disabled	Disabled	0	Disabled	Drop	

DHCP Snooping Port Settings

To make a port trusted, Toggle ON **Trust Mode**, more security parameters can be enabled too like **Chaddr Verification**, **Rate** (pps = packet per seconds) to limit the number of DHCP packets, and enable Option 82 for this port with three modes (keep, drop, replace). Please refer to the figure below:

Port Settings > Edit

Port

Trust Mode

Chaddr Verification

*Rate (pps)
 Valid range is 0-300

Option 82

Option 82 Mode

DHCP Snooping Port Settings Edit

DHCP Snooping Statistics

This page displays all statistics recorded by DHCP snooping function including Forwarding packets, Untrusted Port Drops, etc.

To clear the statistics, select the ports and click on **“Clear”** button as shown below:

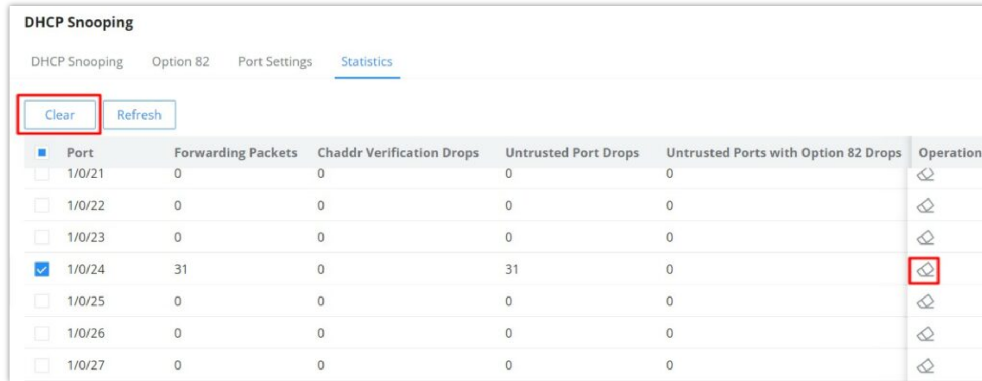

Port	Forwarding Packets	Chaddr Verification Drops	Untrusted Port Drops	Untrusted Ports with Option 82 Drops	Operation
<input type="checkbox"/> 1/0/21	0	0	0	0	
<input type="checkbox"/> 1/0/22	0	0	0	0	
<input type="checkbox"/> 1/0/23	0	0	0	0	
<input checked="" type="checkbox"/> 1/0/24	31	0	31	0	
<input type="checkbox"/> 1/0/25	0	0	0	0	
<input type="checkbox"/> 1/0/26	0	0	0	0	
<input type="checkbox"/> 1/0/27	0	0	0	0	

DHCP Snooping Statistics

DHCPv6 Snooping

DHCPv6 snooping is a security feature in IPv6 networks that safeguards against unauthorized DHCPv6 server messages and controls IPv6 address assignments, similar to how [DHCPv4 snooping](#) operates in IPv4 networks.

To enable the DHCPv6 Snooping feature on GWN78xx switches, navigate to **Security** → **DHCPv6 Snooping**, then enable DHCPv6 Snooping, to make the DHCPv6 snooping enabled on a VLAN, specify the VLANs or a VLAN range for example 5-8 that means VLANs from 5 to 8, click **“OK”** button to save. Please refer to the figure below:

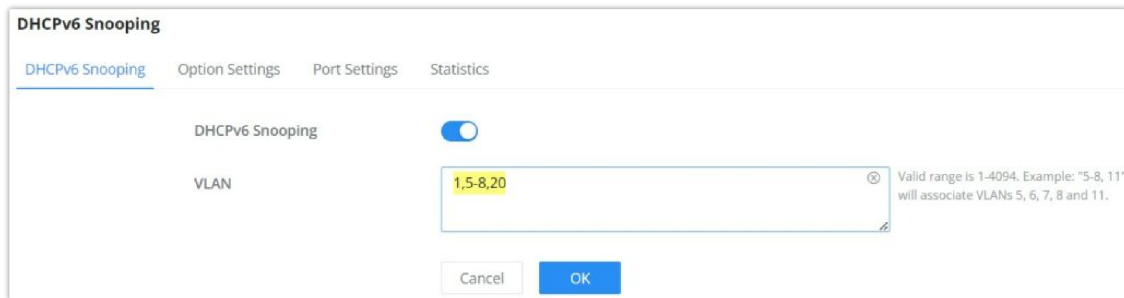

DHCPv6 Snooping

VLAN: Valid range is 1-4094. Example: "5-8, 11" will associate VLANs 5, 6, 7, 8 and 11.

DHCPv6 Snooping

DHCPv6 Snooping Option 18

On this page, the user can configure the Remote ID (Option 37), by default GWN78xx switches use the GWN78xx switches MAC Address.

The DHCPv6 Relay-Option, encompassing Option 18 and Option 37, enables a DHCPv6 relay agent to embed circuit-specific and remote information as a TLV (type-length-value) within the relay message sent to the DHCPv6 server. In this scenario, the managed device functions as a DHCPv6 relay agent.

To add option 18 for a port, click on the **“Add”** button as shown below:

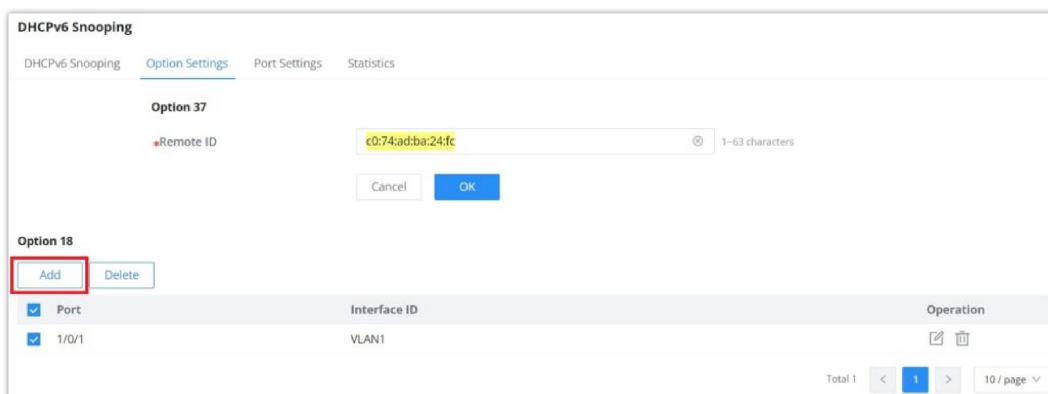

Option 37 Remote ID: 1-63 characters

Option 18

Port	Interface ID	Operation
<input checked="" type="checkbox"/> 1/0/1	VLAN1	

Total 1

Then, select the port, Format (Standard, Extended), when the Standard format is selected then the user can select the VLAN and if the Extended Format is selected the user can interface ID (3~63 characters), click on "OK" to save.

DHCPv6 Snooping Add option 18

DHCPv6 Snooping Port Settings

On this page, the user can configure the trusted port(s) that will allow DHCP messages, all other ports that are not trusted will discard the DHCP messages, this way GWN78xx will protect users from rogue DHCP servers that are plugged into untrusted ports.

To configure a port(s), either select the port(s) and click on the "Edit" button or click on the "Edit icon" under the operation column as seen below:

Port	Trust Mode	Speed	Option 18	Option 37	Operation
<input checked="" type="checkbox"/> 1/0/1	Enabled	300	Drop	Keep	
<input type="checkbox"/> 1/0/2	Disabled	0	Disabled	Disabled	
<input type="checkbox"/> 1/0/3	Disabled	0	Disabled	Disabled	
<input type="checkbox"/> 1/0/4	Disabled	0	Disabled	Disabled	

DHCPv6 Snooping Port Settings

To make a port trusted, Toggle ON **Trust Mode**, more security parameters can be enabled too like **Rate (pps = packet per seconds)** to limit the number of DHCPv6 packets, and enable Option 18 and 37 for this port with three modes (keep, drop, replace). Please refer to the figure below:





DHCPv6 Snooping Port Settings Edit

DHCPv6 Snooping Statistics

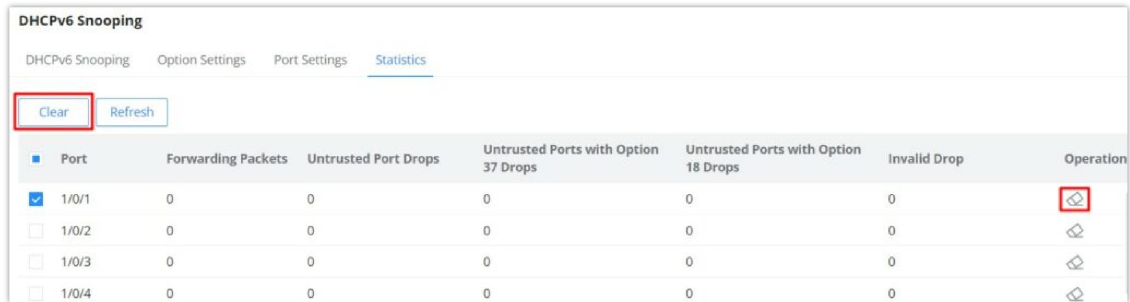
This page displays all statistics recorded by DHCPv6 snooping function including Forwarding packets, Untrusted Port Drops, etc.

To clear the statistics, select the ports and click on "**Clear**" button as shown below:



Port	Forwarding Packets	Untrusted Port Drops	Untrusted Ports with Option 37 Drops	Untrusted Ports with Option 18 Drops	Invalid Drop	Operation
<input checked="" type="checkbox"/> 1/0/1	0	0	0	0	0	
<input type="checkbox"/> 1/0/2	0	0	0	0	0	
<input type="checkbox"/> 1/0/3	0	0	0	0	0	
<input type="checkbox"/> 1/0/4	0	0	0	0	0	

DHCPv6 Snooping Statistics

MAINTENANCE

Upgrade

GWN78xx Switches support manual upload firmware upgrade via a BIN file that can be downloaded from Grandstream Firmware page: <https://www.grandstream.com/support/firmware>.

Upgrading via network is also possible using 5 of these protocols:

- TFTP
- HTTP
- HTTPS
- FTP
- Explicit FTPS

Once the protocol is selected, then the user needs to specify the firmware Server Path (For example: firmware.grandstream.com).

Note:

- Username and Password must be specified if the Server requires it.
- For FTP protocol use the header "**ftp://**" and for FTPS use "**ftps://**"
- Considering the memory problem of the device, the upload upgrade supports streaming upgrade, and the upgrade is carried out while uploading.

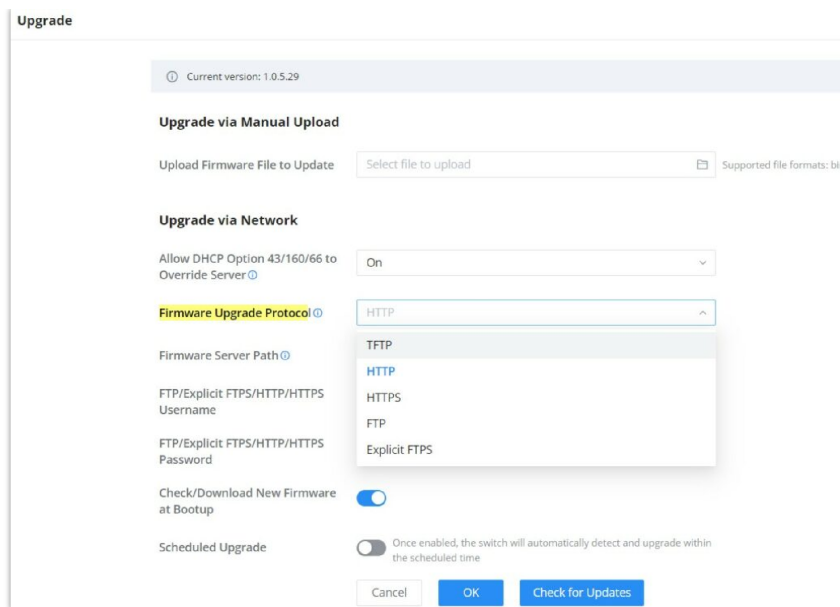

Upgrade

Diagnostics

GWN78xx Switches support many diagnostics tools that can help the user troubleshoot the issue and resolve it. These tools include Logs, Ping, Traceroute, Mirroring, Fiber Module, Copper Test, and One-Click Debugging.

Logs

This page lists all the generated Logs with details level and generated time, also an option to export the list is available.

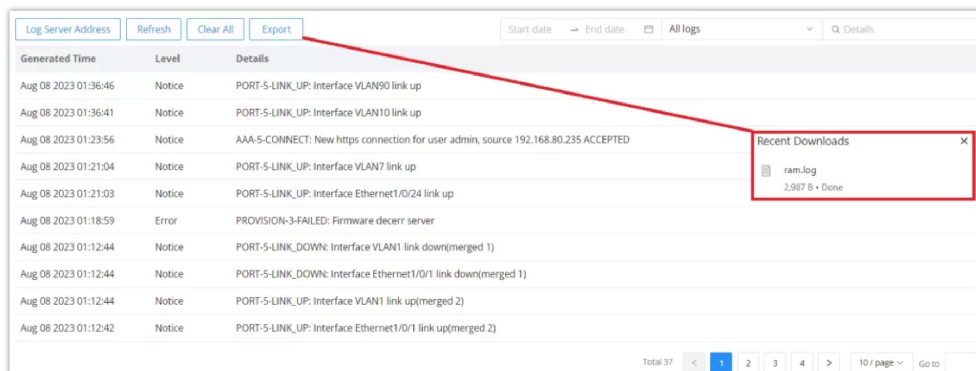

Diagnostics Logs

Adding a Log Server Address to the logs to be sent to is also supported on the GWN78xx Switches.

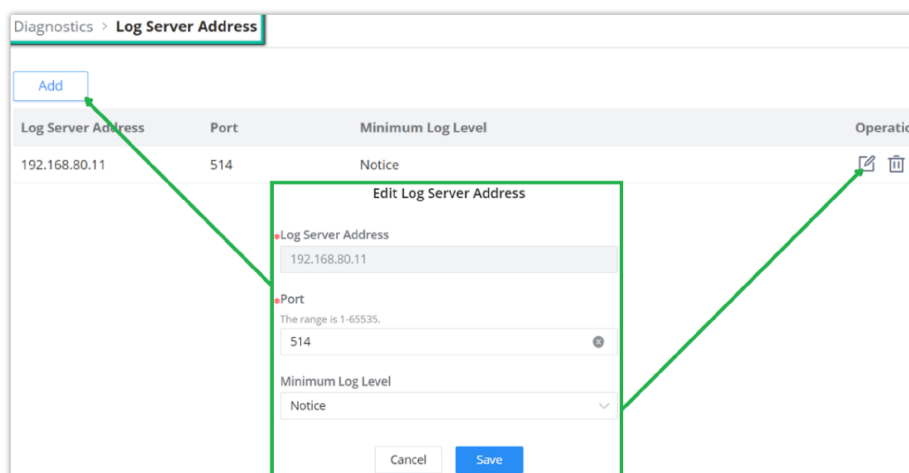

Log Server Address

Users can Configure the following elements in the logs settings:

- **Minimum log level:** This defines the lowest severity of events that will be logged. "Debug" means all messages, including detailed diagnostic information, will be recorded. Other log levels (e.g., Info, Warning, Error) would filter out lower-priority messages.
- **Log Aggregation:** This option allows you to merge multiple logs from various sources or components into a centralized location for easier monitoring, analysis, and management.
- **Timeout:** This setting defines the time, in seconds, before the logging operation times out. In the example shown, the timeout is set to 60 seconds. The valid range for the timeout is between 15 and 3600 seconds.

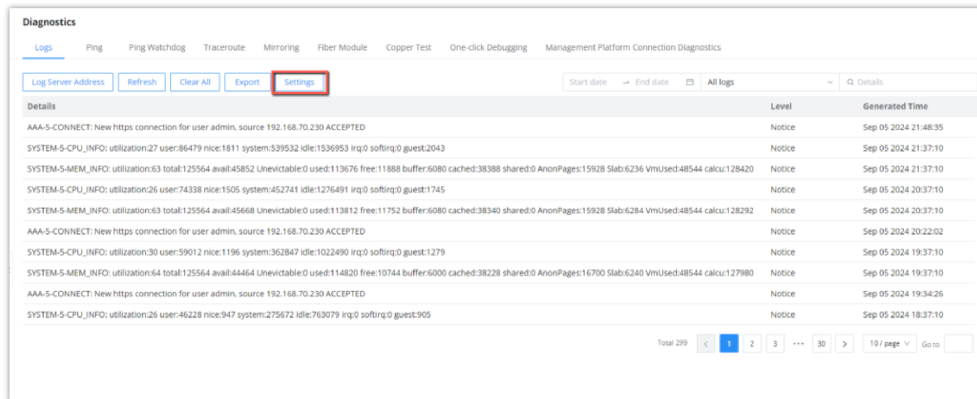

Log Diagnostics

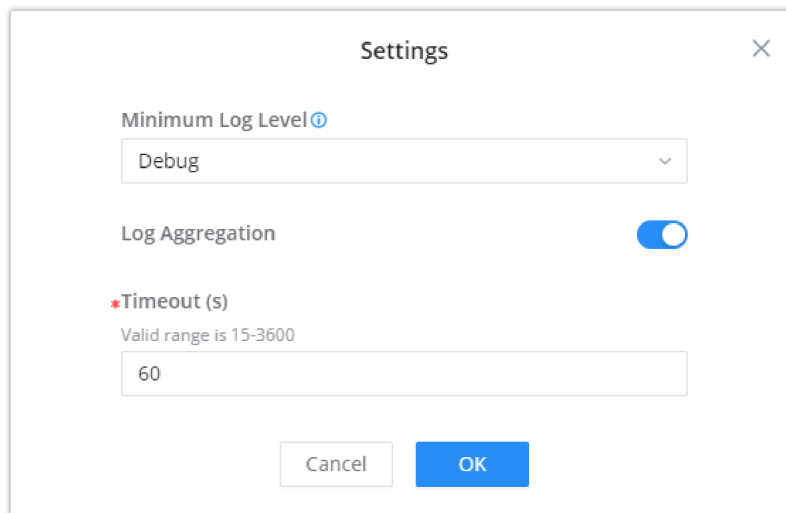

Log Diagnostics

Ping

The user in this page can enter the IP Address or Hostname then click "Start", the results of the ping command will be shown below.

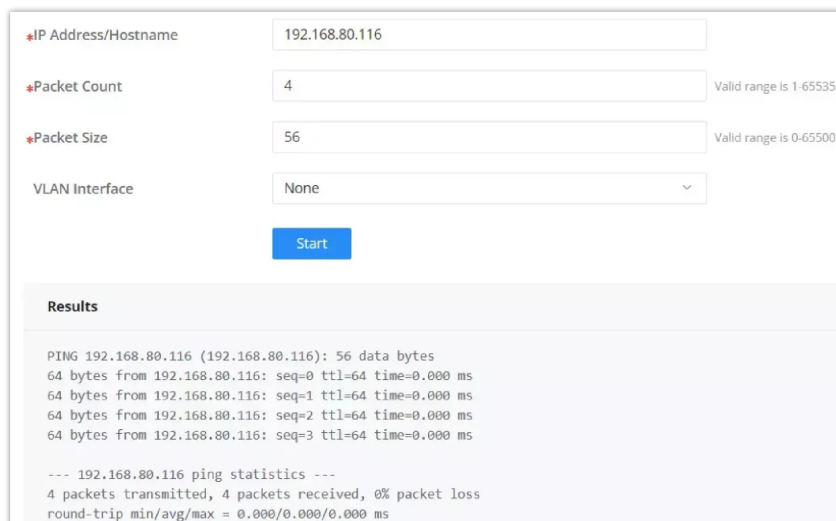

Ping

Ping Watchdog

Ping Watchdog is a feature designed to monitor the connectivity of a device by continuously pinging a specified IP address. If the device becomes unresponsive to pings, then corrective actions can be triggered based on the configuration settings.

Port: Specifies the port on the device that will be monitored or managed by Ping Watchdog.

Enable: Toggles the Ping Watchdog feature on or off for the selected port.

IP Address: The target IP address to which the device will send ping requests.

Packet Sending Interval (s): Defines how frequently (in seconds) ping packets are sent to the specified IP address.

Delay Time (s): This sets a delay before the Ping Watchdog starts monitoring the device after it's enabled or after a reboot.

Retry Times: Specifies how many failed ping attempts are allowed before the watchdog takes action.

Shutdown Interval (s): how long the switch keeps the port *shutdown* before bringing it back up after a Ping Watchdog failure.

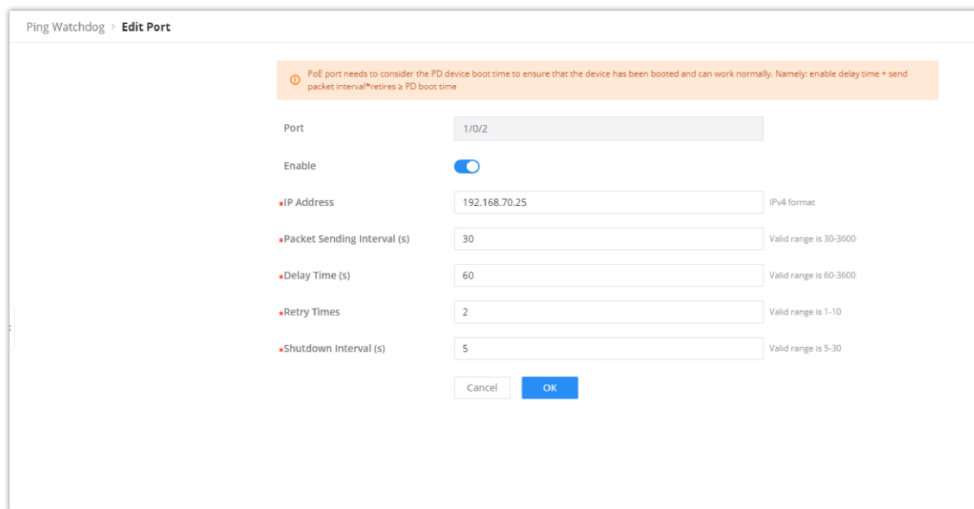

The screenshot shows the 'Ping Watchdog > Edit Port' configuration page. At the top, there is a warning message: 'Full port needs to consider the PD device boot time to ensure that the device has been booted and can work normally. Namely: enable delay time + send packet interval * retries > PD boot time'. Below this, the configuration fields are as follows:

Field	Value	Notes
Port	1/0/2	
Enable	<input checked="" type="checkbox"/>	
IP Address	192.168.70.25	IPv4 format
Packet Sending Interval (s)	30	Valid range is 30-3600
Delay Time (s)	60	Valid range is 60-3600
Retry Times	2	Valid range is 1-10
Shutdown Interval (s)	5	Valid range is 5-30

At the bottom, there are 'Cancel' and 'OK' buttons.

Ping watchdog

Traceroute

Another tool is Traceroute which shows the number of hops, and GWN78xx Switches enables the user to run Traceroute commands right from the Switches WEB UI.

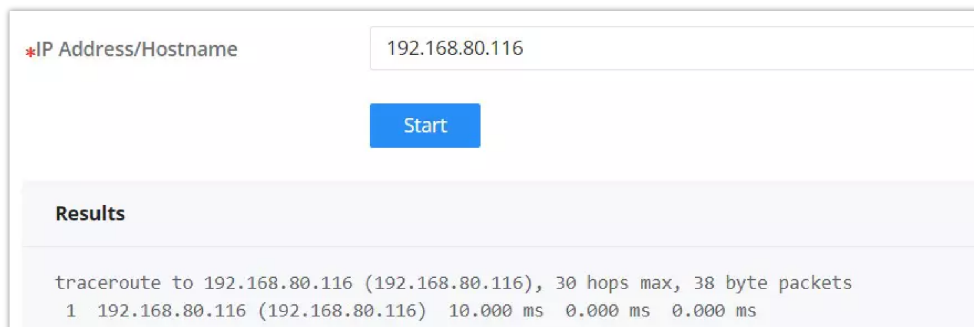

The screenshot shows the Traceroute configuration and results page. The configuration part includes:

- IP Address/Hostname: 192.168.80.116
- A 'Start' button.

The results section shows the following output:

```
tracert to 192.168.80.116 (192.168.80.116), 30 hops max, 38 byte packets
 1 192.168.80.116 (192.168.80.116) 10.000 ms 0.000 ms 0.000 ms
```

Traceroute

Mirroring

Mirroring refers to copying the packets from the specified source to the destination port. The specified source is called the mirroring source, the destination port is called the observing port, and the copied packet is called the mirroring packet.

Mirroring can make a copy of the original packet without affecting the normal processing of the original packet by the device, and send it to the monitoring device through the observation port to determine whether the service running on the network is normal.

The GWN78xx switches support two modes of Port Mirroring: SPAN and RSPAN:

- **SPAN (Local):** Traffic is mirrored locally within the same switch.
- **RSPAN (Remote):** Traffic is mirrored remotely across a network using a Remote VLAN.

SPAN

The traffic mirroring occurs locally within the same switch. SPAN allows you to capture traffic from one or more ports and send a copy of it to another port, typically connected to a network analyzer or monitoring tool.

- **Ingress Mirroring:** Captures incoming traffic on the source port(s).
- **Egress Mirroring:** Captures outgoing traffic from the source port(s).
- **Source Port:** Where the traffic originates (the port being monitored).
- **Tx/Rx Regular Data Messages:** defines what type of traffic (transmit, receive, or both) is monitored on the destination switch.

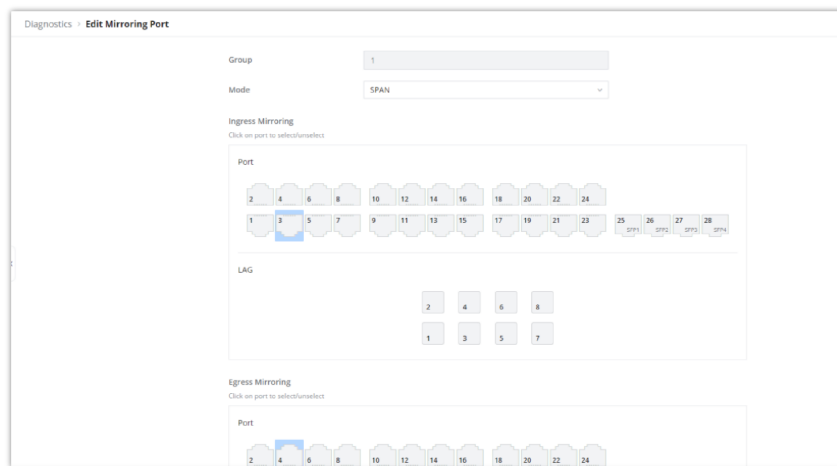

Port Mirroring

RSPAN

RSPAN (Remote Switched Port Analyzer) allows traffic to be mirrored from one switch to another over a network. Unlike SPAN, which is limited to mirroring traffic locally within the same switch, RSPAN uses a **Remote VLAN** to transport mirrored traffic across multiple switches, enabling centralized monitoring.

Source Switch Role (RSPAN)

- **Ingress Mirroring:** This captures incoming traffic on the specified source port(s). It mirrors the packets received by the port before they are processed by the switch, forwarding them to the designated destination for monitoring or analysis.
- **Egress Mirroring:** This captures outgoing traffic from the specified source port(s). It mirrors the packets leaving the port after the switch processes them, forwarding these packets to the monitoring destination.
- **Output Port:** This is the port on the source switch where the mirrored traffic is sent. In SPAN, it's usually a local port that connects to the monitoring device, but in RSPAN, this traffic is forwarded across a network using the Remote VLAN to the destination switch.
- **Remote VLAN:** This is the VLAN used to transport mirrored traffic between the source switch and the destination switch in an RSPAN configuration. The source switch forwards mirrored traffic to this VLAN, which allows it to be sent across the network to the destination switch for analysis.

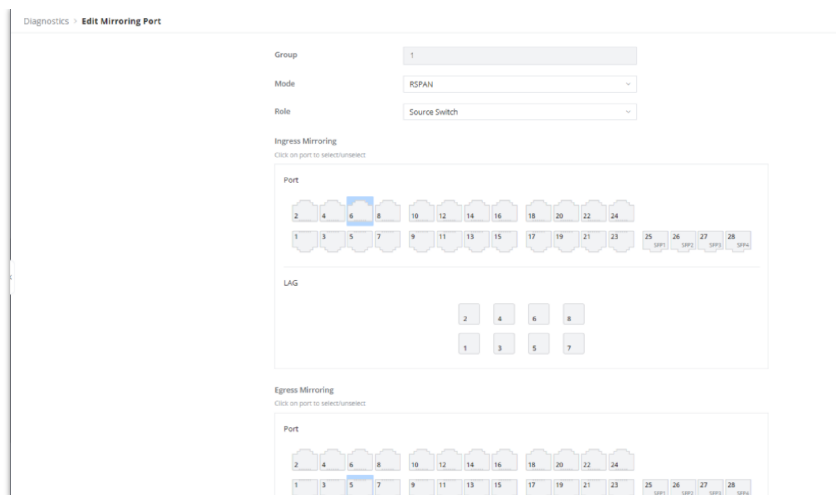

Source Switch Role

Destination Switch Role (RSPAN)

- **Source Port:** This is the remote VLAN where the mirrored traffic from the source switch arrives. The destination switch receives the mirrored packets via this VLAN and forwards them to the appropriate monitoring port.
- **Monitor Port TX/RX:** This defines what type of traffic (transmit, receive, or both) is monitored on the destination switch.
- **Remote VLAN:** The VLAN used to receive mirrored traffic from the source switch. It's the same VLAN that the source switch uses to forward the mirrored traffic over the network to the destination switch.

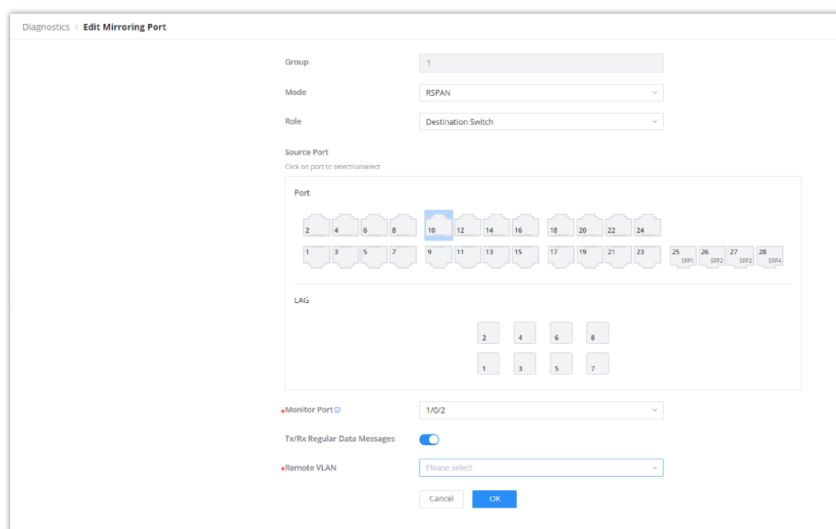

Destination Switch Role RSPAN

Fiber Module

This page provides the user with the information about the fiber module for each Port that supports it. Select the port from the drop-down list and click refresh icon.

Note: The information displayed on the optical module of each manufacturer is different.

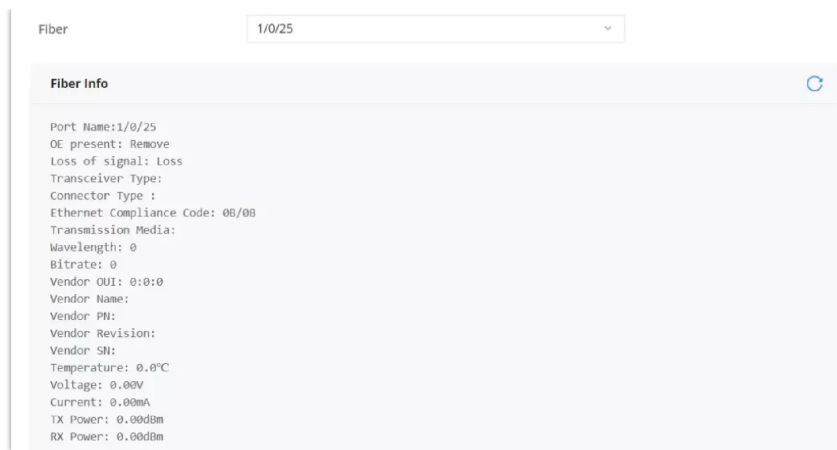

Fiber Module

Copper Test

Copper test can detect whether the cable connected to the switch is faulty and the location of the fault. Using this function can assist in the daily engineering installation diagnosis .

Please navigate to **Web UI** → **Maintenance** → **Diagnostics page** → **Copper Test Tab**.

Note:

When performing cable detection, please ensure that the electrical port is not in the UP state, otherwise the detection result will not be available.

To perform the test simply click on the port, please refer to the figure below:

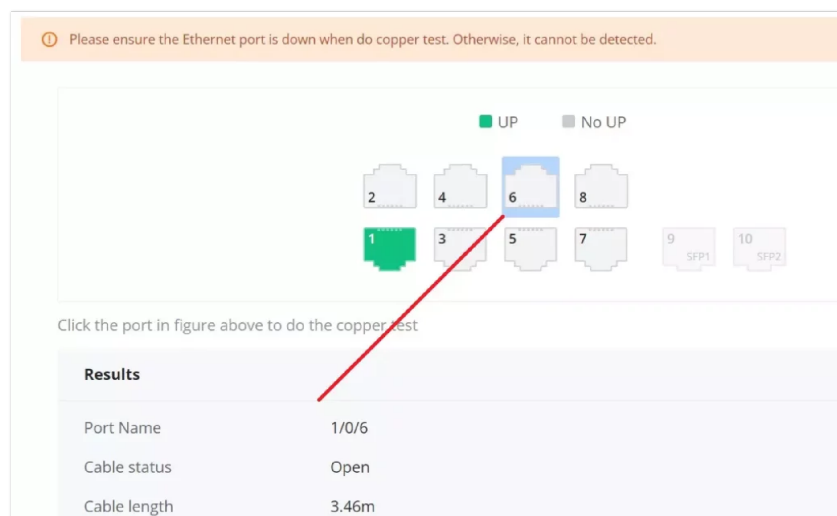

Copper Test

After the detection, the cable detection result is displayed as follows:

Cable Status: OK (normal), Open (open circuit), Short (short circuit), Crosstalk (crosstalk), Unknown (unknown).

Cable Length:

- When there is a fault: it is the length from the port to the fault location.
- When there is no fault: it is the actual length of the cable.

One-click Debugging

On GWN78xx switches, One-click debugging feature can help administrators or tech-support to quickly and easily get debugging information about the GWN switch in a matter of few minutes.

Please navigate to **Web UI** → **Maintenance** → **Diagnostics page** → **One-click Debugging tab**, then click on **"Debug"** button to start the debugging process.

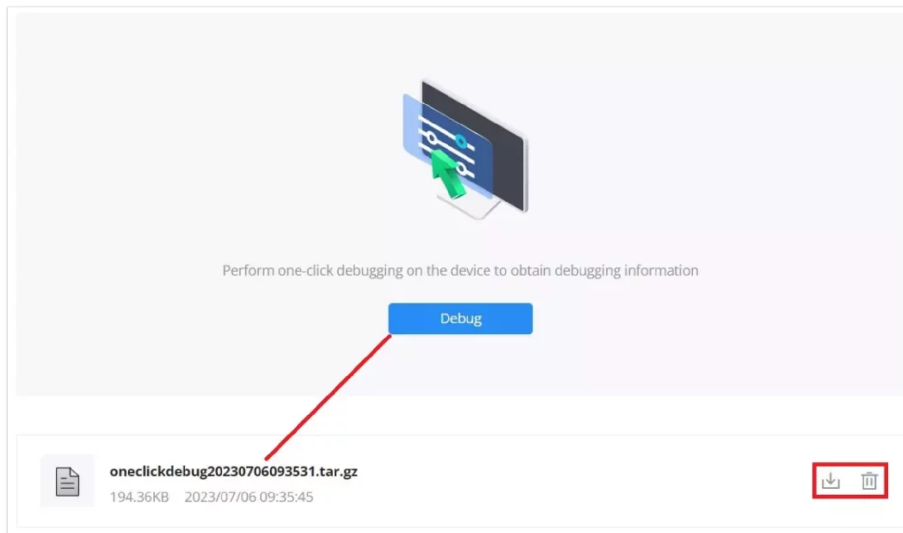

One click Debugging

It's also possible to delete the generated file or download it locally to share it with tech-support for example. The folder contains many logs files and even a tech-support file that containing valuable information like the switch configuration etc.

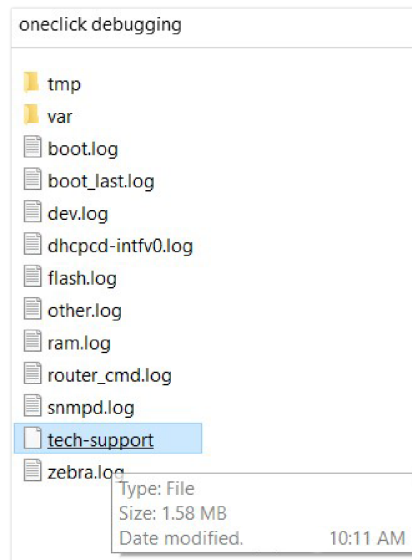

One click Debugging Folder

Management Platform Connection Diagnostics

If the GWN78xx switch is added to the GDMS networking ,GWN Manager, or a GWN Router, it will display a Cloud icon with a green check mark (as shown in the figure below) indicating it's added to a GDMS Networking account, GWN Manage, or to a GWN Router.

In case there is an issue with the connection, then the user can navigate to **Maintenance** → **System Diagnosis** → **Cloud/Manager Connection Diagnostics** and then click on **"Detection"** or **"Redetection"** button to see in what stage/step the connection has failed. Refer to the figure below:

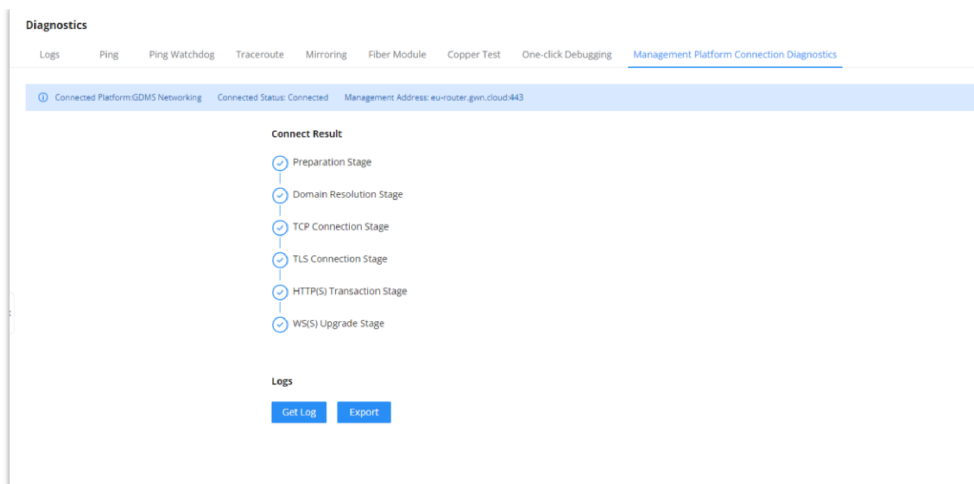

CloudManager Connection Diagnostics

Backup and Restore

Click on "Factory Reset" button to reset the GWN78xx Switch back to default settings, or restore to previously saved backup by uploading a configuration file, these configuration files can be used as a way to back up the device running configuration or saved configuration.

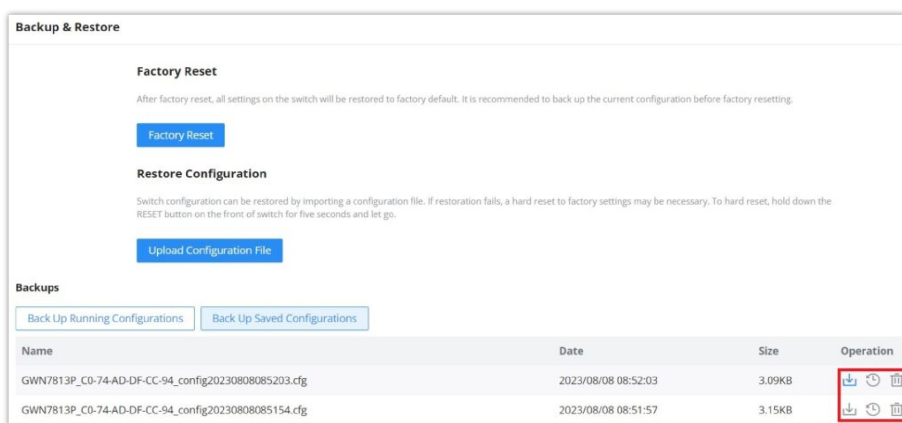

Backup and Restore

SNMP

Network Management Protocol (SNMP) is an "Internet-standard protocol for managing devices on IP networks". Devices that typically support SNMP include routers, switches, servers, workstations, printers, modem racks and more. SNMP is used mostly in network management systems to monitor network-attached devices for conditions that warrant administrative attention. SNMP is a component of the Internet Protocol Suite as defined by the Internet Engineering Task Force (IETF). It consists of a set of standards for network management, including an application layer protocol, a database schema, and a set of data objects. An SNMP-managed network consists of three key components:

- Managed device
- Agent – software which runs on managed devices
- Network management station (NMS) – software which runs on the manager

A managed device is a network node that implements an SNMP interface that allows unidirectional (read-only) or bidirectional (read and write) access to node-specific information. Managed devices exchange node-specific information with the NMSs. Sometimes called network elements, the managed devices can be any type of device, including, but not limited to, routers, access servers, switches, bridges, hubs, IP telephones, IP video cameras, computer hosts, and printers. An agent is a network-management software module that resides on a managed device. An agent has local knowledge of management information and translates that information to or from an SNMP-specific form. A network management station (NMS) executes applications that monitor and control managed devices. NMSs provide the bulk of the processing and memory resources required for network management. One or more NMSs may exist on any managed network.

The global settings page allows the user to enable the SNMP function with the Local Engine ID or add a Remote Engine ID.

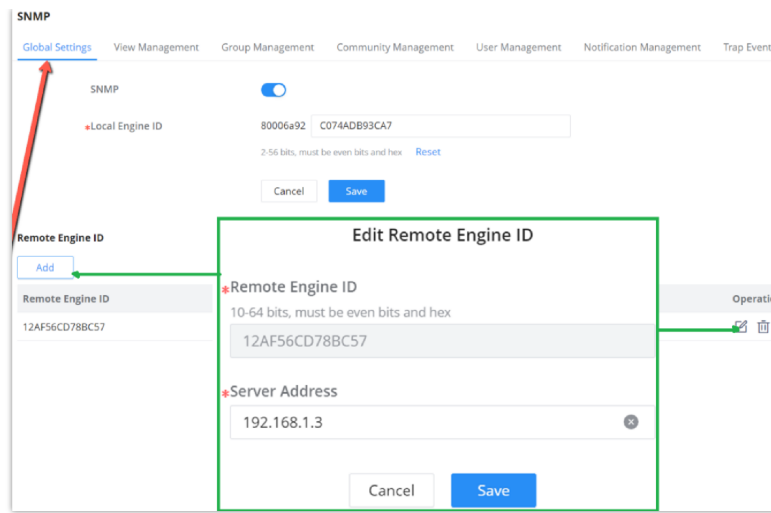

SNMP Global Settings

SNMP	Select whether to enable SNMP.
Local Engine ID	Set the engine ID of the local SNMP entity or click “Reset” to restore to the initial value. <i>Note: The default is 8000 A59Dxxxxxxx, where xxxxxxx is the device MAC address by default, which can be modified by the user . It is expressed in hexadecimal , and the length is limited between 2 and 56 characters. The number of characters must be an even number .</i>
Edit Remote Engine ID	
Remote Engine ID	Set the engine ID of the SNMP management side , and the remote user is established under the remote engine. The input length is limited to 10-64 characters, expressed in hexadecimal , and the number of characters must be an even number.
Server Address	Set the address of the network management station server, support input of Hostname and IP address (including IPv4 and IPv6), and need to meet the requirements of various types of address formats, otherwise an error message is required.

SNMP Global Settings

View Management

This page allows the network administrator to create MIB views (Management information base) and then include or exclude OID (Object Identifier) in a view.

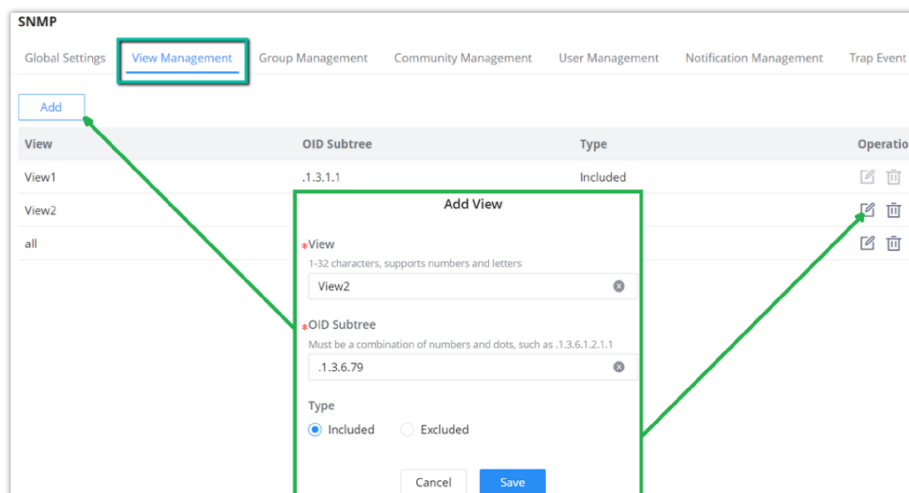

SNMP View Management

Group Management

This page allows the network administrator to group SNMP users and assign different authorization and access privileges.

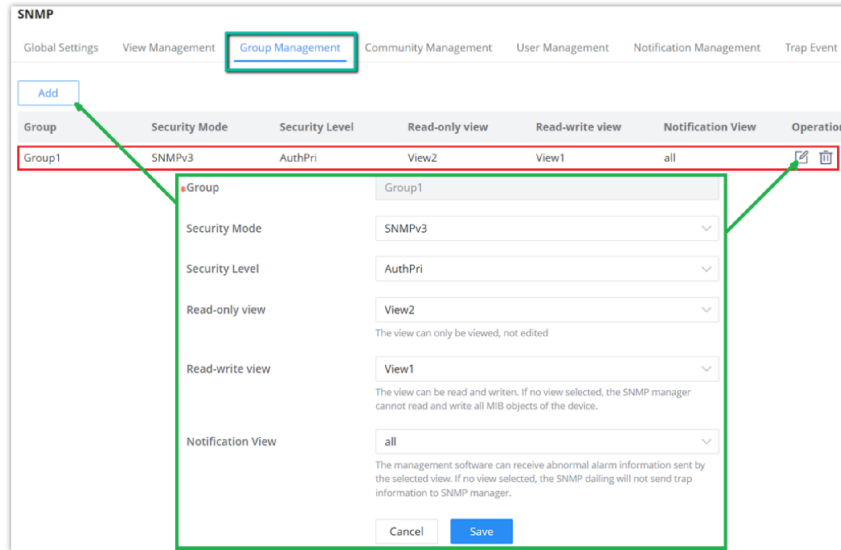

SNMP Group Management

Community Management

This page allows a user to add/remove multiple communities of SNMP.

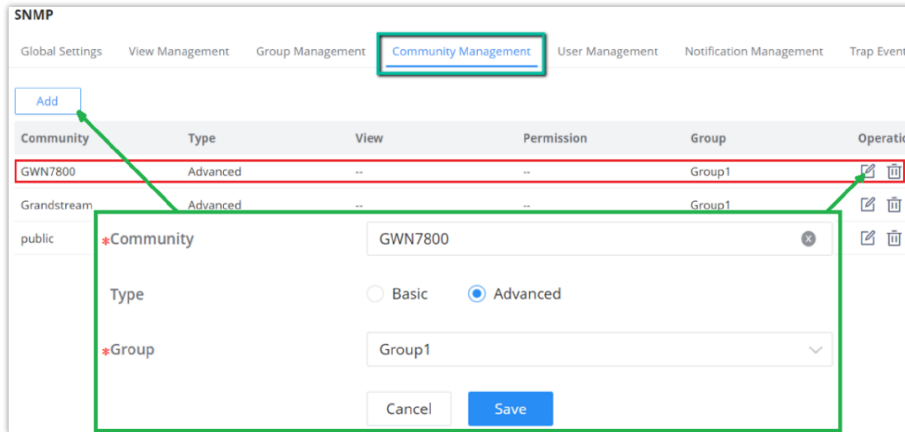

SNMP Community Management

SNMP User Management

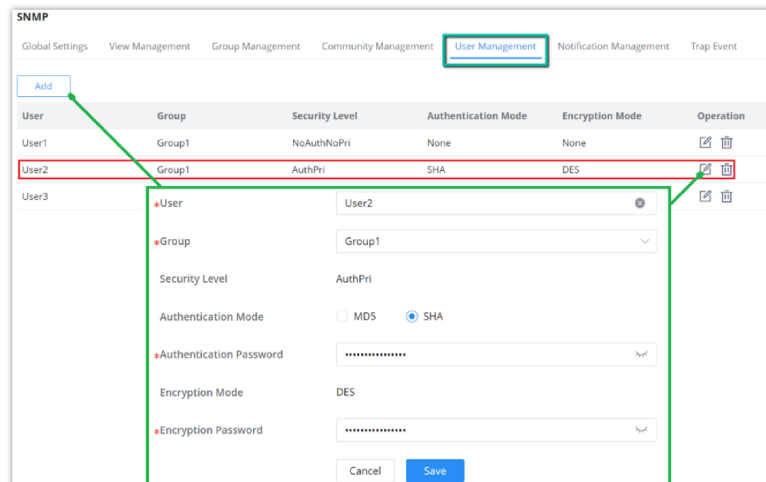

This page allows a user to configure the SNMPv3 user profile.



SNMP User Management

Notification Management

This page allows a user to configure a host to receive SNMPv1/v2/v3 notification.

Server Address	UDP Port	Security Mode	Notification Type	Community/User	Security Level	Timeout (s)	Maximum Retries	Operation
192.168.5.11	162	SNMPv3	Traps	User1	AuthPri	--	--	 

Configuration details for the highlighted row:

- Server Address: 192.168.5.11
- UDP Port: 162
- Security Mode: SNMPv3
- Notification Type: Traps Informs
- User: User1
- Security Level: AuthPri
- Timeout (s): 300
- Maximum Retries: 255

SNMP Notification Management

Trap Event

a **Trap event** refers to an alert or notification that is automatically sent by a device or system when a specific event occurs. These events, shown in the SNMP configuration, are various types of conditions that the system is monitoring. When enabled, the device sends a trap to the SNMP manager, notifying it of occurrences like:

- **Authentication failed:** When there is an unauthorized login attempt.
- **Port Up/Down:** When a network port goes offline or comes online.
- **Cold Start/Warm Start:** When the system or device reboots (cold or warm restart).

Authentication failed	<input checked="" type="checkbox"/>
Port Up/Down	<input checked="" type="checkbox"/>
Cold Start	<input checked="" type="checkbox"/>
Warm Start	<input checked="" type="checkbox"/>
STP Bridge	<input type="checkbox"/>
CPU	<input type="checkbox"/>
Monitor	<input type="checkbox"/>
Port ErrDisable	<input type="checkbox"/>
Port Security	<input type="checkbox"/>
PoE Power Supply	<input type="checkbox"/>
Logs	<input type="checkbox"/>
Configuration Distribution	<input type="checkbox"/>

SNMP Trap Event

RMON

RMON (Remote Monitoring) based on SNMP (Simple Network Management Protocol) architecture, functions to monitor the network. RMON is currently a commonly used network management standard defined by the Internet Engineering Task Force (IETF), which is mainly used to monitor the data traffic across a network segment or even the entire network to enable the network administrator to take protection measures in time to avoid any network malfunction. In addition, RMON MIB records network statistics information on network performance and malfunction periodically, based on which the management station can monitor the network at any time effectively. RMON is helpful for network administrators to manage the large-scale network since it reduces the communication traffic between the management station and the managed agent.

Note:

 Please enable [SNMP>Global Settings>SNMP](#) first before RMON takes effect

RMON Statistics

Ethernet statistics function (corresponding to the statistics group in the RMON MIB): The system collects basic statistics of each network being monitored. The system will continuously count the traffic of a certain network segment and the distribution of various types of packets, the number of error frames of various types, the number of collisions, etc. The number of data packets, the number of broadcast and multicast packets, the number of received bytes, the number of received packets, etc.

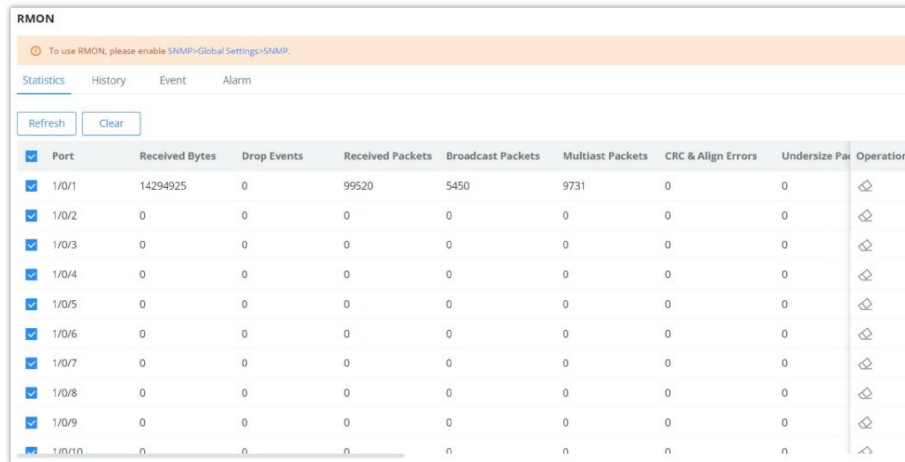

The screenshot shows the RMON Statistics page with a table of network ports and their statistics. The table has columns for Port, Received Bytes, Drop Events, Received Packets, Broadcast Packets, Multicast Packets, CRC & Align Errors, Undersize Packets, and Operation. The first row shows port 1/0/1 with 14294925 Received Bytes and 99520 Received Packets. The other rows show zero values for all statistics.

Port	Received Bytes	Drop Events	Received Packets	Broadcast Packets	Multicast Packets	CRC & Align Errors	Undersize Packets	Operation
1/0/1	14294925	0	99520	5450	9731	0	0	
1/0/2	0	0	0	0	0	0	0	
1/0/3	0	0	0	0	0	0	0	
1/0/4	0	0	0	0	0	0	0	
1/0/5	0	0	0	0	0	0	0	
1/0/6	0	0	0	0	0	0	0	
1/0/7	0	0	0	0	0	0	0	
1/0/8	0	0	0	0	0	0	0	
1/0/9	0	0	0	0	0	0	0	
1/0/10	0	0	0	0	0	0	0	

RMON Statistics

RMON History

The system will periodically collect statistics on various traffic information, including bandwidth utilization, number of error packets, and total number of packets based on the History ID.

Click on the "Add" button to create a History ID specifying the Port as well.

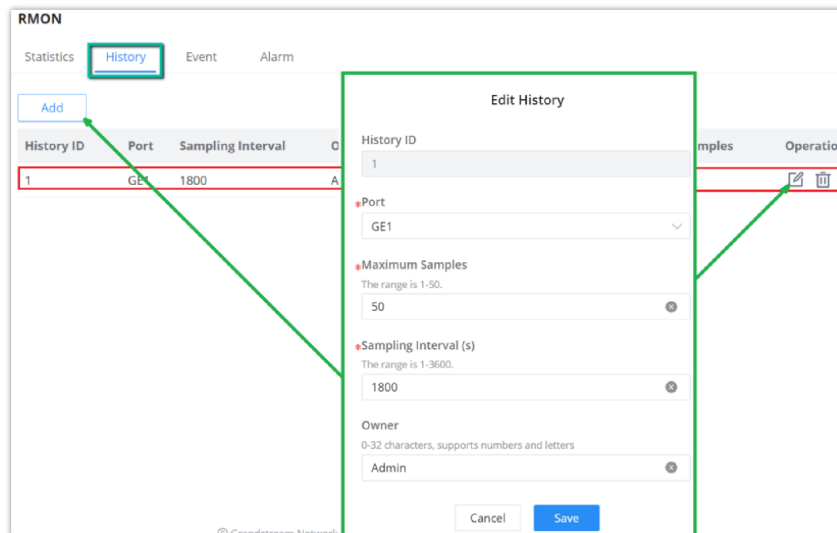

The screenshot shows the RMON History page with the 'Edit History' dialog box open. The dialog box has fields for History ID, Port, Maximum Samples, Sampling Interval (s), and Owner. The History ID is 1, Port is GE1, Maximum Samples is 50, Sampling Interval (s) is 1800, and Owner is Admin. The dialog box also has 'Cancel' and 'Save' buttons.

RMON History

RMON Event

The event group controls the events and prompts from the device and provides all events generated by the RMON Agent. When an event occurs, it can record logs or send Trap to the network management station.

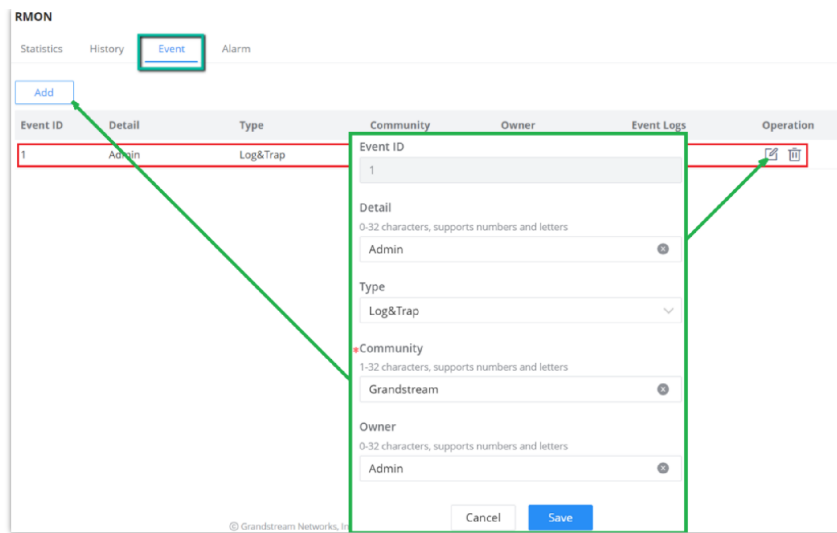

RMON Event

RMON Alarm

The system monitors the specified alarm variable. After pre-defining a set of thresholds and sampling time for the specified alarm, the system will obtain the value of the specified alarm variable according to the defined time period. When the value of the alarm variable is greater than or equal to the upper threshold, an upper alarm event will be triggered. When the value of the alarm variable is less than or equal to the lower threshold, a lower alarm event is triggered.

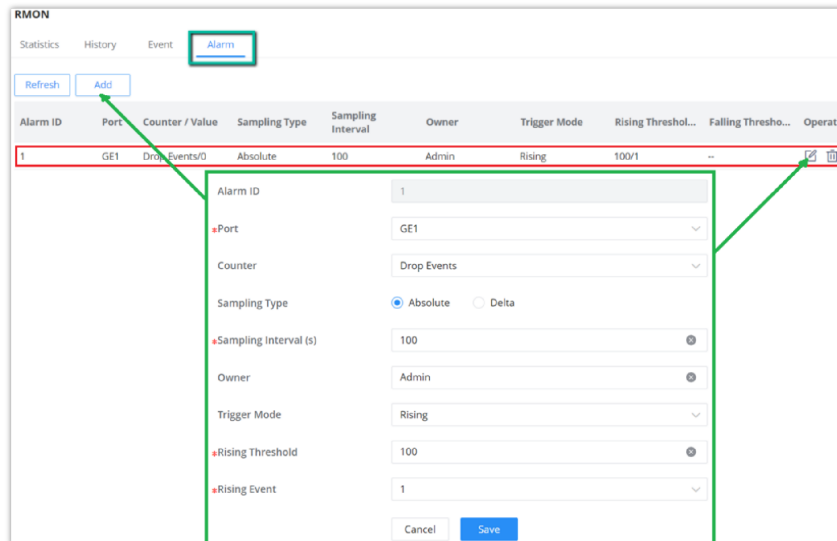

RMON Alarm

LLDP/LLDP MED

LLDP/LLDP MED is a one-way protocol, there are no request/response sequences. Information is advertised by stations implementing the transmit function, and is received and processed by stations implementing the receive function.

LLDP MED is an enhancement to LLDP that provides additional functionality to support media devices. LLDP MED features include: enabling network policy advertisement and discovery for real-time applications (such as voice and/or video);

LLDP Global Settings

This page allows a user to set general settings for LLDP including enabling LLDP and other parameters.

LLDP/LLDP-MED

LLDP Global Settings | LLDP MED Network Policy | LLDP MED Port Settings | Device Info | Neighbor Info | Statistics

LLDP

TLV Advertise Interval (s) Valid range is 5-32767

TLV Multiplier Valid range is 2-10

Port Reinitializing Delay Time (s) Valid range is 1-10

LLDPDU Transmit Delay Time (s) Valid range is 1-8192

Cancel OK

Port Settings

Edit

Port	Mode	TLV	Operation
<input checked="" type="checkbox"/> 1/0/1	Tx/Rx	PortDescription, SysName, SysDescription, SysCapabilities, ManagementAddrSel, PVID, MacPhySel, Lin...	
<input checked="" type="checkbox"/> 1/0/2	Tx/Rx	PortDescription, SysName, SysDescription, SysCapabilities, ManagementAddrSel, PVID, MacPhySel, Lin...	
<input checked="" type="checkbox"/> 1/0/3	Tx/Rx	PortDescription, SysName, SysDescription, SysCapabilities, ManagementAddrSel, PVID, MacPhySel, Lin...	

LLDP Global Settings

More configurations can adjusted per port (GE1 to GE10).

LLDP Global Settings > **Edit Port Settings**

Port

Mode

TLV

Basic TLV

Port Description TLV System Name TLV

System Description TLV System Capabilities TLV

Management Address TLV

IEEE 802.1TLV

Port VLAN ID TLV VLAN Name TLV

IEEE 802.3TLV

MAC/PHY Configuration/Status TLV Link Aggregation TLV

Maximum Frame Size TLV Power via MDI TLV

Cancel OK

LLDP Port Settings

LLDP MED Network Policy

This page allows the network administrator to set the MED (Media Endpoint Discovery) network policy. Click on the **"Add"** button to add a Network Policy or toggle ON **Auto Voice Network Policy** (Voice VLAN has to be configured as well).

LLDP/LLDP-MED

LLDP Global Settings | **LLDP MED Network Policy** | LLDP MED Port Settings | Device Info | Neighbor Info | Statistics

Fast Report Count Valid range is 1-10

Auto Voice Network Policy

Cancel OK

Network Policy

Add Delete

Policy ID	Application	VLAN	VLAN Tag	CoS	DSCP	Operation
<input checked="" type="checkbox"/> 1	Voice	7	Tagged	6	43	

LLDP MED Network Policy

To add a Network Policy, click on the **"Add"** button or click on the **"Edit"** icon under the Operation column to edit.

LLDP MED Network Policy > **Edit Network Policy**

Policy ID	1
Application	Voice
*VLAN	7 <small>Valid range is 0-4095</small>
VLAN Tag	Tagged
CoS	6
DSCP	43

Cancel OK

Add/Edit Network Policy

LLDP MED Port Settings

The user can configure LLDP MED Settings for each port on this page.

LLDP/LLDP MED

LLDP Global Settings LLDP MED Network Policy **LLDP MED Port Settings** Device Info Neighbor Info Statistics

Edit

Port	LLDP MED	Network Policy TLV	Inventory TLV	Location Identification TLV	PoE-PSE TLV	Operation
<input checked="" type="checkbox"/> GE1	Enabled	Enabled	Enabled	Disabled	Disabled	
<input type="checkbox"/> GE2						
<input type="checkbox"/> GE3						
<input type="checkbox"/> GE4						
<input type="checkbox"/> GE5						
<input type="checkbox"/> GE6						
<input type="checkbox"/> GE7						
<input type="checkbox"/> GE8						
<input type="checkbox"/> GE9						
<input type="checkbox"/> GE10						

Port GE1

LLDP MED

Network Policy TLV

*Network Policy Voice 1 Add Network Policy +

Inventory TLV

Location Identification TLV

PoE-PSE TLV

Cancel Save

LLDP MED Port Settings

LLDP Device Info

This page displays information for LLDP Local Device connected to each port. Click on the port to view related LLDP information about that port, the information includes: Basic Info, **IEEE 802.1 TLVs** information, **IEEE 802.3 TLVs (802.3 bt)** information, **MED Details**, **Network Policy**...

LLDP/LLDP-MED

LLDP Global Settings LLDP MED Network Policy LLDP MED Port Settings **Device Info** Neighbor Info Statistics

Local Device Info

Chassis ID Subtype	MacAddr
Chassis ID	CO:74:AD:...
Device Name	GWN7813P
System Description	GWN7813P
Supported System Capabilities	Bridge, Router
Enabled System Features	Bridge, Router
Port ID Subtype	Local

Local Port Info

Click port figure above to view related LLDP and LLDP-MED details

Basic Info

Chassis ID Subtype	MacAddr
Chassis ID	CO:74:AD:...
Device Name	GWN7813P
System Description	GWN7813P
Supported System Capabilities	Bridge, Router
Enabled System Features	Bridge, Router

LLDP Device Info

Neighbor Info

This page lists the neighbors obtained on the switch ports. Click on the "Refresh" button to update the list.

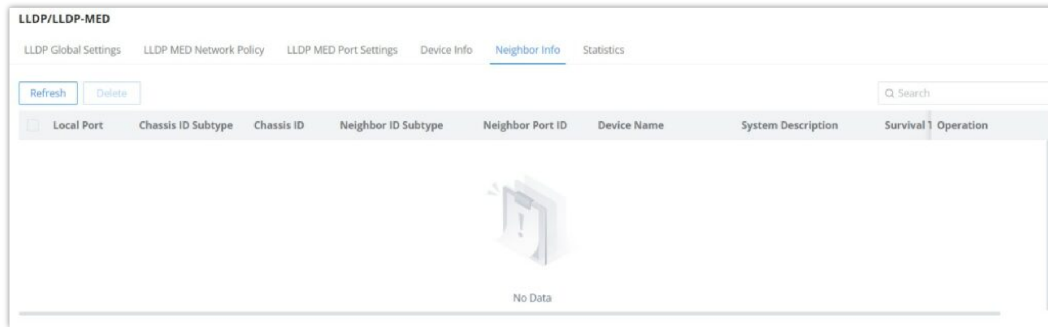

LLDP Neighbor Info

LLDP Statistics

View the LLDP statistics of the local device through this feature. Click on "Refresh" to update the list.

Global Statistics	
Insertions	1
Delete	1
Drops	0
Age-Outs	0

Port Statistics								
Port	Total Packets Transmitted	Total	Discarded	Error	Discarded	Unrecognized	Timed-out Neighbors	Operation
<input checked="" type="checkbox"/> 1/0/1	852	0	0	0	0	0	0	
<input checked="" type="checkbox"/> 1/0/2	0	0	0	0	0	0	0	
<input checked="" type="checkbox"/> 1/0/3	0	0	0	0	0	0	0	
<input checked="" type="checkbox"/> 1/0/4	0	0	0	0	0	0	0	
<input checked="" type="checkbox"/> 1/0/5	0	0	0	0	0	0	0	

LLDP Statistics

Energy Efficient Ethernet

EEE or **Energy Efficient Ethernet** helps on reducing the power consumption on interfaces like GWN78xx switches Ethernet port, it achieves this by using power only during data transmission.

Navigate to **Maintenance** → **Energy Saving Management**, select a port to edit then enable 802.3 EEE.

- **Configuration Status:** shows if the configuration is enabled.
- **Status:** if a supported device is connected to the GWN78xx switch, it will show if it's enabled or not.

Port	Configuration Status	Status	Operation
<input checked="" type="checkbox"/> 1/0/1	Enabled	Enabled	
<input type="checkbox"/> 1/0/2	Enabled	Disabled	
<input type="checkbox"/> 1/0/3	Disabled	Disabled	
<input type="checkbox"/> 1/0/4	Disabled	Disabled	
<input type="checkbox"/> 1/0/5	Disabled	Disabled	

Energy Efficient Ethernet

To enable EEE on a port, select a port then click on "Edit" button then toggle ON 802.3 EEE as shown below:

Edit Port ✕

Port

1/0/1

802.3 EEE

Cancel
OK

Energy Efficient Ethernet

Alert

The Alerts section allows administrators to set up alert statuses for different types of system reactions for hardware components, this can be configured based on the component's performance, this can include factors such as CPU Usage, Memory Usage, PoE Power, MAC Address Exceeds Limit, Temperature, Fan Malfunctioning, PoE Chip Malfunctioning...

Alert
Alert Settings [Statistics](#)

Type	Alert Status	Log Level	Alert Threshold	Alert Waiting Time (s)	Restore Threshold	Restore Waiting Time (s)
CPU Usage	<input checked="" type="checkbox"/>	Error	80 %	30	80 %	10
Memory Usage	<input checked="" type="checkbox"/>	Error	80 %	30	80 %	10
PoE Power	<input checked="" type="checkbox"/>	Error	80 %	30	80 %	10
Mac Address Exceeds Limit	<input checked="" type="checkbox"/>	Error	80 %	30	80 %	10
Temperature	<input checked="" type="checkbox"/>	Error	77 °C	30	77 °C	10
Fan Malfunction	<input checked="" type="checkbox"/>	Error	--	30	--	10
PoE Chip Malfunction	<input checked="" type="checkbox"/>	Error	--	30	--	10

Cancel
OK

Alert Settings

Alert Statistics

The statistics section shows the current status of the Hardware components, in addition to some other hardware information, it also displays the last alert time and last restore time of the service

Alert
Alert Settings [Statistics](#)

Refresh

Type	Current Status	Last Alert Time	Last Alert Actual Value	Last Restore Time	Last restore Actual Value	Alert Times
CPU Usage	normal	1970-01-01 08:00:00	0%	1970-01-01 08:00:00	0%	0
Memory Usage	normal	1970-01-01 08:00:00	0%	1970-01-01 08:00:00	0%	0
PoE Power	normal	1970-01-01 08:00:00	0%	1970-01-01 08:00:00	0%	0
Mac Address Exceeds Limit	normal	1970-01-01 08:00:00	0%	1970-01-01 08:00:00	0%	0
Temperature	normal	1970-01-01 08:00:00	0°C	1970-01-01 08:00:00	0°C	0
Fan Malfunction	normal	1970-01-01 08:00:00	--	1970-01-01 08:00:00	--	0
PoE Chip Malfunction	normal	1970-01-01 08:00:00	--	1970-01-01 08:00:00	--	0

Alert Statistics

SYSTEM

Basic Settings

The basic settings page is split into three categories:

- **Basic Info:** first section, the user can specify a name for the GWN78xx switch with a system location and contact.
- **Time Settings:** In this section, the users can configure the time either manually, or using an NTP Server, it's also possible to configure Daylight Saving (DST) Mode according to the location or recurrence.

- Scheduled Reboot: the users can enable scheduled reboot by adding a schedule under the [Time Policy](#).

Please navigate to the **System** → **Basic Settings** page.

Basic Info

• Device Name 1-64 characters

System Location 0-64 characters

System Contact 0-64 characters

Time Settings

Date & Time Manual Automatic (NTP Server)

System Time 🗓️

• NTP Server

Time Zone

DayLight Saving (DST) Mode

• Offset (Min) Valid range is 1-1440

• Starting Time 🕒

• Ending Time 🕒

Scheduled Reboot

Reboot Time

Basic Settings

Basic Info	
Device Name	Specify a name for the device.
System Location	Enter system location.
System Contact	Specify the system contact.
Time Settings	
Date & Time	<p>Select time synchronization method: Manual or Automatic (NTP Server).</p> <ul style="list-style-type: none"> • Manual: specify the time manually. • Automatic (NTP Server): time will be synced automatically with NTP Server. <p><i>Note: if the device is added to the GDMS Networking and Auto Sync Time feature (under Settings → System) is enabled then the local NTP setting on the device will be disabled. All managed devices will synchronize the time from GDMS Networking.</i></p>
System Time	<ul style="list-style-type: none"> • If Manual is selected, the user can specify the date and time. • If Automatic (NTP Server) is selected, the current time and time will be displayed,
NTP Server	If Date & Time is set to Automatic (NTP Server), please specify the NTP Server address, by default is set to “pool.ntp.org” .
Time Zone	Select the time zone from the drop-down list.
DayLight Saving (DST) Mode	<ul style="list-style-type: none"> • Disabled: DayLight Saving mode will be disabled. • Recurring: if the Daylight saving is recurring (repetitive). • Non Recurring: if selected the user can specify the offset (min) and daylight saving time start date and end date. • Recurring USA: for USA region.

	<ul style="list-style-type: none"> • Recurring EU: for EU region
Offset (Min)	Specify the Offset by minutes, range from 1 to 1440.
Starting Time	Specify the starting date and time.
Ending Time	Specify the ending date and time.
Scheduled Reboot	
Reboot Time	Select a reboot time from the drop-down list or click on “+” button to add a schedule. By default is disabled.

Basic Settings

Access Control

In this section, the user can configure access to GWN78xx switches.

Please navigate to **System** → **Access Control**.

Web Service Management

On the first tab, the user can configure the following:

- **Inactive Session Timeout (min):** (the range is from 15 seconds to 1440) which is how much time before the GWN78xx switch will log out automatically.
- **HTTPS:** the HTTPS port, by default, is 443, It can be changed if necessary. (it's recommended to keep it 443).
- **Telnet:** can be enabled, but by default is disabled (it's recommended to keep it disabled, it's not secure, and use instead SSH).
- **SSH:** SSH is enabled by default, and it's a better alternative to Telnet, the default port is 22, It can be changed if necessary. (it's recommended to keep it to 22)

The screenshot shows the 'Access Control' configuration page with the following settings:

- Inactive Session Timeout (min):** 15 (Valid range is 1-1440)
- HTTPS Port:** 443 (Valid range is 443 and 1024-65535)
- Telnet:** Disabled (toggle switch)
- SSH:** Enabled (toggle switch)
- SSH Port:** 22 (Valid range is 22 and 1024-65535)

Buttons: Cancel, OK

Access Control Web Service Management

Note:

VTY (Virtual Teletype) sessions allow remote management of network devices through a command-line interface. GWN78xx switches now support up to 12 simultaneous VTY sessions, enabling concurrent SSH or Telnet access for administrators.

SSH Remote Access

Note:

This feature is exclusively used for troubleshooting purposes by our developers and support engineers. When remote access is requested by either party, please enter the current user's password to grant permission to access to the device.

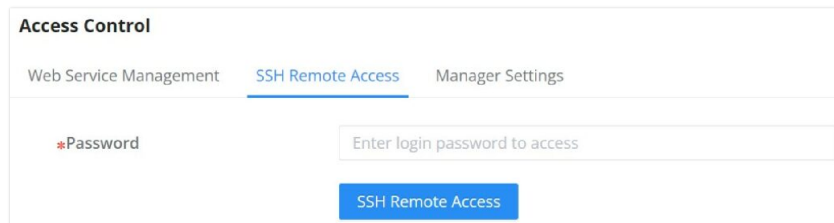

Access Control SSH Remote Access disabled

Enter the password, then click on the “**SSH Remote Access**” button, it will be automatically disabled in 48 hours.

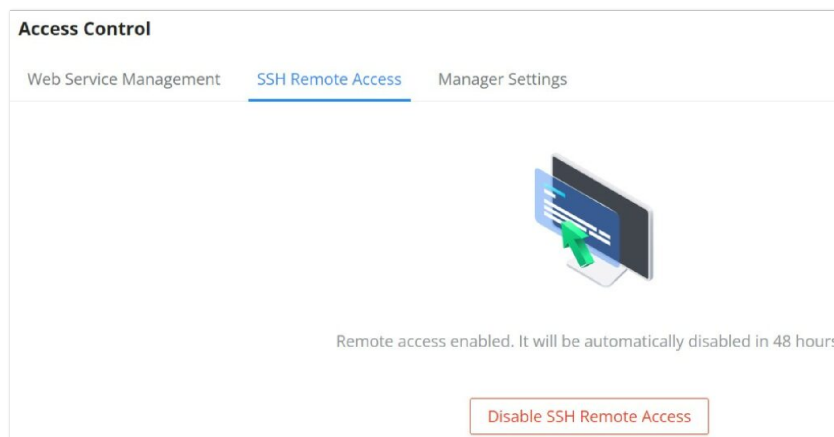

Access Control SSH Remote Access enabled

Management Platform Settings

The Manager Settings tab allows the users to configure GWN Manager or GWN Router access parameters (Server address and port). It's also possible to allow DHCP option 43 and if it's enabled If enabled, the server address assigned by DHCP Option 43 will be preferred.

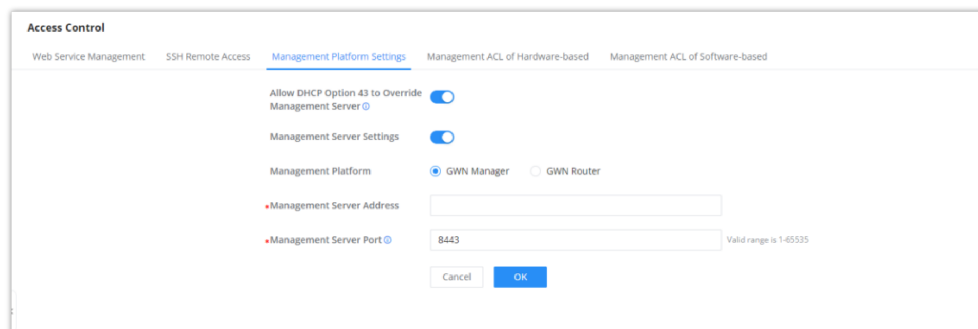

Access Control Manager Settings

Note:

When GWN Manager wants to take over a managed switch, it can force the takeover by entering the switch current password.

Management ACL of Hardware-based

On a GWN78xx switch, the hardware management Access Control List (ACL) is designed to optimize resource efficiency by filtering traffic directly at the hardware level before it reaches the CPU. This pre-processing step ensures that only traffic matching the defined security rules is forwarded for further handling, effectively reducing unnecessary CPU load and enhancing overall performance. By offloading the initial traffic validation to the switch hardware, the GWN78xx improves both network efficiency and security.

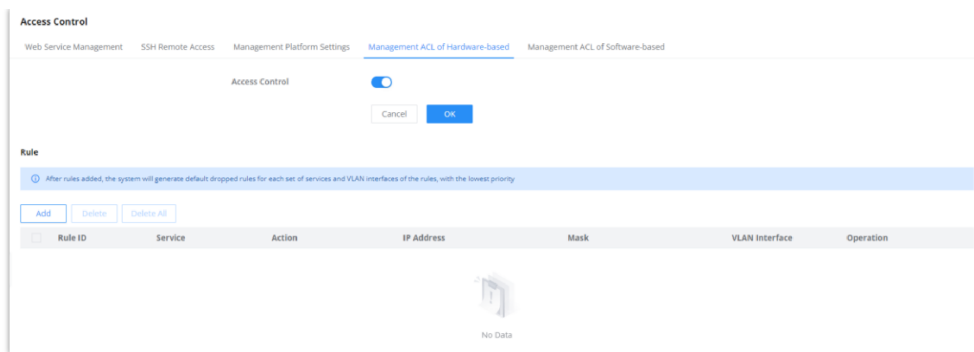

Management ACL of Hardware based

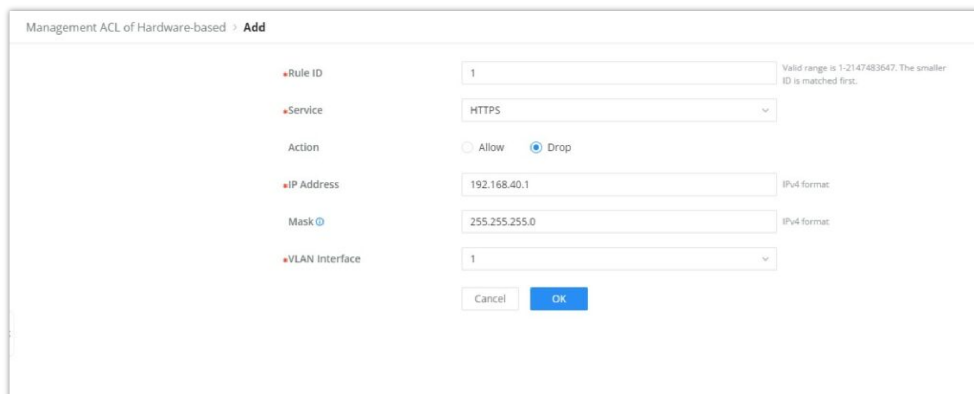

Add a Hardware based ACL Rule

Management ACL of Software-based

On the GWN78xx switch, the software-based Management ACL uses firewall-like rules to control who can access the network and its management features. This means it sets up restrictions to make sure that only authorized users and devices can access important parts of the switch, helping to keep the network secure and well-managed.

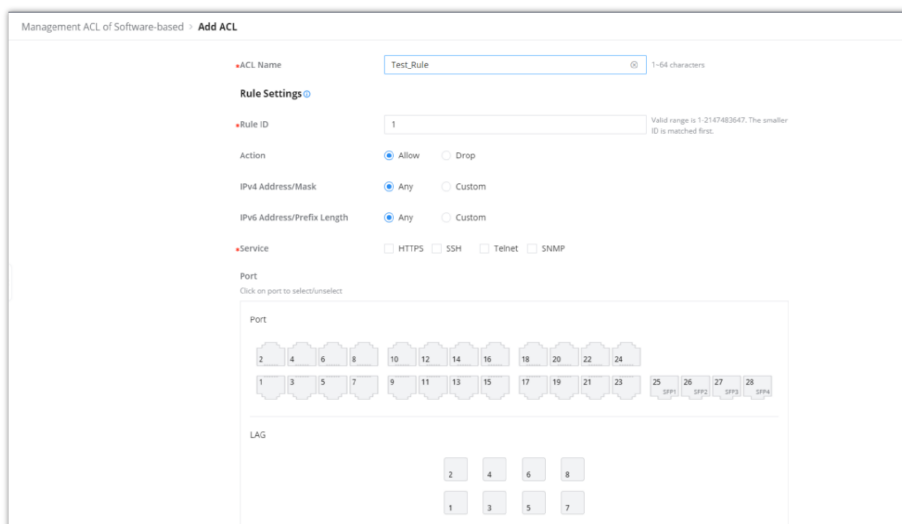

Management ACL of Software based

User Management

There are three levels of users, namely administrator, operator and monitor. The administrator authenticates and authorizes users who log in to the switch according to management need where each user has different permissions and passwords.

1. Administrator

- Each device has one and only one administrator.
- The highest privileges can execute any command.
- The username admin cannot be changed, only the password can be changed.
- Support adding, and deleting operator and monitor.

2. Operator

- Added by an administrator, there can be multiple accounts as Operators.
- The second highest authority can execute all commands except the administrator's key operations and important mandatory commands
- Can't change the username, only the password.
- Support adding, and deleting Monitor users.

Note:

All features of admin are allowed except setting management IP address and factory reset.

3. Monitor

- Multiple Monitors are possible with the permission of an Administrator or Operator.
- The lowest authority can only view switch status and statistics without any execution and configuration authority.
- Can't change the username, only the password.

Note:

Can only view information.

Click on the "Add" button to add a new user then specify the password and the user level (Operator or Monitor).

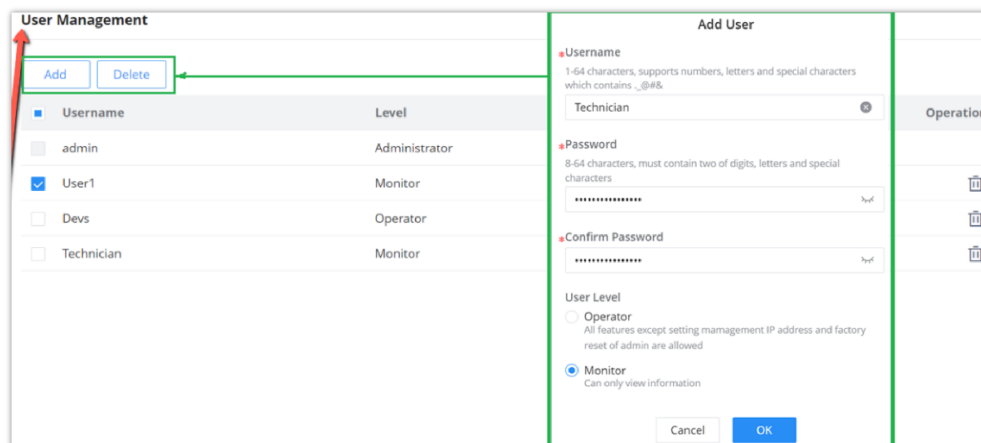

The screenshot displays the 'User Management' interface. On the left, a table lists existing users with columns for 'Username' and 'Level'. The 'Add' button is highlighted with a red arrow, and the 'Delete' button is highlighted with a green arrow. On the right, the 'Add User' form is shown, which includes fields for 'Username', 'Password', and 'Confirm Password', along with radio buttons for selecting the 'User Level' (Operator or Monitor). The 'Monitor' level is selected. The 'Operation' column in the table has trash icons for each user.

Username	Level
<input type="checkbox"/> admin	Administrator
<input checked="" type="checkbox"/> User1	Monitor
<input type="checkbox"/> Devs	Operator
<input type="checkbox"/> Technician	Monitor

User Management

Time Policy

The time policy page helps to create schedules, for example, Office working hours, Upgrade schedules or Reboot schedules.

To create a schedule, Please navigate to **Web UI** → **System** → **Time Policy** page, then click on "**Create Policy**" button, there are weekly schedules or absolute Date/Time schedules, for weekly schedules please select from the table the hours and days and as for absolute Date/Time select the days from the drop-down calendars and times from the drop-down menu. Please refer to the figure below.

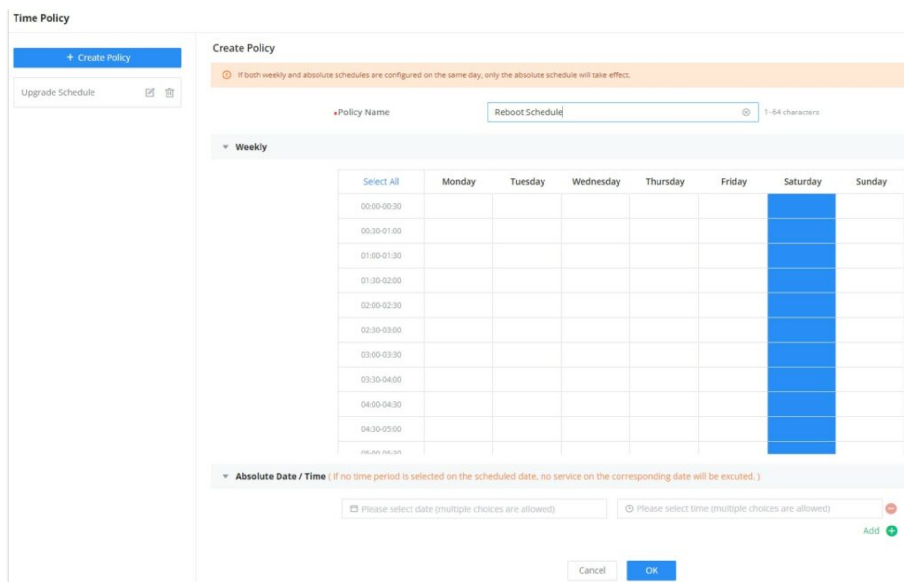

Time Policy

Note:

- If both weekly and absolute schedules are configured on the same day, only the absolute schedule will take effect.
- If no time period is selected on the scheduled date, no service on the corresponding date will be executed.

1588v2 TC

IEEE 1588v2 is a protocol for synchronizing clocks, enabling accurate time between nodes in a network.

A transparent clock or TC is a type of clock used in IEEE 1588v2 networks and it uses a Precision Time Protocol (PTP) messages to accurately calculate the time.

E2E or (End-to-End) transparent clock measures the delay at each network element between the master and slave clocks.

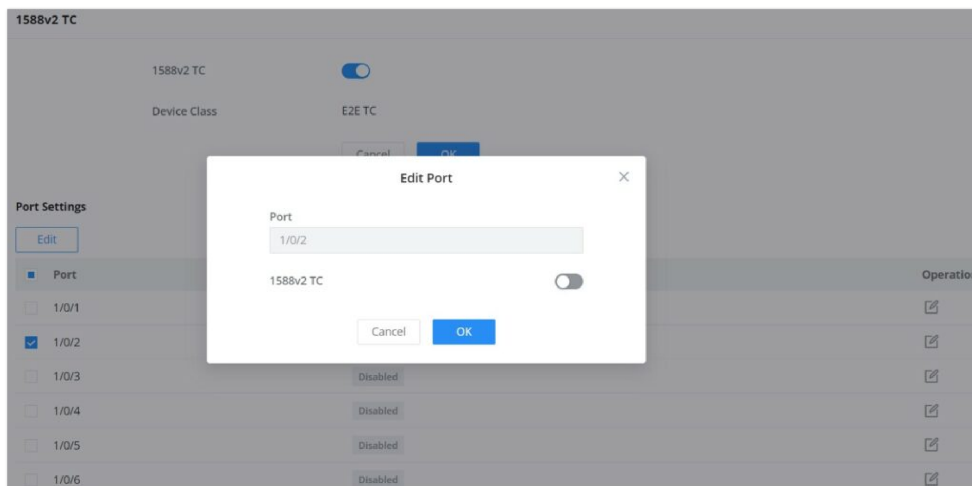

1588v2 TC

Note:

This feature is still in Beta, Web only supports E2E TC.

STACK

Stacking allows multiple supported GWN78xx switch models to operate as a single logical unit, simplifying network management, increasing redundancy, and expanding port density. This feature is available only on the following models:

Note:

Supported Models: GWN7806(P), GWN7811(P), GWN7812P, GWN7813(P), GWN7816(P), GWN7821P, GWN7822P, GWN7830, GWN7831, GWN7832.

To access this feature, navigate to:

Web UI → **Stack** → **Stack Settings**

💡 For full configuration examples, topology use cases, and best practices, please refer to the [GWN78xx Stacking Feature Guide](#).

Stack Settings

In this section, you can enable stack mode, assign a device ID and priority, and define the physical ports used for stacking.

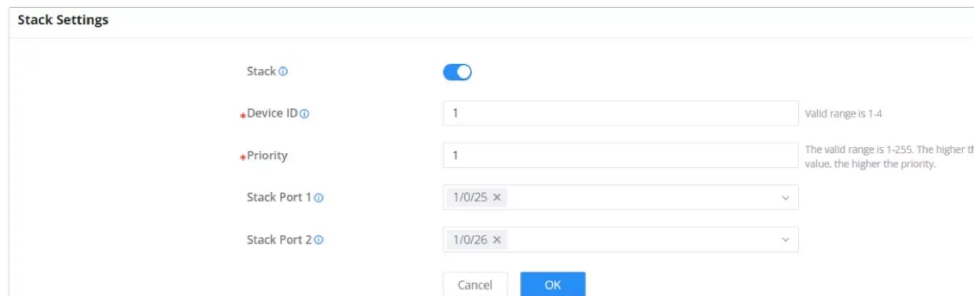

Stack Settings

- **Stack**

Enable or disable stacking functionality.

- When enabled, this device becomes part of a stack group.
- Make sure the ports used are in shutdown status before configuration.
- Only 10G fiber modules are supported.

Note:

After setting and saving, reboot the switch to take effect. Cross connect the switches and power them on (it is recommended to power on the preset primary switch first) to form a stacking system.

- **Device ID**

Unique identifier for the device in the stack.

- Range: **1–4**
- Must be **unique** across all devices in the same stack.

Note:

Device ID must be unique, otherwise switch cannot join the stack.

- **Priority**

Sets the priority level for master election during stack formation.

- Range: **1–255**
- Higher value = higher priority

- **Stack Port 1 & Stack Port 2**

Select the two physical ports to use for stacking interconnection.

- Must be 10G ports
- Ensure that these ports are correctly cross-connected between switches

Note:

After configuring Stack settings, you must click Save and reboot the switch for changes to take effect.

Stack Info

This page displays the current stack topology and status, including member switches and their roles (Master/Member), device IDs, priorities, and port mappings.

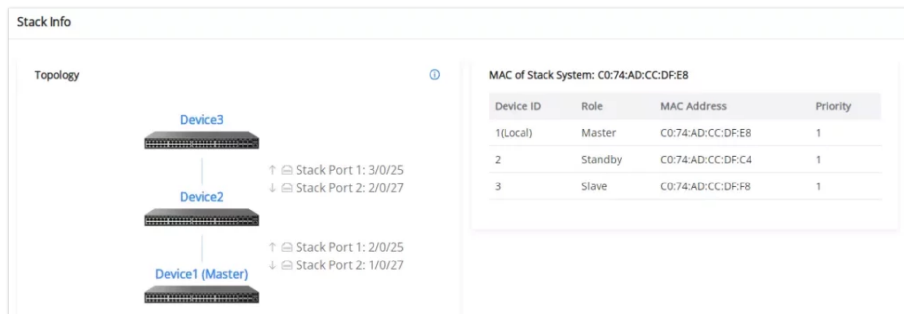

Stack Info

- If no data appears, ensure stack settings are properly configured and devices are connected.
- All stacked switches must be running the same firmware version.

CHANGE LOG

This section documents significant changes from previous versions of the GWN78xx switches user manuals. Only major new features or major document updates are listed here. Minor updates for corrections or editing are not documented here.

Version 1.0.15.132

Product Name: GWN7801(P) / GWN7802(P) / GWN7803(P), GWN7806(P), GWN7811(P), GWN7812P, GWN7813(P), GWN7816(P), GWN7821P, GWN7822P, GWN7830, GWN7831, GWN7832.

- Added support for ignoring credentials during SSH authentication. [SSH] [CLI Access]
- Added key for "encrypted" field to configuration files for Radius and TACACS+. [RADIUS] [TACACS+] [CLI Access]

Version 1.0.15.126

Product Name: GWN7801(P) / GWN7802(P) / GWN7803(P), GWN7806(P), GWN7811(P), GWN7812P, GWN7813(P), GWN7816(P), GWN7821P, GWN7822P, GWN7830, GWN7831, GWN7832.

- Added support for switch stacking feature. [Stack]
- Added the Ability to disable the native VLAN. [VLAN Port Setting]
- Added support for PVLAN. [PVLAN]
- Added the option to set the Web GUI language on the configuration. [Web GUI Languages]
- Added support to use encrypted strings in password fields in CLI. [RADIUS]
- Added support for "Calling-Station-Id" in RADIUS Access-Request. [Identity Authentication Management]

Version 1.0.13.18

Product Name: GWN7801(P) / GWN7802(P) / GWN7803(P), GWN7806(P), GWN7811(P), GWN7812P, GWN7813(P), GWN7816(P), GWN7821P, GWN7822P, GWN7830, GWN7831, GWN7832.

- No major changes

Version 1.0.13.6

Product Name: GWN7801(P) / GWN7802(P) / GWN7803(P), GWN7806(P), GWN7811(P), GWN7812P, GWN7813(P), GWN7816(P), GWN7821P, GWN7822P, GWN7830, GWN7831, GWN7832.

- Added support for BGP & Route Policy on L3 Switch. [[BGP](#)] [[Route Policy](#)]
- Added LED status change during the start-up process. [[LED Indicators](#)]
- Removed PTP settings from Web UI.
- This is the initial release for GWN7821P/GWN7822P Switches.

Version 1.0.9.15

Product Name: GWN7806(P)

- Added port groups. [[Port Group](#)]
- Added LLDP auto-config for Auto Voice VLAN mode in Voice VLAN. [[LLDP/LLDP MED Auto Config](#)]
- Added more features for STP, including ignore VLAN in BPDU, root protection and loopback protection. [[Ignore VLAN in BPDU](#)] [[Root Protection](#)] [[Loop Protection](#)]
- Added more OUI in Voice VLAN. [[OUI](#)]
- Added IP configuration for MGMT VLAN. [[MGMT VLAN](#)]
- Added redirect to interface for ACL. [[Redirect to Interface](#)]
- Added VLAN binding to ACL function. [[VLAN Binding to ACL](#)]
- Optimized the rate limit groups from 32 to 128 in ACL. [[Rate Limit Settings](#)]
- Added mask for IPSG/IPv6SG. [[IP Source Guard](#)]
- Added remote-ID configuration based on port for DHCP Snooping. [[DHCP Option 82](#)]
- Changed DHCP's Option 82 Circuit ID/Remote ID. [[DHCP Option 82](#)]
- Added entries fixed for DHCP/DHCPv6 Snooping. [[DHCP Snooping](#)]
- Added flow upgrade via manual upgrade. [[Upgrade Flow](#)]
- Added more settings for logs, including minimum log level and log aggregation. [[Log Aggregation](#)]
- Added Ping watchdog in diagnostics. [[Ping Watchdog](#)]
- Added connection diagnostics of GWN router. [[GWN Router](#)]
- Added RSPAN, including port-based and ACL-based remotely mirroring. [[RSPAN](#)] [[Configuring an ACL based RSPAN](#)]
- Added new SNMP Traps. [[Trap Event](#)]
- Added 802.3bt info in LLDP. [[IEEE 802.3 TLV](#)]
- Added Maintenance Alerts. [[Alert](#)]
- Added management ACL, including hardware-based and software-based management ACL. [[Management ACL of Hardware-based](#)] [[Management ACL of Software-based](#)]
- Added Layer 3 discovery and management by GWN router. [[Management Platform Settings](#)]
- Added ACL for VTY (SSH and telnet). [[Web Service Management](#)]
- Added additional Radius Access-Request Attributes. [[Identity Authentication Management](#)]
- Removed Committed Burst Configuration from Queue Shaping. [[Queue Shaping](#)]
- Added 1588v2 P2P TC. [[1588v2 P2P TC](#)]
- Added NAS-Port-Type value 15 with alternate management VLAN. [[MGMT VLAN](#)]
- Added ability to shutdown port by profile group. [[Port Group](#)]
- Added more port details such as neighbor and PoE power history info. [[Port Info](#)]
- Added more port statistics info. [[Port Statistics](#)]
- Added loopback detection. [[Loopback Detection](#)]

- Added support for QinQ. [[QinQ](#)]
- Added MAC-based VLAN. [[MAC VLAN](#)]
- Added protocol-based VLAN. [[Protocol VLAN](#)]
- Added VLAN translation. [[VLAN translation](#)]
- Added untagged OUI mode for voice VLAN. [[Voice VLAN](#)]
- Added gateway priority when using DHCP to get VLAN IP address [[VLAN IP Interface](#)]
- Added import/export IPSG binding table for IP Source Guard. [[IP Source Guard](#)]
- Added IPv6 Source Guard. [[IPv6 Source Guard](#)]
- Added MAC bypass authentication. [[Identity Authentication Management](#)]
- Added upgrade by FTP and Explicit FTPS. [[FTP](#)] [[Explicit FTPS](#)]
- Added DST mode for time settings. [[DST](#)]
- Added HTTPS/SSH port customization. [[Web Service Management](#)]
- Added GWN Manager takeover function. [[Management Platform Settings](#)]
- Added support to see switch clients and other information. [[Port Info](#)]
- Optimized DHCP option 43 settings for DHCP server. [[DHCP Server](#)]
- Optimized routing table. [[Routing Forwarding](#)]
- Added port scheduled enabling feature. [[Scheduled enabled](#)]
- Added DHCPv6 Snooping. [[DHCPv6 Snooping](#)]
- Optimized CPU and memory usage in Web GUI. [[System Info](#)]
- Optimized search for Web GUI. [[Search](#)]

Version 1.0.1.14

Product Name: GWN7806(P)

- This is the initial release.

Version 1.0.9.15

Product Name: GWN7832

- Added port groups. [[Port Group](#)]
- Added LLDP auto-config for Auto Voice VLAN mode in Voice VLAN. [[LLDP/LLDP MED Auto Config](#)]
- Added more features for STP, including ignore VLAN in BPDU, root protection and loopback protection. [[Ignore VLAN in BPDU](#)] [[Root Protection](#)] [[Loop Protection](#)]
- Added more OUI in Voice VLAN. [[OUI](#)]
- Added IP configuration for MGMT VLAN. [[MGMT VLAN](#)]
- Added redirect to interface for ACL. [[Redirect to Interface](#)]
- Added VLAN binding to ACL function.[[VLAN Binding to ACL](#)]
- Optimized the rate limit groups from 32 to128 in ACL. [[Rate Limit Settings](#)]
- Added mask for IPSG/IPv6SG. [[IP Source Guard](#)]
- Added remote-ID configuration based on port for DHCP Snooping. [[DHCP Option 82](#)]
- Changed DHCP's Option 82 Circuit ID/Remote ID. [[DHCP Option 82](#)]
- Added entries fixed for DHCP/DHCPv6 Snooping. [[DHCP Snooping](#)]
- Added flow upgrade via manual upgrade. [[Upgrade Flow](#)]
- Added more settings for logs, including minimum log level and log aggregation. [[Log Aggregation](#)]
- Added Ping watchdog in diagnostics. [[Ping Watchdog](#)]
- Added connection diagnostics of GWN router. [[GWN Router](#)]

- Added RSPAN, including port-based and ACL-based remotely mirroring. [[RSPAN](#)] [[Configuring an ACL based RSPAN](#)]
- Added new SNMP Traps. [[Trap Event](#)]
- Added 802.3bt info in LLDP. [[IEEE 802.3 TLV](#)]
- Added Maintenance Alerts. [[Alert](#)]
- Added management ACL, including hardware-based and software-based management ACL. [[Management ACL of Hardware-based](#)] [[Management ACL of Software-based](#)]
- Added Layer 3 discovery and management by GWN router. [[Management Platform Settings](#)]
- Added ACL for VTY (SSH and telnet). [[Web Service Management](#)]
- Added additional Radius Access-Request Attributes. [[Identity Authentication Management](#)]
- Removed Committed Burst Configuration from Queue Shaping. [[Queue Shaping](#)]
- Added 1588v2 P2P TC. [[1588v2 P2P TC](#)]
- Added NAS-Port-Type value 15 with alternate management VLAN. [[MGMT VLAN](#)]
- Added ability to shutdown port by profile group. [[Port Group](#)]
- Added more port details such as neighbor and PoE power history info. [[Port Info](#)]
- Added more port statistics info. [[Port Statistics](#)]
- Added loopback detection. [[Loopback Detection](#)]
- Added support for QinQ. [[QinQ](#)]
- Added MAC-based VLAN. [[MAC VLAN](#)]
- Added protocol-based VLAN. [[Protocol VLAN](#)]
- Added VLAN translation. [[VLAN translation](#)]
- Added untagged OUI mode for voice VLAN. [[Voice VLAN](#)]
- Added gateway priority when using DHCP to get VLAN IP address [[VLAN IP Interface](#)]
- Added import/export IPSG binding table for IP Source Guard. [[IP Source Guard](#)]
- Added IPv6 Source Guard. [[IPv6 Source Guard](#)]
- Added MAC bypass authentication. [[Identity Authentication Management](#)]
- Added upgrade by FTP and Explicit FTPS. [[FTP](#)] [[Explicit FTPS](#)]
- Added DST mode for time settings. [[DST](#)]
- Added HTTPS/SSH port customization. [[Web Service Management](#)]
- Added GWN Manager takeover function. [[Management Platform Settings](#)]
- Optimized DHCP option 43 settings for DHCP server. [[DHCP Server](#)]
- Optimized routing table. [[Routing Forwarding](#)]
- Added port scheduled enabling feature. [[Scheduled enabled](#)]
- Added DHCPv6 Snooping. [[DHCPv6 Snooping](#)]
- Optimized CPU and memory usage in Web GUI. [[System Info](#)]
- Optimized search for Web GUI. [[Search](#)]

Product Name: GWN7830/GWN7831

- Added port groups. [[Port Group](#)]
- Added LLDP auto-config for Auto Voice VLAN mode in Voice VLAN. [[LLDP/LLDP MED Auto Config](#)]
- Added more features for STP, including ignore VLAN in BPDU, root protection and loopback protection. [[Ignore VLAN in BPDU](#)] [[Root Protection](#)] [[Loop Protection](#)]
- Added more OUI in Voice VLAN. [[OUI](#)]
- Added IP configuration for MGMT VLAN. [[MGMT VLAN](#)]
- Added redirect to interface for ACL. [[Redirect to Interface](#)]
- Added VLAN binding to ACL function. [[VLAN Binding to ACL](#)]

- Optimized the rate limit groups from 32 to 128 in ACL. [[Rate Limit Settings](#)]
- Added mask for IPSG/IPv6SG. [[IP Source Guard](#)]
- Added remote-ID configuration based on port for DHCP Snooping. [[DHCP Option 82](#)]
- Changed DHCP's Option 82 Circuit ID/Remote ID. [[DHCP Option 82](#)]
- Added entries fixed for DHCP/DHCPv6 Snooping. [[DHCP Snooping](#)]
- Added flow upgrade via manual upgrade. [[Upgrade Flow](#)]
- Added more settings for logs, including minimum log level and log aggregation. [[Log Aggregation](#)]
- Added Ping watchdog in diagnostics. [[Ping Watchdog](#)]
- Added connection diagnostics of GWN router. [[GWN Router](#)]
- Added RSPAN, including port-based and ACL-based remotely mirroring. [[RSPAN](#)] [[Configuring an ACL based RSPAN](#)]
- Added new SNMP Traps. [[Trap Event](#)]
- Added 802.3bt info in LLDP. [[IEEE 802.3 TLV](#)]
- Added Maintenance Alerts. [[Alert](#)]
- Added management ACL, including hardware-based and software-based management ACL. [[Management ACL of Hardware-based](#)] [[Management ACL of Software-based](#)]
- Added Layer 3 discovery and management by GWN router. [[Management Platform Settings](#)]
- Added ACL for VTY (SSH and telnet). [[Web Service Management](#)]
- Added additional Radius Access-Request Attributes. [[Identity Authentication Management](#)]
- Removed Committed Burst Configuration from Queue Shaping. [[Queue Shaping](#)]

Version 1.0.7.71

Product Name: GWN7830/GWN7831

- Optimized search for Web GUI [[Search](#)]
- Optimized CPU and memory usage in Web GUI [[System Info](#)]
- Optimized device IP address display [[System Info](#)]
- Added more port details such as neighbor, PoE power history info [[Port Info](#)]
- Added port scheduled enabling feature [[Port Basic Settings](#)]
- Added more port statistics info [[Port Statistics](#)]
- Added loopback detection feature [[Loopback Detection](#)]
- Added QinQ [[VLAN](#)]
- Optimized trunk port settings [[VLAN Port Members](#)]
- Added MAC-based VLAN [[MAC VLAN](#)]
- Added protocol-based VLAN [[Protocol VLAN](#)]
- Added VLAN translation [[VLAN Port Settings](#)]
- Added default gateway configuration under MGMT VLAN [[VLAN IP Interface](#)]
- Added gateway priority when using DHCP to get VLAN IP address [[VLAN IP Interface](#)]
- Optimized DHCP option 43 configuration for DHCP server [[DHCP Server](#)]
- Added advanced ACL settings, including mirroring, statistics, and priority remapping for a rule [[ACL](#)]
- Added import/export IPSG binding table for IP Source Guard [[IP Source Guard](#)]
- Added IPv6 Source Guard [[IPv6 Source Guard](#)]
- Optimized remote ID and Circuit ID for DHCP Snooping [[DHCP Snooping option 82](#)]
- Added DHCPv6 Snooping [[DHCPv6 Snooping](#)]
- Added upgrade by FTP and Explicit FTPS [[Upgrade](#)]
- Added connection diagnostics with GWN.Cloud/Manager [[Cloud/Manager Connection Diagnostics](#)]
- Optimized EEE [[Energy Efficient Ethernet](#)]

- Added DST mode for time settings [[Basic Settings](#)]
- Added HTTPS/SSH port customization [[Web Service Management](#)]
- Optimized Manager settings [[Manager Settings](#)]
- Added rate limit by ACL binding to VLAN. [[VLAN Binding to ACL](#)]
- Added MAC bypass authentication. [[Local User of MAC-based](#)]
- Add GWN Manager takeover function [[Manager Settings](#)]
- Expanded DHCP leases range up to 11520 min [[DHCP Server](#)]
- Added refresh IP address when using DHCP to get VLAN IP address. [[VLAN IP Interface](#)]
- Added support for OSPFv3. [[OSPFv3](#)]
- Added support for 12 VTY (SSH or telnet) sessions. [[Access Control](#)]
- Added support to see switch clients and other information. [[Port Info](#)]

Version 1.0.3.1

Product Name: GWN7830, GWN7831, GWN7832

- This is the initial release.

Version 1.0.9.15

Product Name: GWN7816(P)

- Added port groups. [[Port Group](#)]
- Added LLDP auto-config for Auto Voice VLAN mode in Voice VLAN. [[LLDP/LLDP MED Auto Config](#)]
- Added more features for STP, including ignore VLAN in BPDU, root protection and loopback protection. [[Ignore VLAN in BPDU](#)] [[Root Protection](#)] [[Loop Protection](#)]
- Added more OUI in Voice VLAN. [[OUI](#)]
- Added IP configuration for MGMT VLAN. [[MGMT VLAN](#)]
- Added redirect to interface for ACL. [[Redirect to Interface](#)]
- Added VLAN binding to ACL function. [[VLAN Binding to ACL](#)]
- Optimized the rate limit groups from 32 to 128 in ACL. [[Rate Limit Settings](#)]
- Added mask for IPSG/IPv6SG. [[IP Source Guard](#)]
- Added remote-ID configuration based on port for DHCP Snooping. [[DHCP Option 82](#)]
- Changed DHCP's Option 82 Circuit ID/Remote ID. [[DHCP Option 82](#)]
- Added entries fixed for DHCP/DHCPv6 Snooping. [[DHCP Snooping](#)]
- Added flow upgrade via manual upgrade. [[Upgrade Flow](#)]
- Added more settings for logs, including minimum log level and log aggregation. [[Log Aggregation](#)]
- Added Ping watchdog in diagnostics. [[Ping Watchdog](#)]
- Added connection diagnostics of GWN router. [[GWN Router](#)]
- Added RSPAN, including port-based and ACL-based remotely mirroring. [[RSPAN](#)] [[Configuring an ACL based RSPAN](#)]
- Added new SNMP Traps. [[Trap Event](#)]
- Added 802.3bt info in LLDP. [[IEEE 802.3 TLV](#)]
- Added Maintenance Alerts. [[Alert](#)]
- Added management ACL, including hardware-based and software-based management ACL. [[Management ACL of Hardware-based](#)] [[Management ACL of Software-based](#)]
- Added Layer 3 discovery and management by GWN router. [[Management Platform Settings](#)]
- Added ACL for VTY (SSH and telnet). [[Web Service Management](#)]
- Added additional Radius Access-Request Attributes. [[Identity Authentication Management](#)]
- Removed Committed Burst Configuration from Queue Shaping. [[Queue Shaping](#)]

- Added 1588v2 P2P TC. [[1588v2 P2P TC](#)]
- Added NAS-Port-Type value 15 with alternate management VLAN. [[MGMT VLAN](#)]
- Added ability to shutdown port by profile group. [[Port Group](#)]
- Added more port details such as neighbor and PoE power history info. [[Port Info](#)]
- Added more port statistics info. [[Port Statistics](#)]
- Added loopback detection. [[Loopback Detection](#)]
- Added support for QinQ. [[QinQ](#)]
- Added MAC-based VLAN. [[MAC VLAN](#)]
- Added protocol-based VLAN. [[Protocol VLAN](#)]
- Added VLAN translation. [[VLAN translation](#)]
- Added untagged OUI mode for voice VLAN. [[Voice VLAN](#)]
- Added gateway priority when using DHCP to get VLAN IP address. [[VLAN IP Interface](#)]
- Added import/export IPSG binding table for IP Source Guard. [[IP Source Guard](#)]
- Added IPv6 Source Guard. [[IPv6 Source Guard](#)]
- Added MAC bypass authentication. [[Identity Authentication Management](#)]
- Added upgrade by FTP and Explicit FTPS. [[FTP](#)] [[Explicit FTPS](#)]
- Added DST mode for time settings. [[DST](#)]
- Added HTTPS/SSH port customization. [[Web Service Management](#)]
- Added GWN Manager takeover function. [[Management Platform Settings](#)]
- Optimized DHCP option 43 settings for DHCP server. [[DHCP Server](#)]
- Optimized routing table. [[Routing Forwarding](#)]
- Added port scheduled enabling feature. [[Scheduled enabled](#)]
- Added DHCPv6 Snooping. [[DHCPv6 Snooping](#)]
- Optimized CPU and memory usage in Web GUI. [[System Info](#)]
- Optimized search for Web GUI. [[Search](#)]

Product Name: GWN7811(P)/GWN7812P/GWN7813(P)

- Added port groups. [[Port Group](#)]
- Added LLDP auto-config for Auto Voice VLAN mode in Voice VLAN. [[LLDP/LLDP MED Auto Config](#)]
- Added more features for STP, including ignore VLAN in BPDU, root protection and loopback protection. [[Ignore VLAN in BPDU](#)] [[Root Protection](#)] [[Loop Protection](#)]
- Added more OUI in Voice VLAN. [[OUI](#)]
- Added IP configuration for MGMT VLAN. [[MGMT VLAN](#)]
- Added redirect to interface for ACL. [[Redirect to Interface](#)]
- Added VLAN binding to ACL function. [[VLAN Binding to ACL](#)]
- Optimized the rate limit groups from 32 to 128 in ACL. [[Rate Limit Settings](#)]
- Added mask for IPSG/IPv6SG. [[IP Source Guard](#)]
- Added remote-ID configuration based on port for DHCP Snooping. [[DHCP Option 82](#)]
- Changed DHCP's Option 82 Circuit ID/Remote ID. [[DHCP Option 82](#)]
- Added entries fixed for DHCP/DHCPv6 Snooping. [[DHCP Snooping](#)]
- Added flow upgrade via manual upgrade. [[Upgrade Flow](#)]
- Added more settings for logs, including minimum log level and log aggregation. [[Log Aggregation](#)]
- Added Ping watchdog in diagnostics. [[Ping Watchdog](#)]
- Added connection diagnostics of GWN router. [[GWN Router](#)]
- Added RSPAN, including port-based and ACL-based remotely mirroring. [[RSPAN](#)] [[Configuring an ACL based RSPAN](#)]

- Added new SNMP Traps. [[Trap Event](#)]
- Added 802.3bt info in LLDP. [[IEEE 802.3 TLV](#)]
- Added Maintenance Alerts. [[Alert](#)]
- Added management ACL, including hardware-based and software-based management ACL. [[Management ACL of Hardware-based](#)] [[Management ACL of Software-based](#)]
- Added Layer 3 discovery and management by GWN router. [[Management Platform Settings](#)]
- Added ACL for VTY (SSH and telnet). [[Web Service Management](#)]
- Added additional Radius Access-Request Attributes. [[Identity Authentication Management](#)]
- Removed Committed Burst Configuration from Queue Shaping. [[Queue Shaping](#)]

Version 1.0.7.71

Product Name: GWN7811(P)/GWN7812P/GWN7813(P)

- Optimized search for Web GUI. [[Search](#)]
- Optimized CPU and memory usage in Web GUI. [[System Info](#)]
- Optimized device IP address display. [[System Info](#)]
- Added more port details such as neighbor, PoE power history info. [[Port Info](#)]
- Added port scheduled enabling feature. [[Port Basic Settings](#)]
- Added more port statistics info. [[Port Statistics](#)]
- Added loopback detection. [[Loopback Detection](#)]
- Added support for QinQ. [[VLAN](#)]
- Optimized trunk port settings. [[VLAN Port Members](#)]
- Added MAC-based VLAN. [[MAC VLAN](#)]
- Added protocol-based VLAN. [[Protocol VLAN](#)]
- Added VLAN translation. [[VLAN Port Settings](#)]
- Added default gateway configuration under MGMT VLAN. [[VLAN IP Interface](#)]
- Added gateway priority when using DHCP to get VLAN IP address. [[VLAN IP Interface](#)]
- Optimized DHCP option 43 configuration for DHCP server. [[DHCP Server](#)]
- Added advanced ACL settings, including mirroring, statistics, and priority remapping for a rule. [[ACL](#)]
- Added import/export IPSG binding table for IP Source Guard. [[IP Source Guard](#)]
- Added IPv6 Source Guard. [[IPv6 Source Guard](#)]
- Optimized remote ID and Circuit ID for DHCP Snooping. [[DHCP Snooping option 82](#)]
- Added DHCPv6 Snooping. [[DHCPv6 Snooping](#)]
- Added upgrade by FTP and Explicit FTPS. [[Upgrade](#)]
- Added connection diagnostics with GWN.Cloud/Manager. [[Cloud/Manager Connection Diagnostics](#)]
- Optimized EEE. [[Energy Efficient Ethernet](#)]
- Added DST mode for time settings. [[Basic Settings](#)]
- Added HTTPS/SSH port customization. [[Web Service Management](#)]
- Optimized Manager settings. [[Manager Settings](#)]
- Added rate limit by ACL binding to VLAN. [[VLAN Binding to ACL](#)]
- Added MAC bypass authentication. [[Local User of MAC-based](#)]
- Add GWN Manager takeover function [[Manager Settings](#)]
- Expanded DHCP leases range up to 11520 min. [[DHCP Server](#)]
- Added refresh IP address when using DHCP to get VLAN IP address. [[VLAN IP Interface](#)]
- Added support for OSPFv3. [[OSPFv3](#)]
- Added support for 12 VTY (SSH or telnet) sessions. [[Access Control](#)]

- Added support to see switch clients and other information. [[Port Info](#)]

Version 1.0.3.8

Product Name: GWN7816(P)

- This is the initial release.

Version 1.0.1.20

Product Name: GWN7811(P)/GWN7812P/GWN7813(P)

- Added support for GWN Cloud 1.1.25.23. [[GWN.Cloud](#)]
- Added support of SSH and TELNET in #mode. [[Login Remotely using SSH](#)]
- Added support of Auto Voice VLAN (Dynamic Voice VLAN). [[Voice VLAN](#)]
- Added support of voice VLAN OUI Untagged mode. [[Voice VLAN](#)]
- Added SNTP GWN Cloud interface. [[Time Settings](#)]
- Added support of EXEC CLI config commands by GWN Cloud. [[GWN Cloud – Web CLI](#)]

Version 1.0.1.8

Product Name: GWN7811(P)/GWN7812P/GWN7813(P)

- This is the initial release.

Firmware Version 1.0.9.15

Product Name: GWN7801(P)/GWN7802(P)/GWN7803(P)

- Added port groups. [[Port Group](#)]
- Added LLDP auto-config for Auto Voice VLAN mode. [[LLDP/LLDP MED Auto Config](#)]
- Added more features for STP, including ignore VLAN in BPDU, root protection and loopback protection. [[Ignore VLAN in BPDU](#)] [[Root Protection](#)] [[Loop Protection](#)]
- Added more OUI in Voice VLAN. [[OUI](#)]
- Added IP configuration for MGMT VLAN. [[MGMT VLAN](#)]
- Added redirect to interface for ACL. [[Redirect to Interface](#)]
- Added VLAN binding to ACL function. [[VLAN Binding to ACL](#)]
- Optimized the rate limit groups from 32 to 128 in ACL. [[Rate Limit Settings](#)]
- Added mask for IPSG/IPv6SG. [[IP Source Guard](#)]
- Added remote-ID configuration based on port for DHCP Snooping. [[DHCP Option 82](#)]
- Changed DHCP's Option 82 Circuit ID/Remote ID. [[DHCP Option 82](#)]
- Added entries fixed for DHCP/DHCPv6 Snooping. [[DHCP Snooping](#)]
- Added flow upgrade via manual upgrade. [[Upgrade Flow](#)]
- Added more settings for logs, including minimum log level and log aggregation. [[Log Aggregation](#)]
- Added Ping watchdog in diagnostics. [[Ping Watchdog](#)]
- Added connection diagnostics of GWN router. [[GWN Router](#)]
- Added RSPAN, including port-based and ACL-based remotely mirroring. [[RSPAN](#)] [[Configuring an ACL based RSPAN](#)]
- Added new SNMP Traps. [[Trap Event](#)]
- Added 802.3bt info in LLDP. [[IEEE 802.3 TLV](#)]
- Added Maintenance Alerts. [[Alert](#)]
- Added management ACL, including hardware-based and software-based management ACL. [[Management ACL of Hardware-based](#)] [[Management ACL of Software-based](#)]
- Added Layer 3 discovery and management by GWN router. [[Management Platform Settings](#)]

- Added ACL for VTY (SSH and telnet). [[Web Service Management](#)]
- Added additional Radius Access-Request Attributes. [[Identity Authentication Management](#)]
- Removed Committed Burst Configuration from Queue Shaping. [[Queue Shaping](#)]

Firmware Version 1.0.5.61

Product Name: GWN7801(P)/GWN7802(P)/GWN7803(P)

- Optimized search for Web GUI. [[Search](#)]
- Optimized CPU and memory usage in Web GUI. [[System Info](#)]
- Optimized device IP address display [[System Info](#)]
- Added more port details such as neighbor, PoE power history info. [[Port Info](#)]
- Added port scheduled enabling feature. [[Port Basic Settings](#)]
- Added more port statistics info. [[Port Statistics](#)]
- Added loopback detection feature. [[Loopback Detection](#)]
- Added QinQ. [[VLAN](#)]
- Optimized trunk port settings. [[VLAN Port Members](#)]
- Added MAC-based VLAN. [[MAC VLAN](#)]
- Added protocol-based VLAN. [[Protocol VLAN](#)]
- Added VLAN translation. [[VLAN Port Settings](#)]
- Added default gateway configuration under MGMT VLAN. [[VLAN IP Interface](#)]
- Added gateway priority when using DHCP to get VLAN IP address. [[VLAN IP Interface](#)]
- Optimized DHCP option 43 configuration for DHCP server. [[DHCP Server](#)]
- Added advanced ACL settings, including mirroring, statistics, and priority remapping for a rule. [[ACL](#)]
- Added import/export IPSG binding table for IP Source Guard. [[IP Source Guard](#)]
- Added IPv6 Source Guard. [[IPv6 Source Guard](#)]
- Optimized remote ID and Circuit ID for DHCP Snooping. [[DHCP Snooping option 82](#)]
- Added DHCPv6 Snooping. [[DHCPv6 Snooping](#)]
- Added upgrade by FTP and Explicit FTPS. [[Upgrade](#)]
- Added connection diagnostics with GWN.Cloud/Manager. [[Cloud/Manager Connection Diagnostics](#)]
- Optimized EEE. [[Energy Efficient Ethernet](#)]
- Added DST mode for time settings. [[Basic Settings](#)]
- Added HTTPS/SSH port customization. [[Web Service Management](#)]
- Optimized Manager settings. [[Manager Settings](#)]
- Added rate limit by ACL binding to VLAN. [[VLAN Binding to ACL](#)]
- Added MAC bypass authentication. [[Local User of MAC-based](#)]
- Add GWN Manager takeover function. [[Manager Settings](#)]
- Expanded DHCP leases range up to 11520 min. [[DHCP Server](#)]
- Adjust the maximum length of the command line to 2000. [[CLI Access](#)]
- Added support to see switch clients and other information. [[Port Info](#)]

Firmware Version 1.0.3.37

Product Name: GWN7801(P)/GWN7802(P)/GWN7803(P)

- Added support for GWN Cloud 1.1.25.23. [[GWN.Cloud](#)]
- Added support of SSH and TELNET in # mode. [[Login Remotely using SSH](#)]
- Added support of Dynamic Voice VLAN. [[Voice VLAN](#)]

- Added support of voice VLAN OUI Untagged mode. [[Voice VLAN](#)]
- Added support of backspace when using CLI. [[Login Remotely using SSH](#)]

Firmware Version 1.0.3.19

Product Name: GWN7801(P)/GWN7802(P)/GWN7803(P)

- Added support of EEE [[Energy Efficient Ethernet](#)]
- Added feature of ARP table [[ARP table](#)]
- Added support of neighbor discovery [[Neighbor Discovery](#)]
- Added feature of IPv6 RA, RS [[Neighbor Discovery](#)]
- Added feature of copper test [[Copper test](#)]
- Added feature of one key debugging [[One-click Debugging](#)]
- Added feature of VLAN IP Interface [[VLAN IP Interface](#)]
- Added feature of DHCP server [[DHCP Server](#)]
- Added feature of time scheduling [[Time Policy](#)]
- Added support of Layer 2 and Layer 3 GWN Manager discovery [[Access Control](#)]
- Added support of ErrDisable status to port information [[Port Info](#)]
- Added support of SSH/Telnet client [[Access Control](#)]
- Added support of fan status to system information [[System Info](#)]
- Added support of SSH remote access [[SSH remote access](#)]
- Added support of switch IP interface DNS configuration [[DNS](#)]
- Added support of port based enable/disable in QoS port priority [[Port Priority](#)]
- Added support of SP-WRR and SP-WFQ to queue policy of QoS [[Queue Scheduling](#)]
- Added feature of routing table [[Routing Table](#)].
- Added feature of static routing [[Static Routes](#)].
- Added feature of DHCP relay [[DHCP Relay](#)]

Firmware Version 1.0.1.36

Product Name: GWN7801(P)/GWN7802(P)/GWN7803(P)

- Added DNS configurations for switch IP service. [[DNS](#)]

Firmware Version 1.0.1.30

Product Name: GWN7801(P)/GWN7802(P)/GWN7803(P)

- No major changes

Firmware Version 1.0.1.20

Product Name: GWN7801(P)/GWN7802(P)/GWN7803(P)

- This is the initial version.