



Maintenance and Service Guide

V27i G5 model

SUMMARY

This guide provides information about spare parts, removal and replacement of parts, diagnostic tests, problem troubleshooting, and more.

© Copyright 2022 HP Development Company, L.P.

AMD is a trademark of Advanced Micro Devices, Inc. Bluetooth is a trademark owned by its proprietor and used by HP Inc. under license. NVIDIA is a trademark and/or registered trademark of NVIDIA Corporation in the U.S. and other countries. USB Type-C and USB-C are registered trademarks of USB Implementers Forum. DisplayPort and the DisplayPort logo are trademarks owned by the Video Electronics Standards Association (VESA) in the United States and other countries.

The information contained herein is subject to change without notice. The only warranties for HP products and services are set forth in the express warranty statements accompanying such products and services. Nothing herein should be construed as constituting an additional warranty. HP shall not be liable for technical or editorial errors or omissions contained herein.

First Edition: Jun. 2022

Document Part Number: N08483-V27i G5-MSG-V1

Assembly part number: N08483-001

Product notice

Only trained service personnel familiar with this product should service it. Before performing any maintenance or service, be sure to read “Important Safety Information”.

Table of Contents

1	Getting started	2
	Important safety information	2
	Important service information and precautions	2
	RoHS (2002/95/EC) requirements.....	3
	General descriptions	3
	Firmware updates.....	3
	Before returning the repaired product to the customer	3
2	Monitor features	4
	Features.....	4
	Front components.....	5
	Rear components.....	6
	Locating the serial number and product number	7
3	Illustrated parts catalog	8
	How to order parts	10
4	Removal and replacement procedures.....	11
	Preparation for disassembly	11
	Rear Cover	11
	Power board	16
	Connector repair	17
	DP connector CN501.....	19
	HDMI connector CN502	20
	D-SUB connector CN503.....	21
	Function test.....	22
	Function test.....	22
	Support and troubleshooting	22
	Index	24

1 Getting started

Read this chapter to learn about safety information and where to find additional HP resources.

Important safety information

Carefully read the cautions and notes within this document to minimize the risk of personal injury to service personnel. The cautions and notes are not exhaustive. Proper service methods are important to the safe, reliable operation of equipment. Improper service methods can damage equipment.

The service procedures recommended and described in this service manual provide effective methods of performing service operations. Service engineers should have prior repair knowledge and experience as well as appropriate training for the product before performing service procedures.

- Be sure your working environment is dry and clean and meets all government safety requirements.
- Be sure that other persons are safe while you are servicing the product.
- Do not perform any action that can cause a hazard to the customer or make the product unsafe.
- Use proper safety devices to ensure your personal safety.
- Always use approved tools and test equipment for servicing.
- Never assume the product's power is disconnected from the main power supply. Check that it is disconnected before opening the product's cabinet.
- Modules containing electrical components are sensitive to electrostatic discharge (ESD). Follow ESD safety procedures while handling these parts.
- Some products contain more than one battery. Do not disassemble or expose a battery to high temperatures, such as throwing into fire, or the battery may explode.
- Refer to government requirements for battery recycling or disposal.

This information provides general service information for the monitor. Adherence to the procedures and precautions is essential for proper service.

IMPORTANT: Only trained service personnel who are familiar with this HP product should perform service or maintenance for it. Before performing any service or maintenance, personnel must read the important safety information.

IMPORTANT: You must disconnect the power cord from the power source before opening the monitor to prevent component damage.

Important service information and precautions

- Repair must be performed by professional service technicians in a repair center. End users should not perform these procedures.
- Please note during servicing that the primary side is the high voltage area.
- This monitor meets ROHS requirements. Be sure to use lead-free solder wire when soldering.
- If you must change a capacitor, be sure to match the polarity as printed on the PCB.
- If you must replace a capacitor, make sure the specification and part number match the BOM and location.
- If you must replace a capacitor, insert new parts carefully to avoid a short circuit caused by the near pin.
- Do not get the board wet. Water and moisture can cause a short circuit that causes malfunctions.

- To avoid damage, be sure to use lead-free solder.
- When soldering, work quickly to avoid overheating the circuit board.
- Keep the soldering iron tip clean and well tinned when replacing parts.
- After repair, perform a close inspection of the circuit board to confirm it is in good condition.
- After repair, perform a function test to confirm the power supply is working properly.

ERP Lot5 requirement

1. A professional repairer must have the technical competence to repair electronic displays and comply with the applicable regulations for repairers of electrical equipment in the Member States where the repairer operates. Reference to an official registration system as professional repairer, where such a system exists in the Member States, shall be accepted as proof of compliance.

2. A professional repairer must have insurance that covers liabilities resulting from repairs, regardless of whether required by the Member State.

RoHS (2002/95/EC) requirements

Applied to all countries that require RoHS.

The RoHS (Restriction of Hazardous Substance in Electrical and Electronic Equipment Directive) is a legal requirement by the EU (European Union) for the global electronics industry sold in the EU and other countries. Any electrical and electronics products launched in the market after June 2006 should meet this RoHS requirement. Products launched in the market before June 2006 are not required to be compliant with RoHS parts. If the original parts are not RoHS compliant, the replacement parts can be non-ROHS compliant. If the original parts are RoHS compliant, the replacement parts **MUST** be RoHS compliant.

If product service or maintenance requires replacing parts, confirm the RoHS requirement before replacement.

General descriptions

This manual contains general information. There are two levels of service:

Level 1: Cosmetic/appearance/alignment service

Level 2: Circuit board or standard parts replacement

Firmware updates

Firmware updates for the monitor are available at support.hp.com. If no firmware is posted, the monitor does not need a firmware update.

Before returning the repaired product to the customer

Perform an AC leakage current check on exposed metallic parts to be sure the product is safe to operate without the potential of electrical shock. Do not use a line isolation transformer during this check.

Measurements that are not within specified limits present a possible shock hazard. You must check and repair the product before returning it to the customer.

2 Monitor features

This chapter provides an overview of the monitor's features.

Features

Depending on the model, your monitor might include the following features:

Display features

- 68.58 cm (27 in) plus full-screen support for lower resolutions; includes custom scaling for maximum image size while preserving original aspect ratio
- Liquid crystal display (LCD) with active matrix and in-plane switching (IPS) (select products only)
- sRGB color gamut
- Nonglare panel with an LED backlight
- Tilt capabilities
- Height adjustment capabilities (select products only)
- On-screen display (OSD) adjustments in several languages for easy setup and screen optimization
- Energy saver feature to meet requirements for reduced power consumption
- Security cable slot on the rear of the monitor for an optional security cable
- Cable management feature for placement of cables and cords
- Speakers are available on select models only

Connectors

- VGA port (select products only)
- DisplayPort™ video input (select products only)
- High-Definition Multimedia Interface™ (HDMI™) video input
- USB Type-C® port (select products only)
- Plug and Play capability, if supported by your operating system **Monitor**

stand

- Removable stand for flexible monitor head mounting solutions
- VESA® mounting capability (100 × 100 mm) for attaching the monitor to a swing arm mount
- Support for a mounting bracket to attach the monitor to a workstation

NOTE: For safety and regulatory information, see the *Product Notices* provided in your documentation kit. To access the latest user guide, go to <http://www.hp.com/support>, and follow the instructions to find your product. Then select **Manuals**.

Front components

To identify the components on the front of the monitor, use this illustration and table.

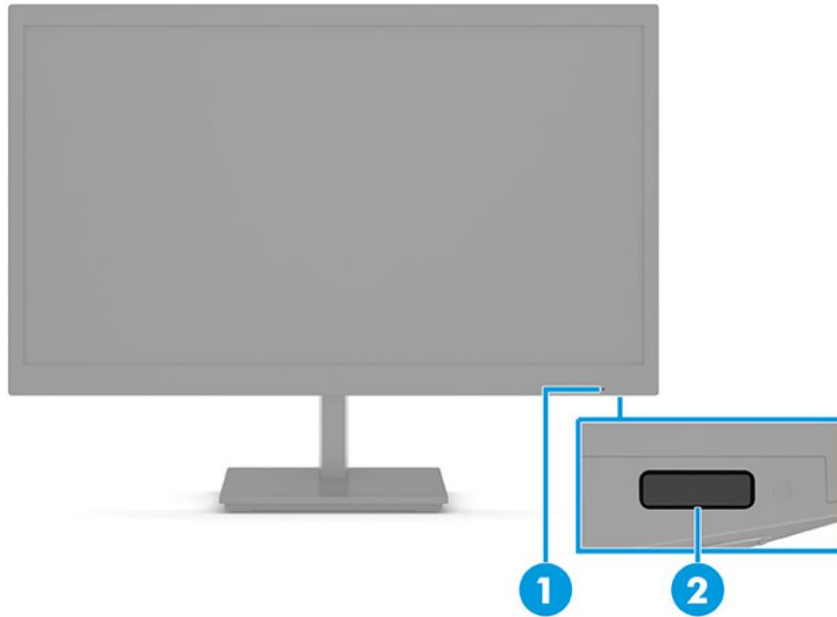

Table 1-1: Front components and their descriptions

Component		Function
1	Power LED	Indicates that the monitor is powered on.
2	Power button	Turns the monitor on or off. NOTE: Be sure that the master power switch on the monitor is in the On position to turn on the monitor. (Select products only.)

Rear components

To identify the components on the rear of the monitor, use this illustration and table.

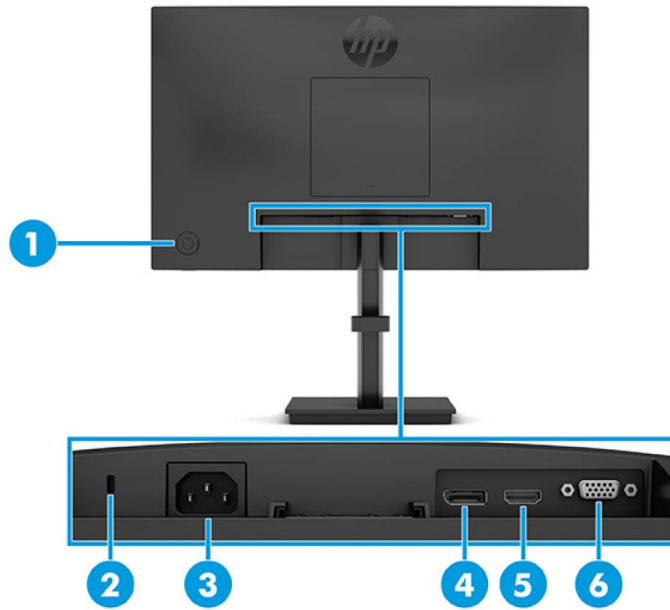
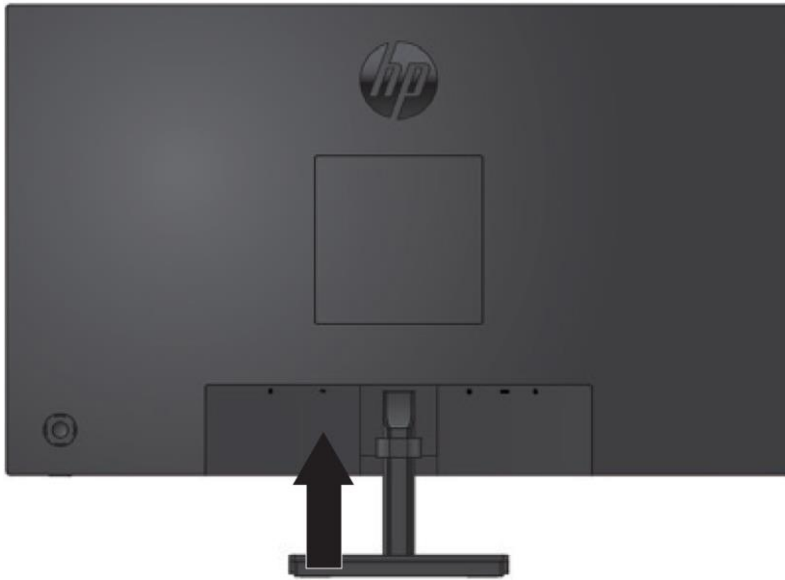

Table 1-2: Rear components and their descriptions

Component	Function
1 Joypad OSD button	Opens the OSD settings.
2 Security cable slot	Connects an optional security cable.
3 Power connector	Connects a power cord.
4 DisplayPort connector	Connects a DisplayPort cable to a source device such as a computer or game console.
5 HDMI port	Connects the HDMI cable to a source device such as a computer or game console.
6 VGA port	Connects a VGA cable to a source device such as a computer or game console.
4 Menu button	Press to open the OSD menu.
5 Security cable slot	Connects an optional security cable.
6 Power connector	Connects a power cord.

Locating the serial number and product number

The SPEC label (1) and Barcode label (2) are located on the rear of the monitor. The serial number and product number are located on a Safety label. You may need these numbers when contacting HP about the monitor model.



Barcode label



Spec label

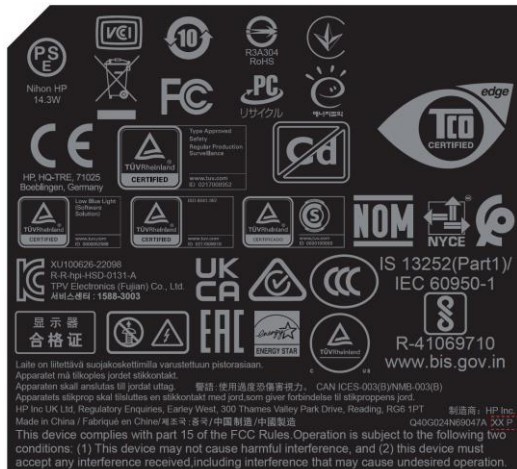

3 Illustrated parts catalog

To identify the monitor major components, use this illustration and table.

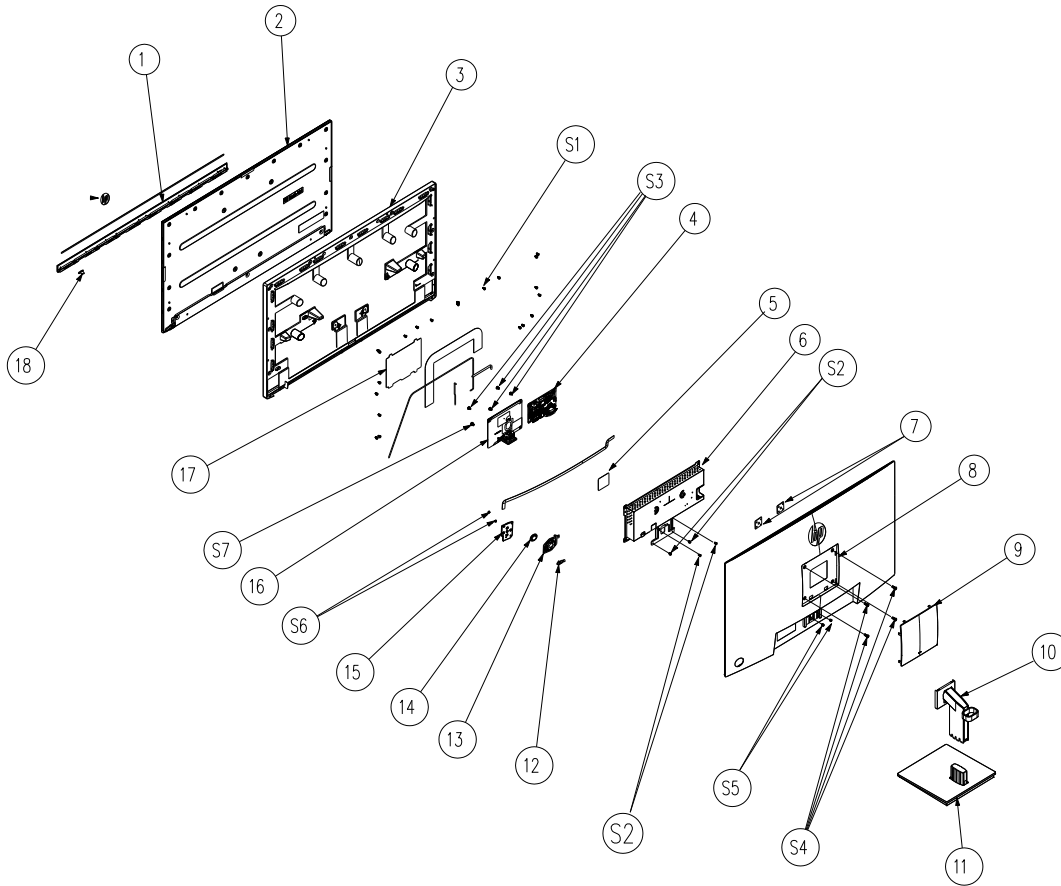

Item	Description	Qty
1	DECO_BEZEL	1
2	PANEL	1
3	MIDDLE_FRAME	1
4	MAIN BOARD	1
5	MAINFRAME	1
6	BKT_VESA	1
7	REAR_COVER	1
8	COVER_VESA	1
9	stand ass"y	1
10	BASE_ASS'Y	1
11	KEY_POWER	1
12	KEY_FUNCTION	1

13	KEY	1
14	KEY BOARD	1
15	ADAPTER BOARD NA	1
16	INSULATING SHEET 125.7*92.9*0.5mm	1
17	LENS	1
18	DECO_BEZEL	1
S1	0M1G3030 4120	11
S2	0Q1G3030 6 47 CR3	4
S3	0M1G1030 6120	3
S4	0M1G2940 10 47 CR3	4
S5	0M1G3030 4 47 CR3	2
S6	QQ1G24200301200AWL	2
S7	QM1G38400601200ARA	1

How to order parts

The HP authorized repair center can purchase the power board from HP.

Power board

Description	HP spare part number	Manufacturer part number
PSU V27i G5 1 st Source	N16742-001	PLPCLH521GQB6
PSU V27i G5 2 nd Source	N16742-002	PLPCLH671KQB7
PSU V27i G5 3 rd Source	N16742-003	PLPCLH531AQB3

Capacitors and connectors are available for purchase from the following EU distributors:

- Farnell: [Farnell UK - Electronic Components Distributor](#)
- RS Component: [Capacitors | RS Components \(rs-online.com\)](#)
- tme Component: [Transfer Multisort Elektronik](#)

Capacitors by distributor

Component description	Location	Component distributor	Distributor part number
EC 470uF 20% 25V 10x12 5000 hr 1.7A ECR1	C916	NA	Contact HP Support

Connectors by manufacturer

Component description	Location identifier	Component distributor	Distributor part number
DisplayPort	CN501	Farnell	DP1RD20JQ1 (JAE)
HDMI	CN502	RS	DP1RD20JQ1 (JAE)
D-SUB	CN503	tme	HDL15-SL-B (ADAM TECH)

NOTE: Rear cover and chassis need to be modified to hold connector. Connector may need modifications to meet functional, safety and regulatory requirements accordingly if it doesn't match exactly.

NOTE: The connector may need to be modified to meet functionality, regulatory and safety requirements if it is not an exact match.

You can purchase cables from the HP part store at <https://partsurfer.hp.com/Search.aspx>.

Internal and External Power Supplies are available for purchase from the following EU distributor: EET_ <https://www.eetgroup.com/en-eu/>

NOTE: HP continually improves and changes product parts. For complete and current information about supported parts for your product, go to <https://partsurfer.hp.com/Search.aspx>, select your country or region, and then follow the on-screen instructions.

4 Removal and replacement procedures

Adherence to these procedures and precautions is essential for proper service.

Preparation for disassembly

Use this information to properly prepare to disassemble and reassemble the monitor.

- 1) Read the “Important safety information” and “Important service information and precautions” sections in the “Getting started” chapter of this guide.
- 2) Clean the room for disassembly.
- 3) Identify the disassembly area.
- 4) Check the position that the monitors are to be placed along with the number of monitors. Prepare the area for material flow according to the disassembly layout.
- 5) Be sure to have the following equipment and materials:
 - Press fixture
 - Working table
 - Screwdriver
 - Knife
 - Gloves
 - Cleaning cloth
 - ESD protection
 - Scraper bar in the following dimensions:

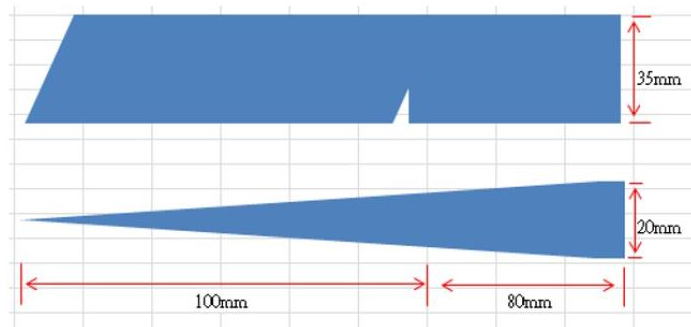

Rear Cover

Before removing the Rear Cover, follow these steps:

- ▲ Prepare the monitor for disassembly. See Preparation for disassembly on page 11.

Remove the Rear Cover:

- 1) Remove four screw from the rear case.

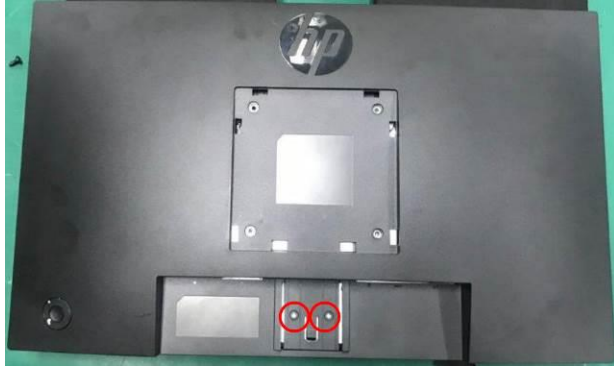

- 2) Use your fingers to split the left and right sides apart between the middle frame and rear case.



- 3) Insert the scraper bar tool into the gap between the middle frame and rear case, and then rotate. The hook opens. Repeat the steps.

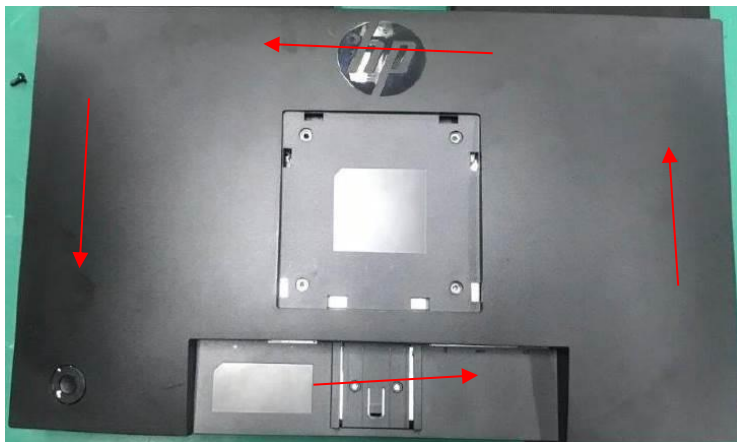

- 4) Disassemble the Rear Cover and disconnect the connectors.

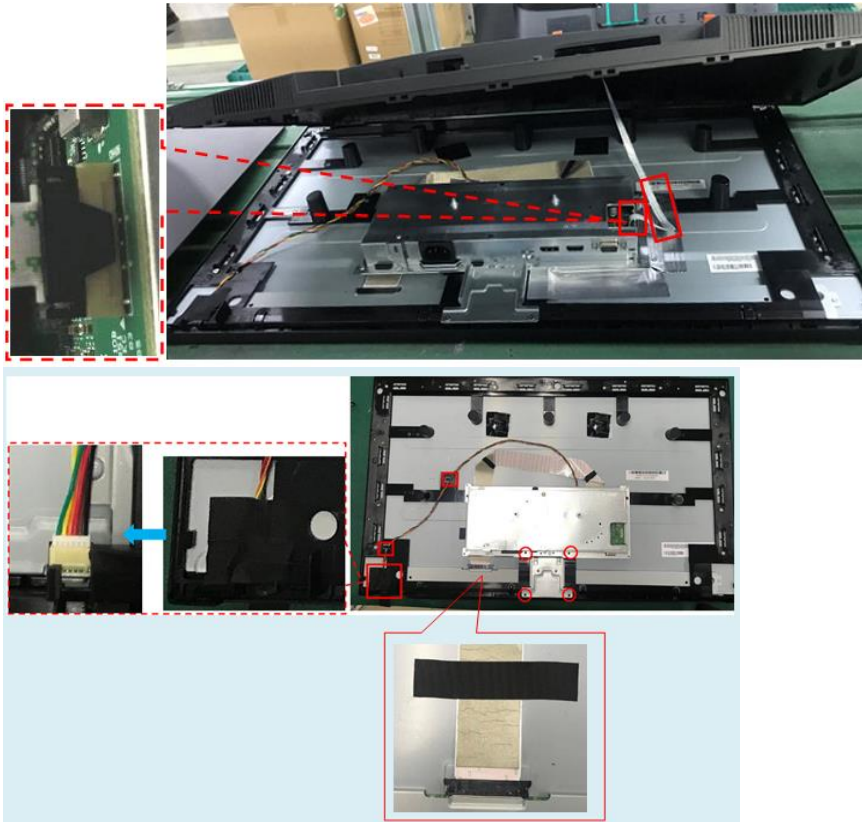

- 5) Remove the Mylar.

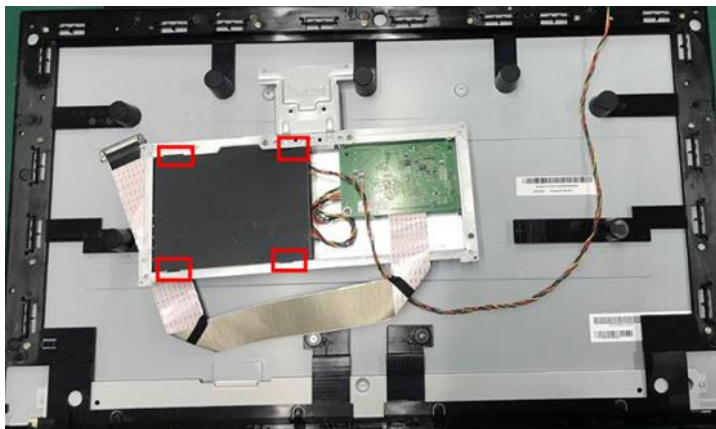

- 6) Disassemble 6 screws from the boards.
- 7) Disassemble all the boards from housing.
- 8) Disconnect all the wires from the board.

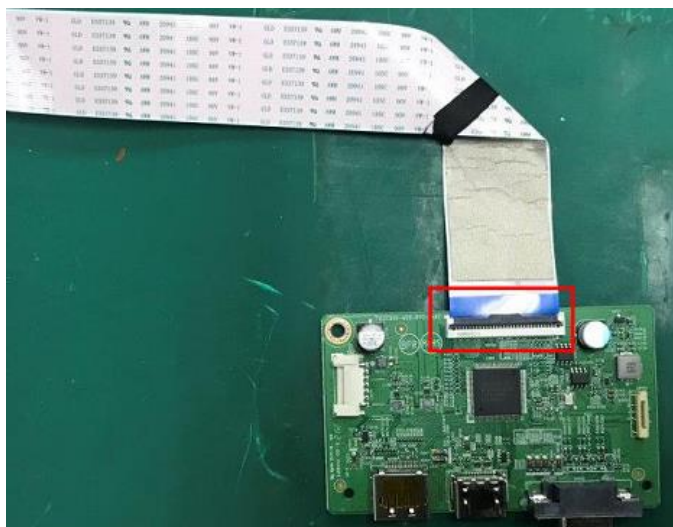
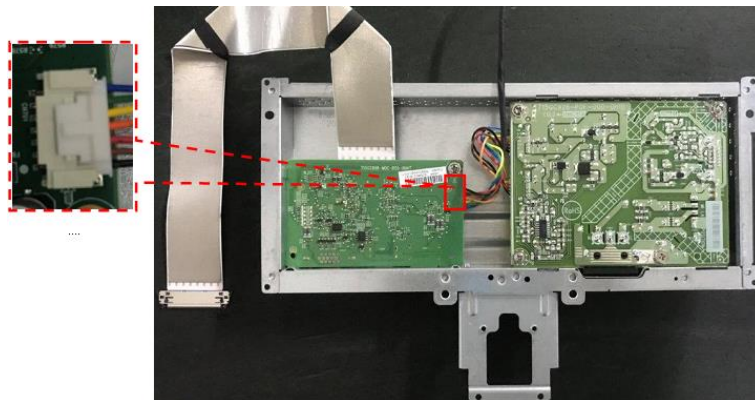
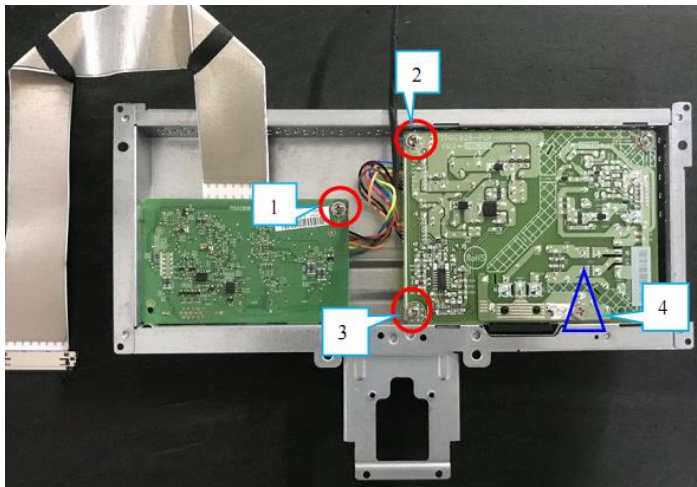

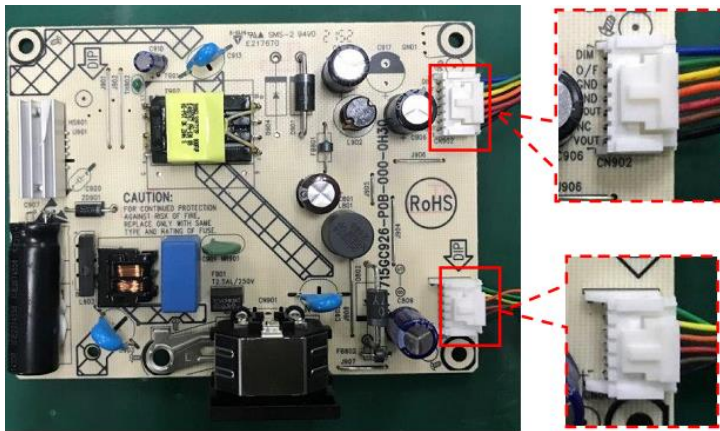

9) Remove the screws to remove the middle frame and the panel.

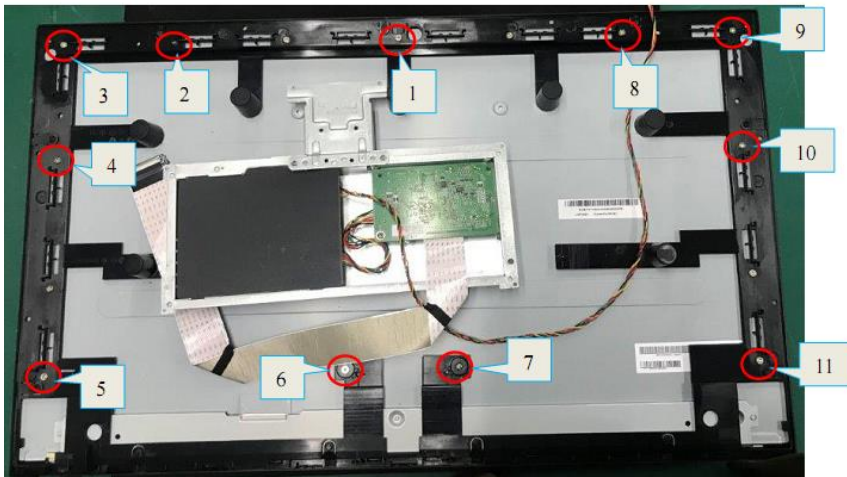

Power board

The power board part number is PLPCLH521GQB6 (1st Source) or PLPCLH671KQB7 (2nd Source) and PLPCLH531AQB3 (3rd Source).

Before removing the power board, follow these steps:

- ▲ Prepare the monitor for disassembly. See Preparation for disassembly on page 11.

Remove the power board:

- 1) The HP V27i G5 power board connector position is as follows:

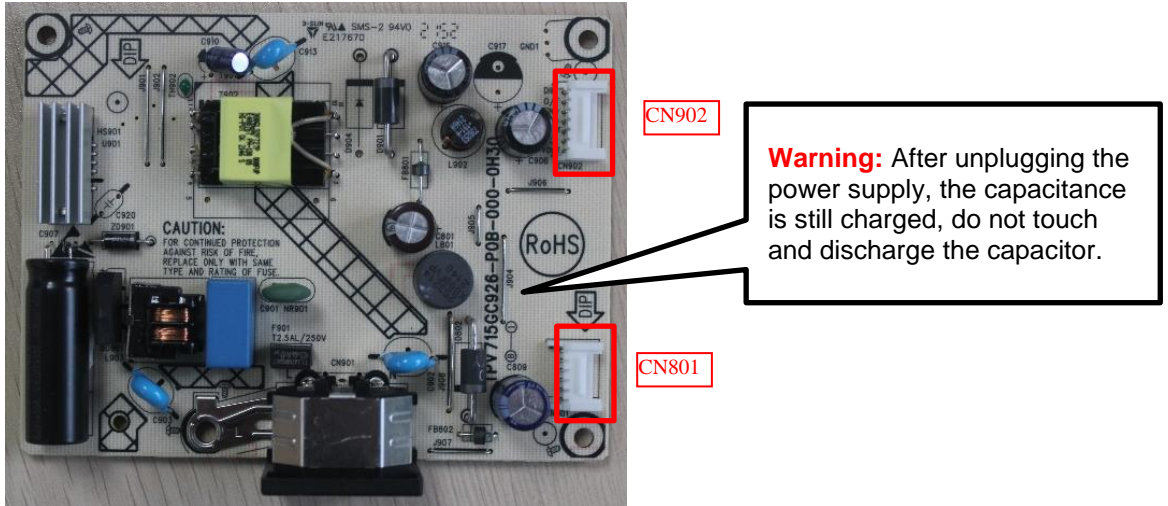

- 2) Locate the part number location on the board.



Connector repair

This procedure includes DisplayPort, HDMI and D-SUB connectors.

The connectors are on the main board (board part number CBPR1EBH7Q5).

The connectors identifiers are as follows:

Connector	Location
DisplayPort	CN501
HDMI	CN502
D-SUB	CN503

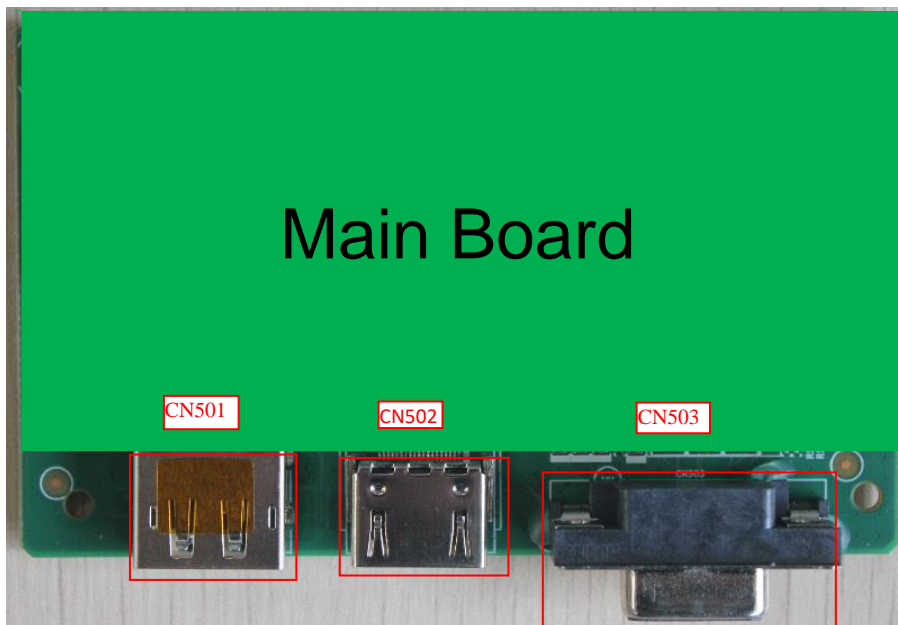

Before repairing connectors, follow these steps:

- ▲ Prepare the monitor for disassembly. See [Preparation for disassembly](#) on page 13.

IMPORTANT:

- **Repair Condition: Connector repair is only for out of warranty.**
- **Repairing must operate by professional repairers (Note) in repair center, not applicable for end user.**
- **Electrostatic protection is required when component replacement is required.**
- **The monitor meets ROHS, please use Lead-free solder wire for soldering.**
- **If Connector need to replace, must check specification and part number whether match the BOM and location.**
- **If connector need to replace, please insert new parts carefully because the near pin may cause short circuit by inappropriate operate.**
- **DO NOT allow any liquid on the board. Water and moisture may cause short-circuit to the electronic**

components and lead to malfunctions.

- **The fusion point of Lead-Free solder is requested. Repairing with conventional lead wire may cause damage.**
- **Work quickly to avoid overheating the circuit board as soon as you confirm the steady soldering condition.**
- **Keep the soldering iron tip clean and well tinned and when replacing parts.**
- **A close inspection of the circuit board revealed look in good condition.**
- **After repaired, must connect source to each port to check Main board function is ordinary.**

Note: (The requirement of professional repairers' regulation by ERP lot5)

- 1) The professional repairer has the technical competence to repair electronic displays and complies with the applicable regulations for repairers of electrical equipment in the Member States where it operates. Reference to an official registration system as professional repairer, where such system exists in the Member States concerned, shall be accepted as proof of compliance with this point.
- 2) The professional repairer is covered by insurance covering liabilities resulting from its activity, regardless of whether this is required by the Member State.

DP connector CN501

Repair the DP connector:

- 1) Use a soldering iron and a de-soldering pump to remove as much solder as possible from the pin.

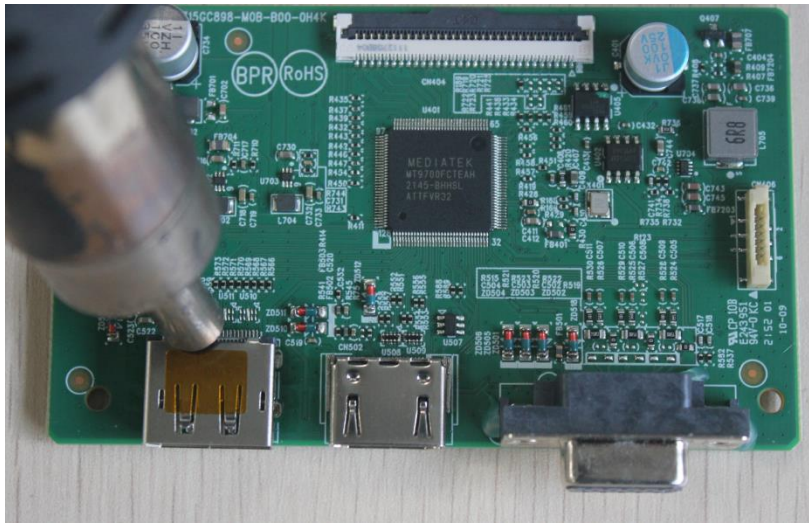

- 2) Use a hot air gun to melt the solder on the pins.



- 3) Lift the CN501 connector from the circuit board.
- 4) Place the new component on the circuit board. Be sure that it matches the circuit board footprint.
- 5) Solder the new component.

HDMI connector CN502

Repair the HDMI connector:

- 1) Use a soldering iron and a de-soldering pump to remove as much solder as possible from the pin.

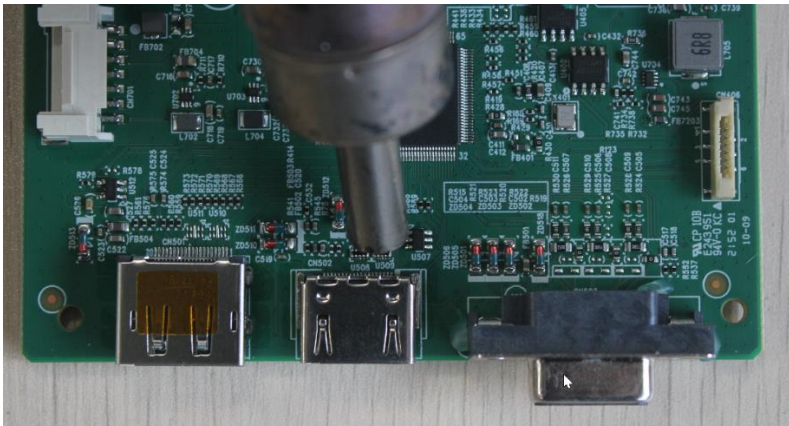

- 2) Use a hot air gun to melt the solder on the pins.

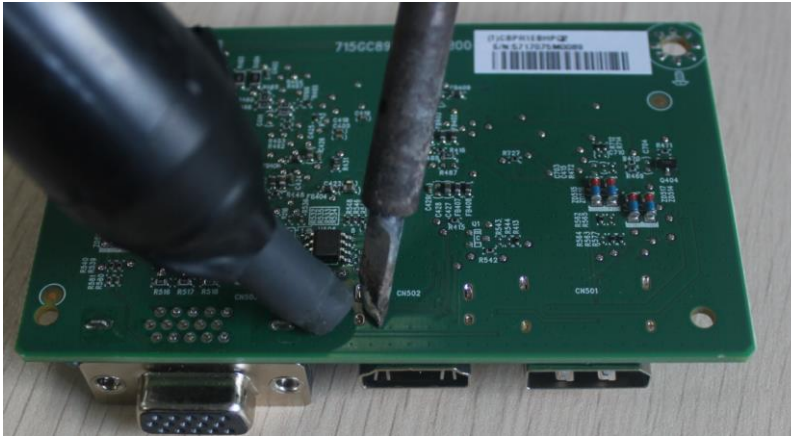

- 3) Lift the CN502 connector from the circuit board.
- 4) Place the new component on the circuit board. Be sure that it matches the circuit board footprint.
- 5) Solder the new component.

D-SUB connector CN503

Repair the D-SUB connector:

- 1) Use a soldering iron and a de-soldering pump to remove as much solder as possible from the pin.



- 2) Lift the CN503 connector from the circuit board.
- 3) Place the new component on the circuit board. Be sure that it matches the circuit board footprint.
- 4) Solder the new component.

Function test

After repair, be sure to confirm that all functions are working.

Table 4-1: Function test

Test item	Operating description	Tool used
HDMI test	Confirm whether image displays and sound plays correctly on the monitor.	Computer or DVD player
DP test	Confirm whether image displays and sound plays correctly on the monitor.	Computer or DVD player
D-SUB test	Confirm whether image displays and sound plays correctly on the monitor	Computer or D-SUB player

Support and troubleshooting

The following table lists possible problems, the possible cause or each problem, and the recommended solutions.

Table 4-2: Solving common problems

Problem	Possible cause	Solution
Screen is blank or video is flashing.	Power cord is disconnected.	Connect the power cord.
	Monitor is off.	Power the power button. NOTE: If pressing the Power button has no effect, press and hold the power button for 10 seconds to disable the Power button lockout feature.
	Master power switch is set to off.	Set the master power switch on the rear of the monitor to the On position.
	Video cable is improperly connected.	Connect the video cable properly.
Image appears blurred, indistinct, or too dark.	System is in Auto-Sleep Mode.	Press any key on the keyboard or move the mouse to inactivate the screen blanking utility.
	Video card is incompatible.	Open the OSD menu and select the Input menu. Set Auto-Switch Input to Off and manually select the input or replace the video card or connect the video cable to one of the computer's on-board video sources.
Check Video Cable is	Monitor video cable is disconnected.	Open the OSD menu and select Brightness to adjust the brightness scale as needed. Connect the appropriate

displayed on screen.		video signal cable between the computer and monitor. Be sure that the computer power is off while connecting the video cable.
Input Signal Out of Range is displayed on screen.	Video resolution, refresh rate, or both, are set higher than the monitor supports.	Change the settings to a supported setting.
The monitor does not enter into a low-power sleep state.	The monitor's power saving control is disabled.	Open the OSD menu and select Power, select Auto-Sleep Mode, and then set auto-sleep to On.
“OSD Lockout” is displayed	The monitor’s OSD lockout function is enabled.	Press and hold the Left button for 10 seconds to disable the OSD Lockout function.
“Power Button Lockout” is displayed.	The monitor's Power Button Lockout feature is enabled.	Press and hold the Power button for 10 seconds to unlock the power button function.
Monitor has trouble waking from Sleep mode		DisplayPower or USB Type-C inputs: Set the DisplayPort hot-plug detection to Always Active. Power mode monitors: Set the hot-plug detection to Always Active to switch the monitor to Performance mode.
Monitor is not displaying the preferred resolution or refresh rate.		Multi-streaming USB Type-C: Set the USB Type-C configuration to USB 2.x.
Slow performance from USB devices connected to the USB Type-A monitor connectors		Set the USB Type-C configuration to 3.x to enable better performance for integrated or connected USB Type-A devices.

Index

- components
 - front, 5
 - rear, 6
- connector repair, 17
- features, 4
- firmware updates, 3
- front components, 5
- function test, 22
- how to order parts, 10
- illustrated parts catalog, 8
- menu button location, 5
- parts, 8
- parts, ordering, 10
- power board removal, 16
- precautions, 2
- preparation for disassembly, 11
- RC removal, 11
- rear components, 6
- removal
 - power board, 16
 - RC, 11
- removal and replacement procedures, 11
- returning to customer, 3
- RoHS (2002/95/EC) requirements, 3
- safety information, 2
- serial number location, 7
- service information, 2
- spare parts, 8
- support and troubleshooting, 22
- troubleshooting, 22