



# Maintenance and Service Guide

## **SUMMARY**

This guide provides maintenance information about such topics as spare parts, removal and replacement of parts, security, and backing up.

## Legal information

© Copyright 2023 HP Development Company, L.P.

Bluetooth is a trademark owned by its proprietor and used by HP Inc. under license. Chrome, ChromeOS, Chromebook, Google, and Google Drive are trademarks of Google LLC. Intel, Celeron, and Pentium are trademarks of Intel Corporation or its subsidiaries in the U.S. and/or other countries. Microsoft and Windows are either registered trademarks or trademarks of Microsoft Corporation in the United States and/or other countries. USB Type-C and USB-C are registered trademarks of USB Implementers Forum. DisplayPort™ and the DisplayPort™ logo are trademarks owned by the Video Electronics Standards Association (VESA®) in the United States and other countries. Wi-Fi is a registered trademark of Wi-Fi Alliance.

The information contained herein is subject to change without notice. The only warranties for HP products and services are set forth in the express warranty statements accompanying such products and services. Nothing herein should be construed as constituting an additional warranty. HP shall not be liable for technical or editorial errors or omissions contained herein.

First Edition: February 2023

Document Part Number: N38465-001

### Product notice

This guide describes features that are common to most models. Some features may not be available on your computer.

To access the latest user guides, go to <http://www.hp.com/support>, and follow the instructions to find your product. Then select **Manuals**.

### Software terms

By installing, copying, downloading, or otherwise using any software product preinstalled on this computer, you agree to be bound by the terms of the HP End User License Agreement (EULA). If you do not accept these license terms, your sole remedy is to return the entire unused product (hardware and software) within 14 days for a full refund subject to the refund policy of your seller.

For any further information or to request a full refund of the price of the computer, please contact your seller.

## Safety warning notice

Reduce the possibility of heat-related injuries or of overheating the computer by following the practices described.

- 
- ⚠ WARNING!** To reduce the possibility of heat-related injuries or of overheating the computer, do not place the computer directly on your lap or obstruct the computer air vents. Use the computer only on a hard, flat surface. Do not allow another hard surface, such as an adjoining optional printer, or a soft surface, such as pillows or rugs or clothing, to block airflow. Also, do not allow the AC adapter to come into contact with the skin or a soft surface, such as pillows or rugs or clothing, during operation. The computer and the AC adapter comply with the user-accessible surface temperature limits defined by applicable safety standards.
-

---

# Table of contents

<b>1 Product description</b>	<b>1</b>
<b>2 Components</b>	<b>3</b>
Right	3
Left	4
Display	5
Keyboard area	6
Touchpad	7
Special keys	7
Bottom	8
Labels	8
<b>3 Illustrated parts catalog</b>	<b>11</b>
Computer major components	11
Display assembly subcomponents	13
Miscellaneous parts	14
<b>4 Removal and replacement procedures preliminary requirements</b>	<b>16</b>
Tools required	16
Service considerations	16
Plastic parts	16
Cables and connectors	16
Drive handling	16
Electrostatic discharge information	17
Generating static electricity	17
Preventing electrostatic damage to equipment	18
Personal grounding methods and equipment	18
Grounding the work area	19
Recommended materials and equipment	19
Cleaning your computer	20
Enabling HP Easy Clean (select products only)	20
Removing dirt and debris from your computer	20
Cleaning your computer with a disinfectant	21
Caring for wood veneer (select products only)	22
Packaging and transporting guidelines	22
Accessing support information	23
<b>5 Removal and replacement procedures for authorized service provider parts</b>	<b>25</b>
Component replacement procedures	25
Preparation for disassembly	25



Top cover with keyboard .....	25
Touchpad cable.....	28
Touchpad .....	29
Keyboard camera .....	30
Keyboard camera cable.....	31
Speakers.....	32
Battery.....	33
WLAN module.....	35
USB board cables.....	36
USB board.....	37
System board .....	38
Lock bracket .....	41
Display assembly.....	42
<b>6 Backing up, resetting, and recovering.....</b>	<b>50</b>
Backing up .....	50
Resetting.....	50
Recovering.....	50
Option 1: Recovering using an internet connection.....	51
Option 2: Installing the Chromebook Recovery Utility.....	51
Creating recovery media .....	51
Recovering the Chrome operating system with recovery media.....	52
Setting up your computer after a reset or recovery .....	52
Erasing and reformatting the recovery media .....	52
<b>7 Specifications.....</b>	<b>54</b>
Computer specifications.....	54
35.6 cm (14.0 in) display specifications .....	54
<b>8 Power cord set requirements .....</b>	<b>56</b>
Requirements for all countries .....	56
Requirements for specific countries and regions.....	56
<b>9 Recycling.....</b>	<b>58</b>
<b>Index.....</b>	<b>59</b>

# 1 Product description

This table provides detailed product information.

**Table 1-1 Product components and their descriptions**

Category	Description
<b>Product Name</b>	<b>HP Fortis x360 11 inch G3 J Chromebook™</b>
<b>Processors</b>	<b>Intel® processors</b> Intel Pentium® Silver N6000 (1.1 GHz base frequency, 4 MB cache, 4 cores, 6 W) Intel Celeron® N5100 (1.1 GHz base frequency, 4 MB cache, 4 cores, 6 W) Intel Celeron N4500 (1.1 GHz base frequency, 4 MB cache, 2 cores, 6 W)
<b>Graphics</b>	<b>Intel UHD Graphics</b>
<b>Display</b>	<b>11.6 in (29.46 cm), WLED backlit, BrightView, touch screen (TOP+) with Corning® Gorilla® Glass 3</b> High Definition (HD) (1366 × 768), eDP, 50% NTSC, 220 nits
<b>Memory</b>	Integrated, not customer accessible or upgradeable supporting up to 8 GB of RAM LPDDR4X-4266 dual-channel support Supports the following configurations: <ul style="list-style-type: none"><li>• 8 GB</li><li>• 4 GB</li></ul>
<b>Primary storage</b>	<b>embedded MultiMedia Controller (eMMC) 5.0</b> 64 GB 32 GB
<b>Audio and video</b>	Dual speakers 5 MP camera (select products only) 720p camera
<b>Wireless</b>	<b>Wireless Local Area Network (WLAN)</b> Intel Wi-Fi 6 AX201 802.11ax (2 × 2) and Bluetooth® 5.2
<b>Ports</b>	Audio-out (headphone)/audio-in (microphone) combo jack USB Type-C® power connector and SuperSpeed ports (2) USB SuperSpeed ports (2)
<b>Keyboard/pointing devices</b>	<b>Keyboard</b> (island style, spill resistant) Clickpad

**Table 1-1 Product components and their descriptions (continued)**

<b>Category</b>	<b>Description</b>
<b>Power requirements</b>	<b>Battery</b>
	2 cell, 47 Whr, HP Long Life
	HP Fast Charge
	<b>AC adapter, 45 W</b> (USB Type-C, non power factor correction, (nPFC), straight, 1.8 m [6 ft])
	<b>Power cord</b>
C5, conventional, sticker, 1 m (3.3 ft)	
<b>Security</b>	H1 Secure Microcontroller
	Nano lock slot
	HP Sure Key Cable Lock
<b>Operating system</b>	<b>Google Chrome™</b>
	Google Chrome with Chrome Education Upgrade (select products only)
	Google Chrome with Chrome Enterprise Upgrade (select products only)
<b>Serviceability</b>	<b>End user replaceable parts</b>
	AC adapter

## 2 Components



Your computer features top-rated components. This chapter provides details about your components, where they are located, and how they work.

### Right

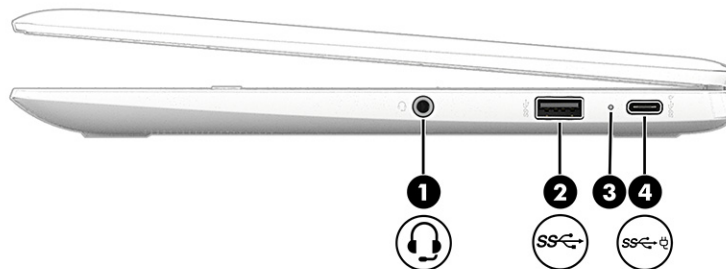
Use the illustration and table to identify the components on the right side of the computer.



**Table 2-1** Right-side components and their descriptions

Component	Description
(1) 	<p>Audio-out (headphone)/Audio-in (microphone) combo jack</p> <p><b>WARNING!</b> To reduce the risk of personal injury, adjust the volume before putting on headphones, earbuds, or a headset. For additional safety information, see the <i>Regulatory, Safety, and Environmental Notices</i>.</p> <p><b>NOTE:</b> When a device is connected to the jack, the computer speakers are disabled.</p>
(2) 	<p>USB SuperSpeed 5 Gbps port</p> <p>Connects a USB device, provides high-speed data transfer, and (for select products) charges small devices (such as a smartphone) when the computer is on or in Sleep mode.</p> <p><b>NOTE:</b> Use a standard USB Type-A charging cable or cable adapter (purchased separately) when charging a small external device.</p>
(3)	<p>AC adapter and battery light</p> <ul style="list-style-type: none"><li>• White: The AC adapter is connected and the battery is fully charged.</li><li>• Amber: The AC adapter is connected and the battery is charging.</li><li>• Blinking amber: The battery has an error.</li><li>• Off: The battery is not charging.</li></ul>

**Table 2-1** Right-side components and their descriptions (continued)



Component	Description
(4) 	<p>USB Type-C power connector and SuperSpeed 5 Gbps port</p> <p>Connects an AC adapter that has a USB Type-C connector, supplying power to the computer and, if needed, charging the computer battery.</p> <p>- and -</p> <p>Connects a USB device, provides high-speed data transfer, and charges small devices (such as a smartphone), even when the computer is off.</p> <p><b>NOTE:</b> Use a standard USB Type-C charging cable or cable adapter (purchased separately) when charging a small external device.</p>

## Left

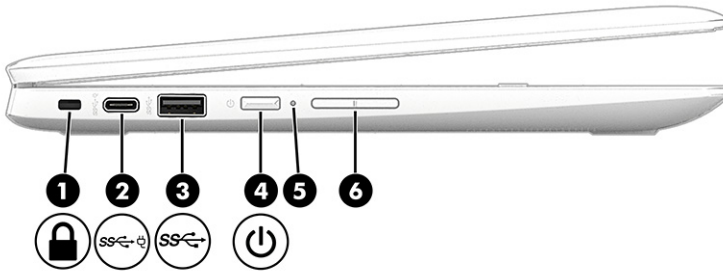

Use the illustration and table to identify the components on the left side of the computer.



**Table 2-2** Left-side components and their descriptions

Component	Description
(1) 	<p>Security cable slot</p> <p>Attaches an optional security cable to the computer.</p> <p><b>NOTE:</b> The security cable is designed to act as a deterrent, but it might not prevent the computer from being mishandled or stolen.</p>
(2) 	<p>USB Type-C power connector and SuperSpeed 5 Gbps port</p> <p>Connects an AC adapter that has a USB Type-C connector, supplying power to the computer and, if needed, charging the computer battery.</p> <p>- and -</p> <p>Connects a USB device, provides high-speed data transfer, and charges small devices (such as a smartphone), even when the computer is off.</p> <p><b>NOTE:</b> Use a standard USB Type-C charging cable or cable adapter (purchased separately) when charging a small external device.</p>

**Table 2-2** Left-side components and their descriptions (continued)

Component	Description
(3)  USB SuperSpeed 5 Gbps port	<p>Connects a USB device, provides high-speed data transfer, and (for select products) charges small devices (such as a smartphone) when the computer is on or in Sleep mode.</p> <p><b>NOTE:</b> Use a standard USB Type-A charging cable or cable adapter (purchased separately) when charging a small external device.</p>
(4)  Power button	<ul style="list-style-type: none"><li>• When the computer is off, press the button briefly to turn on the computer.</li><li>• When the computer is on, press the button briefly to initiate Sleep.</li><li>• When the computer is in the Sleep state, press the button briefly to exit Sleep (select products only).</li><li>• When the computer is in Hibernation, press the button briefly to exit Hibernation.</li></ul> <p><b>IMPORTANT:</b> Pressing and holding down the power button results in the loss of unsaved information.</p> <p>If the computer has stopped responding and shutdown procedures are ineffective, press and hold the power button for at least 10 seconds to turn off the computer.</p>
(5) Power light	<ul style="list-style-type: none"><li>• White: The computer is on.</li><li>• Blinking white: The computer is in the Sleep state.</li><li>• Off: The computer is off.</li></ul>
(6) Volume button	Controls speaker volume on the computer.

## Display

Use the illustration and table to identify the components on the display.

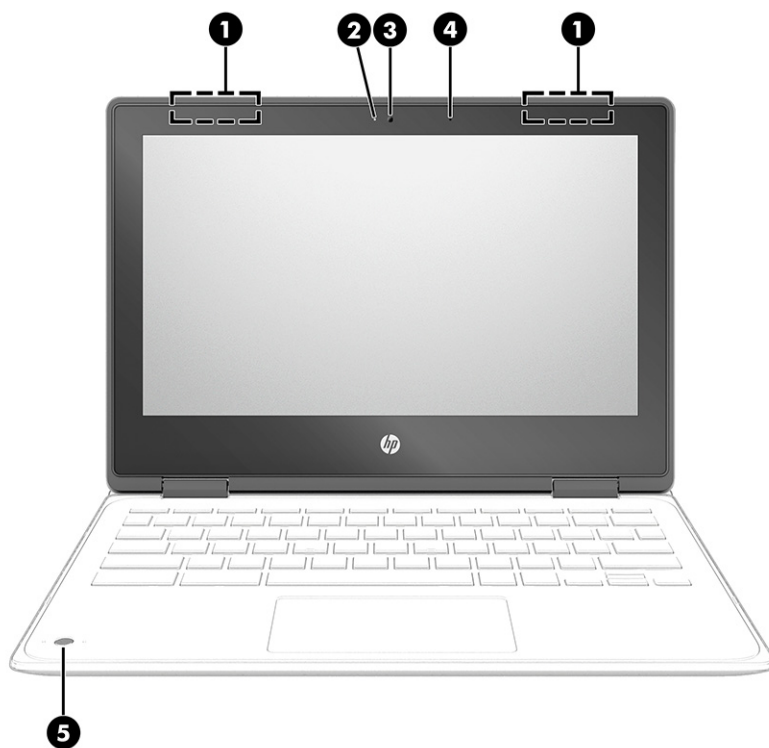

**Table 2-3** Display components and their descriptions

Component	Description
(1) WLAN antennas*	Send and receive wireless signals to communicate with wireless local area networks (WLANs).
(2) Camera light	On (white): The camera is in use. On (amber): The camera is turned off by the switch. Off: The camera is turned off by the software.
(3) Camera	Allows you to video chat, record video, and record still images. <b>NOTE:</b> Camera functions vary depending on the camera hardware and software installed on your product.
(4) Internal microphone	Records sound.
(5) Camera (select products only)	Allows you to video chat, record video, and record still images. <b>NOTE:</b> Camera functions vary depending on the camera hardware and software installed on your product.

\*The antennas are not visible from the outside of the computer. For optimal transmission, keep the areas immediately around the antennas free from obstructions.

For wireless regulatory notices, see the section of the *Regulatory, Safety, and Environmental Notices* that applies to your country or region.

## Keyboard area

Keyboards can vary by language.

## Touchpad

The touchpad settings and components are described here.

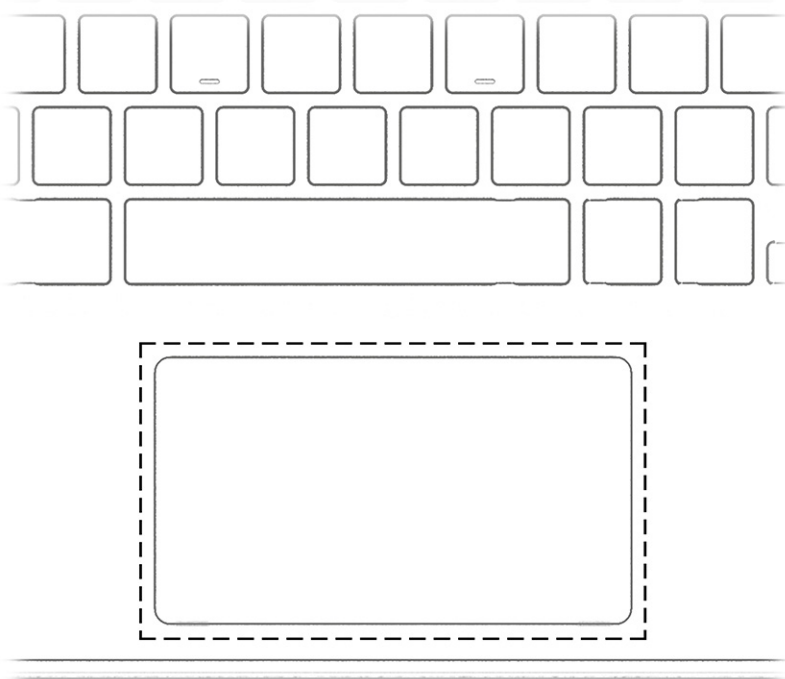
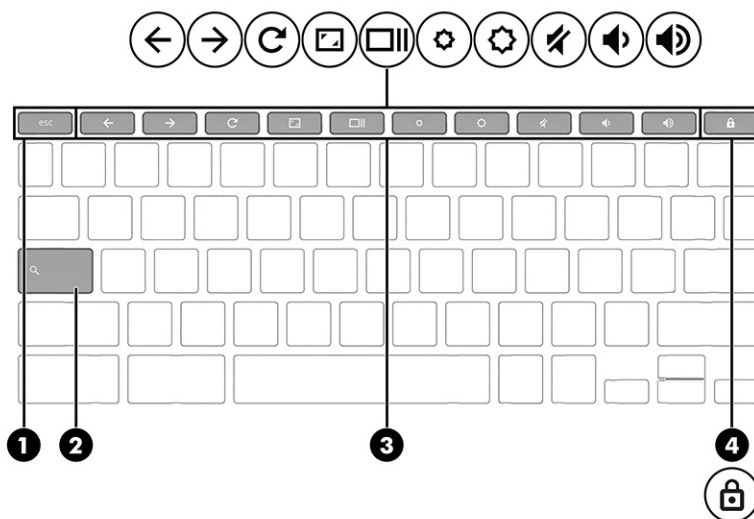

**Table 2-4** Touchpad component and description

Component	Description
Touchpad zone	Reads your finger gestures to move the pointer or activate items on the screen.

## Special keys

Use the illustration and table to locate the special keys.



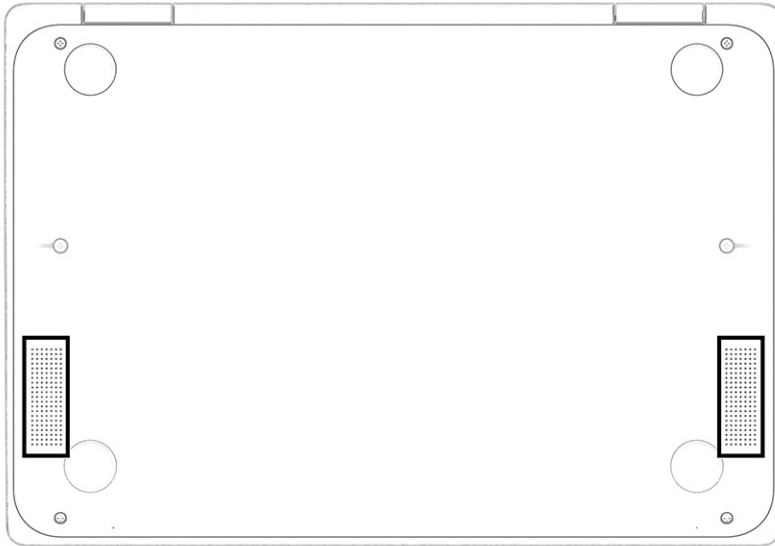

**Table 2-5** Special keys and their descriptions

Component	Description
(1) <code>esc</code> key	Activates certain computer functions when pressed in combination with other keys, such as <code>tab</code> or <code>shift</code> .
(2) Search key	Opens the search dialog.
(3) Action keys	Execute frequently used system functions.
(4) Lock key	Closes and locks the screen, requiring users to type a password to unlock the screen.

## Bottom

Use the illustration and table to identify the bottom components.



**Table 2-6** Bottom component and description

Components	Description
Speakers	Produce sound.

## Labels

The labels affixed to the computer provide information you might need when you troubleshoot system problems or travel internationally with the computer. Labels might be in paper form or imprinted on the product.

 **IMPORTANT:** Check the following locations for the labels described in this section: the bottom of the computer, inside the battery bay, under the service door, on the back of the display, or on the bottom of a tablet kickstand.

- Service label—Provides important information to identify your computer. When contacting support, you might be asked for the serial number, the product number, or the model number. Locate this information before you contact support.

Your service label will resemble one of the following examples. Refer to the illustration that most closely matches the service label on your computer.

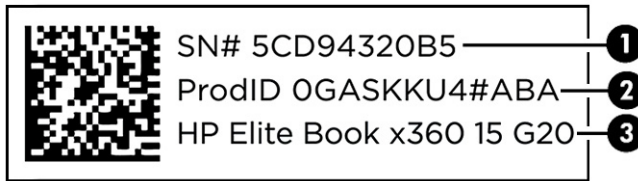

**Table 2-7** Service label components

Component	
(1)	Serial number
(2)	Product ID
(3)	HP product name

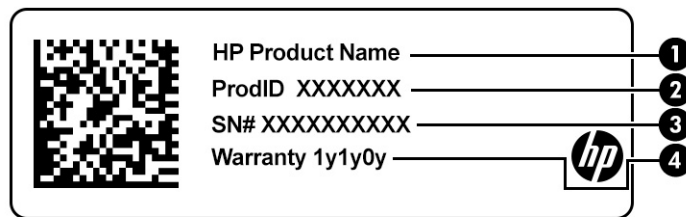

**Table 2-8** Service label components

Component	
(1)	HP product name
(2)	Product ID
(3)	Serial number
(4)	Warranty period

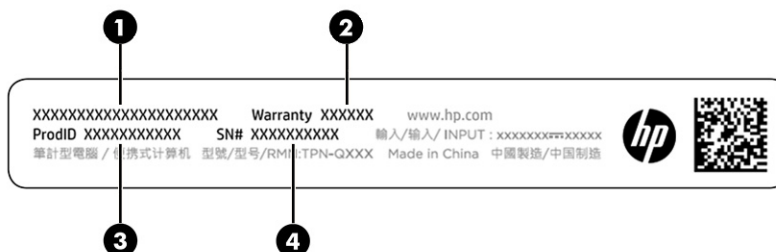

**Table 2-9 Service label components**

Component	
(1)	HP product name
(2)	Warranty period
(3)	Product ID
(4)	Serial number

- Regulatory labels—Provide regulatory information about the computer.
- Wireless certification labels—Provide information about optional wireless devices and the approval markings for the countries or regions where the devices have been approved for use.

# 3 Illustrated parts catalog

Use this chapter to determine the spare parts that are available for the computer.

## Computer major components

To identify the computer major components, use this illustration and table.

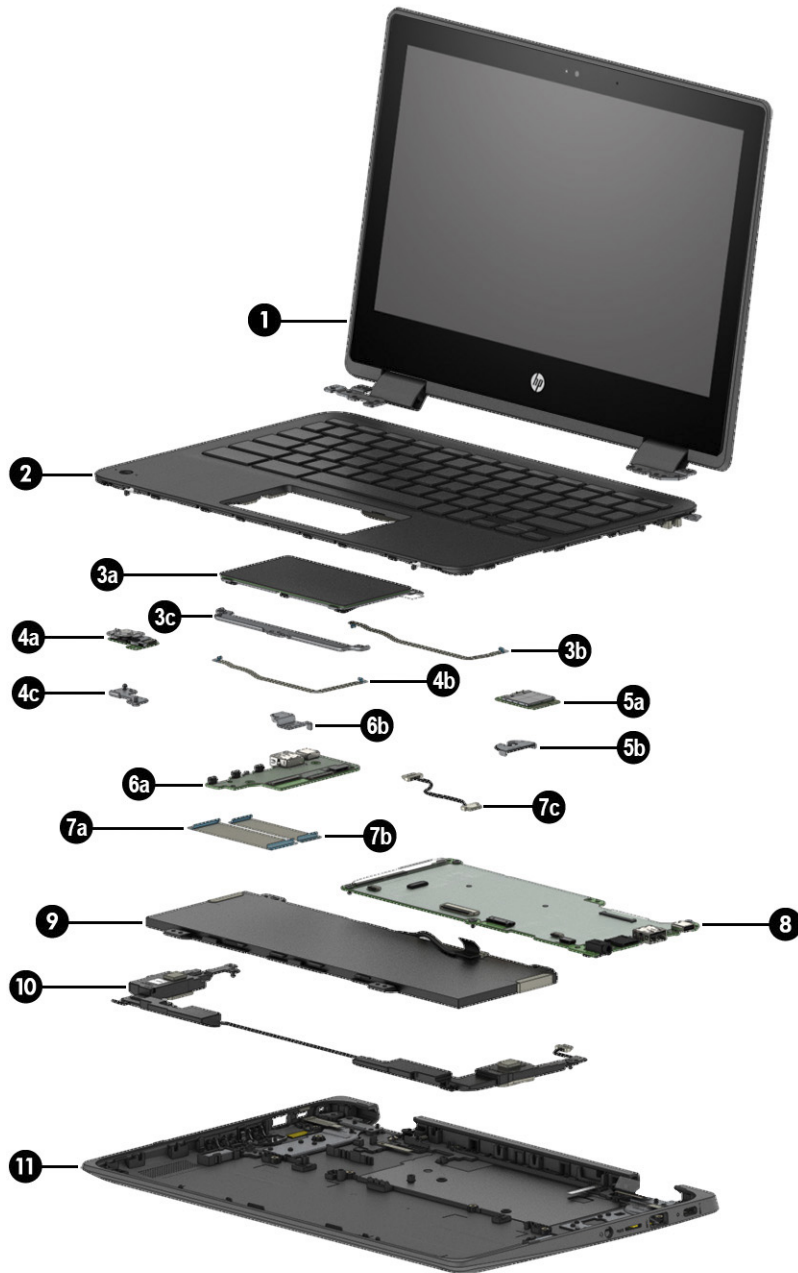

**Table 3-1 Computer major component descriptions and part numbers**

Item	Component	Spare part number
(1)	<b>Display assembly</b>  <b>NOTE:</b> Display assemblies are offered as spare parts only at a subcomponent level. For more information, see <a href="#">Display assembly subcomponents on page 13</a> .	not available as a spare part
(2)	<b>Top cover with keyboard</b>  For a detailed list of country codes, see <a href="#">Top cover with keyboard on page 25</a> .	
	Emerald green models with one camera	N38879-xxx
	Jet black models with one camera	N38880-xxx
	Emerald green models with two cameras	N38881-xxx
	Jet black models with two cameras	N38882-xxx
(3a)	<b>Touchpad</b>	
	Emerald green models	N38883-001
	Jet black models	N38884-001
(3b)	<b>Touchpad cable</b> (included in the Cable Kit)	N38878-001
(3c)	<b>Touchpad bracket</b> (included in the Bracket Kit)	N38891-001
*	<b>Touchpad bracket rubber</b>	N38885-001
(4a)	<b>Keyboard camera module</b>	N38887-001
(4b)	<b>Keyboard camera module cable</b> (included in the Cable Kit)	N38878-001
(4c)	<b>Keyboard camera module bracket</b> (included in the Bracket Kit)	N38891-001
(5a)	<b>WLAN module</b> (Intel Wi-Fi 6 AX201 802.11ax (2 × 2) and Bluetooth 5)	L92724-005
(5b)	<b>WLAN bracket</b> (included in the Bracket Kit)	N38891-001
(6a)	<b>USB board</b>	N38877-001
(6b)	<b>USB board bracket</b> (included in the Bracket Kit)	N38891-001
(7a)	<b>USB board high-power cable</b> (included in the Cable Kit)	N38878-001
(7b)	<b>USB board low-power cable</b> (included in the Cable Kit)	N38878-001
(7c)	<b>Power cable</b>	N38878-001
(8)	<b>System board</b> (includes processor)	
	Intel Pentium Silver N6000 processor, 8 GB of system memory, 64 GB eMMC storage	N38876-001
	Intel Pentium Silver N6000 processor, 4 GB of system memory, 64 GB eMMC storage	N38875-001
	Intel Celeron N5100 processor, 8 GB of system memory, 64 GB eMMC storage	N38870-001
	Intel Celeron N5100 processor, 8 GB of system memory, 32 GB eMMC storage	N38869-001
	Intel Celeron N5100 processor, 4 GB of system memory, 32 GB eMMC storage	N38868-001
	Intel Celeron N4500 processor, 8 GB of system memory, 64 GB eMMC storage	N38874-001
	Intel Celeron N4500 processor, 8 GB of system memory, 32 GB eMMC storage	N38873-001
	Intel Celeron N4500 processor, 4 GB of system memory, 64 GB eMMC storage	N38872-001

**Table 3-1 Computer major component descriptions and part numbers (continued)**

Item	Component	Spare part number
	Intel Celeron N4500 processor, 4 GB of system memory, 32 GB eMMC storage	N38871-001
(9)	<b>Battery</b> (2 cell, 47 Whr)	L75783-005
(10)	<b>Speakers</b> (include left and right speakers)	N38888-001
(11)	<b>Bottom cover</b>	
	Emerald green	N38889-001
	Jet black	N38890-001

## Display assembly subcomponents

To identify the display assembly subcomponents, use this illustration and table.

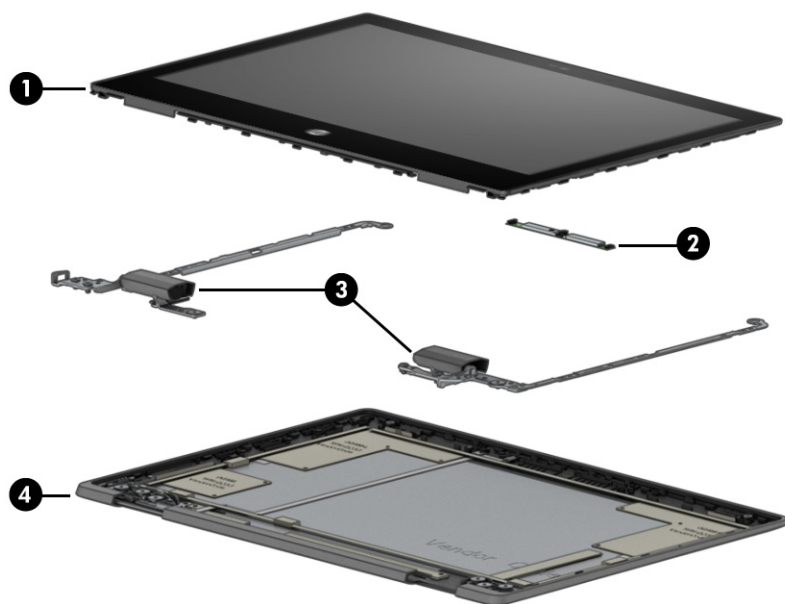

**Table 3-2 Display component descriptions and part numbers**

Item	Component	Spare part number
(1)	<b>Display panel</b>	L92337-001
(2)	<b>Camera module</b> (5 MP)	N38886-001
	<b>NOTE:</b> The camera module cable is available in the Cable Kit as spare part number N38878-001.	
(3)	<b>Hinges</b>	not available as a spare part
(4)	<b>Display back cover</b> (includes wireless antennas)	N08413-001
	Emerald green	N38894-001
	Jet black	N38895-001

**Table 3-2** Display component descriptions and part numbers (continued)

Item	Component	Spare part number
*	Sensor board	N38892-001
*	Wireless antenna cables	N08412-001
*not illustrated		

## Miscellaneous parts

To identify the miscellaneous parts, use this table.

**Table 3-3** Miscellaneous part descriptions and part numbers

Component	Spare part number
<b>AC adapter, 45 W</b> (USB Type-C, nPFC, 3 pin, 1.8 m [6 ft])	L43407-001
<b>USB-C-to-RJ-45 adapter</b>	N22602-001
<b>USB 3.0-to-gigabit RJ-45 adapter</b>	M95984-001
<b>HDMI-to-VGA</b>	N25154-001
<b>USB-C-to-DisplayPort*</b>	N25155-001
<b>HP Universal Multiport USB-C hub</b>	M96882-001
<b>Bracket Kit</b> (includes top left support bracket, right and left long hinge brackets, lock bracket, battery bracket, battery protection bracket, right and left USB-C brackets, touchpad bracket, and WLAN module bracket)	N38891-001
<b>Cable Kit</b> (includes connector board high-speed cable, connector board low-speed cable, keyboard camera cable, display cable, touchpad cable, and camera module cable)	N38878-001
<b>Miscellaneous Kit</b> (includes camera Mylar, LED sponge, and rear camera rubber)	N38896-001
<b>Thermal pad</b>	M76797-001
<b>HP Always On Black 11.6 Case</b>	M16115-001
<b>HP Mobility 11.6 laptop case</b>	M99074-001
<b>HP 128 Laser Wired Mouse</b>	M27885-001
<b>HP 435 Wireless Mouse</b>	M62277-001
<b>HP USB laser mouse</b>	
<b>Screw Kit</b>	N38893-001
<b>Power adapter</b> (C5, AC, conventional, 1.0 m [3.3 ft]) for use in the following countries and regions:	
Argentina	L19357-001
Australia	L19358-001
Brazil	L19359-001
Denmark	L19360-001
Europe (Austria, Belgium, Finland, France, Germany, the Netherlands, Norway, and Sweden)	L19361-001
India	L19363-001

**Table 3-3** Miscellaneous part descriptions and part numbers (continued)

<b>Component</b>	<b>Spare part number</b>
Israel	L19362-001
Israel, HF	M82712-001
Italy	L19364-001
Japan	L19365-001
North America	L19367-001
South Africa	L19369-001
South Korea	L19366-001
North America	L19367-001
Switzerland	L19370-001
Taiwan	L19372-001
United Kingdom	L19373-001
United Kingdom, HF	M82712-001



---

# 4 Removal and replacement procedures preliminary requirements

Use this information to properly prepare to disassemble and reassemble the computer.

## Tools required

You need the following tools to complete the removal and replacement procedures:

- Tweezers
- Nonconductive, nonmarking pry tool
- Magnetic Phillips P1 screwdriver

## Service considerations

The following sections include some of the considerations that you must keep in mind during disassembly and assembly procedures.

---

 **NOTE:** As you remove each subassembly from the computer, place the subassembly (and all accompanying screws) away from the work area to prevent damage.

---

## Plastic parts

Using excessive force during disassembly and reassembly can damage plastic parts.

## Cables and connectors

Handle cables with extreme care to avoid damage.

---

 **IMPORTANT:** When servicing the computer, be sure that cables are placed in their proper locations during the reassembly process. Improper cable placement can damage the computer.

---

Apply only the tension required to unseat or seat the cables during removal and insertion. Handle cables by the connector whenever possible. In all cases, avoid bending, twisting, or tearing cables. Be sure that cables are routed so that they cannot be caught or snagged as you remove or replace parts. Handle flex cables with extreme care; these cables tear easily.

## Drive handling

Note the following guidelines when handling drives.

---

 **IMPORTANT:** Drives are fragile components. Handle them with care. To prevent damage to the computer, damage to a drive, or loss of information, observe these precautions:

- Before removing or inserting a hard drive, shut down the computer. If you are unsure whether the computer is off or in Hibernation, turn the computer on, and then shut it down through the operating system.

- Before handling a drive, be sure that you are discharged of static electricity. While handling a drive, avoid touching the connector.
  - Before removing an optical drive, be sure that a disc is not in the drive, and be sure that the optical drive tray is closed.
  - Handle drives on surfaces covered with at least 2.54 cm (1 inch) of shock-proof foam.
  - Avoid dropping drives from any height onto any surface.
  - After removing a hard drive or an optical drive, place it in a static-proof bag.
  - Avoid exposing an internal hard drive to products that have magnetic fields, such as monitors or speakers.
  - Avoid exposing a drive to temperature extremes or liquids.
  - If a drive must be mailed, place the drive in a bubble pack mailer or other suitable form of protective packaging, and label the package "FRAGILE."
- 

## Electrostatic discharge information

A sudden discharge of static electricity from your finger or other conductor can destroy static-sensitive devices or microcircuitry. Often the spark is neither felt nor heard, but damage occurs. An electronic device exposed to electrostatic discharge (ESD) might not appear to be affected at all and can work perfectly throughout a normal cycle. The device might function normally for a while, but it has been degraded in the internal layers, reducing its life expectancy.

Networks built into many integrated circuits provide some protection, but in many cases, the discharge contains enough power to alter device parameters or melt silicon junctions.

---

 **IMPORTANT:** To prevent damage to the device when you remove or install internal components, observe these precautions:

- Keep components in their electrostatic-safe containers until you are ready to install them.
  - Before touching an electronic component, discharge static electricity by using the guidelines described in [Personal grounding methods and equipment on page 18](#).
  - Avoid touching pins, leads, and circuitry. Handle electronic components as little as possible.
  - If you remove a component, place it in an electrostatic-safe container.
- 

## Generating static electricity

Follow these static electricity guidelines:

- Different activities generate different amounts of static electricity.
- Static electricity increases as humidity decreases.

**Table 4-1 Static electricity occurrence based on activity and humidity**

Event	Relative humidity		
	55%	40%	10%
Walking across carpet	7,500 V	15,000 V	35,000 V
Walking across vinyl floor	3,000 V	5,000 V	12,000 V
Motions of bench worker	400 V	800 V	6,000 V
Removing dual in-line packages (DIPs) from plastic tube	400 V	700 V	2,000 V
Removing DIPs from vinyl tray	2,000 V	4,000 V	11,500 V
Removing DIPs from polystyrene foam	3,500 V	5,000 V	14,500 V
Removing bubble pack from PCB (printed circuit board)	7,000 V	20,000 V	26,500 V
Packing PCBs in foam-lined box	5,000 V	11,000 V	21,000 V
Multiple electric components can be packaged together in plastic tubes, trays, or polystyrene foam.			



**NOTE:** As little as 700 V of static electricity can degrade a product.

## Preventing electrostatic damage to equipment

Many electronic components are sensitive to ESD. Circuitry design and structure determine the degree of sensitivity.

The following packaging and grounding precautions are necessary to prevent static electricity damage to electronic components:

- To avoid hand contact, transport products in static-safe containers such as tubes, bags, or boxes.
- Protect all electrostatic parts and assemblies with conductive or approved containers or packaging.
- Keep electrostatic-sensitive parts in their containers until they arrive at static-free stations.
- Place items on a grounded surface before removing them from their container.
- Always be properly grounded when touching a sensitive component or assembly.
- Avoid contact with pins, leads, or circuitry.
- Place reusable electrostatic-sensitive parts from assemblies in protective packaging or conductive foam.

## Personal grounding methods and equipment

Using certain equipment can prevent static electricity damage to electronic components.

- **Wrist straps** are flexible straps with a maximum of 1 M $\Omega$   $\pm$ 10% resistance in the ground cords. To provide proper ground, a strap must be worn snug against bare skin. The ground cord must be connected and fit snugly into the banana plug connector on the grounding mat or workstation.
- You can use **heel straps, toe straps, and boot straps** at standing workstations. These straps are compatible with most types of shoes or boots. On conductive floors or dissipative floor mats, use them on both feet with a maximum of 1 M $\Omega$   $\pm$ 10% resistance between the operator and ground.

**Table 4-2 Static shielding protection levels**

Static shielding protection levels	
Method	Voltage
Antistatic plastic	1,500
Carbon-loaded plastic	7,500
Metallized laminate	15,000

## Grounding the work area

To prevent static damage at the work area, follow these precautions:

- Cover the work surface with approved static-dissipative material.
- Use a wrist strap connected to a properly grounded work surface and use properly grounded tools and equipment.
- Use static-dissipative mats, foot straps, or air ionizers to give added protection.
- Handle electrostatic sensitive components, parts, and assemblies by the case or PCB laminate. Handle them only at static-free work areas.
- Turn off power and input signals before inserting and removing connectors or test equipment.
- Use fixtures made of static-safe materials when fixtures must directly contact dissipative surfaces.
- Keep the work area free of nonconductive materials, such as ordinary plastic assembly aids and polystyrene foam.
- Use conductive field service tools, such as cutters, screwdrivers, and vacuums.
- Avoid contact with pins, leads, or circuitry.

## Recommended materials and equipment

HP recommends certain materials and equipment to prevent static electricity:

- Antistatic tape
- Antistatic smocks, aprons, or sleeve protectors
- Conductive bins and other assembly or soldering aids
- Conductive foam
- Conductive tabletop workstations with ground cord of  $1\text{ M}\Omega \pm 10\%$  resistance
- Static-dissipative table or floor mats with hard tie to ground
- Field service kits
- Static awareness labels
- Wrist straps and footwear straps providing  $1\text{ M}\Omega \pm 10\%$  resistance
- Material handling packages

- Conductive plastic bags
- Conductive plastic tubes
- Conductive tote boxes
- Opaque shielding bags
- Transparent metallized shielding bags
- Transparent shielding tubes

## Cleaning your computer

Cleaning your computer regularly removes dirt and debris so that your device continues to operate at its best. Use the following information to safely clean the external surfaces of your computer.

### Enabling HP Easy Clean (select products only)

HP Easy Clean helps you to avoid accidental input while you clean the computer surfaces. This software disables devices such as the keyboard, touch screen, and touchpad for a preset amount of time so that you can clean all computer surfaces.

1. Start HP Easy Clean in one of the following ways:
  - Select the **Start** menu, and then select **HP Easy Clean**.
  - or -
  - Select the **HP Easy Clean** icon in the taskbar.
  - or -
  - Select **Start**, and then select the **HP Easy Clean** tile.
2. Now that your device is disabled for a short period, see [Removing dirt and debris from your computer on page 20](#) for the recommended steps to clean the high-touch, external surfaces on your computer. After you remove the dirt and debris, you can also clean the surfaces with a disinfectant. See [Cleaning your computer with a disinfectant on page 21](#) for guidelines to help prevent the spread of harmful bacteria and viruses.

### Removing dirt and debris from your computer

Here are the recommended steps to clean dirt and debris from your computer.

For computers with wood veneer, see [Caring for wood veneer \(select products only\) on page 22](#).

1. Wear disposable gloves made of latex (or nitrile gloves, if you are latex-sensitive) when cleaning the surfaces.
2. Turn off your device and unplug the power cord and other connected external devices. Remove any installed batteries from items such as wireless keyboards.

---

**⚠ CAUTION:** To prevent electric shock or damage to components, never clean a product while it is turned on or plugged in.

---

3. Moisten a microfiber cloth with water. The cloth should be moist, but not dripping wet.

---

 **IMPORTANT:** To avoid damaging the surface, avoid abrasive cloths, towels, and paper towels.

---

4. Wipe the exterior of the product gently with the moistened cloth.

---

 **IMPORTANT:** Keep liquids away from the product. Avoid getting moisture in any openings. If liquid makes its way inside your HP product, it can cause damage to the product. Do not spray liquids directly on the product. Do not use aerosol sprays, solvents, abrasives, or cleaners containing hydrogen peroxide or bleach that might damage the finish.

---

5. Start with the display (if applicable). Wipe carefully in one direction, and move from the top of the display to the bottom. Finish with any flexible cables, like power cord, keyboard cable, and USB cables.
6. Be sure that surfaces have completely air-dried before turning the device on after cleaning.
7. Discard the gloves after each cleaning. Clean your hands immediately after you remove the gloves.

See [Cleaning your computer with a disinfectant on page 21](#) for recommended steps to clean the high-touch, external surfaces on your computer to help prevent the spread of harmful bacteria and viruses.

## Cleaning your computer with a disinfectant

The World Health Organization (WHO) recommends cleaning surfaces, followed by disinfection, as a best practice for preventing the spread of viral respiratory illnesses and harmful bacteria.

After cleaning the external surfaces of your computer using the steps in [Removing dirt and debris from your computer on page 20](#), [Caring for wood veneer \(select products only\) on page 22](#), or both, you might also choose to clean the surfaces with a disinfectant. A disinfectant that is within HP's cleaning guidelines is an alcohol solution consisting of 70% isopropyl alcohol and 30% water. This solution is also known as rubbing alcohol and is sold in most stores.

Follow these steps when disinfecting high-touch, external surfaces on your computer:

1. Wear disposable gloves made of latex (or nitrile gloves, if you are latex-sensitive) when cleaning the surfaces.
2. Turn off your device and unplug the power cord and other connected external devices. Remove any installed batteries from items such as wireless keyboards.

---

 **CAUTION:** To prevent electric shock or damage to components, never clean a product while it is turned on or plugged in.

---

3. Moisten a microfiber cloth with a mixture of 70% isopropyl alcohol and 30% water. The cloth should be moist, but not dripping wet.

---

 **CAUTION:** Do not use any of the following chemicals or any solutions that contain them, including spray-based surface cleaners: bleach, peroxides (including hydrogen peroxide), acetone, ammonia, ethyl alcohol, methylene chloride, or any petroleum-based materials, such as gasoline, paint thinner, benzene, or toluene.

---

 **IMPORTANT:** To avoid damaging the surface, avoid abrasive cloths, towels, and paper towels.

---

4. Wipe the exterior of the product gently with the moistened cloth.



---

**IMPORTANT:** Keep liquids away from the product. Avoid getting moisture in any openings. If liquid makes its way inside your HP product, it can cause damage to the product. Do not spray liquids directly on the product. Do not use aerosol sprays, solvents, abrasives, or cleaners containing hydrogen peroxide or bleach that might damage the finish.

---

5. Start with the display (if applicable). Wipe carefully in one direction, and move from the top of the display to the bottom. Finish with any flexible cables, like power cord, keyboard cable, and USB cables.
6. Be sure that surfaces have completely air-dried before turning the device on after cleaning.
7. Discard the gloves after each cleaning. Clean your hands immediately after you remove the gloves.

## Caring for wood veneer (select products only)

Your product might feature high-quality wood veneer. As with all natural wood products, proper care is important for best results over the life of the product. Because of the nature of natural wood, you might see unique variations in the grain pattern or subtle variations in color, which are normal.

- Clean the wood with a dry, static-free microfiber cloth or chamois.
- Avoid cleaning products containing substances such as ammonia, methylene chloride, acetone, turpentine, or other petroleum-based solvents.
- Do not expose the wood to sun or moisture for long periods of time.
- If the wood becomes wet, dry it by dabbing with an absorbent, lint-free cloth.
- Avoid contact with any substance that might dye or discolor the wood.
- Avoid contact with sharp objects or rough surfaces that might scratch the wood.

See [Removing dirt and debris from your computer on page 20](#) for the recommended steps to clean the high-touch, external surfaces on your computer. After you remove the dirt and debris, you can also clean the surfaces with a disinfectant. See [Cleaning your computer with a disinfectant on page 21](#) for sanitizing guidelines to help prevent the spread of harmful bacteria and viruses.

## Packaging and transporting guidelines

Follow these grounding guidelines when packaging and transporting equipment:

- To avoid hand contact, transport products in static-safe tubes, bags, or boxes.
- Protect ESD-sensitive parts and assemblies with conductive or approved containers or packaging.
- Keep ESD-sensitive parts in their containers until the parts arrive at static-free workstations.
- Place items on a grounded surface before removing items from their containers.
- Always be properly grounded when touching a component or assembly.
- Store reusable ESD-sensitive parts from assemblies in protective packaging or nonconductive foam.

- Use transporters and conveyors made of antistatic belts and roller bushings. Be sure that mechanized equipment used for moving materials is wired to ground and that proper materials are selected to avoid static charging. When grounding is not possible, use an ionizer to dissipate electric charges.

## Accessing support information

To find the HP support that you need, use this information.

**Table 4-3 Support information locations**

Service consideration	Path to access information
Records of reported failure incidents stored on the computer	<p><b>Windows®:</b></p> <p>Preoperating system failures are logged in the BIOS Event Log. To view the BIOS Event Log:</p> <ol style="list-style-type: none"> <li>1. Press the power button.</li> <li>2. Immediately and repeatedly press <b>esc</b> when the power button light turns white.</li> </ol> <p><b>NOTE:</b> If you do not press <b>esc</b> at the appropriate time, you must restart the computer and again repeatedly press <b>esc</b> when the power button light turns white to access the utility.</p> <ol style="list-style-type: none"> <li>3. Press <b>f10</b> to enter the BIOS setup.</li> <li>4. (On commercial products) Under the <b>Main</b> tab, select <b>BIOS event log</b>, and then select <b>View BIOS Event Log</b>.</li> </ol> <p>- or -</p> <p>(On consumer products) Under the <b>Main</b> tab, select <b>System Log</b>.</p> <p>Post-operating system failures are logged in the Event Viewer.</p> <ol style="list-style-type: none"> <li>1. Turn on the computer and allow the operating system to open.</li> <li>2. Select the search icon  in the taskbar.</li> <li>3. Type <code>Event Viewer</code>, and then press <b>enter</b>.</li> <li>4. Select the log from the left panel. Details display in the right panel.</li> </ol> <p><b>Chrome™:</b></p> <ol style="list-style-type: none"> <li>1. Go to <a href="https://support.google.com/chrome">support.google.com/chrome</a>.</li> <li>2. Search <code>collect Chrome device logs</code>.</li> </ol>
Technical bulletins	<p>To locate technical bulletins:</p> <ol style="list-style-type: none"> <li>1. Go to <a href="https://www.hp.com">www.hp.com</a>.</li> <li>2. Place the cursor over <b>Problem solving</b> to display more options.</li> <li>3. Select <b>Support &amp; Troubleshooting</b>.</li> <li>4. Type the serial number, product number, or product name to go to the product support page.</li> <li>5. Select <b>Advisories</b> to view technical bulletins.</li> </ol>





**Table 4-3** Support information locations (continued)

Service consideration	Path to access information
Repair professionals	To locate repair professionals: <ol style="list-style-type: none"><li data-bbox="679 306 906 333">1. Go to <a href="http://www.hp.com">www.hp.com</a>.</li><li data-bbox="679 359 1337 386">2. Place the cursor over <b>Support resources</b> to display more options.</li><li data-bbox="679 411 1066 438">3. Select <b>Authorized service providers</b>.</li></ol>
Component and diagnosis information, failure detection, and required action	To locate diagnosis information and actions: <ol style="list-style-type: none"><li data-bbox="679 506 1177 533">1. Go to <a href="http://www.hp.com/go/techcenter/pcdiags">http://www.hp.com/go/techcenter/pcdiags</a>.</li><li data-bbox="679 558 911 585">2. Select <b>Get Support</b>.</li><li data-bbox="679 611 1422 653">3. Near the bottom of the window, select <b>Notebook PCs</b>, and then select your location.</li></ol>

# 5 Removal and replacement procedures for authorized service provider parts

This chapter provides removal and replacement procedures for authorized service provider parts.

 **IMPORTANT:** Only an authorized service provider should access the components described in this chapter. Accessing these parts can damage the computer or void the warranty.

 **NOTE:** Details about your computer, including model, serial number, product key, and length of warranty, are on the service tag at the bottom of your computer.

## Component replacement procedures

To remove and replace computer components, use the procedures described in this section.

 **NOTE:** HP continually improves and changes product parts. For complete and current information about supported parts for your computer, go to <http://partsurfer.hp.com>, select your country or region, and then follow the on-screen instructions.

Make special note of each screw size and location during removal and replacement.

## Preparation for disassembly

To remove and replace computer components, use these procedures:

For initial safety procedures, see [Removal and replacement procedures preliminary requirements on page 16](#).

1. Turn off the computer. If you are unsure whether the computer is off or in Hibernation, turn the computer on, and then shut it down through the operating system.
2. Disconnect the power from the computer by unplugging the power cord from the computer.
3. Disconnect all external devices from the computer.

## Top cover with keyboard

To remove the top cover with keyboard, use this procedure and illustration. The first table provides the main spare part number for the top cover with keyboards. The second table provides the keyboard country codes.

**Table 5-1 Top cover with keyboard description and part number**

Description	Spare part number
Bottom cover with keyboard, emerald green models	N38889-001
Bottom cover with keyboard, jet black models	N38890-001
Top cover with keyboard, emerald green models with one camera	N38879-001
Top cover with keyboard, jet black models with one camera	N38880-001

**Table 5-1 Top cover with keyboard description and part number (continued)**

Description	Spare part number
Top cover with keyboard, emerald green models with two cameras	N38881-001
Top cover with keyboard, jet black models with two cameras	N38882-001

**Table 5-2 Spare part country codes**

For use in country or region	Spare part number	For use in country or region	Spare part number	For use in country or region	Spare part number
Belgium	-A41	Iceland	-DD1	Slovenia	-BA1
Brazil	-201	India	-D61	South Korea	-AD1
Bulgaria	-261	Israel	-BB1	Spain	-071
Chile	-161	Italy	-061	Switzerland	-BG1
Czech Republic/Slovakia	-FL1	Japan	-291	Taiwan	-AB1
Denmark, Finland, and Norway	-DH1	The Netherlands	-B31	Thailand	-281
French Canada	-DB1	Northern Africa	-FP1	Turkey	-141
France	-051	Portugal	-131	Ukraine	-BD1
Germany	-041	Romania	-271	United Kingdom	-031
Greece	-151	Russia	-251	United States	-001
Hungary	-211	Saudi Arabia	-171		

Before removing the top cover with keyboard, prepare the computer for disassembly (see [Preparation for disassembly on page 25](#)).

Remove the bottom cover:

1. Remove or loosen the following screws that secure the keyboard/top cover to the bottom cover:
  - (1) Two Phillips M2.0 × 5.7 screws
  - (2) Two Phillips M2.0 × 5.7 captive screws
  - (3) Two Phillips M2.5 × 8.7 screws

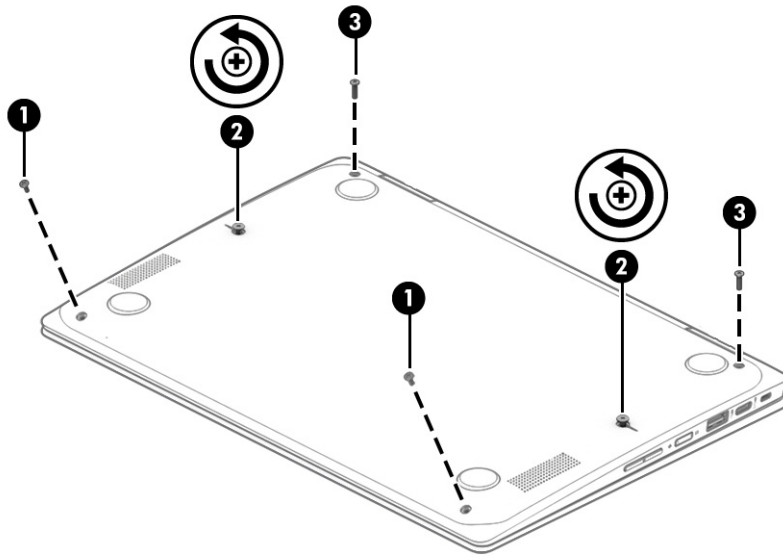

2. Position the computer upright.
3. Starting at the bottom right corner, use a tool (1) to release the cover from the computer
4. Run the tool along the bottom, left, and right edges (2) to release the cover.

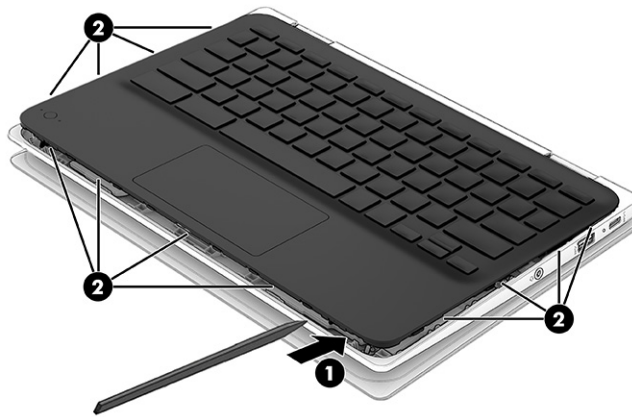

5. Lift the front edge of the keyboard/top cover (1) as far as the keyboard cable and touchpad cable allow.
6. Release the zero insertion force (ZIF) connector (2) the touchpad board cable is connected to, and then disconnect the touchpad cable from the system board.
7. Release the shielding (3) that covers the keyboard cable ZIF connector.
8. Release the ZIF connector (4) the keyboard cable is connected to, and then disconnect the keyboard cable from the system board.
9. Release the ZIF connector (5) the keyboard camera cable is connected to, and then disconnect the keyboard camera cable from the system board.

10. Remove the top cover (6).

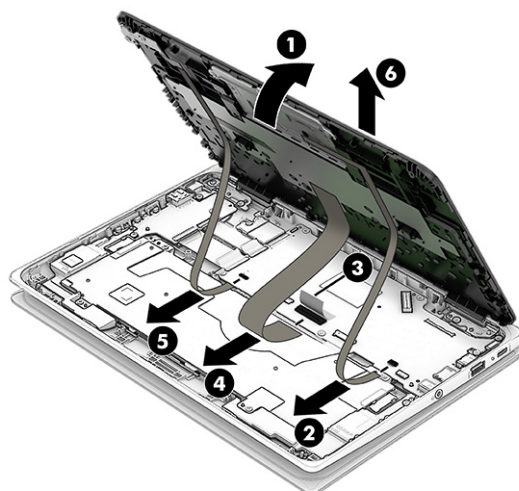

To replace the top cover with keyboard, reverse the removal procedures.

## Touchpad cable

To remove the touchpad cable, use this procedure and illustration.

**Table 5-3 Touchpad cable descriptions and part numbers**

Description	Spare part number
Touchpad cable (available in the Cable Kit)	N38878-001

Before removing the touchpad cable, follow these steps:

1. Prepare the computer for disassembly (see [Preparation for disassembly on page 25](#)).
2. Remove the top cover with keyboard (see [Top cover with keyboard on page 25](#)).

Remove the touchpad cable:

1. Turn the keyboard/top cover upside down with the front toward you.
2. Detach the touchpad cable (1) from the keyboard/top cover. (The touchpad cable is attached to the keyboard/top cover with double-sided adhesive.)
3. Release the ZIF connector (2) the touchpad cable is connected to, and then disconnect the touchpad cable from the touchpad.

4. Remove the touchpad cable **(3)**.

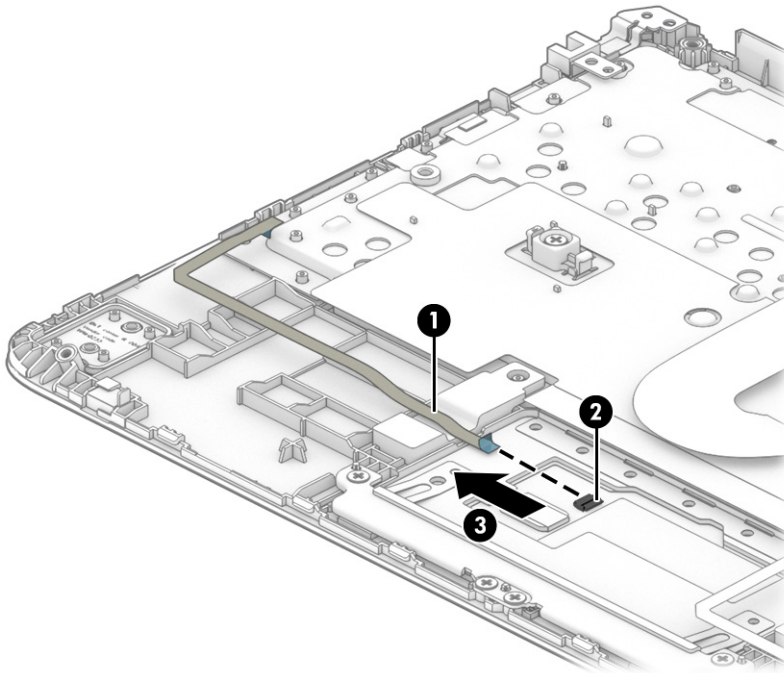

To install the touchpad cable, reverse the removal procedures.

## Touchpad

To remove the touchpad, use this procedure and illustration.

**Table 5-4 Touchpad description and part number**

Description	Spare part number
Touchpad, emerald green models	N38883-001
Touchpad, jet black models	N38884-001
Touch bracket (available in the Bracket Kit)	N38891-001
Touch bracket rubber	N38885-001

Before removing the touchpad, follow these steps:

1. Prepare the computer for disassembly (see [Preparation for disassembly on page 25](#)).
2. Remove the top cover with keyboard (see [Top cover with keyboard on page 25](#)).

Remove the touchpad:

1. Turn the keyboard/top cover upside down with the front toward you.
2. Detach the touchpad cable **(1)** from the keyboard/top cover. (The touchpad cable is attached to the keyboard/top cover with double-sided adhesive.)
3. Release the shielding **(2)** that covers the touchpad screws.

4. Remove the three Phillips M2.0 × 2.2 broad head screws (3) that secure the touchpad to the keyboard/top cover.
5. Remove the four Phillips M2.0 × 2.9 screws (4) that secure the touchpad and touchpad bracket to the keyboard/top cover.
6. Remove the touchpad bracket (5).
7. Remove the touchpad (6) and cable.

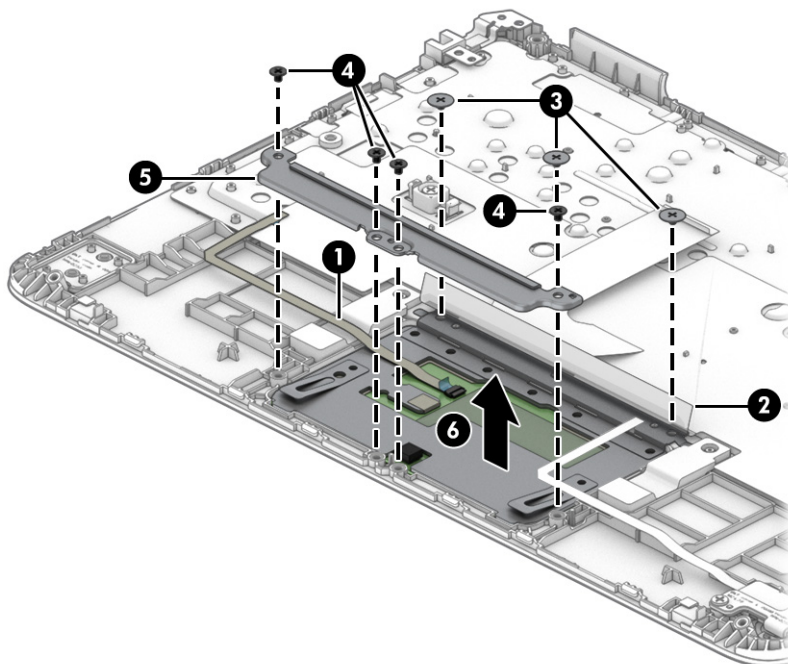

To install the touchpad, reverse this procedure.

## Keyboard camera

To remove the Keyboard camera, use this procedure and illustration.

**Table 5-5 Keyboard camera description and part number**

Description	Spare part number
Keyboard camera	N38887-001
Keyboard camera bracket	N38891-001

Before removing the keyboard camera, follow these steps:

1. Prepare the computer for disassembly (see [Preparation for disassembly on page 25](#)).
2. Remove the top cover with keyboard (see [Top cover with keyboard on page 25](#)).

Remove the keyboard camera:

1. Turn the keyboard/top cover upside down with the front toward you.

2. Detach the keyboard camera cable (1) from the top cover. (The keyboard camera cable is attached to the keyboard/top cover with double-sided adhesive.)
3. Remove the two Phillips M2.0 × 4.1 screws (2) that secure the keyboard camera and keyboard camera bracket to the top cover.
4. Remove the keyboard camera bracket (3).
5. Remove the keyboard camera (4) and cable.



**NOTE:** The cable connects to the bottom of the camera. You can only replace the cable after removing the camera.

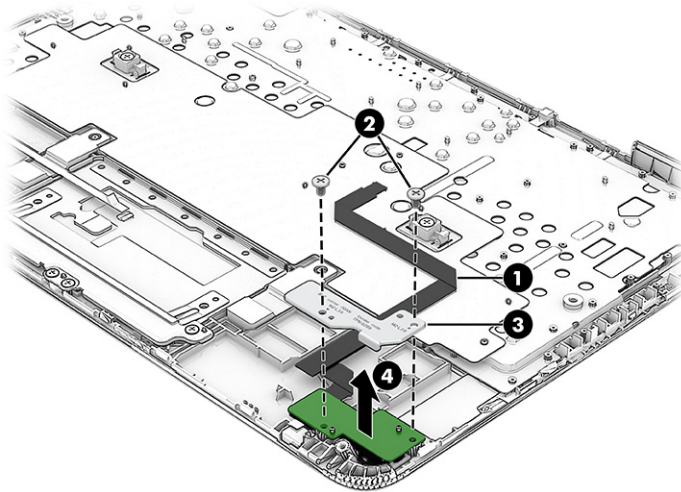

To replace the keyboard camera, reverse the removal procedures.

## Keyboard camera cable

To remove the keyboard camera cable, use this procedure and illustration.

**Table 5-6 Keyboard camera cable description and part number**

Description	Spare part number
Keyboard camera cable reader	N08418-001

Before removing the keyboard camera cable board, follow these steps:

1. Prepare the computer for disassembly (see [Preparation for disassembly on page 25](#)).
2. Remove the top cover with keyboard (see [Top cover with keyboard on page 25](#)).
3. Remove the keyboard camera (see [Keyboard camera on page 30](#)).

Remove the keyboard camera cable:

1. Turn the keyboard camera upside down with the rear toward you.
2. Release the ZIF connector (1) the keyboard camera cable is connected to, and then disconnect the keyboard camera cable from the keyboard camera.



3. Remove the keyboard camera cable (2).

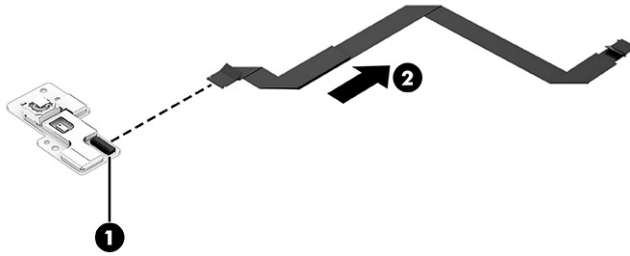

To install the keyboard camera cable, reverse this procedure.

## Speakers

To remove the speakers, use this procedure and illustration.

**Table 5-7** Speaker description and part number

Description	Spare part number
Speaker Kit	N38888-001

Before removing the speakers, follow these steps:

1. Prepare the computer for disassembly (see [Preparation for disassembly on page 25](#)).
2. Remove the top cover with keyboard (see [Top cover with keyboard on page 25](#)).

Remove the speakers:

1. Release the shielding (1) that covers the battery cable and connector.

2. Disconnect the battery cable (2) from the system board.

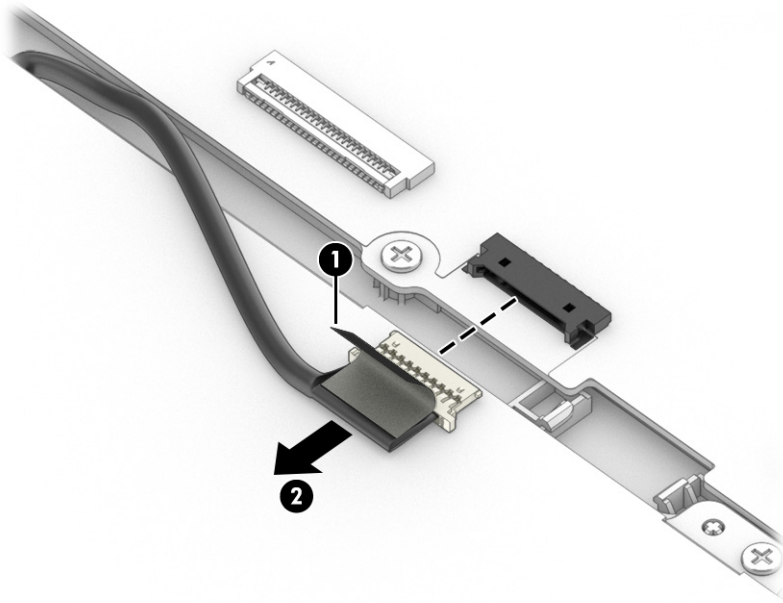

3. Disconnect the speaker cable (1) from the system board.
4. Remove the two Phillips M2.0 × 4.2 screws (2) that secure the speakers to the bottom cover.
5. Remove the speakers (3).

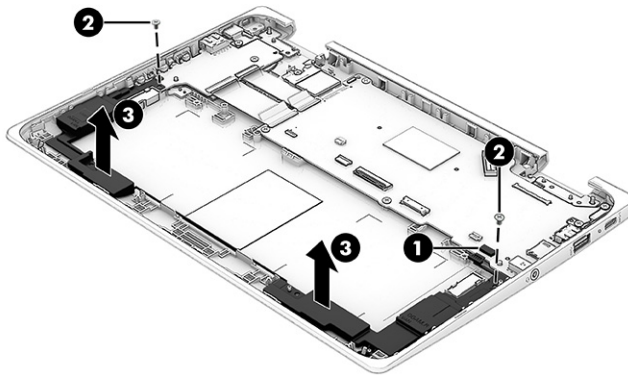

To install the speakers, reverse this procedure.

## Battery

To remove the battery, use this procedure and illustration.

**Table 5-8 Battery description and part number**

Description	Spare part number
2 cell, 47 Whr battery	L75783-005

**⚠ WARNING!** To avoid personal injury and damage to the product:

- Do *not* puncture, twist, or crack the battery.
- Do *not* cause an external puncture or rupture to the battery. Punctures can cause a short inside the battery, which can result in battery thermal runaway.
- Do *not* handle or touch the battery enclosure with sharp objects such as tweezers or pliers, which might puncture the battery.
- Do *not* compress or squeeze the battery case with tools or heavy objects stacked on top of the case. These actions can apply undue force to the battery.
- Do *not* touch the connectors with any metallic surface or object, such as metal tools, screws, or coins, which can cause shorting across the connectors.

Before removing the battery, follow these steps:

1. Prepare the computer for disassembly (see [Preparation for disassembly on page 25](#)).
2. Remove the top cover with keyboard (see [Top cover with keyboard on page 25](#)).
3. Remove the speakers (see [Speakers on page 32](#)).

**⚠ WARNING!** To reduce potential safety issues, use only the user-replaceable battery provided with the computer, a replacement battery provided by HP, or a compatible battery purchased from HP.

**📄 IMPORTANT:** Removing a battery that is the sole power source for the computer can cause loss of information. To prevent loss of information, save your work or shut down the computer through Windows before you remove the battery.

Remove the battery:

1. Remove the four Phillips M2.0 × 4.0 screws (1) that secure the battery bracket, and then remove the bracket (2).

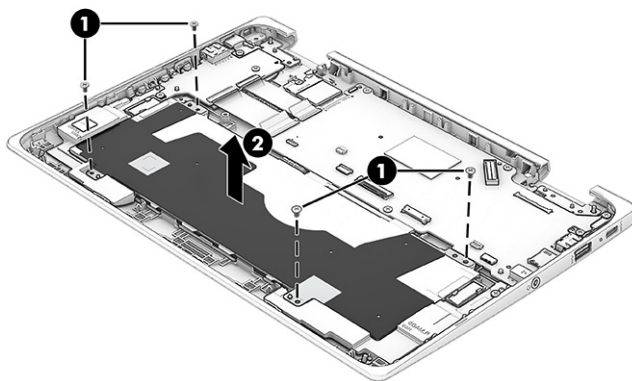

2. Remove the battery from the computer.

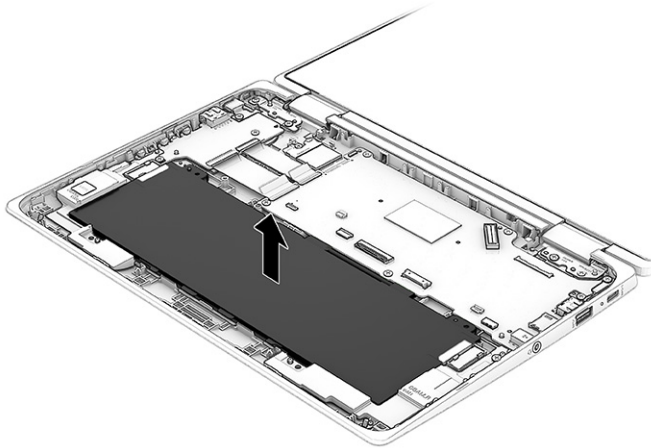

To replace the battery, reverse the removal procedures.

## WLAN module

To remove the WLAN module, use this procedure and illustration.

**Table 5-9** WLAN module descriptions and part numbers

Description	Spare part number
WLAN module (Intel Wi-Fi 6 AX211 + Bluetooth 5.2)	L92724-005
WLAN bracket (included in the Bracket Kit)	N38891-001

 **IMPORTANT:** To prevent an unresponsive system, replace the wireless module only with a wireless module authorized for use in the computer by the governmental agency that regulates wireless devices in your country or region. If you replace the module and then receive a warning message, remove the module to restore device functionality, and then contact technical support.

Before removing the WLAN module, follow these steps:

1. Prepare the computer for disassembly (see [Preparation for disassembly on page 25](#)).
2. Remove the top cover with keyboard (see [Top cover with keyboard on page 25](#)).
3. Disconnect the battery cable from the system board (see [Battery on page 33](#)).

Remove the WLAN module:

1. Remove the Phillips M2.0 × 2.9 screw **(1)** that secures the WLAN module to the system board. (The WLAN module tilts up.)
2. Remove the WLAN bracket **(2)**.
3. Disconnect the two WLAN antenna cables **(3)** from the terminals on the WLAN module.
4. Release the shielding **(4)** that secures the WLAN module to the slot.

5. Remove the WLAN module (5) by pulling the module away from the slot at an angle.

 **NOTE:** When connecting the antenna cables, be sure to match the number or letter on the cable with the appropriate connector on the module.

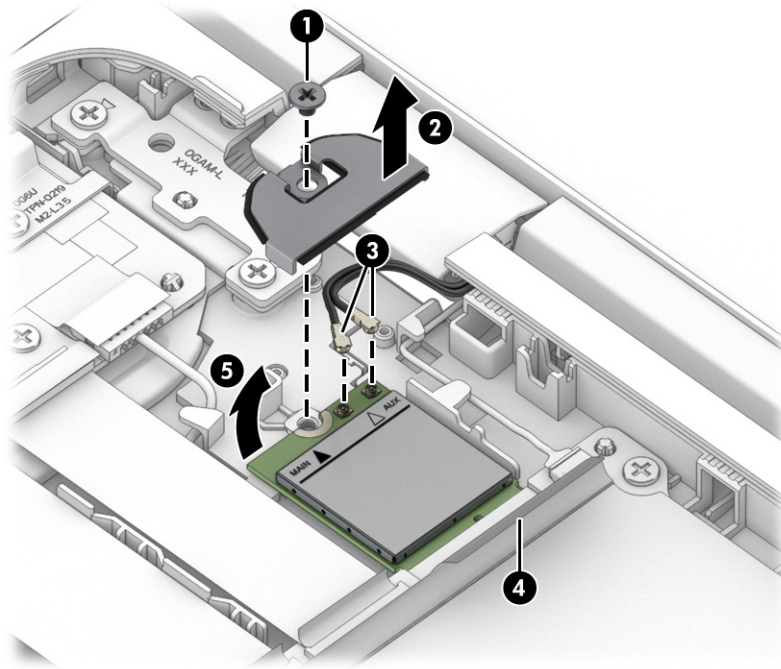

6. If the WLAN antenna is not connected to the terminal on the WLAN module, you must install a protective sleeve on the antenna connector, as shown in the following illustration.

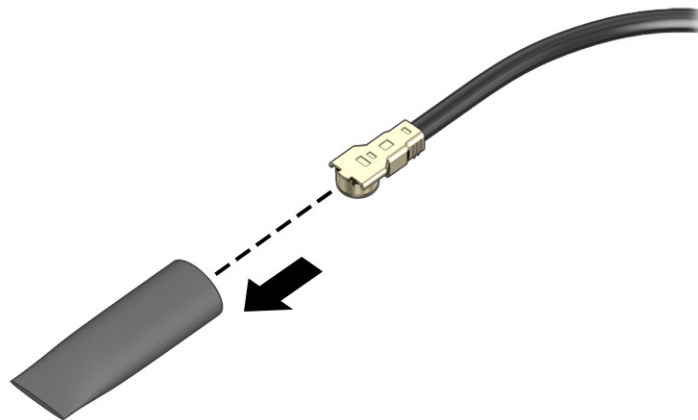

To install the WLAN module, reverse this procedure.

## USB board cables

To remove the USB board cables, use these procedures and illustrations.

**Table 5-10** USB board cables descriptions and part numbers

Description	Spare part number
USB board cables	N38878-001

Before removing the USB board cables, follow these steps:

1. Prepare the computer for disassembly (see [Preparation for disassembly on page 25](#)).
2. Remove the top cover with keyboard (see [Top cover with keyboard on page 25](#)).
3. Disconnect the battery cable from the system board (see [Battery on page 33](#)).

Remove the USB board cables:

1. Release the shielding (1) that covers the USB board cable ZIF connectors.
2. Release the two ZIF connectors (2) the USB board cables are connected to, and then disconnect the USB board cables from the system board.
3. Release the two ZIF connectors (3) the USB board cables are connected to, and then disconnect the USB board cables from the USB board.
4. Remove the two USB board cables (4). The cables are secured with adhesive.

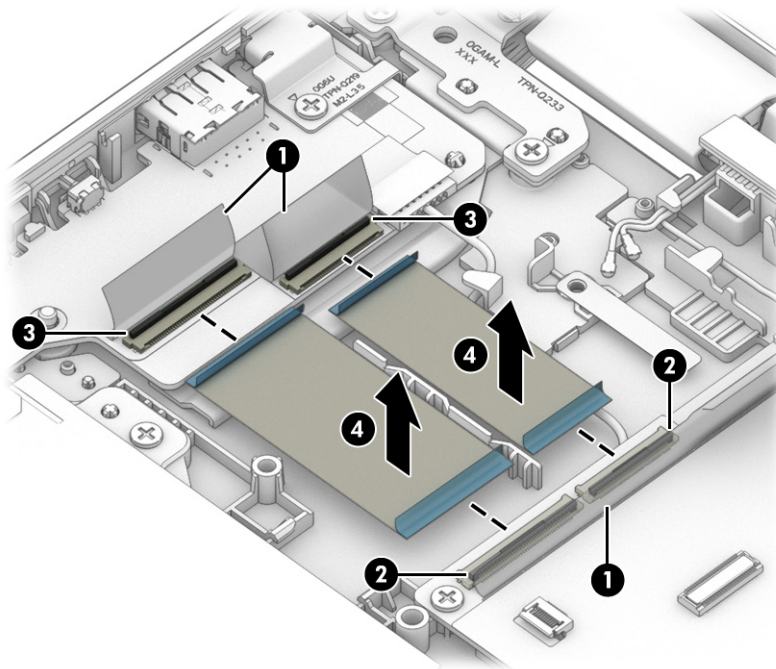

To install the USB board cables, reverse this procedure.

## USB board

To remove the USB board, use these procedures and illustrations.

**Table 5-11 USB board description and part number**

Description	Spare part number
USB board	N38877-001
USB board bracket	N38891-001

Before removing the USB board, follow these steps:

1. Prepare the computer for disassembly (see [Preparation for disassembly on page 25](#)).
2. Remove the top cover with keyboard (see [Top cover with keyboard on page 25](#)).
3. Disconnect the battery cable from the system board (see [Battery on page 33](#)).

Remove the USB board:

1. Release the shielding (1) that covers the USB board cable ZIF connectors on the system board.
2. Release the two ZIF connectors (2) the USB board cables are connected to, and then disconnect the USB board cables from the system board.
3. Remove Phillips M2.0 × 4.2 screw that secures the USB board bracket (3) to the bottom cover.
4. Remove the USB board bracket (4).
5. Remove the USB board (5) and cables.

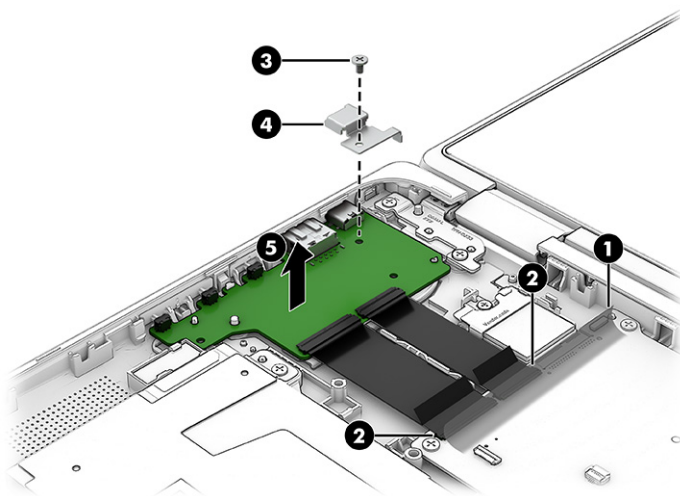

To install the USB board, reverse this procedure.

## System board

To remove the system board, use these procedures and illustrations.

**Table 5-12 System board descriptions and part numbers**

Description	Spare part number
<b>System board</b> (includes processor)	



**Table 5-12 System board descriptions and part numbers (continued)**

Description	Spare part number
Intel Pentium Silver N6000 processor, 8 GB of system memory, 64 GB eMMC storage	N38876-001
Intel Pentium Silver N6000 processor, 4 GB of system memory, 64 GB eMMC storage	N38875-001
Intel Celeron N5100 processor, 8 GB of system memory, 64 GB eMMC storage	N38870-001
Intel Celeron N5100 processor, 8 GB of system memory, 32 GB eMMC storage	N38869-001
Intel Celeron N5100 processor, 4 GB of system memory, 32 GB eMMC storage	N38868-001
Intel Celeron N4500 processor, 8 GB of system memory, 64 GB eMMC storage	N38874-001
Intel Celeron N4500 processor, 8 GB of system memory, 32 GB eMMC storage	N38873-001
Intel Celeron N4500 processor, 4 GB of system memory, 64 GB eMMC storage	N38872-001
Intel Celeron N4500 processor, 4 GB of system memory, 32 GB eMMC storage	N38871-001

Before removing the system board, follow these steps:

1. Prepare the computer for disassembly (see [Preparation for disassembly on page 25](#)).
2. Remove the top cover with keyboard (see [Top cover with keyboard on page 25](#)).
3. Disconnect the battery cable from the system board (see [Battery on page 33](#)).
4. Remove the WLAN module (see [WLAN module on page 35](#)).

Remove the system board:

1. Release the shielding **(1)** that covers the webcam module cable connector.
2. Disconnect the webcam module cable **(2)** from the system board.
3. Release the shielding **(3)** that covers the display panel cable connector.
4. Disconnect the display panel cable **(4)** from the system board.
5. Disconnect the speaker cable **(5)** from the system board.
6. Release the shielding **(6)** that covers the connector board cable ZIF connectors on the system board.



7. Release the two ZIF connectors (7) the connector board cables are connected to, and then disconnect the connector board cables from the system board.

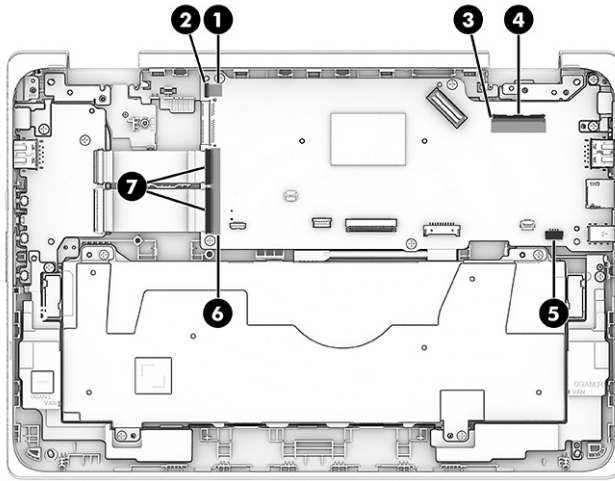

8. Remove the six Phillips M2.0 × 4.2 screws (1) that secure the system board to the bottom cover, and then remove the USB bracket (2).

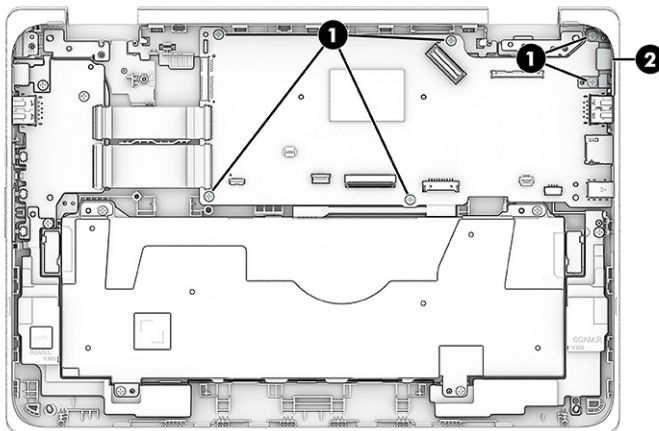

9. Lift the left side the system board (1) until it rests at an angle.

10. Remove the system board (2) by sliding it up and to the left at an angle.

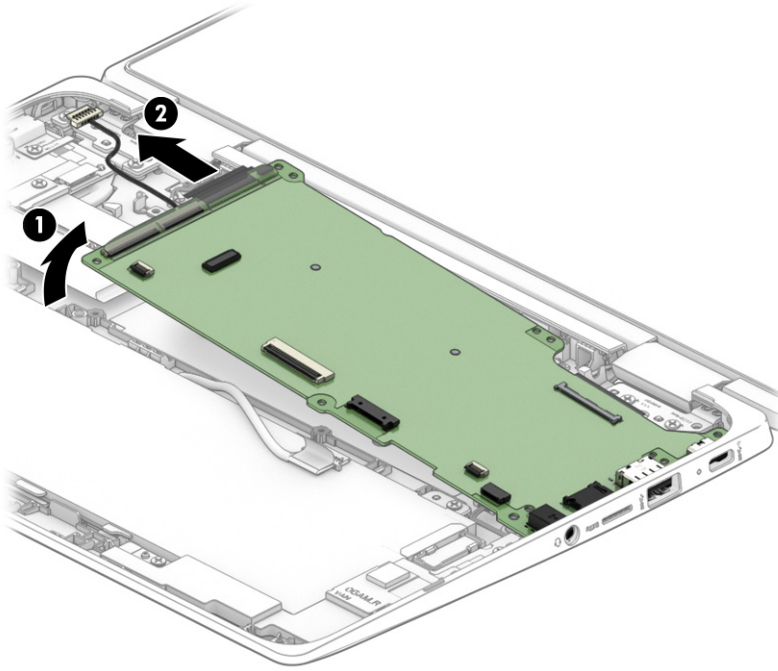

To install the system board, reverse this procedure.

## Lock bracket

To remove the lock bracket, use this procedure and illustration.

**Table 5-13** Lock bracket description and part number

Description	Spare part number
Bracket Kit	N38891-001

Before removing the lock bracket, follow these steps:

1. Prepare the computer for disassembly (see [Preparation for disassembly on page 25](#)).
2. Remove the top cover with keyboard (see [Top cover with keyboard on page 25](#)).
3. Disconnect the battery cable from the system board (see [Battery on page 33](#)).
4. Remove the WLAN module (see [WLAN module on page 35](#)).
5. Remove the system board (see [System board on page 38](#)).

Remove the lock bracket:

- Lift the lock bracket out of the computer.

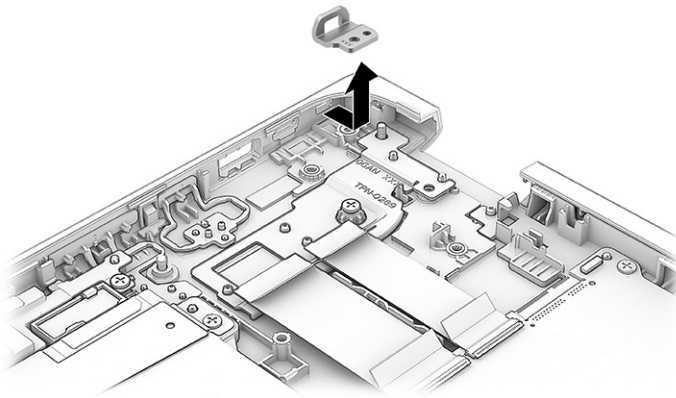

To install the lock bracket, reverse this procedure.

## Display assembly

To remove and disassemble the display assembly, use these procedures and illustrations.

---

 **NOTE:** The display assembly is spared at the subcomponent level. For display assembly spare part information, see the individual removal subsections.

---

Before removing the display panel, follow these steps:

1. Prepare the computer for disassembly (see [Preparation for disassembly on page 25](#)).
2. Remove the top cover with keyboard (see [Top cover with keyboard on page 25](#)).
3. Disconnect the battery cable from the system board (see [Battery on page 33](#)).

Remove the display assembly:

1. Disconnect the webcam module cable **(1)** from the system board.
2. Remove the Phillips M2.0 × 2.9 screw **(2)** that secures the WLAN module and bracket to the system board. (The WLAN module tilts up.)
3. Remove the WLAN bracket **(3)**. The WLAN bracket is included in the Bracket Kit, spare part number N38891-001.
4. Disconnect the two WLAN antenna cables **(4)** from the terminals on the WLAN module.

---

 **NOTE:** The #1/white WLAN antenna cable connects to the WLAN module #1/Main terminal. The #2/ black WLAN antenna cable connects to the WLAN module #2/Aux terminal.

---

5. Release the shielding **(5)** that covers the display panel cable connector.
6. Release the adhesive strip **(6)** that secures the display panel cable to the system board.

7. Disconnect the display panel cable (7) from the system board.

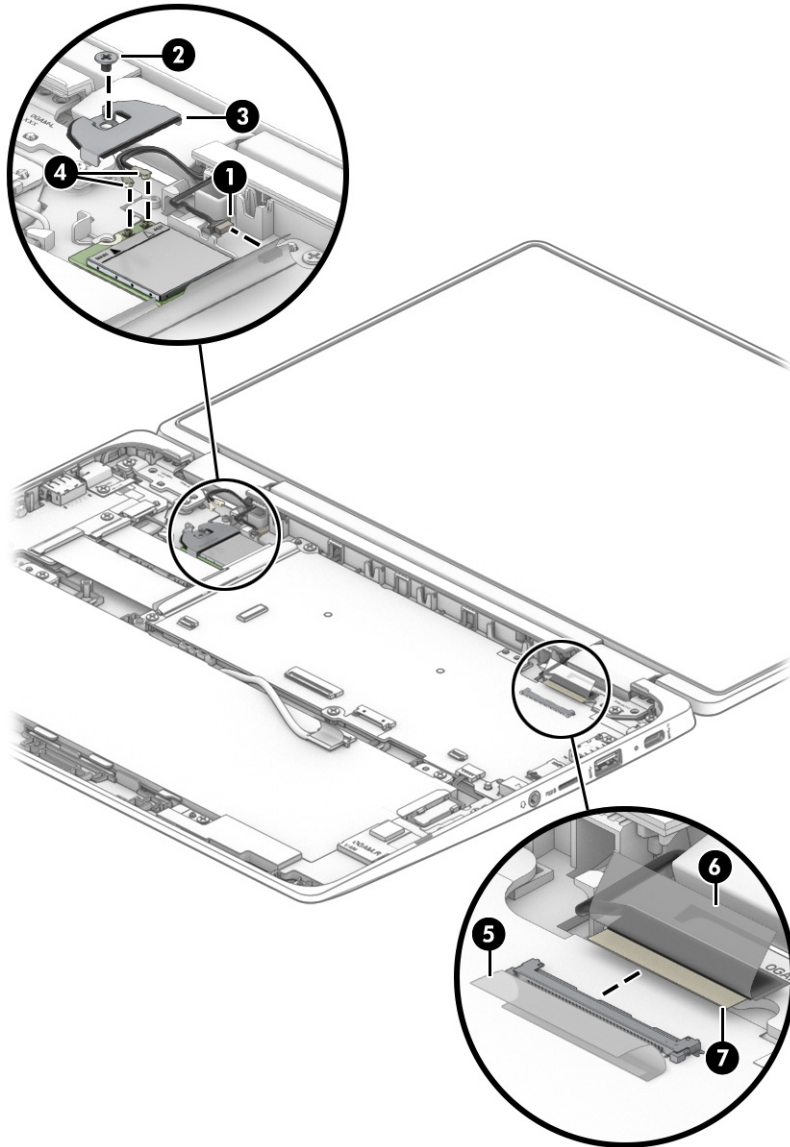

8. Remove the four Phillips M2.5 × 4.7 screws that secure the display assembly to the keyboard/top cover.

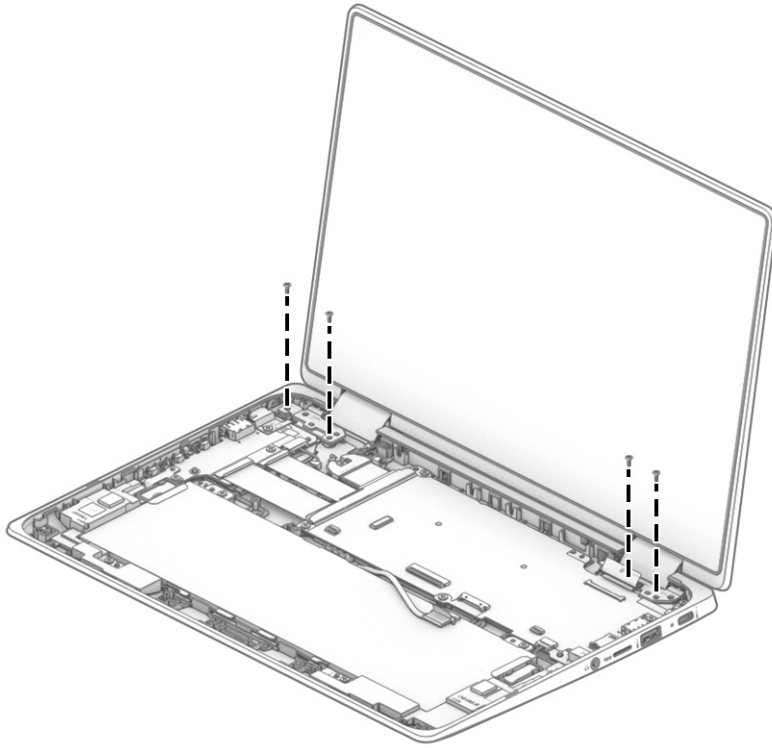

9. Rotate the display assembly **(1)** clockwise to release the right hinge from the keyboard/top cover.

10. Slide the display assembly (2) to the right at an angle to release the left hinge from the keyboard/top cover (3).

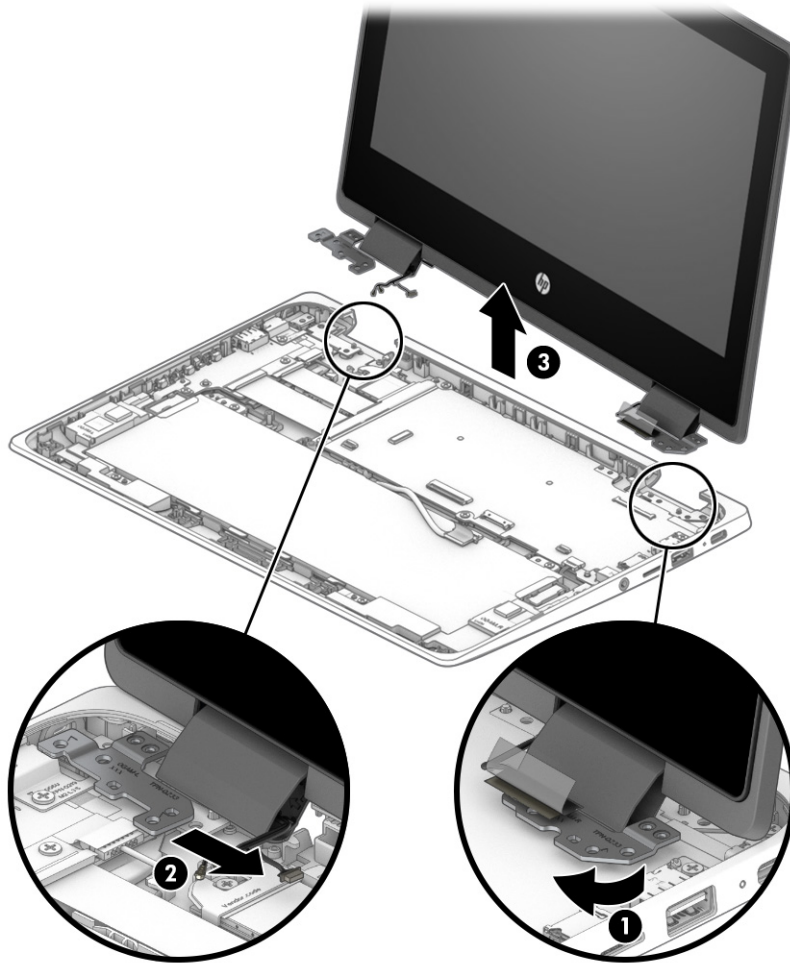

11. Remove the display panel assembly by following these steps:
  - a. Use a case utility tool (1) or a similar thin plastic tool to separate the top edge of the display panel assembly from the display back cover.

- b. Swing the top edge of the display panel assembly (2) up and away from the display back cover until it rests upside down in front of the display back cover.

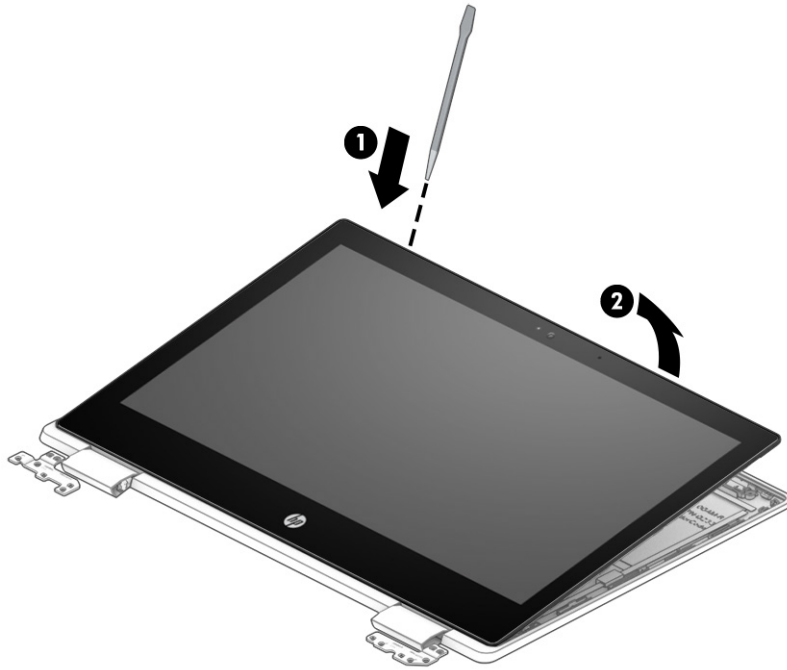

- c. Disconnect the display panel cable (1) from the display panel assembly.
- d. Remove the display panel assembly (2). The display panel assembly is available using spare part number L92337-001.

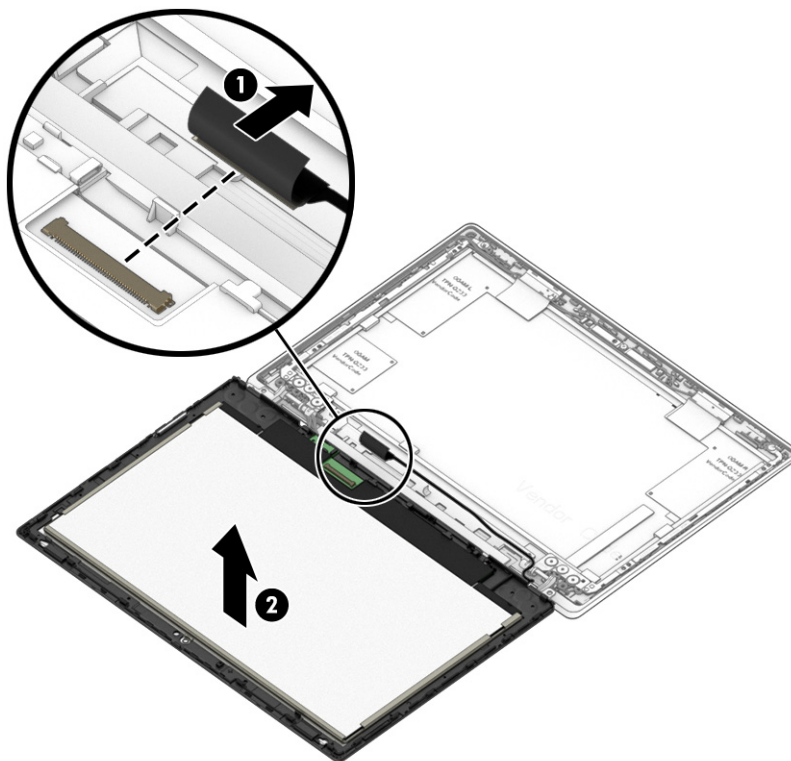



12. Remove the six Phillips M2.5 × 5.0 screws (1) that secure the display panel to the display back cover.
13. Rotate the display back cover downward slightly (2), and then lift the panel off the display back cover (3).

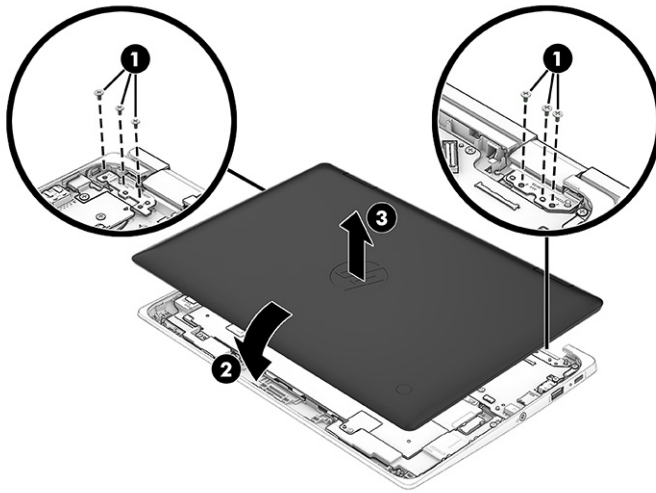

14. Remove the sensor board by following these steps:
  - a. Lift the tape from the connector on the sensor board (1).
  - b. Disconnect the cable from the sensor module (2).
  - c. Pull the module off the computer (3). The module is secured with adhesive.

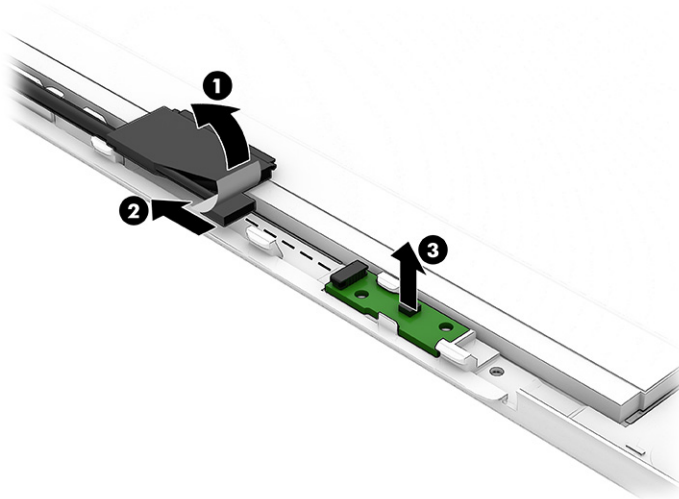

The sensor board is available using spare part number N38892-001.

15. Remove the display hinges by pulling them away from the display back cover. Note that each hinge include a rubber insert.

The display back cover is available using spare part number N38894-001 for emerald green models and N38895-001 for jet black models.



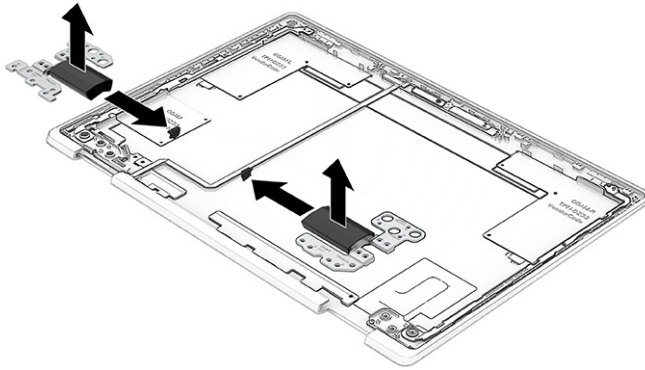

16. Remove the camera module by following these steps:

- a. Detach the camera module **(1)** from the display back cover. (The camera module is attached to the display back cover with double-sided adhesive.)
- b. Release the ZIF connector **(2)**, and then disconnect the cable.

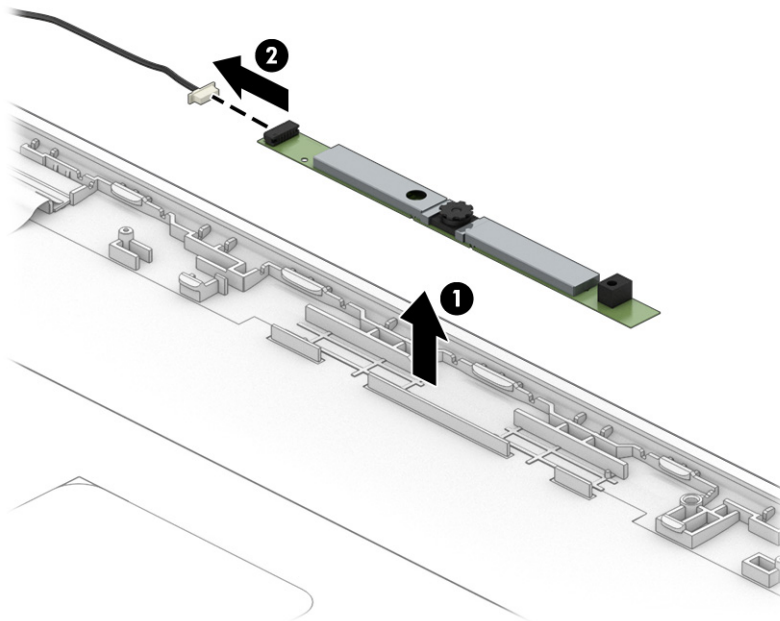

The camera module is available using spare part number N38886-001.

17. Remove the display cable by following these steps:

- a. Remove the tape from the display connector on the back of the panel **(1)**.
- b. Disconnect the cable from the panel **(2)**.

- c. Remove the cable from the clips on the bottom of the panel (3).

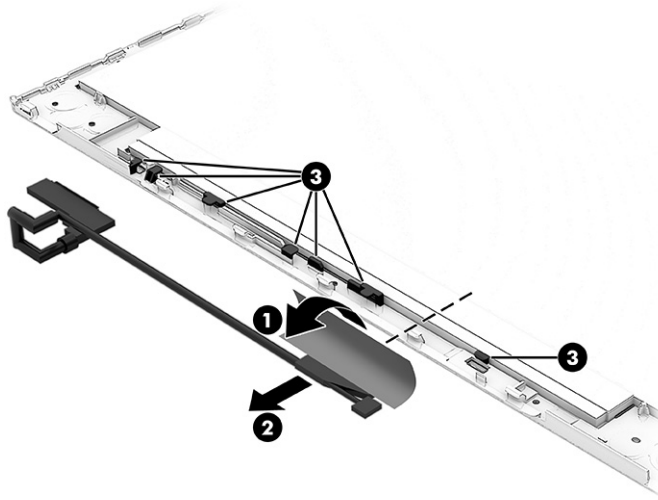

- 18. Remove the camera cable by following these steps:
  - a. Disconnect the cable from the camera module (1).
  - b. Peel the cable off the inside of the display rear cover (2).

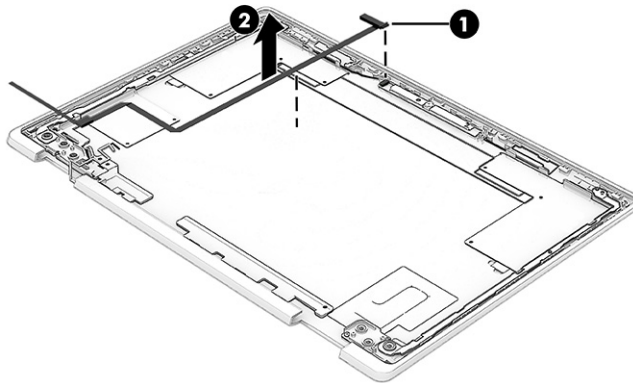

To reassemble and replace the display assembly, reverse this procedure.

---

## 6 Backing up, resetting, and recovering

This chapter provides information about the standard procedures of backing up your personal data, resetting your computer to original factory conditions, and recovering your operating system.

### Backing up

You can back up your data to an optional USB flash drive or SD memory card or through Google Drive™.

For detailed information about creating a backup, go to <http://www.support.google.com>.

### Resetting

A factory reset erases the information on your computer hard drive, including files in the Downloads folder. Before you reset, back up your files to an optional USB flash drive, to an SD memory card, or through Google Drive. The factory reset will not delete your files at these locations.

You might want to reset your computer in the following circumstances:

- You see the message "Reset this Chrome device."
- You are having problems with your user profile or settings.
- You restarted your computer, and it still doesn't work properly.
- You want to change the owner of your computer.

To reset your computer:

1. Under the **Settings** menu, select **Advanced**.
2. In the **Powerwash** section, select **Powerwash**.
3. Select **Restart**.
4. In the window that appears, select **Powerwash**, and then select **Continue**.
5. Follow the on-screen instructions to reset your computer, and sign in with your Google Account.



**NOTE:** The account you sign in with after you reset your computer is recognized as the owner account.

---

6. After you complete the reset, you can set up your computer and check to see whether the problem is fixed.

### Recovering

When your ChromeOS™ doesn't work properly, you can perform a recovery. A recovery reinstalls the operating system, software programs, and original factory settings. It deletes locally saved files and saved networks for all accounts. A system recovery does not affect Google Accounts and data synced to Google Drive.

---

 **IMPORTANT:** Recovery permanently erases everything on your computer hard drive, including your downloaded files. If possible, back up your files before you recover your computer.

 **NOTE:** For more information about performing a system recovery on your computer, go to <http://www.support.google.com>.

---

Before you begin the recovery process, you need the following prerequisites:

- A USB flash drive or SD memory card with a capacity of 4 GB or greater. All data is erased from this storage device when the recovery media is created, so back up all files from the device before you begin.
- A computer with internet access. You must also have administrative rights to the computer.
- A computer AC adapter. The computer must be plugged into AC power during recovery.
- The “ChromeOS is missing or damaged” screen displaying on your computer. If this message is not already displayed:
  - Turn on the computer, press and hold the **esc+f3** keys, and then press the power button. The computer restarts, and the screen shows the “ChromeOS is missing or damaged” screen.

## Option 1: Recovering using an internet connection

Use these instructions to recover the Chrome operating system on your computer without recovery media:

1. Disconnect any external devices connected to your computer, plug in the power cord, and then turn on the computer.
2. To enter recovery mode, press and hold the **esc+f3** keys, and then press the power button. When the “ChromeOS is missing or damaged” screen appears, select **Recover using internet connection** and follow the on-screen instructions.

---

 **NOTE:** The computer must have internet access.

---

3. When the “System Recovery is complete” message appears, reboot your computer.

The computer restarts with ChromeOS reinstalled.

## Option 2: Installing the Chromebook Recovery Utility

The Chromebook™ Recovery Utility recovers the original operating system and software programs that were installed at the factory. You can install this utility from the Chrome Web Store on any computer.

---

 **NOTE:** Use this option if you do not have Internet access on your computer.

---

To install the Chromebook Recovery Utility:

- Open the Chrome Web Store, search for `chrome recovery`, select **Chromebook Recovery Utility** from the Apps list, and follow the on-screen instructions.

## Creating recovery media

You can use recovery media to recover the original operating system and software programs that were installed at the factory.

To create recovery media:

1. Turn on a computer that has internet access.

---

 **NOTE:** You must have administrative rights to the computer.

---

2. Select the **Launcher** icon, and then select **All Apps**.
3. In the Apps window, select **Recovery**, and then select **Get started**.
4. Follow the on-screen instructions to create the recovery media.

---

 **NOTE:** All data and partitions on your recovery media will be deleted. Do not remove the USB flash drive or SD memory card until the process is complete.

---

## Recovering the Chrome operating system with recovery media

Use these instructions to recover the Chrome operating system on your computer using the recovery media that you created.

1. Disconnect any external devices connected to your computer, plug in the power cord, and then turn on the computer.
2. To enter recovery mode, press and hold **esc+f3**, and then press the power button. When the “ChromeOS is missing or damaged” screen appears, insert the recovery media into your computer. The recovery process begins immediately.
3. Wait while Chrome verifies the integrity of the recovery media.

---

 **NOTE:** If you need to cancel the recovery during the verification process, press and hold the power button until the computer turns off. Do not disrupt the system recovery process after the verification step is complete.

 **NOTE:** If an error message is displayed, you might need to run the Chrome Recovery Utility again or use a different USB flash drive or SD memory card.

---

4. When the “System Recovery is complete” message appears, remove the recovery media.  
The computer restarts with ChromeOS reinstalled.

## Setting up your computer after a reset or recovery

After a reset or recovery is complete, perform the initial setup process.

For details about setting up the computer, go to <http://www.support.google.com>.

## Erasing and reformatting the recovery media

When you create recovery media, the USB flash drive or SD memory card is formatted as a recovery tool. After recovery, you must erase the recovery media to reuse your storage device. Follow these steps to use the Chromebook Recovery Utility to erase the recovery media.

1. Select the **Launcher** icon, and then select **All Apps**.
2. In the apps window, select **Recovery**.
3. Select the **Settings** icon, and then select **Erase recovery media**.

4. Select the USB flash drive or SD memory card that you inserted, select **Continue**, and then select **Erase now**.
5. After the recovery media is erased, select **Done** to close the Chromebook Recovery Utility, and then remove the USB flash drive or SD memory card.

The media is ready to be formatted using a formatting tool provided by your operating system.

# 7 Specifications

This chapter provides specifications for your computer system.

## Computer specifications

This section provides specifications for your computer. When traveling with your computer, the computer dimensions and weights, input power ratings, and operating specifications provide helpful information.

**Table 7-1** Computer specifications

	Metric	U.S.
<b>Dimensions</b>		
Width	295 mm	11.6 in
Depth	205 mm	8.1 in
Height	21 mm	0.8 in
<b>Weight</b>		
	1.5 kg	3.2 lb
<b>Input power</b>		
Operating voltage and current	19.5 V DC @ 3.33 A – 65 W	
	19.5 V DC @ 2.31 A – 45 W	
<b>Temperature</b>		
Operating	5°C to 35°C	41°F to 95°F
Nonoperating	-20°C to 60°C	-4°F to 140°F
<b>Relative humidity</b> (noncondensing)		
Operating	10% to 90%	
Nonoperating	5% to 95%	
<b>Maximum altitude</b> (unpressurized)		
Operating	-15 m to 3,048 m	-50 ft to 10,000 ft
Nonoperating	-15 m to 12,192 m	-50 ft to 40,000 ft
<b>NOTE:</b> Applicable product safety standards specify thermal limits for plastic surfaces. The device operates well within this range of temperatures.		

## 35.6 cm (14.0 in) display specifications

This section provides specifications for your display.

**Table 7-2 Display specifications**

	<b>Metric</b>	<b>U.S.</b>
Active diagonal size	<b>29.5 cm</b>	11.6 in
Resolution	1366 × 768	
Surface treatment	BrightView	
Brightness	220 nits	
Viewing angle	UWVA	
Backlight	WLED	
Display panel interface	eDP	



## 8 Power cord set requirements

This chapter provides power cord requirements for countries and regions.

The wide-range input feature of the computer permits it to operate from any line voltage from 100 V AC to 120 V AC, or from 220 V AC to 240 V AC.

The three-conductor power cord set included with the computer meets the requirements for use in the country or region where the equipment is purchased.

Power cord sets for use in other countries or regions must meet the requirements of the country and region where the computer is used.

### Requirements for all countries

These power cord requirements are applicable to all countries and regions.

- The length of the power cord set must be at least **1.0 m** (3.3 ft) and no more than **2.0 m** (6.5 ft).
- All power cord sets must be approved by an acceptable accredited agency responsible for evaluation in the country or region where the power cord set will be used.
- The power cord sets must have a minimum current capacity of 10 A and a nominal voltage rating of 125 V AC or 250 V AC, as required by the power system of each country or region.
- The appliance coupler must meet the mechanical configuration of an EN 60 320/IEC 320 Standard Sheet C13 connector for mating with the appliance inlet on the back of the computer.

### Requirements for specific countries and regions

To determine power cord requirements for specific countries and regions, use this table.

**Table 8-1** Power cord requirements for specific countries and regions

Country/region	Accredited agency	Applicable note number
Argentina	IRAM	1
Australia	SAA	1
Austria	OVE	1
Belgium	CEBEC	1
Brazil	ABNT	1
Canada	CSA	2
Chile	IMQ	1
Denmark	DEMKO	1
Finland	FIMKO	1
France	UTE	1

**Table 8-1 Power cord requirements for specific countries and regions (continued)**

Country/region	Accredited agency	Applicable note number
Germany	VDE	1
India	BIS	1
Israel	SII	1
Italy	IMQ	1
Japan	JIS	3
Netherlands	KEMA	1
New Zealand	SANZ	1
Norway	NEMKO	1
People's Republic of China	CCC	4
Saudi Arabia	SASO	7
Singapore	PSB	1
South Africa	SABS	1
South Korea	KTL	5
Sweden	SEMKO	1
Switzerland	SEV	1
Taiwan	BSMI	6
Thailand	TISI	1
United Kingdom	ASTA	1
United States	UL	2

1. The flexible cord must be Type H05VV-F, three-conductor, 0.75 mm<sup>2</sup> conductor size. Power cord set fittings (appliance coupler and wall plug) must bear the certification mark of the agency responsible for evaluation in the country or region where it will be used.
2. The flexible cord must be Type SVT/SJT or equivalent, No. 18 AWG, three-conductor. The wall plug must be a two-pole grounding type with a NEMA 5-15P (15 A, 125 V AC) or NEMA 6-15P (15 A, 250 V AC) configuration. CSA or C-UL mark. UL file number must be on each element.
3. The appliance coupler, flexible cord, and wall plug must bear a T mark and registration number in accordance with the Japanese Dentori Law. The flexible cord must be Type VCTF, three-conductor, 0.75 mm<sup>2</sup> or 1.25 mm<sup>2</sup> conductor size. The wall plug must be a two-pole grounding type with a Japanese Industrial Standard C8303 (7 A, 125 V AC) configuration.
4. The flexible cord must be Type RVV, three-conductor, 0.75 mm<sup>2</sup> conductor size. Power cord set fittings (appliance coupler and wall plug) must bear the CCC certification mark.
5. The flexible cord must be Type H05VV-F three-conductor, 0.75 mm<sup>2</sup> conductor size. KTL logo and individual approval number must be on each element. Approval number and logo must be printed on a flag label.
6. The flexible cord must be Type HVCTF three-conductor, 1.25 mm<sup>2</sup> conductor size. Power cord set fittings (appliance coupler, cable, and wall plug) must bear the BSMI certification mark.
7. For 127 V AC, the flexible cord must be Type SVT or SJT 3-conductor, 18 AWG, with plug NEMA 5-15P (15 A, 125 V AC), with UL and CSA or C-UL marks. For 240 V AC, the flexible cord must be Type H05VV-F three-conductor, 0.75 mm<sup>2</sup> or 1.00 mm<sup>2</sup> conductor size, with plug BS 1363/A with BSI or ASTA marks.

---

## 9 Recycling

When a nonrechargeable or rechargeable battery has reached the end of its useful life, do not dispose of the battery in general household waste. Follow the local laws and regulations in your area for battery disposal.

HP encourages customers to recycle used electronic hardware, HP original print cartridges, and rechargeable batteries. For more information about recycling programs, see the HP website at <http://www.hp.com/recycle>.

# Index

## A

- AC adapter light 3
- AC adapters, spare part numbers 14
- action keys
  - identifying 7
- audio-in (microphone) jack, identifying 3
- audio-out (headphone) jack, identifying 3
- audio, product description 1

## B

- backing up 50
- battery
  - illustrated 13
  - light 3
  - removal and replacement 33
  - spare part numbers 13, 33
- Bluetooth label 8
- bottom cover
  - illustrated 13
  - spare part numbers 13
- buttons
  - power 5

## C

- camera 6
  - identifying 6
- camera light, identifying 6
- camera module
  - illustrated 13
  - spare part numbers 13
- caring for your computer 20
- cautions
  - electrostatic discharge 16, 17
- Chromebook Recovery Utility, installing 51
- cleaning your computer 20
  - caring for wood veneer 22
  - disinfecting 21
  - HP Easy Clean 20
  - removing dirt and debris 20
- components
  - bottom 8
  - display 5
  - keyboard area 6

- left side 4
- right side 3
- computer major components 11
- computer specifications 54
- connector, power 4

## D

- display
  - specifications 54
- display assembly
  - subcomponents 13
- display back cover
  - illustrated 13
  - spare part numbers 13
- display panel
  - illustrated 13
  - product description 1
  - spare part numbers 13

## E

- electrostatic discharge (ESD) 16, 17
  - preventing damage 16-18
- esc key, identifying 7

## G

- graphics, product description 1
- grounding methods 16-18
- guidelines
  - packaging 16, 22
  - transporting 16, 22
  - workstation 16

## H

- hard drive
  - product description 1
  - specifications 54
- headphone (audio-out) jack 3
- hinge
  - illustrated 13
  - spare part numbers 13

## I

- illustrated parts catalog 11
- internal microphone, identifying 6

## J

- jacks
  - audio-in (microphone) 3
  - audio-out (headphone) 3

## K

- keyboard
  - product description 1
- keyboard camera
  - removal and replacement 30
  - spare part numbers 30
- keyboard camera cable
  - removal 31
  - spare part numbers 31
- keys
  - esc 7

## L

- labels
  - Bluetooth 8
  - regulatory 8
  - serial number 8
  - service 8
  - wireless certification 8
  - WLAN 8

## Lights

- AC adapter and battery 3
- camera 6
- power 5
- lock bracket
  - removal and replacement 41

## M

- memory module
  - product description 1
- microphone
  - product description 1
- microphone (audio-in) jack, identifying 3
- model name 1

## O

- operating system, product description 2

- P**
- packaging guidelines 16, 22
  - pointing device, product description 1
  - ports
    - product description 1
    - USB SuperSpeed 3, 5
    - USB Type-C power connector and SuperSpeed port 4
  - power
    - light 5
  - power button, identifying 5
  - power connector
    - identifying USB Type-C 4
  - power cord
    - requirements for all countries 56
    - requirements for specific countries and regions 56
    - set requirements 56
  - power cords, spare part numbers 14
  - Power light 5
  - power requirements, product description 2
  - primary storage
    - product description 1
  - processor
    - product description 1
  - product description
    - audio 1
    - display panel 1
    - graphics 1
    - hard drive 1
    - keyboard 1
    - memory module 1
    - microphone 1
    - operating system 2
    - pointing device 1
    - ports 1
    - power requirements 2
    - primary storage 1
    - processors 1
    - product name 1
    - security 2
    - serviceability 2
    - solid-state drive 1
    - video 1
    - wireless 1
  - product name 1
  - product name and number, computer 8
- R**
- recovery media
    - creating 51
    - erase 52
  - recovery, performing 50
  - regulatory information
    - regulatory label 8
    - wireless certification labels 8
  - removal and replacement
    - battery 33
    - keyboard camera 30
    - lock bracket 41
    - procedures 25
    - speakers 32
    - system board 38
    - top cover with keyboard 25
    - touchpad 29
    - touchpad cable 28
    - USB board 37
    - USB board cables 36
    - WLAN module 35
  - resetting 50
- S**
- Screw Kit, spare part number 14
  - security cable slot, identifying 4
  - security, product description 2
  - serial number, computer 8
  - service labels, locating 8
  - serviceability, product description 2
  - slots
    - security cable 4
  - solid-state drive
    - product description 1
  - spare part numbers
    - battery 33
    - keyboard camera 30
    - speakers 32
    - system board 38
    - top cover with keyboard 25
    - touchpad 29
    - touchpad cable 28
    - USB board 37
    - USB board cables 36
    - WLAN module 35
  - speaker
    - illustrated 13
    - spare part numbers 13
  - speakers
    - removal and replacement 32
    - spare part numbers 32
  - speakers, identifying 8
  - special keys 8
  - key lock 8
  - specifications
    - computer 54
    - display 54
    - hard drive 54
  - static electricity 16, 17
  - support information 23
  - system board
    - illustrated 12
    - removal and replacement 38
    - spare part numbers 12, 38
  - system recovery
    - Chrome operating system 52
    - Chromebook Recovery Utility 51
    - internet connection 51
    - recovery media 51
- T**
- top cover with keyboard
    - illustrated 12
    - removal and replacement 25
    - spare part numbers 12, 25
  - touchpad
    - illustrated 12
    - removal and replacement 29
    - spare part numbers 12, 29
  - touchpad cable
    - removal and replacement 28
    - spare part numbers 28
  - touchpad zone, identifying 7
  - transporting guidelines 16, 22
  - traveling with the computer 8
- U**
- USB board
    - illustrated 12
    - removal and replacement 37
    - spare part numbers 12, 37
  - USB board bracket
    - illustrated 12
    - spare part numbers 12
  - USB board cables
    - removal and replacement 36
    - spare part numbers 36
  - USB SuperSpeed port, identifying 3, 5
  - USB Type-C power connector and SuperSpeed port, identifying 4
- V**
- video, product description 1

volume button, identifying 5

## W

wireless certification label 8

wireless, product description 1

WLAN antennas, identifying 6

WLAN device 8

WLAN label 8

WLAN module

    removal and replacement 35

    spare part numbers 35

workstation guidelines 16