

XPS 15 9520

Service Manual



Notes, cautions, and warnings

 **NOTE:** A NOTE indicates important information that helps you make better use of your product.

 **CAUTION:** A CAUTION indicates either potential damage to hardware or loss of data and tells you how to avoid the problem.

 **WARNING:** A WARNING indicates a potential for property damage, personal injury, or death.

Chapter 1: Working inside your computer	5
Before working inside your computer.....	5
Safety instructions.....	5
Electrostatic discharge—ESD protection.....	6
ESD field service kit	6
Transporting sensitive components.....	7
After working inside your computer.....	7
Chapter 2: Removing and installing components	8
Recommended tools.....	8
Screw list.....	8
Major components of XPS-15 9520.....	9
Base cover.....	11
Removing the base cover.....	11
Installing the base cover.....	14
Battery.....	15
Lithium-ion battery precautions.....	15
Removing the battery.....	16
Installing the battery.....	17
Memory.....	18
Removing the memory.....	18
Installing the memory.....	20
Solid-state drive.....	21
Removing the solid-state drive 1.....	21
Installing the solid-state drive 1.....	22
Removing the solid-state drive 2.....	23
Installing the solid-state drive 2.....	24
Removing the M.2 2230 solid-state drive.....	26
Installing the M.2 2230 solid-state drive.....	26
Fans.....	27
Removing the left fan.....	27
Installing the left fan.....	28
Removing the right fan.....	29
Installing the right fan.....	30
Heat sink.....	31
Removing the heat sink.....	31
Installing the heat sink.....	33
Speakers.....	34
Removing the speakers.....	34
Installing the speakers.....	35
I/O board.....	36
Removing the I/O board.....	36
Installing the I/O board.....	37
Display assembly.....	39

Removing the display assembly.....	39
Installing the display assembly.....	41
System board.....	44
Removing the system board.....	44
Installing the system board.....	47
LED board.....	51
Removing the LED board.....	51
Installing the LED board.....	52
Palm-rest and keyboard assembly.....	53
Removing the palm-rest and keyboard assembly.....	53
Installing the palm-rest and keyboard assembly.....	54
Chapter 3: Drivers and downloads.....	56
Chapter 4: System setup.....	57
Entering BIOS setup program.....	57
Navigation keys.....	57
Boot Sequence.....	57
One time boot menu.....	58
System setup options.....	58
System and setup password.....	67
Assigning a system setup password.....	68
Deleting or changing an existing system setup password.....	68
Clearing CMOS settings.....	69
Clearing BIOS (System Setup) and System passwords.....	69
Updating the BIOS.....	69
Updating the BIOS in Windows.....	69
Updating the BIOS using the USB drive in Windows.....	69
Updating the BIOS from the F12 One-Time boot menu.....	70
Chapter 5: Troubleshooting.....	71
Handling swollen Lithium-ion batteries.....	71
Locate the Service Tag or Express Service Code of your Dell computer	71
System diagnostic lights.....	72
SupportAssist diagnostics.....	73
Built-in self-test (BIST).....	73
M-BIST.....	73
LCD Built-in Self Test (BIST).....	74
Recovering the operating system.....	74
WiFi power cycle.....	74
Drain residual flea power (perform hard reset).....	75
Backup media and recovery options.....	75
Real Time Clock—RTC reset.....	75
Chapter 6: Getting help and contacting Dell.....	77



Working inside your computer

Before working inside your computer

About this task







 **NOTE:** The images in this document may differ from your computer depending on the configuration you ordered.

Steps

1. Save and close all open files and exit all open applications.
2. Shut down your computer. Click **Start** >  **Power** > **Shut down**.
 **NOTE:** If you are using a different operating system, see the documentation of your operating system for shut-down instructions.
3. Disconnect your computer and all attached devices from their electrical outlets.
4. Disconnect all attached network devices and peripherals, such as keyboard, mouse, and monitor from your computer.
 **CAUTION:** To disconnect a network cable, first unplug the cable from your computer and then unplug the cable from the network device.
5. Remove any media card and optical disc from your computer, if applicable.

Safety instructions

Use the following safety guidelines to protect your computer from potential damage and to ensure your personal safety. Unless otherwise noted, each procedure included in this document assumes that you have read the safety information that shipped with your computer.

-  **WARNING:** Before working inside your computer, read the safety information that is shipped with your computer. For more safety best practices, see the Regulatory Compliance home page at www.dell.com/regulatory_compliance.
-  **WARNING:** Disconnect your computer from all power sources before opening the computer cover or panels. After you finish working inside the computer, replace all covers, panels, and screws before connecting your computer to an electrical outlet.
-  **CAUTION:** To avoid damaging the computer, ensure that the work surface is flat, dry, and clean.
-  **CAUTION:** To avoid damaging the components and cards, handle them by their edges, and avoid touching the pins and the contacts.
-  **CAUTION:** You should only perform troubleshooting and repairs as authorized or directed by the Dell technical assistance team. Damage due to servicing that is not authorized by Dell is not covered by your warranty. See the safety instructions that is shipped with the product or at www.dell.com/regulatory_compliance.
-  **CAUTION:** Before touching anything inside your computer, ground yourself by touching an unpainted metal surface, such as the metal at the back of the computer. While you work, periodically touch an unpainted metal surface to dissipate static electricity which could harm internal components.
-  **CAUTION:** When you disconnect a cable, pull it by its connector or its pull tab, not the cable itself. Some cables have connectors with locking tabs or thumbscrews that you must disengage before disconnecting the cable.

When disconnecting cables, keep them evenly aligned to avoid bending the connector pins. When connecting cables, ensure that the ports and the connectors are correctly oriented and aligned.

CAUTION: Press and eject any installed card from the media-card reader.

CAUTION: Exercise caution when handling Lithium-ion batteries in laptops. Swollen batteries should not be used and should be replaced and disposed properly.

NOTE: The color of your computer and certain components may appear differently than shown in this document.

Electrostatic discharge—ESD protection

ESD is a major concern when you handle electronic components, especially sensitive components such as expansion cards, processors, memory DIMMs, and system boards. Very slight charges can damage circuits in ways that may not be obvious, such as intermittent problems or a shortened product life span. As the industry pushes for lower power requirements and increased density, ESD protection is an increasing concern.

Due to the increased density of semiconductors used in recent Dell products, the sensitivity to static damage is now higher than in previous Dell products. For this reason, some previously approved methods of handling parts are no longer applicable.

Two recognized types of ESD damage are catastrophic and intermittent failures.

- **Catastrophic** – Catastrophic failures represent approximately 20 percent of ESD-related failures. The damage causes an immediate and complete loss of device functionality. An example of catastrophic failure is a memory DIMM that has received a static shock and immediately generates a "No POST/No Video" symptom with a beep code emitted for missing or nonfunctional memory.
- **Intermittent** – Intermittent failures represent approximately 80 percent of ESD-related failures. The high rate of intermittent failures means that most of the time when damage occurs, it is not immediately recognizable. The DIMM receives a static shock, but the tracing is merely weakened and does not immediately produce outward symptoms related to the damage. The weakened trace may take weeks or months to melt, and in the meantime may cause degradation of memory integrity, intermittent memory errors, etc.

The more difficult type of damage to recognize and troubleshoot is the intermittent (also called latent or "walking wounded") failure.

Perform the following steps to prevent ESD damage:

- Use a wired ESD wrist strap that is properly grounded. The use of wireless anti-static straps is no longer allowed; they do not provide adequate protection. Touching the chassis before handling parts does not ensure adequate ESD protection on parts with increased sensitivity to ESD damage.
- Handle all static-sensitive components in a static-safe area. If possible, use anti-static floor pads and workbench pads.
- When unpacking a static-sensitive component from its shipping carton, do not remove the component from the anti-static packing material until you are ready to install the component. Before unwrapping the anti-static packaging, ensure that you discharge static electricity from your body.
- Before transporting a static-sensitive component, place it in an anti-static container or packaging.

ESD field service kit

The unmonitored Field Service kit is the most commonly used service kit. Each Field Service kit includes three main components: anti-static mat, wrist strap, and bonding wire.

Components of an ESD field service kit

The components of an ESD field service kit are:

- **Anti-Static Mat** – The anti-static mat is dissipative and parts can be placed on it during service procedures. When using an anti-static mat, your wrist strap should be snug and the bonding wire should be connected to the mat and to any bare metal on the system being worked on. Once deployed properly, service parts can be removed from the ESD bag and placed directly on the mat. ESD-sensitive items are safe in your hand, on the ESD mat, in the system, or inside a bag.
- **Wrist Strap and Bonding Wire** – The wrist strap and bonding wire can be either directly connected between your wrist and bare metal on the hardware if the ESD mat is not required, or connected to the anti-static mat to protect hardware that is temporarily placed on the mat. The physical connection of the wrist strap and bonding wire between your skin, the ESD mat, and the hardware is known as bonding. Use only Field Service kits with a wrist strap, mat, and bonding wire. Never

use wireless wrist straps. Always be aware that the internal wires of a wrist strap are prone to damage from normal wear and tear, and must be checked regularly with a wrist strap tester in order to avoid accidental ESD hardware damage. It is recommended to test the wrist strap and bonding wire at least once per week.

- **ESD Wrist Strap Tester** – The wires inside of an ESD strap are prone to damage over time. When using an unmonitored kit, it is a best practice to regularly test the strap prior to each service call, and at a minimum, test once per week. A wrist strap tester is the best method for doing this test. If you do not have your own wrist strap tester, check with your regional office to find out if they have one. To perform the test, plug the wrist-strap's bonding-wire into the tester while it is strapped to your wrist and push the button to test. A green LED is lit if the test is successful; a red LED is lit and an alarm sounds if the test fails.
- **Insulator Elements** – It is critical to keep ESD sensitive devices, such as plastic heat sink casings, away from internal parts that are insulators and often highly charged.
- **Working Environment** – Before deploying the ESD Field Service kit, assess the situation at the customer location. For example, deploying the kit for a server environment is different than for a desktop or portable environment. Servers are typically installed in a rack within a data center; desktops or portables are typically placed on office desks or cubicles. Always look for a large open flat work area that is free of clutter and large enough to deploy the ESD kit with additional space to accommodate the type of system that is being repaired. The workspace should also be free of insulators that can cause an ESD event. On the work area, insulators such as Styrofoam and other plastics should always be moved at least 12 inches or 30 centimeters away from sensitive parts before physically handling any hardware components
- **ESD Packaging** – All ESD-sensitive devices must be shipped and received in static-safe packaging. Metal, static-shielded bags are preferred. However, you should always return the damaged part using the same ESD bag and packaging that the new part arrived in. The ESD bag should be folded over and taped shut and all the same foam packing material should be used in the original box that the new part arrived in. ESD-sensitive devices should be removed from packaging only at an ESD-protected work surface, and parts should never be placed on top of the ESD bag because only the inside of the bag is shielded. Always place parts in your hand, on the ESD mat, in the system, or inside an anti-static bag.
- **Transporting Sensitive Components** – When transporting ESD sensitive components such as replacement parts or parts to be returned to Dell, it is critical to place these parts in anti-static bags for safe transport.

ESD protection summary

It is recommended that all field service technicians use the traditional wired ESD grounding wrist strap and protective anti-static mat at all times when servicing Dell products. In addition, it is critical that technicians keep sensitive parts separate from all insulator parts while performing service and that they use anti-static bags for transporting sensitive components.

Transporting sensitive components

When transporting ESD sensitive components such as replacement parts or parts to be returned to Dell, it is critical to place these parts in anti-static bags for safe transport.

After working inside your computer

About this task

 **CAUTION:** Leaving stray or loose screws inside your computer may severely damage your computer.

Steps

1. Replace all screws and ensure that no stray screws remain inside your computer.
2. Connect any external devices, peripherals, or cables you removed before working on your computer.
3. Replace any media cards, discs, or any other parts that you removed before working on your computer.
4. Connect your computer and all attached devices to their electrical outlets.
5. Turn on your computer.

Removing and installing components

NOTE: The images in this document may differ from your computer depending on the configuration you ordered.

Recommended tools

The procedures in this document may require the following tools:

- Phillips screwdriver #0
- Phillips screwdriver #1
- Torx #5 (T5) screwdriver
- Plastic scribe

Screw list

NOTE: When removing screws from a component, it is recommended to note the screw type, the quantity of screws, and then place them in a screw storage box. This is to ensure that the correct number of screws and correct screw type is restored when the component is replaced.

NOTE: Some computers have magnetic surfaces. Ensure that the screws are not left attached to such surfaces when replacing a component.

NOTE: Screw color may vary with the configuration ordered.

Table 1. Screw list



















Component	Secured to	Screw type	Quantity	Screw image
Base cover	Palm-rest and keyboard assembly	M2x3	8	
Battery	Palm-rest and keyboard assembly	M2x3	4	
Battery	Palm-rest and keyboard assembly	M2x4	4	
Right fan	System board and palm-rest and keyboard assembly	M2x4	1	
I/O board shield	I/O board	M2x4	1	
Left fan	System board and palm-rest and keyboard assembly	M2x4	2	
Solid-state drive 1	System board	M2x2	2	
Solid-state drive 2	System board	M2x2	1	

Table 1. Screw list (continued)

Component	Secured to	Screw type	Quantity	Screw image
Speakers	Palm-rest and keyboard assembly	M2x2	4	
Graphics card-processor thermal shield cover	System board	M2x2	2	
Type-C bracket	Palm-rest and keyboard assembly	M2x4	2	
Display-assembly cable bracket	System board	M2x2	3	
Display-assembly cable holder	Palm-rest and keyboard assembly	M1.6x3	2	
Left hinge	System board and palm-rest and keyboard assembly	M2.5x5.5	4	
Right hinge	System board and palm-rest and keyboard assembly	M2.5x5.5	4	
Wireless-card bracket	System board	M1.6x3	1	
System board	Palm-rest and keyboard assembly	M2x4	2	
Touchpad	Palm-rest and keyboard assembly	M1.6x2.5	6	
Touchpad	Palm-rest and keyboard assembly	M2x1.5	3	

Major components of XPS-15 9520

The following image shows the major components of XPS-15 9520.

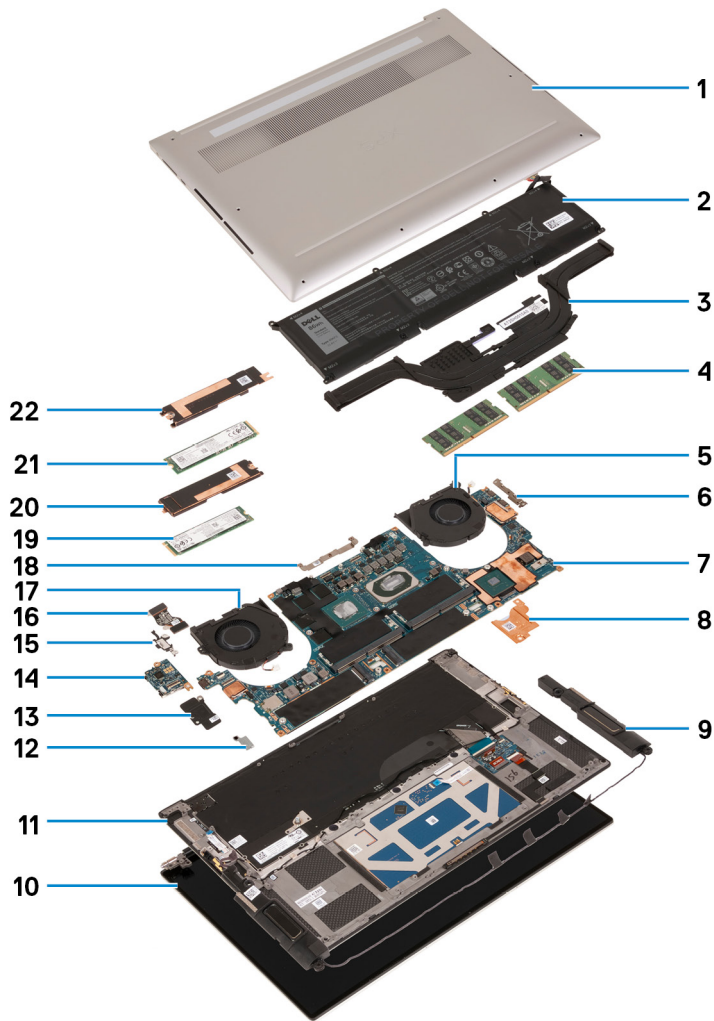

1. Base cover
2. Battery
3. Heat sink
4. Memory module
5. Right fan
6. USB Type-C bracket
7. System board
8. Charger thermal bracket
9. Speaker
10. Display assembly
11. Palm-rest and keyboard assembly
12. Wireless-card bracket
13. I/O-board shield
14. I/O board
15. USB Type-C port bracket
16. I/O-board cable
17. Left fan
18. Display-assembly cable bracket
19. Solid-state drive 2
20. Solid-state drive 2 thermal bracket
21. Solid-state drive 1
22. Solid-state drive 1 thermal bracket

NOTE: Dell provides a list of components and their part numbers for the original system configuration purchased. These parts are available according to warranty coverages purchased by the customer. Contact your Dell sales representative for purchase options.

Base cover

Removing the base cover

Prerequisites

1. Follow the procedure in [Before working inside your computer](#).

About this task

The following images indicate the location of the base cover and provide a visual representation of the removal procedure.



8x
M2x3, T5-Torx



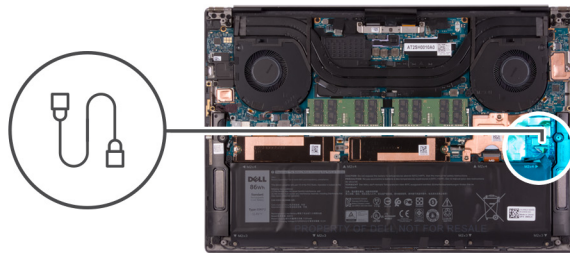
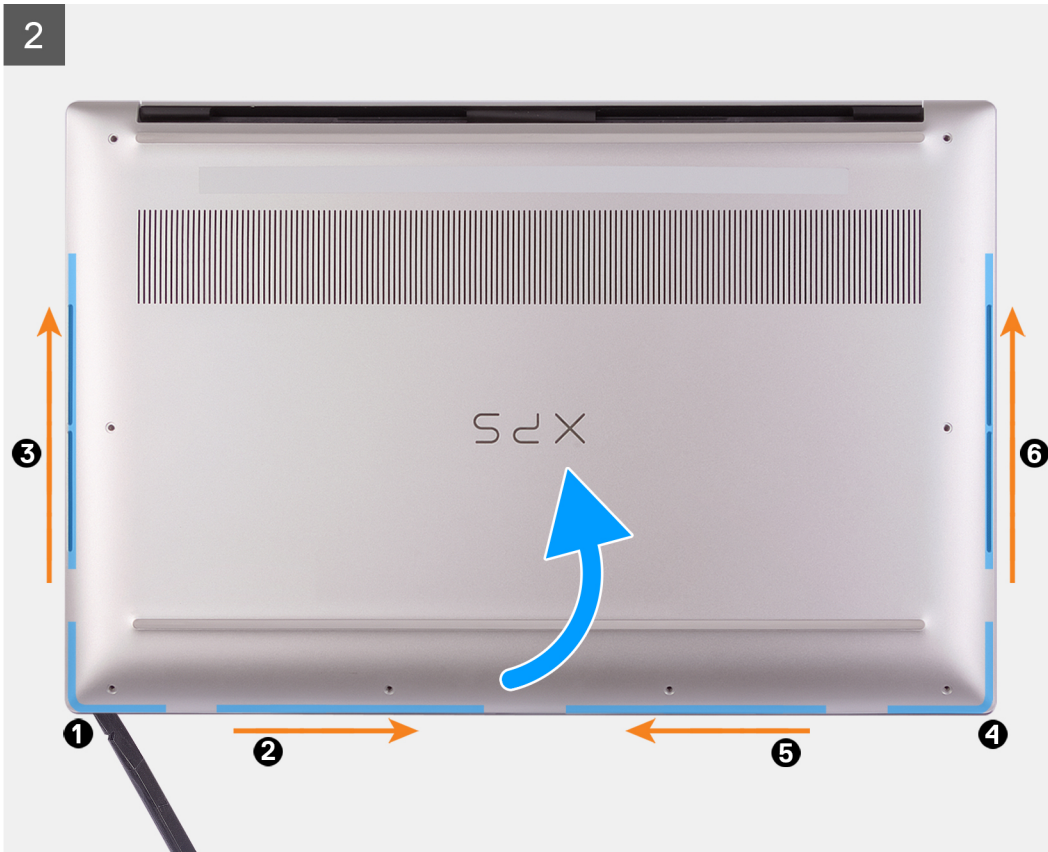

4



Steps

1. Remove the eight screws(M2x3 , T5-Torx) that secure the base cover to the palm-rest and keyboard assembly.

CAUTION: Do not pull on or pry the base cover at the side where the hinges are located; doing so may damage the base cover.

CAUTION: Do not pry open from the top of the computer as this will damage the display FPC.

CAUTION: The base cover is preassembled with the audio-daughter board. The pins at the bottom of the base cover are fragile. They ground the antennas and audio-daughter board. Place the base cover on a clean surface to avoid damage to the pins.

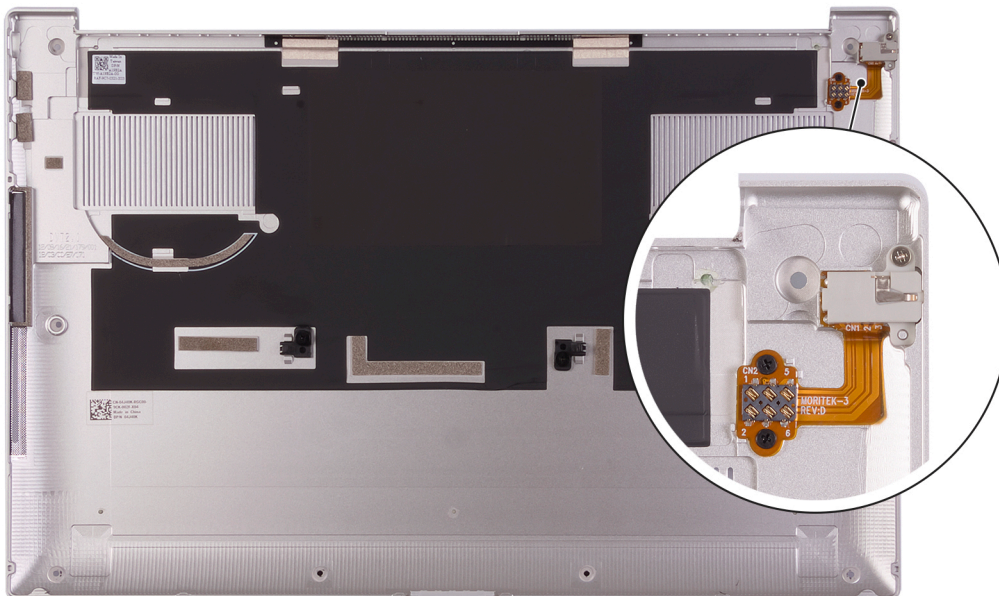

2. Starting from the bottom-left corner, use a plastic scribe to pry the base cover in the direction of the arrows to release the base cover from the palm-rest and keyboard assembly.
3. Grasp the left side and the right side of the base cover and remove the base cover from the palm-rest and keyboard assembly.

CAUTION: Handle with care as the underside of the base cover has pins for grounding the audio board. After removing the base cover, place it in a location where contact can be avoided.

NOTE: The following steps are applicable only if you want to further remove any other component from your computer.

NOTE: Disconnecting the battery cable, removing the battery, or draining the flea power clears the CMOS and resets the BIOS settings on your computer.

NOTE: After your computer is reassembled and powered on, it prompts for the Real Time Clock (RTC) reset. When the RTC reset cycle occurs, the computer restarts several times and then an error message is displayed– "Time of day not set". Enter the BIOS when this error appears and set the date and time on your computer to resume normal functionality.

4. Disconnect the battery cable from the system board.
5. Turn your computer over and press the power button for 15 seconds to drain the flea power.

Installing the base cover

Prerequisites

If you are replacing a component, remove the existing component before performing the installation procedure.

About this task

The following images indicate the location of the base cover and provide a visual representation of the installation procedure.

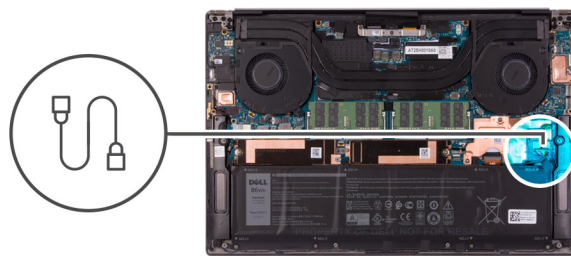



8x
M2x3, T5-Torx

2

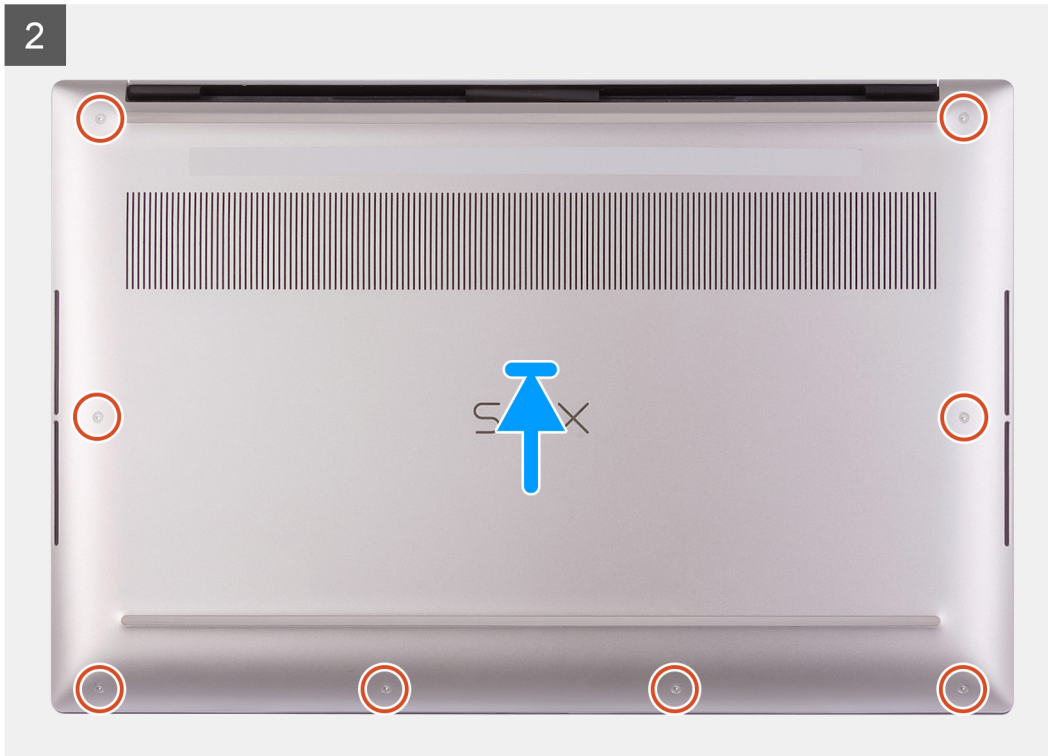

Steps

1. Connect the battery cable to the system board, if applicable.
2. Align the screw holes on the base cover with the screw holes on the palm-rest and keyboard assembly.
3. Starting from the bottom-right corner snap the base cover in. Work your way around to the middle of the base cover and then to the bottom-left corner and snap the base cover into place.
4. Replace the eight screws (M2x3, T5-Torx) that secure the base cover to the palm-rest and keyboard assembly.

Next steps

- i** **NOTE:** After your computer is reassembled and powered on, it prompts for the Real Time Clock (RTC) reset. When the RTC reset cycle occurs, the computer restarts several times and then an error message is displayed- "Time of day not set". Enter the BIOS when this error appears and set the date and time on your computer to resume normal functionality.
1. Follow the procedure in [After working inside your computer](#).

Battery

Lithium-ion battery precautions

- ⚠ CAUTION:**
- Exercise caution when handling Lithium-ion batteries.

- Discharge the battery completely before removing it. Disconnect the AC power adapter from the system and operate the computer solely on battery power—the battery is fully discharged when the computer no longer turns on when the power button is pressed.
- Do not crush, drop, mutilate, or penetrate the battery with foreign objects.
- Do not expose the battery to high temperatures, or disassemble battery packs and cells.
- Do not apply pressure to the surface of the battery.
- Do not bend the battery.
- Do not use tools of any kind to pry on or against the battery.
- Ensure any screws during the servicing of this product are not lost or misplaced, to prevent accidental puncture or damage to the battery and other system components.
- If the battery gets stuck inside your computer as a result of swelling, do not try to release it as puncturing, bending, or crushing a lithium-ion battery can be dangerous. In such an instance, contact Dell technical support for assistance. See www.dell.com/contactdell.
- Always purchase genuine batteries from www.dell.com or authorized Dell partners and resellers.
- Swollen batteries should not be used and should be replaced and disposed properly. For guidelines on how to handle and replace swollen Lithium-ion batteries, see [Handling swollen Lithium-ion batteries](#).

Removing the battery

Prerequisites

1. Follow the procedure in [Before working inside your computer](#).
2. Remove the [base cover](#).

NOTE: Disconnecting the battery cable, removing the battery, or draining the flea power clears the CMOS and resets the BIOS settings on your computer.

About this task

To disconnect the battery cable, release the pull tab located under the battery cable and use it to disconnect the battery cable.



The following image indicates the location of the battery and provides a visual representation of the removal procedure.

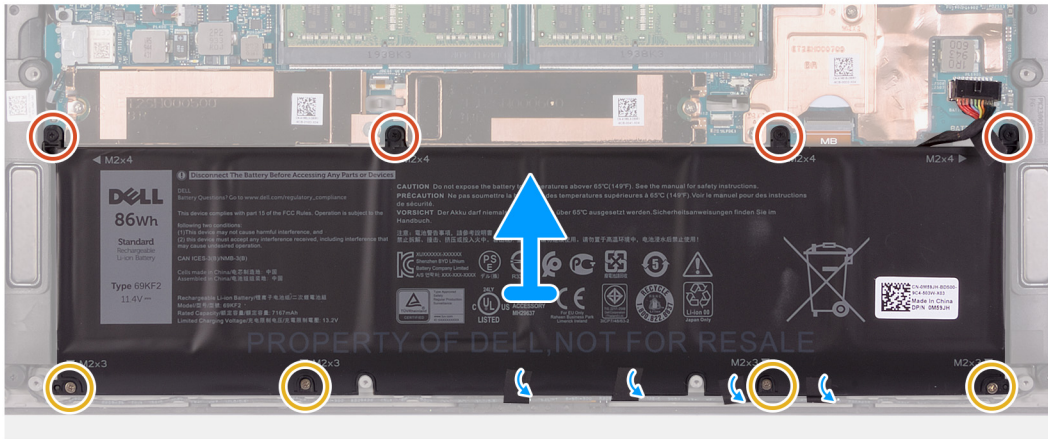
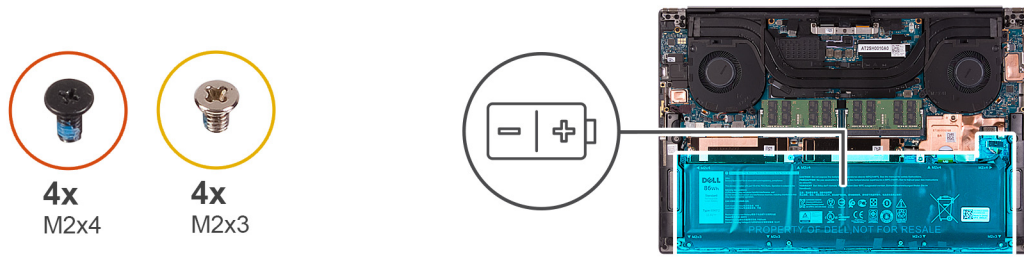

Steps

1. Disconnect the battery cable from the system board, if it was not disconnected earlier.
2. Remove the four screws (M2x4) that secure the battery to the palm-rest and keyboard assembly.
3. Remove the four screws (M2x3) that secure the battery to the palm-rest and keyboard assembly.
4. Peel the tapes that secure the speaker cable to the battery.
5. Lift the battery off the palm-rest and keyboard assembly.

Installing the battery

Prerequisites

If you are replacing a component, remove the existing component before performing the installation procedure.

About this task

The following image indicates the location of the battery and provides a visual representation of the installation procedure.

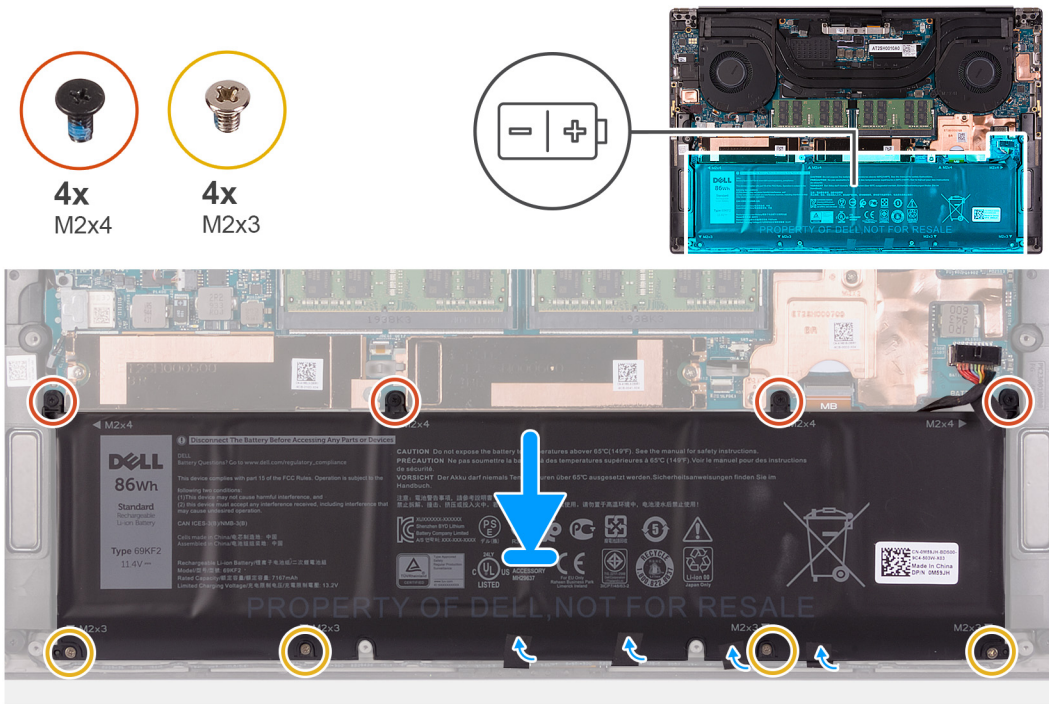

Steps

1. Align the screw holes on the battery with the screw holes on the palm-rest and keyboard assembly.
2. Adhere the tapes that secure the speaker cable to the battery.
3. Replace the four screws (M2x3) that secure the battery to the palm-rest and keyboard assembly.
4. Replace the four screws (M2x4) that secure the battery to the palm-rest and keyboard assembly.
5. Connect the battery cable to the system board.

Next steps

1. Install the [base cover](#).
2. Follow the procedure in [After working inside your computer](#).

Memory

Removing the memory

Prerequisites

1. Follow the procedure in [Before working inside your computer](#).
2. Remove the [base cover](#).

About this task

The following image indicates the location of the memory modules and provides a visual representation of the removal procedure.

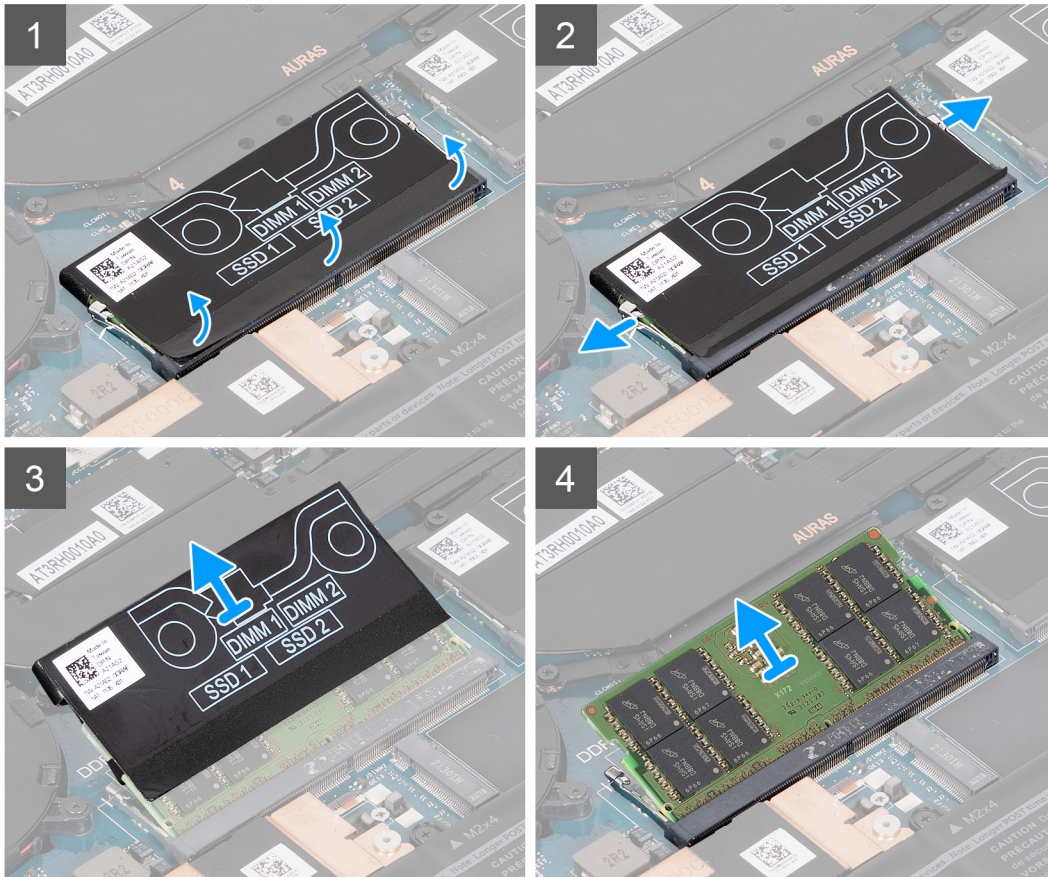
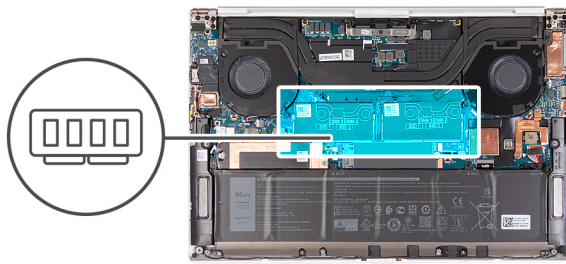

Steps

1. Peel the bottom of the DDR jacket back to access the memory-module slot.
2. Use your fingertips to carefully spread apart the securing-clips on each end of the memory-module slot until the memory module pops up.
3. Remove the DDR jacket from the memory module.
4. Slide and remove the memory module from the memory-module slot.

i NOTE: Repeat step 1 to step 3 to remove the other memory module if required.

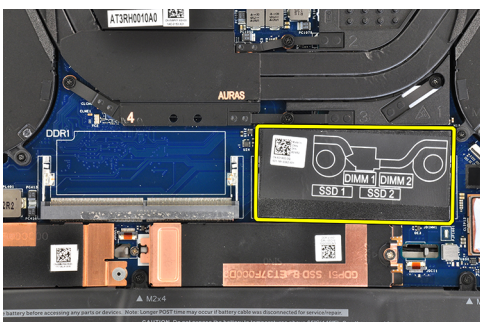

Installing the memory

Prerequisites

If you are replacing a component, remove the existing component before performing the installation procedure.

About this task

The following image indicates the location of the memory modules and provides a visual representation of the installation procedure.

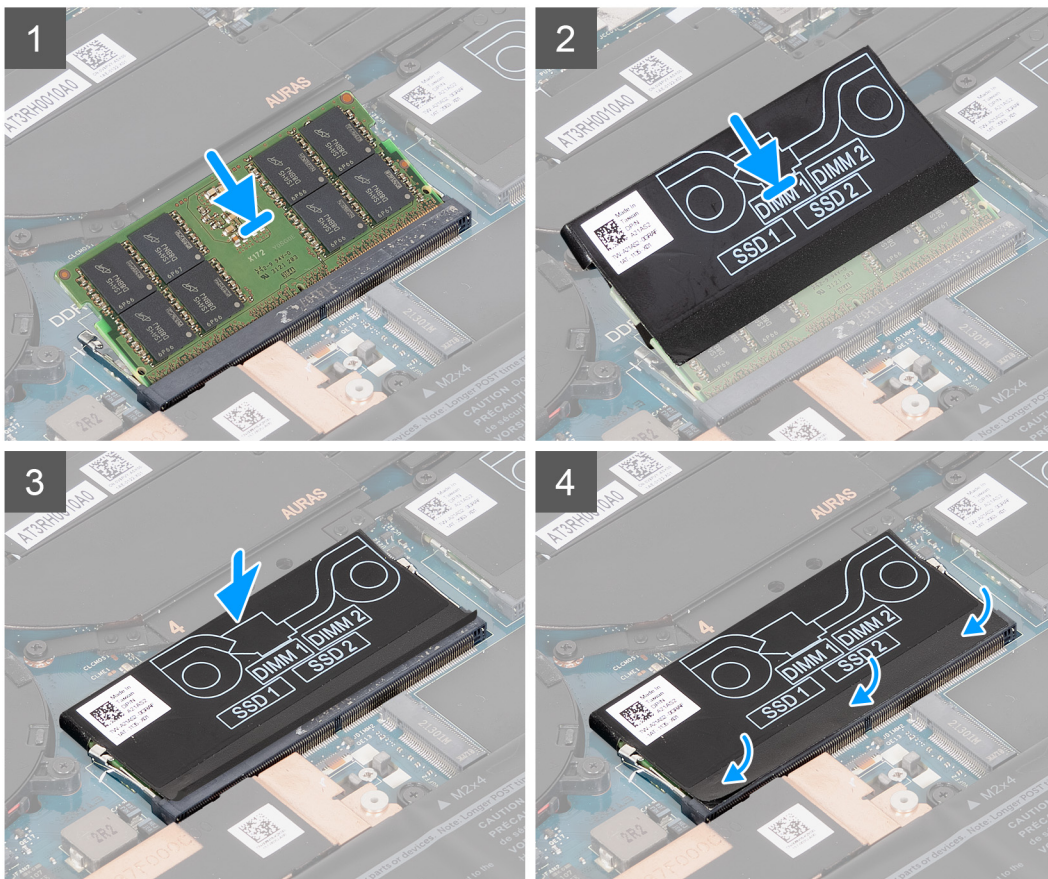
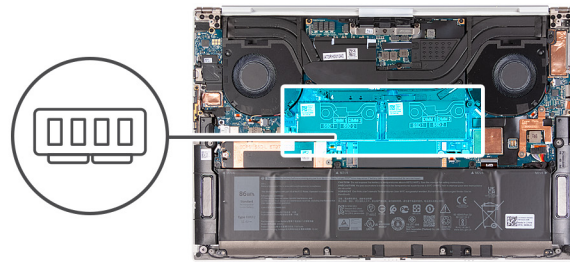

Steps

1. Align the notch on the memory module with the tab on the memory-module slot.
2. Slide the memory module firmly at an angle, into the memory-module slot.
3. Slide the DDR jacket back on the memory module.
4. Press the memory module down until it clicks into place.

NOTE: If you do not hear the click, remove the memory module and reinstall it.

NOTE: Repeat step 1 to step 3 to install the other memory module if available on your computer.

5. Press the flaps of the DDR jacket back in place.

Next steps

1. Install the [base cover](#).
2. Follow the procedure in [After working inside your computer](#).

Solid-state drive

Removing the solid-state drive 1

Prerequisites

1. Follow the procedure in [Before working inside your computer](#).

 **CAUTION:** Solid-state drives are fragile. Exercise care when handling the solid-state drive.

 **CAUTION:** To avoid data loss, do not remove the solid-state drive while the computer is turned on or is in sleep state.

2. Remove the [base cover](#).

About this task

The following image indicates the location of the solid-state drive 1 and provides a visual representation of the removal procedure.

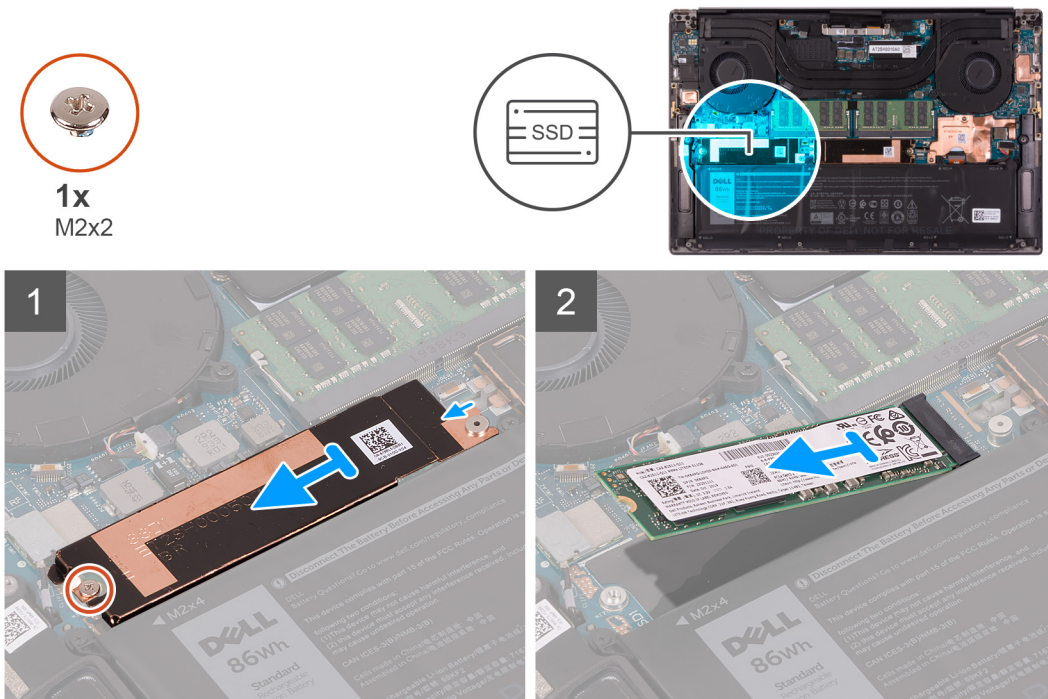

Steps

1. Remove the screw (M2x2) that secures the solid-state drive thermal bracket and the solid-state drive 1 to the system board.
2. Slide the solid-state drive thermal bracket from the peg and lift it from the system board.

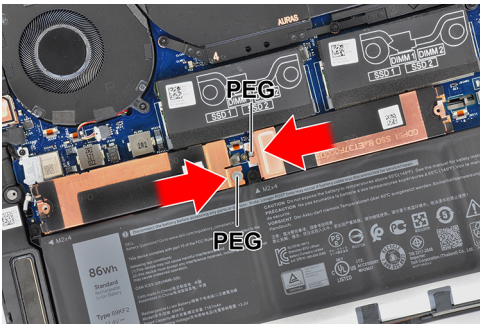

3. Slide and remove the solid-state drive 1 from the solid-state drive slot.

NOTE: The size of the solid-state drive thermal bracket varies based on the storage type. A solid-state drive thermal bracket that is designed for an M.2 2280 drive cannot accommodate an M.2 2230 drive and vice versa. To use a M.2 2230 drive, an M.2 solid-state drive bracket must be used. Follow the procedure in [Removing the M.2 2230 solid-state drive](#).

Installing the solid-state drive 1

Prerequisites

If you are replacing a component, remove the existing component before performing the installation procedure.

CAUTION: Solid-state drives are fragile. Exercise care when handling the solid-state drive.

About this task

The following image indicates the location of the solid-state drive 1 and provides a visual representation of the installation procedure.

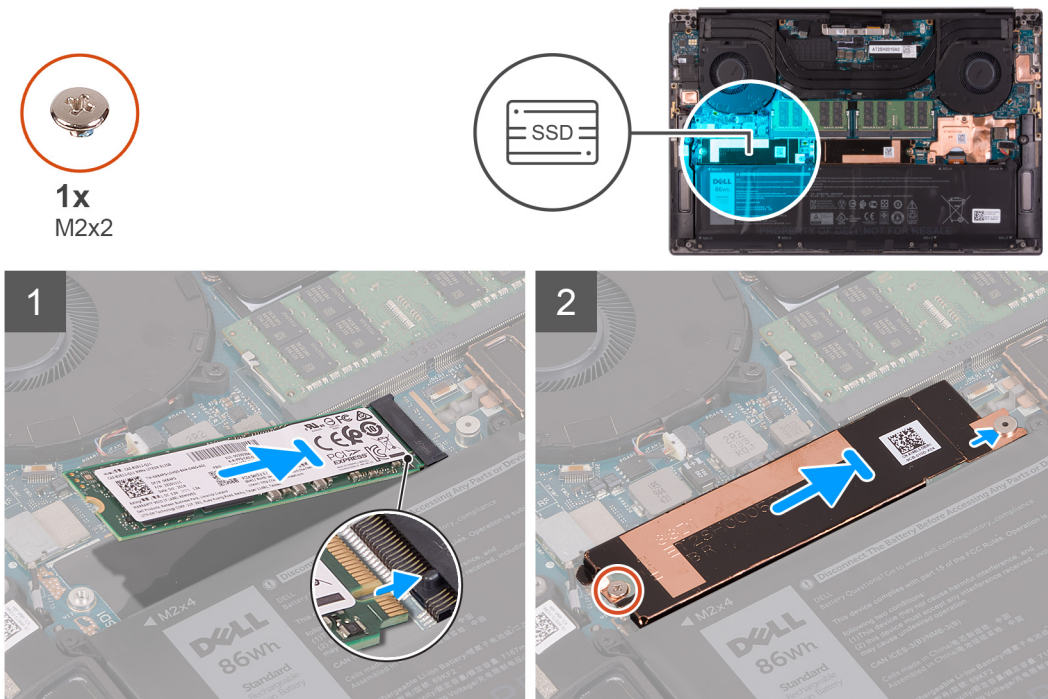

Steps

1. Align the notch on the solid-state drive 1 with the tab on the solid-state drive slot.
2. Gently slide the solid-state drive 1 into the solid-state drive slot.

3. Slide the solid-state drive thermal bracket under the peg on the system board.

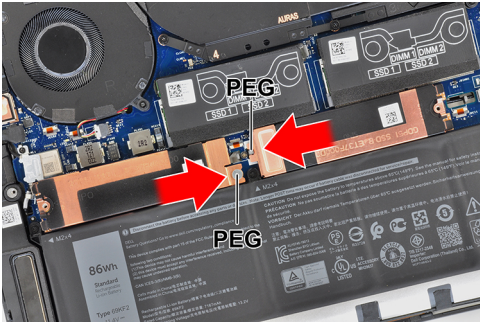

4. Align the screw hole on the solid-state drive thermal bracket with the peg on the system board.

i **NOTE:** The size of the solid-state drive thermal bracket varies based on the storage type. A solid-state drive thermal bracket that is designed for an M.2 2280 drive cannot accommodate an M.2 2230 drive and vice versa. To use a M.2 2230 drive, an M.2 solid-state drive bracket must be used. Follow the procedure in [Installing the M.2 2230 solid-state drive](#).

5. Replace the screw (M2x2) that secures the solid-state drive thermal bracket and the solid-state drive 1 to the system board.

Next steps

1. Install the [base cover](#).
2. Follow the procedure in [After working inside your computer](#).

Removing the solid-state drive 2

Prerequisites

1. Follow the procedure in [Before working inside your computer](#).

⚠ CAUTION: Solid-state drives are fragile. Exercise care when handling the solid-state drive.

⚠ CAUTION: To avoid data loss, do not remove the solid-state drive while the computer is in sleep or on state.

2. Remove the [base cover](#).

About this task

The following image indicates the location of the solid-state drive and provides a visual representation of the removal procedure.



1x
M2x2

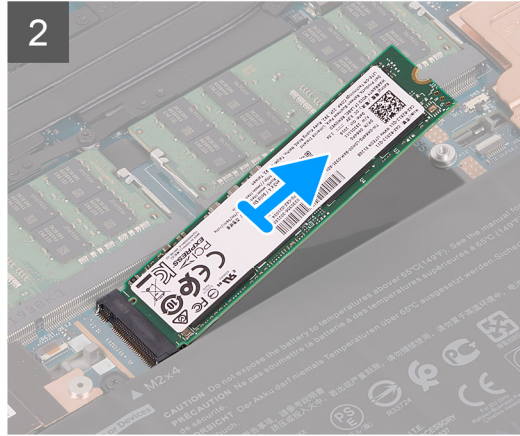
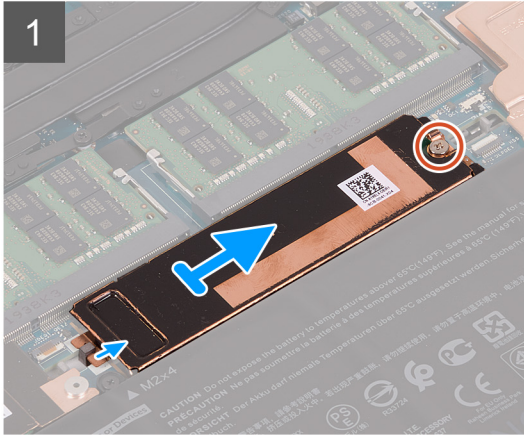
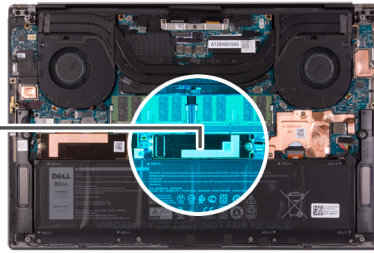

Steps

1. Remove the screw (M2x2) that secures the solid-state drive thermal bracket and the solid-state drive 2 to the system board.
2. Slide the solid-state drive thermal bracket from the peg and lift it from the system board.

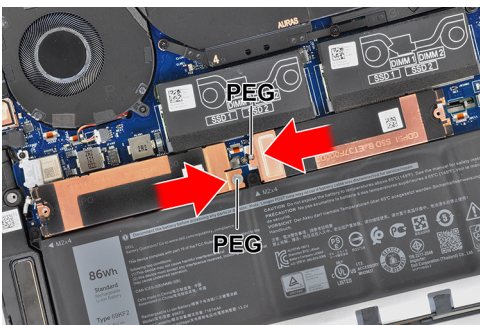

3. Slide and remove the solid-state drive 2 from the solid-state drive slot.

NOTE: The size of the solid-state drive thermal bracket varies based on the storage type. A solid-state drive thermal bracket that is designed for an M.2 2280 drive cannot accommodate an M.2 2230 drive and vice versa. To use a M.2 2230 drive, an M.2 solid-state drive bracket must be used. Follow the procedure in [Removing the M.2 2230 solid-state drive](#).

Installing the solid-state drive 2

Prerequisites

If you are replacing a component, remove the existing component before performing the installation procedure.

CAUTION: Solid-state drives are fragile. Exercise care when handling the solid-state drive.

NOTE: Your computer supports two solid-state drive slots. Solid-state drive1 is the primary slot and solid-state drive2 is the secondary slot. If you are installing only one solid-state drive, install the drive to the primary slot. Install the second solid-state drive, if available, to the solid-state drive2 slot.

About this task

The following image indicates the location of the solid-state drive 2 and provides a visual representation of the installation procedure.

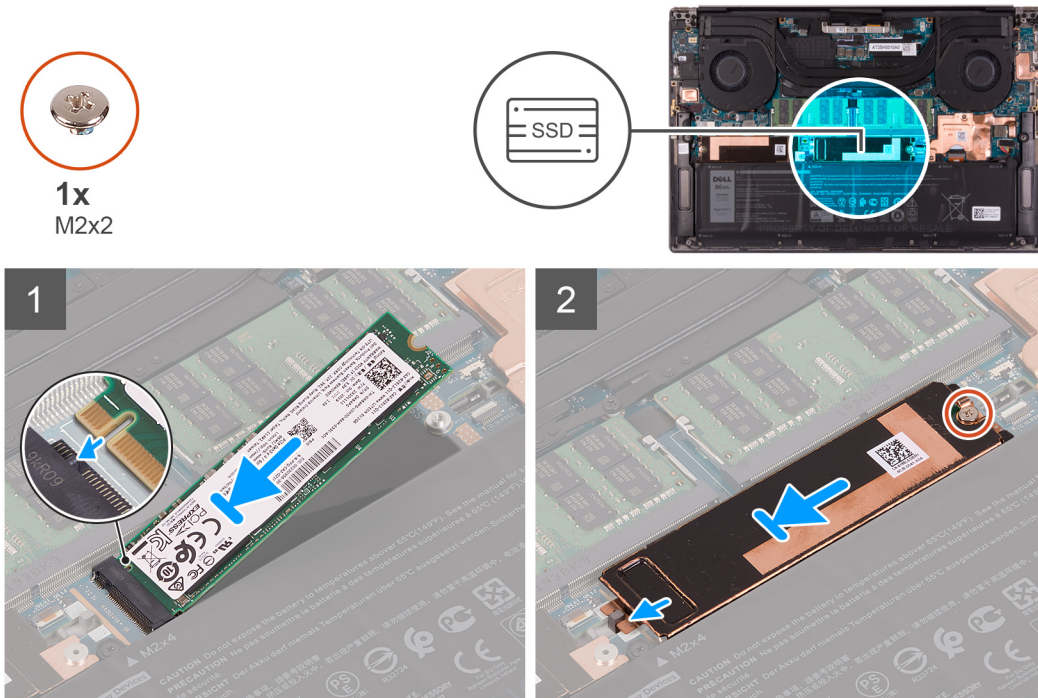

Steps

1. Align the notch on the solid-state drive 2 with the tab on the solid-state drive slot.
2. Gently slide the solid-state drive 2 into the solid-state drive slot.
3. Slide the solid-state drive thermal bracket into the peg on the system board, and align the screw hole on the solid-state drive thermal bracket with the screw hole on the system board.

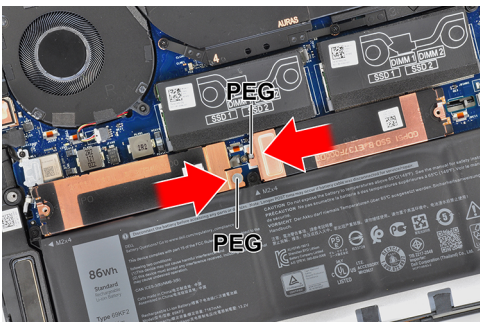

NOTE: The size of the solid-state drive thermal bracket varies based on the storage type. A solid-state drive thermal bracket that is designed for an M.2 2280 drive cannot accommodate an M.2 2230 drive and vice versa. To use a M.2 2230 drive, an M.2 solid-state drive bracket must be used. Follow the procedure in [Installing the M.2 2230 solid-state drive](#).

4. Replace the screw (M2x2) that secures the solid-state drive thermal bracket and the solid-state drive 2 to the system board.

Next steps

1. Install the [base cover](#).
2. Follow the procedure in [After working inside your computer](#).

Removing the M.2 2230 solid-state drive

About this task

If you are replacing the M.2 2230 solid-state drive with an M.2 2280 solid-state drive, the following images indicate how to remove the M.2 2230 solid-state drive from the M.2 2230 solid-state drive bracket.

1. After removing the M.2 2230 solid-state drive with bracket from the solid-state drive slot., keep the printed side of the M.2 2230 solid-state drive facing up.

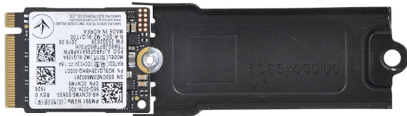

2. Remove the M2x2 screw that secures the M.2 2230 solid-state drive to the M.2 solid-state drive bracket.

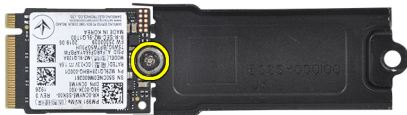

3. Lift the M.2 2230 solid-state drive off the M.2 solid-state drive bracket.

Installing the M.2 2230 solid-state drive

Prerequisites

If you are replacing a component, remove the existing component before performing the installation procedure.

About this task

This computer supports two solid-state drive form factors.

- M.2 2230
- M.2 2280

If you are replacing the M.2 2280 solid-state drive with an M.2 2230 solid-state drive, the following images indicate how to install the solid-state drive bracket to the M.2 2230 solid-state drive card before installing the 2230 solid-state drive to the computer.

1. With the printed side of the solid-state drive facing up, align the screw hole on the M.2 2230 solid-state drive with the screw hole on the M.2 solid-state drive bracket.

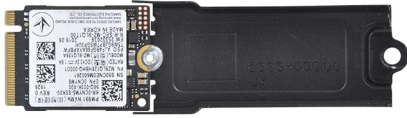

2. Secure the M.2 2230 solid-state drive to the M.2 solid-state drive bracket with a M2x2 screw.

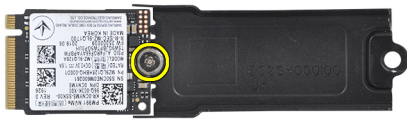

3. To install the M.2 2230 solid-state drive card to the solid-state drive card slot 1, see [installing the solid state drive 1](#). To install the M.2 2230 solid-state drive card to the solid-state drive card slot 2, see [installing the solid state drive 2](#).

Fans

Removing the left fan

Prerequisites

1. Follow the procedure in [Before working inside your computer](#).
2. Remove the [base cover](#).

About this task

The following images indicate the location of the left fan and provide a visual representation of the removal procedure.



3x
M2x4

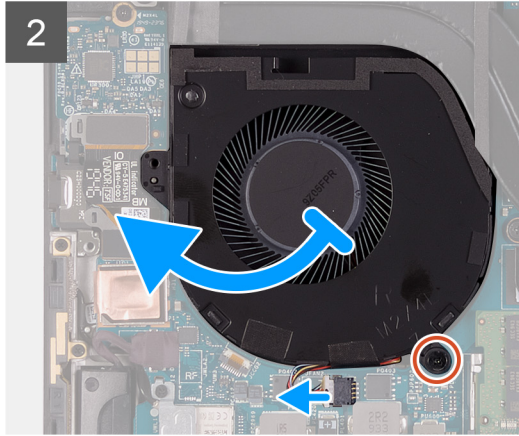
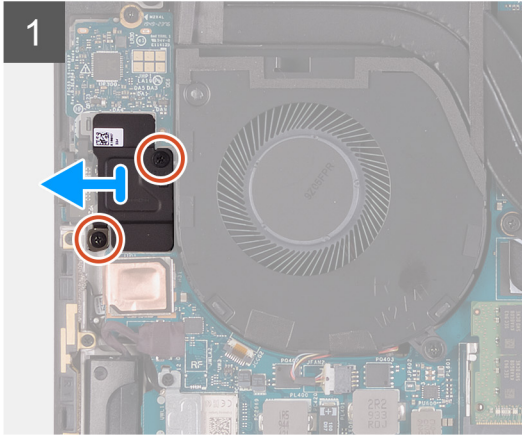
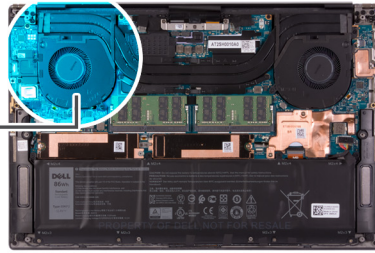
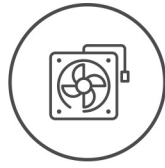

Steps

1. Remove the two screws (M2x4) that secure the I/O-board FPC bracket to the left fan and the palm-rest and keyboard assembly.
2. Lift the I/O-board FPC bracket off the system board.
3. Remove the screw (M2x4) that secures the fan to the system board.
4. Disconnect the left-fan cable from the system board.
5. Partially lift the left side of the left fan and slide it to the left to remove it from the palm-rest and keyboard assembly.

CAUTION: Do not hold the fan assembly at the center, as it may damage the center bearing.

CAUTION: When removing the fan, do not lift the fan up directly as this may damage the fan.

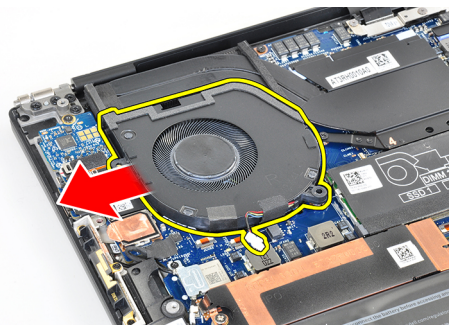
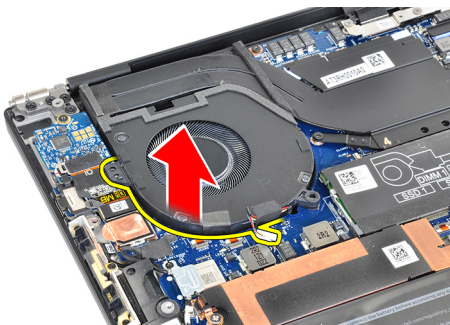

NOTE: The images shown above are for the left fan, but the same information applies for the right fan.

Installing the left fan

Prerequisites

If you are replacing a component, remove the existing component before performing the installation procedure.

About this task

The following images indicate the location of the left fan and provide a visual representation of the installation procedure.

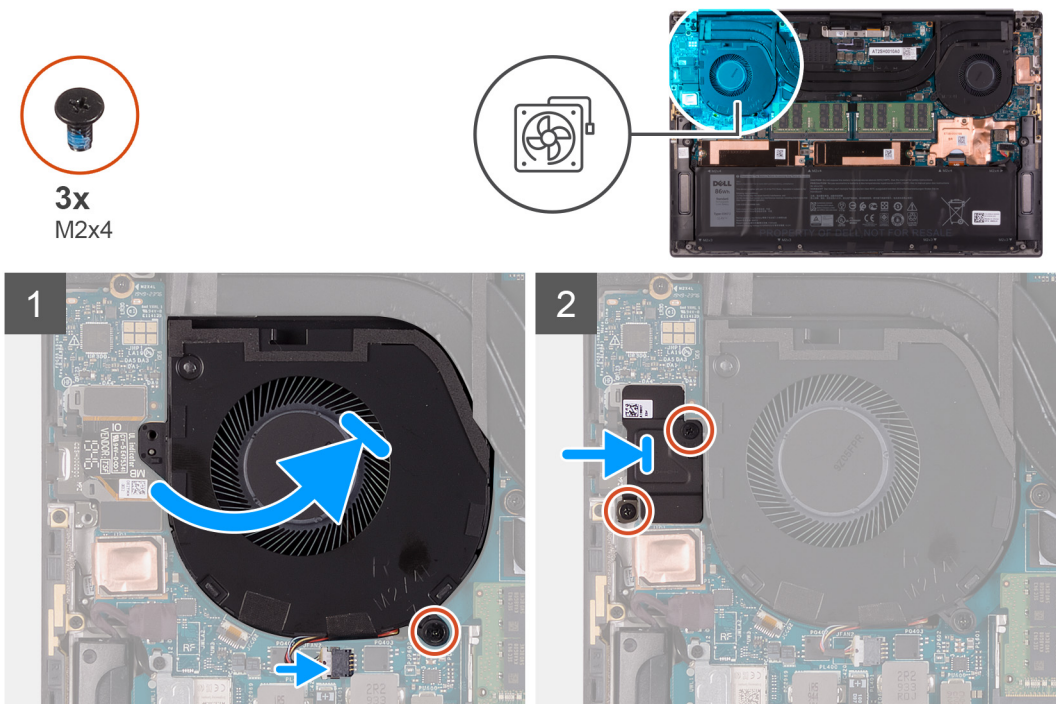

Steps

1. Slide the left fan below the heat sink and align the screw hole on fan with the screw hole on the palm-rest and keyboard assembly.
2. Replace the screw (M2x4) that secures the left fan to the system board.
3. Connect the left-fan cable to the system board.
4. Align the screw holes on the I/O-board shield with the screw holes on the left fan and the system board.
5. Replace the two screws (M2x4) that secure the I/O-board shield to the left fan and palm-rest and keyboard assembly.

Next steps

1. Install the [base cover](#).
2. Follow the procedure in [After working inside your computer](#).

Removing the right fan

Prerequisites

1. Follow the procedure in [Before working inside your computer](#).
2. Remove the [base cover](#).

About this task

The following images indicate the location of the right fan and provide a visual representation of the removal procedure.

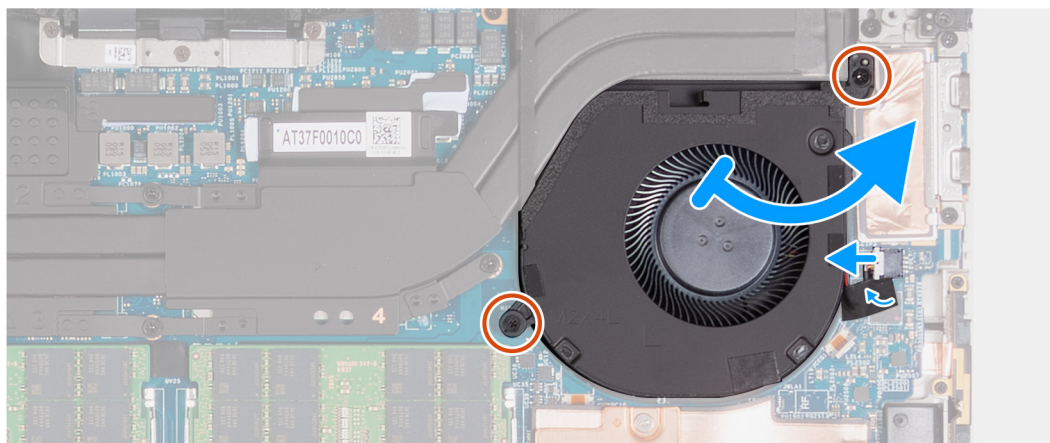
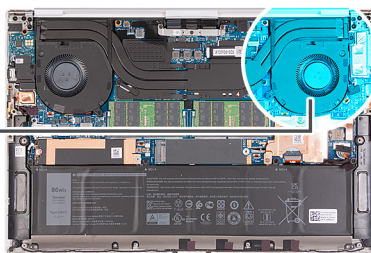
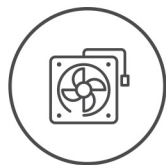

Steps

1. Peel the tape that secures the right-fan cable to the system board.
2. Disconnect the right-fan cable from the system board.
3. Remove the two screws (M2x4) that secure the right fan to the system board and palm-rest and keyboard assembly.

 **CAUTION:** Do not hold the fan assembly at the center, as it may damage the center bearing.

4. Lift the right side of the right fan slightly. Then, slide the right fan to the right to remove it from the palm-rest and keyboard assembly.

Installing the right fan

Prerequisites

If you are replacing a component, remove the existing component before performing the installation procedure.

About this task

The following images indicate the location of the right fan and provide a visual representation of the installation procedure.



2x
M2x4

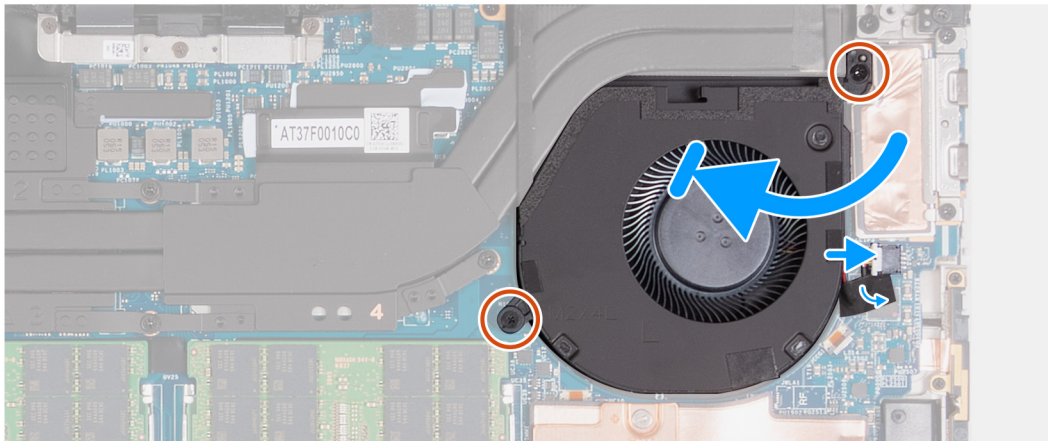
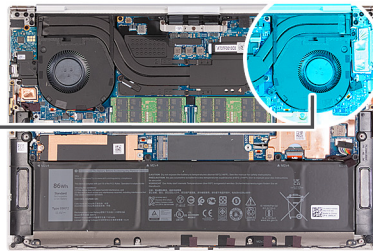
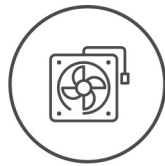

Steps

1. Connect the right-fan cable to the system board.
2. Slide fan below the heat sink and align the screw holes on the right fan with the screw holes on the system board and palm-rest and keyboard assembly.
3. Replace the two screws (M2x4) that secure the right fan to the system board and palm-rest and keyboard assembly.
4. Adhere the tape that secures the right-fan cable to the system board.

Next steps

1. Install the [base cover](#).
2. Follow the procedure in [After working inside your computer](#).

Heat sink

Removing the heat sink

Prerequisites

1. Follow the procedure in [Before working inside your computer](#).

CAUTION: For maximum cooling of the processor, do not touch the heat transfer areas on the heat sink. The oils in your skin can reduce the heat transfer capability of the thermal grease.

NOTE: The heat sink may become hot during normal operation. Allow sufficient time for the heat sink to cool before you touch it.

2. Remove the [base cover](#).

About this task

The following image indicates the location of the heat sink and provides a visual representation of the removal procedure.



4x

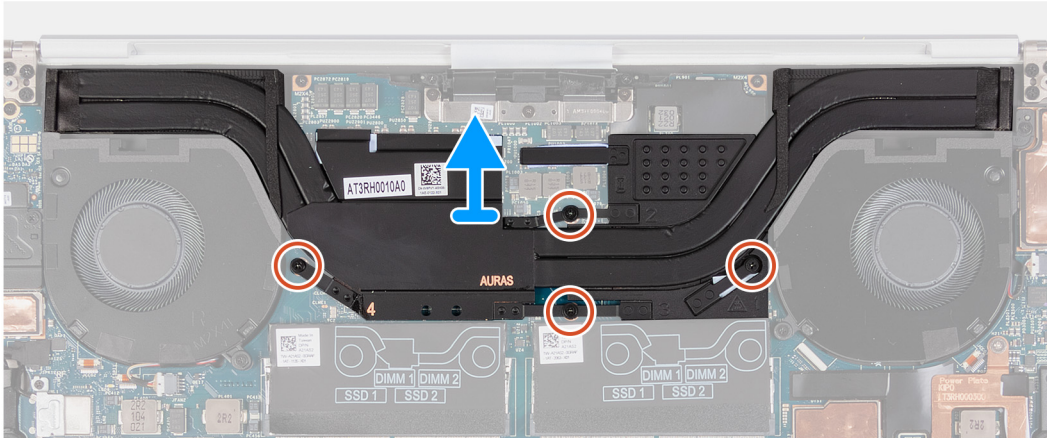
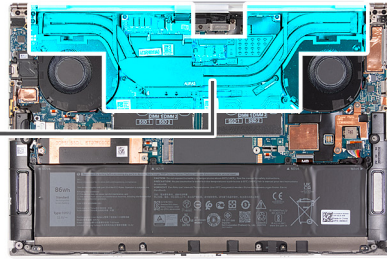

NOTE: This is the heat sink for computers with discrete Graphics Processing Units (GPUs).



3x

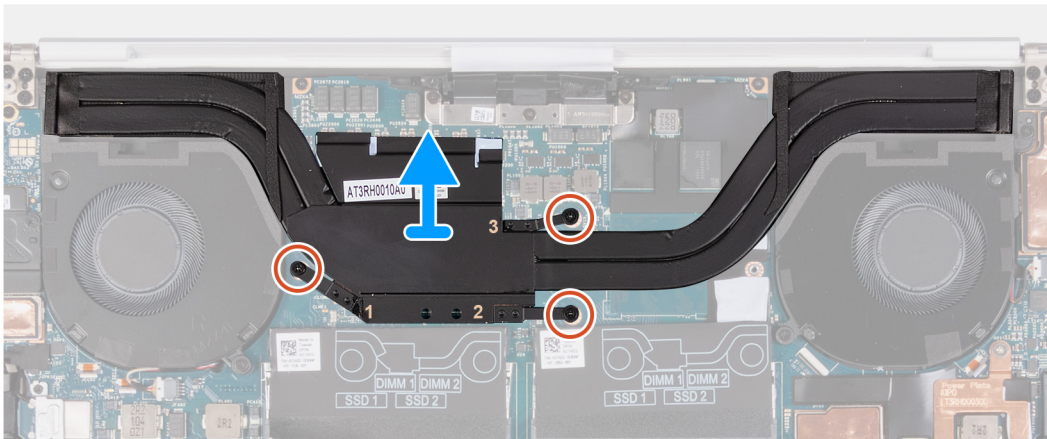
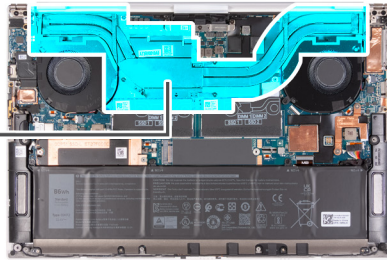

NOTE: This is the heat sink for computers without discrete Graphics Processing Units (GPUs).

Steps

1. In reverse sequential order (as indicated on the heat sink), loosen the four captive screws that secure the heat sink to the system board.

NOTE: The number of screws will vary depending on the graphics configuration of your computer.

- With discrete Graphics Processing Units: 4
- Without discrete Graphics Processing Units: 3

2. Lift the heat sink off the system board.

Installing the heat sink

Prerequisites

If you are replacing a component, remove the existing component before performing the installation procedure.

CAUTION: Incorrect alignment of the heat sink can damage the system board and processor.

NOTE: If either the system board or the heat sink is replaced, use the thermal pad or thermal paste provided in the kit to ensure that thermal conductivity is achieved.

About this task

The following image indicates the location of the heat sink and provides a visual representation of the installation procedure.

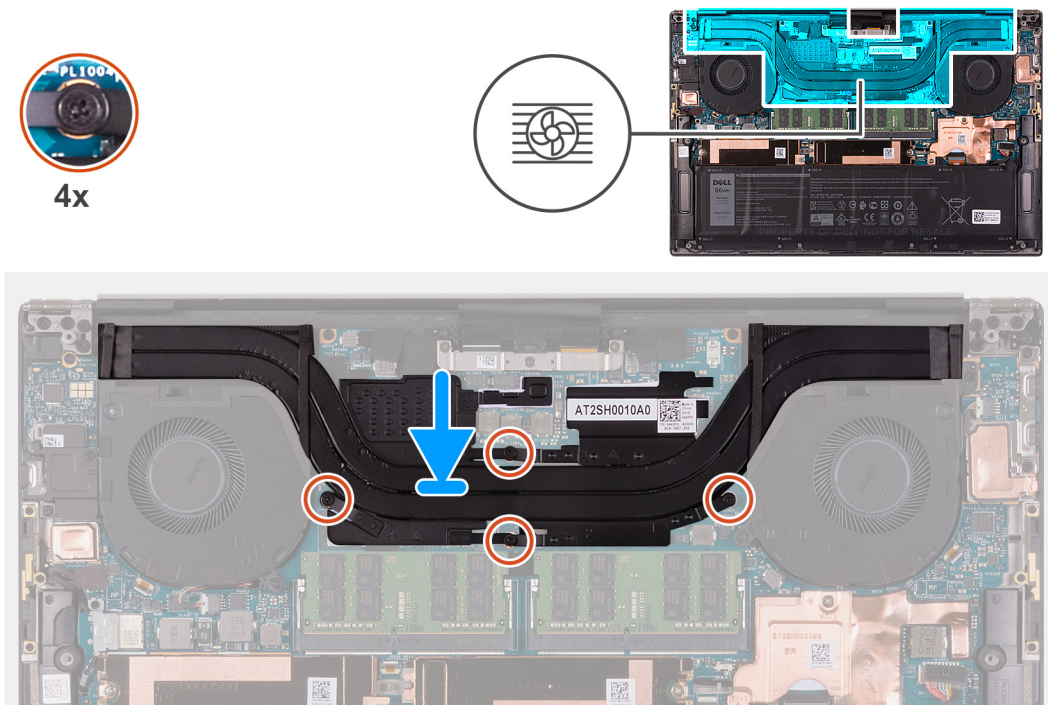

NOTE: This is the heat sink for computers with discrete Graphics Processing Units (GPUs).

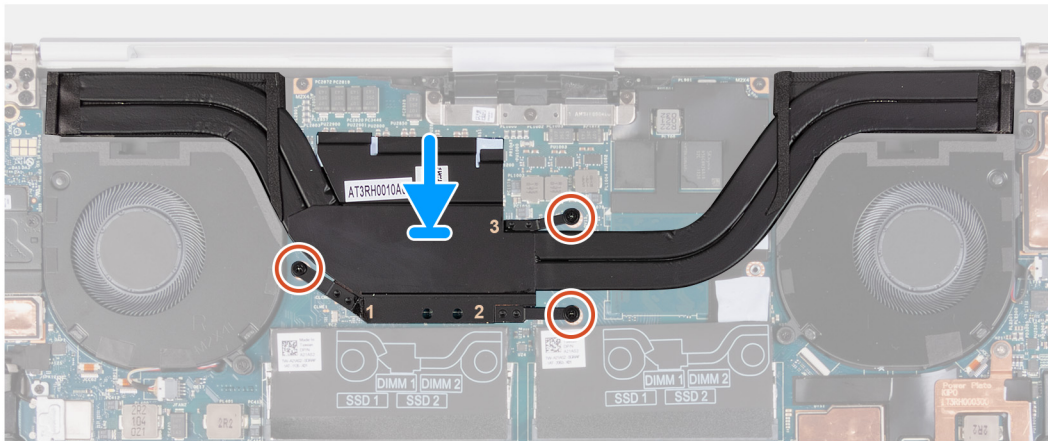
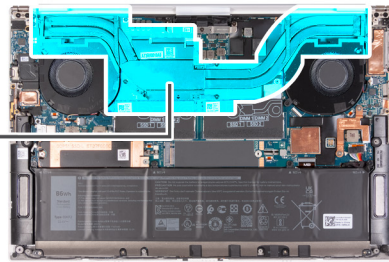

NOTE: This is the heat sink for computers without discrete Graphics Processing Units (GPUs).

Steps

1. Align the screw holes on the heat sink with the screw holes on the system board.
2. In sequential order (as indicated on the heat sink), tighten the four captive screws that secure the heat sink to the system board.

- NOTE:** The number of screws will vary depending on the graphics configuration of your computer.
- With discrete Graphics Processing Units: 4
 - Without discrete Graphics Processing Units: 3

Next steps

1. Install the [base cover](#).
2. Follow the procedure in [After working inside your computer](#).

Speakers

Removing the speakers

Prerequisites

1. Follow the procedure in [Before working inside your computer](#).
2. Remove the [base cover](#).

About this task

The following image indicates the location of the speakers and provides a visual representation of the removal procedure.

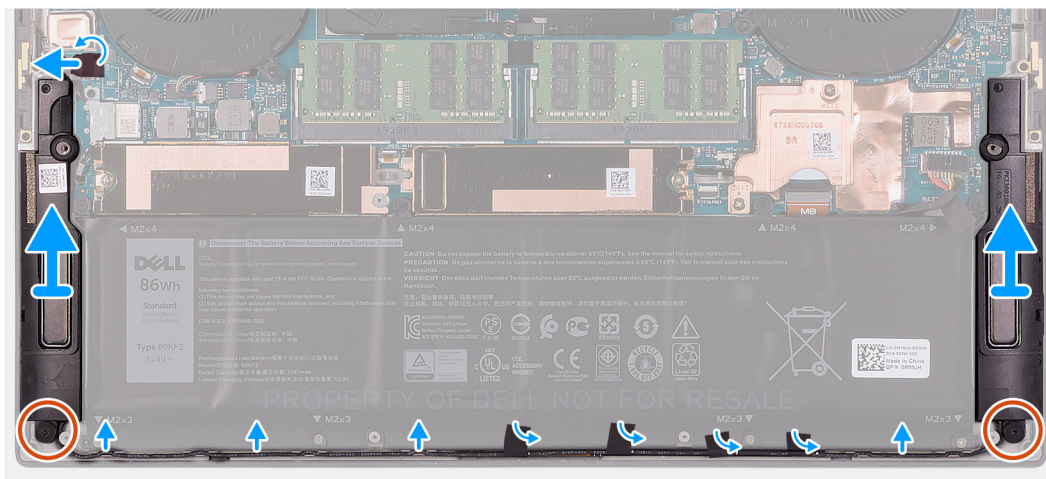
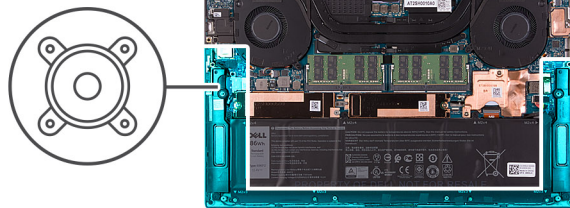

Steps

1. Peel the tape, and disconnect the speaker cable from the system board.
2. Peel the tapes that secure the speaker cable to the battery.
3. Remove the two screws (M2x2) that secure the speakers to the palm-rest and keyboard assembly.
4. Note the speaker cable routing, and remove the speaker cable from the routing guides on the palm-rest and keyboard assembly.
5. Lift the speakers, along with the cables, off the palm-rest and keyboard assembly.

Installing the speakers

Prerequisites

If you are replacing a component, remove the existing component before performing the installation procedure.

About this task

The following image indicates the location of the speakers and provides a visual representation of the installation procedure.

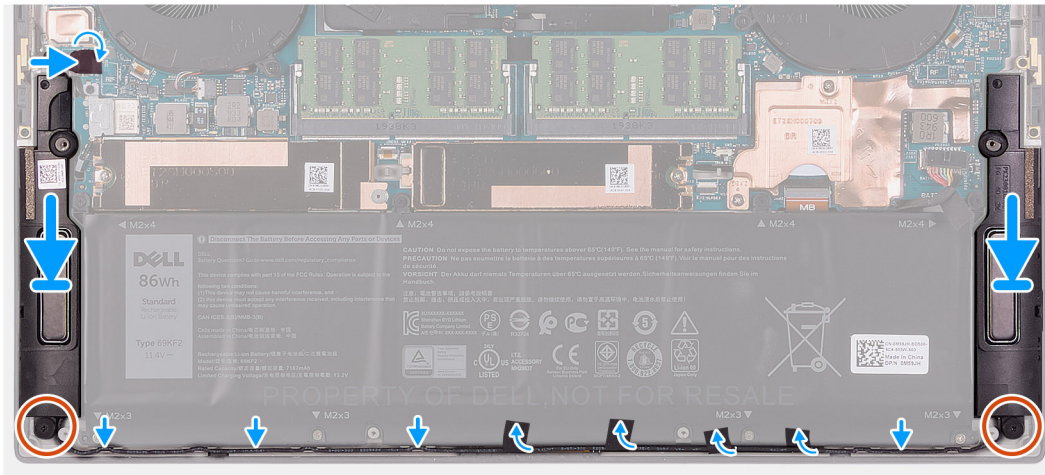
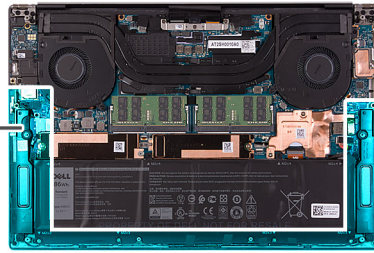
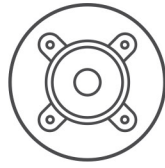

Steps

1. Using the alignment posts and rubber grommets, place the speakers on the slots of the palm-rest and keyboard assembly.
2. Route the speaker cable through the routing guides on the palm-rest and keyboard assembly.
3. Adhere the tapes that secure the speaker cable to the battery.
4. Replace the two screws (M2x2) that secures the speakers to the palm-rest and keyboard assembly.
5. Connect the speaker cable to the system board and adhere the tape that secures the speaker cable to the system board.

Next steps

1. Install the [base cover](#).
2. Follow the procedure in [After working inside your computer](#).

I/O board

Removing the I/O board

Prerequisites

1. Follow the procedure in [Before working inside your computer](#).
2. Remove the [base cover](#).
3. Remove the [right fan](#).

About this task

The following image indicates the location of the I/O board and provides a visual representation of the removal procedure.

 **NOTE:** The I/O board consists of the SD-card reader and the audio board.



2x
M2x4

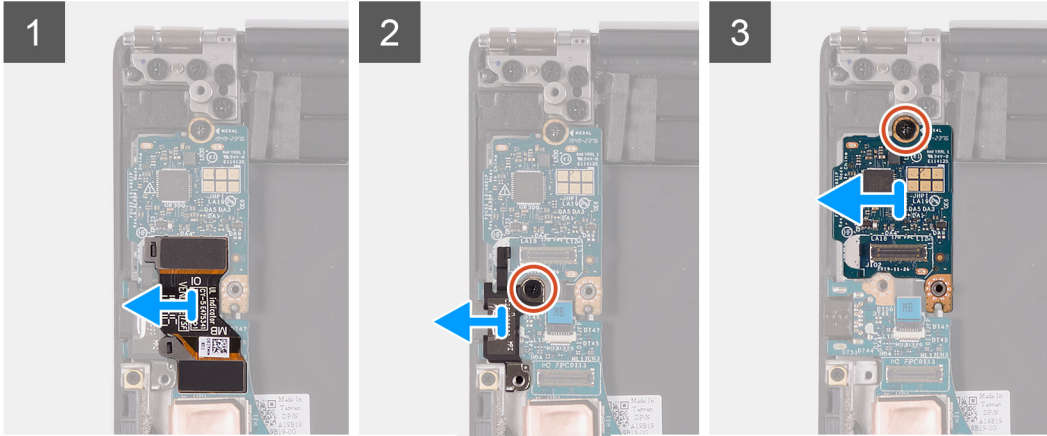
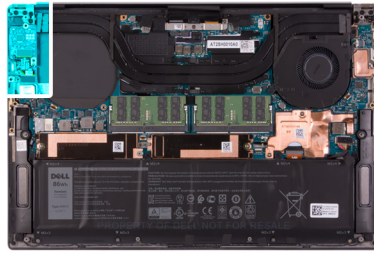

Steps

1. Disconnect the I/O-board cable from the system board and I/O board, then lift the I/O-board cable from the system board.
2. Remove the screw (M2x4) that secures the USB Type-C port bracket to the system board and lift the bracket off the I/O board.
3. Remove the screw (M2x4) securing the IO daughter board in place.
4. Lift the I/O board off the palm-rest and keyboard assembly.

Installing the I/O board

Prerequisites

If you are replacing a component, remove the existing component before performing the installation procedure.

About this task

The following image indicates the location of the I/O board and provides a visual representation of the installation procedure.

 **NOTE:** The I/O board consists of the SD-card reader and the audio board.



2x
M2x4

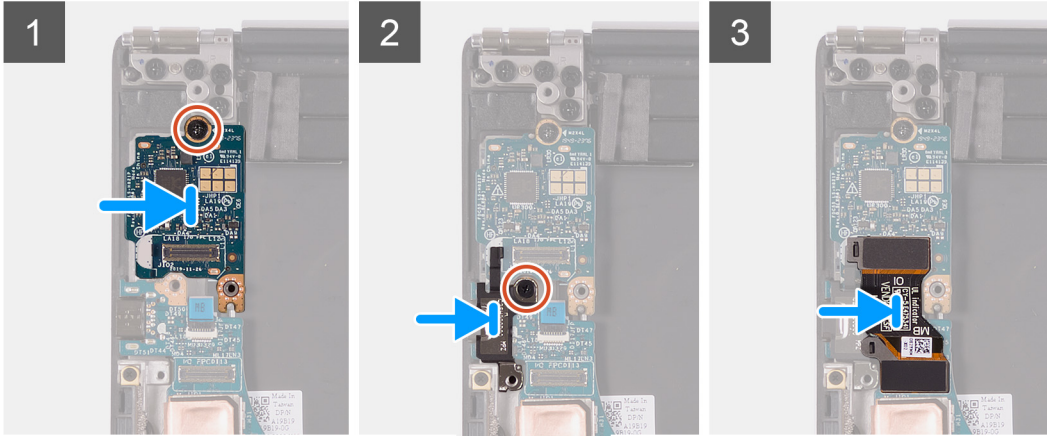
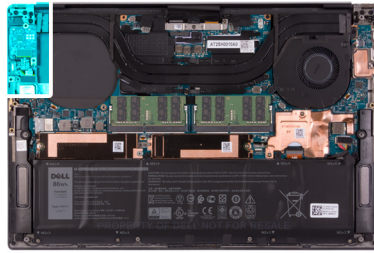

Steps

1. Place the I/O board on the palm-rest and keyboard assembly.
2. Connect the screw (M2x4) that secures the I/O board to the palm-rest and keyboard assembly.
3. Align the screw hole on the USB Type-C port bracket with the screw hole on the system board.
4. Connect the screw (M2x4) that secures the USB Type-C port bracket to the system board.
5. Connect the I/O-board cable to the connector on the system board and I/O board.

NOTE: Ensure to connect IO marked side of the I/O-board cable to the I/O daughter board and the side marked MB to the system board.



Next steps

1. Install the [right fan](#).
2. Install the [base cover](#).
3. Follow the procedure in [After working inside your computer](#).

Display assembly

Removing the display assembly

Prerequisites

1. Follow the procedure in [Before working inside your computer](#).
2. Remove the [base cover](#).

About this task

The following images indicate the location of the display assembly cable and display-assembly hinges and provide a visual representation of the removal procedure.



3x



2x
M1.6x3



8x
M2.5x5.5

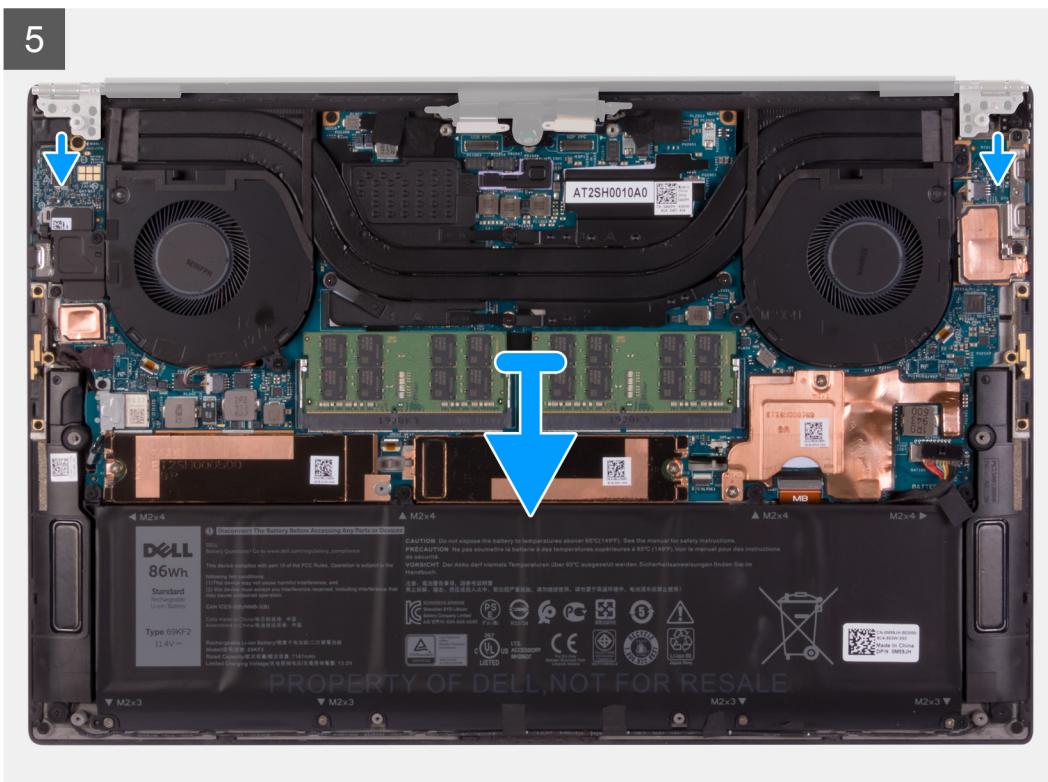
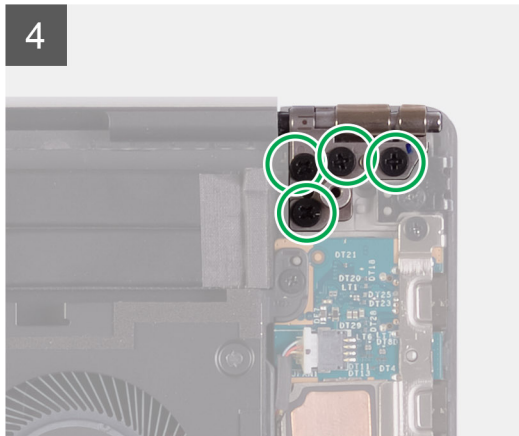
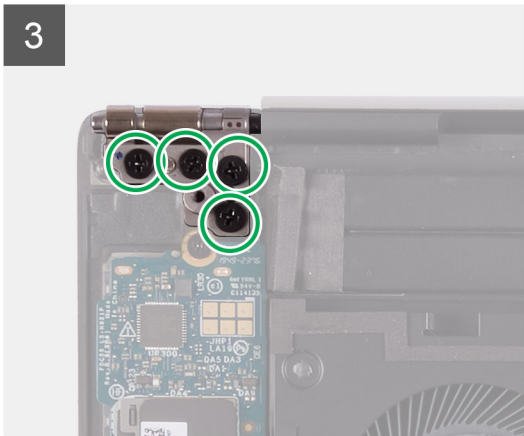
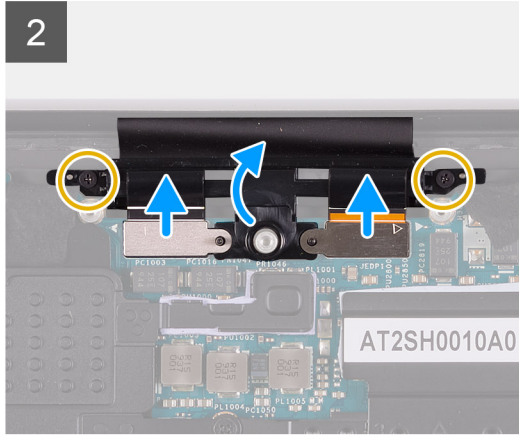
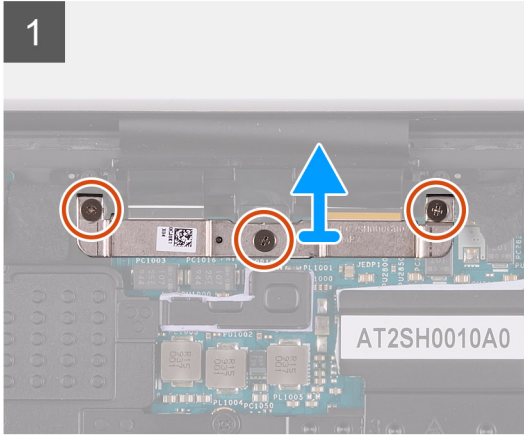
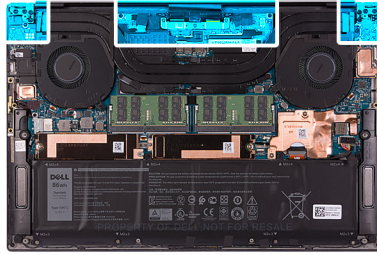

Steps

1. Loosen the three captive screws that secure the display-assembly cable bracket to the system board.
2. Lift the display-assembly cable bracket off the system board.
3. Remove the two screws (M1.6x3) that secure the display-assembly cable holder to the palm-rest and keyboard assembly.
4. Disconnect the touchscreen cable and camera cable.
5. Remove the eight screws (M2.5x5.5) that secure the left and right display-assembly hinges to the system board and the palm-rest and keyboard assembly.
6. Slide the palm-rest and keyboard assembly from the display assembly.
7. After performing all the above steps, you are left with display assembly.



NOTE: The display assembly is a Hinge-Up Design (HUD) assembly and cannot be further disassembled once it is removed from the bottom chassis. If any components in the display assembly are malfunctioning and need to be replaced, replace the entire display assembly.

Installing the display assembly

Prerequisites

If you are replacing a component, remove the existing component before performing the installation procedure.

About this task

The following images indicate the location of the display-assembly cable and display-assembly hinges and provide a visual representation of the installation procedure.

1

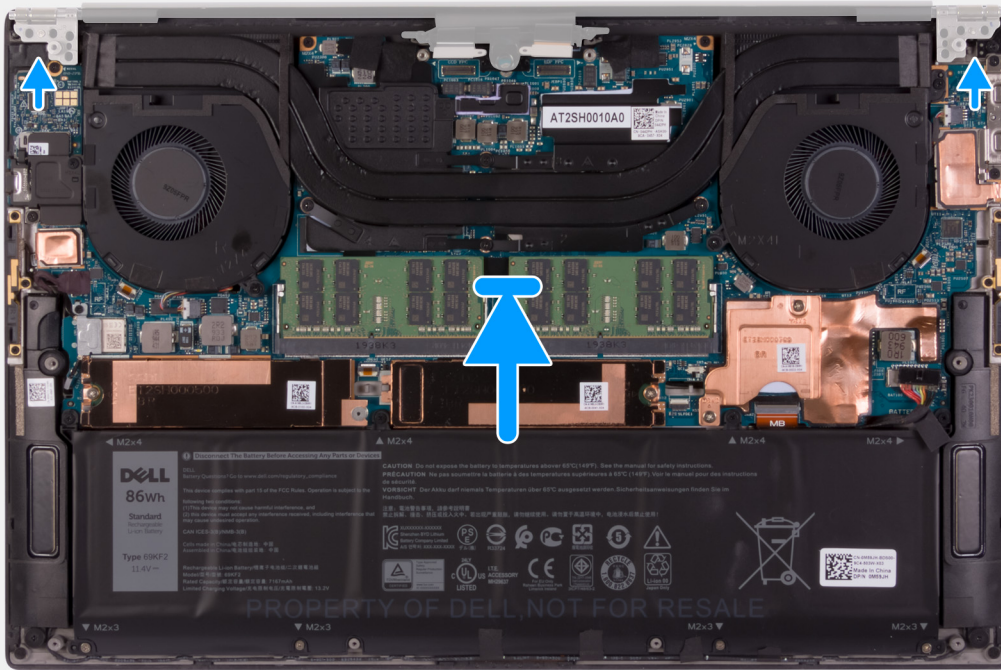

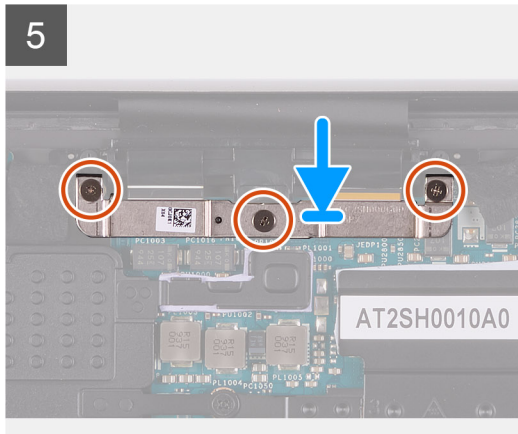
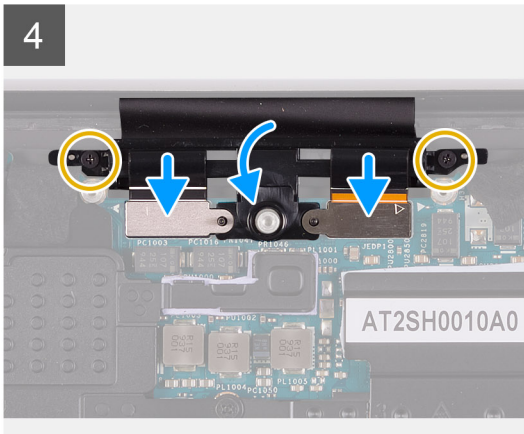
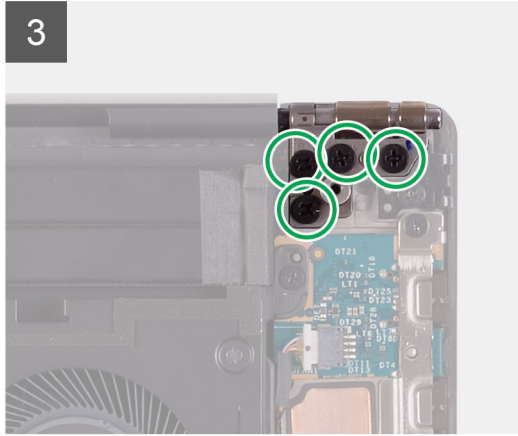
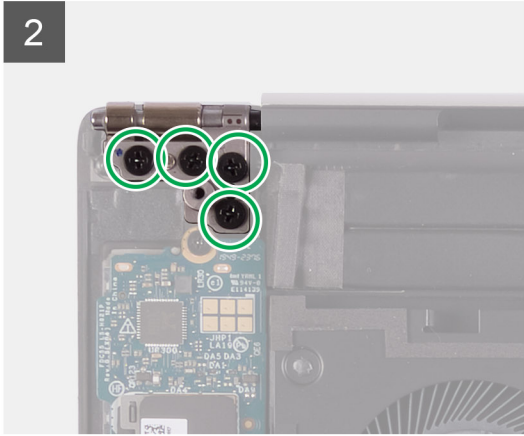
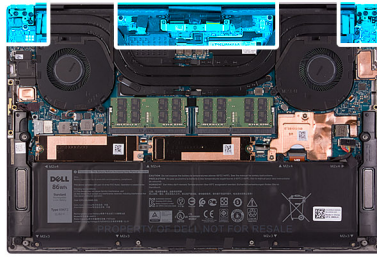
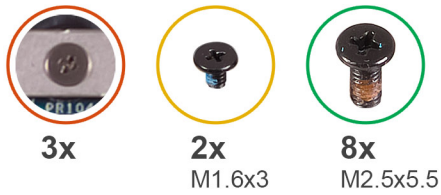

Steps

- Slide the palm-rest and keyboard assembly under the display-assembly hinges.
- Align the screw holes on the palm-rest assembly with the screw holes on the right and left display-assembly hinges.
- Replace the four screws (M2.5x5.5) that secure the left hinge to the system board and the palm-rest and keyboard assembly.
- Replace the four screws (M2.5x5.5) that secure the right hinge to the system board and the palm-rest and keyboard assembly.
- Align the screw holes on the display-assembly cable holder with the screw holes on the palm-rest and keyboard assembly.
- Connect the touchscreen cable and camera cable to the display-assembly cable .
- Replace the two screws (M1.6x3) that secure the display-assembly cable holder to the palm-rest and keyboard assembly.
 - NOTE:** Apply gentle torque when tightening the two screws (M1.6x3) to avoid damaging the screw threads.
- Align the screw holes on the display-assembly cable bracket with the screw holes on the system board.
- Tighten the three captive screws that secure the display-assembly cable bracket to the system board.

Next steps

- Install the [base cover](#).
- Follow the procedure in [After working inside your computer](#).

System board

Removing the system board

Prerequisites

1. Follow the procedure in [Before working inside your computer](#).

i **NOTE:** Before disconnecting the cables from the system board, note the location of the connectors so that you can reconnect the cables correctly after you replace the system board.

i **NOTE:** The Service Tag of your computer is stored in the system board. Enter the Service Tag in the BIOS setup program after you replace the system board.

i **NOTE:** Replacing the system board removes any changes that you have made to the BIOS using the BIOS setup program. Make the appropriate changes again after you replace the system board.

i **NOTE:** After your computer is reassembled and turned on, it prompts for the Real Time Clock (RTC) reset. When the RTC reset cycle occurs, the computer restarts several times and then an error message is displayed- "Time of day not set". Enter the BIOS when this error appears and set the date and time on your computer to resume normal functionality.

2. Remove the [base cover](#).

3. Remove the [battery](#).

4. Remove the [speakers](#).

5. Remove the [memory](#).

6. Remove the [solid state drive 1](#).

7. Remove the [solid state drive 2](#).

8. Remove the [heat sink](#).

i **NOTE:** The system board can be removed or installed together with the heat sink attached. This simplifies the procedure and avoids breaking the thermal bond between the system board and the heat sink.

9. Remove the [left fan](#).

10. Remove the [right fan](#).

11. Remove the [I/O board](#).

About this task

The following image indicates the connectors on your system board.

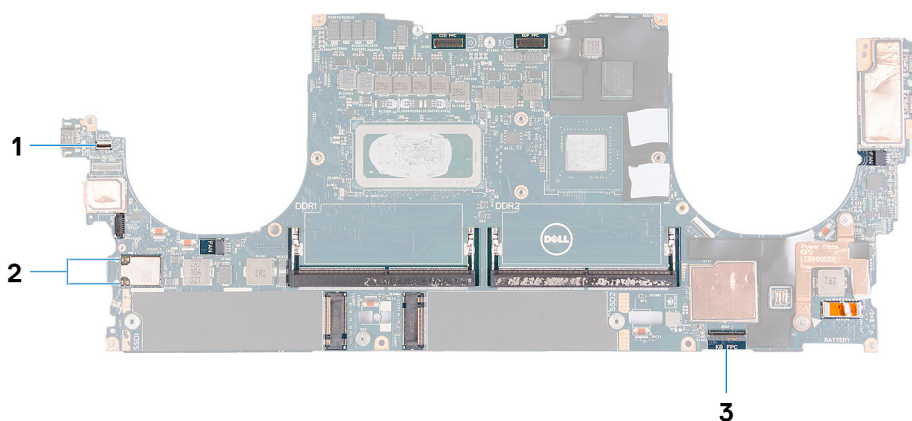
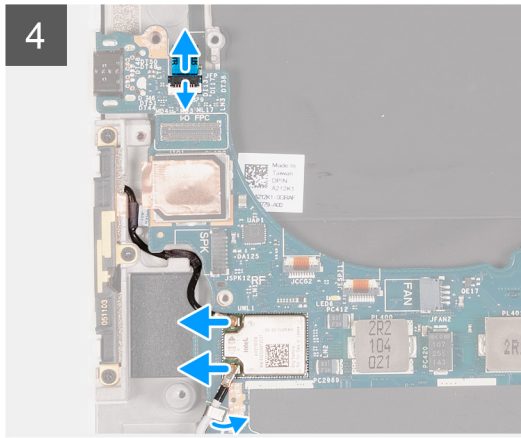
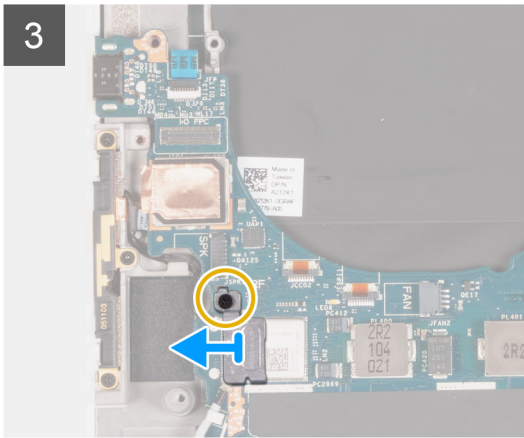
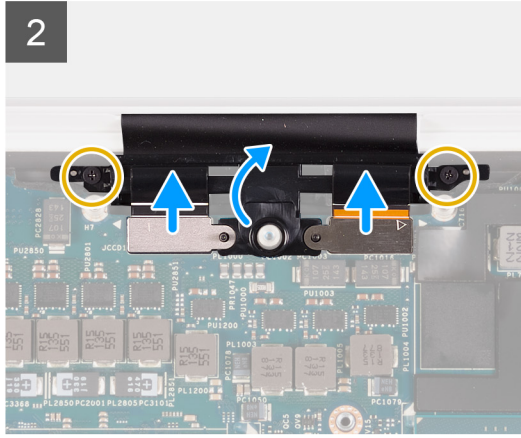
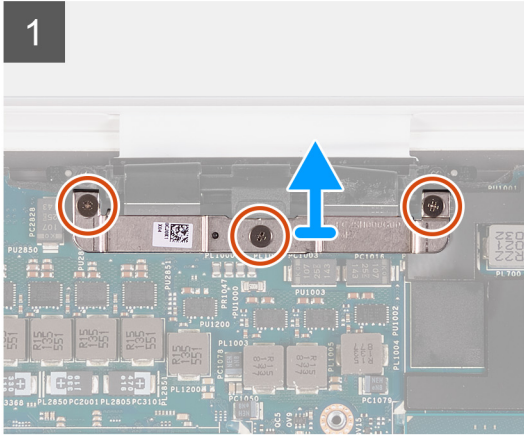
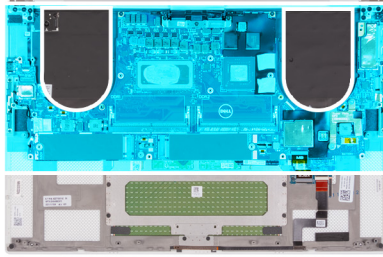
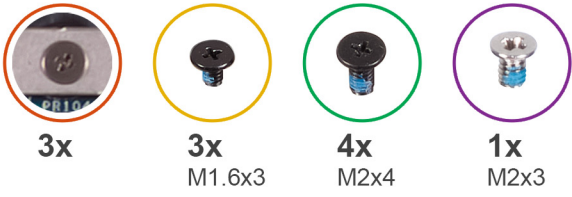
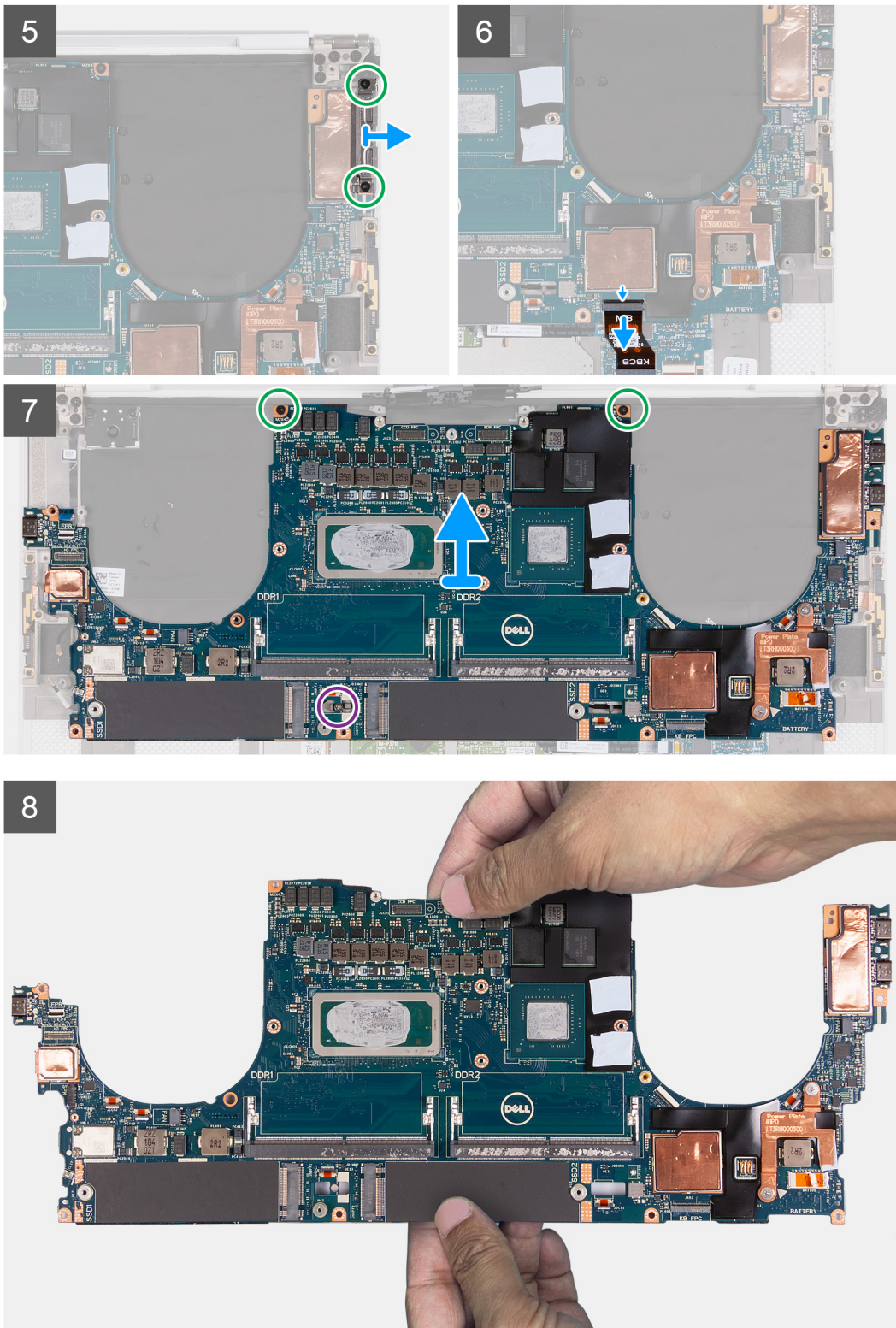

Figure 1. System-board connectors

1. Fingerprint reader-board cable
2. Antenna cables
3. Keyboard control-board cable

The following images indicate the location of the system board and provide a visual representation of the removal procedure.





Steps

1. Loosen the three captive screws that secure the camera and display-assembly cable bracket in place.
2. Lift the camera and display-assembly cable bracket off the system board.
3. Remove the two screws (M1.6x3) that secure the display-assembly cable holder to the palm-rest and keyboard assembly.
4. Disconnect the touch screen cable and camera cable.
5. Remove the screw (M1.6x3) that secures the wireless-card bracket to the system board.

6. Using a plastic scribe, disconnect the antenna cables from the wireless card. Unthread them from the clips on the system board.
7. Open the latch, and disconnect the fingerprint reader-board cable from the system board.
8. Disconnect the speaker cable from the system board.
9. Remove the screw (M2x4) that secures the right USB Type-C bracket to the palm-rest and keyboard assembly.
10. Lift the right USB Type-C bracket from the palm-rest and keyboard assembly.
11. Remove the two screws (M2x4) that secure the left USB Type-C bracket to the palm-rest and keyboard assembly.
12. Lift the left USB Type-C bracket from the palm-rest and keyboard assembly.

NOTE: Transfer the two USB Type-C brackets to the new replacement system board.

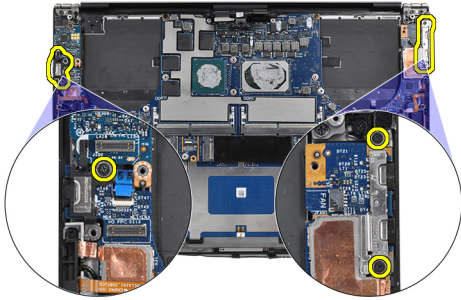

13. Open the latch, and disconnect the keyboard-control board cable from the system board.
14. Remove the single screw (M2x3) and the two screws (M2x4) that secure the system board to the palm-rest and keyboard assembly.

NOTE: The thermal plate is a part of the system board, DO NOT separate it from the system board.

15. Lift the system board off the palm-rest and keyboard assembly.

NOTE: When handling the system board, hold the system board firmly at the top and bottom. DO NOT hold the system board at the thin areas on the sides at the left and right.

Installing the system board

Prerequisites

If you are replacing a component, remove the existing component before performing the installation procedure.

NOTE: The Service Tag of your computer is stored in the system board. Enter the Service Tag in the BIOS setup program after you replace the system board.

NOTE: Replacing the system board removes any changes that you have made to the BIOS using the BIOS setup program. Make the appropriate changes again after you replace the system board.

NOTE: Replacing the system board removes any changes that you have made to the BIOS using the BIOS setup program. Make the appropriate changes again after you replace the system board. After your computer is reassembled and turned on, it prompts for the Real Time Clock (RTC) reset. When the RTC reset cycle occurs, the computer restarts several times and then an error message is displayed- "Time of day not set". Enter the BIOS when this error appears and set the date and time on your computer to resume normal functionality.

About this task

The following image indicates the connectors on your system board.

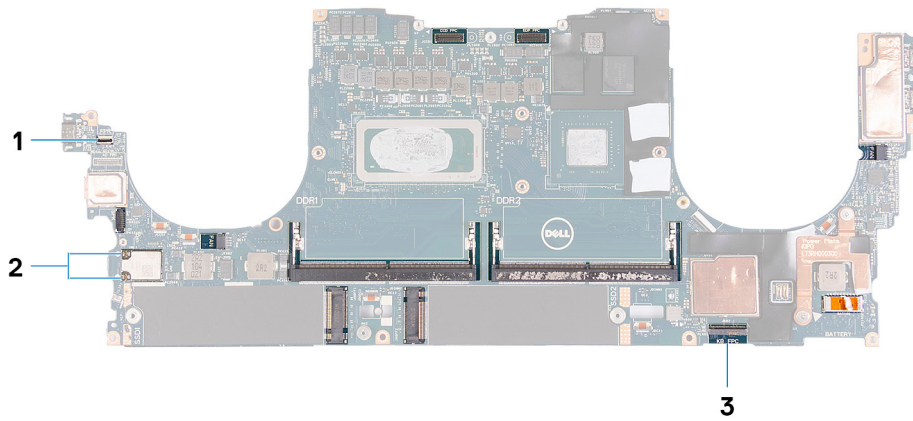

Figure 2. System-board connectors

1. Fingerprint reader-board cable
2. Antenna cables
3. Keyboard control-board cable

The following images indicate the location of the system board and provide a visual representation of the installation procedure.



3x



3x
M1.6x3



4x
M2x4



1x
M2x3

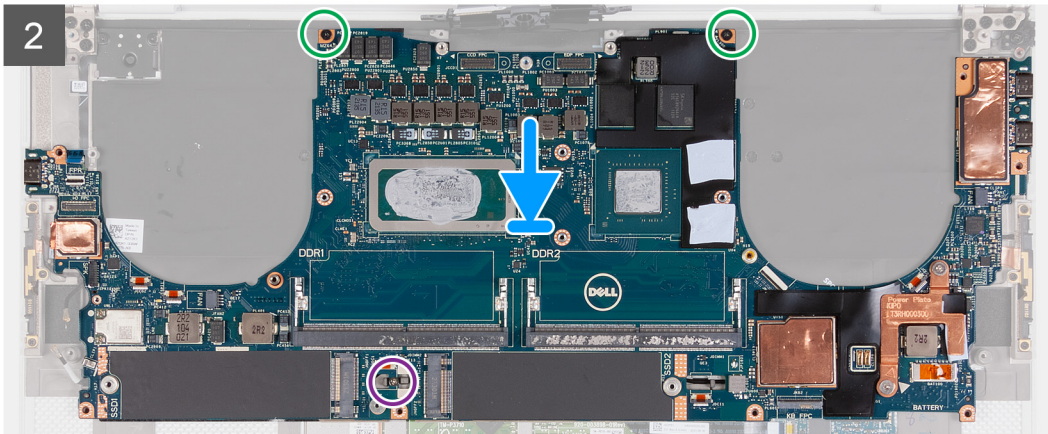
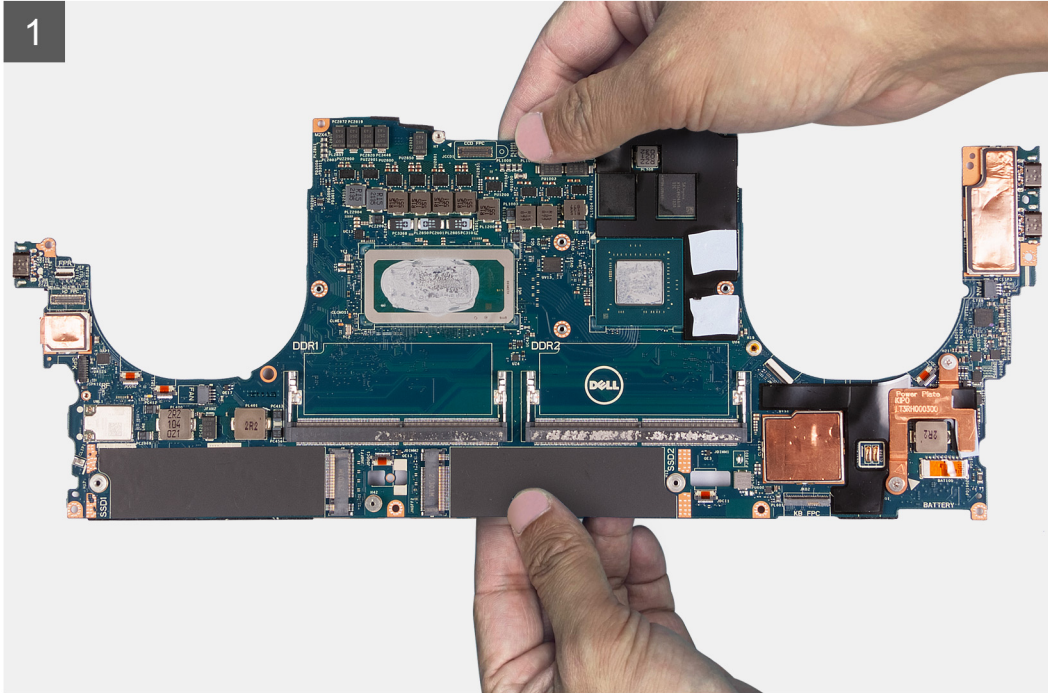
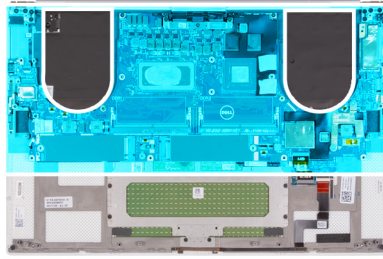

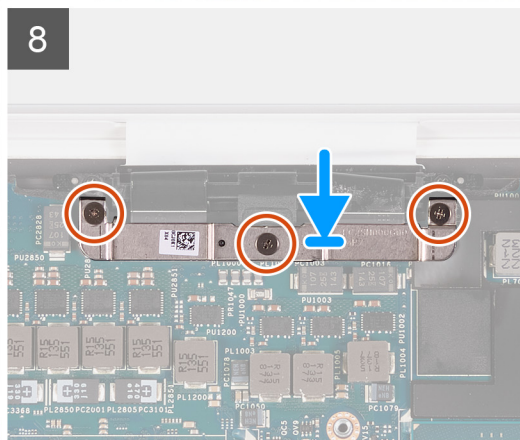
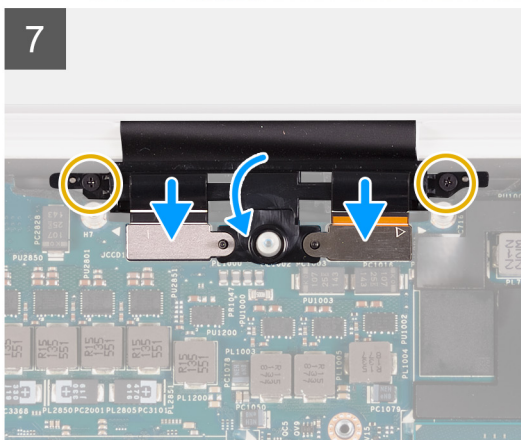
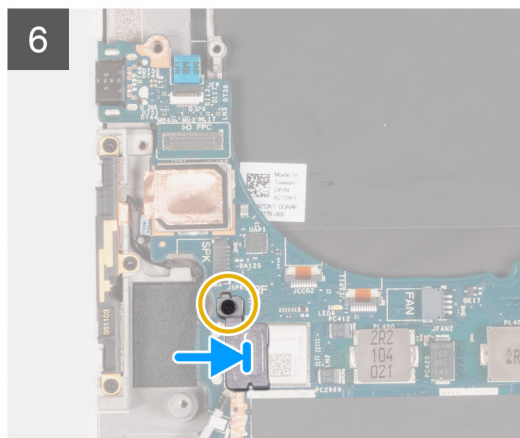
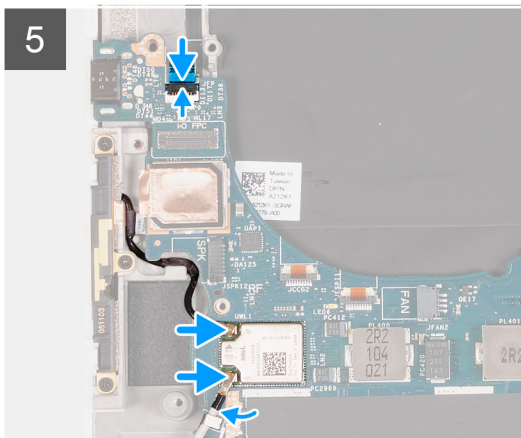
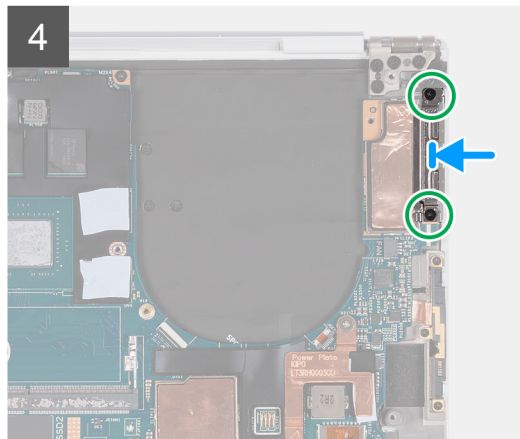
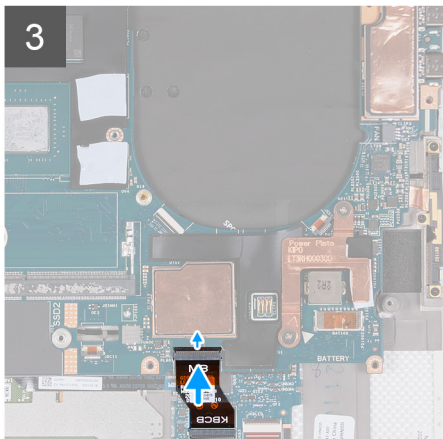

Steps

1. Hold the system board firmly at the top and bottom portions of the system board.

CAUTION: DO NOT hold the system board at the sides on the left and right as it will damage the system board.

2. Place the system board on the palm-rest and keyboard assembly.
3. Align the screw holes on the system board with the screw holes on the palm-rest and keyboard assembly.
4. Replace the two screws (M2x4) that secure the system board to the palm-rest and keyboard assembly.
5. Replace the single screw (M2x3) that secures the system board to the palm-rest and keyboard assembly.
6. Connect the keyboard-control board cable to the system board and close the latch to secure the cable.
7. Align the screw holes on the left Type-C bracket with the screw holes on the palm-rest and keyboard assembly.
8. Replace the two screws (M2x4) that secure the left Type-C bracket to the palm-rest and keyboard assembly.
9. Align the screw hole on the right Type-C bracket with the screw holes on the palm-rest and keyboard assembly.

10. Replace the screw (M2x4) that secures the right Type-C bracket to the palm-rest and keyboard assembly.
11. Connect the fingerprint reader-board cable to the system board and close the latch to secure the cable.
12. Connect the right speaker cable to the system board.
13. Connect the keyboard cable to the system board and close the latch to secure the cable.
14. Thread the antenna cables through the clips on the system board and connect them to the wireless card.
15. Align the screw hole on the wireless-card bracket with the screw hole on the system board.
16. Replace the screw (M1.6x3) that secures the wireless-card bracket to the system board.
17. Connect the touch screen cable and camera cable to the display-assembly cable .
18. Replace the two screws (M1.6x3) that secure the display-assembly cable holder to the palm-rest and keyboard assembly.
19. Connect the touch screen cable and camera cable to the display-assembly cable.
20. Align the screw holes on the display-assembly cable bracket with the screw holes on the system board.
21. Tighten the three captive screws that secure the display-assembly cable bracket to the system board.

Next steps

1. Install the [I/O board](#).
2. Install the [right fan](#).
3. Install the [left fan](#).
4. Install the [heat sink](#).
5. Install the [solid state drive 2](#).
6. Install the [solid state drive 1](#).
7. Install the [memory](#).
8. Install the [battery](#).
9. Install the [speakers](#).
10. Install the [base cover](#).
11. Follow the procedure in [After working inside your computer](#).

LED board

Removing the LED board

Prerequisites

1. Follow the procedure in [Before working inside your computer](#).
2. Remove the [base cover](#).
3. Remove the [battery](#)
4. Remove the [speakers](#)

About this task

The following images indicate the location of the LED board and provide a visual representation of the removal procedure.

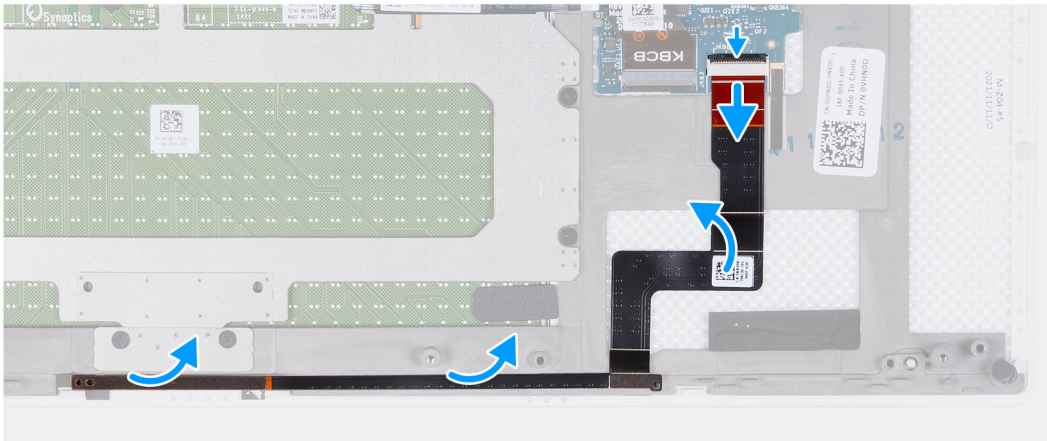
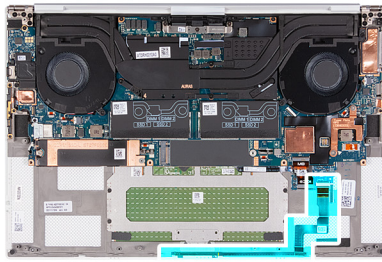

Steps

1. Open the latch and disconnect the LED board cable from the system board.
2. Peel off the LED-board cable from the palm-rest and keyboard assembly.
3. Note the LED board routing, and remove the LED board from the routing guides on the palm-rest and keyboard assembly.
4. Lift the LED board off the system board

Installing the LED board

Prerequisites

If you are replacing a component, remove the existing component before performing the installation procedure.

About this task

The following images indicate the location of the LED board and provide a visual representation of the installation procedure.

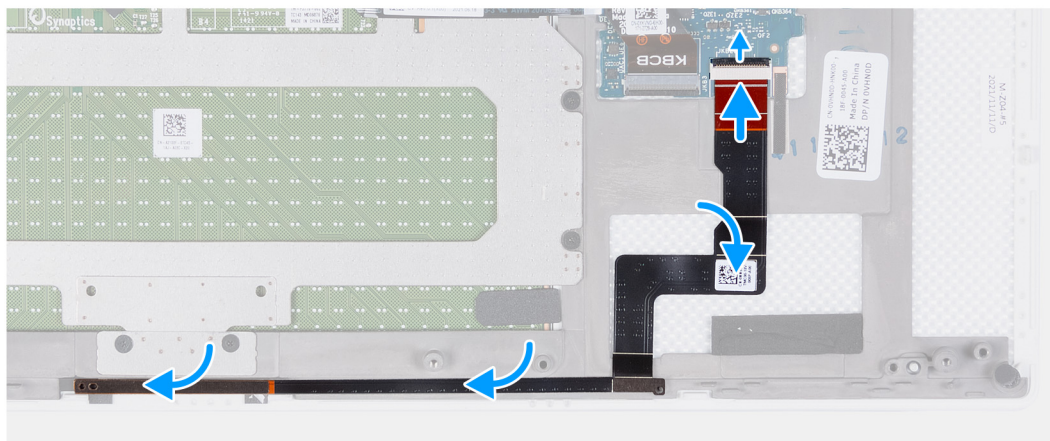
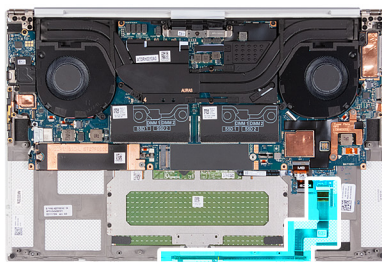

Steps

1. Place the LED board on the system board following the routing guide on the palm-rest and keyboard assembly.
2. Adhere the LED-board cable to the palm-rest and keyboard assembly.
3. Connect the LED-board cable to the system board and close the latch to secure the cable.

Next steps

1. Install the [speakers](#)
2. Install the [battery](#)
3. Install the [base cover](#).
4. Follow the procedure in [After working inside your computer](#).

Palm-rest and keyboard assembly

Removing the palm-rest and keyboard assembly

Prerequisites

1. Follow the procedure in [Before working inside your computer](#).
2. Remove the [base cover](#).
3. Remove the [battery](#).
4. Remove the [speakers](#).
5. Remove the [memory](#).
6. Remove the [solid state drive1](#).
7. Remove the [solid state drive2](#).
8. Remove the [heat sink](#).

NOTE: The system board can be removed or installed together with the heat sink attached. This simplifies the procedure and avoids breaking the thermal bond between the system board and the heat sink.

9. Remove the [right fan](#).
10. Remove the [left fan](#).
11. Remove the [I/O daughter board](#).
12. Remove the [display assembly](#).

13. Remove the [system board](#).

About this task

After performing all the pre-requisites, you are left with the palm-rest and keyboard assembly.

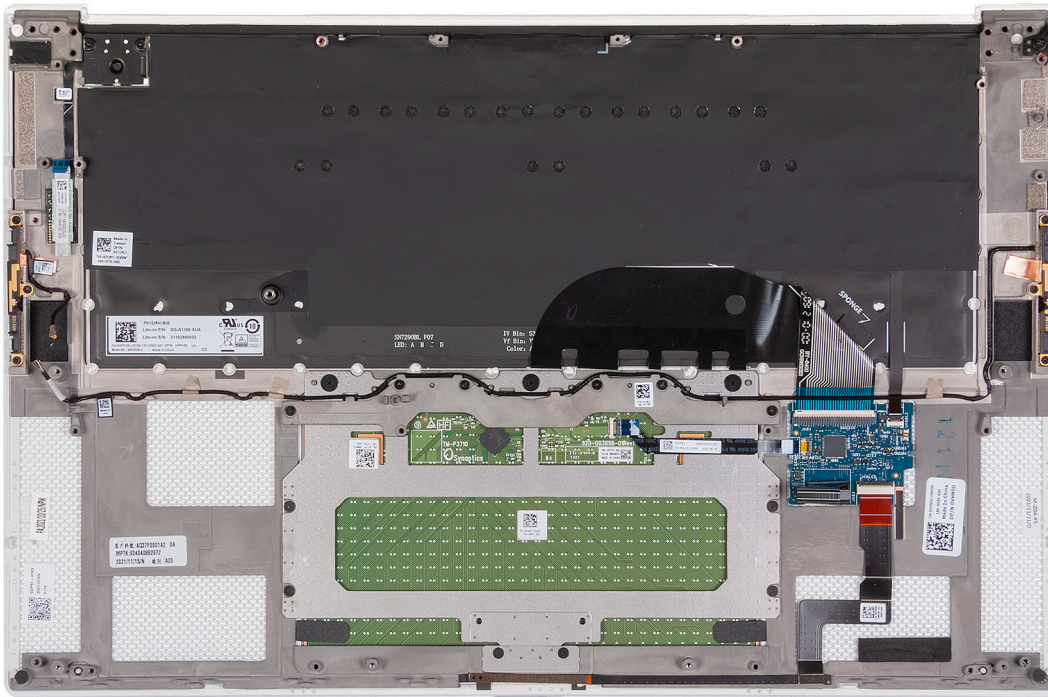

After performing the steps in the pre-requisites, you are left with the palm-rest and keyboard assembly.

Installing the palm-rest and keyboard assembly

Prerequisites

If you are replacing a component, remove the existing component before performing the installation procedure.

About this task

The following image indicates the palm-rest and keyboard assembly and provides a visual representation of the installation procedure.

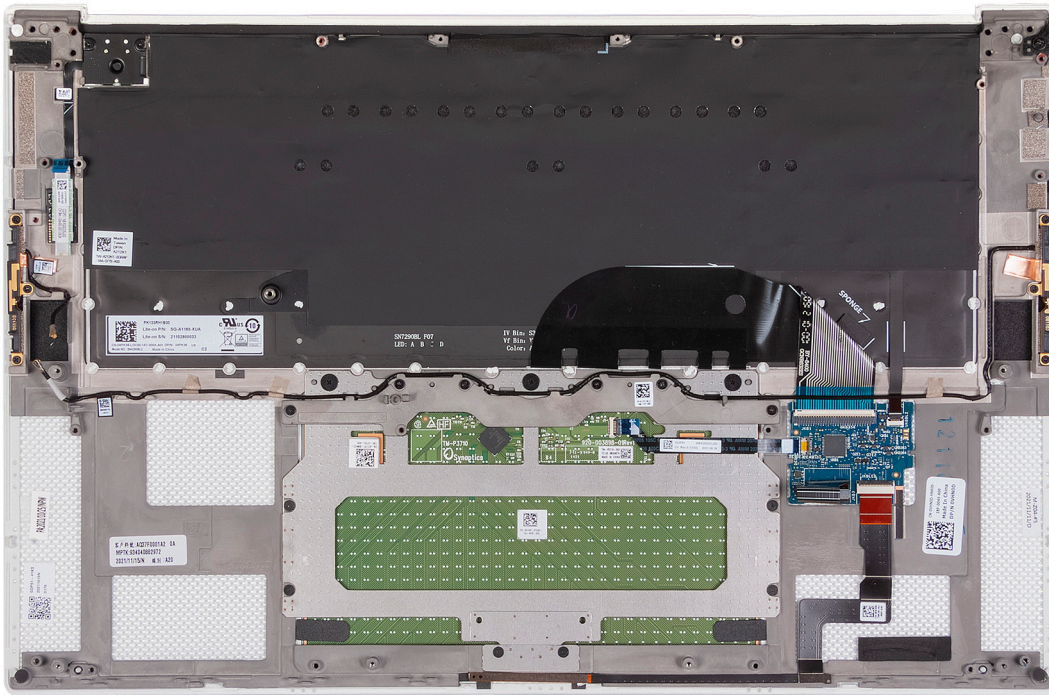

Steps

Place the palm-rest and keyboard assembly on a flat surface.

Next steps

1. Install the [system board](#).
2. Install the [display assembly](#).
3. Install the [I/O daughter board](#).
4. Install the [left fan](#).
5. Install the [right fan](#).
6. Install the [heat sink](#).
7. Install the [solid state drive2](#).
8. Install the [solid state drive1](#).
9. Install the [memory](#).
10. Install the [battery](#).
11. Install the [speakers](#).
12. Install the [base cover](#).
13. Follow the procedure in [After working inside your computer](#).

Drivers and downloads

When troubleshooting, downloading or installing drivers it is recommended that you read the Dell Knowledge Based article, Drivers and Downloads FAQ [000123347](#).

System setup

CAUTION: Unless you are an expert computer user, do not change the settings in the BIOS Setup program. Certain changes can make your computer work incorrectly.

NOTE: Depending on the computer and its installed devices, the items listed in this section may or may not be displayed.

NOTE: Before you change BIOS Setup program, it is recommended that you write down the BIOS Setup program screen information for future reference.

Use the BIOS Setup program for the following purposes:

- Get information about the hardware installed in your computer, such as the amount of RAM and the size of the hard drive.
- Change the system configuration information.
- Set or change a user-selectable option, such as the user password, type of hard drive installed, and enabling or disabling base devices.

Entering BIOS setup program

About this task

Turn on (or restart) your computer and press F2 immediately.

Navigation keys

NOTE: For most of the System Setup options, changes that you make are recorded but do not take effect until you restart the system.

Table 2. Navigation keys

Keys	Navigation
Up arrow	Moves to the previous field.
Down arrow	Moves to the next field.
Enter	Selects a value in the selected field (if applicable) or follow the link in the field.
Spacebar	Expands or collapses a drop-down list, if applicable.
Tab	Moves to the next focus area. NOTE: For the standard graphics browser only.
Esc	Moves to the previous page until you view the main screen. Pressing Esc in the main screen displays a message that prompts you to save any unsaved changes and restarts the system.

Boot Sequence

Boot Sequence allows you to bypass the System Setup–defined boot device order and boot directly to a specific device (for example: optical drive or hard drive). During the Power-on Self Test (POST), when the Dell logo appears, you can:

- Access System Setup by pressing F2 key

- Bring up the one-time boot menu by pressing F12 key

The one-time boot menu displays the devices that you can boot from including the diagnostic option. The boot menu options are:

- Removable Drive (if available)
- STXXXX Drive (if available)
- **i** **NOTE:** XXX denotes the SATA drive number.
- Optical Drive (if available)
- SATA Hard Drive (if available)
- Diagnostics

The boot sequence screen also displays the option to access the System Setup screen.

One time boot menu

To enter **one time boot menu**, turn on your computer, and then press F12 immediately.

i **NOTE:** It is recommended to shutdown the computer if it is on.

The one-time boot menu displays the devices that you can boot from including the diagnostic option. The boot menu options are:

- Removable Drive (if available)
- STXXXX Drive (if available)
- **i** **NOTE:** XXX denotes the SATA drive number.
- Optical Drive (if available)
- SATA Hard Drive (if available)
- Diagnostics

The boot sequence screen also displays the option to access the System Setup screen.

System setup options

i **NOTE:** Depending on this computer and its installed devices, the items that are listed in this section may or may not be displayed.

Table 3. System setup options—System information menu

Overview	
XPS 15 9520	
BIOS Version	Displays the BIOS version number.
Service Tag	Displays the Service Tag of the computer.
Asset Tag	Displays the Asset Tag of the computer.
Manufacture Date	Displays the manufacture date of the computer.
Ownership Date	Displays the ownership date of the computer.
Express Service Code	Displays the express service code of the computer.
Ownership Tag	Displays the ownership tag of the computer.
Signed Firmware Update	Displays whether the signed firmware update is enabled. Default: Enabled
Battery	
Primary	Displays the primary battery.
Battery Level	Displays the battery level.

Table 3. System setup options—System information menu (continued)

Overview	
Battery State	Displays the battery state.
Health	Displays the battery health.
AC Adapter	Displays whether an AC adapter is connected. If connected, the AC adapter type.
PROCESSOR	
Processor Type	Displays the processor type.
Maximum Clock Speed	Displays the maximum processor clock speed.
Minimum Clock Speed	Displays the minimum processor clock speed.
Current Clock Speed	Displays the current processor clock speed.
Core Count	Displays the number of cores on the processor.
Processor ID	Displays the processor identification code.
Processor L2 Cache	Displays the processor L2 Cache size.
Processor L3 Cache	Displays the processor L3 Cache size.
Microcode Version	Displays the microcode version.
Intel Hyper-Threading Capable	Displays whether the processor is Hyper-Threading (HT) capable.
64-Bit Technology	Displays whether 64-bit technology is used.
MEMORY	
Memory Installed	Displays the total computer memory installed.
Memory Available	Displays the total computer memory available.
Memory Speed	Displays the memory speed.
Memory Channel Mode	Displays single or dual channel mode.
Memory Technology	Displays the technology that is used for the memory.
DIMM SLOT 1	Displays the memory card installed in slot 1
DIMM SLOT 2	Displays the memory card installed in slot 2
DEVICES	
Panel Type	Displays the Panel Type of the computer.
Video Controller	Displays the integrate graphics information of the computer.
Video Memory	Displays the video memory information of the computer.
Wi-Fi Device	Displays the Wi-Fi device installed in the computer.
Native Resolution	Displays the native resolution of the computer.
Video BIOS Version	Displays the video BIOS version of the computer.
Audio Controller	Displays the audio controller information of the computer.
Bluetooth Device	Displays whether a Bluetooth device is installed in the computer.
Pass Through MAC Address	Displays the MAC address of the video pass-through.

Table 4. System setup options—Boot options menu

Boot options	
Boot Sequence	
Boot Mode: UEFI only	Displays the boot mode of this computer.
Boot Sequence	Displays the boot sequence.

Table 4. System setup options—Boot options menu (continued)

Boot options	
Secure Digital (SD) Card Boot	
Enable Secure Digital (SD) Card Boot	Enables or disables Secure Digital (SD) Card Boot Default: ON
Secure Boot	Enables or disables Secure Boot Default: OFF
Expert Key Management	Allows databases to be manipulated

Table 5. System setup options—Integrated Devices

Integrated Devices	
Date/Time	
Date	Sets the computer date in MM/DD/YYYY format. Changes to the date take effect immediately.
Time	Sets the computer time in HH/MM/SS 24-hour format. You can switch between 12-hour and 24-hour clock. Changes to the time take effect immediately.
Camera	
Enable camera	Enables or disables camera Default: CHECKED
Enable Audio	
Enable Audio	Enables or disables all integrated audio controller. Default: ON
Enable Microphone	Enables or disables microphone. By default, Enable Microphone is selected.
Enable Internal Speaker	Enables or disables internal speaker. By default, Enable Internal Speaker is selected.
USB/Thunderbolt Configuration	
USB/Thunderbolt Configuration	Enables or disables booting from USB mass storage devices such as external hard drive, optical drive, and USB drive. By default, Enable USB Boot Support is selected. By default, Enable External USB Ports is selected.
Enable Thunderbolt Technology Support	Enables or disables Thunderbolt Technology Support. Default: ON
Enable Thunderbolt Boot Support	Enables or disables Thunderbolt Boot Support. Default: OFF
EnableThunderbolt (and PCIe behind TBT) pre-boot modules	Enables or disables to allow or disallow PCIe devices to be connected through a Thunderbolt adapter during pre-boot. Default: OFF
Disable USB4 PCIE Tunneling	
Disable USB4 PCIE Tunneling	Enables or disables USB4 PCIE Tunneling. Default: OFF
Video/Power only on Type-C Ports	Limits TYpe-C functionality to video or power only

Table 5. System setup options—Integrated Devices (continued)

Integrated Devices	
	Default: OFF
Video/Power only on Type-C Ports	Enables or disables USB4 PCIe Tunneling.
	Default: OFF
Miscellaneous Devices	Enables or disables various onboard devices.
Enable Camera	Enables or disables the camera. By default, Enable Camera is selected.
Touchscreen	Enables or disables the touchscreen. By default, Touchscreen is selected.
Enable Fingerprint Reader Device	Enables or disables the Fingerprint Reader Device. By default, Enable Fingerprint Reader Device is selected.

Table 6. System setup options—Storage menu

Video	
SATA/NVMe Operation	
SATA/NVMe Operation	Sets the operating mode of the integrated storage device controller.
Storage Interface	
Port Enablement	Select to enable the devices.
Smart Reporting	
Enable Smart Reporting	Select to enable the Smart reporting.
Drive Information	
Drive Information	Provides the information of the drives installed in the computer.
Enable MediaCard	
Enable MediaCard	Select to enable or disable the media card

Table 7. System setup options—Security menu

Security	
Enable Admin Setup Lockout	Enables or disables the user from entering BIOS Setup when an Admin Password is set. Default: OFF
Password Bypass	Bypass the System (Boot) Password and the internal hard drive password prompts during a system restart. Default: Disabled
Enable Non-Admin Password Changes	Enables or disables the user to change the system and hard drive password without the need for admin password. Default: ON
Non-Admin Setup Changes	
Enable UEFI Capsule Firmware Updates	Enables or disables BIOS updates through UEFI capsule update packages. Default: ON
Absolute	Enables, disables or permanently disable the BIOS module interface of the optional Absolute Persistence Module service from Absolute Software.

Table 7. System setup options—Security menu (continued)

Security	
	Default: Enabled
TPM 2.0 Security On	Select whether or not the Trusted Platform Model (TPM) is visible to the OS. Default: ON
PPI Bypass for Enable Commands	Enables or disables the OS to skip BIOS Physical Presence Interface (PPI) user prompts when issuing TPM PPI enabled and activate commands. Default: OFF
PPI Bypass for Disable Commands	Enables or disables The OS to skip BIOS PPI user prompts when issuing TPM PPI Disable and Deactivate commands. Default: OFF
PPI Bypass for Clear Commands	Enables or disables the operating system to skip BIOS Physical Presence Interface (PPI) user prompts when issuing the Clear command. Default: OFF
Attestation Enable	Enables to control whether the TPM Endorsement Hierarchy is available to the OS. Disabling this setting restricts the ability to use the TPM for signature operations. Default: ON
Key Storage Enable	Enables to control whether the TPM Endorsement Hierarchy is available to the OS. Disabling this setting restricts the ability to use the TPM for storing owner data. Default: ON
SHA-256	Enables or disables the BIOS and the TPM to use the SHA-256 hash algorithm to extend measurements into the TPM PCRs during BIOS boot. Default: ON
Clear	Enables or disables the computer to clear the PTT owner information, and returns the PTT to the default state. Default: OFF
TPM State	Enables or disables the TPM. This is the normal operating state for the TPM when you want to use its complete array of capabilities. Default: Enabled
SMM Security Mitigation	Enables or disables additional UEFI SMM Security Mitigation protections. Default: OFF
	 NOTE: This feature may cause compatibility issues or loss of functionality with some legacy tools and applications.
Intel SGX	Enables or disables the Intel Software Guard Extensions (SGX) to provide a secured environment for running code/storing sensitive information. Default: Software Control

Table 8. System setup options—Passwords menu

Passwords	
Enable Strong Passwords	Enables or disables strong passwords. Default: OFF
Password Configuration	

Table 8. System setup options—Passwords menu (continued)

Passwords	
Admin Password Min	Specify the minimum number of characters allowed for Admin password. Default: 4
Admin Password Max	Specify the maximum number of characters allowed for Admin password. Default: 32
System Password Min	Specify the minimum number of characters allowed for System password. Default: 4
System Password Max	Specify the maximum number of characters allowed for System password. Default: 32
Admin Password	Sets, Changes, or deletes the administrator (admin) password (sometimes called the "setup" password).
System Password	Sets, Changes, or deletes the system password.
Enable Master Password Lockout	Enables or disables the master password support. Default: OFF

Table 9. System setup options—Secure Boot menu

Secure Boot	
Enable Secure Boot	Enables or disables the computer to boots using only validated boot software. Default: ON NOTE: For Secure Boot to be enabled, the computer needs to be in UEFI boot mode and the Enable Legacy Option ROMs option needs to be turned off.
Secure Boot Mode	Selects the Secure Boot operation mode. Default: Deployed Mode NOTE: Deployed Mode should be selected for normal operation of Secure Boot.

Table 10. System setup options—Expert Key Management menu

Expert Key Management	
Enable Custom Mode	Enables or disables the keys in the PK, KEK, db, and dbx security key databases to be modified. Default: OFF
Custom Mode Key Management	Selects the custom values for expert key management. Default: PK

Table 11. System setup options—Performance menu

Performance	
Multi-Core Support	
Active Cores	Changes the number of CPU cores available to the operating system. The default value is set to the maximum number of cores. Default: All Cores
Intel SpeedStep	

Table 11. System setup options—Performance menu (continued)

Performance	
Enable Intel SpeedStep Technology	Enables or disables the Intel SpeedStep Technology to dynamically adjust processor voltage and core frequency, decreasing average power consumption and heat production. Default: ON
Enable C-State Control	Enables or disables the CPU's ability to enter and exit low-power states. Default: ON
Intel Turbo Boost Technology	
Enable Intel Turbo Boost Technology	Enabled or disabled the Intel TurboBoost mode of the processor. If enabled, the Intel TurboBoost driver increases the performance of the CPU or graphics processor. Default: ON
Intel Hyper-Threading Technology	
Enable Intel Hyper-Threading Technology	Enabled or disabled the Intel Hyper-Threading mode of the processor. If enabled, the Intel Hyper-Threading increases the efficiency of the processor resources when multiple threads run on each core. Default: ON

Table 12. System setup options—Power Management menu

Power Management	
Wake on AC	Enables the computer to turn on and go to boot when AC power is supplied to the computer. Default: OFF
Wake on Dell USB Type-C Dock	Enables connecting a Dell USB Type-C Dock to wake the computer from Standby. Default: ON
Auto On Time	Enables the computer to automatically power on for defined days and times. Default: Disabled. The system will not automatically power up.
Block Sleep	Blocks the computer from entering Sleep (S3) mode in the operating system. Default: OFF NOTE: If enabled, the computer will not go to sleep, Intel Rapid Start will be disabled automatically, and the operating system power option will be blank if it was set to Sleep.
Battery Charge Configuration	Enables the computer to run on battery during power usage hours. Use the below options to prevent AC power usage between certain times of each day. Default: Adaptive. Battery settings are adaptively optimized based on your typical battery usage pattern.
Enable Advanced Battery Charge Configuration	Enables Advanced Battery Charge Configuration from the beginning of the day to a specified work period. Advanced Battery Charged maximizes battery health while still supporting heavy use during the work day. Default: OFF
Peak Shift	Enables the computer to run on battery during peak power usage hours. Default: OFF
Wireless Radio Control	

Table 12. System setup options—Power Management menu (continued)

Power Management	
Control WLAN radio	Enables to sense the connection of the computer to a wired network and subsequently disable the selected wireless radios (WLAN and/or WWAN). Upon disconnection from the wired network, the selected wireless radios are re-enabled. Default: OFF
Wake on LAN	Enables or disables the computer to turn on by a special LAN signal. Default: Disabled
Intel Speed Shift Technology	Enables or disables the Intel Speed Shift Technology support. Setting this option to enable allows the operating system to select the appropriate processor performance automatically. Default: ON
Lid Switch	
Power On Lid Open	Enables the computer to power up from the off state whenever the lid is opened. Default: ON

Table 13. System setup options—Wireless menu

Wireless	
Wireless Device Enable	Enable or disable internal WLAN/Bluetooth devices. By default, WLAN is selected. By default, Bluetooth is selected.

Table 14. System setup options—POST Behavior menu

POST Behavior	
Numlock Enable	
Enable Numlock	Enables or disables Numlock when the computer boots. Default: ON
Fn Lock	
	Enables or disables the Fn lock mode. Default: ON
Lock Mode	Default: Lock Mode Secondary. Lock Mode Secondary = If this option is selected, the F1-F12 keys scan the code for their secondary functions.
Warnings and Errors	
	Selects an action on encountering a warning or error during boot. Default: Prompt on Warnings and Errors. Stop, prompt, and wait for user input when warnings or errors are detected.
	NOTE: Errors deemed critical to the operation of the computer hardware will always halt the computer.
Enable Adapter Warnings	
	Enables or disables the computer to display adapter warning messages when adapters with too little power capacity are detected. Default: ON
Enable Dock Warning Messages	
	Enables or disables dock warning messages. Default: ON
Fastboot	
	Configures the speed of the UEFI boot process.

Table 14. System setup options—POST Behavior menu (continued)

POST Behavior	
	Default: Thorough. Performs complete hardware and configuration initialization during boot.
Extend BIOS POST Time	Configures the BIOS POST (Power-On Self-Test) load time. Default: 0 seconds
Full Screen Logo	Enabled or disabled the computer to display full screen logo if the image match screen resolution. Default: OFF
Mouse/Touchpad	Defines how the computer handles mouse and touchpad input. Default: Touchpad and PS/2 Mouse. Leave the integrated touchpad enabled when an external PS/2 mouse is present.
Sign of Life	
Early Logo Display	Display Logo Sign of Life. Default: ON
Early Keyboard Backlight	Keyboard Backlight Sign of Life. Default: ON
MAC Address Pass-Through	Replaces the external NIC MAC address (in a supported dock or dongle) with the selected MAC address from the computer. Default: System Unique MAC Address.

Table 15. System setup options—Virtualization menu

Virtualization	
Intel Virtualization Technology	Enables the computer to run a virtual machine monitor (VMM). Default: ON
VT for Direct I/O	Enables the computer to perform Virtualization Technology for Direct I/O (VT-d). VT-d is an Intel method that provides virtualization for memory map I/O. Default: ON

Table 16. System setup options—Maintenance menu

Maintenance	
Asset Tag	
Asset Tag	Creates a system Asset Tag that can be used by an IT administrator to uniquely identify a particular system. Once set in BIOS, the Asset Tag cannot be changed.
Service Tag	Displays the Service Tag of the computer.
BIOS Recovery from Hard Drive	
	Enables the computer to recover from a bad BIOS image, as long as the Boot Block portion is intact and functioning. Default: ON
	NOTE: BIOS recovery is designed to fix the main BIOS block and cannot work if the Boot Block is damaged. In addition, this feature cannot work in the event of EC corruption, ME corruption, or a hardware issue. The recovery image must exist on an unencrypted partition on the drive.
BIOS Auto-Recovery	Enables the computer to automatically recover the BIOS without user actions. This feature requires BIOS Recovery from Hard Drive to be set to Enabled.

Table 16. System setup options—Maintenance menu (continued)

Maintenance	
	Default: OFF
Start Data Wipe	<p> CAUTION: This Secure Wipe Operation deletes information in a way that it cannot be reconstructed.</p> <p>If enabled, the BIOS will queue up a data wipe cycle for storage devices that are connected to the motherboard on the next reboot.</p> <p>Default: OFF</p>
Allow BIOS Downgrade	<p>Controls flashing of the system firmware to previous revisions.</p> <p>Default: ON</p>

Table 17. System setup options—System Logs menu

System Logs	
Power Event Log	
Clear POWER Event Log	<p>Select keep or clear Power events.</p> <p>Default: Keep</p>
BIOS Event Log	
Clear Bios Event Log	<p>Select keep or clear BIOS events.</p> <p>Default: Keep</p>
Thermal Event Log	
Clear Thermal Event Log	<p>Select keep or clear Thermal events.</p> <p>Default: Keep</p>

Table 18. System setup options—SupportAssist menu

SupportAssist	
Dell Auto OS Recovery Threshold	<p>Controls the automatic boot flow for SupportAssist System Resolution Console and for Dell operating system Recovery tool.</p> <p>Default: 2.</p>
SupportAssist OS Recovery	<p>Enables or disables the boot flow for SupportAssist operating system Recovery tool in the even of certain system errors.</p> <p>Default: ON</p>
BIOSConnect	<p>Enables or disables cloud Service OS recover if the main operating system fails to boot with the number of failures equal to or greater than the value specified by the Auto OS Recovery Threshold setup option.</p> <p>Default: ON</p>

System and setup password

Table 19. System and setup password

Password type	Description
System password	Password that you must enter to log in to your system.
Setup password	Password that you must enter to access and make changes to the BIOS settings of your computer.

You can create a system password and a setup password to secure your computer.

 **CAUTION:** The password features provide a basic level of security for the data on your computer.

 **CAUTION:** Anyone can access the data that is stored on your computer if it is not locked and left unattended.

 **NOTE:** System and setup password feature is disabled.

Assigning a system setup password

Prerequisites

You can assign a new **System or Admin Password** only when the status is in **Not Set**.

About this task

To enter the system setup, press F12 immediately after a power-on or reboot.

Steps

1. In the **System BIOS** or **System Setup** screen, select **Security** and press Enter.
The **Security** screen is displayed.
2. Select **System/Admin Password** and create a password in the **Enter the new password** field.
Use the following guidelines to assign the system password:
 - A password can have up to 32 characters.
 - At least one special character: ! " # \$ % & ' () * + , - . / : ; < = > ? @ [\] ^ _ ` { | }
 - Numbers 0 through 9.
 - Upper case letters from A to Z.
 - Lower case letters from a to z.
3. Type the system password that you entered earlier in the **Confirm new password** field and click **OK**.
4. Press Esc and save the changes as prompted by the pop-up message.
5. Press Y to save the changes.
The computer restarts.

Deleting or changing an existing system setup password

Prerequisites

Ensure that the **Password Status** is Unlocked (in the System Setup) before attempting to delete or change the existing System and/or Setup password. You cannot delete or change an existing System or Setup password, if the **Password Status** is Locked.

About this task

To enter the System Setup, press F12 immediately after a power-on or reboot.

Steps

1. In the **System BIOS** or **System Setup** screen, select **System Security** and press Enter.
The **System Security** screen is displayed.
2. In the **System Security** screen, verify that **Password Status** is **Unlocked**.
3. Select **System Password**, update, or delete the existing system password, and press Enter or Tab.
4. Select **Setup Password**, update, or delete the existing setup password, and press Enter or Tab.
 **NOTE:** If you change the System and/or Setup password, reenter the new password when prompted. If you delete the System and/or Setup password, confirm the deletion when prompted.
5. Press Esc and a message prompts you to save the changes.
6. Press Y to save the changes and exit from System Setup.

The computer restarts.

Clearing CMOS settings

About this task

 **CAUTION:** Clearing CMOS settings will reset the BIOS settings on your computer.

Steps

1. Turn off your computer.
2. Remove the [base cover](#).

 **NOTE:** The battery must be disconnected from the system board. See step 3 in [removing base cover](#).

3. Press and hold the power button for 15 seconds to drain the flea power.
4. Before you turn on your computer, follow the steps in [installing the base cover](#).
5. Turn on your computer.

Clearing BIOS (System Setup) and System passwords

About this task

To clear the system or BIOS passwords, contact Dell technical support as described at www.dell.com/contactdell.

 **NOTE:** For information on how to reset Windows or application passwords, refer to the documentation accompanying Windows or your application.

Updating the BIOS

Updating the BIOS in Windows

Steps

1. Go to www.dell.com/support.
2. Click **Product support**. In the **Search support** box, enter the Service Tag of your computer, and then click **Search**.

 **NOTE:** If you do not have the Service Tag, use the SupportAssist feature to automatically identify your computer. You can also use the product ID or manually browse for your computer model.

3. Click **Drivers & Downloads**. Expand **Find drivers**.
4. Select the operating system installed on your computer.
5. In the **Category** drop-down list, select **BIOS**.
6. Select the latest version of BIOS, and click **Download** to download the BIOS file for your computer.
7. After the download is complete, browse the folder where you saved the BIOS update file.
8. Double-click the BIOS update file icon and follow the on-screen instructions.

For more information, see knowledge base article [000124211](https://www.dell.com/support/000124211) at www.dell.com/support.

Updating the BIOS using the USB drive in Windows

Steps

1. Follow the procedure from step 1 to step 6 in [Updating the BIOS in Windows](#) to download the latest BIOS setup program file.
2. Create a bootable USB drive. For more information, see the knowledge base article [000145519](https://www.dell.com/support/000145519) at www.dell.com/support.
3. Copy the BIOS setup program file to the bootable USB drive.

4. Connect the bootable USB drive to the computer that needs the BIOS update.
5. Restart the computer and press **F12**.
6. Select the USB drive from the **One Time Boot Menu**.
7. Type the BIOS setup program filename and press **Enter**.
The **BIOS Update Utility** appears.
8. Follow the on-screen instructions to complete the BIOS update.

Updating the BIOS from the F12 One-Time boot menu

Update your computer BIOS using the BIOS update.exe file that is copied to a FAT32 USB drive and booting from the F12 One-Time boot menu.

About this task

BIOS Update

You can run the BIOS update file from Windows using a bootable USB drive or you can also update the BIOS from the F12 One-Time boot menu on the computer.

Most of the Dell computers built after 2012 have this capability, and you can confirm by booting your computer to the F12 One-Time Boot Menu to see if BIOS FLASH UPDATE is listed as a boot option for your computer. If the option is listed, then the BIOS supports this BIOS update option.

 **NOTE:** Only computers with BIOS Flash Update option in the F12 One-Time boot menu can use this function.

Updating from the One-Time boot menu

To update your BIOS from the F12 One-Time boot menu, you need the following:

- USB drive formatted to the FAT32 file system (key does not have to be bootable)
- BIOS executable file that you downloaded from the Dell Support website and copied to the root of the USB drive
- AC power adapter that is connected to the computer
- Functional computer battery to flash the BIOS

Perform the following steps to perform the BIOS update flash process from the F12 menu:

 **CAUTION: Do not turn off the computer during the BIOS update process. The computer may not boot if you turn off your computer.**

Steps

1. From a turn off state, insert the USB drive where you copied the flash into a USB port of the computer.
2. Turn on the computer and press F12 to access the One-Time Boot Menu, select BIOS Update using the mouse or arrow keys then press Enter.
The flash BIOS menu is displayed.
3. Click **Flash from file**.
4. Select external USB device.
5. Select the file and double-click the flash target file, and then click **Submit**.
6. Click **Update BIOS**. The computer restarts to flash the BIOS.
7. The computer will restart after the BIOS update is completed.

Troubleshooting

Handling swollen Lithium-ion batteries

Like most laptops, Dell laptops use lithium-ion batteries. One type of lithium-ion battery is the lithium-ion polymer battery. Lithium-ion polymer batteries have increased in popularity in recent years and have become standard in the electronics industry due to customer preferences for a slim form factor (especially with newer ultra-thin laptops) and long battery life. Inherent to lithium-ion polymer battery technology is the potential for swelling of the battery cells.

Swollen battery may impact the performance of the laptop. To prevent possible further damage to the device enclosure or internal components leading to malfunction, discontinue the use of the laptop and discharge it by disconnecting the AC adapter and letting the battery drain.

Swollen batteries should not be used and should be replaced and disposed of properly. We recommend contacting Dell product support for options to replace a swollen battery under the terms of the applicable warranty or service contract, including options for replacement by a Dell authorized service technician.

The guidelines for handling and replacing Lithium-ion batteries are as follows:

- Exercise caution when handling Lithium-ion batteries.
- Discharge the battery before removing it from the system. To discharge the battery, unplug the AC adapter from the system and operate the system only on battery power. When the system will no longer power on when the power button is pressed, the battery is fully discharged.
- Do not crush, drop, mutilate, or penetrate the battery with foreign objects.
- Do not expose the battery to high temperatures, or disassemble battery packs and cells.
- Do not apply pressure to the surface of the battery.
- Do not bend the battery.
- Do not use tools of any type to pry on or against the battery.
- If a battery gets stuck in a device as a result of swelling, do not try to free it as puncturing, bending, or crushing a battery can be dangerous.
- Do not attempt to reassemble a damaged or swollen battery into a laptop.
- Swollen batteries that are covered under warranty should be returned to Dell in an approved shipping container (provided by Dell)—this is to comply with transportation regulations. Swollen batteries that are not covered under warranty should be disposed of at an approved recycling center. Contact Dell product support at <https://www.dell.com/support> for assistance and further instructions.
- Using a non-Dell or incompatible battery may increase the risk of fire or explosion. Replace the battery only with a compatible battery purchased from Dell that is designed to work with your Dell computer. Do not use a battery from other computers with your computer. Always purchase genuine batteries from <https://www.dell.com> or otherwise directly from Dell.

Lithium-ion batteries can swell for various reasons such as age, number of charge cycles, or exposure to high heat. For more information on how to improve the performance and lifespan of the laptop battery and to minimize the possibility of occurrence of the issue, search Dell Laptop Battery in the Knowledge Base Resource at www.dell.com/support.

Locate the Service Tag or Express Service Code of your Dell computer

Your Dell computer is uniquely identified by a Service Tag or Express Service Code. To view relevant support resources for your Dell computer, we recommend entering the Service Tag or Express Service Code at www.dell.com/support.

For more information on how to find the Service Tag for your computer, see [Locate the Service Tag for your Dell Laptop](#).

System diagnostic lights

Battery-status light

Indicates the power and battery-charge status.

Solid white — Power adapter is connected and the battery has more than 5 percent charge.

Amber — Computer is running on battery and the battery has less than 5 percent charge.

Off

- Power adapter is connected and the battery is fully charged.
- Computer is running on battery and the battery has more than 5 percent charge.
- Computer is in sleep state, hibernation, or turned off.

The power and battery-status light blinks amber along with beep codes indicating failures.

For example, the power and battery-status light blinks amber two times followed by a pause, and then blinks white three times followed by a pause. This 2,3 pattern continues until the computer is turned off indicating no memory or RAM is detected.

The following table shows different power and battery-status light patterns and associated problems.

Table 20. LED codes

Diagnostic light codes	Problem description
1,1	TPM detection failure
1,2	SPI flash failure
1,3	Short in Hinge cable OCP1
1,4	Short in Hinge cable OCP2
1,5	i-Fuse failure
1,6	EC internal failure
2,1	Processor failure
2,2	System board: BIOS or ROM (Read-Only Memory) failure
2,3	No memory or RAM (Random-Access Memory) detected
2,4	Memory or RAM (Random-Access Memory) failure
2,5	Invalid memory installed
2,6	System-board or chipset error
2,7	Display failure
2,8	Display failure - Power Rail Failure
3,1	Coin-cell battery failure
3,2	PCI, video card/chip failure
3,3	Recovery image not found
3,4	Recovery image found but invalid
3,5	Power-rail failure
3,6	System BIOS Flash incomplete
3,7	Management Engine (ME) error

Camera status light: Indicates whether the camera is in use.

- Solid white — Camera is in use.
- Off — Camera is not in use.

Caps Lock status light: Indicates whether Caps Lock is enabled or disabled.

- Solid white — Caps Lock enabled.
- Off — Caps Lock disabled.

SupportAssist diagnostics

About this task

The SupportAssist diagnostics (previously known as ePSA diagnostics) performs a complete check of your hardware. The SupportAssist diagnostics is embedded in the BIOS and is launched by it internally. The SupportAssist diagnostics provides a set of options for particular devices or device groups. It allows you to:

- Run tests automatically or in an interactive mode.
- Repeat tests
- Display or save test results
- Run thorough tests to introduce additional test options and provide extra information about the failed device(s)
- View status messages that indicate if the tests are completed successfully
- View error messages that indicate if problems were encountered during the test

NOTE: Some tests are meant for specific devices and require user interaction. Ensure that you are present in front of the computer when the diagnostic tests are performed.

For more information, see [SupportAssist Pre-Boot System Performance Check](#).

Built-in self-test (BIST)

M-BIST

M-BIST (Built In Self-Test) is the system board's built-in self-test diagnostics tool that improves the diagnostics accuracy of system board embedded controller (EC) failures.

NOTE: M-BIST can be manually initiated before POST (Power On Self Test).

How to run M-BIST

NOTE: M-BIST must be initiated on the system from a power-off state either connected to AC power or with battery only.

1. Press and hold both the **M** key on the keyboard and the **power button** to initiate M-BIST.
2. With both the **M** key and the **power button** held down, the battery indicator LED may exhibit two states:
 - a. OFF: No fault detected with the system board
 - b. AMBER: Indicates a problem with the system board
3. If there is a failure with the system board, the battery status LED will flash one of the following error codes for 30 seconds:

Table 21. LED error codes

Blinking Pattern		Possible Problem
Amber	White	
2	1	CPU Failure
2	8	LCD Power Rail Failure
1	1	TPM Detection Failure
2	4	Unrecoverable SPI Failure

4. If there is no failure with the system board, the LCD will cycle through the solid color screens described in the LCD-BIST section for 30 seconds and then power off.

LCD Built-in Self Test (BIST)

Dell laptops have a built-in diagnostic tool that helps you determine if the screen abnormality you are experiencing is an inherent problem with the LCD (screen) of the Dell laptop or with the video card (GPU) and PC settings.

When you notice screen abnormalities like flickering, distortion, clarity issues, fuzzy or blurry image, horizontal or vertical lines, color fade etc., it is always a good practice to isolate the LCD (screen) by running the Built-In Self Test (BIST).

How to invoke LCD BIST Test

1. Power off the Dell laptop.
2. Disconnect any peripherals that are connected to the laptop. Connect only the AC adapter (charger) to the laptop.
3. Ensure that the LCD (screen) is clean (no dust particles on the surface of the screen).
4. Press and hold **D** key and **Power on** the laptop to enter LCD built-in self test (BIST) mode. Continue to hold the D key, until the system boots up.
5. The screen will display solid colors and change colors on the entire screen to white, black, red, green, and blue twice.
6. Then it will display the colors white, black and red.
7. Carefully inspect the screen for abnormalities (any lines, fuzzy color or distortion on the screen).
8. At the end of the last solid color (red), the system will shut down.

 **NOTE:** Dell SupportAssist Pre-boot diagnostics upon launch, initiates an LCD BIST first, expecting a user intervention confirm functionality of the LCD.

Recovering the operating system

When your computer is unable to boot to the operating system even after repeated attempts, it automatically starts Dell SupportAssist OS Recovery.

Dell SupportAssist OS Recovery is a standalone tool that is preinstalled in all Dell computers installed with Windows operating system. It consists of tools to diagnose and troubleshoot issues that may occur before your computer boots to the operating system. It enables you to diagnose hardware issues, repair your computer, back up your files, or restore your computer to its factory state.

You can also download it from the Dell Support website to troubleshoot and fix your computer when it fails to boot into their primary operating system due to software or hardware failures.

For more information about the Dell SupportAssist OS Recovery, see *Dell SupportAssist OS Recovery User's Guide* at www.dell.com/serviceabilitytools. Click **SupportAssist** and then, click **SupportAssist OS Recovery**.

WiFi power cycle

About this task

If your computer is unable to access the internet due to WiFi connectivity issues a WiFi power cycle procedure may be performed. The following procedure provides the instructions on how to conduct a WiFi power cycle:

 **NOTE:** Some ISPs (Internet Service Providers) provide a modem/router combo device.

Steps

1. Turn off your computer.
2. Turn off the modem.
3. Turn off the wireless router.
4. Wait for 30 seconds.
5. Turn on the wireless router.
6. Turn on the modem.
7. Turn on your computer.

Drain residual flea power (perform hard reset)

About this task

Flea power is the residual static electricity that remains in the computer even after it has been powered off and the battery is removed.

For your safety, and to protect the sensitive electronic components in your computer, you are requested to drain residual flea power before removing or replacing any components in your computer.

Draining residual flea power, also known as a performing a "hard reset", is also a common troubleshooting step if your computer does not power on or boot into the operating system.

To drain residual flea power (perform a hard reset)

Steps

1. Turn off your computer.
2. Disconnect the power adapter from your computer.
3. Remove the base cover.
4. Remove the battery.
5. Press and hold the power button for 20 seconds to drain the flea power.
6. Install the battery.
7. Install the base cover.
8. Connect the power adapter to your computer.
9. Turn on your computer.

 **NOTE:** For more information about performing a hard reset, search in the Knowledge Base Resource at www.dell.com/support.

Backup media and recovery options

It is recommended to create a recovery drive to troubleshoot and fix problems that may occur with Windows. Dell proposes multiple options for recovering Windows operating system on your Dell PC. For more information, see [Dell Windows Backup Media and Recovery Options](#).

Real Time Clock—RTC reset

The Real Time Clock (RTC) reset function allows you or the service technician to recover the recently launched model Dell Latitude and Precision systems from **No POST/No Boot/No Power** situations. You can initiate the RTC reset on the system from a power-off state only if it is connected to AC power. Press and hold the power button for 25 seconds. The system RTC reset occurs after you release the power button.

 **NOTE:** If AC power is disconnected from the system during the process or the power button is held longer than 40 seconds, the RTC reset process gets aborted.

The RTC reset will reset the BIOS to Defaults, un-provision Intel vPro and reset the system date and time. The following items are unaffected by the RTC reset:

- Service Tag
- Asset Tag
- Ownership Tag
- Admin Password
- System Password
- HDD Password
- Key Databases
- System Logs

 **NOTE:** The IT administrator's vPro account and password on the system will be un-provisioned. The system needs to go through the setup and configuration process again to reconnect it to the vPro server.

The below items may or may not reset based on your custom BIOS setting selections:



- Boot List
- Enable Legacy Option ROMs
- Secure Boot Enable
- Allow BIOS Downgrade

Getting help and contacting Dell

Self-help resources

You can get information and help on Dell products and services using these self-help resources:

Table 22. Self-help resources

Self-help resources	Resource location
Information about Dell products and services	www.dell.com
My Dell app	
Tips	
Contact Support	In Windows search, type <code>Contact Support</code> , and press Enter.
Online help for operating system	www.dell.com/support/windows
Access top solutions, diagnostics, drivers and downloads, and learn more about your computer through videos, manuals and documents.	Your Dell computer is uniquely identified by a Service Tag or Express Service Code. To view relevant support resources for your Dell computer, enter the Service Tag or Express Service Code at www.dell.com/support . For more information on how to find the Service Tag for your computer, see Locate the Service Tag on your computer .
Dell knowledge base articles for a variety of computer concerns	<ol style="list-style-type: none"> 1. Go to www.dell.com/support. 2. On the menu bar at the top of the Support page, select Support > Knowledge Base. 3. In the Search field on the Knowledge Base page, type the keyword, topic, or model number, and then click or tap the search icon to view the related articles.

Contacting Dell

To contact Dell for sales, technical support, or customer service issues, see www.dell.com/contactdell.

 **NOTE:** Availability varies by country/region and product, and some services may not be available in your country/region.

 **NOTE:** If you do not have an active Internet connection, you can find contact information about your purchase invoice, packing slip, bill, or Dell product catalog.