

OPEN Industry Standard, Flexible Architecture

GREEN Less Heat, Less Power Consumption

STABLE Robust Design, Quality Parts

Stable and
Reliable Solution

Server/Workstation
Motherboard

EC266D2I

EC266D2I-2T/AQC

User Manual

English



Version 1.00

Published May 2024

Copyright©2024 ASRock Rack INC. All rights reserved.

Copyright Notice:

No part of this documentation may be reproduced, transcribed, transmitted, or translated in any language, in any form or by any means, except duplication of documentation by the purchaser for backup purpose, without written consent of ASRock Rack Inc.

Products and corporate names appearing in this documentation may or may not be registered trademarks or copyrights of their respective companies, and are used only for identification or explanation and to the owners' benefit, without intent to infringe.

Disclaimer:

Specifications and information contained in this documentation are furnished for informational use only and subject to change without notice, and should not be construed as a commitment by ASRock Rack. ASRock Rack assumes no responsibility for any errors or omissions that may appear in this documentation.

With respect to the contents of this documentation, ASRock Rack does not provide warranty of any kind, either expressed or implied, including but not limited to the implied warranties or conditions of merchantability or fitness for a particular purpose.

In no event shall ASRock Rack, its directors, officers, employees, or agents be liable for any indirect, special, incidental, or consequential damages (including damages for loss of profits, loss of business, loss of data, interruption of business and the like), even if ASRock Rack has been advised of the possibility of such damages arising from any defect or error in the documentation or product.



WARNING

THIS PRODUCT CONTAINS A BUTTOON BATTERY

If swallowed, a button battery can cause serious injury or death.

Please keep batteries out of sight or reach of children.

ASRock Rack's Website: www.ASRockRack.com

INTEL END USER SOFTWARE LICENSE AGREEMENT
IMPORTANT - READ BEFORE COPYING, INSTALLING OR USING.

LICENSE. Licensee has a license under Intel's copyrights to reproduce Intel's Software only in its unmodified and binary form, (with the accompanying documentation, the "Software") for Licensee's personal use only, and not commercial use, in connection with Intel-based products for which the Software has been provided, subject to the following conditions:

- (a) Licensee may not disclose, distribute or transfer any part of the Software, and You agree to prevent unauthorized copying of the Software.
- (b) Licensee may not reverse engineer, decompile, or disassemble the Software.
- (c) Licensee may not sublicense the Software.
- (d) The Software may contain the software and other intellectual property of third party suppliers, some of which may be identified in, and licensed in accordance with, an enclosed license.txt file or other text or file.
- (e) Intel has no obligation to provide any support, technical assistance or updates for the Software.

OWNERSHIP OF SOFTWARE AND COPYRIGHTS. Title to all copies of the Software remains with Intel or its licensors or suppliers. The Software is copyrighted and protected by the laws of the United States and other countries, and international treaty provisions. Licensee may not remove any copyright notices from the Software. Except as otherwise expressly provided above, Intel grants no express or implied right under Intel patents, copyrights, trademarks, or other intellectual property rights. Transfer of the license terminates Licensee's right to use the Software.

DISCLAIMER OF WARRANTY. The Software is provided "AS IS" without warranty of any kind, EITHER EXPRESS OR IMPLIED, INCLUDING WITHOUT LIMITATION, WARRANTIES OF MERCHANTABILITY OR FITNESS FOR ANY PARTICULAR PURPOSE.

LIMITATION OF LIABILITY. NEITHER INTEL NOR ITS LICENSORS OR SUPPLIERS WILL BE LIABLE FOR ANY LOSS OF PROFITS, LOSS OF USE, INTERRUPTION OF BUSINESS, OR INDIRECT, SPECIAL, INCIDENTAL, OR CONSEQUENTIAL DAMAGES OF ANY KIND WHETHER UNDER THIS AGREEMENT OR OTHERWISE, EVEN IF INTEL HAS BEEN ADVISED OF THE POSSIBILITY OF SUCH DAMAGES.

LICENSE TO USE COMMENTS AND SUGGESTIONS. This Agreement does NOT obligate Licensee to provide Intel with comments or suggestions regarding the Software. However, if Licensee provides Intel with comments or suggestions for the modification, correction, improvement or enhancement of (a) the Software or (b) Intel products or processes that work with the Software, Licensee grants to Intel a non-exclusive, worldwide, perpetual, irrevocable, transferable, royalty-free license, with the right to sublicense, under Licensee's intellectual property rights, to incorporate or otherwise utilize those comments and suggestions.

TERMINATION OF THIS LICENSE. Intel or the sublicensor may terminate this license at any time if Licensee is in breach of any of its terms or conditions. Upon termination, Licensee will immediately destroy or return to Intel all copies of the Software.

THIRD PARTY BENEFICIARY. Intel is an intended beneficiary of the End User License Agreement and has the right to enforce all of its terms.

U.S. GOVERNMENT RESTRICTED RIGHTS. The Software is a commercial item (as defined in 48 C.F.R. 2.101) consisting of commercial computer software and commercial computer software documentation (as those terms are used in 48 C.F.R. 12.212), consistent with 48 C.F.R. 12.212 and 48 C.F.R. 227.7202-1 through 227.7202-4. You will not provide the Software to the U.S. Government. Contractor or Manufacturer is Intel Corporation, 2200 Mission College Blvd., Santa Clara, CA 95054.

EXPORT LAWS. Licensee agrees that neither Licensee nor Licensee's subsidiaries will export/re-export the Software, directly or indirectly, to any country for which the U.S. Department of Commerce or any other agency or department of the U.S. Government or the foreign government from where it is shipping requires an export license, or other governmental approval, without first obtaining any such required license or approval. In the event the Software is exported from the U.S.A. or re-exported from a foreign destination by Licensee, Licensee will ensure that the distribution and export/re-export or import of the Software complies with all laws, regulations, orders, or other restrictions of the U.S. Export Administration Regulations and the appropriate foreign government.

APPLICABLE LAWS. This Agreement and any dispute arising out of or relating to it will be governed by the laws of the U.S.A. and Delaware, without regard to conflict of laws principles. The Parties to this Agreement exclude the application of the United Nations Convention on Contracts for the International Sale of Goods (1980). The state and federal courts sitting in Delaware, U.S.A. will have exclusive jurisdiction over any dispute arising out of or relating to this Agreement. The Parties consent to personal jurisdiction and venue in those courts. A Party that obtains a judgment against the other Party in the courts identified in this section may enforce that judgment in any court that has jurisdiction over the Parties.

CALIFORNIA, USA ONLY

The Lithium battery adopted on this motherboard contains Perchlorate, a toxic substance controlled in Perchlorate Best Management Practices (BMP) regulations passed by the California Legislature. When you discard the Lithium battery in California, USA, please follow the related regulations in advance.

"Perchlorate Material-special handling may apply, see www.dtsc.ca.gov/hazardouswaste/perchlorate"

AUSTRALIA ONLY

Our goods come with guarantees that cannot be excluded under the Australian Consumer Law. You are entitled to a replacement or refund for a major failure and compensation for any other reasonably foreseeable loss or damage caused by our goods. You are also entitled to have the goods repaired or replaced if the goods fail to be of acceptable quality and the failure does not amount to a major failure. If you require assistance please call ASRock Rack Tel : +886-2-55599600 ext.123 (Standard International call charges apply)

Licensee's specific rights may vary from country to country.

ASRock Rack's Website: www.ASRockRack.com



This device complies with Part 15 of the FCC Rules. Operation is subject to the following two conditions:

- (1) this device may not cause harmful interference, and
- (2) this device must accept any interference received, including interference that may cause undesired operation.

This equipment has been tested and found to comply with the limits for a Class B digital device, pursuant to part 15 of the FCC Rules. These limits are designed to provide reasonable protection against harmful interference in a residential installation. This equipment generates, uses and can radiate radio frequency energy and, if not installed and used in accordance with the instructions, may cause harmful interference to radio communications. However, there is no guarantee that interference will not occur in a particular installation. If this equipment does cause harmful interference to radio or television reception, which can be determined by turning the equipment off and on, the user is encouraged to try to correct the interference by one or more of the following

measures:

- Reorient or relocate the receiving antenna.
- Increase the separation between the equipment and receiver.
- Connect the equipment into an outlet on a circuit different from that to which the receiver is connected.
- Consult the dealer or an experienced radio/TV technician for help.



ASRock Rack INC. hereby declares that this device is in compliance with the essential requirements and other relevant provisions of related Directives. Full text of EU declaration of conformity is available at: <http://www.asrockrack.com>

ASRock Rack follows the green design concept to design and manufacture our products, and makes sure that each stage of the product life cycle of ASRock Rack product is in line with global environmental regulations. In addition, ASRock Rack disclose the relevant information based on regulation requirements.

Please refer to <https://www.asrockrack.com/general/about.asp?cat=Responsibility> for information disclosure based on regulation requirements ASRock Rack is complied with:



ASRock Rack INC. hereby declares that this device is in compliance with the essential requirements and other relevant provisions of related UKCA Directives. Full text of UKCA declaration of conformity is available at: <http://www.asrockrack.com>



DO NOT throw the motherboard in municipal waste. This product has been designed to enable proper reuse of parts and recycling. This symbol of the crossed out wheeled bin indicates that the product (electrical and electronic equipment) should not be placed in municipal waste. Check local regulations for disposal of electronic products.

Contents

Chapter 1 Introduction	1
1.1 Package Contents	1
1.2 Specifications	2
1.3 Unique Features	5
1.4 Motherboard Layout	6
1.5 Onboard LED Indicators	8
1.7 Block Diagram	12
Chapter 2 Installation	13
2.1 Screw Holes	13
2.2 Pre-installation Precautions	13
2.3 Installing the CPU	14
2.4 Installing the CPU Fan and Heatsink	16
2.5 Installing Memory Modules (DIMM)	17
2.6 Expansion Slot (PCI Express Slot)	18
2.7 Jumper Setup	19
2.8 Onboard Headers and Connectors	20
2.9 Unit Identification purpose LED/Switch	25
2.10 ATX PSU / DC-IN Power Connections	26
2.11 Dual LAN and Teaming Operation Guide	27
2.12 M.2 SSD Module Installation Guide	28
Chapter 3 UEFI Setup Utility	29
3.1 Introduction	29
3.1.1 UEFI Menu Bar	29

3.1.2	Navigation Keys	30
3.2	Main Screen	31
3.2.1	Motherboard Information	32
3.2.2	Processor Information	32
3.2.3	Memory Information	33
3.3	Advanced Screen	34
3.3.1	CPU Configuration	35
3.3.2	DRAM Configuration	38
3.3.3	Chipset Configuration	39
3.3.4	Storage Configuration	41
3.3.5	NVME Configuration	42
3.3.6	ACPI Configuration	43
3.3.7	USB Configuration	44
3.3.8	Super IO Configuration	45
3.3.9	Serial Port Console Redirection	46
3.3.10	H/W Monitor	49
3.3.11	Network Stack Configuration	50
3.3.12	Intel SPS Configuration	52
3.3.13	Driver Health	53
3.3.14	RAM Disk Configuration	54
3.3.15	Tls Auth Configuration	55
3.3.16	Instant Flash	56
3.4	Server Mgmt	57
3.4.1	BMC Network Configuration	59

3.4.2	DNS Configuration	61
3.4.3	System Event Log	63
3.4.4	BMC Tools	64
3.5	Event Logs	65
3.6	Security Screen	66
3.6.1	Key Management	68
3.7	Boot Screen	72
3.8	Exit Screen	74
Chapter 4 Software Support		75
4.1	Download and Install Operating System	75
4.2	Download and Install Software Drivers	75
4.3	Contact Information	75
Chapter 5 Troubleshooting		76
5.1	Troubleshooting Procedures	76
5.2	Technical Support Procedures	78
5.3	Returning Merchandise for Service	78

Chapter 1 Introduction

Thank you for purchasing ASRock Rack **EC266D2I or EC266D2I-2T/AQC** motherboard, a reliable motherboard produced under ASRock Rack's consistently stringent quality control. It delivers excellent performance with robust design conforming to ASRock Rack's commitment to quality and endurance.

In this manual, chapter 1 and 2 contains introduction of the motherboard and step-by-step guide to the hardware installation. Chapter 3 and 4 contains the configuration guide to BIOS setup and information of the Software Support.



Because the motherboard specifications and the BIOS software might be updated, the content of this manual will be subject to change without notice. In case any modifications of this manual occur, the updated version will be available on ASRock Rack website without further notice. Find the latest memory and CPU support lists on ASRock Rack website as well. ASRock Rack's Website: www.ASRockRack.com

About this motherboard technical support, please visit the website for specific information <http://www.asrockrack.com/support/>

1.1 Package Contents

- ASRock Rack EC266D2I or EC266D2I-2T/AQC motherboard (mini-ITX form factor: 6.7" x 6.7", 17.02cm x 17.02cm)
- Quick installation guide
- 1 x I/O shield
- 1 x ATX 4P to 24P power cable
- 1 x Oculink to 4 SATA cable (60cm)
- 1 x SATA power cable (80cm)
- 1 x screw for M.2 socket



If any items are missing or appear damaged, contact the authorized dealer.

1.2 Specifications

EC266D2I, EC266D2I-2T/AQC	
MB Physical Status	
Form Factor	mini-ITX
Dimension	6.7" x 6.7" (17.02cm x 17.02cm)
Processor System	
CPU	Supports Intel® Xeon® E-2400 series processors
Socket	Single Socket (LGA1700)
Thermal Design Power (TDP)	95W
Chipset	Intel® C266
System Memory	
Supported DIMM Quantity	2 DIMM slots (1DPC)
Supported Type	Supports DDR5 288-pin ECC/UDIMM
Max. Capacity per DIMM	32GB
Max. Frequency	4800MT/s
Voltage	1.1V
Note	memory support is to be validated
PCIe Expansion Slots (SLOT7 close to CPU)	
SLOT7	PCIe5.0 x16 [CPU]
Other PCIe Expansion Connectors	
M.2	1 M-key M2_1 (PCIe4.0 x4); support 2280 form factor [CPU]
OCuLink	1 OcuLink (PCIe4.0 x4 or SATA 6Gb/s) [PCH] 1 OcuLink (PCIe3.0 x4 or SATA 6Gb/s) [PCH]
SATA/SAS Storage	
PCH Built-in Storage	Intel® C266 (8 SATA 6Gb/s; RAID 0/1/5/10): 2 OcuLink
Ethernet	
Additional Ethernet Controller	EC266D2I: 2 RJ45 (1GbE) by Intel® i210 EC266D2I-2T/AQC: 2 RJ45 (10GbE) by Marvell AQC113
USB	
Controller/Hub	Intel® C266
Connectors/Headers	External: 2 Type-A (USB3.2 Gen1) Internal: 1 header (19-pin, 2 USB3.2 Gen1)

Graphics	
Controller	ASPEED AST2600: 1 DBI5 (VGA)
Security	
TPM	1 (13-pin, SPI)
Rear I/O	
UID Button/ LED	1 UID button w/ LED
Video Output	1 DBI5 (VGA)
USB	2 Type A (USB3.2 Gen1)
RJ45	EC266D2I: 2 RJ45(1GbE) , 1 dedicated IPMI EC266D2I-2T/AQC: 2 RJ45(10GbE), 1 dedicated IPMI
Hardware Monitor	
Temperature	CPU, MB, Card side, M.2, TR1 Temperature sensing
Fan	Fan Tachometer CPU Quiet Fan (Allow Chassis Fan Speed Auto-Adjust by CPU Temperature) Fan Multi-Speed Control
Voltage	3VSB, 5VSB, CPU_VCORE, VCCIN_AUX, VDD2, 1.05V_PCH, 0V82SB_PCH, 1V8SB, BAT, 3V, 5V, 12V, 1.05V_PROC, 1.8V_PROC
Server Management	
BMC Controller	ASPEED AST2600: iKVM, vMedia support
IPMI Dedicated GLAN	1 RJ45 Dedicated IPMI LAN port by Realtek RTL8211F
System BIOS	
Type	AMI 256Mb SPI Flash ROM
Features	Plug and Play, ACPI 6.4 and above compliance wake up events, SMBIOS 2.8 and above, ASRock Rack Instant Flash
Internal Connectors/Headers	
PSU Connector	1 Micro-Fit (4-pin, ATX PSU signal) w/ ATX 24-pin adapter cable, 1 (8-pin, ATX 12V) support 12V DC-in
Other Power Connector	1 ATX (4-pin) for HDD power when using 12V DC-in power source
Auxiliary Panel Header	1 (9-pin): chassis intrusion, system fault LED, LAN activity LED
System Panel Header	1 (9-pin): power switch, reset switch, system power LED, HDD activity LED
COM Header	1 (9-pin)
Fan Header	3 (4-pin)

Thermal Sensor Header	1
TPM Header	1 (13-pin, SPI)
SGPIO Header	1
SMBus Header	1
PMBus Header	1
IPMB Header	1
IPMI LAN LED Header	1 (4-pin)
NCSI Header	1 (9-pin)
UID Header	1 (4-pin)
Clear CMOS	1 (contact pads)
LED Indicators	
Standby Power LED	1 (5VSB)
Fan Fail LED	3
BMC Heartbeat LED	1
Support OS	
OS	<p>Microsoft® Windows®</p> <ul style="list-style-type: none"> - Server 2022 (64bit) <p>Linux®</p> <ul style="list-style-type: none"> - Red Hat Enterprise Linux Server 8.5 (64bit) / 9.2 (64bit) - SUSE Enterprise Linux Server 15 SP3 (64bit) / 15 SP5 (64bit) - Ubuntu 21.04 (64bit) / 22.04.2 (64bit) <p><i>*Please refer to the website for the latest OS support list.</i></p>
Environment	
Operating Temperature	10 - 35°C (50 - 95 degF)
Non-operating Temperature	-40 - 70°C (-40 - 158degF)

NOTE: Please refer to the website for the latest specifications.



This motherboard supports Wake from on Board LAN. To use this function, please make sure that the "Wake on Magic Packet from power off state" is enabled in Device Manager > Intel® Ethernet Connection > Power Management. And the "PCI Devices Power On" is enabled in UEFI SETUP UTILITY > Advanced > ACPI Configuration. After that, onboard LAN1&2 can wake up S5 under OS.



If installing Intel® LAN utility or Marvell SATA utility, this motherboard may fail Windows® Hardware Quality Lab (WHQL) certification tests. If installing the drivers only, it will pass the WHQL tests.

1.3 Unique Features

ASRock Rack Instant Flash is a BIOS flash utility embedded in Flash ROM. This convenient BIOS update tool allows user to update system BIOS without entering operating systems first like MS-DOS or Windows. With this utility, press the <F6> key during the POST or the <F2> key to enter into the BIOS setup menu to access ASRock Rack Instant Flash. Just launch this tool and save the new BIOS file to the USB flash drive, floppy disk or hard drive, then update the BIOS only in a few clicks without preparing an additional floppy diskette or other complicated flash utility. Please be noted that the USB flash drive or hard drive must use FAT32/16/12 file system.

1.4 Motherboard Layout

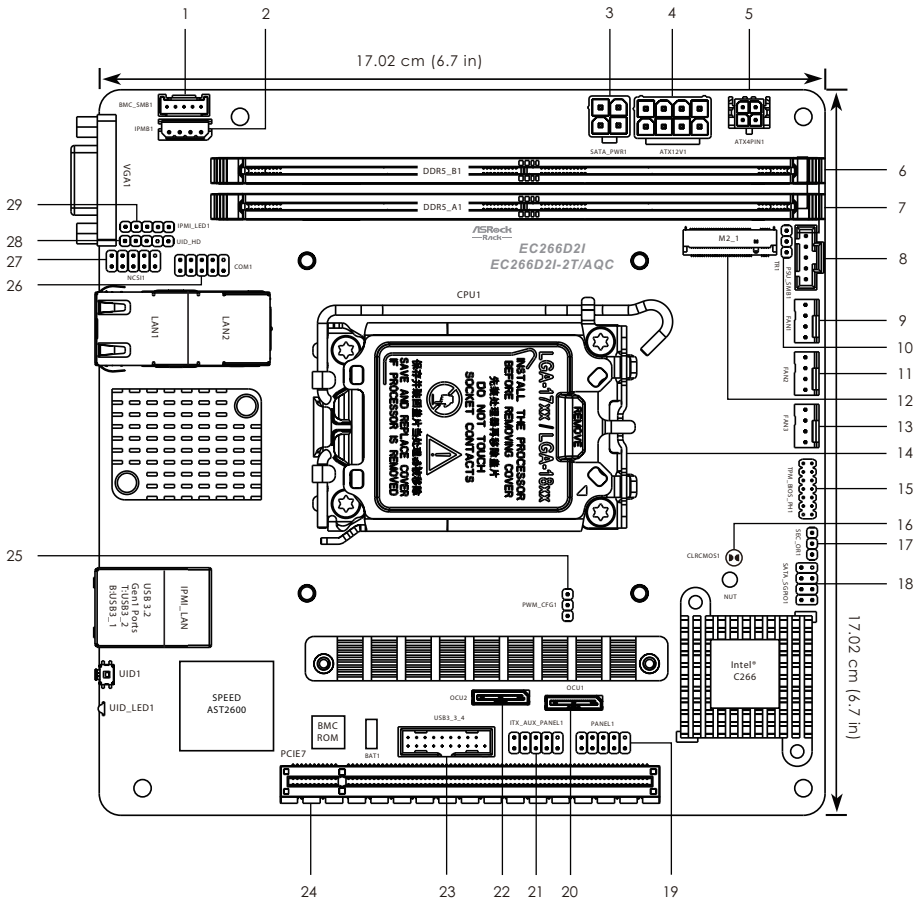

No.	Description
1	BMC SMBus Header (BMC_SMB1)
2	Intelligent Platform Management Bus Header (IPMB1)
3	SATA Power Connector (SATA_PWR1)
4	ATX 12V Power Connector (ATX12V1)
5	Micro-Fit Power Connector (ATX4PIN1)
6	1 x 288-pin DDR5 DIMM Slots (DDR5_B1)*
7	1 x 288-pin DDR5 DIMM Slots (DDR5_A1)*
8	PSU SMBus Header (PSU_SMB1)
9	Chassis Fan Connector (FAN1)
10	Thermal Sensor Header (TR1)
11	Chassis Fan Connector (FAN2)
12	M.2 Socket (M2_1) (Type 2280)
13	Chassis Fan Connector (FAN3)
14	Single Socket (LGA-1700) (CPU1)
15	SPI TPM Header (TPM_BIOS_PH1)
16	Clear CMOS Pad (CLRMO1)
17	Security Override Jumper (SEC_OR1)
18	SATA SGPIO Connector (SATA_SGPIO1)
19	System Panel Header (PANEL1)
20	OCuLink Connector (PCIe4.0 x4 or SATA 6Gb/s) (OCU1)
21	Auxiliary Panel Header (ITX_AUX_PANEL1)
22	OCuLink Connector (PCIe3.0 x4 or SATA 6Gb/s) (OCU2)
23	USB 3.2 Gen1 Header (USB3_3_4)
24	PCI Express 5.0 x16 Slot (PCIE7)
25	PWM Configuration Header (PWM_CFG1)
26	COM Port Header (COM1)
27	NCSI Header (NCSI1)
28	UID Button Header (UID_HD)
29	IPMI LAN LED Header (IPMI_LED1)

* For DIMM installation and configuration instructions, please see p.17 (Installation of Memory Modules (DIMM)) for more details.

1.5 Onboard LED Indicators

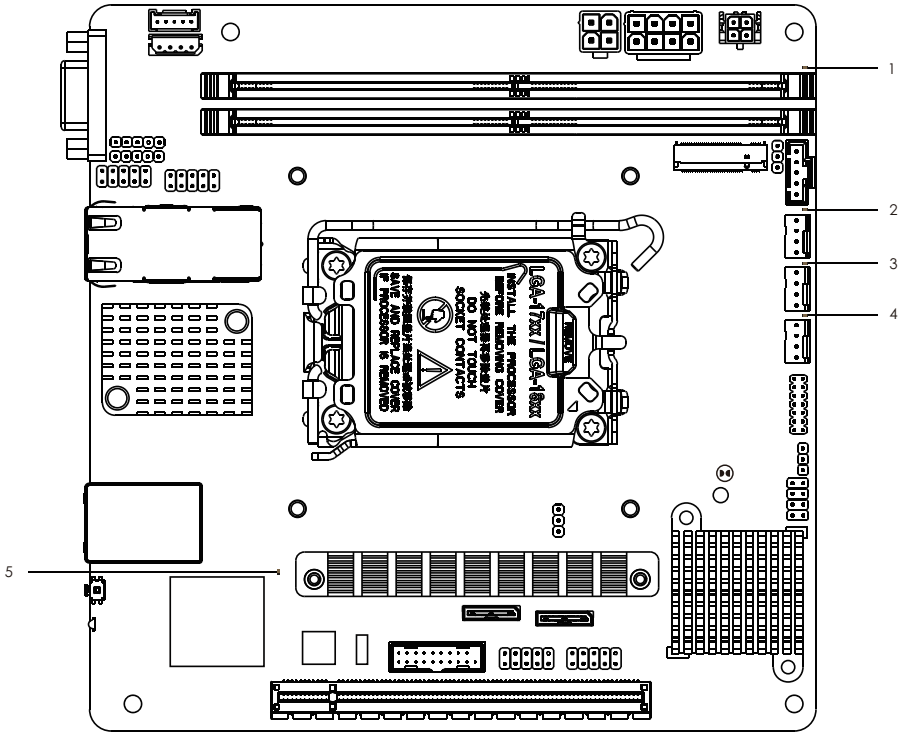

No.	Item	Status	Description
1	SB_PWR1	Green	STB PWR ready
2	LED_FAN1	Red	FAN1 failed
3	LED_FAN2	Red	FAN2 failed
4	LED_FAN3	Red	FAN3 failed
5	BMC_LED1	Green	BMC heartbeat LED

1.6 I/O Panel

EC266D2I:

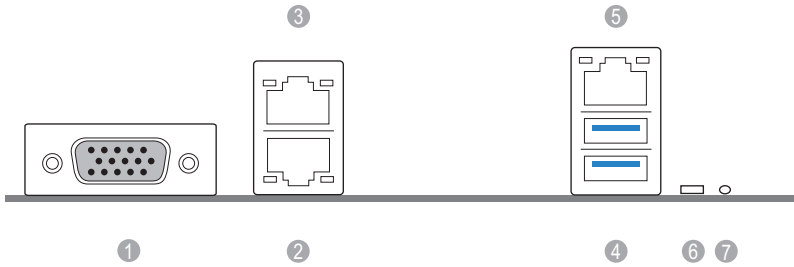

No.	Description	No.	Description
1	VGA Port (VGA1)	5	LAN RJ-45 Port (IPMI_LAN)*
2	1G LAN RJ-45 Port (LAN1, shared NIC)**	6	UID Switch (UID1)
3	1G LAN RJ-45 Port (LAN2)**	7	UID LED (UID_LED1)
4	USB 3.2 Gen1 Ports (USB3_1_2)		

EC266D2I-2T/AQC:

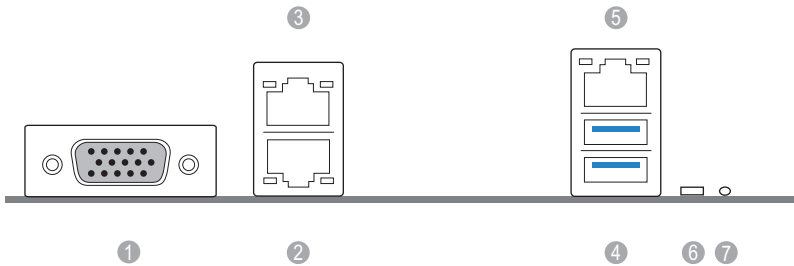

No.	Description	No.	Description
1	VGA Port (VGA1)	5	LAN RJ-45 Port (IPMI_LAN)*
2	10G LAN RJ-45 Port (LAN1)***	6	UID Switch (UID1)
3	10G LAN RJ-45 Port (LAN2)***	7	UID LED (UID_LED1)
4	USB 3.2 Gen1 Ports (USB3_1_2)		

LAN Port LED Indications

*There is an LED on each side of IPMI LAN port. Please refer to the table below for the LAN port LED indications.

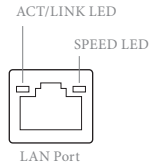

IPMI LAN Port LED Indications

Activity / Link LED		Speed LED	
Status	Description	Status	Description
Off	No Link	Off	10M bps connection or no link
Blinking Yellow	Data Activity	Yellow	100M bps connection
On	Link	Green	1Gbps connection

**There is an LED on each side of 1G LAN port. Please refer to the table below for the LAN port LED indications.

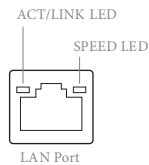

1G LAN Port LED Indications (EC266D2I only)

Activity / Link LED		Speed LED	
Status	Description	Status	Description
Off	No Link	Off	10Mbps connection or no link
Blinking Yellow	Data Activity	Orange	100Mbps connection
On	Link	Green	1Gbps connection

***There is an LED on each side of 10G LAN port. Please refer to the table below for the LAN port LED indications.

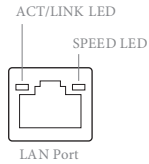

10G LAN Port LED Indications (EC266D2I-2T/AQC only)

Activity / Link LED		Speed LED	
Status	Description	Status	Description
Off	No Link	Off	10/100Mbps Connection or No Link
Blinking Yellow	Data Activity	Orange	1Gbps Connection
On	Link	Green	10Gbps Connection

1.7 Block Diagram

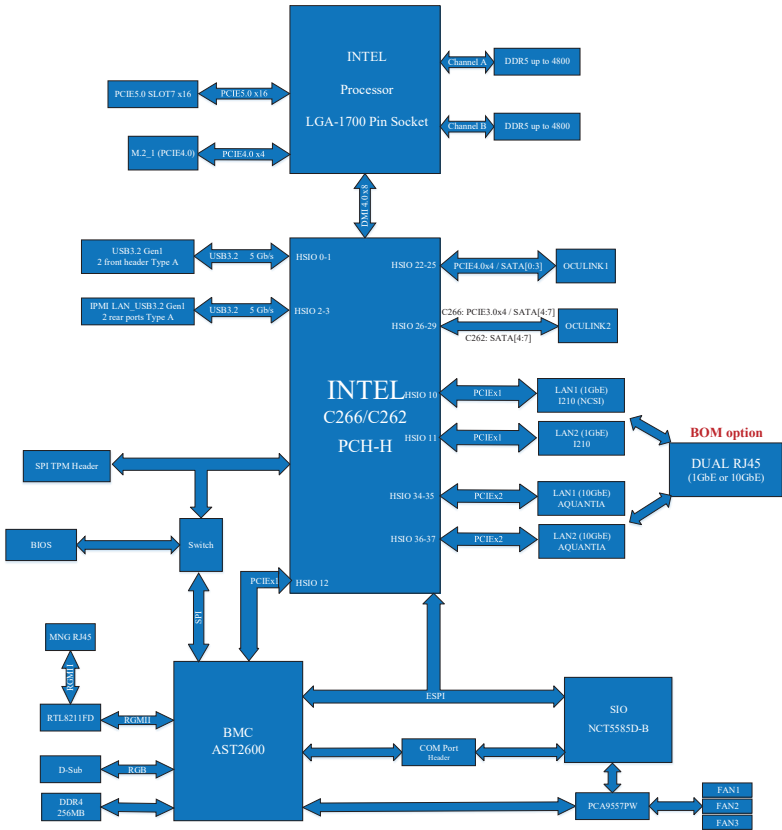

Chapter 2 Installation

This is a mini-ITX form factor (6.7" x 6.7", 17.02cm x 17.02cm) motherboard. Before installing the motherboard, study the configuration of the chassis to ensure that the motherboard fits into it.



Make sure to unplug the power cord before installing or removing the motherboard. Failure to do so may cause physical injuries and motherboard damages.

2.1 Screw Holes

Place screws into the holes indicated by circles to secure the motherboard to the chassis.



Do not over-tighten the screws! Doing so may damage the motherboard.

2.2 Pre-installation Precautions

Take note of the following precautions before installing motherboard components or change any motherboard settings.

1. Unplug the power cord from the wall socket before touching any components.
2. To avoid damaging the motherboard's components due to static electricity, NEVER place the motherboard directly on the carpet or the like. Also remember to use a grounded wrist strap or touch a safety grounded object before handling the components.
3. Hold components by the edges and do not touch the ICs.
4. Whenever uninstall any component, place it on a grounded anti-static pad or in the bag that comes with the component.
5. When placing screws into the screw holes to secure the motherboard to the chassis, please do not over-tighten the screws! Doing so may damage the motherboard.



Before installing or removing any component, ensure that the power is switched off or the power cord is detached from the power supply. Failure to do so may cause severe damage to the motherboard, peripherals, and/or components.

2.3 Installing the CPU



1. Before inserting the 1700-Pin CPU into the socket, please check if the **PnP cap** is on the socket, if the CPU surface is unclean, or if there are any **bent pins** in the socket. Do not force to insert the CPU into the socket if above situation is found. Otherwise, the CPU will be seriously damaged.
2. Unplug all power cables before installing the CPU.

1

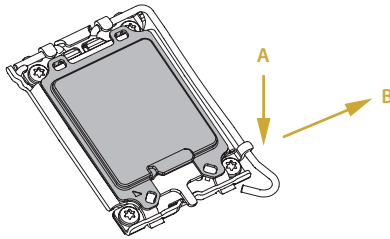

2

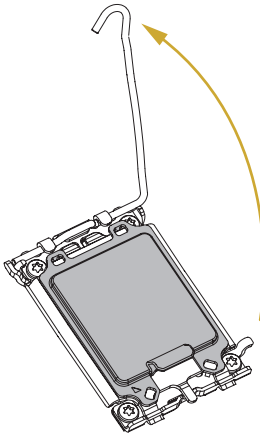

3

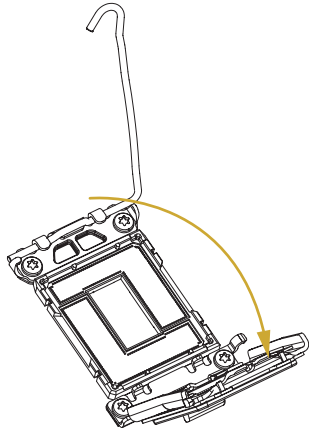

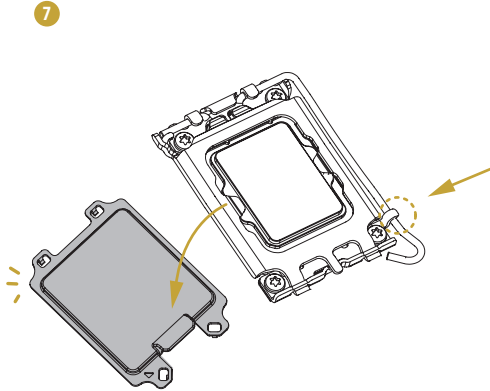
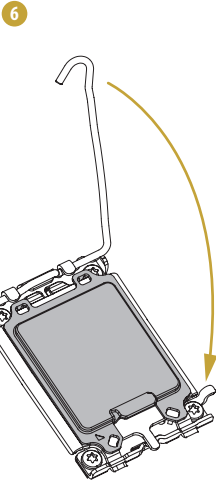
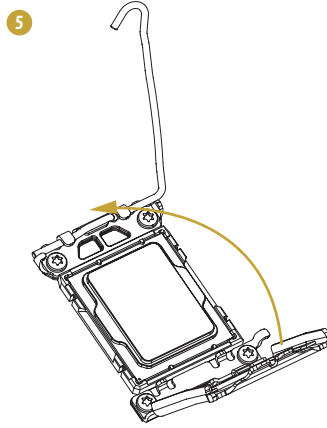
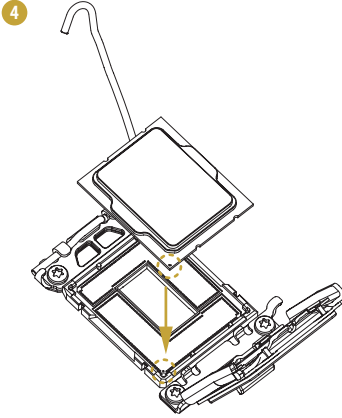

Please save and replace the cover if the processor is removed. The cover must be placed if wishing to return the motherboard for after service.

2.4 Installing the CPU Fan and Heatsink

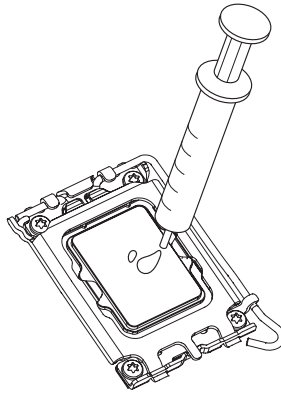

1

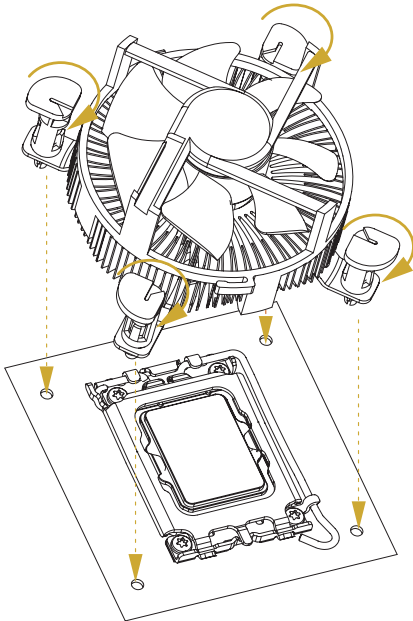

2

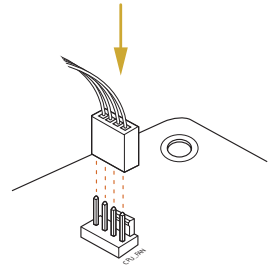

2.5 Installing Memory Modules (DIMM)

This motherboard provides two 288-pin DDR5 (Double Data Rate 5) DIMM slots, and supports Single Channel Memory Technology.



It is not allowed to install a DDR, DDR2, DDR3 or DDR4 memory module into a DDR5 slot; otherwise, this motherboard and DIMM may be damaged.

1

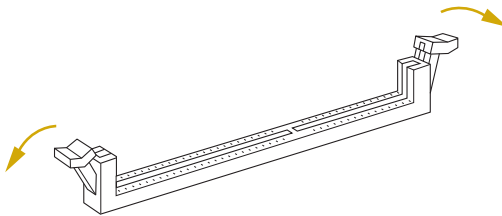

2

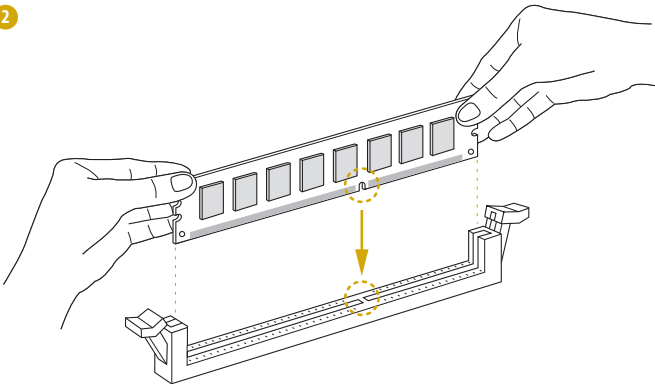

3

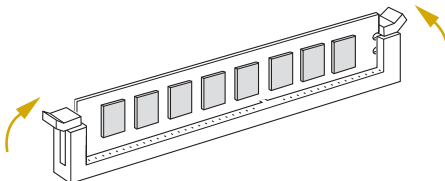

2.6 Expansion Slot (PCI Express Slot)

There is a PCI Express slot on this motherboard.

PCIe slot:

PCIe7 (PCIe 5.0 x16 slot) is used for PCI Express x16 lane width cards.

Slot	Generation	Mechanical	Electrical	Source
PCIe 7	5.0	x16	x16	CPU1

Installing an expansion card

- Step 1. Before installing an expansion card, please make sure that the power supply is switched off or the power cord is unplugged. Please read the documentation of the expansion card and make necessary hardware settings for the card before starting the installation.
- Step 2. Remove the system unit cover (if the motherboard is already installed in a chassis).
- Step 3. Remove the bracket facing the slot that intending to use. Keep the screws for later use.
- Step 4. Align the card connector with the slot and press firmly until the card is completely seated on the slot.
- Step 5. Fasten the card to the chassis with screws.
- Step 6. Replace the system cover.

2.7 Jumper Setup

The illustration shows how jumpers are setup. When the jumper cap is placed on the pins, the jumper is “Short”. If no jumper cap is placed on the pins, the jumper is “Open”. The illustration shows a 3-pin jumper whose pin1 and pin2 are “Short” when a jumper cap is placed on these 2 pins.

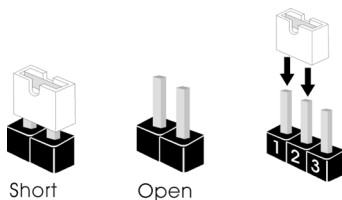

Security Override Jumper
 (3-pin SEC_OR1)
 (see p.6, No. 17)



Descriptor Security
 Override



Not override (Default)

2.8 Onboard Headers and Connectors



Onboard headers and connectors are NOT jumpers. Do NOT place jumper caps over these headers and connectors. Placing jumper caps over the headers and connectors will cause permanent damage to the motherboard.

System Panel Header
(9-pin PANEL1)
(see p.6, No. 19)

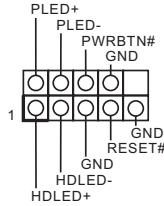

Connect the power switch, reset switch and system status indicator on the chassis to this header according to the pin assignments. Particularly note the positive and negative pins before connecting the cables.



PWRBTN (Power Switch):

Connect to the power switch on the chassis front panel. Configure the way to turn off the system using the power switch.

RESET (Reset Switch):

Connect to the reset switch on the chassis front panel. Press the reset switch to restart the computer if the computer freezes and fails to perform a normal restart.

PLED (System Power LED):

Connect to the power status indicator on the chassis front panel. The LED is on when the system is operating. The LED is off when the system is in S4 sleep state or powered off (S5).

HDLED (Hard Drive Activity LED):

Connect to the hard drive activity LED on the chassis front panel. The LED is on when the hard drive is reading or writing data.

The front panel design may differ by chassis. A front panel module mainly consists of power switch, reset switch, power LED, hard drive activity LED, speaker and etc. When connecting the chassis front panel module to this header, make sure the wire assignments and the pin assignments are matched correctly.

USB 3.2 Gen1 Header
(19-pin USB3_3_4)
(see p.6, No. 23)

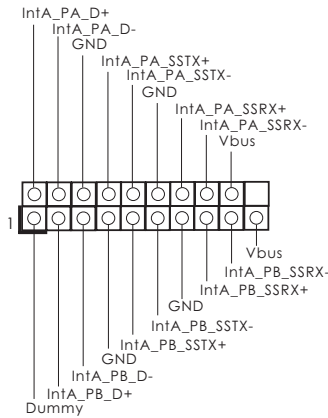

Besides two default USB 3.2 Gen1 ports on the I/O panel, there is one USB 3.2 Gen1 header on this motherboard. This USB 3.2 Gen1 header can support two USB 3.2 Gen1 ports.

SPI TPM Header
(13-pin TPM_BIOS_PH1)
(see p.6, No. 15)

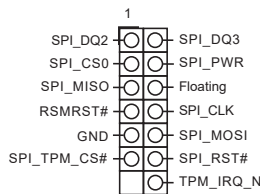

This connector supports SPI Trusted Platform Module (TPM) system, which can securely store keys, digital certificates, passwords, and data. A TPM system also helps enhance network security, protects digital identities, and ensures platform integrity.

Auxiliary Panel Header
(9-pin ITX_AUX_PANEL1)
(see p.6, No. 21)

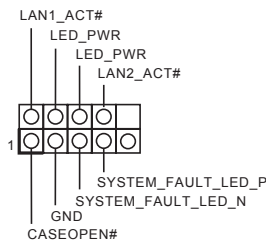

This header supports multiple functions on the front panel, including front panel SMB, internet status indicator.

Serial Port Header
(9-pin COM1)
(see p.6, No. 26)

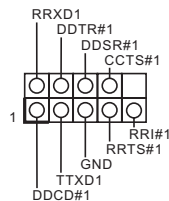

This COM header supports a serial port module.

NCSI Header
(9-pin NCSI1)
(see p.6, No.27)

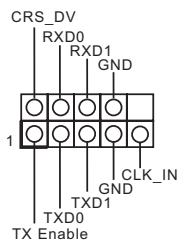

The onboard NCSI header is used for external connections.

Serial General Purpose Input/Output Header
(7-pin SATA_SGPIO1)
(see p.6, No. 18)

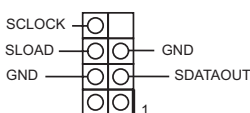

The header supports Serial Link interface for onboard SATA connections.

IPMI LAN LED Header
(4-pin IPMI_LED1)
(see p.6, No. 29)

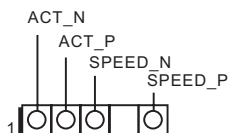

This header is used to connect to the LED indicators on the chassis.

UID Button Header
(4-pin UID_HD)
(see p.6, No.28)

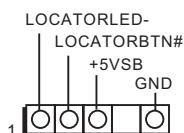

This header is used for UID button features.

Thermal Sensor Header
(3-pin TR1)
(see p.6, No. 10)



Please connect the thermal sensor cable to either pin 1-2 or pin 2-3 and the other end to the device to monitor its temperature.

PWM Configuration Header
(3-pin PWM_CFG1)
(see p.6, No. 25)

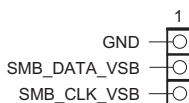

This header is used for PWM configurations.

ATX 12V Power Connector
(8-pin ATX12V1)
(see p.6, No. 4)

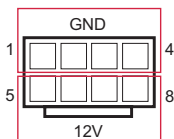

This motherboard provides one 8-pin ATX 12V power connector.

Micro-Fit ATX 4Pin Power Connector
(4-pin ATX4PIN1)
(ATX 24pin-to-4pin)
(see p.6, No. 5)

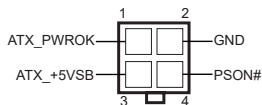

The motherboard provides one 4-pin power/signal connector which is a required input for ATX power source. When using ATX power, it is necessary to use a 24pin to 4pin power cable to connect between the 24pin power connector of PSU and the ATX12V1 connector on the motherboard for power supply and signal communication.

SATA Power Connector
(4-pin SATA_PWR1)
(see p.6, No. 3)

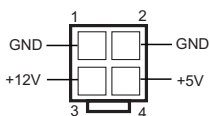

Please use a SATA power cable to connect this SATA Power Connector and the SATA HDD for supplying power from the motherboard, when using DC-IN mode without SATA power supply.

**Caution: Misconnection between the ATX4PIN1 and the SATA_PWR1 connectors may permanently damage the motherboard.*

OCuLink Connectors
(OCU1)
(see p.6, No. 20)
(OCU2)
(see p.6, No. 22)



Please connect PCIE or OCuLink-to-SATA x4 cable to the connectors.

PSU SMBus
(PSU_SMB1)
(see p.6, No. 8)

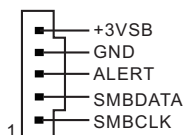

PSU SMBus monitors the status of the power supply, fan and system temperature.

System Fan
Connectors
(4-pin FAN1)
(see p.6, No. 9)
(4-pin FAN2)
(see p.6, No. 11)
(4-pin FAN3)
(see p.6, No. 13)

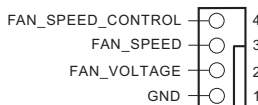

Please connect fan cables to the fan connectors and match the black wire to the ground pin. All fans support Fan Control.

Intelligent Platform
Management Bus Header
(4-pin IPMB1)
(see p.6, No. 2)

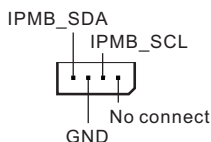

This 4-pin connector is used to provide a cabled base-board or front panel connection for value added features and 3rd-party add-in cards, such as Emergency Management cards, that provide management features using the IPMB.

Baseboard Management
Controller SMBus Header
(5-pin BMC_SMB1)
(see p.6, No. 1)

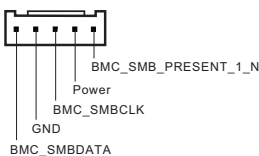

The header is used for the SM BUS devices.

Clear CMOS Pad
(CLRMOSE1)
(see p.6, No. 16)



CLRMOSE1 allows user to clear the data in CMOS. To clear CMOS, take out the CMOS battery and short the Clear CMOS Pad.

2.9 Unit Identification purpose LED/Switch

The UID button allows user to locate the server working on from behind a rack of servers.

Unit Identification
purpose LED/Switch
(UID1)



When the UID button on the front or rear panel is pressed, the front/rear UID blue LED indicator will be turned on. Press the UID button again to turn off the indicator.



- 1. Press and hold the UID button for 4 seconds, the BMC will trigger an external reset.*
- 2. Press and hold the UID button for 10 seconds, the BMC will reset and load default values.*

2.10 ATX PSU / DC-IN Power Connections

This motherboard supports both +12V DC and ATX power input. Please refer to the table below for the required connections between the motherboard and the power supply.

Connector	DC-IN	ATX PSU
12V 8pin	O	O
ATX 4pin	X	O <i>(with the bundled ATX 24pin-to-4pin converter cable)</i>

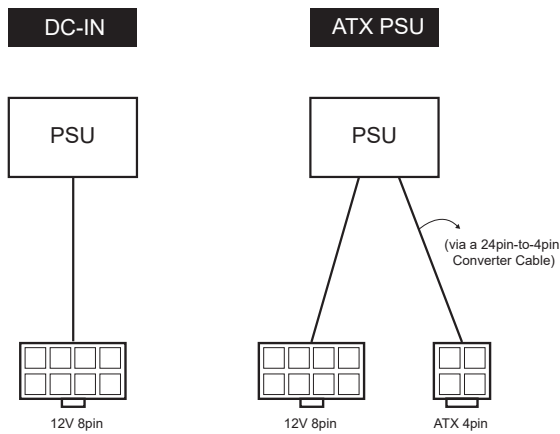

The following diagram illustrates how to connect the bundled ATX 24pin-to-4pin converter cable.

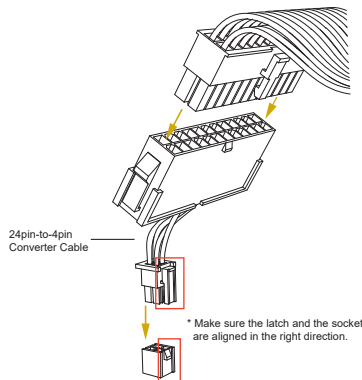

2.11 Dual LAN and Teaming Operation Guide

Dual LAN with Teaming enabled on this motherboard allows two single connections to act as one single connection for twice the transmission bandwidth, making data transmission more effective and improving the quality of transmission of distant images. Fault tolerance on the dual LAN network prevents network downtime by transferring the workload from a failed port to a working port.



The speed of transmission is subject to the actual network environment or status even with Teaming enabled.

Before setting up Teaming, please make sure whether the Switch (or Router) supports Teaming (IEEE 802.3ad Link Aggregation). specify a preferred adapter in Intel PROSet. Under normal conditions, the Primary adapter handles all non-TCP/IP traffic. The Secondary adapter will receive fallback traffic if the primary fails. If the Preferred Primary adapter fails, but is later restored to an active status, control is automatically switched back to the Preferred Primary adapter.

Step 1

From **Device Manager**, open the properties of a team.

Step 2

Click the **Settings** tab.

Step 3

Click the **Modify Team** button.

Step 4

Select the adapter that wants to be the primary adapter and click the **Set Primary** button.

The software will choose an adapter of the highest capability (model and speed) to act as the default primary upon not specify a preferred primary adapter. If a failover occurs, another adapter becomes the primary. The adapter will, however, rejoin the team as a non-primary.

2.12 M.2 SSD Module Installation Guide

The M.2 Socket (M2_1, Key M) supports type 2280 M.2 PCI Express module up to Gen4 x4 (16GT/s x4).

Installing the M.2 SSD Module

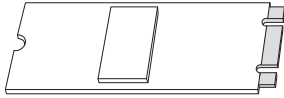

Step 1

Prepare a M.2 SSD module and the screw.

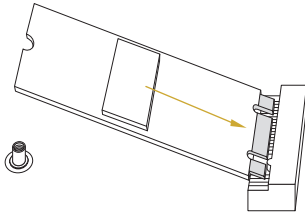

Step 2

Gently insert the M.2 SSD module into the M.2 slot. Please be aware that the M.2 SSD module only fits in one orientation.

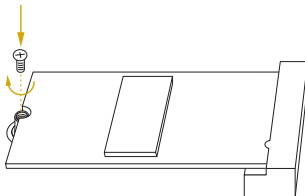
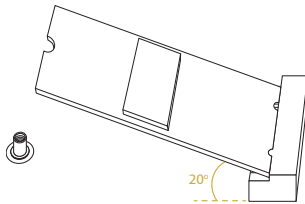

Step 3

Tighten the screw with a screwdriver to secure the module into place. Please do not overtighten the screw as this might damage the module.

Chapter 3 UEFI Setup Utility

3.1 Introduction

This section explains how to use the UEFI SETUP UTILITY to configure the system. The UEFI chip on the motherboard stores the UEFI SETUP UTILITY. Run the UEFI SETUP UTILITY when starting up the computer. Please press <F2> or during the Power-On-Self-Test (POST) to enter the UEFI SETUP UTILITY; otherwise, POST will continue with its test routines.

Restart the system by pressing <Ctrl> + <Alt> + <Delete> to enter the UEFI SETUP UTILITY after POST, or by pressing the reset button on the system chassis. This allows user to restart by turning the system off and then back on.



Because the UEFI software is constantly being updated, the following UEFI setup screens and descriptions are for reference purpose only, and they may not exactly match what seeing on the screen.

3.1.1 UEFI Menu Bar

The top of the screen has a menu bar with the following selections:

Item	Description
Main	To set up the system time/date information
Advanced	To set up the advanced UEFI features
Server Mgmt	To manage the server
Event Logs	For event log configuration
Security	To set up the security features
Boot	To set up the default system device to locate and load the Operating System
Exit	To exit the current screen or the UEFI SETUP UTILITY

Use <←> key or <→> key to choose among the selections on the menu bar, and then press <Enter> to get into the sub screen.

3.1.2 Navigation Keys

Please check the following table for the function description of each navigation key.

Navigation Key(s)	Function Description
← / →	Moves cursor left or right to select Screens
↑ / ↓	Moves cursor up or down to select items
+ / -	To change option for the selected items
<Tab>	Switch to next function
<Enter>	To bring up the selected screen
<PGUP>	Go to the previous page
<PGDN>	Go to the next page
<HOME>	Go to the top of the screen
<END>	Go to the bottom of the screen
<F1>	To display the General Help Screen
<F7>	Discard changes and exit the UEFI SETUP UTILITY
<F9>	Load optimal default values for all the settings
<F10>	Save changes and exit the UEFI SETUP UTILITY
<F12>	Print screen
<ESC>	Jump to the Exit Screen or exit the current screen

3.2 Main Screen

Once entering the UEFI SETUP UTILITY, the Main screen will appear and display the system overview. The Main screen provides system overview information and allows user to set the system time and date.



3.2.1 Motherboard Information

Press [Enter] to view the information of the motherboard.

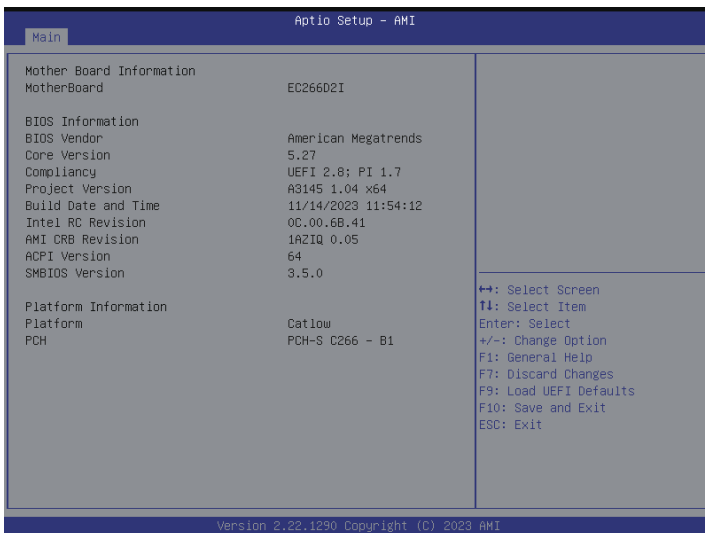

3.2.2 Processor Information

Press [Enter] to view the information of the processor.

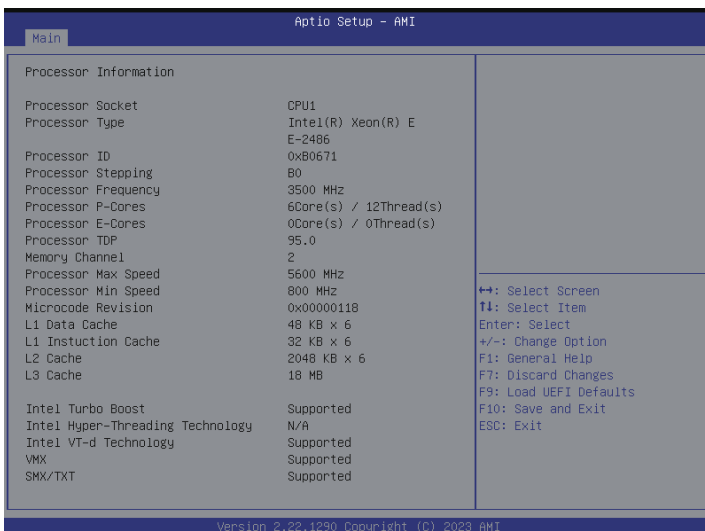

3.2.3 Memory Information

Press [Enter] to view the information of the memory.

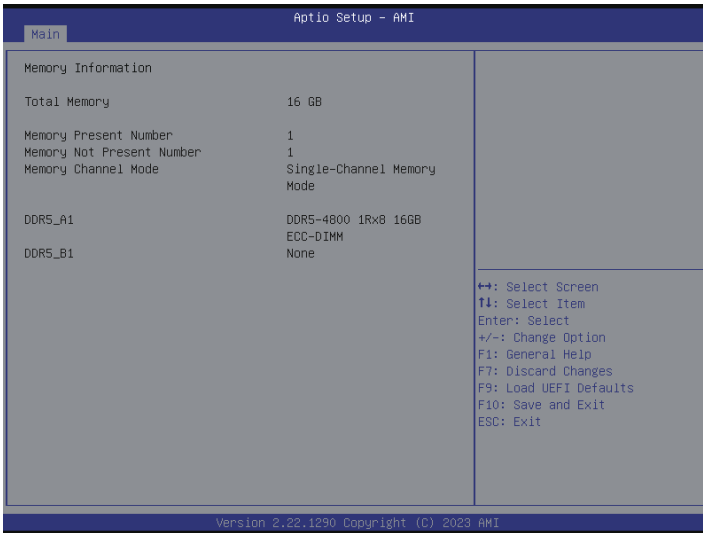

3.3 Advanced Screen

In this section, set the configurations for the following items: CPU Configuration, DRAM Configuration, Chipset Configuration, Storage Configuration, NVMe Configuration, ACPI Configuration, USB Configuration, Super IO Configuration, Serial Port Console Redirection, H/W Monitor, Network Stack Configuration, Intel SPS Configuration, Drive Health, RAM Disk Configuration, Tls Auth Configuration and Instant Flash.

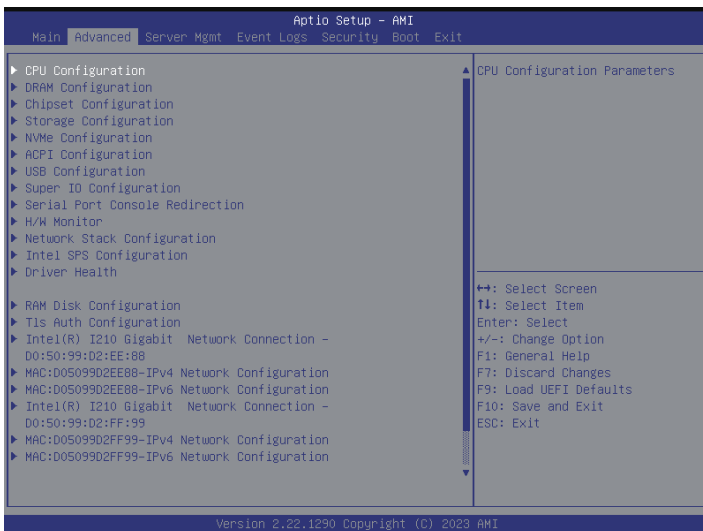

Setting wrong values in this section may cause the system to malfunction.

3.3.1 CPU Configuration

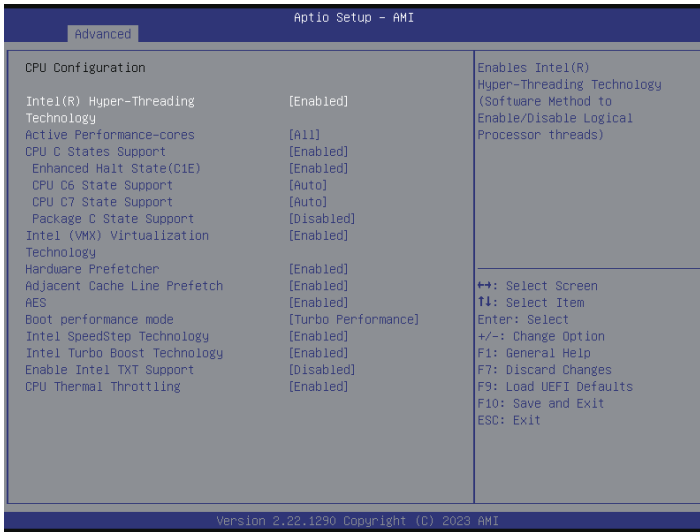

Intel(R) Hyper Threading Technology

Intel Hyper Threading Technology allows multiple threads to run on each core, so that the overall performance on threaded software is improved.

Active Performance-Cores

Select the number of cores to enable in each processor package.



Please note that the Number of Cores and E-cores are looked at together. When both of them are {0,0}, Pcode will enable all cores.

CPU C States Support

Enable CPU C States Support for power saving. It is recommended to keep C6 and C7 enabled for better power saving.

Enhanced Halt State (C1E)

Enable Enhanced Halt State (C1E) for lower power consumption.

CPU C6 State Support

Use this item to enable C6 deep sleep state for lower power consumption.

CPU C7 State Support

Use this item to enable C7 deep sleep state for lower power consumption.

Package C State Support

Use this item to enable CPU, PCIe, Memory, Graphics C State Support for power saving.

Intel (VMX) Virtualization Technology

When enabled, a VMM can utilize the additional hardware capabilities provided by Vanderpool Technology.

Hardware Prefetcher

Automatically prefetch data and code for the processor. Enable for better performance.

Adjacent Cache Line Prefetch

Automatically prefetch the subsequent cache line while retrieving the currently requested cache line. Enable for better performance.

AES

Use this item to enable or disable AES (Advanced Encryption Standard).

Boot Performance Mode

Select the performance state that the BIOS will set starting from reset vector.

Intel SpeedStep Technology

Intel SpeedStep technology allows processors to switch between multiple frequencies and voltage points for better power saving and heat dissipation. CPU turbo ratio can be fixed when Intel SpeedStep Technology set Disabled and Intel Turbo Boost Technology set Enabled.

Intel Turbo Boost Technology

Intel Turbo Boost Technology enables the processor to run above its base operating frequency when the operating system requests the highest performance state.

Enable Intel TXT Support

Enable the utilization of additional hardware capabilities provided by Intel(R) Trusted Execution Technology. It requires a full power cycle to change this for taking effect.

CPU Thermal Throttling

Enable CPU internal thermal control mechanisms to keep the CPU from overheating.

3.3.2 DRAM Configuration



DRAM Frequency

If [Auto] is selected, the motherboard will detect the memory module(s) inserted and assign the appropriate frequency automatically.

3.3.3 Chipset Configuration

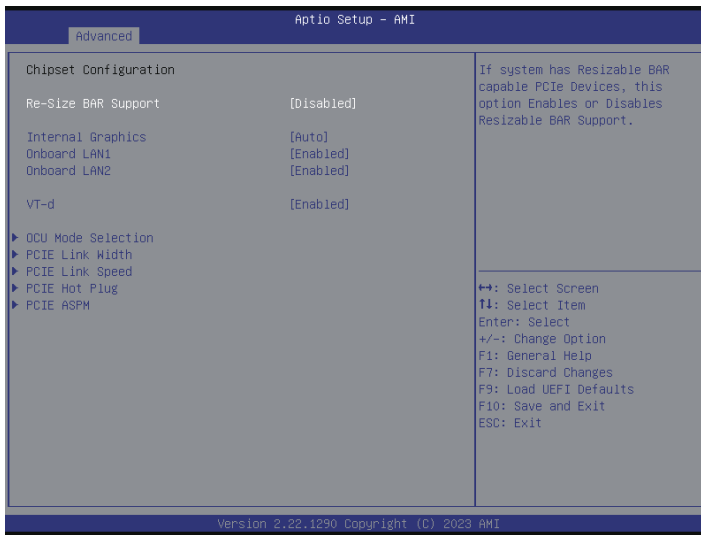

Re-Size BAR Support

If system has Resizable BAR capable PCIe Devices, select this item to enable or disable Resizable BAR Support.

Internal Graphics

Use this item to keep IGFX enabled based on the setup options.

Onboard LAN1/LAN2

Use this item to enable or disable the Onboard LAN function.

VT-d

Intel Virtualization Technology for Directed I/O helps the virtual machine monitor better utilize hardware by improving application compatibility and reliability, and providing additional levels of manageability, security, isolation, and I/O performance.

OCU Mode Selection

Select this item to configure SATA or PCIe in OCU port.

OCU1/OCU2 Mode Selection

Select SATA or PCIe work in OCU port.

PCIE Link Width

Select this item to configure PCIE Link Width.

PCIE7 Link Width

Select the Link Width for PCIE7.

PCIE Link Speed

Select PCIE Link Speed.

PCIE7 Link Speed

Configure the PCIe Speed for PCIE7.

M2_1 Link Speed

Configure the PCIe Speed for M2_1.

OCU1/2 Link Speed

Configure the PCIe Speed for OCU1/2.

PCIE Hot Plug

Select this item to configure PCIE Hot Plug globally.

OCU1/2 Hot Plug

Enable or disable PCIE Hot Plug.

PCIE ASPM

Select this item to configure the PCIE Active State Power Management settings.

PCI-E ASPM Support (Global)

Select this item to enable or disable the ASPM Support for all PCIE downstream devices.

PCIE7 ASPM Support

Select this item to enable or disables the ASPM support for all PCIE downstream devices.

Select [Auto] for the default value.

OCU1/2 ASPM Support

Select this item to enable or disables the ASPM support for all PCIE downstream devices.

3.3.4 Storage Configuration

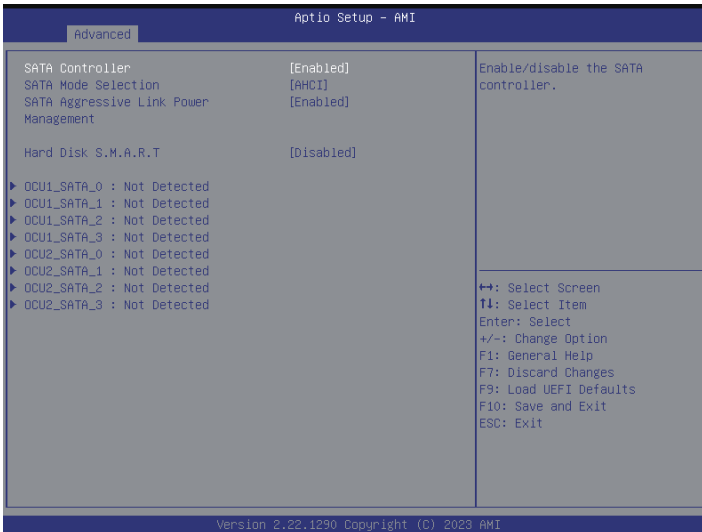

SATA Controller

Select this item to enable or disable the SATA controllers.

SATA Mode Selection

AHCI: Supports new features that improve performance.

RAID: Combine multiple disk drives into a logical unit.

Please press <CTRL-I> to enter RAID ROM during UEFI POST process.

SATA Aggressive Link Power Management

SATA Aggressive Link Power Management allows SATA devices to enter a low power state during periods of inactivity to save power. Select this item to enable or disable the function.

Hard Disk S.M.A.R.T.

S.M.A.R.T stands for Self-Monitoring, Analysis, and Reporting Technology. It is a monitoring system for computer hard disk drives to detect and report on various indicators of reliability.

OCU1_SATA_0/1/2/3, OCU2_SATA_0/1/2/3

Select this item to configure the External SATA, Hot Plug, Spin Up Device and SATA Device Type.

3.3.5 NVMe Configuration



The NVMe Configuration displays the NVMe controller and Drive information.

3.3.6 ACPI Configuration



PCIE Devices Power On

Allow the system to be waked up by a PCIE device and enable wake on LAN.

Ring-In Power On

Allow the system to be waked up by onboard COM port modem Ring-In signals.

RTC Alarm Power On

Allow the system to be waked up by the real time clock alarm. Set it to By OS to let it be handled by the operating system.

RTC Alarm Date

Use this item to set Date of RTC power on feature.

RTC Alarm Hour

Use this item to set Hour of RTC power on feature.

RTC Alarm Minute

Use this item to set Minute of RTC power on feature.

RTC Alarm Second

Use this item to set Second of RTC power on feature.

3.3.7 USB Configuration

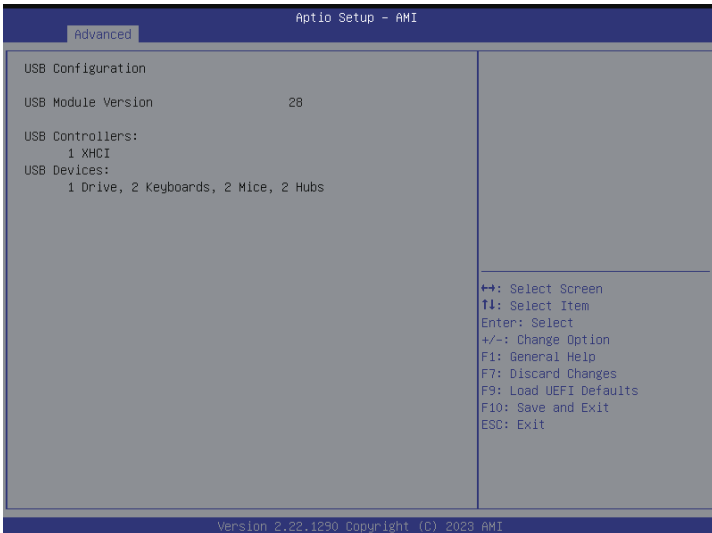

This page displays the information of the USB controllers and USB devices.

3.3.8 Super IO Configuration

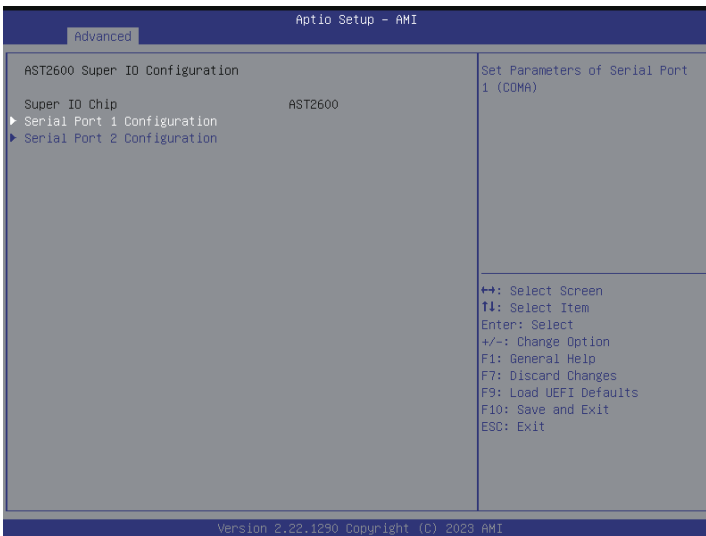

Serial Port 1 Configuration

Use this item to set parameters of Serial Port1 (COMA).

Serial Port

Use this item to enable or disable the serial port (COM).

Change Settings

Use this item to select an optimal setting for Super IO device.

Serial Port 2 Configuration

Use this item to set parameters of Serial Port2 (COMB).

Serial Port

Use this item to enable or disable the serial port (COM).

Change Settings

Use this item to select an optimal setting for Super IO device.

3.3.9 Serial Port Console Redirection

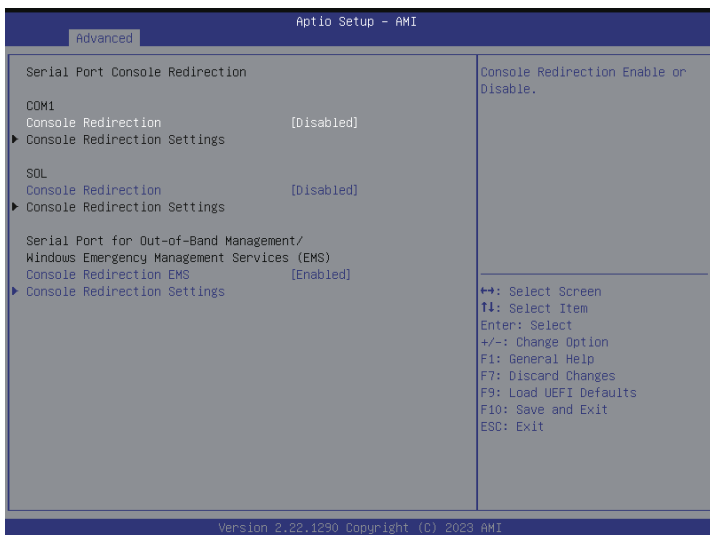

COM1 / SOL

Console Redirection

Use this item to enable or disable Console Redirection. If this item is set to Enabled, user can configure the Console Redirection Settings.

Console Redirection Settings

Use this item to configure Console Redirection Settings, and specify how the computer and host computer to which user are connected exchange information. Both computers should have the same or compatible settings.

Terminal Type

Use this item to select the preferred terminal emulation type for out-of-band management. It is recommended to select [VT-UTF8].

Option	Description
VT100	ASCII character set
VT100Plus	Extended VT100 that supports color and function keys
VT-UTF8	UTF8 encoding is used to map Unicode chars onto 1 or more bytes
ANSI	Extended ASCII character set

Bits Per Second

Use this item to select the serial port transmission speed. The speed used in the host computer and the client computer must be the same. Long or noisy lines may require lower transmission speed. The options include [9600], [19200], [38400], [57600] and [115200].

Data Bits

Use this item to set the data transmission size. The options include [7] and [8] (Bits).

Parity

Use this item to select the parity bit. The options include [None], [Even], [Odd], [Mark] and [Space]. A parity bit can be sent with the data bits to detect some transmission errors. Mark and Space Parity do not allow for error detection. They can be used as an additional data bit.

Even: parity bit is 0 if the num of 1's in the data bits is even.

Odd: parity bit is 0 if num of 1's in the data bits is odd.

Mark: parity bit is always 1.

Space: Parity bit is always 0.

Stop Bits

The item indicates the end of a serial data packet. The standard setting is [1] Stop Bit. Select [2] Stop Bits for slower devices.

Flow Control

Use this item to set the flow control to prevent data loss from buffer overflow. When sending data, if the receiving buffers are full, a "stop" signal can be sent to stop the data flow. Once the buffers are empty, a "start" signal can be sent to restart the flow. Hardware flow uses two wires to send start/stop signals. The options include [None] and [Hardware RTS/CTS].

VT-UTF8 Combo Key Support

Use this item to enable or disable the VT-UTF8 Combo Key Support for ANSI/VT100 terminals.

Recorder Mode

Use this item to enable or disable Recorder Mode to capture terminal data and send it as text messages.

Resolution 100x31

Use this item to enable or disable extended terminal resolution support.

Putty KeyPad

Use this item to select Function Key and Keypad on Putty.

Serial Port for Out-of-Band Management/Windows Emergency Management Services (EMS)

Console Redirection EMS

Use this item to enable or disable Console Redirection. If this item is set to Enabled, user can configure the Console Redirection Settings.

Console Redirection Settings

Use this item to configure Console Redirection Settings, and specify how the computer and the host computer to which user are connected exchange information.

Out-of-Band Mgmt Port

Microsoft Windows Emergency Management Services (EMS) allows for remote management of a Windows Server OS through a serial port.

Terminal Type EMS

Use this item to select the preferred terminal emulation type for out-of-band management. It is recommended to select [VT-UTF8].

Option	Description
VT100	ASCII character set
VT100+	Extended VT100 that supports color and function keys
VT-UTF8	UTF8 encoding is used to map Unicode chars onto 1 or more bytes
ANSI	Extended ASCII character set

Bits Per Second EMS

Use this item to select the serial port transmission speed. The speed used in the host computer and the client computer must be the same. Long or noisy lines may require lower transmission speed. The options include [9600], [19200], [57600] and [115200].

Flow Control EMS

Use this item to set the flow control to prevent data loss from buffer overflow. When sending data, if the receiving buffers are full, a "stop" signal can be sent to stop the data flow. Once the buffers are empty, a "start" signal can be sent to restart the flow. Hardware flow uses two wires to send start/stop signals. The options include [None], [Hardware RTS/CTS], and [Software Xon/Xoff].

Data Bits EMS

Parity EMS

Stop Bits EMS

3.3.10 H/W Monitor

In this section, it allows user to monitor the status of the hardware on the system, including the parameters of the CPU temperature, motherboard temperature, CPU fan speed, chassis fan speed, and the critical voltage.

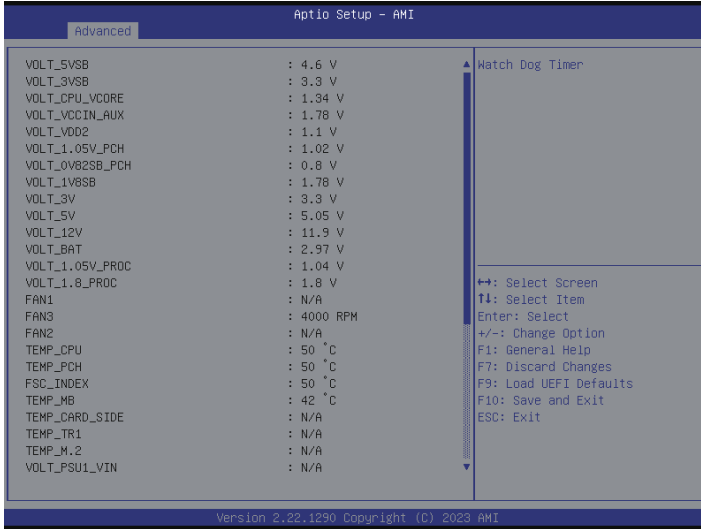

3.3.11 Network Stack Configuration

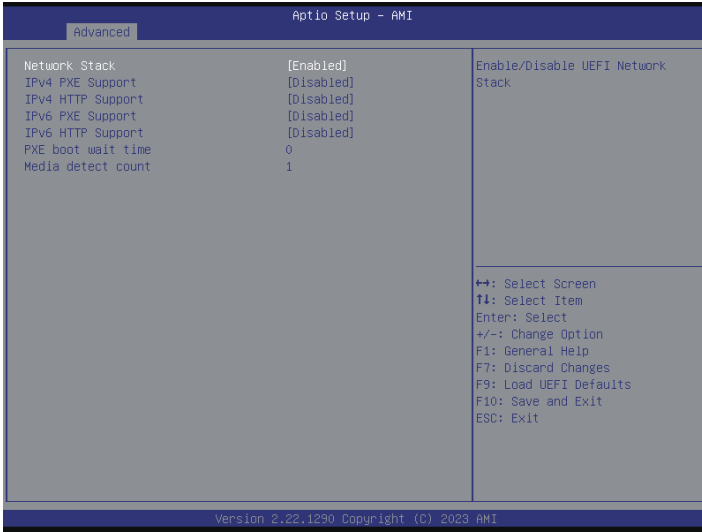

Network Stack

Use this item to enable or disable UEFI Network Stack.

IPv4 PXE Support

Use this item to enable or disable IPv4 PXE boot support. If disabled, IPv4 PXE boot support will not be available.

IPv4 HTTP Support

Use this item to enable or disable IPv4 HTTP boot support. If disabled, IPv4 HTTP boot support will not be available.

IPv6 PXE Support

Use this item to enable or disable IPv6 PXE boot support. If disabled, IPv6 PXE boot support will not be available.

IPv6 HTTP Support

Use this item to enable or disable IPv6 HTTP boot support. If disabled, IPv6 HTTP boot support will not be available.

PXE Boot Wait Time

Specifies the wait time and press the ESC key to abort the PXE boot.

Media Detect Count

Specifies the number of times the presence of physical storage device are verified on a system reset or power cycle.

3.3.12 Intel SPS Configuration

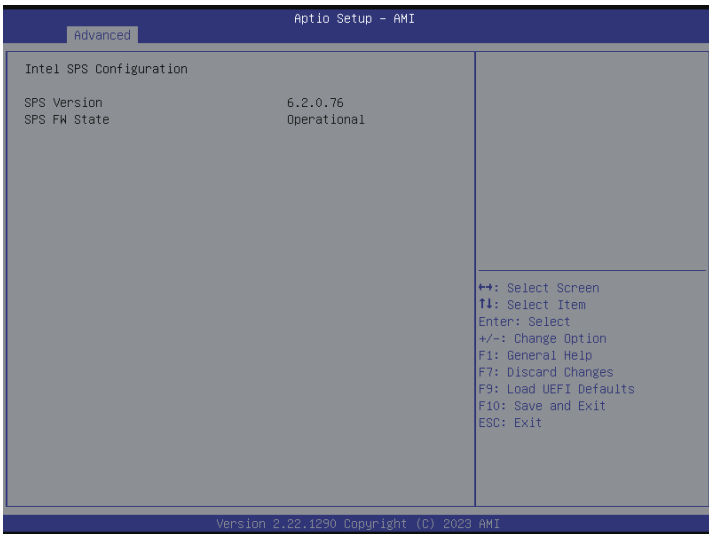

SPS screen displays the Intel SPS Configuration information, such as Operational Firmware Version and Firmware State.

3.3.13 Driver Health



Inter (R) PRO/1000 6.5.01 PCI-E Healthy

Provides Health Status for the Drivers/Controllers

Inter (R) Gigabit 0.2.01 Healthy

Provides Health Status for the Drivers/Controllers

3.3.14 RAM Disk Configuration

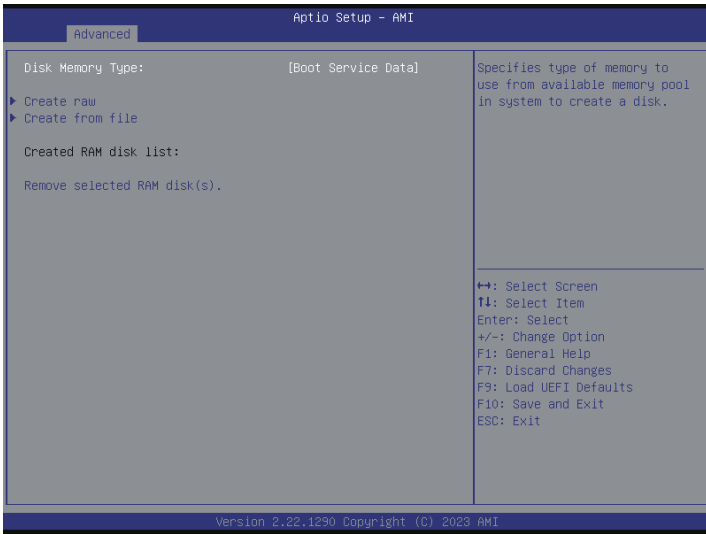

Disk Memory Type

Specifies type of memory to use from available memory pool in system to create a disk.

Create raw

Create a raw RAM disk.

Create from file

Create a RAM disk from a given file.

Remove selected RAM disk(s)

Remove selected RAM disk(s).

3.3.15 Tls Auth Configuration



Server CA Configuration

Press <Enter> to configure Server CA.

Client Cert Configuration

Press <Enter> to configure Client Cert.

Enroll Cert

Press <Enter> to enroll cert.

Delete Cert

Press <Enter> to delete cert.

3.3.16 Instant Flash

Instant Flash is a UEFI flash utility embedded in Flash ROM. This convenient UEFI update tool allows user to update system UEFI without entering operating systems first like MS-DOS or Windows. Just save the new UEFI file to the USB flash drive, floppy disk or hard drive and launch this tool, then update the UEFI only in a few clicks without preparing an additional floppy diskette or other complicated flash utility. Please be noted that the USB flash drive or hard drive must use FAT32/16/12 file system. Execute the Instant Flash utility, the utility will show the UEFI files and the respective information. Select the proper UEFI file to update UEFI, and reboot the system after the UEFI update process is completed.

3.4 Server Mgmt



Wait For BMC

Wait For BMC response for specified time out. BMC starts at the same time when BIOS starts during AC power ON. It takes around 255 seconds to initialize Host to BMC interfaces.

FRB-2 Timer

Use this item to enable or disable FRB-2 timer (POST timer).

FRB-2 Timer Timeout

Enter value between 1 to 30 min for FRB-2 Timer Expiration.

FRB-2 Timer Policy

Use this item to configure how the system should respond if the FRB-2 Timer expires. Not available if FRB-2 Timer is disabled.

OS Watchdog Timer

If enabled, starts a BIOS timer which can only be shut off by Management Software after the OS loads. Helps determine that the OS successfully loaded or follows the OS Boot Watchdog Timer policy.

OS Wtd Timer Timeout

Configure the OS Boot Watchdog Timer Expiration between 1 to 30 min value. If the OS Boot Watchdog Timer is disabled, this item is not available.

OS Wtd Timer Policy

Configure how the system should respond if the OS Boot Watchdog Timer expires. If the OS Boot Watchdog Timer is disabled, this item is not available.

BMC Network Configuration

Select this item to configure BMC network parameters.

DNS Configuration

Select this item to configure DNS parameters.

System Event Log

Press <Enter> to change the SEL event log configuration.

BMC Tools

Select this item to configure about KCS control, restore AC power loss and load BMC default settings.

3.4.1 BMC Network Configuration

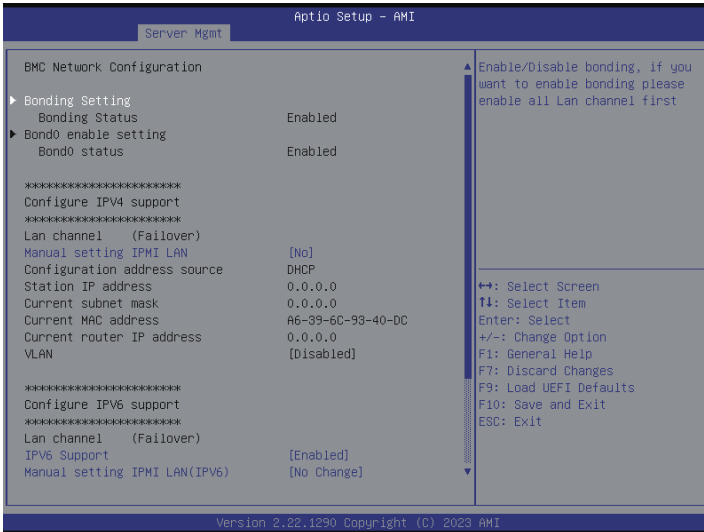

Bonding Setting

Select this item to enabled or disabled bonding. Please enable all lan channel first when want to enable bonding.

Lan Channel (Failover)

Manual Setting IPMI LAN

If [No] is selected, the IP address is assigned by DHCP. If using a static IP address, toggle to [Yes], and the changes take effect after the system reboots. The default value is [No].

Configuration Address Source

Select to configure BMC network parameters statically or dynamically(by BIOS or BMC). Configuration options: [Static] and [DHCP].

Static: Manually enter the IP Address, Subnet Mask and Gateway Address in the BIOS for BMC LAN channel configuration.

DHCP: IP address, Subnet Mask and Gateway Address are automatically assigned by the network's DHCP server.



When [DHCP] or [Static] is selected, do NOT modify the BMC network settings on the IPMI web page.



The default login information for the IPMI web interface is:

Username: admin

Password: admin

For more instructions on how to set up remote control environment and use the IPMI management platform, please refer to the IPMI Configuration User Guide or go to the Support website at: <http://www.asrockrack.com/support/faq.asp>

VLAN

Select this item to enabled or disabled Virtual Local Area Network.

If [Enabled] is selected, allows user to configure the VLAN ID and VLAN Priority.

IPV6 Support

Select this item to enabled or disable IPV6 Support.

Manual Setting IPMI LAN (IPV6)

Select to configure LAN channel parameters statically or dynamically(by BIOS or BMC).

Unspecified option will not modify any BMC network parameters during BIOS phase.

3.4.2 DNS Configuration

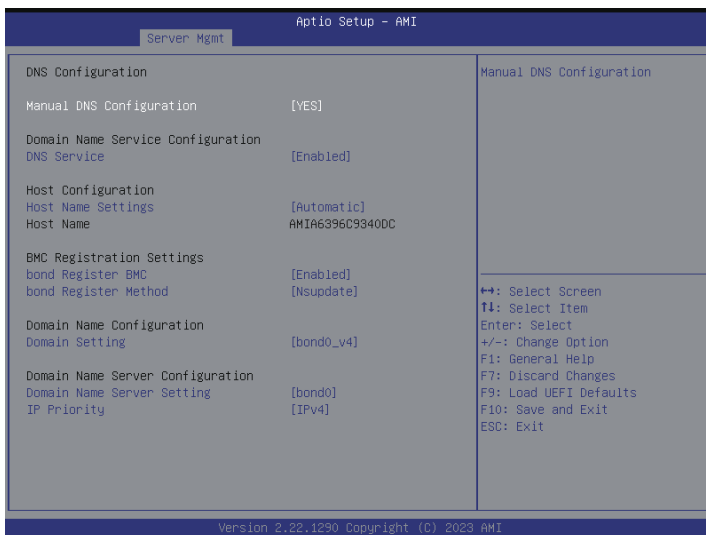

Manual DNS Configuration

Select this item to manual configure DNS.

If [YES] is selected, configure the items below.

DNS Service

Select this item to enable or disable DNS Service Configuration.

Host Name Settings

Select this item to automatic or manual Host Name Settings.

Bond Register BMC

Select this item to enable or disable Bond Register BMC.

Bond Register Method

Select this item to configure Bond Register Method with Nsupdate or DHCP client FQDN/Hostname..

Domain Setting

This item supports Manual, Bond0_v4 and Bond0_v6 Domain Settings.

Domain Name Server Setting

Select this item to configure DNS Server Settings.

IP Priority

Select this item to configure IP Priority.

3.4.3 System Event Log

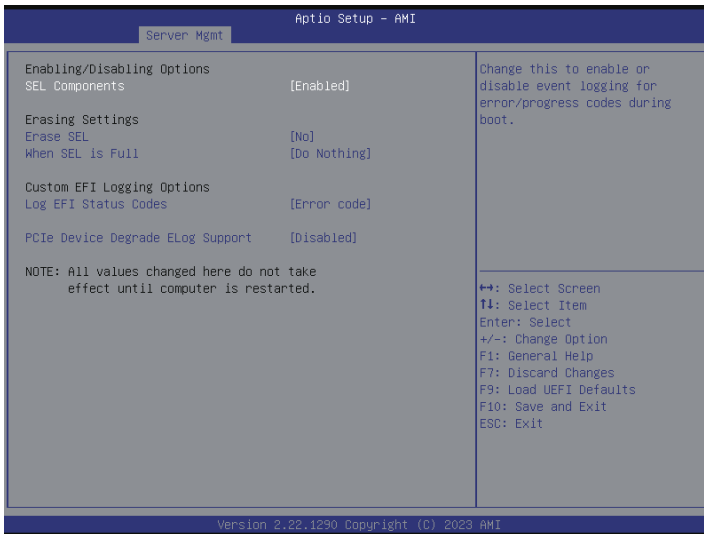

SEL Components

Change this to enable or disable event logging for error/progress codes during boot.

Erase SEL

Use this to choose options for erasing SEL.

When SEL is Full

Use this to choose options for reactions to a full SEL.

Log EFI Status Codes

Use this item to disable the logging of EFI Status Codes or log only error code or only progress or both.

PCIe Device Degrade ELog Support

Use this item to enable or disable PCIe Device Degrade Error Logging Support.

3.4.4 BMC Tools

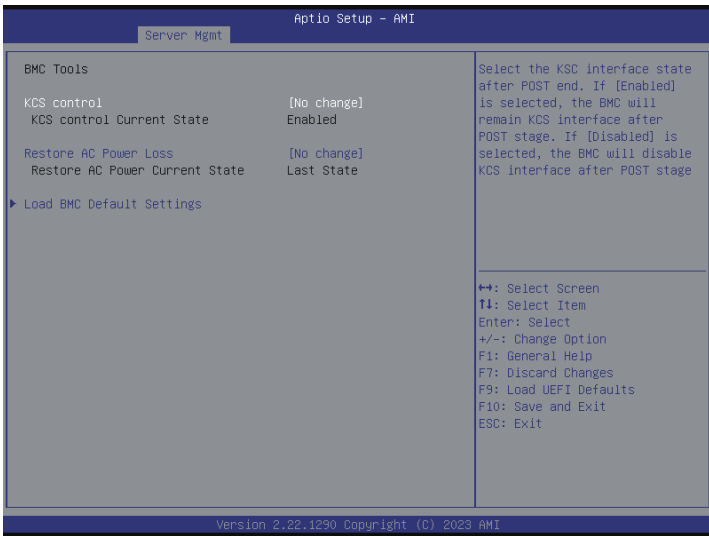

KCS Control

Select this KCS interface state after POST end. If [Enabled] is selected, the BMC will remain KCS interface after POST stage. If [Disabled] is selected, the BMC will disable KCS interface after POST stage

Restore AC Power Loss

This allows user to set the power state after an unexpected AC/power loss. If [Power Off] is selected, the AC/power remains off when the power recovers. If [Power On] is selected, the AC/power resumes and the system starts to boot up when the power recovers. If [Last State] is selected, it will recover to the state before AC/power loss.

Load BMC Default Settings

Use this item to Load BMC Default Settings

3.5 Event Logs



Change Smbios Event Log Settings

Select this item to configure the Smbios Event Log Settings.

When entering the item, the screen displays following sub-items:

Smbios Event Log

Select this item to enable or disable all features of the SMBIOS Event Logging during system boot.

Erase Event Log

This item is for erasing Smbios Event Log. Erasing is done prior to any logging activation during reset.

When Log is Full

Select this item to choose options for reactions to a full Smbios Event Log. The options include [Do Nothing] and [Erase Immediately].

Log System Boot Event

Select this item to enable or disable logging of System boot event.

View Smbios Event Log

Press <Enter> to view the Smbios Event Log records.



All values changed here do not take effect until computer is restarted.

3.6 Security Screen

This section allows user to set or change the supervisor/user password for the system. For the user password item is allowed user to clear it.

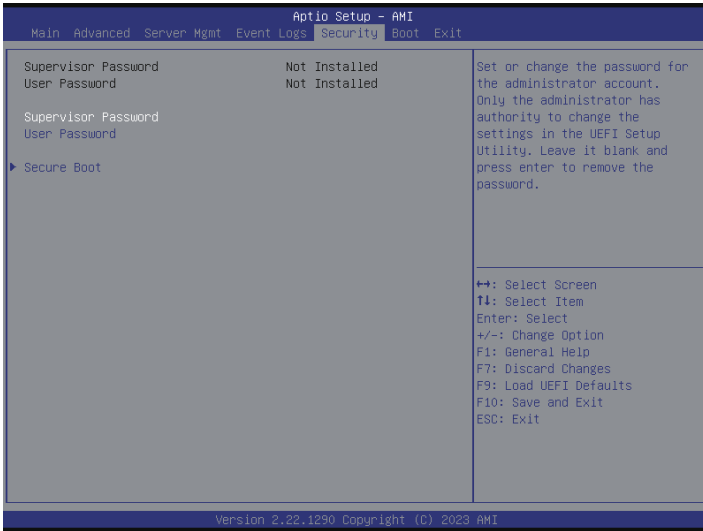

Supervisor Password

Set or change the password for the administrator account. Only the administrator has authority to change the settings in the UEFI Setup Utility. Leave it blank and press enter to remove the password.

User Password

Set or change the password for the user account. Users are unable to change the settings in the UEFI Setup Utility. Leave it blank and press enter to remove the password.

Secure Boot

Use this item to enable or disable support for Secure Boot. If Secure Boot is Enabled, Platform Key (PK) is enrolled and the System is in User mode. The mode change requires platform reset.

Secure Boot Mode

Support Standard or Custom. In Custom mode, Secure Boot Policy variables can be configured by a physically present user without full authentication.

Install Default Secure Boot Keys

Please install default secure boot keys if it's the first time using secure boot.

Clear Secure Boot Keys

Use this to clear the secure boot keys.

Expert Key Management

Enables expert users to modify Secure Boot Policy variables without variable authentication.

3.6.1 Key Management

In this section, expert users can modify Secure Boot Policy variables without variable authentication.

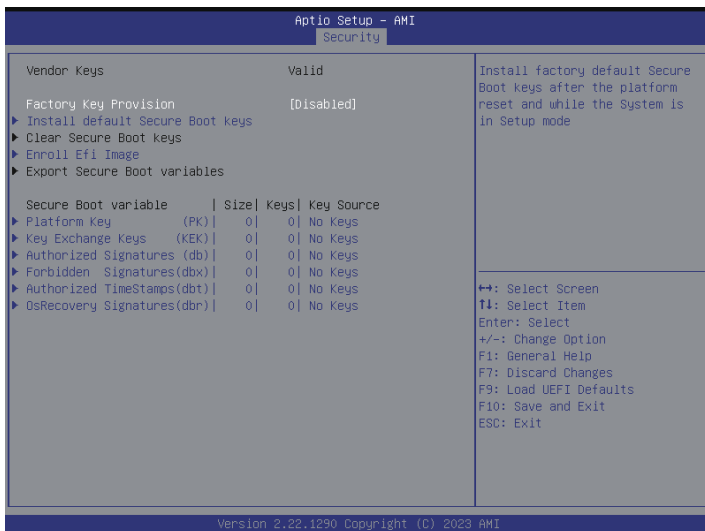

Factory Key Provision

Install factory default Secure Boot keys after the platform reset and while the System is in Setup mode.

Install Default Secure Boot Keys

Please install default secure boot keys if it's the first time using secure boot.

Clear Secure Boot Keys

Use this to clear the secure boot keys.

Enroll Efi Image

Allow the Efi image to run in Secure Boot mode. Enroll SHA256 Hash certificate of a PE image into Authorized Signature Database (db).

Export Secure Boot Variables

Save NVRAM content of Secure Boot variables to files.

Platform Key(PK)

Enroll Factory Defaults or load certificates from a file:

1. Public Key Certificate in:

- a) EFI_SIGNATURE_LIST
- b) EFI_CERT_X509 (DER)
- c) EFI_CERT_RSA2048 (bin)
- d) EFI_CERT_SHAXXX

2. Authenticated UEFI Variable

3. EFI PE/COFF Image(SHA256)

Key Source: Factory, Modified, Mixed

Key Exchange Keys(KEK)

Enroll Factory Defaults or load certificates from a file:

1. Public Key Certificate in:

- a) EFI_SIGNATURE_LIST
- b) EFI_CERT_X509 (DER)
- c) EFI_CERT_RSA2048 (bin)
- d) EFI_CERT_SHAXXX

2. Authenticated UEFI Variable

3. EFI PE/COFF Image(SHA256)

Key Source: Factory, Modified, Mixed

Authorized Signatures(db)

Enroll Factory Defaults or load certificates from a file:

1. Public Key Certificate in:

- a) EFI_SIGNATURE_LIST
- b) EFI_CERT_X509 (DER)
- c) EFI_CERT_RSA2048 (bin)
- d) EFI_CERT_SHAXXX

2. Authenticated UEFI Variable
3. EFI PE/COFF Image(SHA256)

Key Source: Factory, Modified, Mixed

Forbidden Signatures(dbx)

Enroll Factory Defaults or load certificates from a file:

1. Public Key Certificate in:

- a) EFI_SIGNATURE_LIST
- b) EFI_CERT_X509 (DER)
- c) EFI_CERT_RSA2048 (bin)
- d) EFI_CERT_SHAXXX

2. Authenticated UEFI Variable

3. EFI PE/COFF Image(SHA256)

Key Source: Factory, Modified, Mixed

Authorized TimeStamps(dbt)

Enroll Factory Defaults or load certificates from a file:

1. Public Key Certificate in:

- a) EFI_SIGNATURE_LIST
- b) EFI_CERT_X509 (DER)
- c) EFI_CERT_RSA2048 (bin)
- d) EFI_CERT_SHAXXX

2. Authenticated UEFI Variable

3. EFI PE/COFF Image(SHA256)

Key Source: Factory, Modified, Mixed

OsRecovery Signatures(dbr)

Enroll Factory Defaults or load certificates from a file:

1. Public Key Certificate in:

- a) EFI_SIGNATURE_LIST

- b) EFI_CERT_X509 (DER)
 - c) EFI_CERT_RSA2048 (bin)
 - d) EFI_CERT_SHAXXX
2. Authenticated UEFI Variable
 3. EFI PE/COFF Image(SHA256)

Key Source: Factory, Modified, Mixed

3.7 Boot Screen

In this section, it will display the available devices on the system for user to configure the boot settings and the boot priority.



Boot Option #1~#6

Use this item to set the system boot order.

UEFI USB Drive BBS Priorities

Specifies the Boot Device Priority sequence from available UEFI USB Drives.

UEFI Application Boot Priorities

Specifies the Boot Device Priority sequence from available UEFI Application.

Setup Prompt Timeout

Configure the number of seconds to wait for setup activation key.

Bootup NumLock State

If this item is set to [On], it will automatically activate the Numeric Lock function after boot-up.

Full Screen Logo

Enable to display boot logo or disable to show normal POST messages. The default value is [Enabled].

CSM (Compatibility Support Module)

CSM

Select this item to enable or disable the Compatibility Support Module support.

When enabling this item, the sub-items as below are displayed:

Launch PXE OpROM Policy

Select UEFI only to run those that support UEFI option ROM only. Select Legacy only to run those that support legacy option ROM only. Select Do not launch to not execute both legacy and UEFI option ROM.

Launch Storage OpROM Policy

Select UEFI only to run those that support UEFI option ROM only. Select Legacy only to run those that support legacy option ROM only. Select Do not launch to not execute both legacy and UEFI option ROM.

Launch Video OpROM Policy

Select UEFI only to run those that support UEFI option ROM only. Select Legacy only to run those that support legacy option ROM only. Select Do not launch to not execute both legacy and UEFI option ROM.

3.8 Exit Screen

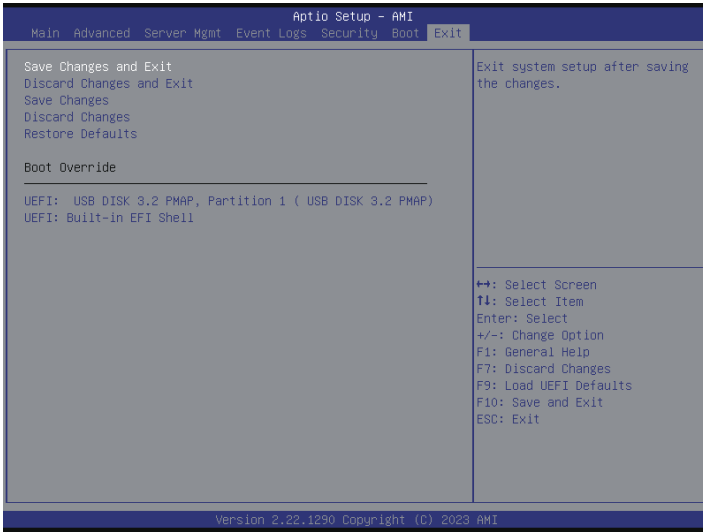

Save Changes and Exit

Exit system setup after saving the changes.

Discard Changes and Exit

Exit system setup without saving any changes.

Save Changes

Save changes done so far to any of the setup options.

Discard Changes

Discard changes done so far to any of the setup options.

Restore Defaults

Restore or load default values for all the setup questions. F9 key can be used for this operation.

Chapter 4 Software Support

After all the hardware has been installed, it suggests to go to the official website at <http://www.ASRockRack.com> and make sure if there are any new updates of the BIOS / BMC firmware for the motherboard.

4.1 Download and Install Operating System

This motherboard supports various Microsoft® Windows® Server / Linux compliant operating systems. Please download the operating system from the OS manufacturer. Please refer to the OS documentation for more instructions.

** Please download the Intel® SATA Floppy Image driver from the ASRock Rack's website (www.asrockrack.com) to the USB drive while installing OS in SATA RAID mode.*

4.2 Download and Install Software Drivers

This motherboard supports various Microsoft® Windows® compliant drivers. Please download the required drivers from the website at <http://www.ASRockRack.com>.

To download necessary drivers, go to the product page, click on the "Download" tab, choose the operating system that is used, and then download the using driver.

4.3 Contact Information

Contact ASRock Rack or want to know more about ASRock Rack, welcome to visit ASRock Rack's website at <http://www.ASRockRack.com>; or contact the dealer for further information.

Chapter 5 Troubleshooting

5.1 Troubleshooting Procedures

Follow the procedures below to troubleshoot the system.



Always unplug the power cord before adding, removing or changing any hardware components. Failure to do so may cause physical injuries and damages to motherboard components.

1. Disconnect the power cable and check whether the PWR LED is off.
2. Unplug all cables, connectors and remove all add-on cards from the motherboard. Make sure that the jumpers are set to default settings.
3. Confirm that there are no short circuits between the motherboard and the chassis.
4. Install a CPU and fan on the motherboard, then connect the chassis speaker and power LED.

If there is no power...

1. Confirm that there are no short circuits between the motherboard and the chassis.
2. Make sure that the jumpers are set to default settings.
3. Check the settings of the 115V/230V switch on the power supply.
4. Verify if the battery on the motherboard provides ~3VDC. Install a new battery if it does not.

If there is no video...

1. Try replugging the monitor cables and power cord.
2. Check for memory errors.

If there are memory errors...

1. Verify that the DIMM modules are properly seated in the slots.
2. Use recommended DDR5 288-pin ECC/UDIMM
3. Install more than one DIMM modules that should be identical with the same brand, speed, size and chip-type.
4. Try inserting different DIMM modules into different slots to identify faulty ones.
5. Check the settings of the 115V/230V switch on the power supply.

Unable to save system setup configurations...

1. Verify if the battery on the motherboard provides ~3VDC. Install a new battery if it does not.
2. Confirm whether the power supply provides adequate and stable power.

Other problems...

1. Try searching keywords related to the related problem on ASRock Rack's FAQ page:
<http://www.asrockrack.com/support>

5.2 Technical Support Procedures

If the problems are still unsolved, please contact ASRock Rack's technical support with the following information:

1. Contact information
2. Model name, BIOS version and problem type.
3. System configuration.
4. Problem description.

Contact ASRock Rack's technical support at:
<http://www.asrockrack.com/support/tsd.asp>

5.3 Returning Merchandise for Service

For warranty service, the receipt or a copy of the invoice marked with the date of purchase is required. By calling the vendor or going to RMA website (<http://event.asrockrack.com/tsd.asp>) to obtain a Returned Merchandise Authorization (RMA) number.

The RMA number should be displayed on the outside of the shipping carton which is mailed prepaid or hand-carried when returning the motherboard to the manufacturer. Shipping and handling charges will be applied for all orders that must be mailed when service is complete.

This warranty does not cover damages incurred in shipping or from failure due to alteration, misuse, abuse or improper maintenance of products.

Contact the distributor first for any product related problems during the warranty period.

Contact Information

If it needs to contact ASRock Rack or want to know more about ASRock Rack, you're welcome to visit ASRock Rack's website at <http://www.asrockrack.com>; or contact the dealer for further information. For technical questions, please submit a support request form at <https://event.asrockrack.com/tsd.asp>

ASRock Rack Incorporation

e-mail: ASRockRack_sales@asrockrack.com

ASRock Rack EUROPE B.V.

Bijsterhuizen 11-11
6546 AR Nijmegen
The Netherlands
Phone: +31-24-345-44-33

ASRock Rack America, Inc.

13848 Magnolia Ave, Chino, CA91710 U.S.A.
Phone: +1-909-590-8308
Fax: +1-909-590-1026