

Installation Guide

14-Slot Rackmount Chassis

To ask questions, find answers, and communicate with TP-Link users or engineers, please visit <https://community.tp-link.com> to join TP-Link Community.

For technical support and other information, please visit <https://www.tp-link.com/support>, or simply scan the QR code.



© 2023 TP-Link 7106510641 REV4.20.0

Package Contents: Chassis, AC Power Cord, Fourteen Retainer-plates, Installation Guide

The pictures are for demonstration purposes only. The actual product may differ in appearance from the depicted.

Installation

Step 1: Install the Media Converters in the Chassis

Note:

It is recommended to use TP-Link media converters. Other vendors' products may be incompatible.

1. Tweak out the two screws on the media converter. Then install the retainer-plate (provided with the chassis) to the media converter using the screws removed from the media converter.

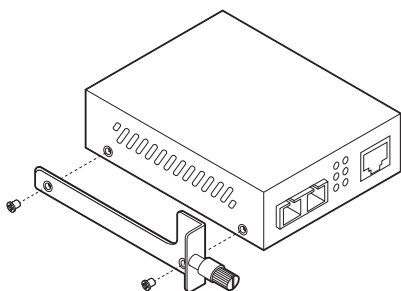

2. Remove the front metal plate of the slot on the chassis, then carefully slide the media converter into the slot and lock it tightly with the locking knob.

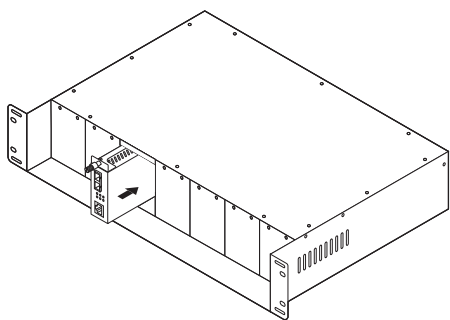

Step 2: (Optional) Install the Redundant Power Supply Module

Remove the protective cover on the power supply module slot of the chassis. Then gently push in the module and plug it solidly into the connector.

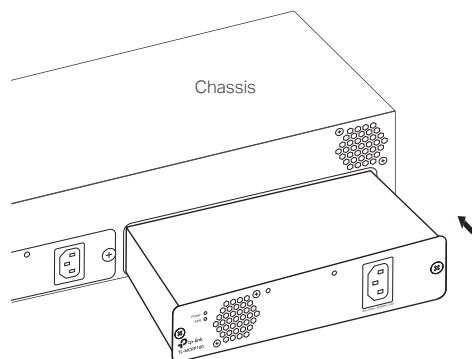

Step 3: Mount the Chassis on the Rack

Note:

1. The chassis supports EIA standard-sized, 19-inch racks.
2. For security reasons, it is recommended to install the chassis as shown below.

Fasten the chassis to the rack with screws through the holes of the brackets on each side.

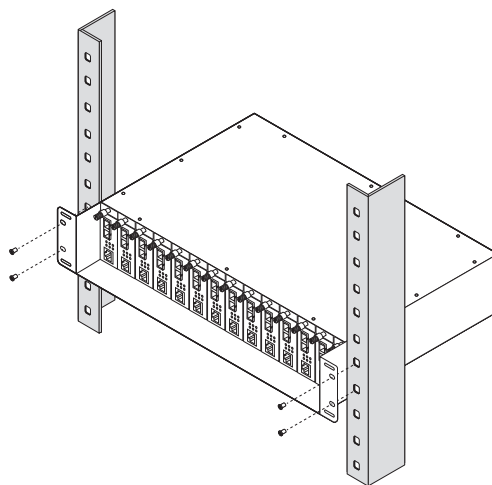

Step 4: Power On

1. Electrically connect the Grounding Terminal on the rear panel of the chassis to ground via the ground cable.

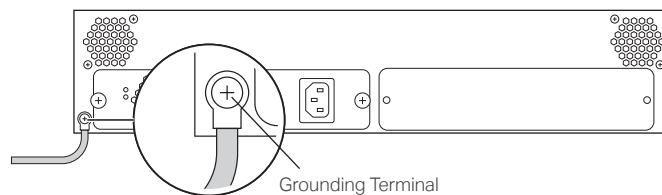

2. Connect the chassis to the AC outlet using the provided power cord.

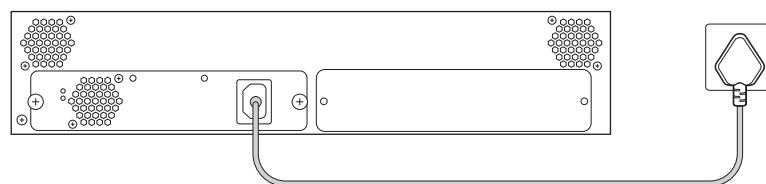

Panel Layout

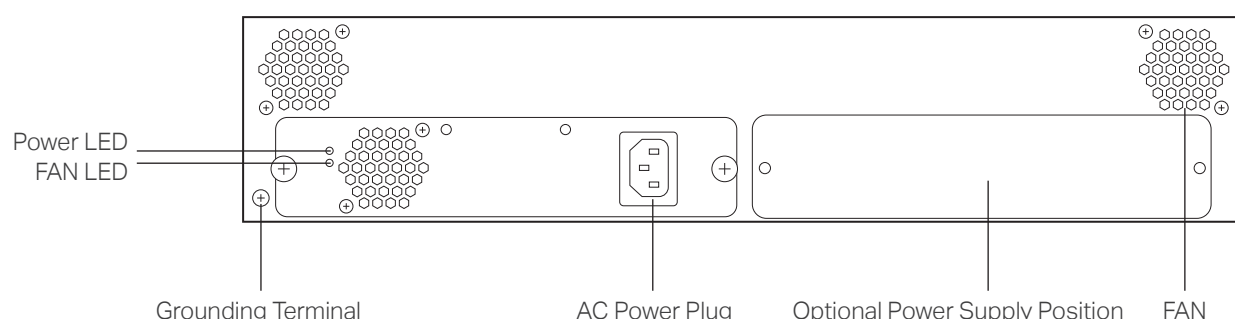

Note:

- An optional AC or DC power supply is available for installation in the optional power supply position.
- The power source should comply with Electrical Energy Source Class 1 (ES1) of IEC 62368-1.

LED Explanation

○	Power	○	FAN
	On: Power on Off: Power off		On: The fans are working properly. Off: The fans are working abnormally.

Specifications

Specifications	
AC Power Supply	Input: 100–240 V ~ 50/60 Hz 1.8 A (Max) Output: 12 V, 6.25 A (Max) Ripple & Noise: < 180 mV (0 °C to 50 °C); < 250 mV (-10 °C to 0 °C)
DC Power Output per Slot	MC1400: 9 V/0.6 A FC1420: 5 V/0.6 A
LED	Power, FAN
Dimensions (W×D×H)	482 × 309 × 86 mm
Hot-swappable	Yes
Overload Protection	Yes

Environmental and Physical Specifications	
Operation Temperature	MC1400: 0 °C to 40 °C (32 °F to 104 °F) FC1420: 0 °C to 50 °C (32 °F to 122 °F)
Storage Temperature	-40 °C to 70 °C (-40 °F to 158 °F)
Operation Humidity	10% to 90% RH non-condensing
Storage Humidity	5% to 90% RH non-condensing

Safety Information

- Keep the device away from water, fire, humidity or hot environments.
- Do not attempt to disassemble, repair, or modify the device. If you need service, please contact us.
- Avoid using this product during an electrical storm. There may be a remote risk of electric shock from lightning.
- The label is placed on the bottom surface of the product.
- Place the device with its bottom surface downward.
- The socket-outlet shall be installed near the equipment and shall be easily accessible.
- Plug the product into the wall outlets with earthing connection through the power supply cord or plug.

In Denmark: Apparatets stikprop skal tilsluttes en stikkontakt med jord som giver forbindelse til stikproppens jord.

In Finland: Laite on liitettävä suojakoskettimilla varustettuun pistorasiaan

In Norway: Apparatet må tilkoples jordet stikkontakt

In Sweden: Apparatens skall anslutas till jordat uttag

Please read and follow the above safety information when operating the device. We cannot guarantee that no accidents or damage will occur due to improper use of the device. Please use this product with care and operate at your own risk.

FCC compliance information statement

Product Name: 14-Slot Rackmount Chassis
Model Number: MC1400/FC1420
Responsible party:
TP-Link USA Corporation
Address: 10 Mauchly, Irvine, CA 92618
Website: <https://www.tp-link.com/us/>
Tel: +1 626 333 0234
Fax: +1 909 527 6804
E-mail: sales.usa@tp-link.com

This equipment has been tested and found to comply with the limits for a Class A digital device, pursuant to part 15 of the FCC Rules. These limits are designed to provide reasonable protection against harmful interference when the equipment is operated in a commercial environment. This equipment generates, uses, and can radiate radio frequency energy and, if not installed and used in accordance with the instruction manual, may cause harmful interference to radio communications. Operation of this equipment in a residential area is likely to cause harmful interference in which case the user will be required to correct the interference at his own expense.

This device complies with part 15 of the FCC Rules. Operation is subject to the following two conditions:

- 1) This device may not cause harmful interference.
- 2) This device must accept any interference received, including interference that may cause undesired operation.

Any changes or modifications not expressly approved by the party responsible for compliance could void the user's authority to operate the equipment.

We, TP-Link USA Corporation, has determined that the equipment shown as above has been shown to comply with the applicable technical standards, FCC part 15. There is no unauthorized change is made in the equipment and the equipment is properly maintained and operated.

Issue Date: 2023/09/14

Industry Canada Statement

CAN ICES-3 (A)/NMB-3(A)

CE Mark Warning

This is a class A product. In a domestic environment, this product may cause radio interference, in which case the user may be required to take adequate measures.

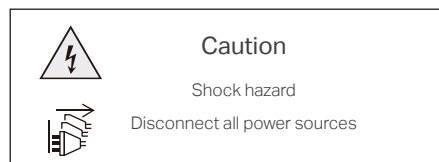

Продукт сертифіковано згідно з правилами системи УкрСЕПРО на відповідність вимогам нормативних документів та вимогам, що передбачені чинними законодавчими актами України.

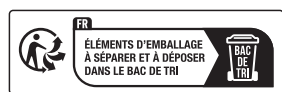

EU Declaration of Conformity

TP-Link hereby declares that the device is in compliance with the essential requirements and other relevant provisions of directives 2014/30/EU, 2014/35/EU, 2009/125/EC, 2011/65/EU and (EU)2015/863. The original EU declaration of conformity may be found at <https://www.tp-link.com/en/ce>.

UK Declaration of Conformity

TP-Link hereby declares that the device is in compliance with the essential requirements and other relevant provisions of the Electromagnetic Compatibility Regulations 2016 and Electrical Equipment (Safety) Regulations 2016. The original UK Declaration of Conformity may be found at <https://www.tp-link.com/support/ukca>

Explanation of the symbols on the product label

Symbols may vary from products. The label is at the bottom of the product.

Symbol	Explanation
	Class II equipment
	Class II equipment with functional earthing
	Alternating current
	Direct current
	Polarity of d.c. power connector
	For indoor use only
	Dangerous voltage
	Caution, risk of electric shock
	Energy efficiency Marking
	Protective earth
	Earth
	Frame or chassis
	Functional earthing
	Caution, hot surface
	Caution
	Operator's manual
	Stand-by
	"ON"/"OFF" (push-push)
	Fuse
	Fuse is used in neutral N
	RECYCLING This product bears the selective sorting symbol for Waste electrical and electronic equipment (WEEE). This means that this product must be handled pursuant to European directive 2012/19/EU in order to be recycled or dismantled to minimize its impact on the environment. User has the choice to give his product to a competent recycling organization or to the retailer when he buys a new electrical or electronic equipment.
	Caution, avoid listening at high volume levels for long periods
	Disconnection, all power plugs
	Switch of mini-gap construction
	Switch of micro-gap construction (for US version)
	Switch of micro-gap /micro-disconnection construction (for other versions except US)
	Switch without contact gap (Semiconductor switching device)