

User's Guide

XMG-100 Series

5/8-port 2.5G Unmanaged Switch with 10G Uplink

Version 1.00 Edition 4, 05/2024

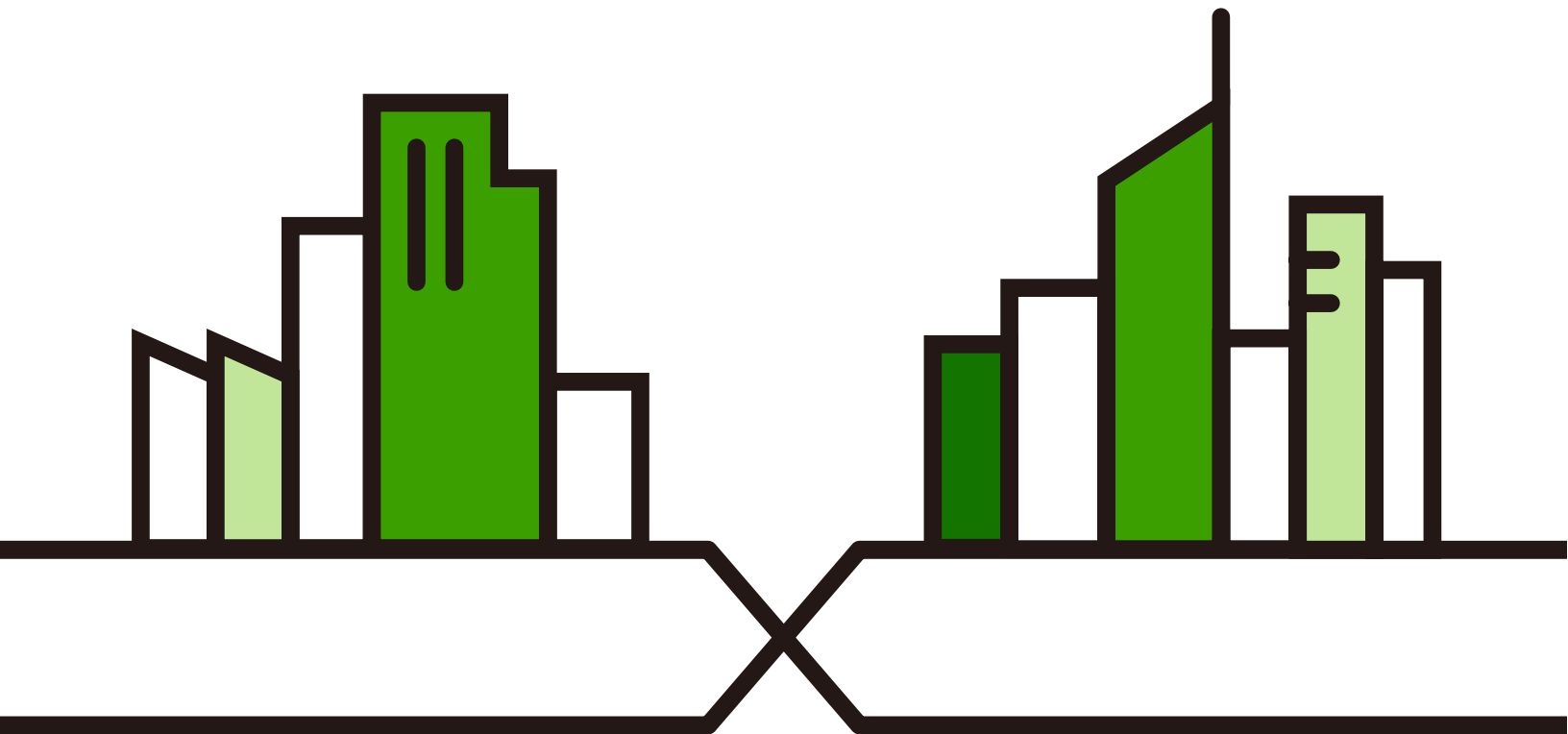

IMPORTANT!

READ CAREFULLY BEFORE USE.

KEEP THIS GUIDE FOR FUTURE REFERENCE.

Screenshots and graphics in this book may differ slightly from your product due to differences in your product firmware or your computer operating system. Every effort has been made to ensure that the information in this manual is accurate.

- More Information

Go to support.zyxel.com to find other information on the Switch.



Document Conventions

Warnings and Notes

These are how warnings and notes are shown in this guide.

Warnings tell you about things that could harm you or your device.











Note: Notes tell you other important information (for example, other things you may need to configure or helpful tips) or recommendations.

Syntax Conventions

- All models may be referred to as the “Switch” in this guide.
- Product labels are all in **bold** font.

Icons Used in Figures

Figures in this user guide may use the following generic icons. The Switch icon is not an exact representation of your device.

Switch 	Generic Router 	Wireless Router / Access Point 
Generic Switch 	Smart TV 	Desktop 
Laptop 	IP Camera 	Printer 
Server 		

Contents Overview

User's Guide	6
Getting to Know Your Switch	7
Hardware Installation and Connection	11
Hardware Panels	15
Troubleshooting	22

Table of Contents

Part I: User's Guide	6
Chapter 1	
Getting to Know Your Switch	7
1.1 Introduction	7
1.2 Features	8
1.2.1 Multi-Gigabit	8
1.2.2 PoE	9
1.3 Example Application	10
1.3.1 PoE Example Application	10
Chapter 2	
Hardware Installation and Connection	11
2.1 Installation Scenarios	11
2.2 Safety Precautions	11
2.3 Freestanding Installation Procedure	12
2.4 Wall Mounting	12
2.4.1 Installation Requirements	13
Chapter 3	
Hardware Panels	15
3.1 Front Panel Connections	15
3.1.1 Multi-gigabit Ethernet Ports	16
3.1.2 SFP+ Slot	16
3.2 Rear Panel	18
3.2.1 Power Connection	19
3.3 Flow Control Button	19
3.4 LEDs	20
Chapter 4	
Troubleshooting	22
4.1 Power, Hardware Connections, and LEDs	22
4.2 Improper Network Cabling and Topology	23
Appendix A Customer Support	24
Appendix B Legal Information	29
Index	34

PART I

User's Guide

CHAPTER 1

Getting to Know Your Switch

1.1 Introduction

The Switch refers to all the following models unless a particular model is specified.

- XMG-105
- XMG-105HP
- XMG-108
- XMG-108HP

The Switch provides 100 Mbps / 1 Gbps /2.5 Gbps multi-gigabit front ports and a 1 Gbps/10 Gbps SFP+ uplink port. The Switch is available in 5 or 8 ports and can be used to build high-performance switched workgroup networks. The Switch is a store-and-forward device that offers low latency for high-speed networking. The Switch is designed for workgroups, departments or backbone computing environments for small businesses. The XMG-105HP and XMG108HP are PoE models that support PoE++ (802.3bt) and can be used to power Ethernet devices.

All models are referred to as the “Switch” in this guide.

The following table describes the hardware features of the Switch by model.

The PoE ports can supply power to the connected PoE powered devices (PDs).

Table 1 Hardware Feature Comparison

PORT/SWITCH DETAILS	XMG-105	XMG-105HP	XMG-108	XMG-108HP
100M/1G/2.5G Base-T Ethernet ports	5	1	8	0
100M/1G/2.5G Base-T IEEE 802.3bt PoE ports	0	4	0	8
1G/10G SFP+ port	1	1	1	1
Desktop Device	Yes	Yes	Yes	Yes
Wall-mountable	Yes	Yes	Yes	Yes
Power Adapter	Yes	Yes	Yes	Yes
Power Cord	No	Yes	No	Yes
Power Plug	Yes	No	Yes	No

The SFP+ slot is for uplink connections. Use SFP+ transceivers in these slots for 1 Gbps or 10 Gbps connections to backbone Ethernet switches.

The Switch has built-in loop detection. All connected port's LED will slow blink green/ amber when it detects that packets sent out that port loop back to the Switch. See [Table 8 on page 20](#) for more information about LEDs.

The Switch uses IEEE 802.3x flow control in full duplex mode and has an additional Flow Control button. The FC LED helps you identify the status of the Flow Control button.

The Switch has built-in IEEE 802.1p CoS (Class of Service) feature that services queues based on priority only. As traffic comes into the Switch, traffic on the highest priority queue is transmitted first. When that queue empties, traffic on the next highest-priority queue is transmitted until it empties, and then traffic is transmitted on the next queue and so on. If higher priority queues never empty, then traffic on lower priority queues never gets sent.

1.2 Features

The following are the essential features of the Switch.

- Conforms to IEEE 802.3u, 802.3ab, 802.3bz, 802.3z, 802.3ae, and 802.3x standards.
- Auto-negotiating 100 Mbps / 1 Gbps / 2.5 Gbps multi-gigabit Ethernet RJ-45 ports.
- Auto-sensing crossover for all 100 Mbps / 1 Gbps / 2.5 Gbps multi-gigabit Ethernet RJ-45 ports.
- Supports N-Way protocol for speed (100 Mbps / 1 Gbps / 2.5 Gbps) and duplex mode (Full) auto-detection.
- Supports store-and-forward switching.
- Supports automatic address learning.
- Supports IEEE 802.3af, IEEE 802.3at, and IEEE 802.3bt PoE standards.
- Full wire speed forwarding rate.
- Supports 802.1p CoS.
- Supports up to 4096 MAC addresses.
- Supports loop detection

1.2.1 Multi-Gigabit

The 2.5 multi-gigabit ports of the Switch(S), supporting speeds of 2.5 Gbps, are backward compatible with 100 Mbps and 1 Gigabit ports. See [Section 3.1.1 on page 16](#) for more information.

Figure 1 Multi-Gigabit Application

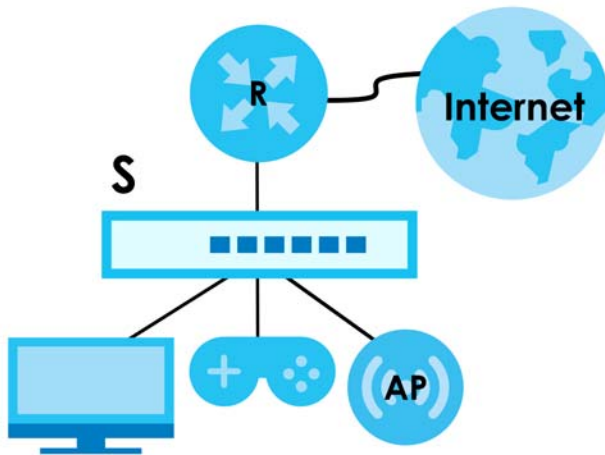

See the following table for the cables required and distance limitation to attain the corresponding speed.

Table 2 Cable Types

CABLE	TRANSMISSION SPEED	MAXIMUM DISTANCE	BANDWIDTH CAPACITY
Category 5	100M	100 m	100 MHz
Category 5e	1G / 2.5G	100 m	100 MHz
Category 6	1G / 2.5G	100 m	250 MHz

1.2.2 PoE

The Switch is a Power Sourcing Equipment (PSE) because it provides a source of power through its Ethernet ports. Each device that receives power through an Ethernet port is a Powered Device (PD).

The Switch can adjust the power supplied to each PD according to the PoE standard the PD supports. PoE standards are:

- IEEE 802.3af Power over Ethernet (PoE)
- IEEE 802.3at Power over Ethernet (PoE) +
- IEEE 802.3bt Power over Ethernet (PoE) ++

The following table describes the PoE features of the Switch by model.

Table 3 XMG-100 Series Models and PoE Features

POE FEATURES	XMG-105HP	XMG-108HP
IEEE 802.3bt PoE++	Ports 1 – 4	Ports 1 – 8
Power Management Mode	Consumption	Consumption
PoE Power Budget	70W	100W

Table 4 PoE Standards

POE FEATURES	PoE	PoE+	PoE++
IEEE Standard	IEEE 802.3af	IEEE 802.3at	IEEE 802.3bt
PoE Type	Type 1	Type 2	Type 3
Switch Port Power			
Maximum Power Per Port	15.4 W	30 W	60 W
Port Voltage Range	44 – 57 V	50 – 57 V	50 – 57 V
Cables			
Twisted Pairs Used	2-pair	2-pair	4-pair
Supported Cables	Cat3 / 24 AWG or better	Cat5 or better / 24 AWG or better	Cat5 or better/24 AWG or better

1.3 Example Application

This section shows the example of using the Switch in the network environments. Note that the Switch in the figure is just an example Switch and not your actual Switch.

1.3.1 PoE Example Application

The following example figure shows a Switch (S) supplying power to Powered Devices (PDs). You can connect the multi-gigabit ports (100 Mbps / 1 Gbps / 2.5 Gbps) to PDs such as an IP camera, an IP telephone, an AP that are not within reach of a power outlet.

Figure 2 Powered Device Example

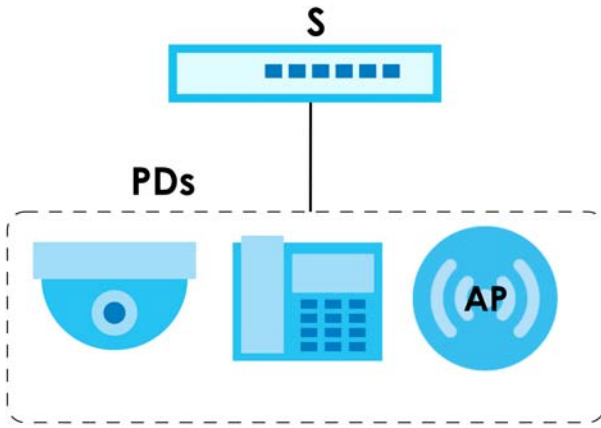

CHAPTER 2

Hardware Installation and Connection

2.1 Installation Scenarios

This chapter shows you how to install and connect the Switch.

See [Table 1 on page 7](#) for a comparison of hardware features for each model.

The Switch can be:

- Placed on a desktop.
- Wall-mounted on a wall.

See the following table for a comparison of the hardware installation methods of each Switch:

Table 5 Mounting Methods

MODEL FEATURE	XMG-105	XMG-105HP	XMG-108	XMG-108HP
Desktop Device	Yes	Yes	Yes	Yes
Wall-mountable	Yes	Yes	Yes	Yes

2.2 Safety Precautions

Please observe the following before using the Switch:

- It is recommended to ask an authorized technician to attach the Switch on a desk or to the wall. Use the proper screws to prevent damage to the Switch. See the **Installation Requirements** sections in this chapter to know the types of screws and screw drivers for each mounting method.
- Make sure there is at least 2 cm of clearance on the top and bottom of the Switch, and at least 5 cm of clearance on all four sides of the Switch. This allows air circulation for cooling.
- Do NOT block the ventilation holes nor store cables or power cords on the Switch. Allow clearance for the ventilation holes to prevent your Switch from overheating. This is especially crucial when your Switch does not have fans. Overheating could affect the performance of your Switch, or even damage it.
- The surface of the Switch could be hot when it is functioning. Do NOT put your hands on it. You may get burned. This could happen especially when you are using a fanless Switch.
- The Switches with fans are not suitable for use in locations where children are likely to be present.

To start using the Switch, simply connect the power adapter to turn it on.

2.3 Freestanding Installation Procedure

- 1 Make sure the Switch is clean and dry.
- 2 Remove the adhesive backing from the rubber feet.
- 3 Attach the rubber feet to each corner on the bottom of the Switch. These rubber feet help protect the Switch from shock or vibration and ensure space between devices when stacking.

Figure 3 Attaching Rubber Feet

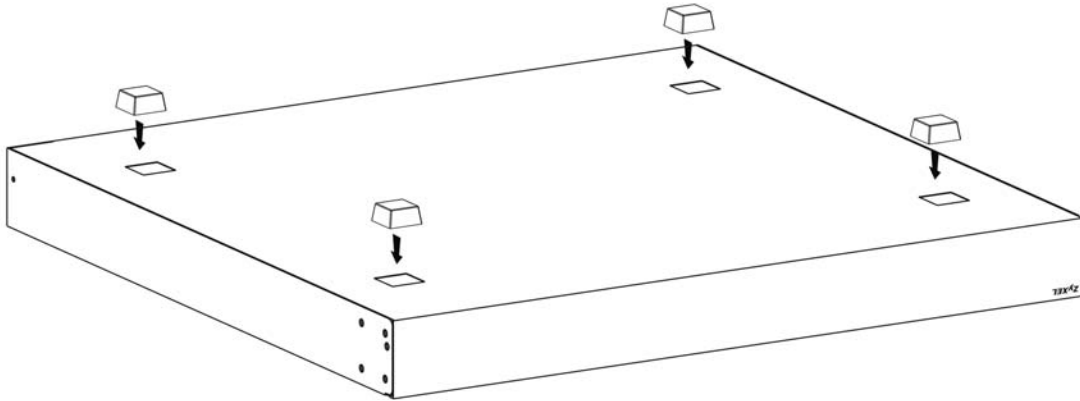

- 4 Set the Switch on a smooth, level surface strong enough to support the weight of the Switch and the connected cables. Make sure there is a power outlet nearby.

Cautions:

- Avoid stacking fanless Switches to prevent overheating.
- Ensure enough clearance around the Switch to allow air circulation for cooling.
- Do NOT remove the rubber feet as it provides space for air circulation.

2.4 Wall Mounting

The Switch can be mounted on a wall (see [Table on page 11](#)). You may need screw anchors if mounting on a concrete or brick wall.

Do the following to mount your Switch on a wall.

See [Table 6 on page 12](#) for how far apart to place the screws.

Table 6 Distance between the centers of the holes for wall mounting

MODEL	DISTANCE
XMG-105	114 mm
XMG-105HP	114 mm
XMG-108	188 mm
XMG-108HP	188 mm

2.4.1 Installation Requirements

- Distance above the floor: At least 1.8 m (5.9 feet)
- Two M4 screws and a #2 Philips screwdriver
- Two screw anchors (optional)

Figure 4 Screw Specifications for Wall Mounting

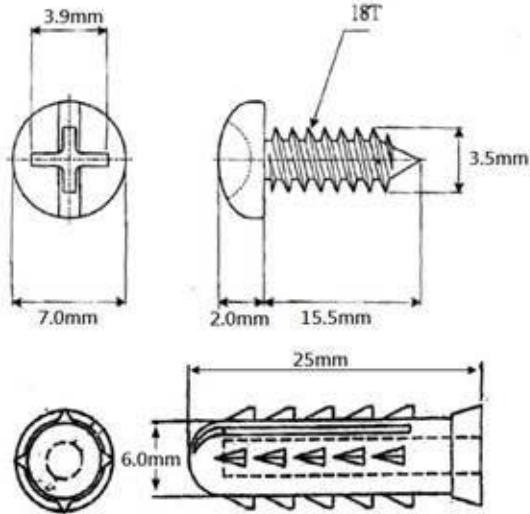

- 1 Select a position free of obstructions on a wall strong enough to hold the weight of the Switch.
- 2 Mark two holes on the wall at the appropriate distance apart for the screws.

WARNING! Be careful to avoid damaging pipes or cables located inside the wall when drilling holes for the screws.

- 3 If using screw anchors, drill two holes for the screw anchors into the wall. Push the anchors into the full depth of the holes, then insert the screws into the anchors. Do NOT insert the screws all the way in – leave a small gap of about 0.5 cm.

If not using screw anchors, use a screwdriver to insert the screws into the wall. Do NOT insert the screws all the way in – leave a gap of about 0.5 cm.

- 4 Make sure the screws are fastened well enough to hold the weight of the Switch with the connection cables.
- 5 Align the holes on the back of the Switch with the screws on the wall. Hang the Switch on the screws.

Note: Make sure there is enough clearance between the wall and the Switch to allow ventilation.

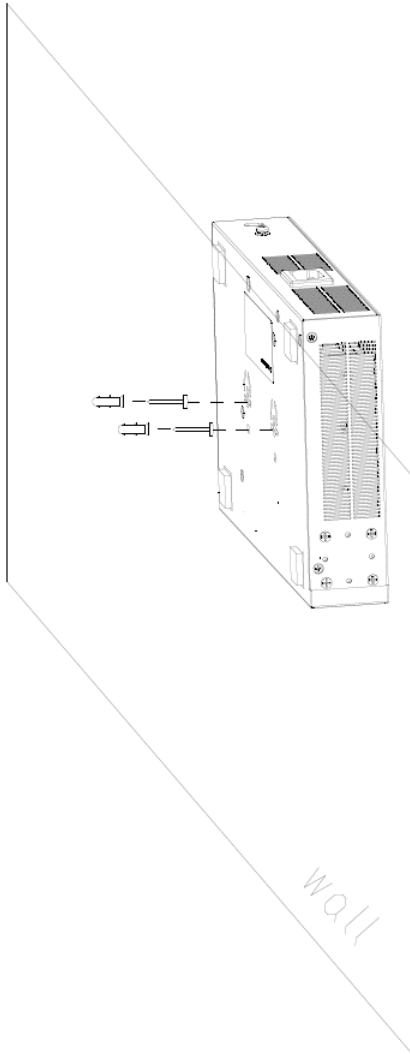

WARNING! The Switch should be wall-mounted horizontally, and make sure the front panel is facing down. The Switch's side panels with ventilation slots should not be facing up or down as this position is less safe.

CHAPTER 3

Hardware Panels

This chapter describes the front panel and rear panel of the Switch and shows you how to make the hardware connections.

3.1 Front Panel Connections

You can use either crossover or straight-through cables for all the ports.

Refer to [Section Table 1 on page 7](#) for more information on hardware differences between models.

The following figures show the front panels of the Switch.

Figure 5 XMG-105



Figure 6 XMG-105HP



Figure 7 XMG-108

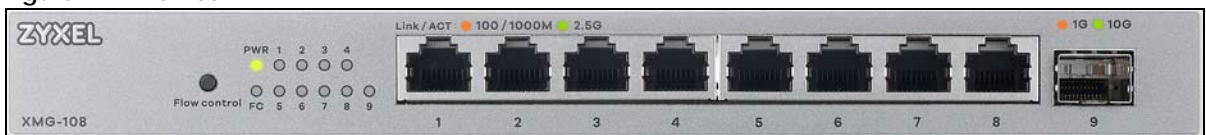

Figure 8 XMG-108HP



You can use unshielded twisted pair (UTP) or shielded twisted-pair (STP) Ethernet cables for RJ-45 ports. The following table describes the types of network cable used for the different connection speeds.

Table 7 Network Cable Types

TRANSMISSION SPEED	NETWORK CABLE TYPE	MAXIMUM DISTANCE	BANDWIDTH CAPACITY
100 Mbps	Category 5 UTP/STP	100 m	100 MHz

Table 7 Network Cable Types (continued)

TRANSMISSION SPEED	NETWORK CABLE TYPE	MAXIMUM DISTANCE	BANDWIDTH CAPACITY
1 Gbps	Category 5e, 6 UTP/STP	100 m	100 MHz
2.5 Gbps	Category 5e, 6 UTP/STP	100 m	100 MHz

3.1.1 Multi-gigabit Ethernet Ports

The Switch has 2.5G Base-T auto-negotiating, auto-crossover Ethernet ports. In 100 Mbps / 1/2.5 Gbps multi-gigabit, the speed can be 100 Mbps, 1 Gbps or 2.5 Gbps and full duplex mode.

The 100 Base-TX / 1G Base-T / 2.5G Base-T RJ-45 ports are auto-negotiating and auto-crossover.

An auto-negotiating port can detect and adjust to the optimum Ethernet speed (100 Mbps / 1 Gbps / 2.5 Gbps) and duplex mode (full duplex) of the connected device.

An auto-crossover (auto-MDI/MDI-X) port automatically works with a straight-through or crossover Ethernet cable.

3.1.1.1 Auto-crossover

All ports support auto-crossover, that is auto-MDIX ports (Media Dependent Interface Crossover), so you may use either a straight-through Ethernet cable or crossover Ethernet cable for all multi-gigabit port connections. Auto-crossover ports automatically sense whether they need to function as crossover or straight ports, so crossover cables can connect both computers and switches or hubs.

3.1.2 SFP+ Slot

Refer to [Section 1.1 on page 7](#) for more information on hardware differences between models.

This is a slot for SFP (Small Form-Factor Pluggable) module, such as an SFP transceiver. A transceiver is a single unit that houses a transmitter and a receiver. Use a transceiver to connect a fiber optic cable to the Switch. The Switch does not come with a transceiver. You must use a transceiver that complies with the Small Form-factor Pluggable (SFP) Transceiver MultiSource Agreement (MSA). See the SFF committee's INF-8074i specification Rev 1.0 for details.

You can change transceiver while the Switch is operating. You can use a different transceiver to connect to Ethernet switches with different types of fiber optic or even copper cable connectors.

- Type: SFP+ connection interface
- Connection speed: 1/10 Gbps

WARNING! To avoid possible eye injury, do not look into an operating fiber optic module's connectors.

HANDLING! A transceiver is static sensitive. To prevent damage from electrostatic discharge (ESD), it is recommended you attach an ESD preventive wrist strap to your wrist and to a bare metal surface when you install or remove a transceiver.

STORAGE! All modules are dust sensitive. When not in use, always keep the dust plug on. Avoid getting dust and other contaminant into the optical bores, as the optics do not work correctly when obstructed with

dust.

3.1.2.1 Transceiver Installation

Use the following steps to install a transceiver.

- 1 Attach an ESD preventive wrist strap to your wrist and to a bare metal surface.
- 2 Align the transceiver in front of the slot opening.
- 3 Make sure the latch is in the lock position (latch styles vary), then insert the transceiver into the slot with the exposed section of PCB board facing down.
- 4 Press the transceiver firmly until it clicks into place.
- 5 The Switch automatically detects the installed transceiver. Check the LEDs to verify that it is functioning properly.
- 6 Remove the dust plugs from the transceiver and cables (dust plug styles vary).
- 7 Identify the signal transmission direction of the fiber optic cables and the transceiver. Insert the fiber optic cable into the transceiver.

Figure 9 Latch in the Lock Position

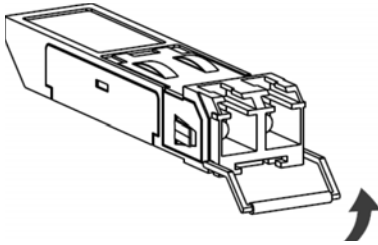

Figure 10 Transceiver Installation Example

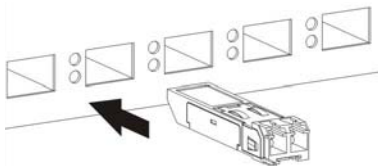
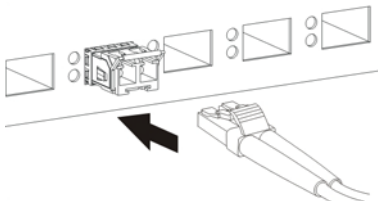

Figure 11 Connecting the Fiber Cables



3.1.2.2 Transceiver Removal

Use the following steps to remove an SFP transceiver.

- 1 Attach an ESD preventive wrist strap to your wrist and to a bare metal surface on the chassis.
- 2 Remove the fiber optic cables from the transceiver.

- 3 Pull out the latch and down to unlock the transceiver (latch styles vary).

Note: Make sure the transceiver's latch is pushed all the way down, so the transceiver can be pulled out successfully.

- 4 Pull the latch, or use your thumb and index finger to grasp the tabs on both sides of the transceiver, and carefully slide it out of the slot.

Note: Do NOT pull the transceiver out by force. You could damage it. If the transceiver will not slide out, grasp the tabs on both sides of the transceiver with a slight up or down motion and carefully slide it out of the slot. If unsuccessful, contact Zyxel Support to prevent damage to your Switch and transceiver.

- 5 Insert the dust plug into the ports on the transceiver and the cables.

Figure 12 Removing the Fiber Optic Cables

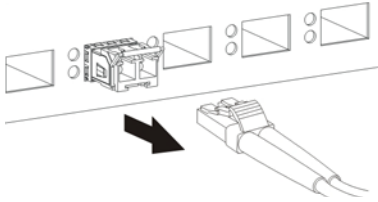

Figure 13 Opening the Transceiver's Latch Example

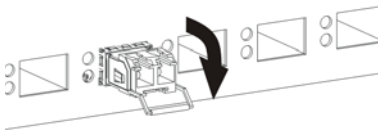
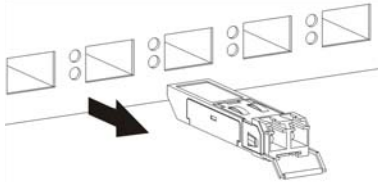

Figure 14 Transceiver Removal Example



3.2 Rear Panel

The following figures show the rear panels of the Switch. The power receptacle is located on the rear panel of the Switch. Refer to the power supply requirements on the panel.

Figure 15 XMG-105

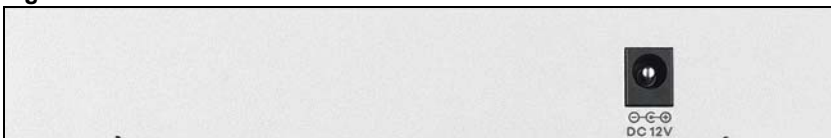

Figure 16 XMG-105HP

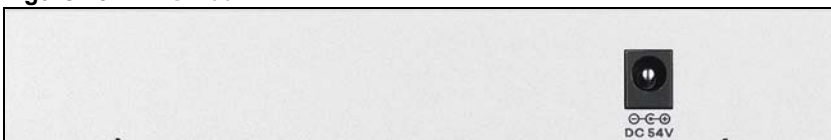

Figure 17 XMG-108

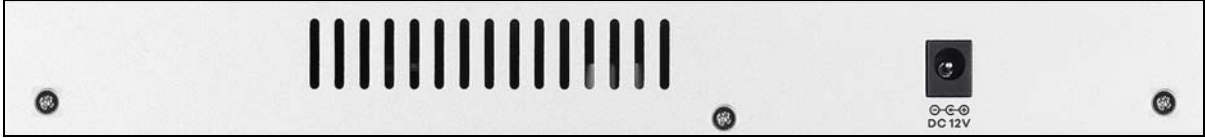
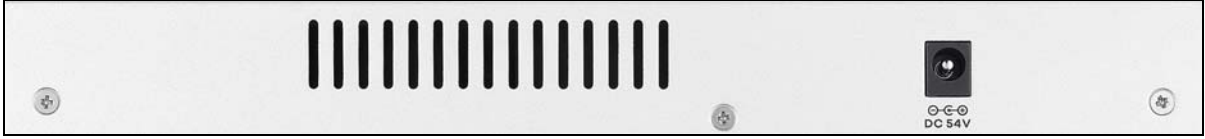

Figure 18 XMG-108HP



3.2.1 Power Connection

Note: Make sure you are using the correct power source as shown on the panel.

Connect the supplied power adapter to the power receptacle on the rear panel. Then use the included power cord to connect the power adapter to an appropriate power source.

3.3 Flow Control Button

The Switch uses IEEE 802.3x flow control in full duplex mode.

IEEE 802.3x flow control is used in full duplex mode to send a pause signal to the sending port, causing it to temporarily stop sending signals when the receiving port memory buffers fill.

The default state is on, and the flow control applies to all Switch ports. When the **Flow control** is on, the Switch port is allowed to send pause signal to the connected device, and for the connected device to send a pause signal to the Switch. The Switch will temporarily stop sending signals after receiving pause signal.

Figure 19 Flow Control Button (XMG-105)



Figure 20 Flow Control Button (XMG-105HP)



Figure 21 Flow Control Button (XMG-108)

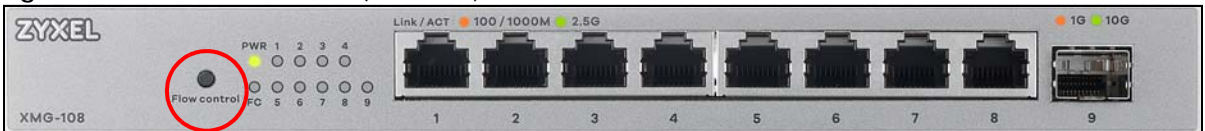

Figure 22 Flow Control Button (XMG-108HP)

3.4 LEDs

The LED Indicators give real-time information about the status of the Switch. After you connect the power to the Switch, view the LEDs to ensure proper functioning of the Switch and as an aid in troubleshooting. The following table provides descriptions of the LEDs.

The following table describes the LEDs.

Table 8 LED Descriptions

LED	COLOR	STATUS	DESCRIPTION
PWR	Green	On	The Switch is receiving power from the power module in the power slot.
		Blinking	The Switch is rebooting.
		Off	The Switch is not receiving power from the power module in the power slot or the Switch is malfunctioning.
PoE MAX	Amber	On	The Switch's remaining power budget is equal to / less than 10 watt.
		Off	The Switch's remaining power budget is above 10 watt.
FC	Green	On	The Switch's flow control is enabled for all ports.
		Off	The Switch's flow control is disabled for all ports.

LED	COLOR	STATUS	DESCRIPTION
100M/1G/2.5G Base-T Ports			
Link / ACT 1 – 5 (XMG-105 / XMG-105HP)	Green	On	The link to a 2.5G Ethernet network is up.
		Blinking	The Switch is transmitting/receiving to/from a 2.5G Ethernet network.
		Slow Blinking	The Switch detects loop activity on the 2.5G Ethernet network.
1 – 8 (XMG-108 / XMG-108HP)	Amber	On	The link to a 100/1000 Mbps Ethernet network is up.
		Blinking	The Switch is transmitting/receiving to/from a 100/1000 Mbps Ethernet network.
		Slow Blinking	The Switch detects loop activity on the 100/1000 Mbps Ethernet network.
		Off	The link to an Ethernet network is down, or the uplink port is shut down.

LED	COLOR	STATUS	DESCRIPTION
1G/10G SFP+ Slots			
Link / ACT 6 (XMG-105 / XMG-105HP)	Green	On	The port has a successful 10G connection.
		Blinking	The port is transmitting or receiving data at 10G.
		Slow Blinking	The Switch detects loop activity on the 10G connection.
9 (XMG-108 / XMG-108HP)	Amber	On	The port has a successful 1G connection.
		Blinking	The port is transmitting or receiving data at 1G.
		Slow Blinking	The Switch detects loop activity on the 1G connection.
		Off	This link is disconnected, or the uplink port is shut down.

PoE Ports for XMG-105HP/XMG-108HP			
PoE++ 60W	Green	On	The Switch is providing PoE power.
1 – 4 (XMG-105HP)		Off	There is no PoE power supplied.
1 – 8 (XMG-108HP)			

CHAPTER 4

Troubleshooting

This chapter offers some suggestions to solve problems you might encounter. The potential problems are divided into the following categories.

- [Power, Hardware Connections, and LEDs](#)
- [Improper Network Cabling and Topology](#)

4.1 Power, Hardware Connections, and LEDs

[The Switch does not turn on. None of the LEDs turn on.](#)

- 1 Make sure you are using the power adapter or cord included with the Switch.
- 2 Make sure the power adapter or cord is connected to the Switch and plugged in to an appropriate power source. Make sure the power source is turned on.
- 3 Disconnect and re-connect the power adapter or cord to the Switch.
- 4 If the problem continues, contact the vendor.

[One of the LEDs does not behave as expected.](#)

- 1 Make sure you understand the normal behavior of the LED. See [Section 3.4 on page 20](#).
- 2 Check the hardware connections. See [Section 3.1 on page 15](#).
- 3 Inspect your cables for damage. Contact the vendor to replace any damaged cables.
- 4 Disconnect and re-connect the power adapter or cord to the Switch.
- 5 If the problem continues, contact the vendor.

[The Link / ACT LED does not light up when a device is connected.](#)

- Verify that the attached device(s) is turned on and properly connected to your Switch.

- Make sure the network adapters are working on the attached devices.
- Verify that proper network cable type is used and its length does not exceed 100 meters. For more information on network cable types, see [Table 2 on page 9](#).

The **PoE++ 60W** LED is off and/or power is not being supplied to my PoE-enabled device.

- Make sure to connect a PoE-enabled device to your Switch.
- Check your Switch's **PoE MAX** LED. If it lights steady amber, then the Switch's remaining power budget is equal to / less than 10 watt.
- Check to see that the power adapter is securely connected to the Switch and an appropriate power source. Make sure the power source is on and functioning properly.
- Check that the Ethernet cables are connected properly and that you are using the correct type of Ethernet cable. Contact your local distributor if the problem persists.

4.2 Improper Network Cabling and Topology

Improper network cabling or topology setup is a common cause of poor network performance or even network failure.

Figure 23 Troubleshooting Improper Network Cabling and Topology

PROBLEM	CORRECTIVE ACTION
Faulty cables	Using faulty network cables may affect data rates and have an impact on your network performance. Replace with new standard network cables.
Non-standard network cables	Non-standard cables may increase the number of network collisions and cause other network problems that affect your network performance. Refer to Table 2 on page 9 for more information on network cable types.
Cabling Length	If you use longer cables than are needed, transmission quality may be affected. The network cables should not be longer than the limit of 100 meters.
Too many hubs between the computers in the network	Too many hubs (or repeaters) between the connected computers in the network may increase the number of network collision or other network problems. Remove unnecessary hubs from the network.
A loop in the data path	A data path loop forms when there is more than one path or route between two networked computers. This results in broadcast storms that will severely affect your network performance. Make sure there are no loops in your network topology.

APPENDIX A

Customer Support

In the event of problems that cannot be solved by using this manual, you should contact your vendor. If you cannot contact your vendor, then contact a Zyxel office for the region in which you bought the device.

For Zyxel Communications offices, see <https://service-provider.zyxel.com/global/en/contact-us> for the latest information.

For Zyxel Networks offices, see <https://www.zyxel.com/index.shtml> for the latest information.

Please have the following information ready when you contact an office.

Required Information

- Product model and serial number.
- Warranty Information.
- Date that you received your device.
- Brief description of the problem and the steps you took to solve it.

Corporate Headquarters (Worldwide)

Taiwan

- Zyxel Communications (Taiwan) Co., Ltd.
- <https://www.zyxel.com>

Asia

China

- Zyxel Communications Corporation–China Office
- <https://www.zyxel.com/cn/sc>

India

- Zyxel Communications Corporation–India Office
- <https://www.zyxel.com/in/en-in>

Kazakhstan

- Zyxel Kazakhstan
- <https://www.zyxel.com/ru/ru>

Korea

- Zyxel Korea Co., Ltd.
- <http://www.zyxel.kr/>

Malaysia

- Zyxel Communications Corp.
- <https://www.zyxel.com/global/en>

Philippines

- Zyxel Communications Corp.
- <https://www.zyxel.com/global/en>

Singapore

- Zyxel Communications Corp.
- <https://www.zyxel.com/global/en>

Taiwan

- Zyxel Communications (Taiwan) Co., Ltd.
- <https://www.zyxel.com/tw/zh>

Thailand

- Zyxel Thailand Co., Ltd.
- <https://www.zyxel.com/th/th>

Vietnam

- Zyxel Communications Corporation–Vietnam Office
- <https://www.zyxel.com/vn/vi>

Europe

Belarus

- Zyxel Communications Corp.
- <https://www.zyxel.com/ru/ru>

Belgium (Netherlands)

- Zyxel Benelux
- <https://www.zyxel.com/nl/nl>
- <https://www.zyxel.com/fr/fr>

Bulgaria

- Zyxel Bulgaria

- <https://www.zyxel.com/bg/bg>

Czech Republic

- Zyxel Communications Czech s.r.o.
- <https://www.zyxel.com/cz/cs>

Denmark

- Zyxel Communications A/S
- <https://www.zyxel.com/dk/da>

Finland

- Zyxel Communications
- <https://www.zyxel.com/fi/fi>

France

- Zyxel France
- <https://www.zyxel.com/fr/fr>

Germany

- Zyxel Deutschland GmbH.
- <https://www.zyxel.com/de/de>

Hungary

- Zyxel Hungary & SEE
- <https://www.zyxel.com/hu/hu>

Italy

- Zyxel Communications Italy S.r.l.
- <https://www.zyxel.com/it/it>

Norway

- Zyxel Communications A/S
- <https://www.zyxel.com/no/no>

Poland

- Zyxel Communications Poland
- <https://www.zyxel.com/pl/pl>

Romania

- Zyxel Romania
- <https://www.zyxel.com/ro/ro>

Russian Federation

- Zyxel Communications Corp.
- <https://www.zyxel.com/ru/ru>

Slovakia

- Zyxel Slovakia
- <https://www.zyxel.com/sk/sk>

Spain

- Zyxel Iberia
- <https://www.zyxel.com/es/es>

Sweden

- Zyxel Communications A/S
- <https://www.zyxel.com/se/sv>

Switzerland

- Studerus AG
- <https://www.zyxel.com/ch/de-ch>
- <https://www.zyxel.com/fr/fr>

Turkey

- Zyxel Turkey A.S.
- <https://www.zyxel.com/tr/tr>

UK

- Zyxel Communications UK Ltd.
- <https://www.zyxel.com/uk/en-gb>

Ukraine

- Zyxel Ukraine
- <https://www.zyxel.com/ua/uk-ua>

South America

Argentina

- Zyxel Communications Corp.
- <https://www.zyxel.com/co/es-co>

Brazil

- Zyxel Communications Brasil Ltda.

- <https://www.zyxel.com/br/pt>

Colombia

- Zyxel Communications Corp.
- <https://www.zyxel.com/co/es-co>

Ecuador

- Zyxel Communications Corp.
- <https://www.zyxel.com/co/es-co>

South America

- Zyxel Communications Corp.
- <https://www.zyxel.com/co/es-co>

Middle East

Israel

- Zyxel Communications Corp.
- <https://il.zyxel.com>

North America

USA

- Zyxel Communications, Inc. – North America Headquarters
- <https://www.zyxel.com/us/en-us>

APPENDIX B

Legal Information

Copyright

Copyright © 2024 Zyxel and/or its affiliates. All rights reserved.

The contents of this publication may not be reproduced in any part or as a whole, transcribed, stored in a retrieval system, translated into any language, or transmitted in any form or by any means, electronic, mechanical, magnetic, optical, chemical, photocopying, manual, or otherwise, without the prior written permission of Zyxel Communications Corporation.

Published by Zyxel and/or its affiliates. All rights reserved.

Disclaimer

Zyxel does not assume any liability arising out of the application or use of any products, or software described herein. Neither does it convey any license under its patent rights nor the patent rights of others. Zyxel further reserves the right to make changes in any products described herein without notice. This publication is subject to change without notice.

Regulatory Notice and Statement (Class B)

Model List: XMG-105, XMG-105HP, XMG-108, XMG-108HP

United States of America



The following information applies if you use the product within USA area.

US Importer: Zyxel Communications, Inc, 1130 North Miller Street Anaheim, CA92806-2001, <https://www.zyxel.com/us/en/>

Federal Communications Commission (FCC) EMC Statement

- This device complies with Part 15 of FCC rules. Operation is subject to the following two conditions:
 - (1) This device may not cause harmful interference.
 - (2) This device must accept any interference received, including interference that may cause undesired operations.
- Changes or modifications not expressly approved by the party responsible for compliance could void the user's authority to operate the equipment.
- This product has been tested and complies with the specifications for a Class B digital device, pursuant to Part 15 of the FCC Rules. These limits are designed to provide reasonable protection against harmful interference in a residential installation. This equipment generates, uses, and can radiate radio frequency energy and, if not installed and used according to the instructions, may cause harmful interference to radio communications. However, there is no guarantee that interference will not occur in a particular installation.
- If this equipment does cause harmful interference to radio or television reception, which is found by turning the equipment off and on, the user is encouraged to try to correct the interference by one or more of the following measures:
 - Reorient or relocate the receiving antenna
 - Increase the separation between the equipment or devices
 - Connect the equipment to an outlet other than the receiver's
 - Consult a dealer or an experienced radio/TV technician for assistance.

Canada

The following information applies if you use the product within Canada area.

Innovation, Science and Economic Development Canada ICES statement

CAN ICES-3 (B)/NMB-3(B)

Europe and the United Kingdom



The following information applies if you use the product within the European Union and United Kingdom.

List of National Codes

COUNTRY	ISO 3166 2 LETTER CODE	COUNTRY	ISO 3166 2 LETTER CODE
Austria	AT	Liechtenstein	LI
Belgium	BE	Lithuania	LT
Bulgaria	BG	Luxembourg	LU
Croatia	HR	Malta	MT
Cyprus	CY	Netherlands	NL
Czech Republic	CZ	Norway	NO
Denmark	DK	Poland	PL
Estonia	EE	Portugal	PT
Finland	FI	Romania	RO
France	FR	Serbia	RS
Germany	DE	Slovakia	SK
Greece	GR	Slovenia	SI
Hungary	HU	Spain	ES
Iceland	IS	Sweden	SE
Ireland	IE	Switzerland	CH
Italy	IT	Turkey	TR
Latvia	LV	United Kingdom	GB

Safety Warnings

- To avoid possible eye injury, do NOT look into an operating fiber-optic module's connector.
- Do NOT use this product near water, for example, in a wet basement or near a swimming pool.
- Do NOT expose your device to dampness, dust or corrosive liquids.
- Do NOT store things on the device.
- Do NOT obstruct the device ventilation slots as insufficient airflow may harm your device. For example, do not place the device in an enclosed space such as a box or on a very soft surface such as a bed or sofa.
- Do NOT install or service this device during a thunderstorm. There is a remote risk of electric shock from lightning.
- Connect ONLY suitable accessories to the device.
- Do NOT open the device or unit. Opening or removing covers can expose you to dangerous high voltage points or other risks. Only qualified service personnel should service or disassemble this device. Please contact your vendor for further information.
- Make sure to connect the cables to the correct ports.
- Place connecting cables carefully so that no one will step on them or stumble over them.
- Always disconnect all cables from this device before servicing or disassembling.
- Do NOT remove the plug and connect it to a power outlet by itself; always attach the plug to the power adaptor first before connecting it to a power outlet.
- Do NOT allow anything to rest on the power adaptor or cord and do NOT place the product where anyone can walk on the power adaptor or cord.
- Please use the provided or designated connection cables/power cables/adaptors. Connect it to the right supply voltage (for example, 120V AC in North America or 230V AC in Europe). If the power adaptor or cord is damaged, it might cause electrocution. Remove it from the device and the power source, repairing the power adapter or cord is prohibited. Contact your local vendor to order a new one.
- Do NOT use the device outside, and make sure all the connections are indoors. There is a remote risk of electric shock from lightning.
- CAUTION: RISK OF EXPLOSION IF BATTERY IS REPLACED BY AN INCORRECT TYPE, DISPOSE OF USED BATTERIES ACCORDING TO THE INSTRUCTION. Dispose them at the applicable collection point for the recycling of electrical and electronic device. For detailed information about recycling of this product, please contact your local city office, your household waste disposal service or the store where you purchased the product.
- Use ONLY power wires of the appropriate wire gauge for your device. Connect it to a power supply of the correct voltage.
- Fuse Warning! Replace a fuse only with a fuse of the same type and rating.
- The PoE (Power over Ethernet) devices that supply or receive power and their connected Ethernet cables must all be completely indoors.
- The following warning statements apply, where the disconnect device is not incorporated in the device or where the plug on the power supply cord is intended to serve as the disconnect device,
 - For PERMANENTLY CONNECTED DEVICES, a readily accessible disconnect device shall be incorporated external to the device;
 - For PLUGGABLE DEVICES, the socket-outlet shall be installed near the device and shall be easily accessible.
- If your device has an earthing screw (frame ground), connect the screw to a ground terminal using an appropriate AWG ground wire. Do this before you make other connections.
- If your device has no earthing screw, but has a 3-prong power plug, make sure to connect the plug to a 3-hole earthed socket.
- When connecting or disconnecting power to hot-pluggable power supplies, if offered with your system, observe the following guidelines:
 - Install the power supply before connecting the power cable to the power supply.
 - Unplug the power cable before removing the power supply.
 - If the system has multiple sources of power, disconnect power from the system by unplugging all power cables from the power supply.
- Do not put the device in a place that is humid, dusty or has extreme temperatures as these conditions may harm your device.
- Please refer to the device back label, datasheet, box specifications or catalog information for the power rating of the device and operating temperature.
- CLASS 1 LASER PRODUCT (for products with mini-GBIC slots or laser products, such as fiber-optic transceiver and GPON products).

- PRODUCT COMPLIES WITH 21 CFR 1040.10 AND 1040.11. (for products with mini-GBIC slots or laser products, such as fiber-optic transceiver and GPON products)
- APPAREIL À LASER DE CLASS 1 (for products with mini-GBIC slots or laser products, such as fiber-optic transceiver and GPON products).
- PRODUIT CONFORME SELON 21 CFR 1040.10 ET 1040.11. (for products with mini-GBIC slots or laser products, such as fiber-optic transceiver and GPON products)

Important Safety Instructions

1 Warning! Energy Hazard. Remove all metal jewelry, watches, and so on from your hands and wrists before serving this device.

2 Caution! The RJ-45 jacks are not used for telephone line connection.

3  Hazardous Moving Parts. Keep body parts away from fan blades.

4  Hot Surface. Do not touch.

1 Avertissement: Risque de choc électrique. Retirer tout bijoux en métal et votre montre de vos mains et poignets avant de manipuler cet appareil.

2 Attention: Les câbles RJ-45 ne doivent pas être utilisés pour les connections téléphoniques.

3  Mobilité des pièces détachées. S'assurer que les pièces détachées ne sont pas en contact avec les pales du ventilateur.

4  Surface brûlante. Ne pas toucher.

Environment Statement

ErP (Energy-related Products)

All Zyxel products put on the EU and United Kingdom markets are in compliance with the requirement of the European Parliament and the Council published Directive 2009/125/EC and UK regulation establishing a framework for the setting of ecodesign requirements for energy-related products (recast), so called as "ErP Directive (Energy-related Products directive) as well as ecodesign requirement laid down in applicable implementing measures, power consumption has satisfied regulation requirements which are:

- Network standby power consumption < 8W and/or
- Off mode power consumption < 0.5W and/or
- Standby mode power consumption < 0.5W.

Disposal and Recycling Information

The symbol below means that according to local regulations your product and/or its battery shall be disposed of separately from domestic waste. If this product is end of life, take it to a recycling station designated by local authorities. At the time of disposal, the separate collection of your product and/or its battery will help save natural resources and ensure that the environment is sustainable development.

Die folgende Symbol bedeutet, dass Ihr Produkt und/oder seine Batterie gemäß den örtlichen Bestimmungen getrennt vom Hausmüll entsorgt werden muss. Wenden Sie sich an eine Recyclingstation, wenn dieses Produkt das Ende seiner Lebensdauer erreicht hat. Zum Zeitpunkt der Entsorgung wird die getrennte Sammlung von Produkt und/oder seiner Batterie dazu beitragen, natürliche Ressourcen zu sparen und die Umwelt und die menschliche Gesundheit zu schützen.

El símbolo de abajo indica que según las regulaciones locales, su producto y/o su batería deberán depositarse como basura separada de la doméstica. Cuando este producto alcance el final de su vida útil, llévelo a un punto limpio. Cuando llegue el momento de desechar el producto, la recogida por separado éste y/o su batería ayudará a salvar los recursos naturales y a proteger la salud humana y medioambiental.

Le symbole ci-dessous signifie que selon les réglementations locales votre produit et/ou sa batterie doivent être éliminés séparément des ordures ménagères. Lorsque ce produit atteint sa fin de vie, amenez-le à un centre de recyclage. Au moment de la mise au rebut, la collecte séparée de votre produit et/ou de sa batterie aidera à économiser les ressources naturelles et protéger l'environnement et la santé humaine.

Il simbolo sotto significa che secondo i regolamenti locali il vostro prodotto e/o batteria deve essere smaltito separatamente dai rifiuti domestici. Quando questo prodotto raggiunge la fine della vita di servizio portarlo a una stazione di riciclaggio. Al momento dello smaltimento, la raccolta separata del vostro prodotto e/o della sua batteria aiuta a risparmiare risorse naturali e a proteggere l'ambiente e la salute umana.

Symbolen innebär att enligt lokal lagstiftning ska produkten och/eller dess batteri kastas separat från hushållsavfallet. När den här produkten når slutet av sin livslängd ska du ta den till en återvinningsstation. Vid tiden för kasseringen bidrar du till en bättre miljö och mänsklig hälsa genom att göra dig av med den på ett återvinningsställe.



台灣



安全警告 – 為了您的安全，請先閱讀以下警告及指示：

- 請勿將此產品接近水、火焰或放置在高溫的環境。
- 避免設備接觸
 - 任何液體 - 切勿讓設備接觸水、雨水、高濕度、污水腐蝕性的液體或其他水份。
 - 灰塵及污物 - 切勿接觸灰塵、污物、沙土、食物或其他不合適的材料。
- 雷雨天氣時，不要安裝或維修此設備。有遭受電擊的風險。
- 切勿重摔或撞擊設備，並勿使用不正確的電源變壓器。
- 若接上不正確的電源變壓器會有爆炸的風險。
- 請勿隨意更換產品內的電池。
- 如果更換不正確之電池型式，會有爆炸的風險，請依製造商說明書處理使用過之電池。
- 請將廢電池丟棄在適當的電器或電子設備回收處。
- 請勿將設備解體。
- 請勿阻礙設備的散熱孔，空氣對流不足將會造成設備損害。
- 請使用隨貨提供或指定的連接線 / 電源線 / 電源變壓器，將其連接到合適的供應電壓 (如：台灣供應電壓 110 伏特)。
- 假若電源變壓器或電源變壓器的纜線損壞，請從插座拔除，若您還繼續插電使用，會有觸電死亡的風險。
- 請勿試圖修理電源變壓器或電源變壓器的纜線，若有毀損，請直接聯絡您購買的店家，購買一個新的電源變壓器。
- 請勿將此設備安裝於室外，此設備僅適合放置於室內。
- 請勿隨一般垃圾丟棄。
- 請參閱產品背貼上的設備額定功率。
- 請參考產品型錄或是彩盒上的作業溫度。
- 設備必須接地，接地導線不允許被破壞或沒有適當安裝接地導線，如果不確定接地方式是否符合要求可聯繫相應的電氣檢驗機構檢驗。
- 如果您提供的系統中有提供熱插拔電源，連接或斷開電源請遵循以下指導原則：
 - 先連接電源線至設備連，再連接電源。
 - 先斷開電源再拔除連接至設備的電源線。
 - 如果系統有多個電源，需拔除所有連接至電源的電源線再關閉設備電源。
- 產品沒有斷電裝置或者採用電源線的插頭視為斷電裝置的一部分，以下警語將適用：
 - 對永久連接之設備，在設備外部須安裝可觸及之斷電裝置；
 - 對插接式之設備，插座必須接近安裝之地點而且是易於觸及的。

About the Symbols

Various symbols are used in this product to ensure correct usage, to prevent danger to the user and others, and to prevent property damage. The meaning of these symbols are described below. It is important that you read these descriptions thoroughly and fully understand the contents.

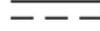
Explanation of the Symbols

SYMBOL	EXPLANATION
	Alternating current (AC): AC is an electric current in which the flow of electric charge periodically reverses direction.
	Direct current (DC): DC is the unidirectional flow or movement of electric charge carriers.
	Earth; ground: A wiring terminal intended for connection of a Protective Earthing Conductor.
	Class II equipment: The method of protection against electric shock in the case of class II equipment is either double insulation or reinforced insulation.

Viewing Certifications

Go to <http://www.zyxel.com> to view this product's documentation and certifications.

Zyxel Limited Warranty

Zyxel warrants to the original end user (purchaser) that this product is free from any defects in material or workmanship for a specific period (the Warranty Period) from the date of purchase. The Warranty Period varies by region. Check with your vendor and/or the authorized Zyxel local distributor for details about the Warranty Period of this product. During the warranty period, and upon proof of purchase, should the product have indications of failure due to faulty workmanship and/or materials, Zyxel will, at its discretion, repair or replace the defective products or components without charge for either parts or labor, and to whatever extent it shall deem necessary to restore the product or components to proper operating condition. Any replacement will consist of a new or re-manufactured functionally equivalent product of equal or higher value, and will be solely at the discretion of Zyxel. This warranty shall not apply if the product has been modified, misused, tampered with, damaged by an act of God, or subjected to abnormal working conditions.

Note

Repair or replacement, as provided under this warranty, is the exclusive remedy of the purchaser. This warranty is in lieu of all other warranties, express or implied, including any implied warranty of merchantability or fitness for a particular use or purpose. Zyxel shall in no event be held liable for indirect or consequential damages of any kind to the purchaser.

To obtain the services of this warranty, contact your vendor. You may also refer to the warranty policy for the region in which you bought the device at <https://www.zyxel.com/global/en/support/warranty-information>.

Registration

Register your product online at www.zyxel.com to receive email notices of firmware upgrades and related information.

Trademarks

The trademarks mentioned in this publication are used for identification purposes only and may be properties of their respective owners.

Index

Numbers

1/2.5/10 Gbps [7](#)

100 Mbps [7](#)

A

address learning [8](#)

air circulation
for cooling [11](#)

applications
PoE [10](#)

authorized technician
install the Switch [11](#)

auto-MDIX port [16](#)

auto-negotiating [8](#)

auto-sensing crossover [8](#)

B

bandwidth capacity [9](#)

C

cable
PoE [9](#)
supported [9](#)

cable type
Ethernet [9](#)

Cabling Length [23](#)

Category 5 [9](#)

Category 5e [9](#)

certifications
viewing [33](#)

Class of Service (CoS) [8](#)

clearance

Switch installation [11](#)

contact information [24](#)

copyright [29](#)

CoS [8](#)

CoS (Class of Service) [8](#)

crossover Ethernet cable [16](#)

customer support [24](#)

D

Data path loop [23](#)

disclaimer [29](#)

distance
maximum [9](#)

distance between holes
wall mount [11, 12](#)

distance limitation [9](#)

dual personality interface [18](#)

duplex mode [8](#)

dust plug [17](#)

E

electrostatic discharge (ESD) [16](#)

Environment Statement [29, 31](#)

Ethernet port [7](#)
auto-crossover [16](#)
auto-negotiating [16](#)

F

Faulty cables [23](#)

FCC interference statement [29](#)

feature comparison [7, 9](#)

features
Switch [8](#)

fiber cable
 connecting [17](#)
 removal [18](#)
forwarding rate
 wire speed [8](#)
freestanding installation
 precautions [12](#)
front panel [15](#)

H

hardware installation [11](#)
hardware overview [15](#)

I

IEEE 802.1p CoS
 built-in [8](#)
IEEE 802.3ab standard [8](#)
IEEE 802.3ae standard [8](#)
IEEE 802.3af [9](#)
IEEE 802.3at [9](#)
IEEE 802.3bt [7, 9](#)
IEEE 802.3bz standard [8](#)
IEEE 802.3u standard [8](#)
IEEE 802.3x standard [8](#)
IEEE 802.3z standard [8](#)
IEEE standard [9](#)
Innovation, Science and Economic Development
 Canada ICES statement [29](#)
installation
 air circulation [11](#)
 desktop [12](#)
 transceiver [17](#)
 wall mounting [12](#)
installation requirements
 rack-mounting [13](#)
installation scenarios [11](#)

L

LED

 description [20](#)
 Link / ACT [20](#)
 PoE MAX [20](#)
 PoE++ 60W [21](#)
 PWR [20](#)
Link / ACT
 LED [20](#)
loop detection
 built-in [7](#)

M

MAC address entry [8](#)
MAC address table [8](#)
management method [9](#)
MDIX (Media Dependent Interface Crossover) [16](#)
Mounting Methods [11](#)
multi-gigabit Ethernet [8](#)
multi-gigabit port [16](#)

N

network applications [10](#)
network cable
 crossover [15](#)
 straight-through [15](#)
Network Cable Types [15, 20](#)
Non-standard network cables [23](#)
N-Way protocol
 for speed [8](#)

O

overheating
 prevention [11](#)

P

PD (Powered Device) [9](#)
PoE [10, 23, 30](#)

PoE MAX
 LED [20](#)

PoE port [7](#)

PoE standard [9](#)
 support [8](#)

PoE standards table [9](#)

PoE type [9](#)

PoE++ [9](#)

PoE++ 60W
 LED [21](#)

port
 voltage range [9](#)

power
 port [9](#)

power adapter [7, 11](#)

power budget
 PoE [9](#)

power connections [19](#)

power connector [19](#)

power management mode [9](#)

power per port
 maximum [9](#)

Power Sourcing Equipment (PSE) [9](#)

Powered Device (PD) [7, 9](#)

product registration [33](#)

PSE (Power Sourcing Equipment) [9](#)

PWR
 LED [20](#)

R

rear panel [18](#)

registration
 product [33](#)

Regulatory Notice and Statement [29](#)

rubber feet
 attach [12](#)

S

safety precautions
 using the Switch [12](#)

safety warnings [30](#)

screw anchors
 using [13](#)

SFP/SFP+ slot [16](#)

SFP+ slot [7](#)

SFP+ transceiver [7](#)

Small Form-factor Pluggable (SFP) [16](#)

speed
 transmission [9](#)

store-and-forward switching [8](#)

straight-through Ethernet cable [16](#)

Switch
 fanless-type usage precaution [11](#)
 fan-type usage precaution [11](#)

Switch models [7](#)

T

trademarks [33](#)

transceiver
 connection speed [16](#)
 installation [17](#)
 removal [17](#)

transceiver MultiSource Agreement (MSA) [16](#)

transceivers [16](#)

transmission speed [9](#)

Troubleshooting
 Improper Network Cabling and Topology [23](#)

twisted pairs
 used [9](#)

U

uplink connection [7](#)

V

ventilation holes [11](#)

voltage range
 port [9](#)

W

wall mount

distance above the floor **13**

wall mounting **12**

distance between holes **13**

wall-mountable **7**

warranty

note **33**

wire speed forwarding rate **8**