



User's Guide

Fibre Channel Adapter

**QLE2740-DEL, QLE2740L-DEL,
QLE2742-DEL, QLE2742L-DEL,
QME2742-DEL, QLE2770-DEL,
QLE2770L-DEL, QLE2772-DEL, and
QLE2772L-DEL**



Third party information brought to
you courtesy of Dell.

BK3254601-00 J
October 28, 2019



For more information, visit our website at: <http://www.marvell.com>

Notice

THIS DOCUMENT AND THE INFORMATION FURNISHED IN THIS DOCUMENT ARE PROVIDED "AS IS" WITHOUT ANY WARRANTY. MARVELL EXPRESSLY DISCLAIMS AND MAKES NO WARRANTIES OR GUARANTEES REGARDING THE PRODUCT, WHETHER EXPRESS, ORAL, IMPLIED, STATUTORY, ARISING BY OPERATION OF LAW, OR AS A RESULT OF USAGE OF TRADE, COURSE OF DEALING, OR COURSE OF PERFORMANCE, INCLUDING THE IMPLIED WARRANTIES OF MERCHANTABILITY AND FITNESS FOR PARTICULAR PURPOSE AND NON-INFRINGEMENT.

Information furnished is believed to be accurate and reliable. However, Marvell assumes no responsibility for the consequences of use of such information or for any infringement of patents or other rights of third parties that may result from its use. No license, express or implied, to any Marvell intellectual property rights is granted by this document. Marvell products are not authorized for use as critical components in medical devices, military systems, life or critical support devices, or related systems. Marvell retains the right to make changes to this document at any time, without notice.

Export Control

The user or recipient of this document acknowledges that the information included in this document may be subject to laws including, but not limited to, U.S. export control laws and regulations regarding the export, re-export, transfer, diversion, or release of such information. The user or recipient must comply with all applicable laws and regulations at all times. These laws and regulations include restrictions on prohibited destinations, end users, and end uses.

Patents/Trademarks

Products identified in this document may be covered by one or more Marvell patents and/or patent applications. You may not use or facilitate the use of this document in connection with any infringement or other legal analysis concerning the Marvell products disclosed herein. Marvell and the Marvell logo are registered trademarks of Marvell or its affiliates. Please visit www.marvell.com for a complete list of Marvell trademarks and any guidelines for use of such trademarks. Other names and brands may be claimed as the property of others.

Copyright

Copyright © 2015–2019. Marvell International Ltd. All rights reserved.

Table of Contents

Introduction

Intended Audience	x
User's Guide Content	x
Related Materials	xi
Documentation Conventions	xi
Functionality and Features	xiii
Functional Description	xiii
Key Features	xiv
Supported Operating Systems	xiv
Microsoft	xiv
Red Hat	xv
SuSE	xv
VMware	xv
Citrix	xv

1 Hardware Installation

Hardware and Software Requirements	1
Safety Precautions	1
Pre-Installation Checklist	2
PCIe Bus Slot Considerations	2
Installing the Adapter	3
Connecting to the SAN	4

2 Driver Installation and Configuration

Windows Driver Installation and Configuration	5
Running the Dell Update Package in the GUI	6
Running the Dell Update Package from the Command Line	11
Examples	12
Linux Driver Installation and Configuration	12
Installation Overview	12
Installing the Linux Fibre Channel Driver	13
Building the Driver for RHEL 7.x and 8.x	13
Building the Driver for SLES 12 SP4 and SLES 15/15 SP 1	14
VMware Driver Installation and Configuration	15

Installation Overview	15
Installing the ESXi 6.7 U3 and 6.5 U3 Fibre Channel Driver	16
Updating an Existing Driver or Installing a New Driver for an Existing ESXi 6.7 U3 and 6.5 U3 Installation with esxcli	16
Verifying the Version of the Installed Driver	17
Installing the QConvergeConsole VMware vCenter Server Plug-in	17
Installation Package Contents	18
Installing the QConvergeConsole VMware vCenter Server Plug-in Plug-in Unregistration from a Manual Install.	18
Uninstalling the QConvergeConsole VMware vCenter Server Plug-in	23
Installing the QLogic Adapter CIM Provider	24
Uninstalling the QLogic Adapter CIM Provider	24
Installing the QConvergeConsole VMware vSphere Web Client Plug-in Before You Begin	28
Installing QConvergeConsole VMware vSphere Web Client Plug-in	28
Uninstalling the QConvergeConsole VMware vSphere Web Client Plug-in	29
Configuring VM-ID	30

3 Fibre Channel Configuration

Updating the Dell Firmware	32
Running the Firmware Update by Double-Clicking	32
Running the Firmware Update from the Command Line	35
Using <i>Fast!UTIL</i> for Custom Configuration.	36
Configuration Settings	37
Adapter Settings	37
Selectable Boot Settings	39
Restore Default Settings.	40
Raw NVRAM Data	40
Advanced Adapter Settings	40
Scan Fibre Devices	41
Fibre Disk Utility.	41
Loopback Data Test.	42
Select Adapter	42
Exit <i>Fast!UTIL</i>	42
Setting Fibre Channel Adapter Parameters	43
Setting Fibre Channel Adapter Parameters with QConvergeConsole GUI	43
Setting Fibre Channel Adapter Parameters with Interactive QConvergeConsole CLI	43

Setting Fibre Channel Adapter Parameters with Noninteractive QConvergeConsole CLI	44
Configuring Target Persistent Binding	44
Configuring Persistent Binding with QConvergeConsole GUI.	44
Configuring Persistent Binding with Interactive QConvergeConsole CLI	45
Configuring Persistent Binding with Noninteractive QConvergeConsole CLI	45
Configuring Boot Devices	46
Configuring Boot Devices with QConvergeConsole GUI.	46
Configuring Boot Devices with Interactive QConvergeConsole CLI	46
Configuring Boot Devices with Noninteractive QConvergeConsole CLI	46
Configuring Boot Devices with the BIOS.	47
Configuring Virtual Ports (NPIV).	47
Configuring NPIV with QConvergeConsole GUI	47
Configuring NPIV with Interactive QConvergeConsole CLI.	47
Configuring NPIV with Noninteractive QConvergeConsole CLI	47
Configuring NPIV Quality of Service	48
Setting QoS by Bandwidth	49
Setting QoS by Priority	52
Configuring Fibre Channel Driver Parameters	53
Configuring Fibre Channel Driver Parameters with QConvergeConsole GUI	54
Configuring Fibre Channel Driver Parameters with Interactive QConvergeConsole CLI	54
Configuring Fibre Channel Driver Parameters with Noninteractive QConvergeConsole CLI	54
Configuring Fibre Channel Driver Parameters with QConvergeConsole VMware vCenter Server Plug-in	55
Configuring Selective LUNs	55
Configuring OoOFR	55
Configuring OoOFR with QCC GUI.	55
Configuring OoOFR with Interactive QCC CLI	55
Configuring OoOFR with Noninteractive QCC CLI	56
Configuring the UEFI Driver	56
Setting Queue Depth	64
Changing the Windows Queue Depth	64
Changing the Linux Queue Depth	65
Changing the ESXi Queue Depth	65
Setting an FA-PWWN	65

Setting the FA-PWWN from the Adapter	65
Setting FA-PWWN with QConvergeConsole GUI	66
Setting FA-PWWN with QConvergeConsole CLI	67
Setting FA-PWWN with QConvergeConsole VMware Plug-ins	69
Setting the FA-PWWN from the Brocade Switch	70
Setting the FA-PWWN from the Switch	70
Setting the Static FA-PWWN from the Switch	70
Configuring and Verifying FA-BLD	71
Configuring FA-BLD from the Adapter	71
Enabling Host Bus Adapter Port BIOS and Fabric-assigned Boot LUN with QConvergeConsole GUI	71
Configuring the Adapter and Boot Devices with QConvergeConsole CLI	73
Configuring a Zone in a Brocade Switch	74
Verifying that FA-BLD is Operational	75
Adapter Side Restrictions	76
Using a Fabric-Assigned Boot LUN	77
Using a Fabric-Assigned Boot LUN in QConvergeConsole GUI	77
Using a Fabric-Assigned Boot LUN in Interactive QConvergeConsole CLI	77
Using a Fabric-Assigned Boot LUN with Noninteractive QConvergeConsole CLI	77
Using a Fabric-Assigned Boot LUN with QConvergeConsole Plug-ins	78
Running Diagnostics—Fibre Channel Ping and Trace Route	79
Pinging and Viewing Trace of Routing Using Topology Map	79
Running a Fibre Channel CT Ping Test	80
Running a Fibre Channel CT Ping from QConvergeConsole GUI	80
Running a Fibre Channel CT Ping from QConvergeConsole CLI	81
Running a Fibre Channel CT Ping from QConvergeConsole VMware Plug-ins	82
Fibre Channel Trace Route	82
Configuring CS_CTL QoS	84
CS_CTL QoS Features	84
Enabling CS_CTL QoS Mode for the Initiator and Target Ports	85
Verifying and Confirming CS_CTL Mode Setup for Each Port	85
Creating a Virtual Port from the Adapter's Port in QConvergeConsole GUI	85
Setting the QoS Priority Level for a Virtual Port in QConvergeConsole GUI	87
Configuring End-to-End CS_CTL QoS	87
Configuring CS_CTL QoS on the Switch	88

Configuring CS_CTL QoS on the Storage Device	89
Changing the QoS Priority Levels	89
Changing the Priority Levels in Windows	89
Changing the Priority Levels in VMware ESXi	91
Configuring FDMI	93
Brocade Switch FOS CLI	94
Fabric Features	95
FDMI Enhancements Support	96
Enabling QLogic Forward Error Correction	98
FEC Process Overview	98
Enabling QLogic FEC	99
Running Extended Link Service Commands	100
Link Cable Beacon Extended Link Service Command	101
Read Diagnostic Parameters Extended Link Service Command	101
4	NVM Express over Fibre Channel
Hardware and Software Requirements	104
Adapters	104
Operating Systems	104
Host Software	105
Host Setup	106
Setting Up the Host	106
Linux Host Setup	106
Windows Host Setup	110
Verifying the Adapter Firmware	110
Verifying Adapter Firmware	110
Verifying the Availability of FC-NVMe Devices	111
Verifying in Linux	111
Verifying in Windows	112
Limitations and Known Issues	113
Unloading and Reloading the Linux Driver	113
A	Troubleshooting
Fibre Channel Diagnostics	115
Fibre Channel Diagnostics Using QConvergeConsole GUI	115
Fibre Channel Diagnostics Using Interactive QConvergeConsole CLI	117
Fibre Channel Diagnostics Using Noninteractive QConvergeConsole CLI	117
Fibre Channel Troubleshooting Diagram	118
Troubleshooting with a Diagnostic Port (D_Port)	119

	Configuring D_Port on a Brocade Fibre Channel 16G or 32G Switch.	120
	Configuring and Running Diagnostics Port on a Cisco Fibre Channel 16 or 32G Switch.	121
	Checking D_Port Results from a Brocade Fibre Channel 16G or 32G Switch	122
	Verifying D_Port Mode with QConvergeConsole GUI.	123
	Verifying D_Port Mode with Interactive QConvergeConsole CLI	124
	Verifying D_Port Mode with Noninteractive QConvergeConsole CLI	124
	Verifying D_Port Mode with QConvergeConsole Plug-ins.	125
B	Specifications	
	Physical Characteristics	126
	Power Requirements	127
	Standards Specifications	127
	Interface Specifications	127
	Environmental Specifications	128
C	QConvergeConsole GUI	
	Introduction to QConvergeConsole GUI.	129
	Downloading QConvergeConsole Documentation.	130
	Downloading and Installing Management Agents	130
	Installing the Agents from the Marvell Web Site	130
	Installing the Agents Using the Built-in Agent Installer	131
	Installing QConvergeConsole GUI	131
	Installing QConvergeConsole in a Windows Environment	132
	Installing QConvergeConsole in a Linux Environment	133
	Installing QConvergeConsole in Silent Mode	134
	What Is in the QConvergeConsole Help System	134
D	Regulatory Information	
	Warranty.	136
	Regulatory and Compliance Information	136
	Laser Safety, FDA Notice	136
	Agency Certification.	137
	EMI and EMC Requirements	137
	Product Safety Compliance	138
E	Adapter LEDs	
F	Revision History	

Introduction

This introductory chapter provides a list of the covered models, describes the intended audience and contents of this guide, lists related documents and the document conventions, describes the product functionality and features, and lists the supported OSs.

This user's guide covers the following products:

- QLogic® QLE2740-DEL single-port, low profile adapter with a full-height bracket
- QLogic QLE2740L-DEL single-port, low profile adapter with a low profile bracket
- QLogic QLE2742-DEL dual-port, low profile adapter with a full-height bracket
- QLogic QLE2742L-DEL dual-port, low profile adapter with a low profile bracket
- QLogic QME2742-DEL dual-port mezzanine adapter
- QLogic® QLE2770-DEL single-port, low profile adapter with a full-height bracket
- QLogic QLE2770L-DEL single-port, low profile adapter with a low profile bracket
- QLogic QLE2772-DEL dual-port, low profile adapter with a full-height bracket
- QLogic QLE2772L-DEL dual-port, low profile adapter with a low profile bracket

NOTE

Throughout this document, the term *adapter* refers to any or all of these products.

This guide provides technical information about the adapters, including how to install and configure the adapter, as well as detailed descriptions of the adapter's various uses and functions.

Intended Audience

This guide is intended for system administrators and other technical staff members responsible for configuring and managing adapters installed on Dell® PowerEdge® servers in Windows®, Linux®, or VMware® environments.

User's Guide Content

This guide provides information in the following chapters and appendices:

- [Chapter 1 Hardware Installation](#) covers the hardware and software requirements, safety precautions, a pre-installation checklist, PCI Express® (PCIe®) slot considerations, and procedures for installing the adapter and connecting it to the network.
- [Chapter 2 Driver Installation and Configuration](#) covers the installation of the drivers included with the adapter on Windows, Linux, and VMware OSs.
- [Chapter 3 Fibre Channel Configuration](#) provides information about the multiboot image (Fibre Channel Adapter Function Configuration Utility) and instructions for setting Fibre Channel Adapter parameters; persistent binding; configuring the boot device, N_Port ID virtualization (NPIV), and driver parameters; and reassembling out-of-order frames.
- [Chapter 4 NVM Express over Fibre Channel](#) provides information on installing and configuring NVM Express on selected Fibre Channel Adapters.
- [Appendix A Troubleshooting](#) provides information about Fibre Channel diagnostics and a Fibre Channel troubleshooting diagram.
- [Appendix B Specifications](#) defines the physical characteristics and power requirements and lists supported standards, interface, and environmental specifications.
- [Appendix C QConvergeConsole GUI](#) provides an overview of the QConvergeConsole® Web management interface.
- [Appendix D Regulatory Information](#) provides warranty, regulatory, and compliance information.
- [Appendix E Adapter LEDs](#) describes the adapter port LEDs.
- [Appendix F Revision History](#) describes the changes made in this revision of the guide.

Related Materials

For additional information, refer to the following QLogic documents:

- *QConvergeConsole Help*, available after installing QConvergeConsole GUI, provides help topics on configuring and managing host servers and adapters using QConvergeConsole GUI.
- *Installation Guide—QConvergeConsole GUI* (part number SN0051105-00) contains instructions for installing and starting QConvergeConsole GUI.
- *User's Guide—QConvergeConsole CLI* (part number SN0054667-00) provides specific command line use in both interactive and noninteractive modes.
- *User's Guide—QConvergeConsole Plug-ins for VMware vSphere* (part number SN0054677-00) provides reference material on using the QConvergeConsole VMware vCenter Server Plug-in and the QConvergeConsole VMware vSphere Web Client Plug-in.

NOTE

To access QLogic product documents, visit the Marvell Web site, www.marvell.com.

Documentation Conventions

This guide uses the following documentation conventions:

- **NOTE** provides additional information.
- **CAUTION** without an alert symbol indicates the presence of a hazard that could cause damage to equipment or loss of data.
- **⚠ WARNING** indicates the presence of a hazard that could cause serious injury or death.
- Text in **blue** font indicates a hyperlink (jump) to a figure, table, or section in this guide, and links to Web sites are shown in **underlined blue**. For example:
 - ❑ **Table 9-2** lists problems related to the user interface and remote agent.
 - ❑ See **"Installation Checklist"** on page 3-6.
 - ❑ For more information, visit **www.marvell.com**.

- Text in **bold** font indicates user interface elements such as a menu items, buttons, check boxes, or column headings. For example:
 - ❑ Click **Start**, point to **Programs**, point to **Accessories**, and then click **Command Prompt**.
 - ❑ Under **Notification Options**, select the **Warning Alarms** check box.
- Text in `Courier` font indicates a file name, directory path, or command line text. For example:
 - ❑ To return to the root directory from anywhere in the file structure, type `cd /root`, and then press the ENTER key.
 - ❑ Issue the following command: `# sh ./install.bin`
- Key names and key strokes are indicated with UPPERCASE:
 - ❑ Press the CTRL+P keys.
 - ❑ Press the UP ARROW key
- Text in *italics* indicates terms, emphasis, variables, or document titles. For example:
 - ❑ For a complete listing of license agreements, refer to the *QLogic Software End User License Agreement*.
 - ❑ What are *shortcut keys*?
 - ❑ To enter the date, type *mm/dd/yyyy* (where *mm* is the month, *dd* is the day, and *yyyy* is the year).
- Topic titles between quotation marks identify related topics either within this manual or in the online help, which is also referred to as *QConvergeConsole Help* throughout this document.
- QConvergeConsole CLI non-interactive command syntax conventions include the following:
 - ❑ Plain text indicates items that you must type as shown. For example:
 - `qacli -pr nic -ei`
 - ❑ `< >` (angle brackets) indicate a variable whose value you must specify. For example:
 - `<hba instance>`

NOTE

For CLI commands only, variable names are always indicated using angle brackets instead of *italics*.

- ❑ [] (square brackets) indicate an optional parameter. For example:
 - [`<file_name>`] means specify a file name, or omit it to select the default file name.
- ❑ | (vertical bar) indicates mutually exclusive options; select one option only. For example:
 - `on|off`
 - `1|2|3|4`
- ❑ ... (ellipsis) indicates that the preceding item may be repeated. For example:
 - `x...` means *one* or more instances of `x`.
 - [`x...`] means *zero* or more instances of `x`.
- ❑ () (parentheses) and { } (braces) are used to avoid logical ambiguity. For example:
 - `a|b c` is ambiguous
 - { `(a|b) c` } means *a* or *b*, followed by *c*
 - { `a|(b c)` } means either *a*, or *b c*

Functionality and Features

This section provides the following information:

- [Functional Description](#)
- [Key Features](#)
- [Supported Operating Systems](#)

Functional Description

Functional descriptions for the adapters are as follows:

- **QLE2740-DEL:** A low profile, Gen 6 32Gb, single-port Fibre Channel PCIe adapter with a full-height bracket installed.
- **QLE2740L-DEL:** A low profile, Gen 6 32Gb, single-port Fibre Channel PCIe adapter with a low profile bracket installed.
- **QLE2742-DEL:** A low profile, Gen 6 32Gb, dual-port Fibre Channel PCIe adapter with a full-height bracket installed.
- **QLE2742L-DEL:** A low profile, Gen 6 32Gb, dual-port Fibre Channel PCIe adapter with a low profile bracket installed.
- **QME2742-DEL:** A Gen 6 32Gb, dual-port, Fibre Channel mezzanine adapter for the blade server environment

- **QLE2770-DEL:** A low profile, Gen 7 32Gb, single-port Fibre Channel PCIe adapter with a full-height bracket installed.
- **QLE2770L-DEL:** A low profile, Gen 7 32Gb, single-port Fibre Channel PCIe adapter with a low profile bracket installed.
- **QLE2772-DEL:** A low profile, Gen 7 32Gb, dual-port Fibre Channel PCIe adapter with a full-height bracket installed.
- **QLE2772L-DEL:** A low profile, Gen 7 32Gb, dual-port Fibre Channel PCIe adapter with a low profile bracket installed.

Key Features

Key features of the adapters include:

- Centralized device management for SAN
- Connectivity to 32Gb/16Gb/8Gb¹ Fibre Channel networks
- PCIe 3.0 x8
- Add PCIe 4.0 x8 (QLE277x only)
- Device Guard support
- Full hardware offload for the Fibre Channel protocol
- Message-signaled interrupts (MSI-X) and legacy interrupts (INT-X)
- NPIV
- Boot from SAN
- Several advanced management features for 2700 Series Adapters:
 - ❑ QConvergeConsole (GUI and CLI) is available if you are running Windows or Linux.
 - ❑ QConvergeConsole VMware vCenter Server Plug-in is available if you are running VMware ESXi.

Supported Operating Systems

NOTE

Because the *Dell Update Packages Version xx.xx.xxx User's Guide* is not updated in the same cycle as this Fibre Channel adapter user's guide, consider the operating systems listed in this section as the more current.

The adapter supports the following operating systems. To view the most complete and current list, refer to the product release notes.

Microsoft

- Windows Server® 2019

¹ 8Gb and 16Gb do not apply to QME2742-DEL.

- Windows Server 2016
- Windows Server 2012 R2

Red Hat

- Red Hat® Enterprise Linux (RHEL®) 7.6
- RHEL 7.7
- RHEL 8.0
- RHEL 8.1

SuSE

- SuSE® Linux Enterprise Server (SLES®) 12 SP4
- SLES 15
- SLES 15 SP1

VMware

- vSphere®: VMware ESXi 6.5 U3
- vSphere: VMware ESXi 6.7 U3

Citrix

- Citrix Hypervisor 8.0
- Citrix® XenServer® 7.1 CU2

NOTE

For the most current versions of the OS and drivers supported by the adapter, refer to the release notes file (`release.txt`).

1 Hardware Installation

This chapter provides the hardware and software requirements, safety precautions, a pre-installation checklist, PCIe slot considerations, and procedures for installing the adapter and connecting it to the network.

Hardware and Software Requirements

Before you install the adapter, verify that the system meets the following hardware and software requirements.

- **Hardware:**
 - ❑ For QLE27xx -DEL Adapters port and slot assignments, refer to the “Expansion Cards” section of the *Hardware Owner’s Manual* for your Dell PowerEdge server.
 - ❑ For QME2742-DEL adapter port and slot assignments, refer to the blade and M1000e chassis diagram in the *Dell PowerEdge M1000e Systems Configuration Guide*.
- **Software:** For information on the supported operating systems, firmware versions, adapter drivers, and utilities, refer to the product release notes.

Safety Precautions

⚠ WARNING

The adapter is being installed in a system that operates with voltages that can be lethal. Before you open the case of your system, observe the following precautions to protect yourself and to prevent damage to the system components.

For your safety, follow these precautions:

- Remove any metallic objects or jewelry from your hands and wrists.
- Make sure to use only insulated or nonconducting tools.

- Before you touch internal components, verify that the system is powered OFF and is unplugged.
- Install or remove adapters in a static-free environment. The use of a properly grounded wrist strap or other personal anti-static devices and an anti-static mat is strongly recommended.

Pre-Installation Checklist

1. Verify that your system meets the hardware and software requirements listed in “[Hardware and Software Requirements](#)” on page 1.
2. Verify that your system is using the latest BIOS.

NOTE

If you acquired the adapter software on a disk or from the Dell support Web site (<http://support.dell.com>), verify the path to the adapter driver files.

3. Check the adapter for visible signs of damage. Never attempt to install a damaged adapter.

PCIe Bus Slot Considerations

The size of the PCIe bus slot in which you install the adapter will affect the speed throughput. [Table 1-1](#) lists the approximate speed throughput for each bus slot size.

Table 1-1. Approximate Speed Throughput per Bus Slot Size

Slot Size	PCIe Generation (Speed) Throughput			
	PCIe Gen1 (2.5 GT/s)	PCIe 2.0 (5 GT/s)	PCIe 3.0 (8 GT/s)	PCIe 4.0 (16 GT/s)
x8 slot	~20GFC (2.5 × 8)	~40GFC (5 × 8)	~64GFC (8 × 8)	128GFC (16x8)
x16 slot	~40GFC (2.5 × 16)	~80GFC (5 × 16)	~128GFC (8 × 16)	256GFC (16x16)

Table 1-2 lists the throughput needed to achieve line rates.

Table 1-2. Throughput Requirements to Achieve Line Rate

Number of 32G FC Ports	Model Number	PCIe Throughput Required to Achieve Line Rate	Minimum PCIe Gen and Slot Configurations
1	QLE2740-DEL, QLE2740L-DEL QLE2770-DEL QLE2770L-DEL	32GFC (1 × 32GFC)	PCIe 2.0 x8 and higher PCIe 3.0 x8 and higher
2	QLE2742-DEL, QLE2742L-DEL, QME2742-DEL QLE2772-DEL QLE2772L-DEL	64GFC (2 × 32GFC)	PCIe 3.0 x8 and higher

Installing the Adapter

To install the QLE27xx -DEL Adapters:

1. Power off the computer and all attached devices such as monitors, printers, and external components.
2. Disconnect the power cable.
3. Remove the computer cover and find an empty PCIe bus slot. For more information about selecting a bus slot, see [“PCIe Bus Slot Considerations” on page 2](#).
4. Pull out the slot cover (if any).
5. Grasp the adapter by the top edge and seat it firmly into the appropriate slot.
6. Refasten the adapter’s retaining bracket.
7. Close the computer cover.
8. Plug the Fibre Channel cable into the adapter.
9. Plug in the power cable and turn on the computer.

To install the QME2742-DEL Adapters:

Refer to the “I/O Module Mezzanine Cards” and “Guidelines for Installing I/O Modules” sections of the *Dell PowerEdge Modular Systems Hardware Owner’s Manual*:

ftp://ftp.dell.com/Manuals/all-products/esuprt_ser_stor_net/esuprt_poweredge/powered-edge-m610x_Owner%27s%20Manual_en-us.pdf

For more detailed information, refer to the *Hardware Owner's Manual* for your Dell PowerEdge server.

Connecting to the SAN

To connect the QLE27xx -DEL Adapters to the SAN, refer to the *Hardware Owner's Manual* for your Dell PowerEdge server.

To connect the QME2742-DEL mezzanine adapter to the SAN, refer to the “Guidelines for Installing I/O Modules” section of the *Dell PowerEdge Modular Systems Hardware Owner's Manual*:

ftp://ftp.dell.com/Manuals/all-products/esuprt_ser_stor_net/esuprt_poweredge/poweredge-m610x_Owner%27s%20Manual_en-us.pdf

2 Driver Installation and Configuration

NOTE

If you need to update the Flash memory of multiple adapters simultaneously:

- For QConvergeConsole GUI, refer to the “Update the Flash Using the Flash Update Wizard” topic in the *QConvergeConsole Help*.
- For QConvergeConsole CLI, issue the `-flashsupport` command to update the Flash memory for all cards supported by the specified file. For example:

```
qacucli -pr nic -flashsupport -i ALL -a p3p11179.bin
```

This chapter provides the following information about the drivers included with the adapters:

- [“Windows Driver Installation and Configuration” on page 5](#)
- [“Linux Driver Installation and Configuration” on page 12](#)
- [“VMware Driver Installation and Configuration” on page 15](#)

NOTE

When you disable the firmware (for example, during a firmware dump or during a firmware update) in Windows or Linux with a QConvergeConsole agent, multiple application messages are generated. These messages are generated because the application cannot communicate with the adapter while the firmware is disabled. After the firmware is re-enabled, the errors will go away.

Windows Driver Installation and Configuration

You can run a software or driver Dell Update Package (DUP) in two ways:

- [Running the Dell Update Package in the GUI](#)
- [Running the Dell Update Package from the Command Line](#)

Running the Dell Update Package in the GUI

Before you begin, refer to the *Dell Update Packages Version xx.xx.xxx User's Guide*, "Prerequisites and Features for Systems Running Windows" section.

To run the DUP in the GUI:

1. Double-click the icon representing the DUP file. (The actual file name of the DUP varies.)
2. In the Dell Update Package window (Figure 2-1), click **Install**.



Figure 2-1. Dell Update Package Window

3. In the QLogic Super Installer—InstallShield® Wizard's Welcome window (Figure 2-2), click **Next**.

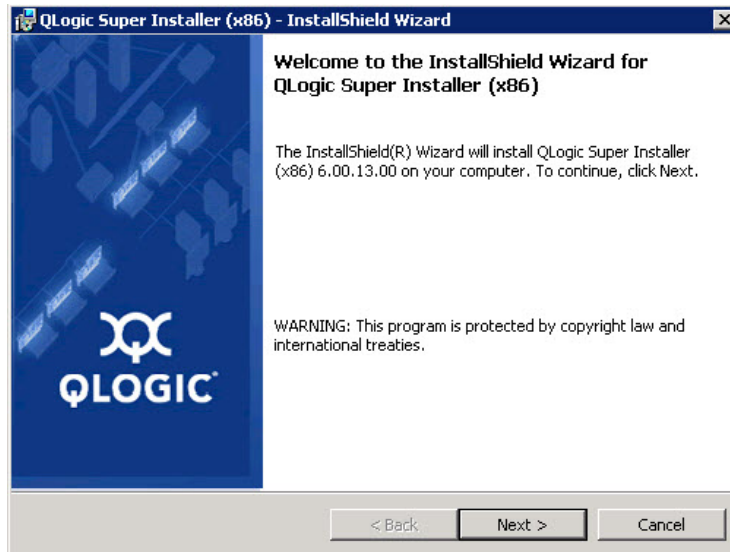

Figure 2-2. QLogic InstallShield Wizard: Welcome Window

4. In the wizard's License Agreement window (Figure 2-3):
 - a. Read the QLogic End User Software License Agreement.
 - b. To continue, select **I accept the terms in the license agreement**.
 - c. Click **Next**.

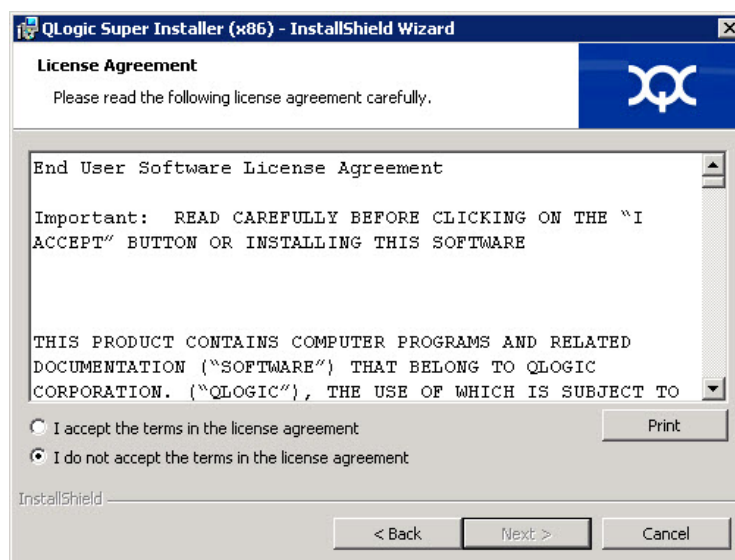

Figure 2-3. QLogic InstallShield Wizard: License Agreement Window

5. Complete the wizard's Setup Type window (Figure 2-4) as follows:
 - a. Select one of the following setup types:
 - Click **Complete** to install *all* program features.
 - Click **Custom** to manually select the features to be installed.
 - b. To continue, click **Next**.If you selected **Complete**, proceed directly to [Step 6 b](#).

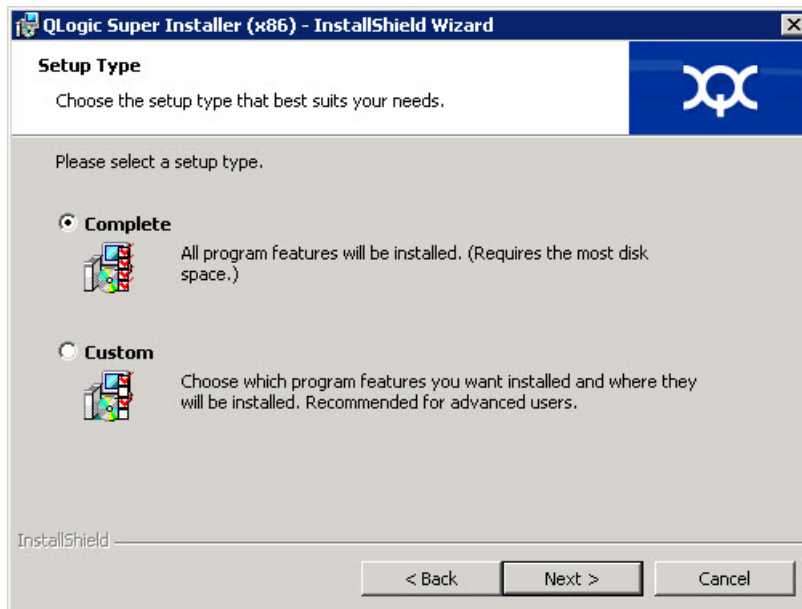

Figure 2-4. InstallShield Wizard: Setup Type Window

6. If you selected **Custom** in [Step 5](#), complete the Custom Setup window ([Figure 2-5 on page 9](#)) as follows:
 - a. Select the features to install. By default, all features are selected. To change a feature's install setting, click the icon next to it, and then select one of the following options:
 - **This feature will be installed on the local hard drive**—This setting marks the feature for installation without affecting any of its subfeatures.
 - **This feature, and all subfeatures, will be installed on the local hard drive**—This setting marks the feature and all of its subfeatures for installation.
 - **This feature will not be available**—This setting prevents the feature from being installed.

- b. Click **Next** to continue.

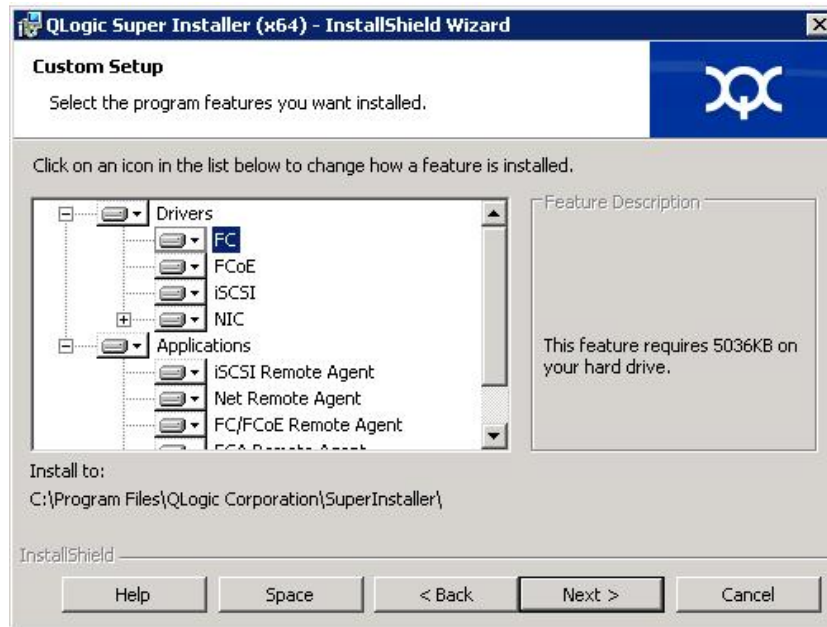

Figure 2-5. InstallShield Wizard: Custom Setup Window

- 7. In the InstallShield Wizard's Ready To Install window ([Figure 2-6](#)), click **Install**.

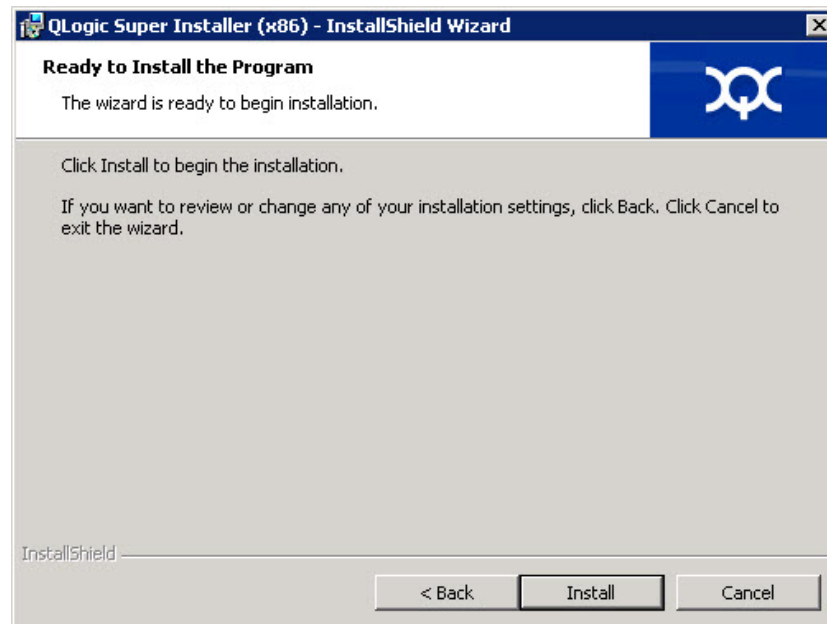

Figure 2-6. InstallShield Wizard: Ready to Install the Program Window

The InstallShield Wizard installs the QLogic Adapter drivers and Management Software Installer.

8. When the installation is complete, the InstallShield Wizard Completed window appears (Figure 2-7). Click **Finish** to dismiss the installer.



Figure 2-7. InstallShield Wizard: Completed Window

9. In the Dell Update Package (DUP) window (Figure 2-8), “Complete” indicates successful installation.
 - (Optional) To open the log file, click **View Log**. The log file shows the progress of the DUP installation, any previous installed versions, any error messages, and other information about the installation.
 - To close the Update Package window, click **OK**.



Figure 2-8. Dell Update Package Window

Running the Dell Update Package from the Command Line

For a list of the CLI options for systems running Windows, a description of each option, and the command syntax, refer to the *Dell Update Packages Version xx.xx.xxx User's Guide*, “Windows CLI Options” section.

Running the DUP from the command line, with no options specified, results in the same behavior as double-clicking the icon representing the DUP.

NOTE

The actual file name of the DUP varies.

To run the DUP from the command line:

```
C:\><DUP_file_name>.EXE
```

The following shows the syntax for specifying options to customize the Dell update package installation behavior:

```
<DUP_file_name>.exe [/<option1>[=<value1>]] [/<option2>[=<value2>]]...
```

To display the GUI for guided installation, update, or extraction, use no options.

Examples

To update the system silently:

```
<DUP_file_name>.exe /s
```

To extract the update contents to the C:\mydir\ directory:

```
<DUP_file_name>.exe /s /e=C:\mydir
```

To extract the driver components to the C:\mydir\ directory:

```
<DUP_file_name>.exe /s /drivers=C:\mydir
```

To install only the driver components:

```
<DUP_file_name>.exe /s /driveronly
```

To change from the default log location to C:\my path with spaces\log.txt:

```
<DUP_file_name>.exe /l="C:\my path with spaces\log.txt"
```

Linux Driver Installation and Configuration

This section provides the following procedures for installing drivers on a Linux system:

- [Installation Overview](#)
- [Installing the Linux Fibre Channel Driver](#)

Installation Overview

To install and configure the adapter drivers on a Linux system, refer to the driver release notes, readme, and installation instructions included in the package.

NOTE

To install the Red Hat Package Manager (RPM), issue the following command as a root user:

```
# rpm -Uvh <rpm name>
```

For example:

```
# rpm -Uvh qla2xxx-kmp-default-  
<driver-version_kernel-version>-<release>.x86_64.rpm
```

To uninstall the RPM, issue the following command as a root user:

```
# rpm -e <rpm>
```

For example:

```
# rpm -e qla2xxx-kmp-default-  
<driver-version_kernel-version>-<release>
```

Installing the Linux Fibre Channel Driver

This section provides procedures for installing the Linux Fibre Channel driver for the following operating systems:

- [Building the Driver for RHEL 7.x and 8.x](#)
- [Building the Driver for SLES 12 SP4 and SLES 15/15 SP 1](#)

Building the Driver for RHEL 7.x and 8.x

1. From the directory that contains the source driver file, `qla2xxx-src.vx.xx.xx.xx.x-k.tar.gz`, issue the appropriate commands.

```
# tar -xzvf qla2xxx-src-vx.xx.xx.xx.x-k.tar.gz
# cd qla2xxx-src-vx.xx.xx.xx.x-k
```

2. Build and install the driver modules from the source code by executing the `build.sh` script as follows:

```
# ./extras/build.sh install
```

The `build.sh` script does the following:

- ❑ Builds the driver `.ko` files.
- ❑ Copies the `.ko` files to the appropriate `/lib/modules/<kernel version>/extra/qlgc-qla2xxx` directory.
- ❑ Add the appropriate directive in the `modprobe.conf` (if applicable).

NOTE

You can optionally complete either or both [Step 3](#) and [Step 4](#) of this procedure.

3. (Optional) To manually load the driver, issue the `insmod` or `modprobe` command:

- ❑ To directly load the driver from the local build directory, issue the following `insmod` commands in order:

```
# modprobe scsi_tgt.ko (if not already loaded)
# modprobe scsi_transport_fc.ko
# insmod ./qla2xxx.ko
```

- ❑ To load the driver using `modprobe`, issue the following command:

```
# modprobe -v qla2xxx
```

- ❑ To unload the driver using `modprobe`, issue the following command:

```
# modprobe -r qla2xxx
```

4. (Optional) To automatically load the driver each time the system boots, rebuild the RAMDISK to include the driver as follows:
 - a. Create a backup copy of the RAMDISK image by issuing the following commands:

```
# cd /boot
# cp initramfs-[kernel version].img initramfs-[kernel version].img.bak
```
 - b. Create the new RAMDISK by issuing the following command:

```
# dracut -f
```
 - c. To load the driver, reboot the host.

Building the Driver for SLES 12 SP4 and SLES 15/15 SP 1

1. From the directory that contains the source driver file, `qla2xxx-src-vx.xx.xx.xx.xx.x-k.tar.gz`, issue the following commands:

```
# tar -xzvf qla2xxx-src-vx.xx.xx.xx.xx.x-k.tar.gz
# cd qla2xxx-src-vx.xx.xx.xx.xx.x-k
```

Where `x.xx.xx.xx.xx` is the applicable version number.

2. Build and install the driver modules from the source code by executing the `build.sh` script as follows:

```
# ./extras/build.sh install
```

The `build.sh` script does the following:

- Builds the driver `.ko` files.
- Copies the `.ko` files to the appropriate `/lib/modules/<kernel version>/updates` directory.
- Adds the appropriate directive in the `modprobe.conf` file (if applicable).

NOTE

You can optionally complete either or both [Step 3](#) and [Step 4](#) of this procedure.

3. (Optional) Manually load the driver for Linux.
 - ❑ Edit the `/etc/modprobe.d/unsupported_modules` file to make the following change:

```
allow_unsupported_modules 1 (replace 0 with 1)
```
 - ❑ To load the driver using `modprobe`, issue the following command:

```
# modprobe -v qla2xxx
```
 - ❑ To unload the driver using `modprobe`, issue the following command:

```
# modprobe -r qla2xxx
```
4. (Optional) To automatically load the driver each time the system boots, rebuild the RAM disk to include the driver as follows:
 - a. Create a backup copy of the RAMDISK image by issuing the following commands:

```
# cd /boot  
# cp initramfs-[kernel version].img initramfs-[kernel version].img.bak
```
 - b. Create the new RAMDISK by issuing the following command:

```
# dracut -f
```
5. To load the driver, reboot the host.

VMware Driver Installation and Configuration

This section provides the following procedures for installing drivers on a VMware system:

- [Installation Overview](#)
- [Installing the ESXi 6.7 U3 and 6.5 U3 Fibre Channel Driver](#)
- [Installing the QConvergeConsole VMware vCenter Server Plug-in](#)
- [Installing the QConvergeConsole VMware vSphere Web Client Plug-in](#)
- [Configuring VM-ID](#)

Installation Overview

To install and configure the adapter drivers on a VMware system, refer to the driver release notes and readme files included in the package.

Installing the ESXi 6.7 U3 and 6.5 U3 Fibre Channel Driver

The operating system manages and controls the driver installation process. To install the ESXi driver, follow the steps in this section.

NOTE

This section provides the most common ways of installing and upgrading the driver. For other installation procedures, consult the operating system manuals and the driver readme file.

This section provides procedures for the following:

- [“Updating an Existing Driver or Installing a New Driver for an Existing ESXi 6.7 U3 and 6.5 U3 Installation with esxcli” on page 16](#)
- [“Verifying the Version of the Installed Driver” on page 17](#)

Updating an Existing Driver or Installing a New Driver for an Existing ESXi 6.7 U3 and 6.5 U3 Installation with esxcli

To use the driver bundle <offline-bundle>.zip):

1. Copy the driver bundle (<offline-bundle>.zip) to this ESXi host.
2. Install the driver bundle (<offline-bundle>.zip) as follows:
 - a. To create a temporary directory, issue the following commands:

```
mkdir /install
cd /install
```
 - b. Unzip the driver bundle in the temporary directory:

```
/install : unzip <offline-bundle>.zip
```
 - c. Issue the following command:

```
esxcli software vib install -n qlnativefc -d /install
```

To use the driver VIB:

1. Copy the driver VIB to this ESXi host by issuing the following command:

```
qlnativefc-<driver-version>-1OEM.<esx-build>.x86_64.vib
```
2. Install the driver VIB using the following `esxcli` commands:
 - a. To make a temporary directory, issue the following commands:

```
mkdir /install
cd /install
```
 - b. Issue the following command:

```
esxcli software vib install -v /install/<driver-vib>
```

Verifying the Version of the Installed Driver

To verify the installed package in the system, issue the following command:

```
esxcli software vib list | grep qlnativefc
```

The driver version is embedded in the VIB version.

For example, the output looks like the following:

```
# esxcli software vib list | grep qlnativefc
qlnativefc                2.1.50.0-1OEM.600.0.0.2768847
QLogic VMwareCertified   2017-01-19
```

Installing the QConvergeConsole VMware vCenter Server Plug-in

The following installation sections apply to VI Server, Web Client, and HTML5 Client plug-ins.

It is advised to use HTML5 Plug-in for ESXi 6.5 and later.

To use QConvergeConsole VMware vCenter Server Plug-in, install the following software in this order:

1. **QConvergeConsole VMware vCenter Server Plug-in** on the vCenter Server
2. **QLogic Adapter CIM Provider** on the ESXi server

The following sections explain how to install and uninstall the required software:

- [Installation Package Contents](#)
- [Installing the QConvergeConsole VMware vCenter Server Plug-in](#)
- [Plug-in Unregistration from a Manual Install](#)
- [Uninstalling the QConvergeConsole VMware vCenter Server Plug-in](#)
- [Installing the QLogic Adapter CIM Provider](#)
- [Uninstalling the QLogic Adapter CIM Provider](#)

For information on installing the Plug-in, refer to “[Installing the QConvergeConsole VMware vCenter Server Plug-in](#)” on page 18.

Installation Package Contents

The latest version of the QLogic Adapter CIM Provider and QConvergeConsole VMware vCenter Server Plug-in package contains the files needed to install both the Plug-in and the CIM Provider. Required files include the following (where `x_x_x` is the version number):

- `QLogic_Adapter_VI_Plugin_x_x_x.exe`—This file is the QConvergeConsole VMware vCenter Server Plug-in installation package.
- `QLogic_Adapter_Web_Client_Plugin_<ver_num>.exe`—This file is the vSphere Web Client Plug-in installation package.
- `QLogic_Adapter_vSphere_Client_Plugin_<ver_num>.exe`— This file is the HTML5-based vSphere Client Plug-in installation package (for HTML5-based vSphere Client)
- `qlogic_adapter_provider_vmware_esx67-x.x.x`—This file contains the QLogic Adapter CIM Provider installation package for ESXi 6.7 U3, where `x.x.x` is the version of the CIM Provider.
- `qlogic_adapter_provider_vmware_esx65-x.x.x`—This file contains the QLogic Adapter CIM Provider installation package for ESXi 6.5 U3, where `x.x.x` is the version of the CIM Provider.
- `readme.txt`—This file is the Read Me document that covers hardware and software requirements, operating system support, supported features, installation and removal instructions, known issues and workarounds, and support contact information.
- `release_notes.txt`—This file is the Release Notes document that lists changes, fixes, known issues, and release details.

For detailed information on installing the QConvergeConsole VMware vCenter Server Plug-in, refer to [“Installing the QConvergeConsole VMware vCenter Server Plug-in” on page 18](#).

For detailed information on installing the CIM Provider, refer to [“Installing the QLogic Adapter CIM Provider” on page 24](#).

Installing the QConvergeConsole VMware vCenter Server Plug-in

To install the QConvergeConsole VMware vCenter Server Plug-in:

1. Download the `QLogic_Adapter_VI_Plugin_x_x_x.exe` file (where `x_x_x` is the version number).
2. Start the installation either by double-clicking the `.exe` file, by typing the name of the `.exe` file in a Run window, or by clicking **Browse** and locating the `.exe` file.

The InstallAnywhere wizard opens, as shown in [Figure 2-9](#).

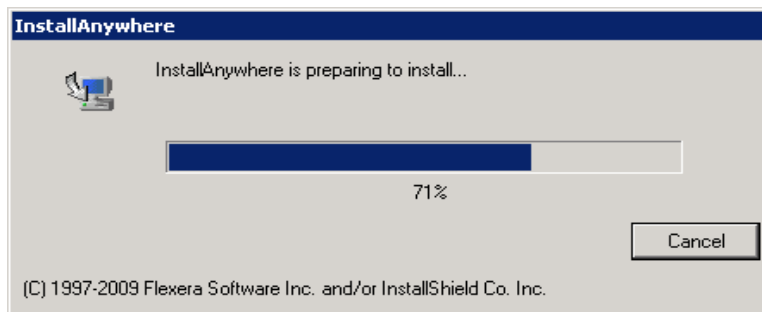

Figure 2-9. InstallAnywhere Initial Window

3. In the QLogic Adapter VI Plug-in wizard's Introduction window (see [Figure 2-10](#)), click **Next**.

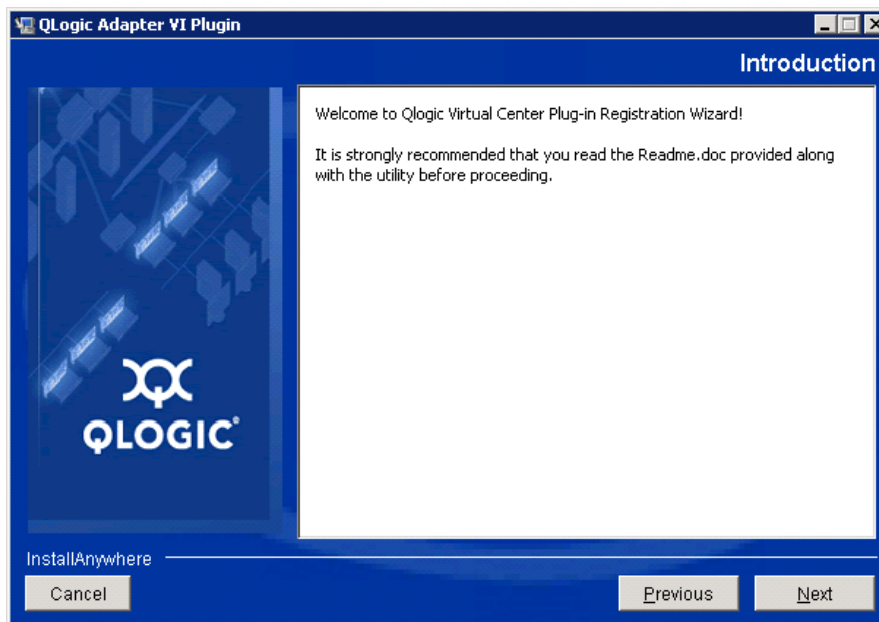

Figure 2-10. QLogic Adapter VI Plug-in Wizard: Introduction

Wait while the wizard configures the plug-in (see [Figure 2-11](#)).

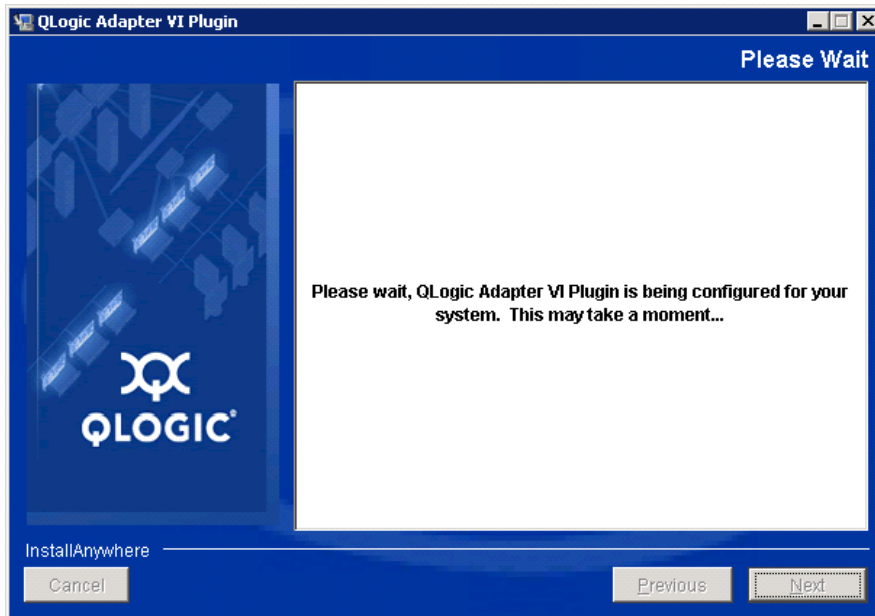

Figure 2-11. QLogic Adapter VI Plug-in Wizard: Configuring the Plug-in

4. Select the installation directory, and then click **Install** (see [Figure 2-12](#)).

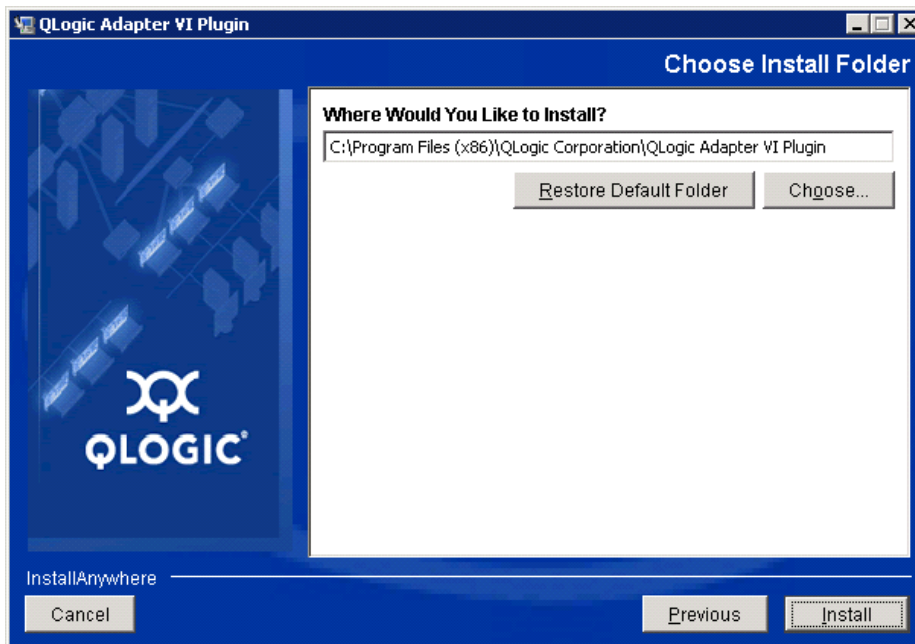

Figure 2-12. QLogic Adapter VI Plug-in Wizard: Choose Install Folder

Wait while the wizard performs the installation (see [Figure 2-13](#)).

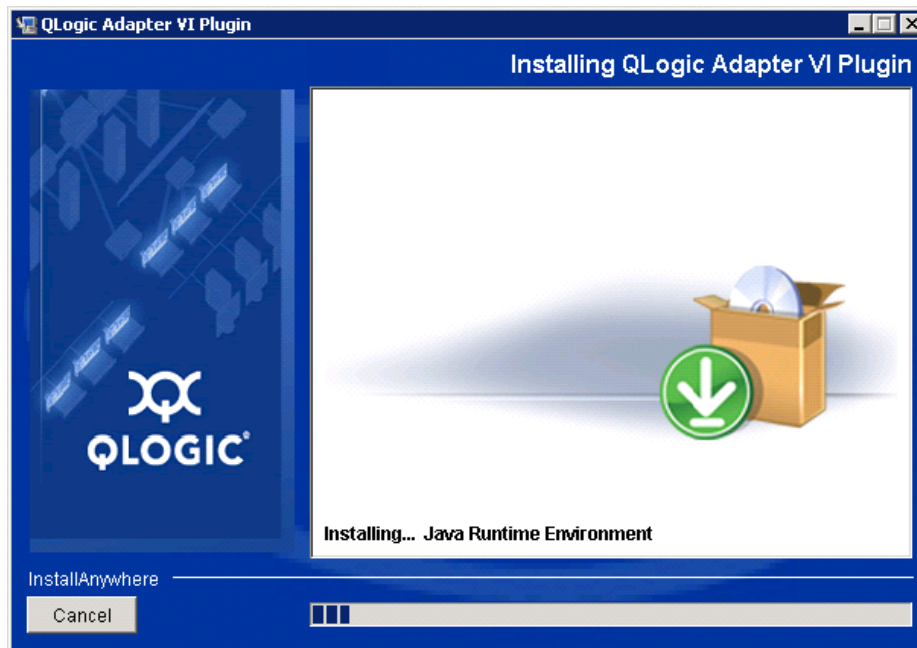

Figure 2-13. QLogic Adapter VI Plug-in Wizard: Installing the Plug-In

5. Type the requested information in the boxes, and then click **Next** (see [Figure 2-14](#)).

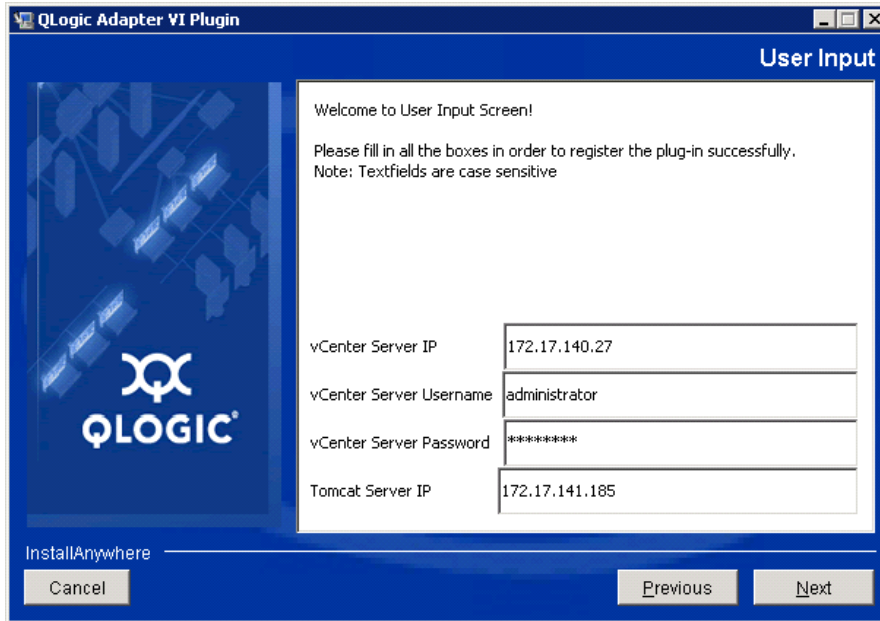

Figure 2-14. QLogic Adapter VI Plug-in Wizard: User Input

Wait while the wizard finishes configuring the plug-in (see [Figure 2-15](#)).

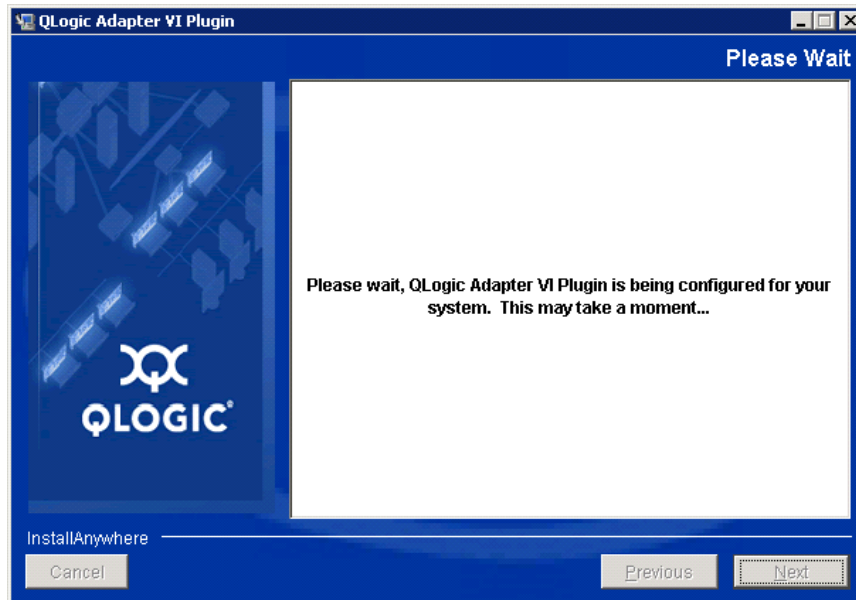

Figure 2-15. QLogic Adapter VI Plug-in Wizard: Configuration in Progress

6. When the Registration Result window (Figure 2-16) appears, click **Finish** to exit.

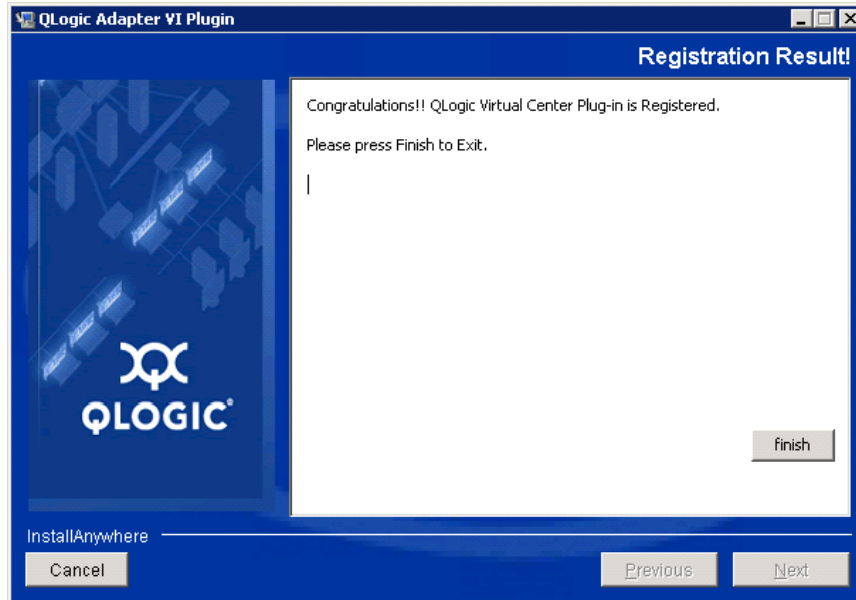

Figure 2-16. QLogic Adapter VI Plug-in Wizard: Registration Result

7. After the installation completes, restart the Tomcat™ service as follows:
 - If the plug-in is installed on the VMware vCenter Server, restart the VMware Virtual Center Management Web services.
 - If the plug-in is installed on a server other than the vCenter Server, restart the Apache Tomcat service.

Plug-in Unregistration from a Manual Install

If you have performed a manual install of the QConvergeConsole VMware vCenter Server Plug-in, you must perform a manual uninstall before running the plug-in Installation Wizard.

VMware provides two types of scripts for plug-in registration (and unregistration):

- For PowerShell scripting:
<http://communities.vmware.com/docs/DOC-4521>
- For Perl®:
<http://communities.vmware.com/docs/DOC-4530>

Before you can use the script, you must download the appropriate VI SDK from VMware:

- For Perl VI SDK, download vSphere SDK for Perl:
<http://www.vmware.com/support/developer/viperltoolkit/>
- For PowerShell, download vSphere PowerCLI:
<http://communities.vmware.com/community/vmtn/vsphere/automationtools/powercli>

After downloading and installing the SDK and the registration script, follow the VMware instructions to unregister the plug-in. For example, the Perl unregister command is:

```
perl registerPlugin.pl --server="127.0.0.1"  
-username="administrator" --password="password"  
--key="com.qlogic.QLogicAdapterVIPlugIn" --action="remove"
```

To log into the vCenter Server, replace `server's` IP address, `administrator` and `password` with the correct information.

Uninstalling the QConvergeConsole VMware vCenter Server Plug-in

To remove the QConvergeConsole VMware vCenter Server Plug-in:

1. In the Windows Control Panel, select **Programs and Features**.
2. In the Add or Remove Programs dialog box, select the QConvergeConsole VMware vCenter Server Plug-in, and then click **Change/Remove**.
3. To remove the plug-in, follow the instructions in the QConvergeConsole VMware vCenter Server Plug-in installer.

Installing the QLogic Adapter CIM Provider

This section describes how to install, start, and remove the QLogic Adapter CIM Provider for VMware ESXi. Because there are multiple zip packages, ensure that you pick the zip package that matches your environment: ESXi 6.7 U3 and 6.5 U3.

NOTE

The QLogic Adapter CIM Provider for VMware ESXi was generated as a VIB file. A VIB contains the complete set of files and binaries required to install the provider on VMware ESXi. The file `offline-bundle.zip` contains the VIB and the necessary metadata to install the provider on VMware ESXi.

Initial Installation Methods

Initial installation methods for the CIM Provider include the following:

- **Online.** Refer to “[Installing the CIM Provider on an ESXi 6.7 U3 or 6.5 U3 Host](#)” on page 25.
- **Offline.** Refer to “[Existing ESXi Installation Using VMware Update Manager](#)” on page 25.
- **Remote.** Refer to “[Remote Installation of the CIM Provider on an ESXi Host](#)” on page 26.

Installing the CIM Provider on an ESXi 6.7 U3 or 6.5 U3 Host

1. For an ESXi 6.5/6.7 host, do the following; otherwise proceed to [Step 2](#).
 - a. Turn off the firewall on the ESXi 6.5/ESXi 6.7 host by issuing the following command:

```
# esxcli network firewall set --enabled false
```
 - b. Reboot the ESXi 6.5/6.7 host.
 - c. On some platforms, FC adapters are not discovered from ESXi 6.7 through vCenter. If this happens, restart the CIMON by issuing the following commands:

```
# /etc/init.d/sfcbd-watchdog stop  
# /etc/init.d/sfcbd-watchdog restart
```
2. Copy the following file to the root directory (/) of the ESXi system:

```
QLGC-ESX-5.5.0-qlogic-adapter-provider-x.x.xx.xxxxxxx-  
offline_bundle-xxxxxxx.zip
```

This CIM provider is applicable for ESXi versions 6.x and later.

3. Issue the `esxcli` commands as follows:

```
# cd /  
# esxcli software acceptance set --level=CommunitySupported  
# esxcli software vib install -d  
file://<offline bundle>.zip --maintenance-mode
```
4. Reboot the system as required.

Existing ESXi Installation Using VMware Update Manager

An existing ESXi host has asynchronous drivers installed using VMware Update Manager (VUM). For more information, see “Using vSphere ESXi Image Builder CLI” in the *vSphere Installation and Setup Guide* at:

<http://www.vmware.com/support/pubs/vsphere-esxi-vcenter-server-pubs.html>

To install the asynchronous drivers:

1. Extract the contents of the asynchronous driver zip file.
2. Identify the `offline-bundle.zip` file or files.
3. From vCenter Server, go to **Home**, and then select **Update Manager**.
4. Click the **Patch Repository** tab.
5. Click the **Import Patches** link at the top right of the window.
6. Click **Finish**.

The asynchronous driver is now added to the patch repository.

7. Create a baseline and remediate the ESXi host. For more information, refer to *Installing and Administering VMware vSphere Update Manager*:

http://www.vmware.com/support/pubs/vum_pubs.html.

Remote Installation of the CIM Provider on an ESXi Host

NOTE

Before performing this procedure, ensure that the remote ESXi system is in Maintenance Mode. To do so using vSphere Client, select **Inventory**, select **Host**, and then select **Enter Maintenance Mode**.

1. Copy the `offline-bundle.zip` file to any location on the host where either the vSphere CLI package is installed or vSphere Management Assistant (vMA) is hosted.
2. Navigate to the location of the `offline-bundle.zip` file.
3. To install the offline bundle, issue the `vihostupdate` command as follows:

```
# vihostupdate.pl <conn_options> --install --bundle  
offline-bundle.zip --nosigcheck
```

4. Follow the on-screen instructions to complete the installation. You might need to reboot the ESXi system.

NOTE

For more details on the `vihostupdate` command, see the *vSphere Command-Line Interface Installation and Reference Guide* at:

http://www.vmware.com/pdf/vsphere4/r40/vsp_40_vcli.pdf

Subsequent Update Installation

To update the QLogic Adapter CIM Provider after a prior VIB installation, follow the instructions in [“Uninstalling the QLogic Adapter CIM Provider” on page 27](#) to remove the existing VIB. After completing the VIB removal, use the same steps in [“Initial Installation Methods” on page 25](#) to install the new VIB.

Starting the QLogic Adapter CIM Provider

After a system startup, the SFCB (Small-Footprint CIM Broker) CIMOM (CIM object manager) in the ESXi system should start automatically and load the QLogic Adapter CIM Provider, when necessary.

If the CIM Provider does not start automatically, you can manually stop, start, or restart the SFCB CIMOM by issuing the following commands.

- To stop the SFCB CIMOM and the QLogic Adapter CIM Provider:

```
# /etc/init.d/sfcbd-watchdog stop
```
- To start the SFCB CIMOM and the QLogic Adapter CIM Provider:

```
# /etc/init.d/sfcbd-watchdog start
```
- To restart the SFCB CIMOM and the QLogic Adapter CIM Provider:

```
# /etc/init.d/sfcbd-watchdog restart
```

After starting the SFCB CIMOM, use a CIM client utility to query the QLogic Adapter CIM Provider for information.

Uninstalling the QLogic Adapter CIM Provider

You can uninstall the QLogic Adapter CIM Provider for your version of VMware. For information about removing the QLogic Adapter CIM Provider through a remote host, see the *QLogic Adapter CIM Provider and vCenter Plug-in for VMware ESX/ESXi Readme* file.

To uninstall the CIM Provider from an ESXi 5.x or 6.x host:

1. To view the VIB list, issue the following command:

```
# esxcli software vib list
```
2. To remove the QLogic Adapter CIM Provider, issue the following command:

```
# esxcli software vib remove --vibname viplugin-cimprovider  
--maintenance-mode -f
```

To uninstall the CIM Provider from a remote host:

NOTE

Before performing this procedure, make sure that the ESXi system is in Maintenance Mode. To do so using the vSphere Client, select **Inventory**, select **Host**, and then select **Enter Maintenance Mode**.

1. From a console on the host where the vSphere CLI package is installed or vMA is hosted, query and find the Bulletin ID of the existing provider:

```
# vihostupdate.pl <conn_options> --query
```

2. Remove the existing VIB by issuing the following command:

```
# vihostupdate.pl <conn_options> --remove --bulletin  
<bulletinID>
```

NOTE

For more details on `vihostupdate`, see the *vSphere Command-Line Interface Installation and Reference Guide*, located here:

http://www.vmware.com/pdf/vsphere4/r40/vsp_40_vcli.pdf

Installing the QConvergeConsole VMware vSphere Web Client Plug-in

This section includes the following information:

- [Before You Begin](#)
- [Installing QConvergeConsole VMware vSphere Web Client Plug-in](#)
- [Uninstalling the QConvergeConsole VMware vSphere Web Client Plug-in](#)

Before You Begin

It is advised to use this Plug-in for ESXi 6.5 and later.

Gather the information necessary for the installation, including:

- IP address of the vCenter Server
- vCenter Server credentials (user name and password)
- Where to host the QConvergeConsole VMware vSphere Web Client Plug-in (on vCenter Server or other server)

If you are hosting the QConvergeConsole VMware vSphere Web Client Plug-in on a non-vCenter Server, make sure the server has Tomcat running as a service and have the IP address of the Tomcat instance ready. Also, make sure the Tomcat `CATALINA_HOME` environment variable is set to the appropriate directory.

Installing QConvergeConsole VMware vSphere Web Client Plug-in

1. Run the installer on the server providing the Tomcat service. Enter the information requested by the installer.
 - On Windows, double-click the installer and follow the instructions on the GUI provided.
 - On Linux:
 - a. Make sure the user is the root user (or has root privileges).
 - b. Create the installer executable if one does not already exist. Choose the installer for your system (32-bit or 64-bit), and then issue the following command:

```
chmod +x <installer>
```

Where `<installer>` is the file name of the installer.
 - c. Run the installer by issuing the following command:

```
./<installer>
```

Where `<installer>` is the file name of the installer.
 - d. Follow the instructions provided by the installer.

2. Restart the Tomcat service.

If the QConvergeConsole VMware vSphere Web Client Plug-in is being hosted on the vCenter Server, you must restart the VMware Virtual Center Management Web services:

- In Windows, go to the **Administrative Tools** menu, select **Services**, and then restart VMware Virtual Center Management Web services.
- On the vCenter Server Appliance (Linux), issue the following command:

```
/etc/init.d/vmware-vpxd tomcat-restart
```

3. Restart any vSphere Web Client sessions.

If you are updating a previous version of the QConvergeConsole VMware vSphere Web Client Plug-in, restart the vSphere Web Client services as follows:

- In Windows, go to the **Administrative Tools** menu, select **Services**, and then restart VMware vSphere Web Client.
- On the vCenter Server Appliance (Linux), issue the following command:

```
/etc/init.d/vsphere-client restart
```

Uninstalling the QConvergeConsole VMware vSphere Web Client Plug-in

To uninstall the QConvergeConsole VMware vSphere Web Client Plug-in, refer to the procedure for Windows or Linux:

- **Windows.** Uninstall the QConvergeConsole VMware vSphere Web Client Plug-in on Windows using the Windows Control Panel Uninstall Program window. Follow the uninstaller user interface to remove the plug-in.
- **Linux.** Uninstall the QConvergeConsole VMware vSphere Web Client Plug-in on Linux by issuing the following command at a command prompt:

```
/opt/qlogic/QLogic\ Adapter\ Web\ Client\  
Plugin/Uninstall_QLogic\ Adapter\ Web\ Client\  
Plugin/Uninstall\ QLogic\ Adapter\ Web\ Client\ Plugin
```

Follow the prompts (user interface or console commands) to uninstall the plug-in by the root user.

Configuring VM-ID

VM storage I/O activity automatically generates VM-ID tagging in FC frames. VM-ID tags I/O frames with an ID that identifies the virtual machine that sent or received them. This ID allows management applications to monitor traffic flows down to the virtual machine level. VM-ID is disabled by default and requires a switch running FOS version 8.1.0a or later on Brocade switches. For detailed VM-ID information, see the documentation for your switch.

- To enable VM-ID (and disable QoS), issue the following command and then reboot the system:

```
$ esxcfg-module -s "ql2xvmidsupport=1,  
ql2xfabricpriorityqos=0" qlnativefc
```

- To disable VM-ID, issue the following command, and then reboot the system:

```
$ esxcfg-module -s "ql2xvmidsupport=0" qlnativefc
```

For details about configuring VM-ID, see the *User's Guide: QLogic Fibre Channel and Converged Network Adapters for VMware ESXi 5.5 and 6.x* (SN0154529-00).

3 Fibre Channel Configuration

This chapter provides the following information about configuring Fibre Channel:

- [“Updating the Dell Firmware” on page 32](#)
- [“Using Fast!UTIL for Custom Configuration” on page 36](#)
- [“Setting Fibre Channel Adapter Parameters” on page 43](#)
- [“Configuring Target Persistent Binding” on page 44](#)
- [“Configuring Boot Devices” on page 46](#)
- [“Configuring Virtual Ports \(NPIV\)” on page 47](#)
- [“Configuring Fibre Channel Driver Parameters” on page 53](#)
- [“Configuring Selective LUNs” on page 55](#)
- [“Configuring OoOFR” on page 55](#)
- [“Configuring the UEFI Driver” on page 56](#)
- [“Setting Queue Depth” on page 63](#)
- [“Setting an FA-PWWN” on page 65](#)
- [“Configuring and Verifying FA-BLD” on page 71](#)
- [“Using a Fabric-Assigned Boot LUN” on page 77](#)
- [“Running Diagnostics—Fibre Channel Ping and Trace Route” on page 79](#)
- [“Configuring CS_CTL QoS” on page 84](#)
- [“Configuring End-to-End CS_CTL QoS” on page 87](#)
- [“Configuring FDMI” on page 93](#)
- [“Enabling QLogic Forward Error Correction” on page 98](#)
- [“Running Extended Link Service Commands” on page 100](#)

NOTE

For information on configuring the Fibre Channel Adapter using VMware vCenter Server, refer to the *User's Guide—QConvergeConsole Plug-ins for VMware vSphere* (part number SN0054677-00), available at: www.marvell.com.

Updating the Dell Firmware

The firmware Dell Update Package (DUP) is a Flash update utility only; it is not used for adapter configuration. To run the firmware DUP, double-click the executable file. Alternatively, run the firmware DUP from the command line, which supports several command line options.

NOTE

If you update the firmware using the DUP with the Integrated Dell Remote Access Controller (iDRAC) or Lifecycle Controller (LC), it shows FFV as the QLogic Fibre Channel adapter MBI version. This issue occurs only the first time that you run the firmware DUP; following a reboot, FFV will be shown correctly on subsequent firmware updates with the DUP.

Running the Firmware Update by Double-Clicking

For additional information, refer to the *Dell Update Packages Version xx.xx.xxx User's Guide*, “Using Dell Update Packages” section.

To run the firmware DUP by double-clicking the executable file:

1. Double-click the icon representing the firmware DUP file.

2. When the DUP splash screen appears (Figure 3-1), click **Install** to continue.

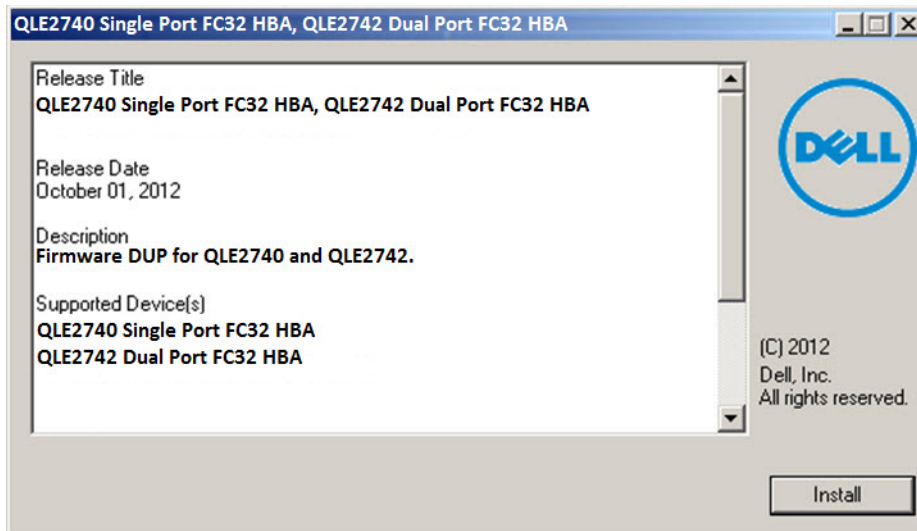

Figure 3-1. Dell Update Package Splash Screen

3. Follow the installer instructions. If a warning message appears (Figure 3-2), click **Yes** to continue the installation.

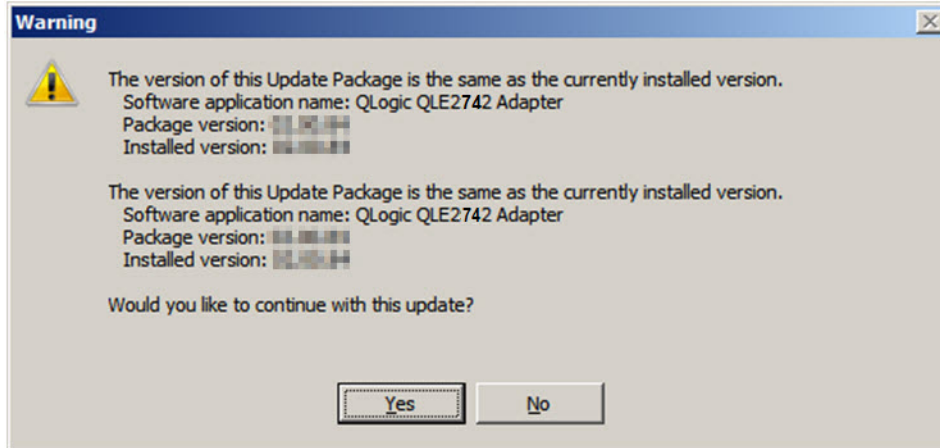

Figure 3-2. Continue Dell Update Package Installation

The installer indicates that it is loading the new firmware (Figure 3-3).

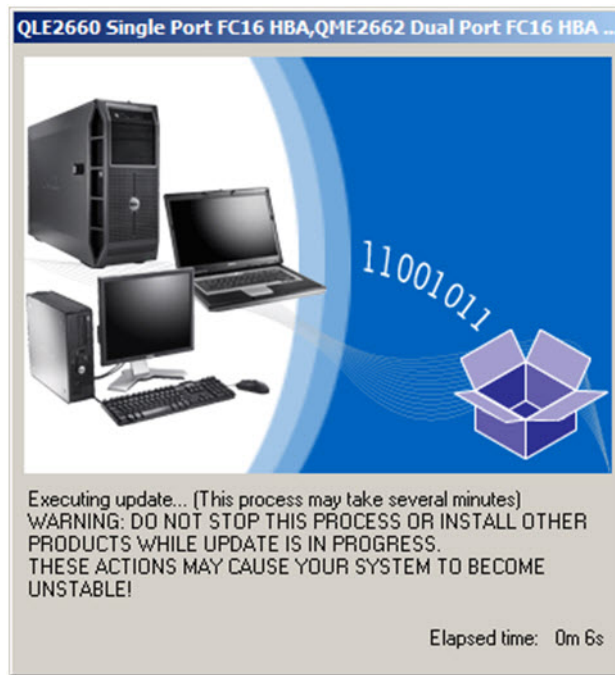

Figure 3-3. Loading New Firmware

4. When complete, the installer indicates the result of the installation (Figure 3-4). Click **Yes** to elect to reboot.

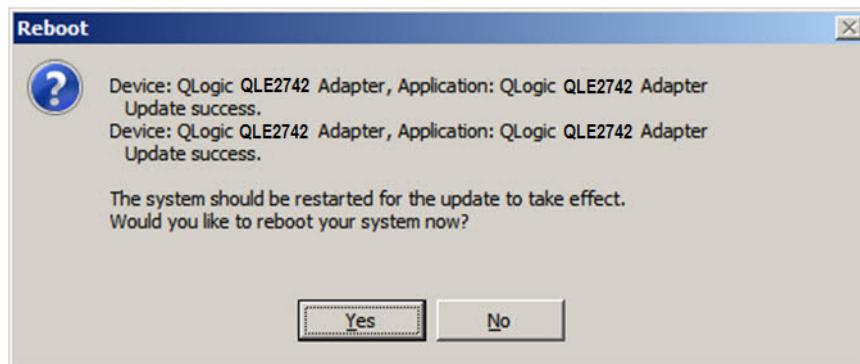

Figure 3-4. Result of Installation

5. To complete the installation, click **Finish** (Figure 3-5).

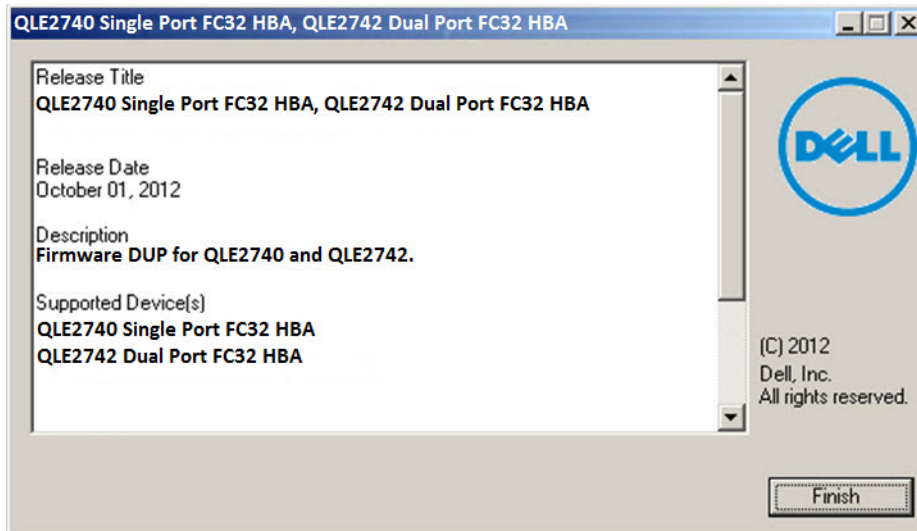

Figure 3-5. Finish Installation

Running the Firmware Update from the Command Line

Running the firmware DUP from the command line, with no options specified, results in the same behavior as double-clicking the icon representing the DUP. Note that the actual file name of the DUP will vary.

```
<adapter>_Firmware_<release>_<OS>_<version>.EXE
```

Figure 3-6 shows the options you can use to customize the DUP installation behavior.

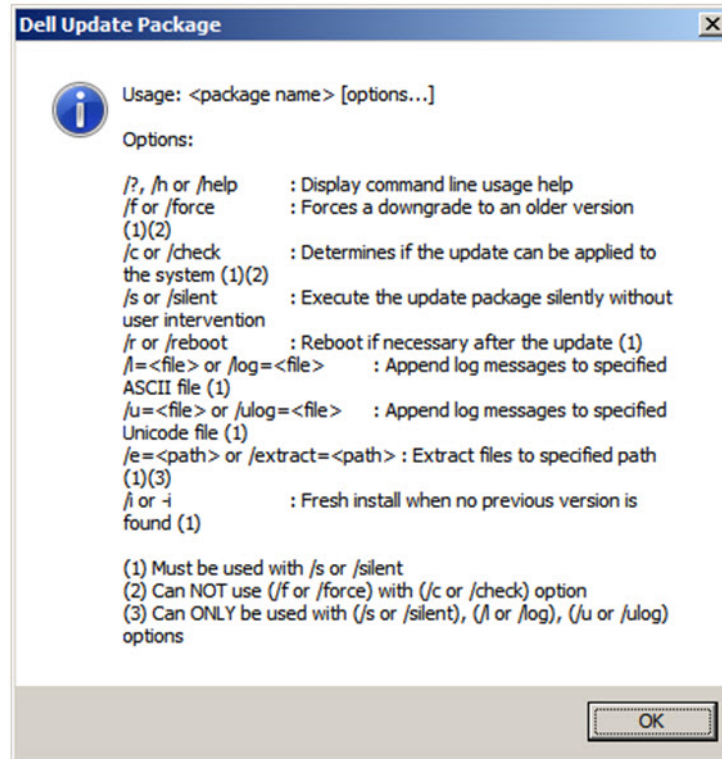

Figure 3-6. Command Line Options

Using *Fast!UTIL* for Custom Configuration

This section provides detailed configuration information for advanced users who want to customize the configuration of the adapters and connected devices using *Fast!UTIL* (the QLogic Fibre Channel Adapter BIOS utility) in a pre-OS environment.

To configure adapters using *Fast!UTIL*:

1. During the Host Bus Adapter BIOS initialization, press ALT+Q or CTRL+Q. It may take a few seconds for the *Fast!UTIL* menu to appear.
2. When the Select Host Adapter window appears, select the adapter type.
3. In the Adapter Settings window (see [“Adapter Settings” on page 37](#)), configure the adapter settings.

4. A message indicates that the configuration settings have been modified. Select **Save changes**.
5. To load the new parameters, reboot the system.

CAUTION

If the configuration settings are incorrect, your 2700 Series Adapter may not function properly.

The **Fast!UTIL Options** menu provides the following options:

- [Configuration Settings](#)
- [Scan Fibre Devices](#)
- [Fibre Disk Utility](#)
- [Loopback Data Test](#)
- [Select Adapter](#)
- [Exit Fast!UTIL](#)

Configuration Settings

The following sections show and describe the 2700 Series Adapters **Configuration Settings** menu options in *Fast!UTIL*:

- [Adapter Settings](#)
- [Selectable Boot Settings](#)
- [Restore Default Settings](#)
- [Raw NVRAM Data](#)
- [Advanced Adapter Settings](#)

Adapter Settings

[Table 3-1](#) describes the adapter settings.

Table 3-1. Adapter Settings

Setting	Values	Default	Description
Host Bus Adapter BIOS	Enabled, Disabled	Disabled	Disabling this setting disables the ROM BIOS on the 2700 Series Adapter, which frees space in upper memory. If you are booting from a Fibre Channel disk drive attached to the 2700 Series Adapter, you must enable this setting. See “Selectable Boot Settings” on page 39 for details on specifying the boot device.

Table 3-1. Adapter Settings (Continued)

Setting	Values	Default	Description
Frame Size	512, 1024, 2048	2048	This setting specifies the maximum frame length supported by the 2700 Series Adapter.
Loop Reset Delay	0–60 seconds	5 seconds	After resetting the loop, the firmware refrains from initiating any loop activity for the number of seconds specified in this setting.
Adapter Hard Loop ID	Enabled, Disabled	Disabled	If the Adapter Hard Loop ID setting is enabled, the adapter attempts to use the ID specified in the Hard Loop ID setting.
Hard Loop ID	0–125	0	If the Adapter Hard Loop ID setting is enabled, the adapter attempts to use the ID specified in this setting.
Connection Options	0, 1, 2	2	This setting defines the type of connection: <ul style="list-style-type: none"> ■ 0—loop only (for the 8Gb data rate) ■ 1—point-to-point only (for the 8Gb, 16Gb, and 32Gb data rate) ■ 2—loop preferred, then point-to-point (for the 8Gb and 16Gb data rate)
Fibre Channel Tape Support	Enabled, Disabled	Enabled	This setting enables FCP-2 recovery.
Data Rate	2, 4, 5, 6	2	This setting determines the data rate: <ul style="list-style-type: none"> ■ 2—The adapter auto-negotiates and determines the data rate. ■ 4—The adapter runs at 8GFC^a. ■ 5—The adapter runs at 16GFC¹. Loop mode is not supported. ■ 6—The adapter runs at 32GFC.

^a QME2742-DEL does not support 8GFC or 16GFC data rates.

Selectable Boot Settings

The **Configuration Settings** menu provides access to the **Selectable Boot Settings** options. If you enable the Host Bus Adapter BIOS in the adapter settings, you can select the boot device, as shown in [Table 3-2](#).

Table 3-2. Selectable Boot Settings

Enable Selectable Boot	Boot WWPN/LUN	Device Boot
No	—	The BIOS configures the first disk drive it finds as the boot device.
Yes	None specified	The BIOS configures the first disk drive it finds that is also LUN 0 as the boot device.
Yes	Specified	The BIOS scans through the specified boot worldwide port name (WWPN) and LUN list until it finds a disk drive. This drive is configured as the boot device.

The **Selectable Boot Settings** option allows you to specify up to four WWPNs or LUNs as boot devices.

To enable the Selectable Boot option and insert devices into boot device locations:

1. On the **Configuration Settings** menu, select **Host Adapter Settings**.
2. Enable the **Host Bus Adapter BIOS** and then press the ESC key to return to the **Configuration Settings** menu.
3. On the **Configuration Settings** menu, select **Selectable Boot Settings**.
4. To enable or disable (toggle) the **Selectable Boot** option, press the ENTER key. To move to the Primary location of the **Selectable Boot List** menu, press the DOWN ARROW key.
5. To see a list of accessible devices (in the Select Fibre Channel Device menu), press ENTER.
6. Select a drive by pressing the UP ARROW and DOWN ARROW keys or the PAGE UP and PAGE DOWN keys to scroll to the device that you want to put into your **Selectable Boot** menu list. Then press ENTER to select the requested device and load it into the **Selectable Boot** menu list.
7. To specify an alternate boot device on the 2700 Series Adapter, use the arrow keys to move to the next available alternate entry, press ENTER, select the disk drive you want, and press ENTER again. You can specify up to three alternate boot devices in this way.

NOTE

System BIOS compatibility: To boot from a QLogic host 2700 Series Adapter in a computer system with a multiboot system BIOS, the 2700 Series Adapter must be included in the list of bootable devices in the system's **Boot** menu.

Restore Default Settings

The **Restore Defaults** option restores the BIOS settings back to default.

Raw NVRAM Data

The **Raw NVRAM Data** option displays the 2700 Series Adapter's NVRAM contents in hexadecimal format. This option is a QLogic troubleshooting tool; you cannot modify the raw NVRAM data.

Advanced Adapter Settings

On the **Configuration Settings** menu in *Fast!UTIL*, select **Advanced Adapter Settings**. [Table 3-3](#) describes the default settings for the 2700 Series Adapters.

Table 3-3. Advanced Adapter Settings

Setting	Values	Default	Description
LUNs per Target	0, 8, 16, 32, 64, 128, 256	128	This setting specifies the number of LUNs supported per target if the target does not support the Report LUN command. Multiple LUN support is typically for redundant array of independent disks (RAID) boxes that use LUNs to map drives.
Enable LIP Reset ^a	Yes, No	No	This setting determines the type of loop initialization process (LIP) reset used when the OS initiates a bus reset routine as follows: <ul style="list-style-type: none"> ■ Yes = The driver initiates a global LIP reset to reset the target devices. ■ No = The driver initiates a global LIP reset with full login.
Enable LIP Full Login ^a	Yes, No	Yes	When this setting is Yes, the 2700 Series Adapter's reduced instruction set computer (RISC) controller logs in to all ports after any LIP.
Enable Target Reset	Yes, No	Yes	When this setting is Yes, the drivers issue a Target Reset command to all devices on the loop when a SCSI Bus Reset command is issued.
Login Retry Count	0–255	8	This setting specifies the number of times the software tries to log in to a device.

Table 3-3. Advanced Adapter Settings (Continued)

Setting	Values	Default	Description
Port Down Retry Count	0–255 seconds	30 seconds	This setting specifies the number of seconds the software waits before resending a command to a port whose status indicates that the port is down.
Link Down Timeout	0–255 seconds	30 seconds	This setting specifies the number of seconds the software waits for a link that is down to come up.
Operation Mode	0, 5, 6	6	This setting specifies the reduced interrupt operation (RIO) modes if they are supported by the software driver. The RIO modes allow posting multiple command completions in a single interrupt. This setting supports the following modes: <ul style="list-style-type: none"> ■ 0—Interrupt for every I/O completion ■ 5—Interrupt when the interrupt delay timer expires ■ 6—Interrupt when the interrupt delay timer expires or no active I/Os
Interrupt Delay Timer	0–255 (100µs units)	2 (200µs)	This setting contains the value used by a timer to set the wait time before generating an interrupt.
Enable Interrupt	Yes, No	No	This setting enables or disables the interrupt: <ul style="list-style-type: none"> ■ Yes—This setting enables the BIOS to use the interrupt request (IRQ) assigned to the 2700 Series Adapter. ■ No—The BIOS polls for the 2700 Series Adapter's RISC controller mailbox command completion status.

^a Loop support is available only at port speeds up to 16GFC. At 32GFC, loop is not supported.

Scan Fibre Devices

The **Scan Fibre Devices** option scans the Fibre Channel loop and lists all the connected devices by loop ID. It lists information about each device; for example, vendor name, product name, and revision. This information helps when configuring your 2700 Series Adapter and attached devices.

Fibre Disk Utility

The **Fibre Disk Utility** option scans the Fibre Channel loop and lists all the connected devices by loop ID. You can select a Fibre Channel hard disk and do one of the following tasks:

- Perform a low-level format
- Verify the disk media

- Verify the disk data (Some targets do not support this feature.)
- Select a disk device

CAUTION

Performing a low-level format destroys all data on the disk.

Loopback Data Test

The **Loopback Data Test** option allows you to perform the following loopback tests:

- External loopback data test
- Internal loopback data test

NOTE

When running an external loopback data test, make sure that the Fibre Channel link is up or a loopback plug is attached to the 2700 Series Adapter before starting the test.

Select Adapter

If you have a multiport or multiple 2700 Series Adapters in the system, use the **Select Adapter** option to select and then configure or view the settings of a specific 2700 Series Adapter or one of its ports.

Exit *Fast!UTIL*

The **Exit *Fast!UTIL*** option allows you to exit the utility and reboot the system. After making changes to the 2700 Series Adapter in *Fast!UTIL*, make sure you save the changes before you reboot the system.

Setting Fibre Channel Adapter Parameters

Use QConvergeConsole to set Fibre Channel adapter parameters:

- [Setting Fibre Channel Adapter Parameters with QConvergeConsole GUI](#)
- [Setting Fibre Channel Adapter Parameters with Interactive QConvergeConsole CLI](#)
- [Setting Fibre Channel Adapter Parameters with Noninteractive QConvergeConsole CLI](#)

NOTE

The QLE2742 32Gbps FC HBA does not link up with the **Auto** setting when it is connected to a Dell EMC S4148U-ON switch.

Setting Fibre Channel Adapter Parameters with QConvergeConsole GUI

For information about how to set Fibre Channel adapter parameters using QConvergeConsole GUI, refer to the topic about managing Fibre Channel and Fibre Channel over Ethernet (FCoE) adapter ports in the *QConvergeConsole Help*.

Setting Fibre Channel Adapter Parameters with Interactive QConvergeConsole CLI

To set Fibre Channel adapter parameters with interactive QConvergeConsole CLI:

1. On the **Fibre Channel Adapter Configuration** menu, select **HBA Parameters**.
2. On the port menu, select a port to open the **HBA Parameters** menu.
3. On the **HBA Parameters** menu, select the **Configure HBA Parameters** option to open the **Configure Parameters** menu.

For more information, refer to the section about the Fibre Channel interactive commands in the *User's Guide—QConvergeConsole CLI* (part number SN0054667-00).

Setting Fibre Channel Adapter Parameters with Noninteractive QConvergeConsole CLI

For information about how to set Fibre Channel adapter parameters using the noninteractive mode of QConvergeConsole CLI, refer to the section about the Fibre Channel noninteractive commands in the *User's Guide—QConvergeConsole CLI* (part number SN0054667-00).

Configuring Target Persistent Binding

NOTE

Target persistent binding is supported only on Windows.

Use QConvergeConsole to configure target persistent binding:

- [Configuring Persistent Binding with QConvergeConsole GUI](#)
- [Configuring Persistent Binding with Interactive QConvergeConsole CLI](#)
- [Configuring Persistent Binding with Noninteractive QConvergeConsole CLI](#)

Configuring Persistent Binding with QConvergeConsole GUI

To bind target devices attached to an adapter port using QConvergeConsole GUI:

1. In the system tree, expand a Fibre Channel node.
2. In the system tree for a 2700 Series Adapter, select the physical port number.
3. Click the **Targets** tab, and then click the **Target Persistent Binding** tab.
4. Choose the binding options:
 - Select the **Bind All** check box to bind all the devices listed to adapter ports.
 - Select the **Bind** check box if you want to configure a specific port and bind it to the target ID that you have selected from the **Target ID** list. If you do not want to configure the port, clear the check box. If you clear the check box, the corresponding port is unconfigured.
5. To save the configuration changes, click **Save**.
6. If the Security Check dialog box appears, type the password in the **Enter Password** box, and then click **OK**.
7. The system overwrites any previously saved configuration for the current adapter and displays a message box. Click **OK** to close the message box.

For more information, refer to the topic about binding target devices in the *QConvergeConsole Help*.

Configuring Persistent Binding with Interactive QConvergeConsole CLI

To bind a target using interactive QConvergeConsole CLI:

1. On the **Fibre Channel Adapter Configuration** menu, select **Target Persistent Bindings**.
2. On the port menu, select a port and then select **Bind Target(s)** to bind a target to a port.
3. Select a target and specify a target ID to open the **Target Persistent Binding – FC Port Configuration** menu with options to select more targets, save changes, or cancel the binding operation.

For more information, refer to the section about Fibre Channel interactive commands in the *User's Guide—QConvergeConsole CLI* (part number SN0054667-00).

Configuring Persistent Binding with Noninteractive QConvergeConsole CLI

To bind a selected target to a specific adapter using the noninteractive mode of QConvergeConsole CLI, issue the following command:

```
# qauccli -pr fc -p (<hba instance> | <hba wwpn>) (<target wwnn>  
<target wwpn> <target port id> <target id>)
```

Where:

```
hba instance = Adapter number (use the -g command to find)  
hba wwnn = Worldwide node name of the adapter  
hba wwpn = Worldwide port name of the adapter  
target wwnn = Worldwide node name of the target  
target wwpn = Worldwide port name of the target  
target port id = Port ID of the target  
target id = ID to which the target is bound
```

For more information, refer to the section about Fibre Channel noninteractive commands in the *User's Guide—QConvergeConsole CLI* (part number SN0054667-00).

Configuring Boot Devices

Use QConvergeConsole or *Fast!UTIL* to configure boot devices:

- [Configuring Boot Devices with QConvergeConsole GUI](#)
- [Configuring Boot Devices with Interactive QConvergeConsole CLI](#)
- [Configuring Boot Devices with Noninteractive QConvergeConsole CLI](#)
- [Configuring Boot Devices with the BIOS](#)

Configuring Boot Devices with QConvergeConsole GUI

For information about configuring boot devices with QConvergeConsole GUI, refer to the topics about HBA parameters, viewing or modifying port parameters, and boot device selection in the *QConvergeConsole Help*.

Configuring Boot Devices with Interactive QConvergeConsole CLI

On the **Fibre Channel Adapter Configuration** menu, select **Boot Devices Configuration** to open the **Boot Device Settings** menu with options to view and configure boot devices.

For information, refer to the section about the Fibre Channel interactive commands in the *User's Guide—QConvergeConsole CLI* (part number SN0054667-00).

Configuring Boot Devices with Noninteractive QConvergeConsole CLI

To set a specific target as the boot device for a specific adapter, issue the following command:

```
# qauccli -pr fc -e (<hba instance> | <hba wwpn>) <target wwnn>  
<target wwpn> <target id> <lun id>
```

Where:

`hba instance` = Adapter number (use the `-g` command to find)

`hba wwpn` = Worldwide port name of the adapter

`target wwnn` = Worldwide node name of the target

`target wwpn` = Worldwide port name of the target

`target id` = ID to which the target is bound

`lun id` = ID of the LUN

For more information, refer to the “Fibre Channel Noninteractive Commands” section of the *User's Guide—QConvergeConsole CLI* (part number SN0054667-00).

Configuring Boot Devices with the BIOS

For information about boot device configuration with the *Fast!UTIL* BIOS utility, refer to “Using Fast!UTIL for Custom Configuration” on page 36 for information.

Configuring Virtual Ports (NPIV)

Use QConvergeConsole to configure virtual ports for N_Port ID virtualization and quality of service:

- [Configuring NPIV with QConvergeConsole GUI](#)
- [Configuring NPIV with Interactive QConvergeConsole CLI](#)
- [Configuring NPIV with Noninteractive QConvergeConsole CLI](#)
- [Configuring NPIV Quality of Service](#)

Configuring NPIV with QConvergeConsole GUI

For information about using virtualization (NPIV) in QConvergeConsole GUI, refer to in the *QConvergeConsole Help*.

To access the *QConvergeConsole Help* system while the GUI utility is running, point to the gear icon , point to **Help**, and then click **Browse Contents**. To install QConvergeConsole GUI, see “Installing QConvergeConsole GUI” on page 131.

Configuring NPIV with Interactive QConvergeConsole CLI

For information about using virtualization (NPIV) in the interactive mode of QConvergeConsole CLI, refer to the *User’s Guide—QConvergeConsole CLI* (part number SN0054667-00). To download the guide, go to www.marvell.com.

Configuring NPIV with Noninteractive QConvergeConsole CLI

To create a virtual port with an automatic WWPN using the noninteractive mode of QConvergeConsole CLI, issue the following command:

```
# qaucli -vp (<hba instance> | <hba wwpn>) create auto [<num_of_vport>]
```

Where:

`hba instance` = Adapter number (use the `-g` command to find)

`hba wwpn` = Worldwide port name of the adapter

`num_of_vport` = Number of virtual ports to be created (up to the maximum available virtual ports allowed).

If `num_of_vport` is `max`, then the maximum number of virtual ports will automatically be created if applicable.

For more information, refer to the section about Fibre Channel noninteractive commands in the *User's Guide—QConvergeConsole CLI* (part number SN0054667-00).

Configuring NPIV Quality of Service

The QLogic 2700 Series Adapters solution provides for standards-based quality of service (QoS), ensuring high-quality performance for applications that require preferential delivery. The QLogic QoS solution is based on assigning QoS levels to virtual ports (NPIV ports). You can configure the QoS using the **priority method** or the **bandwidth method**, as shown in [Figure 3-7](#).

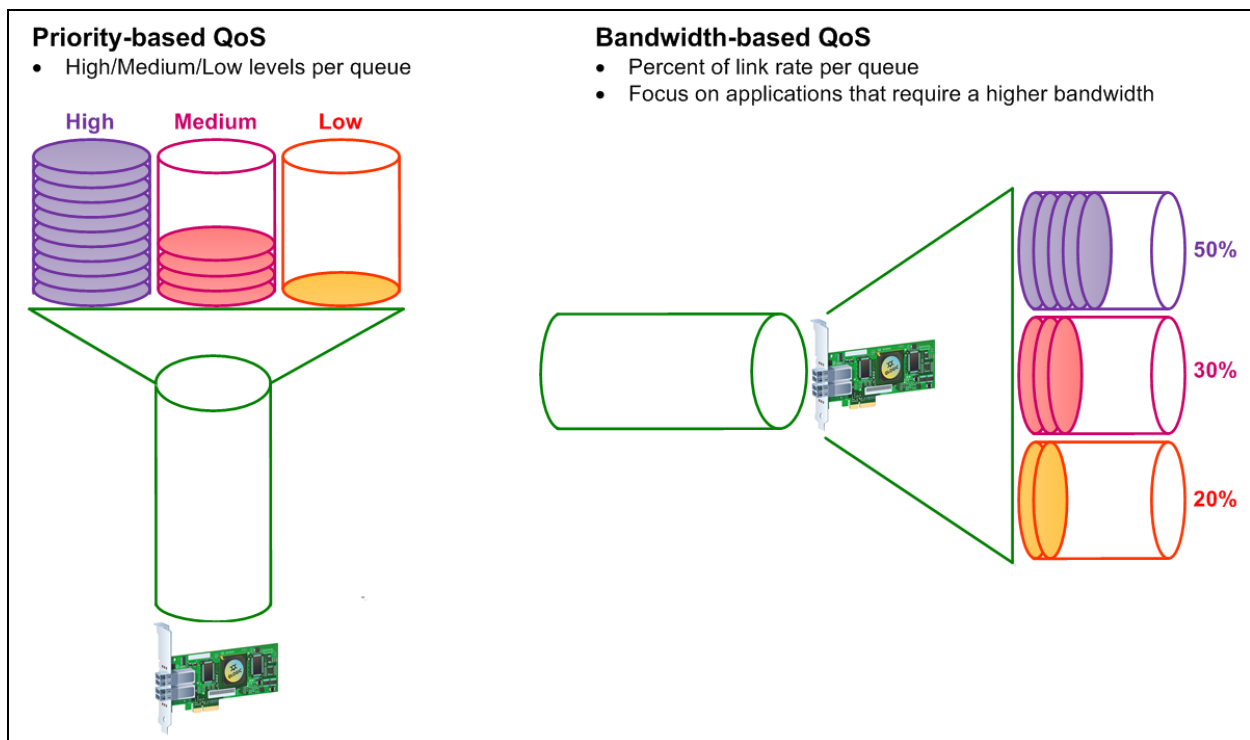

Figure 3-7. Priority and Bandwidth-Based QoS

On a single physical port, you can configure QoS using the priority method or the bandwidth method, but not both.

- The **priority method** assigns priority levels (low, medium, or high) to virtual ports based on the quality of service required for the applications or VMs using the virtual port. This method provides for various levels of latency requirements across virtual ports.

- The **bandwidth method** assigns a bandwidth percentage (0–100) or a bandwidth rate (for example, 6GFC) to applications or VMs that are using a virtual port. This method provides a minimum bandwidth guarantee. The bandwidth-based QoS configuration applies only when the total bandwidth requirement of the applications exceeds the available bandwidth. The bandwidth is not reserved for a specific virtual port, and unused bandwidth is shared among the other virtual ports.

The physical port or WWN always has high priority, independent of the bandwidth or priority scheme chosen for created virtual ports. You need not assign a QoS level to every virtual port that you create. If a QoS level is not assigned to a virtual port, the default is low priority (best effort), independent of the bandwidth or priority scheme. This flexibility allows you to focus on critical applications to ensure that the highest service level is provided. You can modify QoS levels for virtual ports using QConvergeConsole CLI.

To modify QoS levels, the configuration must meet the following hardware and software requirements:

- Server operating system: Microsoft® Windows Server 2012 or later
- Server support for MSI-X
- QLogic 2700 Series Adapter
- Latest version of the QLogic STOR miniport driver, available from Dell:
<http://support.dell.com>
- Fibre Channel switch that supports NPIV
- Physical port attached in a point-to-point connection

Setting QoS by Bandwidth

Setting the QoS by bandwidth allocates up to 80 percent of the physical port's bandwidth to its virtual ports. The remaining 20 percent is reserved to handle non-QoS applications and virtual ports.

Setting QoS by bandwidth guarantees bandwidth for each virtual port and to the application or virtual machine (VM) associated with that virtual port. The proper QoS setting can prevent bottlenecks that occur when VMs contend for port bandwidth.

Consider how much bandwidth is required to maximize application or VM performance and set the QoS level to 105 percent of that value. For example, if a mission-critical application on a VM requires 1Gb of bandwidth to transmit its data over the fabric, Marvell recommends a 1.05Gb bandwidth for the virtual port.

Alternatively, you can set the virtual port QoS values as a percentage of the total available bandwidth.

NOTE

Setting QoS by bandwidth guarantees a minimum bandwidth to a virtual port, but not a maximum limit. If the application or virtual port requires more bandwidth than the QoS bandwidth value allows and the physical port has available bandwidth, the application receives the additional bandwidth. The port allocates additional bandwidth on demand up to the port capacity or until there is contention for bandwidth among the virtual ports.

When the physical port is partitioned into four virtual ports, the port bandwidth is divided between the virtual ports according to traffic demands.

QConvergeConsole lets you configure QoS for each virtual port by setting minimum and maximum percentages of the physical port's bandwidth for each virtual port. This feature lets you guarantee a transmission rate for each port that requires a specific bandwidth to run mission-critical applications for business continuity using virtual ports. The setting for a specific QoS can resolve bottlenecks that exist when VMs contend for port bandwidth.

To set the QoS by bandwidth percentage with QConvergeConsole GUI:

1. In the QConvergeConsole system tree pane on the left, expand a 2700 Series Adapter.
2. Select a virtual port.
3. In the content pane on the right, click the **QoS** tab.
4. In the **QoS Type** box, select **Bandwidth**.
5. In the **View By** box, select **Bandwidth Percentage**.
6. Move the slider to select a percentage between 1 percent to 100 percent. This selection indicates the bandwidth you want to guarantee for data transferred over the selected virtual port.

Figure 3-8 shows an example.

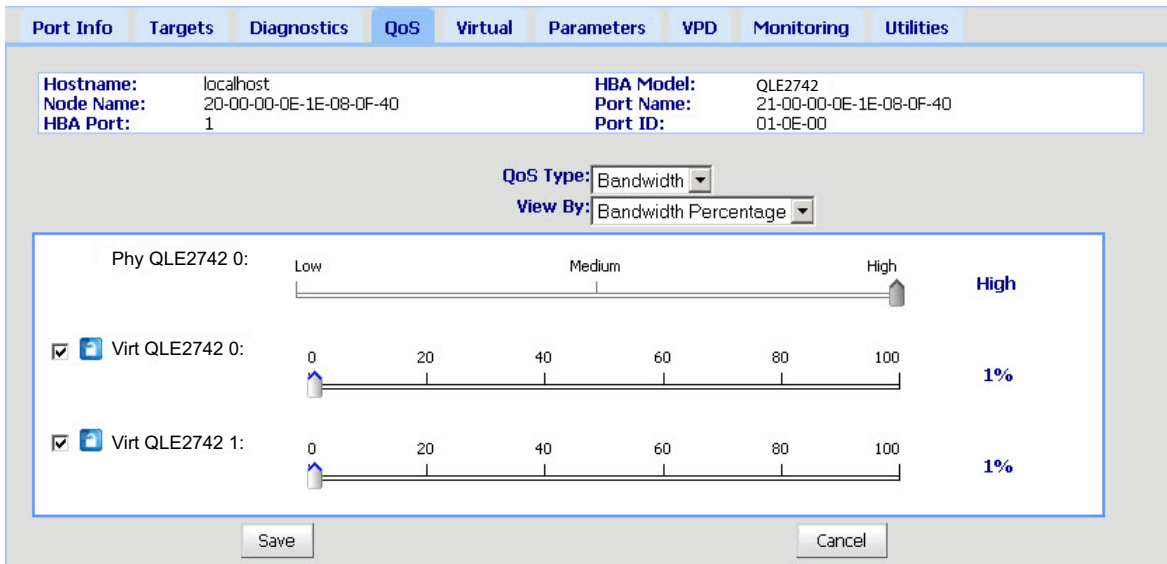

Figure 3-8. Setting the QoS by Bandwidth Percentage

7. Click **Save**.

To set the QoS by bandwidth speed with QConvergeConsole GUI:

1. In the QConvergeConsole tree pane on the left, expand a 2700 Series Adapter.
2. Select a virtual port.
3. In the content pane on the right, click the **QoS** tab.
4. In the **QoS Type** box, select **Bandwidth**.
5. In the **View By** box, select **Bandwidth Speed**.

6. Move the slider to select the bandwidth speed, as shown in [Figure 3-9](#).

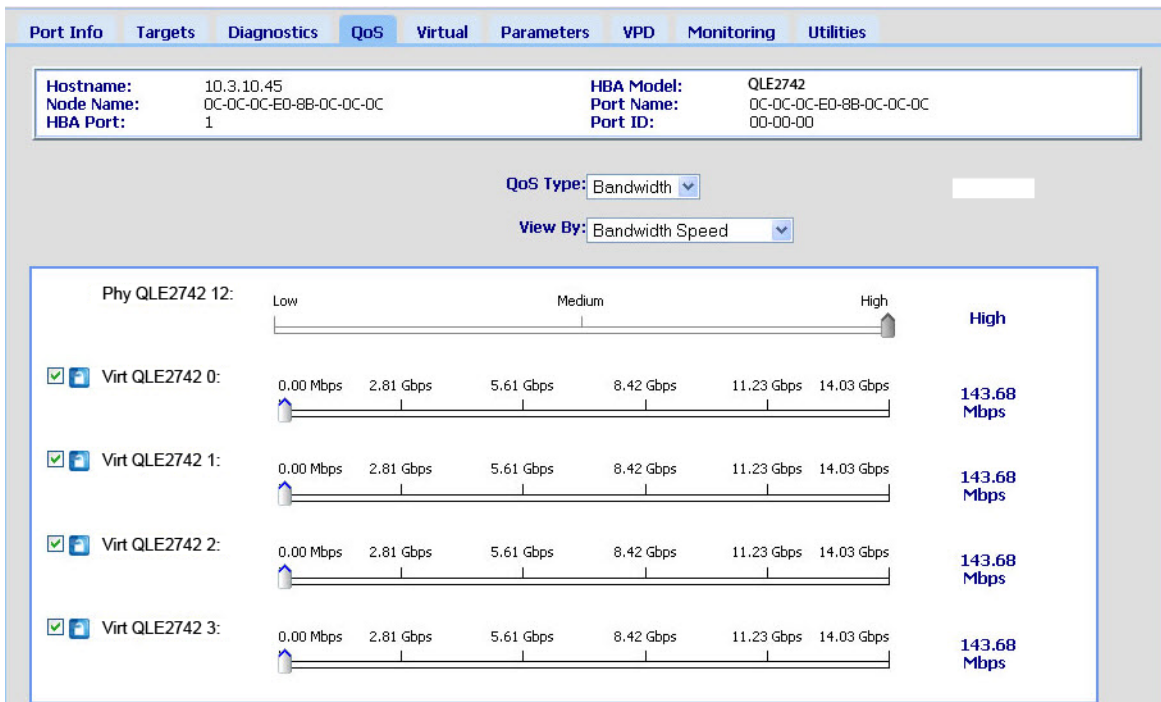

Figure 3-9. Setting the QoS by Bandwidth Speed

7. Click **Save**.

To set the QoS by bandwidth speed with interactive QConvergeConsole CLI:

1. On the **Fibre Channel Adapter Configuration** menu, select the **QoS** option.
2. From the port menu, select a port to open the **QoS Type Menu**. Select **2: QoS Bandwidth** to set the bandwidth speed.

Setting QoS by Priority

To set the QoS by priority with QConvergeConsole GUI:

1. In the QConvergeConsole tree pane on the left, expand a 2700 Series Adapter.
2. Select a virtual port.
3. In the content pane on the right, click the **QoS** tab.
4. In the **QoS Type** box, select **Priority**.

5. Move the slider to select a low, medium, or high priority, as shown in [Figure 3-10](#).

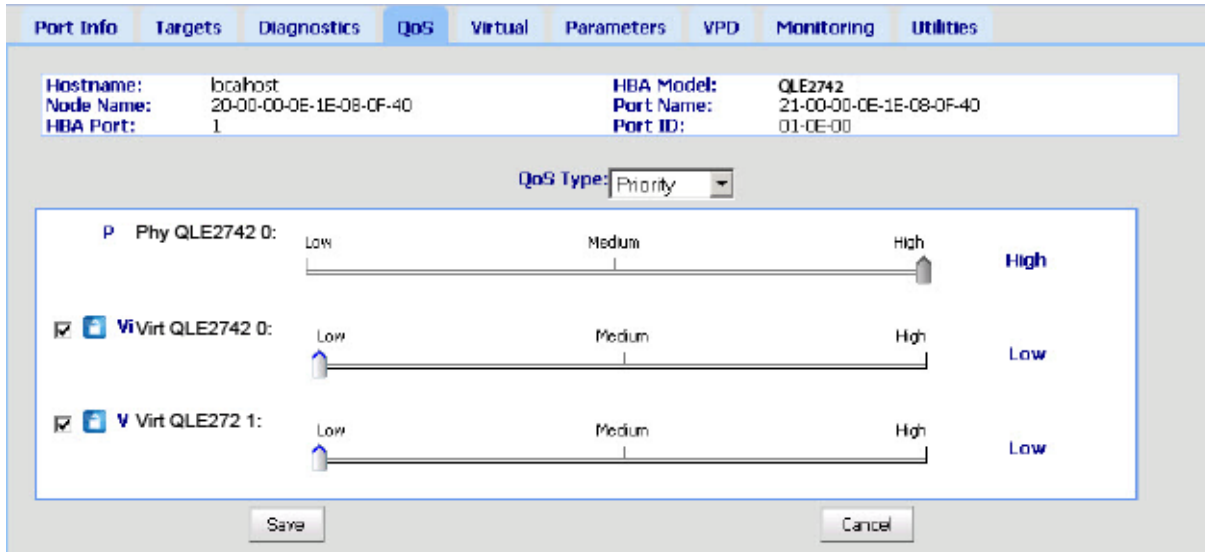

Figure 3-10. Setting the QoS by Priority

6. Click **Save**.

To set the QoS by priority with interactive QConvergeConsole CLI:

1. From the **Fibre Channel Adapter Configuration** menu, select the **QoS** option.
2. From the port menu, select a port to open the **QoS Type Menu**.
Select **1: QoS Priority** to set the priority.

Configuring Fibre Channel Driver Parameters

Use QConvergeConsole GUI, CLI, or VMware plug-in to configure Fibre Channel driver parameters:

- [Configuring Fibre Channel Driver Parameters with QConvergeConsole GUI](#)
- [Configuring Fibre Channel Driver Parameters with Interactive QConvergeConsole CLI](#)
- [Configuring Fibre Channel Driver Parameters with Noninteractive QConvergeConsole CLI](#)
- [Configuring Fibre Channel Driver Parameters with QConvergeConsole VMware vCenter Server Plug-in](#)

Configuring Fibre Channel Driver Parameters with QConvergeConsole GUI

Refer to the topics about HBA parameters and viewing or modifying port parameters in the *QConvergeConsole Help* for information.

Configuring Fibre Channel Driver Parameters with Interactive QConvergeConsole CLI

To configure Fibre Channel driver parameters using interactive QConvergeConsole CLI:

1. On the **Fibre Channel Adapter Configuration** menu, select **HBA Parameters**.
2. On the port menu, select a port to open the **HBA Parameters** menu.
3. On the **HBA Parameters** menu, select **Configure HBA Parameters** to open the **Configure Parameters** menu with options to configure connection options, data rate, frame size, hard loop ID, loop reset delay, BIOS, Fibre Channel tape support, operation mode, interrupt delay timer, login retry count, port down retry count, LIP full login, link down time-out, target reset, LUNS per target, and receive out-of-order frames.

For more information, refer to the section about the Fibre Channel interactive commands in the *User's Guide—QConvergeConsole CLI* (part number SN0054667-00).

Configuring Fibre Channel Driver Parameters with Noninteractive QConvergeConsole CLI

To configure driver settings, issue the following command:

```
# qauccli -pr fc -fs (<hba instance> | <hba wwpn>) {(<param name> | <param alias>) <param value>}
```

Where:

`hba instance` = Adapter number (use the `-g` command to find)

`hba wwpn` = Worldwide port name of the adapter

`param name` = Name of the parameter

`param alias` = Alias of the parameter

`param value` = New value of the parameter

For more information, refer to the section about the Fibre Channel noninteractive commands in the *User's Guide—QConvergeConsole CLI* (part number SN0054667-00).

Configuring Fibre Channel Driver Parameters with QConvergeConsole VMware vCenter Server Plug-in

For details on how to configure the Fibre Channel driver parameters using the QConvergeConsole plug-in, see the *User's Guide—QConvergeConsole Plug-ins for VMware vSphere* (part number SN0054677-00).

Configuring Selective LUNs

The QConvergeConsole GUI cannot be used for configuring selective LUNs.

To configure selective LUNs with the interactive QConvergeConsole CLI, refer to the section about the Fibre Channel interactive commands in the *User's Guide—QConvergeConsole CLI* (part number SN0054667-00).

To configure selective LUNs with the noninteractive QConvergeConsole CLI, refer to the section about the Fibre Channel noninteractive commands in the *User's Guide—QConvergeConsole CLI* (part number SN0054667-00).

Configuring OoOFR

Out-of-order frame reassembly (OoOFR) reassembles out-of-order frames as they are received, minimizing network congestion by eliminating the retransmission of frames and exchanges. To configure OoOFR, use either QConvergeConsole GUI or CLI.

Configuring OoOFR with QCC GUI

To enable OoOFR with QConvergeConsole GUI:

1. In the QConvergeConsole system tree pane on the left, select a Fibre Channel port.
2. In the content pane on the right, click **Parameters**.
3. Click the **Advanced HBA Parameters** tab.
4. Select the **Enable Receive Out of Order Frame** check box.

Configuring OoOFR with Interactive QCC CLI

To enable OoOFR with the interactive QConvergeConsole CLI:

1. On the **Fibre Channel Adapter Configuration** menu, select **HBA Parameters**.
2. On the port menu, select a port to open the HBA Parameters menu.

3. On the **HBA Parameters** menu, select **Configure HBA Parameters** to open the Configure Parameters menu.
4. Select **13: Enable Receive Out Of Order Frame**.

Configuring OoOFR with Noninteractive QCC CLI

To enable OoOFR in the noninteractive mode of QConvergeConsole CLI, issue one of the following commands:

```
# qaucli -n <hba instance>|<hba wwpn> EnableReceiveOutOfOrderFrame 1  
# qaucli -n <hba instance>|<hba wwpn> EO 1
```

Where:

hba instance = Adapter number (use the `-g` command to find)
hba wwpn = Worldwide port name of the adapter

To disable OoOFR in the noninteractive mode of QConvergeConsole CLI, issue one of the following commands:

```
# qaucli -n <hba instance>|<hba wwpn> EnableReceiveOutOfOrderFrame 0  
# qaucli -n <hba instance>|<hba wwpn> EO 0
```

Configuring the UEFI Driver

This section provides information on configuring the unified extensible firmware interface (UEFI) driver contained in the multiboot image. UEFI 2.x systems use a human interface infrastructure (HII) to configure motherboard devices and plug-in adapters. QLogic Fibre Channel Adapters use an HII to configure adapter parameters and boot-from-SAN settings.

To configure the UEFI driver for Dell:

1. During system boot, press the key corresponding to your platform.
2. On the Dell System Setup window, select **Device Settings**, and then press the ENTER key.

The Device Settings window opens and lists the devices installed in the system. Each listed device supports the HII. QLogic devices have one device settings entry per port. Each entry contains the adapter name and WWPN of the port. [Figure 3-11](#) shows an example of the System Setup window for Device Settings.

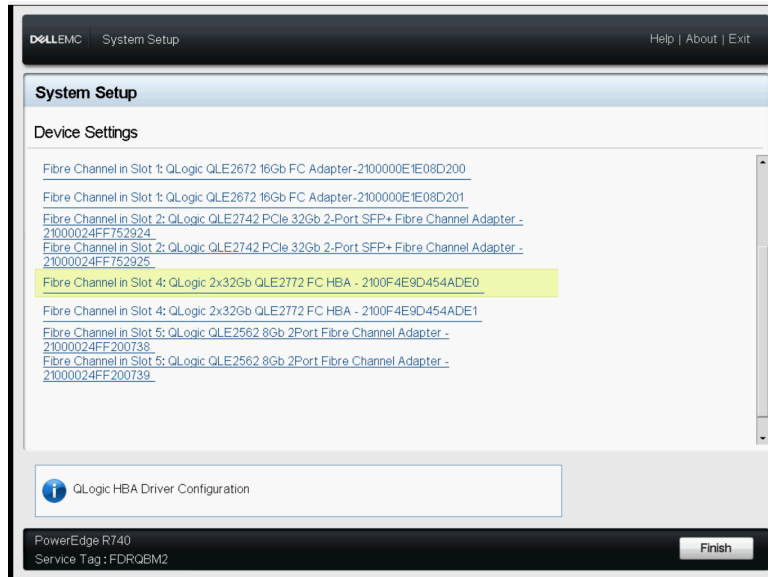

Figure 3-11. Dell System Setup: Device Settings

3. In the Device Settings window, select your device and then press ENTER.
The Main Configuration Page for the selected device appears. The Main Configuration Page is the top-level menu of the adapter configuration pages. [Figure 3-12](#) shows an example of the Main Configuration Page.



Figure 3-12. Dell System Setup: Main Configuration

4. On the Main Configuration Page, select **Port Configuration Page** and press ENTER.

The Port Configuration Page appears; [Figure 3-13](#) shows an example.

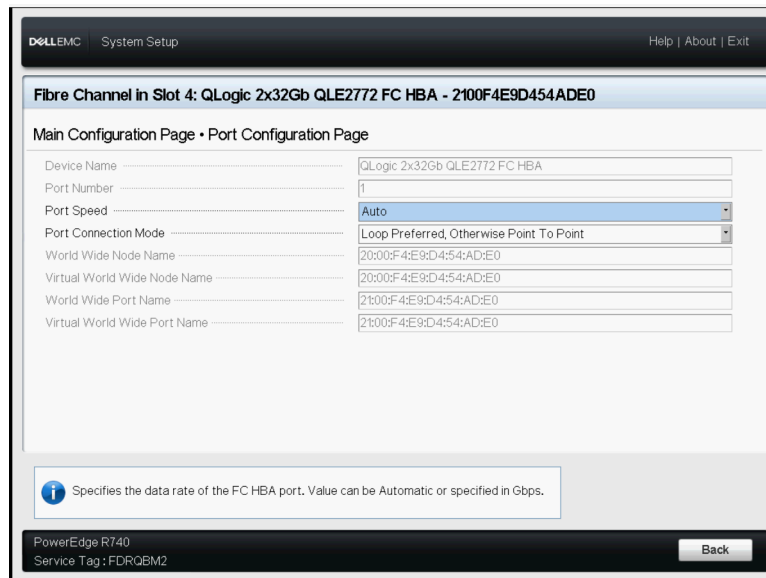

Figure 3-13. Dell System Setup: Port Configuration

- Use the Port Configuration Page to change adapter operational parameters, such as port speed. In most cases, use the default values. [Table 3-4](#) describes the configurable options on the Port Configuration Page.

Table 3-4. Port Configuration Page Settings

Setting	Description
Device Name	Indicates the name of the adapter.
Port Number	Indicates the index of the selected port (1 to N). Figure 3-13 shows port 1 in a two-port adapter.
Port Speed	Indicates the data rate of the Fibre Channel adapter port. This value can be automatic or specified in GFC. The adapters support 8Gbps, 16Gbps, and 32Gbps.
Port Connection Mode	Indicates the connection mode of the Fibre Channel adapter port. The adapters support the following: <ul style="list-style-type: none"> ■ Loop Only^a ■ Point to Point ■ Loop Preferred, Otherwise Point To Point ^a
World Wide Node Name	Indicates the adapter port’s unique worldwide node name (WWNN).

Table 3-4. Port Configuration Page Settings (Continued)

Setting	Description
Virtual World Wide Node Name	Indicates the adapter port's unique virtual WWNN.
World Wide Port Name	Indicates the adapter port's unique WWPN.
Virtual World Wide Port Name	Indicates the adapter port's unique virtual WWPN.

^a Loop support is available only at port speeds up to and including 8Gbps. At 16Gbps and 32Gbps, loop is not supported.

- To return to the Main Configuration Page, click **Back**.
- On the Main Configuration Page, select **Firmware and Device Information**, and then press ENTER.

The Firmware and Device Information page provides the adapter and firmware version information, and port address information. [Figure 3-14](#) shows an example.



Figure 3-14. Dell System Setup: Firmware and Device Information

Table 3-5 describes the Firmware and Device Information settings.

Table 3-5. Firmware and Device Information Settings

Setting	Description
Chip Type	Type of intelligent storage peripheral (ISP) controller used in the adapter.
PCI Device ID	Unique PCI device ID of the adapter.
Bus:Device:Function	PCI address of the adapter in the Bus:Device:Function (BDF) notation.
Family Firmware Version	Adapter firmware version information.
EFI Driver Version	Adapter extensible firmware interface (EFI) driver version information.

8. To return to the Main Configuration Page, click **Back**.
9. On the Main Configuration Page, select **Fibre Channel Target Configuration**, and then press ENTER.

The Fibre Channel Target Configuration page appears. Figure 3-15 shows an example.

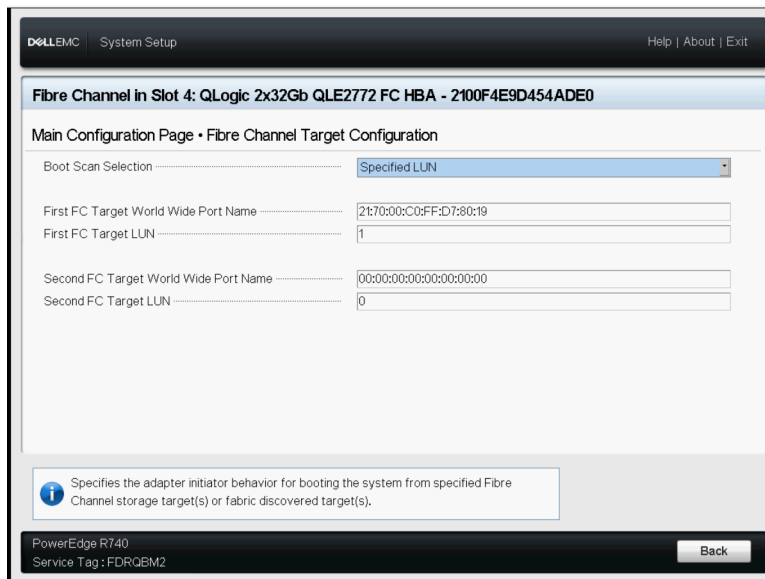

Figure 3-15. Fibre Channel Target Configuration

10. On the Fibre Channel Target Configuration page, select SAN storage devices for boot from SAN. With selective boot scan enabled, the target configuration determines which target LUNs to map. All other devices are ignored. [Table 3-6](#) describes the Fibre Channel Target Configuration settings.

Table 3-6. Fibre Channel Target Configuration Settings

Setting	Description
Boot Scan Selection	Specifies the adapter initiator behavior for booting the system from the specified Fibre Channel storage target(s) or fabric discovered target(s).
First FC Target World Wide Port Name	Specifies the WWPN of the first Fibre Channel storage target.
First FC Target LUN	Specifies the LUN of the first Fibre Channel storage target.
Second FC Target World Wide Port Name	Specifies the WWPN of the second Fibre Channel storage target.
Second FC Target LUN	Specifies the LUN of the second Fibre Channel storage target.

NOTE

System UEFI compatibility: To boot from a QLogic host 2700 Series Adapter in a computer system with a multiboot system UEFI, the 2700 Series Adapter must be included as the first device in the list of bootable devices in the system's **Boot** menu.

11. To return to the Main Configuration Page, click **Back**.

12. On the Main Configuration Page, select **HBA Configuration Page**, and then press ENTER.

The HBA Configuration Page appears; [Figure 3-16](#) shows an example.

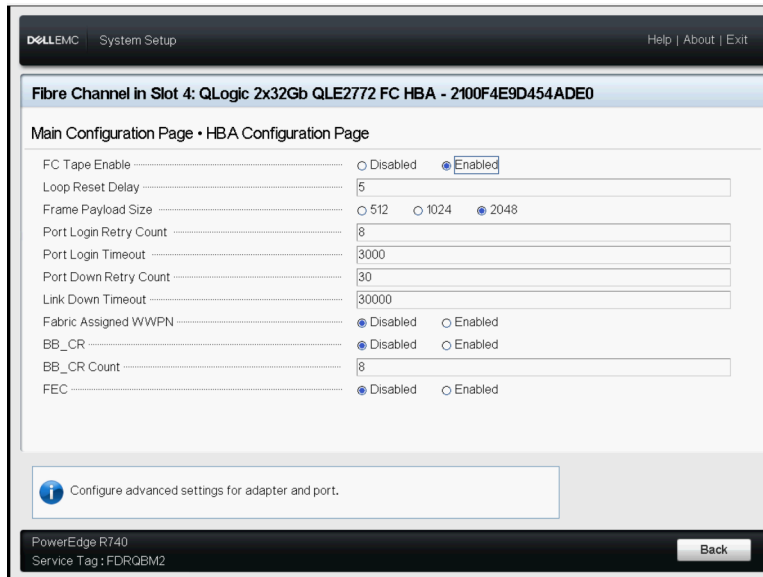

Figure 3-16. Dell System Setup: HBA Configuration

13. Use the HBA Configuration Page to configure adapter operational parameters. In most cases, use the default values.

[Table 3-7](#) describes the fields on the HBA Configuration Page.

Table 3-7. HBA Configuration Page Settings

Setting	Description
FC Tape Enable	Enables or disables Fibre Channel protocol (FCP-2) recovery.
Loop Reset Delay	Specifies the Fibre Channel arbitrated loop reset delay for the port. After resetting the loop, the adapter firmware refrains from initiating any loop activity for the number of seconds specified. The range is 0 to 60.
Frame Payload Size	Specifies the maximum Fibre Channel frame payload size.
Port Login Retry Count	Specifies the number of times the adapter firmware initiator tries to log in to a target device port. The range is 0 to 255.

Table 3-7. HBA Configuration Page Settings (Continued)

Setting	Description
Port Login Timeout	Specifies the time-out in milliseconds that the initiator uses when attempting to log in to the target device port. The range is 0 to 255000.
Port Down Retry Count	Specifies the number of seconds the software retries a command to a port returning port-down status. The range is 0 to 255.
Link Down Timeout	Specifies the number of milliseconds the Fibre Channel uplink port can be offline before the system is notified that the SAN fabric connectivity is lost and the uplink port is marked as being down. The range is 1 to 255000.

14. Click **Back** to return to the Main Configuration Page window.
15. Click **Finish** to save your changes and exit.

Setting Queue Depth

Queue depth refers to the maximum LUN queue depth to report for target devices. This section provides the default values and instructions for modifying the queue depth value configured by the Windows, Linux, and ESXi drivers.

Changing the Windows Queue Depth

The default queue depth value on Windows is 20 and the range is 0–254.

To change the default value:

1. Click **Start**, select **Run**, and open the REGEDIT/REGEDT32 program.
2. Select `HKEY_LOCAL_MACHINE` and then expand the tree structure down to the QLogic driver as follows:

```
HKEY_LOCAL_MACHINE
  SYSTEM
    CurrentControlSet
      Services
        ql2300
          Parameters
            Device
```

3. Double-click `DriverParameter:REG_SZ:qd=32`.

4. If the string `qd=` does not appear, append it to end of the string as `;qd=32`.
5. Click **OK**.
6. Exit the Windows Registry Editor, and then shutdown and reboot the system.

Changing the Linux Queue Depth

The default queue depth value on Linux is 64 and the range is 1–65535.

To change the default value:

1. Set the module parameter by adding the following line to the `modprobe.conf` file:

```
options qla2xxx ql2xmaxqdepth=X
```

where `X` is the new queue depth value.
2. Save and close the `modprobe.conf` file.

Changing the ESXi Queue Depth

The default queue depth value on ESXi is 64 and the range is 0–65535.

To change the default value:

1. Issue the following command:

```
$ esxcfg-module -s "ql2xmaxqdepth=X" qlnativefc
```

where `X` is the new queue depth value.
2. Restart the system.

Setting an FA-PWWN

This section provides the following information for fabric-assigned port world wide (FA-PWWN) name:

- [Setting the FA-PWWN from the Adapter](#)
- [Setting the FA-PWWN from the Brocade Switch](#)

Setting the FA-PWWN from the Adapter

From the adapter side, you can set the FA-PWWN using the following utilities:

- [Setting FA-PWWN with QConvergeConsole GUI](#)
- [Setting FA-PWWN with QConvergeConsole CLI](#)
- [Setting FA-PWWN with QConvergeConsole VMware Plug-ins](#)

Setting FA-PWWN with QConvergeConsole GUI

Before setting the FA-PWWN, the port name appears on the Port Info page as shown in the example in [Figure 3-17](#).

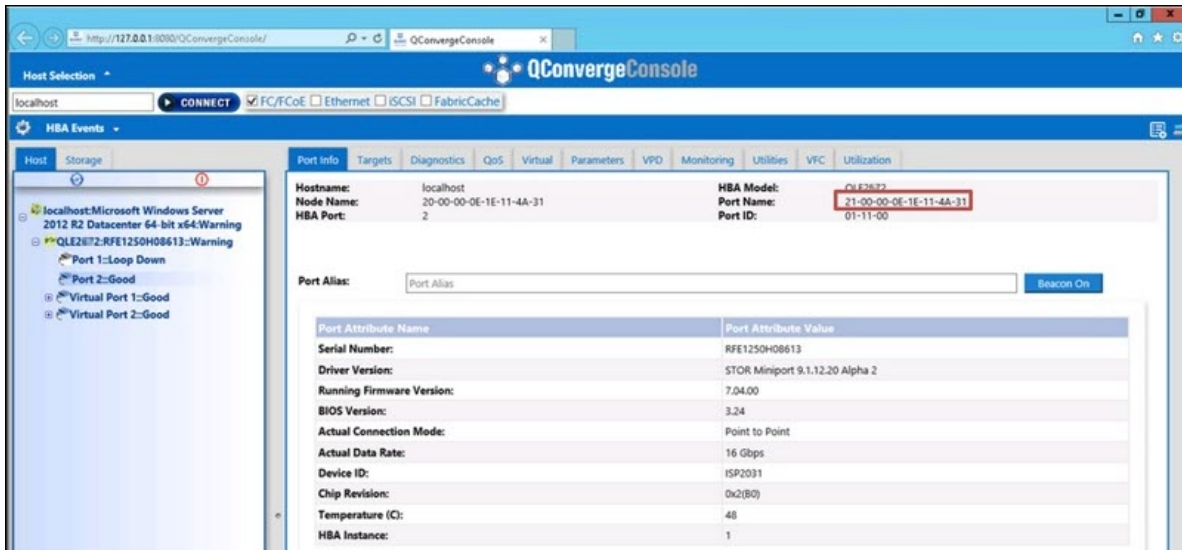

Figure 3-17. Before Setting the FA-PWWN in the GUI

To set the FA-PWWN from the adapter using QConvergeConsole GUI:

1. In the QConvergeConsole GUI tree pane on the left, select an adapter, expand the adapter node, and then select a port.
2. In the content pane on the right, click the **Parameters** tab.
3. On the Parameters page, click the **Advanced HBA Parameters** tab.
4. Under **Configure Port Advanced Parameters**, select the **Enable Fabric Assigned WWN** check box, and then click **Save**.

After refreshing the Brocade® switch, the Port Info page shows the **Port Name** as shown in [Figure 3-18](#).

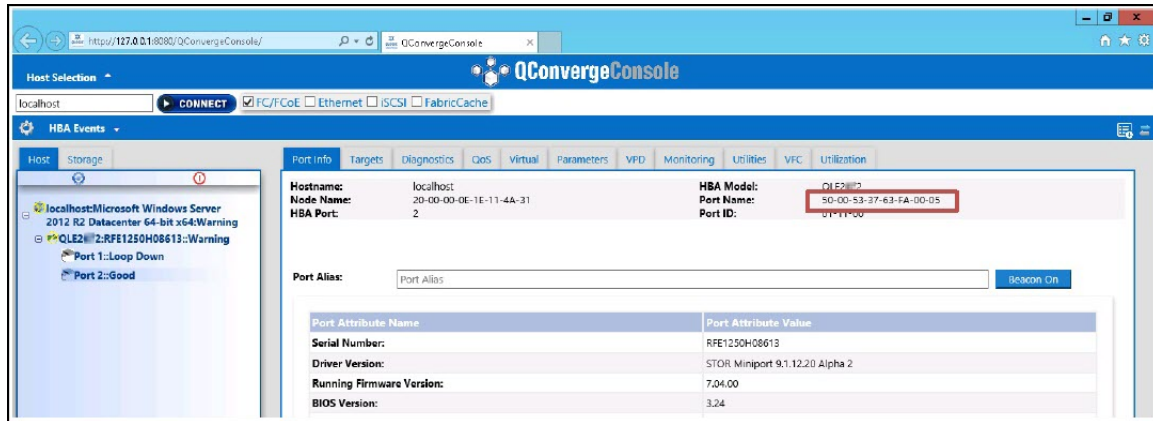

Figure 3-18. New FA-PWWN Port Name in GUI

Setting FA-PWWN with QConvergeConsole CLI

To set the FA-PWWN from the adapter using QConvergeConsole CLI:

1. In the interactive mode of QConvergeConsole CLI, select **Main Menu**, and then click **Adapter Configuration**.
2. Select **HBA Parameters**.
3. Select the appropriate port.
4. Select **Configuration HBA Parameters**.
5. Select **Enable Fabric Assign WWN**.
6. On the **Enable Fabric Assign WWN Menu**, select **1: Enable**.
7. Select the option to **Commit Changes**.

The following shows an example of setting the FA-PWWN:

```
HBA Desc.      : QLE2742 QLogic 2-port 32Gb Fibre Channel Adapter
FW Version    : 7.04.00
WWPN         : 21-00-00-OE-1E-11-4A-38
WWNN        : 21-00-00-OE-1E-11-4A-38
Link         : Online
```

- =====
- 1: Connection Options
 - 2: Data Rate
 - 3: Frame Size
 - 4: Enable HBA Hard Loop ID

3–Fibre Channel Configuration

Setting an FA-PWWN

- 5: Hard Loop ID
- 6: Loop Reset Delay (seconds)
- 7: Enable BIOS
- 8: Enable Fibre Channel Tape Support
- 9: Operation Mode
- 10: Interrupt Delay Timer (100 microseconds)
- 11: Execution Throttle¹
- 12: Login Retry Count
- 13: Port Down Retry Count
- 14: Enable LIP Full Login
- 15: Link Down Timeout (seconds)
- 16: Enable Target Reset
- 17: LUNs per Target
- 18: Enable Receive Out of Order Frame
- 19: Enable LR
- 20: Enable Fabric Assign WWN**
- 21: Commit Changes
- 22: Abort Changes

(p or 0: Previous Menu; m or 98: Main Menu; ex or 99: Quit)

Please enter selection: **20**

QConvergeConsole

Version 1.1.3 (Build 22)

Enable Fabric Assign WWN Menu

- 1: Enable
- 2: Disable (current)

(p or 0: Previous Menu; m or 98: Main Menu; ex or 99: Quit)

Please enter selection: **1**

¹ The Execution Throttle parameter is no longer supported for Fibre Channel 16G and higher.

After refreshing the Brocade switch, the **Adapter Information** shows the port name as shown in the following example.

```
QConvergeConsole
CLI - Version 1.1.3 (Build 22)

FC Adapter Information

1: FC Adapter Information
2: FC Port Information
3: FC VPD Information
4: FC Target/LUN Information
5: FC VFC Information

(p or 0: Previous Menu; m or 98: Main Menu; ex or 99: Quit)
Please enter selection: 2

QConvergeConsole
CLI - Version 1.1.3 (Build 22)

Adapter Information
HBA Model QLE2742 SN: RFE12340H08416
1: Port 1: WWPN: 21-00-00-0F-1F-11-4A-30 Link Down
2: Port 2: WWPN: 50-00-53-37-63-FA-00-05 Online
```

Setting FA-PWWN with QConvergeConsole VMware Plug-ins

For information about setting a FA-PWWN using the QConvergeConsole VMware vCenter Server Plug-in or QConvergeConsole VMware vSphere Web Client Plug-in, see the section “Managing a Fibre Channel Adapter Port” in the *User’s Guide—QConvergeConsole Plug-ins for VMware vSphere* (part number SN0054677-00).

Setting the FA-PWWN from the Brocade Switch

From the Brocade switch, you can set a FA-PWWN and a static FA-PWWN. For the most current information, refer to the Brocade switch documentation.

Setting the FA-PWWN from the Switch

Figure 3-19 shows the FA-PWWN setting from the Brocade switch.

```
portdisable 17
fapwn --enable -port 17
portenable 17
fapwn --show all
```

AG Port	port	Device Port WWN	Virtual Port WWN	PID	Enable	MapType
---	17	---	50:00:53:37:63:fa:00:05	--	Yes	Port/User

Figure 3-19. Setting the FA-PWWN from the Brocade Switch

After refreshing the Brocade switch, the **Device Port WWN** appears in Web Tools as shown in Figure 3-20.

Domain	User P...	Port ID	Device Node WWN	Sequence N...	Tag	Device Type	Model	WWN Compa...	Port Type	Device Port WWN	Device Name	Capability	FDMI Host Na...	NPIV(or)Virtu...	Host vs. Tar...	Member Of Z...	Member O
1(Ox1)	17	0x011100	20:00:00:0e:1e:11:4a:31				QLogic Corp...	N		50:00:53:37:63:fa:00:05	QLE2742 FW...	NS	WWN-5047VP...	Physical	Initiator	Native_sutter	
1(Ox1)	15	0x010F00	20:03:00:11:0d:10:55:00				SANBlaze T...	N		20:03:00:11:0d:10:55:00	SANBlaze V...	NS		Physical	Target	VM4_Ldom1...	

Figure 3-20. Device Port WWN for Brocade Switch

Setting the Static FA-PWWN from the Switch

Figure 3-21 shows the static FA-PWWN setting from the Brocade switch.

```
portdisable 17
fapwn --assign -port 17 -v 51:00:53:37:63:fa:02:11
portenable 17
fapwn --show all
```

AG Port	port	Device Port WWN	Virtual Port WWN	PID	Enable	MapType
---	17	---	51:00:53:37:63:fa:02:11	--	Yes	Port/User
			50:00:53:37:63:fa:00:05			

Figure 3-21. Setting the Static FA-PWWN from the Brocade Switch

After refreshing the Brocade switch, the **Device Port WWN** appears in Web Tools as shown in [Figure 3-22](#).

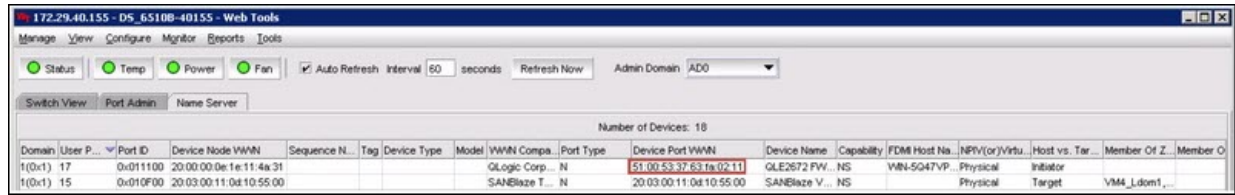

The screenshot shows the Brocade Web Tools interface. At the top, there are tabs for Manage, View, Configure, Monitor, Reports, and Tools. Below these are status indicators for Status, Temp, Power, and Fan, along with an Auto Refresh interval of 60 seconds and an Admin Domain of ADO. The main content area is titled 'Switch View' and 'Port Admin'. A table displays the 'Number of Devices: 18'. The table has columns for Domain, User P..., Port ID, Device Node WWN, Sequence N..., Tag, Device Type, Model, WWN Compa..., Port Type, Device Port WWN, Device Name, Capability, FDMI Host Na..., NFFV(or)Virtu..., Host vs. Tar..., Member Of Z..., and Member O... The table contains two rows of data. The first row has a Device Port WWN of 51:00:53:37:63:fa:02:11. The second row has a Device Port WWN of 20:03:00:11:0a:10:55:00.

Domain	User P...	Port ID	Device Node WWN	Sequence N...	Tag	Device Type	Model	WWN Compa...	Port Type	Device Port WWN	Device Name	Capability	FDMI Host Na...	NFFV(or)Virtu...	Host vs. Tar...	Member Of Z...	Member O...
t(0x1)	17	0x011100	20:00:00:0e:1e:11:4a:31				QLogic Corp...	N		51:00:53:37:63:fa:02:11	GLE2672 FW...	NS	WIN-5047VP...	Physical	Initiator		
t(0x1)	15	0x010F00	20:03:00:11:0a:10:55:00				SANBlaze T...	N		20:03:00:11:0a:10:55:00	SANBlaze V...	NS		Physical	Target	VM4_Ldom1...	

Figure 3-22. Device Port WWN (Static) for Brocade Switch

Configuring and Verifying FA-BLD

This section provides the following information on fabric-assigned boot LUN discovery (FA-BLD):

- [Configuring FA-BLD from the Adapter](#)
- [Verifying that FA-BLD is Operational](#)
- [Adapter Side Restrictions](#)

Configuring FA-BLD from the Adapter

On the adapter side, follow these procedures to configure fabric-assigned boot LUN discovery (FA-BLD) in the QConvergeConsole GUI and QConvergeConsole CLI.

Enabling Host Bus Adapter Port BIOS and Fabric-assigned Boot LUN with QConvergeConsole GUI

To enable the Host Bus Adapter Port BIOS:

1. In QConvergeConsole GUI, select the **Host** tab in the left pane.
2. In the system tree, expand the adapter node and then select a port node.
3. In the content pane on the right, click the **Parameters** tab.
4. On the Parameters page, click the **HBA Parameters** tab.
5. On the HBA Parameters page, select the **Enable HBA Port BIOS** check box.
6. Click **Save**.

Figure 3-23 shows an example.

The screenshot shows the QConvergeConsole GUI with the 'Parameters' tab selected. The 'Boot Device Selection' sub-tab is active. The main configuration area is titled 'Configure Port General Parameters'. It includes the following fields and options:

- Hostname:** localhost
- Node Name:** 20-00-00-24-FF-8F-D7-F4
- HBA Port:** 1
- HBA Model:** QLE2742
- Port Name:** 21-00-00-24-FF-8F-D7-F4
- Port ID:** 00-00-00

The 'Configure Port General Parameters' section contains:

- Connection Options:** 2 - Loop Preferred, Otherwise Point to Point (dropdown)
- Data Rate:** 32 Gbps (dropdown)
- Frame Size:** 2048 (dropdown)
- Enable HBA Port Hard Loop ID
- Hard Loop ID:** 0 (spin box)
- Loop Reset Delay (seconds):** 5 (spin box)
- Enable HBA Port BIOS
- Enable Fibre Channel Tape Support

At the bottom of the configuration area are two buttons: 'Save' and 'Restore Defaults'.

Figure 3-23. Enabling Host Bus Adapter Port BIOS

To enable fabric-assigned boot LUN:

1. In QConvergeConsole GUI, select the **Host** tab in the left pane.
2. In the system tree, expand the adapter node and then select a port node.
3. In the content pane on the right, click the **Parameters** tab.
4. On the Parameters page, click the **Boot Device Selection** tab.
5. On the Boot Device Selection page, select the **Enable Fabric Assigned Boot LUN** check box.
6. Click **Save**.

Figure 3-24 shows an example.

The screenshot shows the 'Parameters' tab in the QConvergeConsole CLI. The 'Boot Device Selection' sub-tab is active. The configuration details are as follows:

Hostname:	localhost	HBA Model:	QLE2742
Node Name:	20-00-00-24-FF-8F-D7-F4	Port Name:	21-00-00-24-FF-8F-D7-F4
HBA Port:	1	Port ID:	00-00-00

Configure Port Boot Parameters

Selectable Boot

Enable Fabric Assigned Boot LUN

(Primary) Boot Port Name:	00-00-00-00-00-00-00-00	LUN:	0
(Alternate 1) Boot Port Name:	00-00-00-00-00-00-00-00	LUN:	0
(Alternate 2) Boot Port Name:	00-00-00-00-00-00-00-00	LUN:	0
(Alternate 3) Boot Port Name:	00-00-00-00-00-00-00-00	LUN:	0

Buttons: Save, Restore Defaults

Figure 3-24. Enabling Fabric-Assigned Boot LUN

Configuring the Adapter and Boot Devices with QConvergeConsole CLI

To configure adapter and boot devices:

1. In QConvergeConsole CLI, navigate to Adapter Configuration and then select **HBA Parameters**.
2. Enter the port number.
3. Select **Configure HBA Parameters**.
4. Select **Enable BIOS** and set it to **Enable**.
5. In the Adapter Configuration, select **Boot Device Configuration**.
6. Enter the port number.
7. Select **Configure Boot Device(s)**.
8. Set the **Enable Fabric Assign Boot LUN** to **Enable**.
9. Select **Commit Changes**.

Figure 3-25 shows an example of the adapter and boot device configuration.

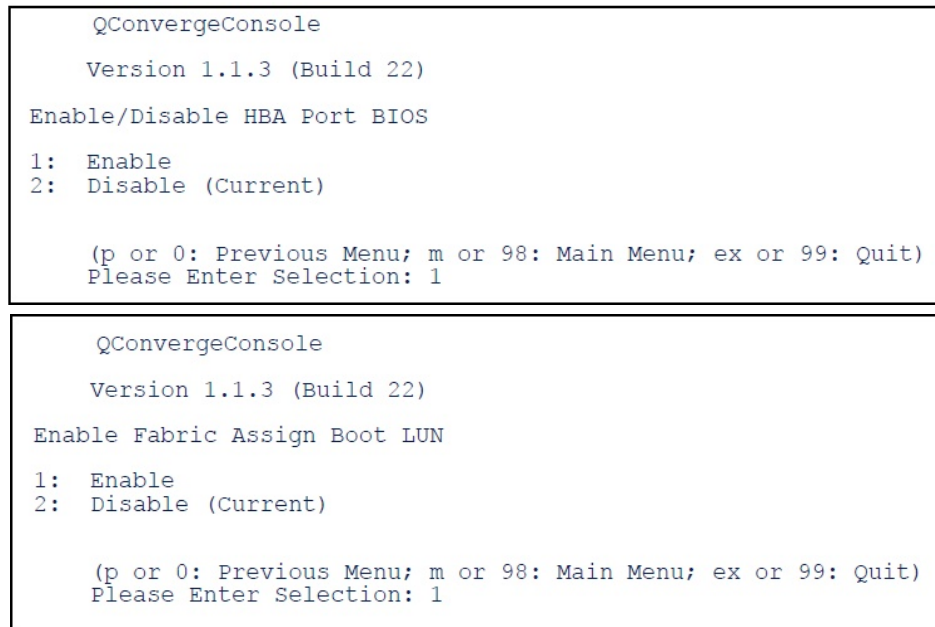

Figure 3-25. Configuring Adapter and Boot Device

Configuring a Zone in a Brocade Switch

To configure a zone in a Brocade switch:

1. Create a boot LUN configuration as follows:

```
bootluncfg --add 50:00:53:37:63:FA:00:05  
20:02:00:11:0d:51:5c:01 0000000000000000
```
2. Create a zone named with the following:
 - Device's PWWN
 - Specific information about the target WWN
 - LUN to be booted from
3. Add a zone to the zoneset configuration as follows:

```
cfgadd config, "BFA_5000533763fa0005_BLUN"
```
4. To save the zoneset, issue the following command:

```
cfigsave
```
5. Enable zoneset configuration to have it actively running:

```
cfigenable config
```

Figure 3-26 shows an example of a configured zone in a Brocade switch.

```
Name of zone contains the PWWN: "BFA_5000533763fa0005_BLUN", and the 4 members of the zone are described as shown below:
1st member      00:00:00:00:                20:02:00:11 [Target's PWWN, first 4 octets]
2nd member      00:00:00:01:                0d:51:5c:01 [Target's PWWN, last 4 octets]
3rd member      00:00:00:02:                00:00:00:00 [Target's LUN, first 4 octets]
4th member      00:00:00:03:                00:00:00:00 [Target's LUN, last 4 octets]

zonecreate "BFA_5000533763fa0005_BLUN", "00:00:00:00:20:02:00:11; 00:00:00:01:0d:51:5c:01;
00:00:00:02:00:00:00:00; 00:00:00:03:00:00:00:00"
```

Figure 3-26. Configuring a Zone in a Brocade Switch

Verifying that FA-BLD is Operational

To verify if the FA-BLD is operational, use either *Fast!UTIL* or the system.

Figure 3-27 shows *Fast!UTIL* displaying the boot LUN.

```
QLE2672 PCI3.0 Fibre Channel ROM BIOS Version 3.24
Copyright (C) QLogic Corporation 1993-2013. All rights reserved.
www.qlogic.com

Press <CTRL-Q> or <ALT-Q> for Fast!UTIL

BIOS for Adapter 0 is disabled
Firmware Version 7.04.00

<CTRL-Q> Detected, Initialization in progress, Please wait...

Device Device Adapter Port Lun Vendor Product Product
Number Type Number ID Number ID ID ID Revision
Disk 1 010B01 0 SANBlaze QLUN P2T1L0 U6.3
ROM BIOS Installed
```

Figure 3-27. Verifying FA-BLD with Fast!UTIL

Figure 3-28 shows using the system with a LUN ready to install or OS booted from LUN.

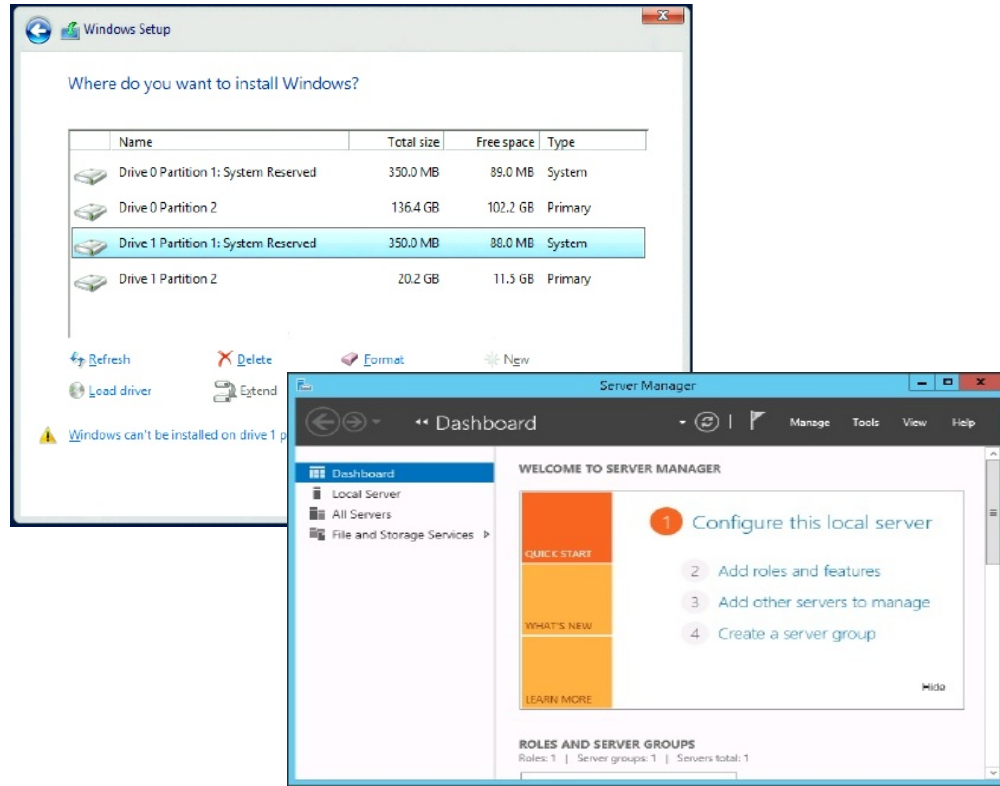

Figure 3-28. Verifying FA-BLD from the System

Adapter Side Restrictions

The known fabric-assigned port world wide name (FA-PWNN) and FA-BLD restrictions include the following:

- Cannot be fully enabled from *Fast!UTIL*
- Do not use **Restore Defaults** from *Fast!UTIL*, *QConvergeConsole* GUI, or *QConvergeConsole* CLI. Doing so causes these capabilities to become disabled.

Using a Fabric-Assigned Boot LUN

This section describes how to use a fabric-assigned boot LUN in the following utilities:

- [Using a Fabric-Assigned Boot LUN in QConvergeConsole GUI](#)
- [Using a Fabric-Assigned Boot LUN in Interactive QConvergeConsole CLI](#)
- [Using a Fabric-Assigned Boot LUN with Noninteractive QConvergeConsole CLI](#)
- [Using a Fabric-Assigned Boot LUN with QConvergeConsole Plug-ins](#)

Using a Fabric-Assigned Boot LUN in QConvergeConsole GUI

For details about how to use a fabric-assigned LUN in QConvergeConsole GUI, refer to the “Fabric-Assigned Boot LUN” topic in the *QConvergeConsole Help*.

Using a Fabric-Assigned Boot LUN in Interactive QConvergeConsole CLI

To use a fabric-assigned boot LUN with interactive QConvergeConsole CLI:

1. From the main menu, select the adapter type (**Fibre Channel Adapter**).
2. On the **Fibre Channel Adapter Configuration** menu, select **Boot Devices Configuration**.
3. On the **Boot Device Settings** menu, select **Configure Boot Device(s)**, and then press the ENTER key.
4. Select **Enable Fabric Assigned Boot LUN**, and then press ENTER.
5. On the **Enable Fabric Assign Boot LUN** menu, type **1** to enable this feature.

Using a Fabric-Assigned Boot LUN with Noninteractive QConvergeConsole CLI

In noninteractive QConvergeConsole CLI, set a target as the fabric-assigned boot LUN for a specific adapter by issuing the following command:

```
# qaucli -pr fc -e <hba instance>|<hba wwpn> enable|disable  
FabricAssignBootLUN|fb
```

Where:

```
hba instance = Adapter number (use the -g command to find)  
hba wwpn = Worldwide port name of the adapter  
FabricAssignBootLUN or fb = Configure enable fabric-assigned boot LUN setting
```

Using a Fabric-Assigned Boot LUN with QConvergeConsole Plug-ins

For information about using a fabric-assigned boot LUN for QConvergeConsole VMware vSphere Web Client Plug-in, see the section “Configure Fibre Channel Port Boot Parameters” in the *User’s Guide—QConvergeConsole Plug-ins for VMware vSphere* (part number SN0054677-00).

To configure a 2700 Series Adapter boot device with QConvergeConsole VMware vCenter Server Plug-in:

1. In the QConvergeConsole VMware vCenter Server Plug-in, click the **QConvergeConsole** tab.
2. In the tree pane on the left, select a 2700 Series Adapter port.
3. Click the **Boot** tab.
4. On the Boot Device Selection page, select the **Enable Fabric Assigned Boot LUN** check box. [Figure 3-29](#) shows an example.

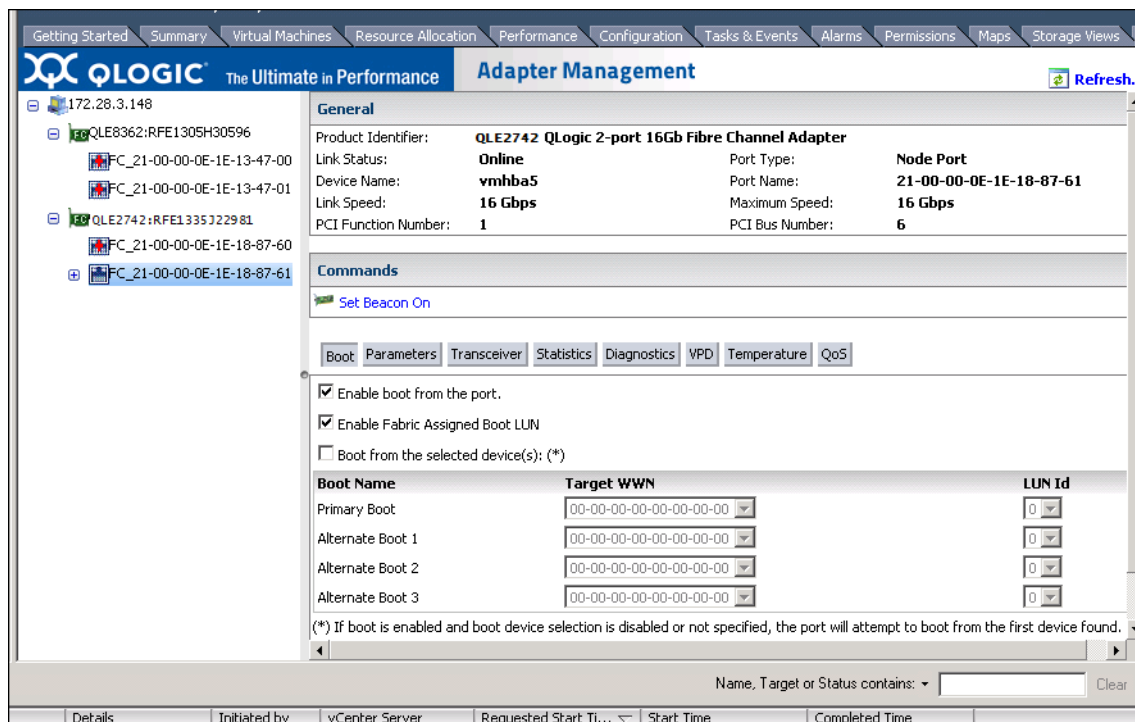

Figure 3-29. Fabric-Assigned Boot LUN in QConvergeConsole VMware vCenter Server Plug-in

For details, refer to the “Boot Device Selection” topic in *QConvergeConsole Help*.

5. Click **Save**. Any previously saved configuration for the current 2700 Series Adapters is overwritten.

Running Diagnostics—Fibre Channel Ping and Trace Route

This section provides the following information on how to run Fibre Channel ping and trace route diagnostics:

- [Pinging and Viewing Trace of Routing Using Topology Map](#)
- [Running a Fibre Channel CT Ping Test](#)
- [Fibre Channel Trace Route](#)

Pinging and Viewing Trace of Routing Using Topology Map

The QConvergeConsole GUI topology map uses the common transport (CT) layer to enable the adapter's initiator port to ping or run a trace route that will navigate across the environment through multiple ports of the switch or switches and to the target.

[Table 3-8](#) compares the differences between the Ping Test, CT Ping Test, and the CT FTR Tests.

Table 3-8. Ping Test, CT Ping Test, and CT FTR Test

Ping Test	CT Ping Test	CT FTR Test
SCSI layer ping	CT or Fibre Channel ping	CT or Fibre Channel trace route
Uses SCSI inquiry command	Uses echo through an external link	Requires scan of physical topology
Can operate on any SCSI device	Can operate with all Fibre Channel devices that support CT or an external link	Can operate with all devices that are connected through a port that supports CT or an external link

Supported configurations for Fibre Channel ping and trace route include:

- QLogic 2700 Series Adapters
- Brocade Switches with Based Fabric OS® (FOS) v6.0.0a
- Cisco® Switches with NX-OS v8.3.1 (FC Trace Route not supported)

NOTE

The switch and the Fibre Channel end device must both support the Fibre Channel ping and trace route feature. See [Table 3-11 on page 96](#) for the supported Fibre Channel software version.

Running a Fibre Channel CT Ping Test

You can run a Fibre Channel CT ping test from QConvergeConsole GUI, QConvergeConsole CLI, or the QConvergeConsole VMware plug-ins, as described in this section.

Running a Fibre Channel CT Ping from QConvergeConsole GUI

To run a Fibre Channel CT ping test from QConvergeConsole GUI:

1. In the QConvergeConsole GUI left pane, click the **Host** tab.
2. On the Host page, expand the adapter node and then select a port.
3. In the content pane on the right, click the **Diagnostics** tab.
4. On the Diagnostics page, click the **General Diagnostics** tab.
5. On the General Diagnostics page (see [Figure 3-30](#)), complete the **Test Configuration** options, and then click **CT Ping Test** to start the test.

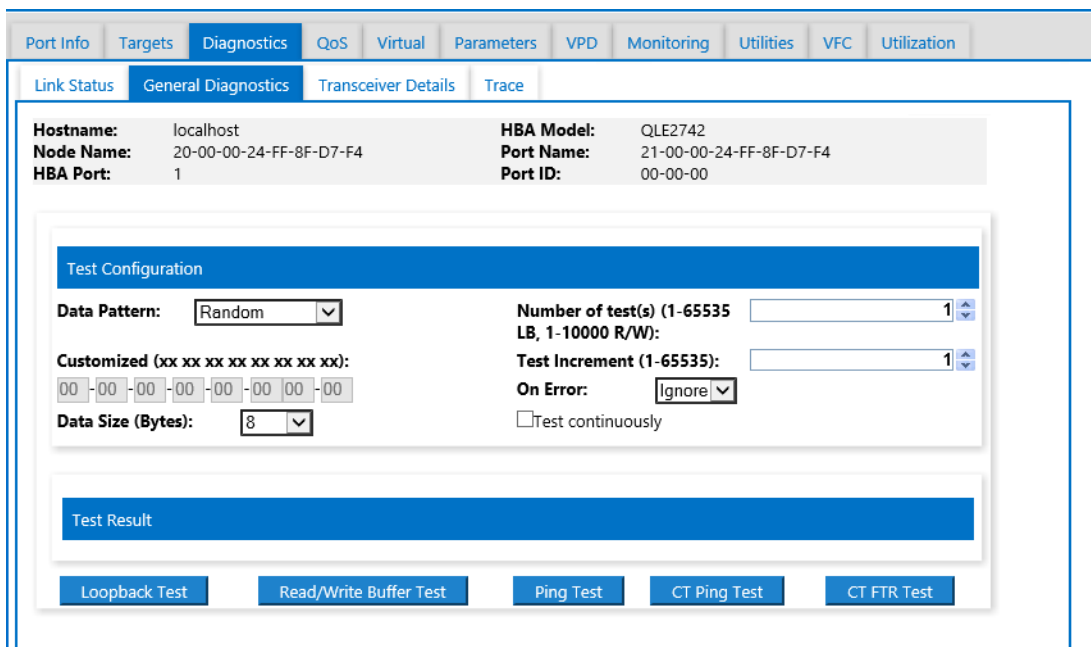

Figure 3-30. Running the Fibre Channel CT Ping Test

A caution message appears for the diagnostic CT ping test (Figure 3-31).

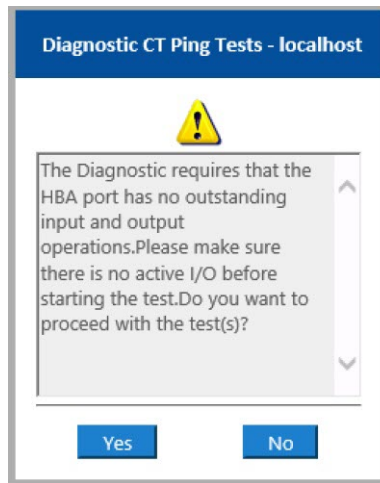

Figure 3-31. CT Ping Test Caution

6. Ensure that the port has no active I/O operations, and then either click **Yes** to proceed or **No** to cancel the test.

Running a Fibre Channel CT Ping from QConvergeConsole CLI

To run a Fibre Channel CT ping test from QConvergeConsole CLI:

1. From the QConvergeConsole CLI **FC Diagnostics** menu, select **7: CT Ping Test**.
2. From the **HBA Model** list, select the port that you want to ping.
3. From the **CT Ping Test** menu, select **4: Start Diagnostic Test**.

The following shows example output from the CT ping test.

```
-----  
Diagnostics Test Configuration  
-----
```

```
Diagnostic Mode           : CT Ping  
Number of tests (1-10000) : 10  
Number of Pass           : 1  
Test Increment (1-10000) : 1  
Abort On Error           : Ignore  
Test Continuous          : OFF  
-----
```

ID Port/Loop	Data Miscompare	Link Failure	Sync Loss	Signal Loss	Invalid CRC	Diagnostic Status
01-0B-01	0	0	0	0	0	Success

NOTE

The default setting will repeat 10 times with output similar to the preceding for each pass of the test.

Running a Fibre Channel CT Ping from QConvergeConsole VMware Plug-ins

For information about running Fibre Channel CT ping from the QConvergeConsole VMware vCenter Server Plug-in or QConvergeConsole VMware vSphere Web Client Plug-in, see the section “Diagnostic Tests—Fibre Channel Port” in the *User’s Guide—QConvergeConsole Plug-ins for VMware vSphere* (part number SN0054677-00).

Fibre Channel Trace Route

To run a Fibre Channel trace route from QConvergeConsole GUI:

1. In the system tree pane on the left, click the **Host** tab.
2. In the content pane on the right, click the **Topology** tab.
3. Next to **Topology**, select the **Physical** option.
4. In the topology map, right-click the applicable adapter.
5. Select the **FC Trace Route** option.
6. In the Target Selection dialog box, select the target to run the trace route.
7. Click **Trace**.

Figure 3-32 shows an example.

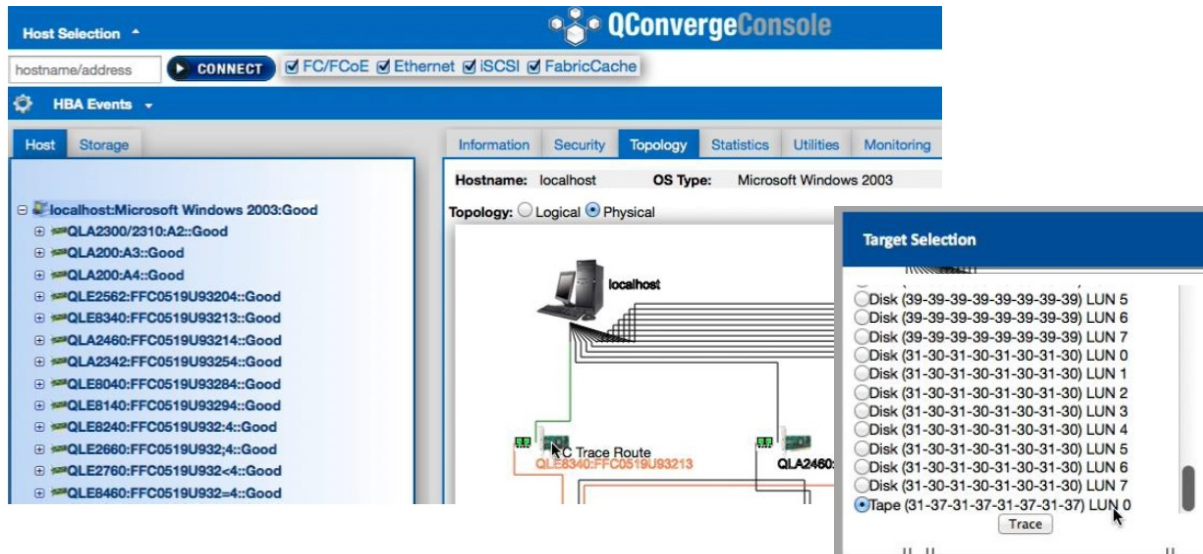

Figure 3-32. Running Fibre Channel Trace Route from QConvergeConsole GUI

The Fibre Channel trace route output from QConvergeConsole GUI shows a symbol of a red payload that starts from the host. The travel across the route is also highlighted in red. The payload enters and exits from the appropriate port on each switch as it traverses the path until it reaches the selected target.

The results appear as a success message output from the following:

- QConvergeConsole GUI
- QConvergeConsole CLI
- Diagnostics area

NOTE

You can also execute the CT FTR test.

For information about using Fibre Channel trace route in QConvergeConsole VMware vCenter Server Plug-in or QConvergeConsole VMware vSphere Web Client Plug-in, see the section “Diagnostic Tests—Fibre Channel Port” in the *User’s Guide—QConvergeConsole Plug-ins for VMware vSphere* (part number SN0054677-00).

Configuring CS_CTL QoS

NOTE

For information about **end-to-end** CS_CTL QoS, see [“Configuring End-to-End CS_CTL QoS” on page 87](#).

This section provides the following information on class-specific control (CS_CTL) quality of service (QoS):

- [CS_CTL QoS Features](#)
- [Enabling CS_CTL QoS Mode for the Initiator and Target Ports](#)
- [Verifying and Confirming CS_CTL Mode Setup for Each Port](#)
- [Creating a Virtual Port from the Adapter’s Port in QConvergeConsole GUI](#)
- [Setting the QoS Priority Level for a Virtual Port in QConvergeConsole GUI](#)

CS_CTL QoS Features

The following highlights some of the features of the CS_CTL QoS:

- Traffic priority classification for QLogic Gen 6 Fibre Channel SAN. QoS at the packet level is realized by using the CS_CTL field, which is specified in the FC-FS-2 specification. QoS allows one to prioritize frames between a host and target, depending on the value of the CS_CTL field in the FC Frame header.
- Extending QoS from the fabric to the host
- Enables QLogic Fibre Channel users to rapidly scale server virtualization without compromising service-level agreements
- Benefits for both physical and virtual server deployments
- Supported configuration:
 - QLogic 2700 Series Adapters
 - CS_CTL-based QoS is end-to-end (requires target to support CS_CTL)

Enabling CS_CTL QoS Mode for the Initiator and Target Ports

Figure 3-33 shows how to enable CS_CTL QoS mode for the initiator and target ports.

```
portdisable 17
portcfgqos --enable 17 csctl_mode
Enabling CSCTL mode flows causes QoS zone flows to lose priority on such ports.
Do you want to proceed?(y/n):y
portenable 17

portdisable 0
portcfgqos --enable 0 csctl_mode
Enabling CSCTL mode flows causes QoS zone flows to lose priority on such ports.
Do you want to proceed?(y/n):y
portenable 0
```

Figure 3-33. Enabling CS_CTL QoS Mode

Verifying and Confirming CS_CTL Mode Setup for Each Port

Figure 3-34 shows how to verify the CS_CTL mode setup for each port.

```
portcfgshow
Ports of Slot 0      0  1  2  3  4  5  6  7  8  9 10 11 12 13 14 15
-----+-----+-----+-----+-----+-----+-----+-----+-----+-----+-----+-----+-----+-----+-----+-----+-----+
Octet Speed Combo  1  1  1  1  1  1  1  1  1  1  1  1  1  1  1  1
<ONLY PARTIAL OUTPUT SHOWN BELOW FOR THE APPROPRIATE AREA TO CHECK ON PORT 0 >

CSCTL mode          ON  ..  ..  ..  ..  ..  ..  ..  ..  ..  ..  ..  ..  ..  ..  ..
```

Figure 3-34. CS_CTL Mode Setup for Each Port

Creating a Virtual Port from the Adapter’s Port in QConvergeConsole GUI

To create a virtual port in QConvergeConsole GUI:

1. In the QConvergeConsole GUI content pane on the left, select the **Host** tab.
2. On the Host page, expand the adapter node, and then select a port.
3. In the content pane on the right, select the **Virtual** tab.
4. On the Virtual page under **Create New Virtual Port**, specify the **Number of vPort to create**, and then click **Update**.
5. Click **Create**.

Figure 3-35 shows how to create a virtual port from the adapter's port in QConvergeConsole GUI.

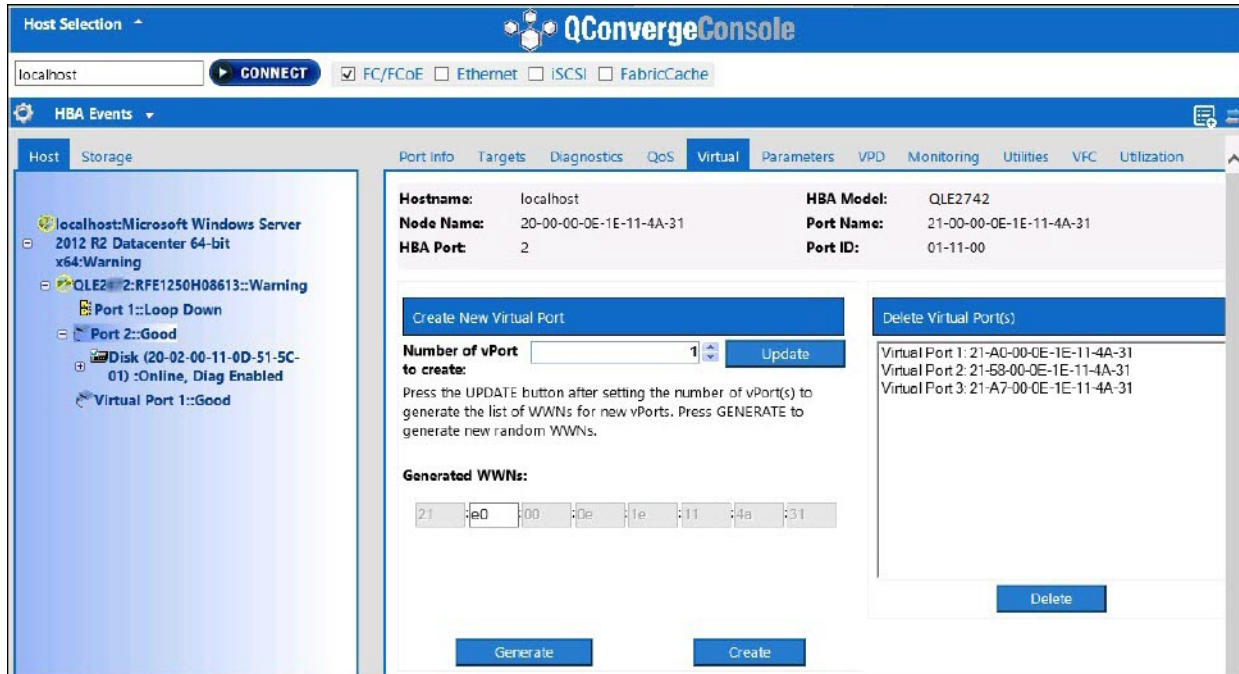

Figure 3-35. Creating a Virtual Port

Setting the QoS Priority Level for a Virtual Port in QConvergeConsole GUI

Figure 3-36 shows how to set the QoS priority level for a virtual port in QConvergeConsole GUI.

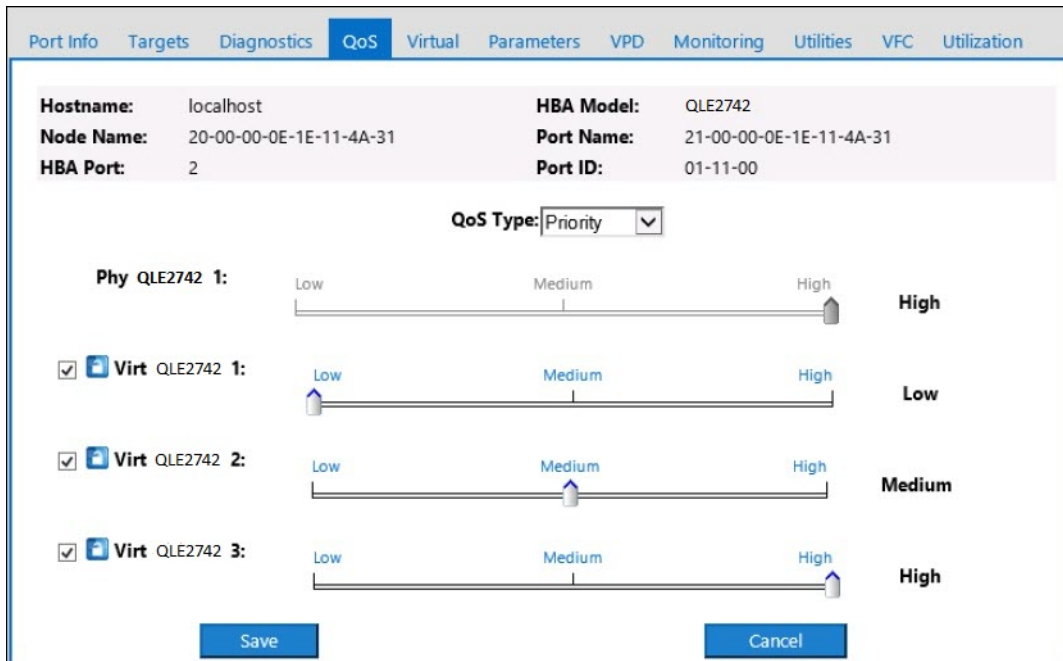

Figure 3-36. Setting the QoS Priority Level

NOTE

By default, the QoS of the physical port is set to **High**, and the QoS of the virtual port is set to **Low**.

Configuring End-to-End CS_CTL QoS

NOTE

For information about CS_CTL QoS that is not end-to-end, see [“Configuring CS_CTL QoS” on page 84](#).

QLogic’s class specific control (CS_CTL) QoS implementation is an end-to-end solution, encompassing the initiator (2700 Series Adapters), the switches, and the target (storage). The 2700 Series Adapter stamps the priority value (high, medium, low) in the CS_CTL field of the Fibre Channel frame. All three entities (initiator, switch, and target) honor this priority value at their respective levels.

Therefore, when all three entities support QoS (and it is enabled on the switch and the target), a default priority value is populated in all FCP_CMND, FCP_DATA, FCP_XFER_RDY, FCP_RSP, and FCP_CONFIRM frames.

NOTE

QoS must be supported by both the switch and target devices.
At the time of publication, CS_CTL QoS has been tested only on the Brocade SW6510 switch with Fabric OS (FOS) version 7.3.0a.

The following sections describe how to configure end-to-end CS_CTL QoS and change the default priority levels:

- [Configuring CS_CTL QoS on the Switch](#)
- [Configuring CS_CTL QoS on the Storage Device](#)
- [Changing the QoS Priority Levels](#)

Configuring CS_CTL QoS on the Switch

To enable CS_STL QoS on the Brocade SW6510 switch:

1. From the switch, issue the following command:

```
root> configurechassis  
Configure...
```

2. A list of attributes appear one at a time. After either accepting the default or entering a different value, the next attribute appears.

- Press ENTER to accept the default for `cfgload` attributes, Custom attributes, and system attributes.
- Type **y** for `fos` attributes.
- Type **1** for CSCTL QoS Mode.

For example:

```
cfgload attributes (yes, y, no, n): [no]  
Custom attributes (yes, y, no, n): [no]  
system attributes (yes, y, no, n): [no]  
fos attributes (yes, y, no, n): [no] y  
CSCTL QoS Mode (0 = default; 1 = auto mode): (0..1) [0] 1
```

3. Reboot the switch.
4. To verify that CS_CTL QoS is enabled, issue the following command:

```
root> configshow -all | grep fos.csctlMode
```

This command should return the following response:

```
fos.csctlMode:1
```

5. To enable QoS on a switch-port basis, issue the following command:

```
portcfgqos --enable [slot/]port csctl_mode
```

Configuring CS_CTL QoS on the Storage Device

See your device's user guide for QoS configuration instructions.

Changing the QoS Priority Levels

The QoS priority levels are set in the 2700 Series Adapters vPorts. The Windows and VMware adapter drivers assign default vPort priority levels. The following sections describe how to change the default vPort priority levels in Windows and VMware ESXi systems.

Changing the Priority Levels in Windows

To change the vPort priority levels in Windows, you must first assign the vPorts, and then change the priority levels. Both procedures can be accomplished using either QConvergeConsole GUI or interactive QConvergeConsole CLI, as described in the following sections.

For more detailed information, see the *QConvergeConsole Help* and the *User's Guide—QConvergeConsole CLI* (part number SN0054667-00).

Creating a vPort

To create a vPort in QConvergeConsole GUI:

1. In the QConvergeConsole GUI left pane, connect to the host that has the 2700 Series Adapters where you want to create the vPorts.
2. Expand the host in the left pane by clicking the plus sign (+).
3. Locate and expand the 2700 Series Adapters where you want to create the vPorts.
4. In the right pane, click the **Virtual** tab.
5. Enter a valid value for the **Number of vPort to create** option, and then click **Update**.
6. To create the vPorts, click **Create**.

Figure 3-37 shows an example.

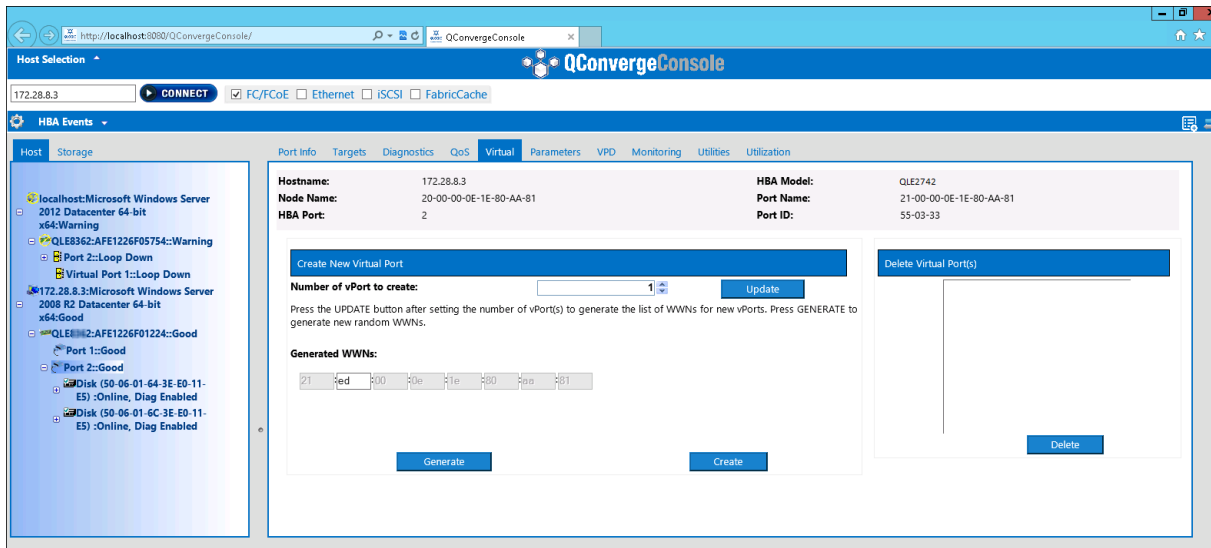

Figure 3-37. Creating vPorts in QConvergeConsole GUI

To create a vPort in interactive QConvergeConsole CLI:

1. On the **Main Menu**, select **Adapter Configuration**.
2. On the **Adapter Type Selection** menu, select **Virtual Ports (NPIV)**.
3. On the **Virtual Ports** menu, select **Adapter Port**.
4. On the **Adapter Port** menu, select **Create vPorts**.
5. On the **Create vPorts** menu, select **Generate**.
6. To create the vPorts, select **Commit**.

Changing the vPort Priority Level

To change the vPort priority level using QConvergeConsole GUI:

1. In the QConvergeConsole GUI left pane, connect to the host that contains the 2700 Series Adapter whose vPort levels you want to change.
2. Expand the host in the left pane by clicking the plus sign (+).
3. Locate and expand the 2700 Series Adapter whose vPort levels you want to change.
4. In the right pane, click the **QoS** tab.
5. In the **QoS Type** box, select **Priority**.
6. Ensure that the check box for the vPort you want to change is selected.
7. Set the QoS priority value for the vPort by moving the corresponding slider.

- Repeat [Step 6](#) and [Step 7](#) for each vPort whose priority you want to change.
- Click **Save**. [Figure 3-38](#) shows an example.

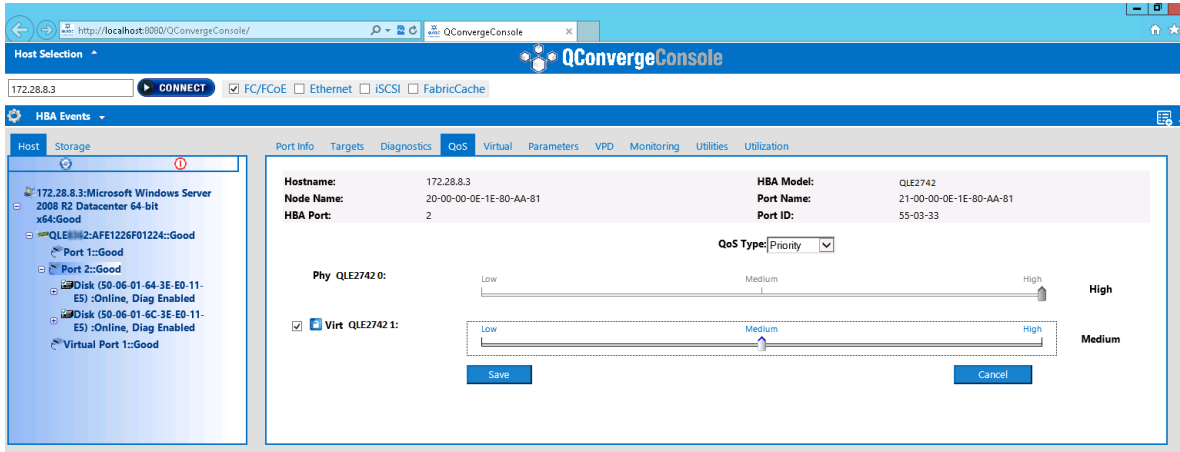

Figure 3-38. Changing vPort Priority using QConvergeConsole GUI

To change the vPort priority level using interactive QConvergeConsole CLI:

- On the **Main Menu**, select **Adapter Configuration**.
- On the **Adapter Type Selection** menu, select **QoS**.
- On the **QoS** menu, select **Adapter Port**.
- On the **Adapter Port** menu, select **QoS Priority**.
- On the **QoS Priority** menu, select **Modify QoS Settings**.
- Choose the priority value for the vPorts.
- Select **Apply QoS**.

Changing the Priority Levels in VMware ESXi

To change the priority levels using QConvergeConsole VMware vCenter Server Plug-in or QConvergeConsole VMware vSphere Web Client Plug-in:

- In the tree pane on the left, select a host.
- Expand the host in the left pane by clicking the plus sign (+).
- Locate and expand the 2700 Series Adapter whose priority levels you want to change.
- Select a port in the 2700 Series Adapter.
- On the content pane on the right, click **QoS**.

6. Set the vPort priority as follows:
 - If the vPort is listed under **QoS**:
 - a. Select the vPort.
 - b. Set the QoS priority value for the vPort by moving the corresponding slider.
 - c. Click **Save**.

Figure 3-39 shows an example.

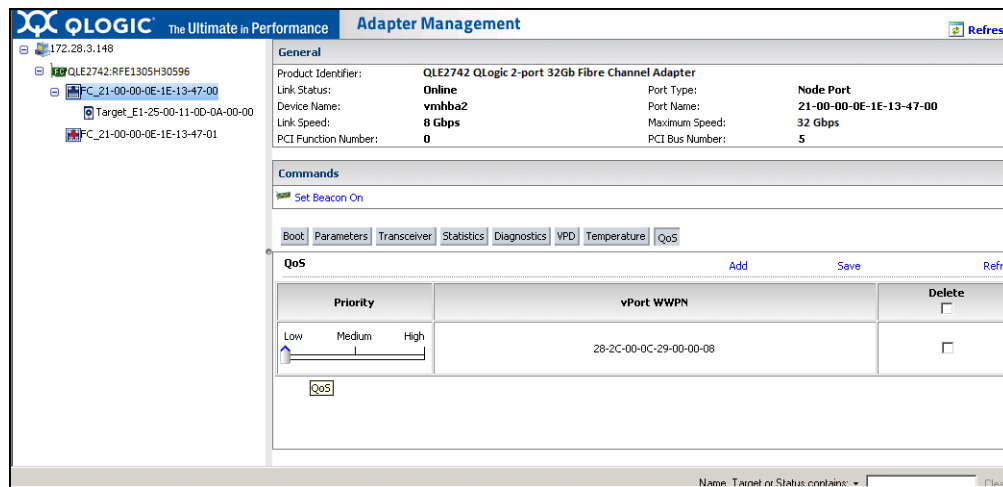

Figure 3-39. Changing vPort Priority Using QConvergeConsole Plug-ins

- If vPort is *not* listed under **QoS**:
 - a. Under **QoS**, click **Add**.
 - b. Set the QoS priority value by moving the corresponding slider.
 - c. Enter the vPort WWPN.
 - d. Click **Save**.
7. Click **Refresh** to see the new QoS settings.

To remove a vPort priority:

1. Under **QoS**, locate the vPort whose priority you want to remove.
2. Do one of the following:
 - Select the **Delete** check box of the vPort you want to remove.
 - Select the **Delete** check box in the header to select or clear all of the vPorts.
3. Click **Save**.

Configuring FDMI

The fabric device management interface (FDMI) enables the centralized management of devices such as host adapters. Supported configuration for FDMI:

- QLogic 2700 Series Adapters
- Brocade 16G and 32G switches with Fabric OS (FOS) v7.3 or later
- Cisco 16G and 32G switches with NX-OS v8.3.1 or later

NOTE

Results can be viewed from Switch CLI. If the Fibre Channel switch does not support FDMI-2, it falls back to FDMI-1 support.

This section provides the following information on the FDMI:

- [Brocade Switch FOS CLI](#)
- [Fabric Features](#)
- [FDMI Enhancements Support](#)

Fabric Features

Table 3-9 shows the default configuration for Brocade Fibre Channel fabric features.

Table 3-9. Brocade Fibre Channel Fabric Features—Default Configuration

Feature	Description	Management Tools	Default Configuration
D_Port	Diagnostics port support	N/A	Diagnostic test; run from switch. Nothing to configure on adapter.
FA-PWWN	Fabric-assigned port world wide name	QConvergeConsole GUI QConvergeConsole CLI QConvergeConsole VMware vCenter Server Plug-in	Disabled by default on adapter. Must be enabled in NVRAM.
F-BLD	Fabric-based boot LUN discovery	QConvergeConsole GUI QConvergeConsole CLI QConvergeConsole VMware vCenter Server Plug-in	No default setting. Requires configuration on adapter.
FC Ping	Ping a Fibre Channel N_Port or end device	QConvergeConsole GUI QConvergeConsole CLI QConvergeConsole VMware vCenter Server Plug-in	Diagnostic test; nothing to configure.
FC Trace Route	Obtains the path information between two F_Ports from the Fabric Configuration Server	QConvergeConsole GUI QConvergeConsole CLI QConvergeConsole VMware vCenter Server Plug-in	Diagnostic test; nothing to configure.
QoS CS_CTL	Prioritize frames depending on the value of the CS_CTL field in the FC Frame header	QConvergeConsole GUI QConvergeConsole CLI QConvergeConsole VMware vCenter Server Plug-in	By default, QoS of the physical port is set to High .
FDMI Enhancements	FDMI attributes	N/A	Nothing to configure on adapter.

Table 3-10 shows the default configuration for Cisco Fibre Channel fabric features.

Table 3-10. Cisco Fibre Channel Fabric Features—Default Configuration

Feature	Description	Management Tools	Default Configuration
D_Port	Diagnostics port support	N/A	Diagnostic test; run from switch. Nothing to configure on adapter.
FC Ping	Ping a Fibre Channel N_Port or end device	QConvergeConsole GUI QConvergeConsole CLI QConvergeConsole VMware vCenter Server Plug-in	Diagnostic test; nothing to configure.
FDMI Enhancements	FDMI attributes	N/A	Nothing to configure on adapter.

Table 3-11 lists the minimum Dell software version of the Fibre Channel fabric features for both Brocade and Cisco.

Table 3-11. Fibre Channel Fabric Features, Software Version

Component	Dell Software Version
Firmware	v15.00.00
Windows Driver	v 9.3.2.20
ESXi Driver	ESXi 6.0 U3: v 2.1.81.0-1
Linux Driver	v 8.08.00.08
QConvergeConsole GUI	v 5.5.0.53
QConvergeConsole CLI	v 2.3.00.11

FDMI Enhancements Support

FDMI enables the management of devices such as host adapters. Enabling additional attributes using FDMI provides you with detailed information about the QLogic adapters through a centralized management entity such as the Fibre Channel fabric switches.

```
ROM Ver           :3.62
Firmware Ver      :8.08.03 (d0d5)
  Port-id: 21:00:00:24:ff:8f:d8:88
    Supported FC4 types:scsi-fcp
    Supported Speed   :8G 16G 32G
    Current Speed     :32G
Maximum Frame Size :2048
  OS Device Name     :qla2xxx:host1
  Host Name          :localhost.localdomain
```

Enabling QLogic Forward Error Correction

QConvergeConsole supports the forward error correction (FEC) feature, which is a correction technique used for high-speed telecommunications devices to control errors in data transmission over unreliable or noisy communication channels.

FEC is mandatory when operating at 32Gb line rate. Gen 6, 32Gb-capable adapters are required to support it, and FEC is automatically enabled when operating at 32G. If the 32G-capable adapter is operating at 16G, enabling FEC is optional, just as it is on QLE269x-DEL adapters.

NOTE

The switch and the Fibre Channel end device must both support the FEC feature. See [Table 3-11 on page 96](#) for the supported Fibre Channel software version.

FEC Process Overview

The following highlights how the FEC process works between the transmitting and receiving device:

1. Transmitter Device:
 - a. Takes the incoming data stream.
 - b. Inserts a redundant amount of parity bits of information on the data stream.
 - c. Sends the data stream.
2. Receiving Device:
 - a. Receives the data stream.
 - b. Checks for missing or corrupt data:
 - If there are no corrupt or missing bits of information, the receiving device proceeds with normal process.

- If there are corrupt or missing bits of information, the receiving device reconstructs the original data by using pieces of the original data stream (that are still intact) and combining those with the parity bits of information.

NOTE

Instead of having to request retransmission of the entire data frame, the receiving device can recreate or reconstruct the data stream itself. This process prevents multiple CRC errors from being triggered and causing application performance issues.

Enabling QLogic FEC

To enable the QLogic FEC feature, submit a case to Technical Support at www.marvell.com, **Support**, or refer to the QLogic document, *Application Note: Enabling Forward Error Correction*, (part number 83830-514-03).

NOTE

At 32Gbps, FEC is mandatory and enabled, and does not require any user configuration. At 16Gbps, FEC is optional and does require user configuration. At 8Gbps, FEC is not supported.

In [Figure 3-41](#), the QConvergeConsole CLI interactive mode **Adapter Information** menu shows a port with an online FEC status.

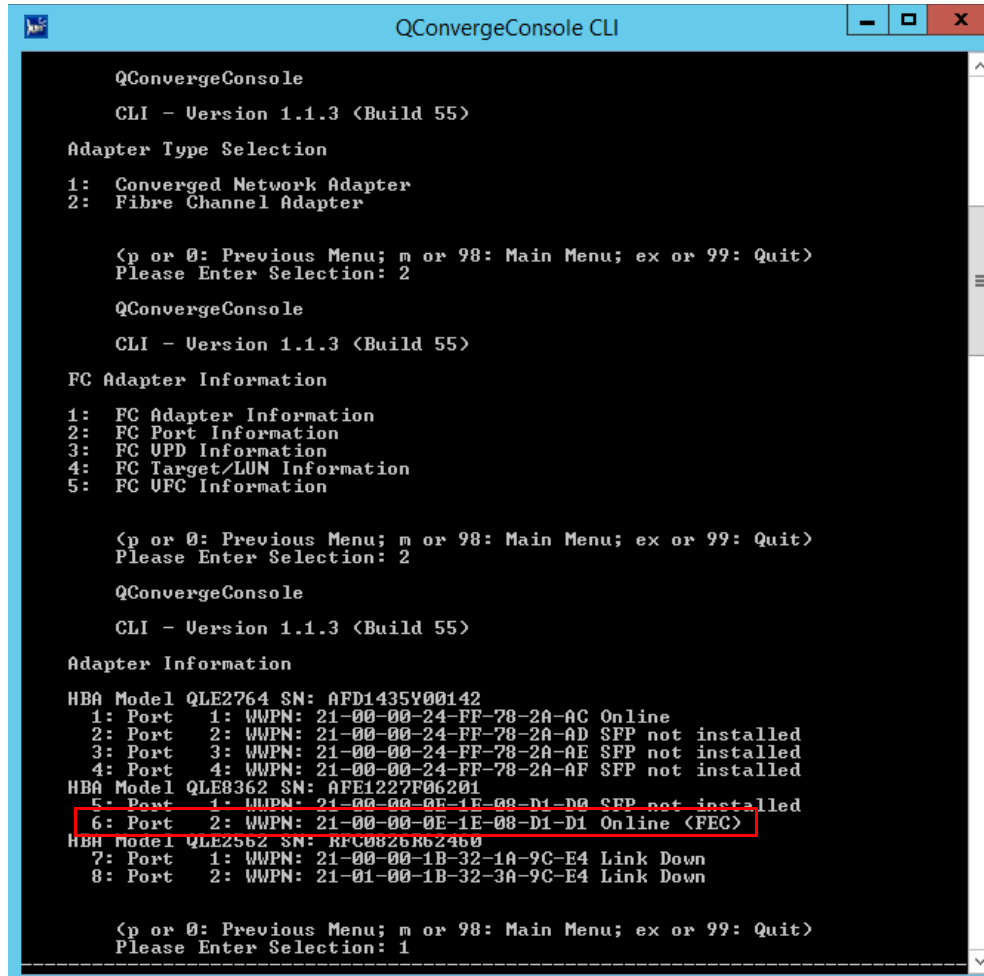

```
QConvergeConsole
CLI - Version 1.1.3 <Build 55>

Adapter Type Selection
1: Converged Network Adapter
2: Fibre Channel Adapter

<p or 0: Previous Menu; n or 98: Main Menu; ex or 99: Quit>
Please Enter Selection: 2

QConvergeConsole
CLI - Version 1.1.3 <Build 55>

FC Adapter Information
1: FC Adapter Information
2: FC Port Information
3: FC UPD Information
4: FC Target/LUN Information
5: FC UFC Information

<p or 0: Previous Menu; n or 98: Main Menu; ex or 99: Quit>
Please Enter Selection: 2

QConvergeConsole
CLI - Version 1.1.3 <Build 55>

Adapter Information
HBA Model QLE2764 SN: AFD1435V00142
1: Port 1: WWPNN: 21-00-00-24-FF-78-2A-AC Online
2: Port 2: WWPNN: 21-00-00-24-FF-78-2A-AD SFP not installed
3: Port 3: WWPNN: 21-00-00-24-FF-78-2A-AE SFP not installed
4: Port 4: WWPNN: 21-00-00-24-FF-78-2A-AF SFP not installed
HBA Model QLE8362 SN: AFE1227F06201
5: Port 1: WWPNN: 21-00-00-0E-1E-08-D1-D0 SFP not installed
6: Port 2: WWPNN: 21-00-00-0E-1E-08-D1-D1 Online <FEC>
HBA Model QLE2562 SN: RFC0826R62460
7: Port 1: WWPNN: 21-00-00-1B-32-1A-9C-E4 Link Down
8: Port 2: WWPNN: 21-01-00-1B-32-3A-9C-E4 Link Down

<p or 0: Previous Menu; n or 98: Main Menu; ex or 99: Quit>
Please Enter Selection: 1
```

Figure 3-41. QConvergeConsole CLI Adapter Information Menu, FEC Status

Running Extended Link Service Commands

Commands for extended link service on the switch include the following:

- [Link Cable Beacon Extended Link Service Command](#)
- [Read Diagnostic Parameters Extended Link Service Command](#)

Link Cable Beacon Extended Link Service Command

NOTE

Run the LCB test only from a switch with either FOS version 7.4.x or later, or Cisco NX-OS 8.3.1 or later.

The link cable beacon (LCB) extended link service command locates the corresponding ends of a cable by flashing the specific LEDs on the corresponding ports of a link. The LCB command can also be sent through a Brocade switch using the following commands, which show examples of enabling, disabling, or verifying the LCB:

```
SW6505:admin> portpeerbeacon --enable 12
SW6505:admin> portpeerbeacon --show -all
portPeerBeacon is enabled on port :12
SW6505:admin> portpeerbeacon --disable 12
```

Read Diagnostic Parameters Extended Link Service Command

NOTE

You must run the RDP test from a switch with either FOS version 7.4.x or later, or Cisco NX-OS 8.3.1 or later.

The following example shows the read diagnostic parameters extended link service (RDP ELS) command output for Port 13 on a Brocade 16G switch:

```
SW6505:admin> sfps show 13 -link -force
Identifier: 3      SFP
Connector: 7      LC
Transceiver: 7004404000000000 8,16,32_Gbps M5 sw Short_dist
Encoding: 6       64B66B
Baud Rate: 140    (units 100 megabaud)
Length 9u: 0      (units km)
Length 9u: 0      (units 100 meters)
Length 50u (OM2): 3      (units 10 meters)
Length 50u (OM3): 0      (units 10 meters)
Length 62.5u: 0     (units 10 meters)
Length Cu: 0      (units 1 meter)
Vendor Name: HP-F      BROCADE
Vendor OUI: 00:05:1e
```

3-Fibre Channel Configuration

Running Extended Link Service Commands

```

Vendor PN:    QK724A
Vendor Rev:   A
Wavelength:  850  (units nm)
Options:     003a Loss_of_Sig,Tx_Fault,Tx_Disable
BR Max:      0
BR Min:      0
Serial No:   HAF314370000B7F
Date Code:   140909
DD Type:     0x68
Enh Options: 0xfa
Status/Ctrl: 0x30
Pwr On Time: 0.30 years (2666 hours)
E-Wrap Control: 0
O-Wrap Control: 0
Alarm flags[0,1] = 0x0, 0x0
Warn Flags[0,1] = 0x0, 0x0

```

		Alarm		Warn	
		low	high	low	high
Temperature:	60 Centigrade	-5	85	0	75
Current:	8.430 mAmps	2.500	12.000	2.000	11.500
Voltage:	3322.2 mVolts	3000.0	3600.0	3100.0	3500.0
RX Power:	-3.1 dBm (495.3uW)	31.6 uW	1258.9 uW	31.6 uW	794.3 uW
TX Power:	-3.2 dBm (481.6 uW)	125.9 uW	1258.9 uW	251.2 uW	794.3 uW

```

State transitions: 5
Port Speed Capabilities      8Gbps 16Gbps 32Gbps

```

PEER Port Gbic Info

```

Laser Type:      Short Wave Laser
SFP Type:        Optical Port Type
Connector Type:  Other

```

Following SFP Parameters are Valid

```

Temperature: 35 Centigrade [Range -128 - +128 C]
Current:     8.176 mAmps [Range 0 - 131 mAmps]
Voltage:     3463.2 mVolts [Range 0 - 3600 mVolts]
Rx Power:   460.4 uW [Range 0 - 6550 uW]
Tx Power:   504.7 uW [Range 0 - 6550 uW]
Signal Loss (Upstream) : -16.7 dBm (21.2 uW)
Signal Loss (Downstream): -20.3 dBm (9.4 uW)

```

3-Fibre Channel Configuration

Running Extended Link Service Commands

Port Speed Capabilities 8Gbps 16Gbps 32Gbps
Last poll time: 03-24-2015 UTC Tue 18:03:14

4 NVM Express over Fibre Channel

This chapter describes the installation and configuration of NVMe over Fibre Channel (FC-NVMe) on the QLogic adapters from Marvell. It covers:

- [Hardware and Software Requirements](#)
- [“Host Setup” on page 106](#)
- [“Limitations and Known Issues” on page 113](#)
- [“Unloading and Reloading the Linux Driver” on page 113](#)

For assistance with the installation and configuration of FC-NVMe, contact Marvell Technical Support at this address:

https://www.marvell.com/support/contact/cust_support.do

Hardware and Software Requirements

The following sections list the required adapters, operating systems, and host software.

Adapters

FC-NVMe requires one or more of the following adapters, including models QLE2740-DEL, QLE2742-DEL, QLE2770-DEL, and QLE2772-DEL.

Operating Systems

The following x86_64 operating systems are supported for FC-NVMe:

- SUSE® Linux Enterprise Server (SLES®):
 - SLES 12 SP4
 - SLES 15/15 SP1
- Red Hat® Enterprise Linux (RHEL):
 - RHEL 7.6
 - RHEL 7.7
 - RHEL 8.0

- RHEL 8.1
- Microsoft Windows Server (Tech Preview only):
 - Windows Server 2016
 - Windows Server 2019

Host Software

This section lists the required FC-NVMe software, which, unless stated otherwise, is available on the Marvell Web site (see [“Documentation Conventions” on page xi](#)).

NOTE

Marvell Beta Software Statement

Marvell has agreed to make available for download certain pre-production beta software for Windows Server 2016 and Windows Server 2019 NVMe over Fibre Channel (FC-NVMe) drivers (the “Software”). The Software is not ready for production and is in a pilot state. The purpose of providing this Software is to enable your development effort to create leading-edge solutions with a significant improvement in time-to-market. Consequently, the Software is not warranted, nor fully tested, and certain risks are expected.

You agree that the Software is of beta quality and you acknowledge that the production test and full qualification are not completed. The Software should, therefore, not be used in a production environment.

Marvell makes no warranties, expressed or implied, statutory or otherwise, with respect to the software, including, without limitation, any implied warranty of merchantability or fitness for a particular purpose. The Software is provided to you “as is”. You assume all risk associated with use of the Software. In no event will Marvell be liable to you or any other person or entity, whether in contract, tort or any other basis, for incidental, consequential, indirect or special damages or liabilities, or the loss of revenue, loss of business, or other, financial loss arising out of the use or possession of the Software by you.

FC-NVMe software for Linux and FC-NVMe Tech Preview software for Microsoft Windows Server are available on the Marvell Web site. See [“Documentation Conventions” on page xi](#).

- Linux out-of-box (OOB) QLogic qla2xxx driver for x86_64 (also supports FC-NVMe):
 - SLES 12 SP4
 - SLES 15
 - SLES 15 SP 1

- RHEL 7.6 OOB
- RHEL 8.0 OOB
- Windows OOB driver version 9.3.3.20, or later (Tech Preview):
 - `q23wx64W16Storv9.3.3.20.zip`
- Fibre Channel firmware version 9.02.05 or later
- Linux QLogic management application, QConvergeConsole CLI version 2.3.00-36 or later:
 - `QConvergeConsoleCLI-2.3.00.36.x86_64`
- Windows QLogic management application, QConvergeConsole CLI version 2.3.00-36 or later (available from the Dell site):
 - `QConvergeConsoleCLI-2.3.00.36_win_x64.zip`
- NVMe CLI native application:
 - The OS Distribution DVD contains the native `nvme-cli-x.x-y.y.x86_64.rpm`.

Host Setup

Procedures for setting up the initiator host include the following:

- [Setting Up the Host](#)
- [Verifying the Adapter Firmware](#)
- [Verifying the Availability of FC-NVMe Devices](#)

Setting Up the Host

The following sections provide setup instructions for servers running SLES 12 SP4, SLES 15/15 SP1, RHEL 7.6, RHEL 8.0, and Windows 2016/2019:

- [Linux Host Setup](#)
- [Windows Host Setup](#)

Linux Host Setup

To set up a Linux host:

1. Install the supported base Linux operating system onto a host system.
2. Download, untar, and install the Linux driver kit as follows:
 - a. Download the appropriate driver kit using the FC-NVMe software as indicated in [“Host Software” on page 105](#).

- b. Untar and install the Linux driver kit by issuing the following commands:

```
# tar -zxvf qla2xxx-src-v10.01.00.xx.yy.z-k.tar.gz
# cd qla2xxx-src-v10.01.00.xx.yy.z-k
# ./extras/build.sh install
```

The src driver kits and driver RPM kits have embedded FC-NVMe auto-discovery scripts that are installed when the driver is deployed.

- c. Verify that the FC-NVMe scripts are installed by issuing the following commands:

```
# ls -l /etc/udev/rules.d/99-nvme-fc.rules
-rw-r--r--. 1 root root 310 Dec 31 15:14 /etc/udev/rules.d/99-nvme-fc.rules
# ls -l /usr/sbin/qla2xxx/qla2xxx_nvme_boot_connections.sh
-rwxr-xr-x. 1 root root 859 Jan 31 10:56 /usr/sbin/qla2xxx/qla2xxx_nvme_boot_connections.sh
# ls -l /usr/lib/systemd/system/qla2xxx-nvmefc-connect@.service
-rwxr-xr-x. 1 root root 859 Jan 31 10:56 /usr/lib/systemd/system/qla2xxx-nvmefc-connect@.service
# ls -l /usr/lib/systemd/system/qla2xxx-nvmefc-connect@.service
-rw-r--r--. 1 root root 279 Jan 31 10:54 /usr/lib/systemd/system/qla2xxx-nvmefc-connect@.service
```

3. If the Linux Out-of-Box driver does not discover NVMe targets after a system reboot, perform the following steps to ensure the service named `qla2xxx-nvmefc-boot-connection.service` is enabled.

- a. Open a Linux terminal window and enter the following to check the state of the service.

```
# systemctl list-unit-files | grep nvmefc-boot-connection
qla2xxx-nvmefc-boot-connection.service disabled
```

- b. If the service is disabled, enter the following to enable.

```
# systemctl enable qla2xxx-nvmefc-boot-connection.service
```

A following example message response should be seen.

```
Created symlink
/etc/systemd/system/default.target.wants/qla2xxx-nvmefc-b
oot-connection.service
→/usr/lib/systemd/system/qla2xxx-nvmefc-boot-connection.s
ervice.
```

- c. Check the service again; to show enabled.

```
# systemctl list-unit-files | grep nvmefc-boot-connection
qla2xxx-nvmefc-boot-connection.service enabled
```

4. Edit or create the `qla2xxx.conf` file to add the `ql2xnvmeenable` option. For example, `/etc/modprobe.d/qla2xxx.conf` contains:

```
options qla2xxx ql2xnvmeenable=1
```

For the FC-NVMe option to take effect the system boot image will need to be updated. See [Step 2](#) and [Step 5](#) to install the driver and to rebuild the boot image.

5. Rebuild the RAMDISK image by following the *Readme* driver guidelines to rebuild the `initrd` image.

The following commands show an example of how to build a RAMDISK:

```
# cd /boot
# cp <current-initrd-image> <current-initrd-image.bak>
# mkinitrd -f -v <current-initrd-image> `uname -r`
```

NOTE

In the `mkinitrd` command, you must use backticks (```) to surround `uname -r`.

6. Reboot the system and verify NVMe targets are discovered.
7. Install the NVMe CLI application version from the base operating system DVD.

```
# rpm -ivh nvme-cli-x.x-y.y.x86_64.rpm
```

8. In a terminal window, verify that the NVMe CLI application version is installed by issuing the following command:

```
# nvme version
```

9. Download and install the QConvergeConsole CLI RPM.
 - a. Download the QConvergeConsole CLI RPM from the URL listed in [“Host Software” on page 105](#).
 - b. Install the QConvergeConsole CLI RPM by issuing the following command:

```
# rpm -ivh QConvergeConsoleCLI-2.3.00-nn.x86_64.rpm
```

10. Confirm that the QLogic QLE27xx FC Adapters are running with the minimum required firmware version 9.02.05. For information about how to determine the firmware version and update it, see [“Verifying the Adapter Firmware” on page 110](#).

NOTE

The OOB driver must have the FC-NVMe option enabled to attach to FC-NVMe storage devices. For details on using the FC-NVMe driver option, see either the 10.01.xx.xx.xx.x-x driver documentation or the example shown in [Step 11](#).

11. (Optional) As needed, on the supported Linux OS, create a `hostnqn` file to attach to remote FC-NVMe Storage Subsystems.
 - a. With the NVMe CLI already installed, issue the following command to verify that the `hostnqn` file exists. For example:

```
# ls /etc/nvme/hostnqn
/etc/nvme/hostnqn
```
 - b. If the `hostnqn` file exists, issue the following command to view and make note of the `hostnqn` data to use when mapping the host initiator(s) to storage subsystems:

```
# cat /etc/nvme/hostnqn
nqn.2014-08.org.nvmexpress:uuid:1164eabb-e77f-4f15-ad16-c
efb43d1fc9
```
 - c. If the `hostnqn` file does not exist, issue the following command to create it using the NVMe CLI:

```
# nvme gen-hostnqn
nqn.2014-08.org.nvmexpress:uuid:a0baf242-85fd-41e5-a524-e
253d8531282
```
 - d. Take the output from the `nvme gen-hostnqn` command and save it to the `hostnqn` file. The edited file in the `/etc/nvme/hostnqn` directory should appear as follows.

```
nqn.2014-08.org.nvmexpress:uuid:a0baf242-85fd-41e5-a524-e
253d8531282
```
12. Reboot the system and verify that the correct driver and firmware versions are installed. For example, issue the following QConvergeConsole CLI command:

```
# qaucli -i 0
```
13. If NVMe devices do not appear, follow the procedures in [“Unloading and Reloading the Linux Driver”](#) on page 113 and [“Verifying the Availability of FC-NVMe Devices”](#) on page 111.

Windows Host Setup

NOTE

These procedures apply only to the FC-NVMe driver. For the Fibre Channel driver, follow the instructions in the corresponding `Readme.txt` file.

To set up a Windows host:

1. Install the Windows FC driver from the Dell update package.
 - Driver v9.3.3.20 or greater
 - QConvergeConsole CLI v2.3.00-36 or greater

Windows Host NQN

The driver automatically generates a host NVMe qualified name (NQN). To view the host NQN, issue the `qaucli -i` command.

The following shows an example Host NQN output:

```
-----  
Host Name           : WIN-4KHVTBVO147  
Host NQN            : nqn.2018-08.com.marvell:nvme.host.sys.wwpn:21000024ff784720  
HBA Instance       : 2  
HBA Model          : QLE2772
```

Verifying the Adapter Firmware

The following sections describe how to verify and update adapter firmware.

Verifying Adapter Firmware

Confirm that the adapter is running the minimum required firmware version, 9.02.05 or later.

To verify adapter firmware:

1. In QConvergeConsole CLI, issue the following command:

```
# qaucli -g  
HBA Model QLE2772 (SN AFD1517Y01945):  
Port 1 WWPN 21-00-00-24-FF-7B-97-60 (HBA instance 0) Online  
Port 2 WWPN 21-00-00-24-FF-7B-97-61 (HBA instance 1) Online
```

2. Choose the HBA instance for the adapter that you want to connect to FC-NVMe devices (0 in this example), and then issue the following command:

```
# qaucli -i 0  
Running Firmware Version      : 9.02.05 (d0d5)
```

```
Flash Firmware Version      : 9.02.05
```

The preceding output shows the QLE2772-DEL adapter with firmware version 9.02.05 in RAM and flash memory.

Verifying the Availability of FC-NVMe Devices

Follow the procedures in this section to confirm FC-NVMe device availability on Linux and Windows systems.

Verifying in Linux

In Linux, verify that the target devices are available by issuing either of the following commands:

```
# lsblk
```

or

```
# nvme list
```

Example: `lsblk` Command

The following example of a portion of the `lsblk` output shows the FC-NVMe attached targets. The system discovered three target controllers (`nvme0`, `nvme1`, and `nvme2`). Each of these controllers has one FC-NVMe LUN behind it (`n1`).

NAME	MAJ:MIN	RM	SIZE	RO	TYPE	MOUNTPOINT
nvme0n1	259:2	0	1G	0	disk	
nvme0n1p1	259:25	0	1023M	0	part	
nvme0n2	259:8	0	1G	0	disk	
nvme0n3	259:12	0	1G	0	disk	
nvme0n4	259:16	0	1G	0	disk	
nvme0n5	259:18	0	1G	0	disk	
nvme0n6	259:20	0	1G	0	disk	
nvme0n7	259:22	0	1G	0	disk	
nvme0n8	259:24	0	1G	0	disk	

Example: `nvme list` Command

The following example of a portion of the `nvme list` output shows the FC-NVMe attached targets.

Node	SN	Model	Namespace	Usage	Format	FW Rev
nvme0n1	00-200100110dd89300	SANBlaze	VLUN P3T0	1 67.11	MB /	67.11 MB 512
nvme1n1	00-200000110dd89200	SANBlaze	VLUN P2T0	1 67.11	MB /	67.11 MB 512
nvme2n1	00-200000110d4d1300	SANBlaze	VLUN P0T0	1 67.11	MB /	67.11 MB 512

Verifying in Windows

In Windows, verify that the target devices are available by issuing the `qaucli -t` command. For example:

```
qaucli -t 0 (HBA instance 0)
Using config file: C:\Users\Administrator\qaucli.cfg
Installation directory: C:\Users\Administrator
Working dir: C:\Users\Administrator
-----
HBA Instance 0: QLE2742 Port 1 WWPN 21-00-00-24-FF-8F-E3-9A PortID 01-21-00
Link: Online (FEC)
-----
Path                : 0
Target              : 0
Device ID           : 0x83
Product Vendor      : NVMe
Product ID          : SANBlaze VLUN P2
Product Revision    : -dev
Serial Number       : 6001_10d0_0247_2600_0302_0000_929d_14c6.
Node Name           : 20-02-00-11-0D-47-26-00
Port Name           : 20-02-00-11-0D-47-26-00
Port ID            : 01-1B-00
Product Type        : NVME Disk (Ensure that this shows as an FC-NVMe target.)
LUN Count(s)       : 51
Status              : Online
-----
```

Figure 4-1 shows the devices in Windows Device Manager.

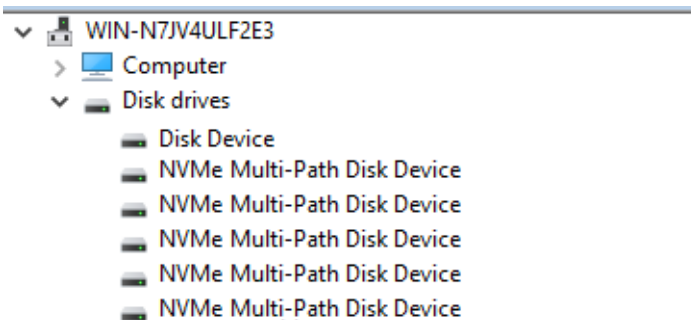

Figure 4-1. FC-NVMe Devices in Windows Device Manager

NOTE

To support formatting of an FC-NVMe drive on Windows, you may need to add the following Windows Registry entry for some OEM storage:

```
[HKEY_LOCAL_MACHINE\SYSTEM\CurrentControlSet\Services\ql2300\Parameters\Device] "DriverParameter"="ts=1"
```

NOTE

By default, NVMe is disabled. To enable NVMe on Windows, you may need to add the following Windows Registry entry for some OEM storage devices.

1.To enable NVMe, navigate to:

```
HKEY_LOCAL_MACHINE\SYSTEM\CurrentControlSet\Services\Ql2300\Parameters\Device
```

2.Double click on **DriverParameter:REG_SZ**

3.Look for `DriverParameter:REG_SZ:nvme=1`

4.If the string `nvme=1` does not exist, append `nvme=1` to the end of string.

Limitations and Known Issues

The following Linux and Windows limitations and known issues affect the installation and configuration of FC-NVMe.

Linux

For Linux operating systems, Marvell recommends that you disconnect all FC-NVMe devices prior to unloading the driver. Refer to the procedure in [Unloading and Reloading the Linux Driver](#).

Windows

Windows FC-NVMe does not support point to point (also called N2N) direct attach to Target/LUN configuration. It does support fabric configuration through FC Switch fabric.

Unloading and Reloading the Linux Driver

Follow the instructions in this section to unload and reload the Linux driver.

To unload and reload the Linux driver:

1. List all the FC-NVMe connected target controllers by issuing the following command:

```
# ls /dev/nvme* | grep -E nvme[0-9]+$
```

The preceding command should list all connected `/dev/nvme[x]` devices. For example:

```
/dev/nvme0  
/dev/nvme1
```

2. Disconnect all of the FC-NVMe target devices by issuing the following commands to each of the `/dev/nvme[x]` devices listed in [Step 1](#):

```
# nvme disconnect -d /dev/nvme0  
# nvme disconnect -d /dev/nvme1
```
3. Unload the current driver by issuing the following command:

```
# modprobe -r qla2xxx
```
4. Reload the driver to auto-discover the FC-NVMe subsystems by issuing the following command:

```
# modprobe -v qla2xxx
```

A Troubleshooting

This appendix provides information about Fibre Channel diagnostics and a Fibre Channel troubleshooting diagram, including:

- [Fibre Channel Diagnostics](#)
- [“Fibre Channel Troubleshooting Diagram” on page 118](#)
- [“Troubleshooting with a Diagnostic Port \(D_Port\)” on page 119](#)

Fibre Channel Diagnostics

Troubleshooting with Fibre Channel diagnostics include:

- [Fibre Channel Diagnostics Using QConvergeConsole GUI](#)
- [Fibre Channel Diagnostics Using Interactive QConvergeConsole CLI](#)
- [Fibre Channel Diagnostics Using Noninteractive QConvergeConsole CLI](#)

Fibre Channel Diagnostics Using QConvergeConsole GUI

QConvergeConsole GUI supports the internal and external loopback, read/write buffer, and beacon on/off diagnostic tests for Fibre Channel ports.

To set the loopback or read/write buffer test parameters:

1. In the QConvergeConsole system tree, select the adapter port.
2. In the content pane on the right, click the **Diagnostics** tab, and then click the **General Diagnostics** tab.
3. From the **Data Pattern** list, do one of the following:
 - Select a data byte or compliant jitter pattern.
 - Click **Customized** to specify your own eight-byte pattern. Enter the data in hexadecimal format (0–FF) into the eight **Customized** boxes.
 - Click **Random** to randomly generate an eight-byte data pattern.

The data size sets the number of bytes transferred per test per iteration when the test is run.

4. From the **Data Size** list, click the number of bytes to transfer.
Valid values are 8, 16, 32, 64, 128, 256, 512, 1024 and 2048. For Linux operating systems only, you can select data size values from 2048, 4096, 8192 up to 65535 (2K bytes to 64K bytes).
5. To set the test frequency, do one of the following:
 - In the **Number of Tests** box, type or select the number of tests you want to run. Testing stops when the passes complete. The valid range is between 1 and 65535 for loopback tests and between 1 and 10,000 for read/write buffer tests.
 - Select the **Test Continuously** check box. You determine when testing stops.
6. In the **On Error** box, click one of the following to determine how errors are handled. This selection applies whether you entered the **Number of Tests** or selected **Test Continuously**.
 - Ignore on Error**—Ignores errors and continues the test sequence.
 - Stop on Error**—Stops the test sequence once an error is encountered.
 - Loop on Error**—Uses the same data pattern and test until the failure is cleared.
7. In the **Test Increment** box, type or select the number of passes you want to run before the test stops.

The valid range is between 1 and 10,000 and must be less than or equal to the value in the **Number of Tests** box (see [Step 5](#)). For example, if the **Number of Tests** box contains 100 and the **Test Increment** box contains 15, 100 tests are run in seven passes. The first six passes run 15 tests each; the seventh pass runs 10 tests: $(6 \times 15) + 10 = 100$.

To run the loopback or read/write buffer test:

1. Click the **Loopback Test** or **Read/Write Buffer Test** button.
The diagnostic tests warning appears.
2. Click **Yes** if there are no I/Os active and you want to proceed with the test or click **No** to cancel the diagnostic test.
3. If you selected the loopback test, a dialog box allows you to select **Internal Loopback** or **External Loopback**. Click the appropriate test and then click **OK**.
4. If you selected **Yes** in [Step 2](#), a dialog box appears with the data pattern generated. Click **Stop** when you want to end the test.

To run the beacon on/off test:

1. In the QConvergeConsole GUI main window, click an adapter port in the system tree pane on the left.
2. In the content pane on the right, click the **Port Info** tab.
3. On the Port Info page, click **Beacon On** to run the test. To end the test, click **Beacon Off**.

For more information, refer to the topic about performing diagnostics in the *QConvergeConsole Help*.

Fibre Channel Diagnostics Using Interactive QConvergeConsole CLI

To run the loopback test, read/write buffer test, or beacon test:

1. On the **Main Menu**, select **4: Adapter Diagnostics**.
2. On the **Fibre Channel Diagnostics** menu, select the test type to run:
 - 1: Loopback Test** to run the loopback test.
 - 2: Read Write Buffer Test** to run the read/write buffer test.
 - 3: Beacon Test** to run the beacon test.
 - 4: Transceiver Diagnostics Monitoring Interface (DMI)** to view the transceiver diagnostics information.

For more information, refer to the section about the Fibre Channel interactive commands in the *User's Guide—QConvergeConsole CLI* (part number SN0054667-00).

Fibre Channel Diagnostics Using Noninteractive QConvergeConsole CLI

For information, refer to the section about the Fibre Channel noninteractive commands in the *User's Guide—QConvergeConsole CLI* (part number SN0054667-00).

Fibre Channel Troubleshooting Diagram

Figure A-1 and Figure A-2 provide a two-part troubleshooting flowchart.

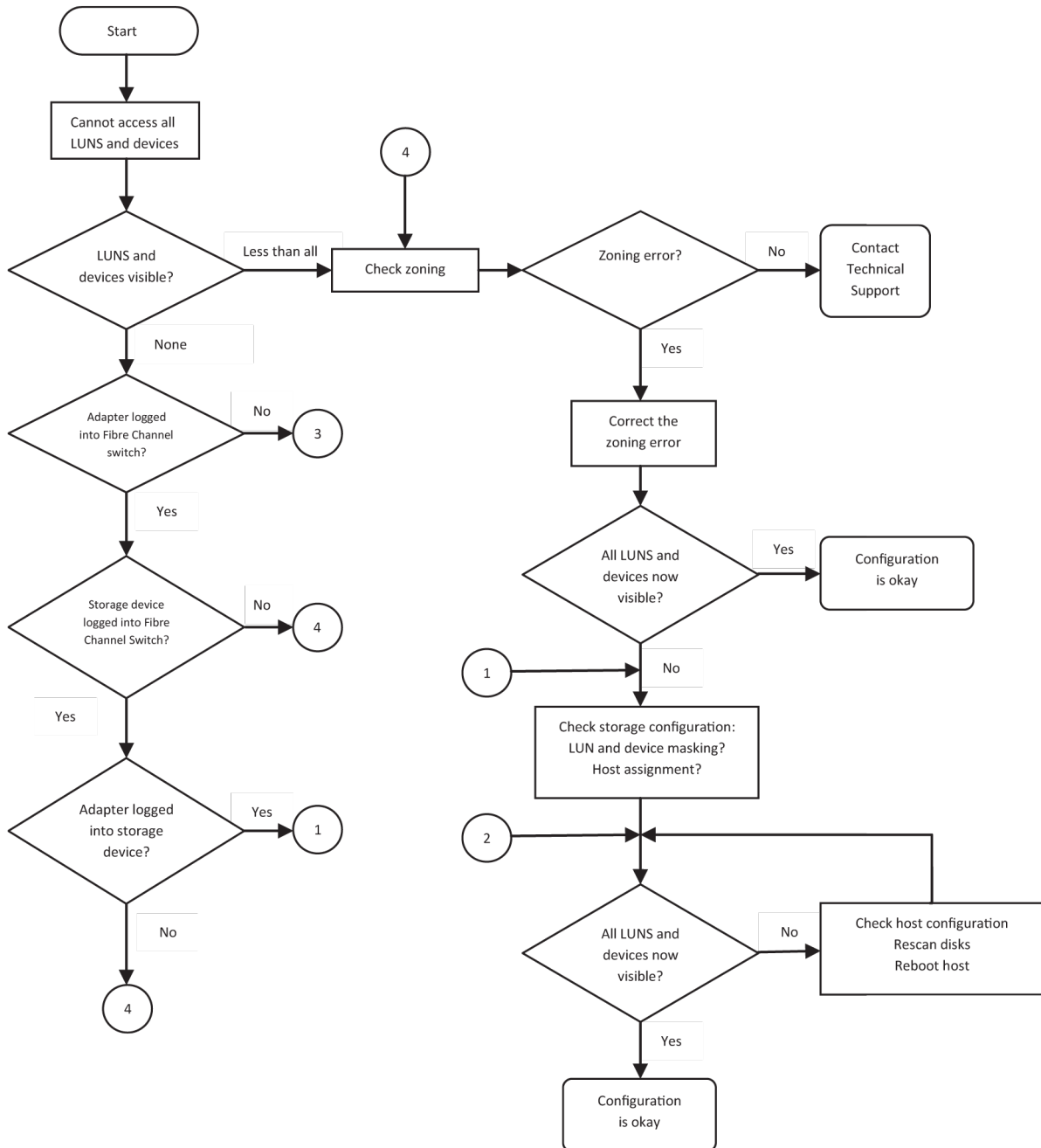

Figure A-1. Fibre Channel Troubleshooting Diagram (1 of 2)

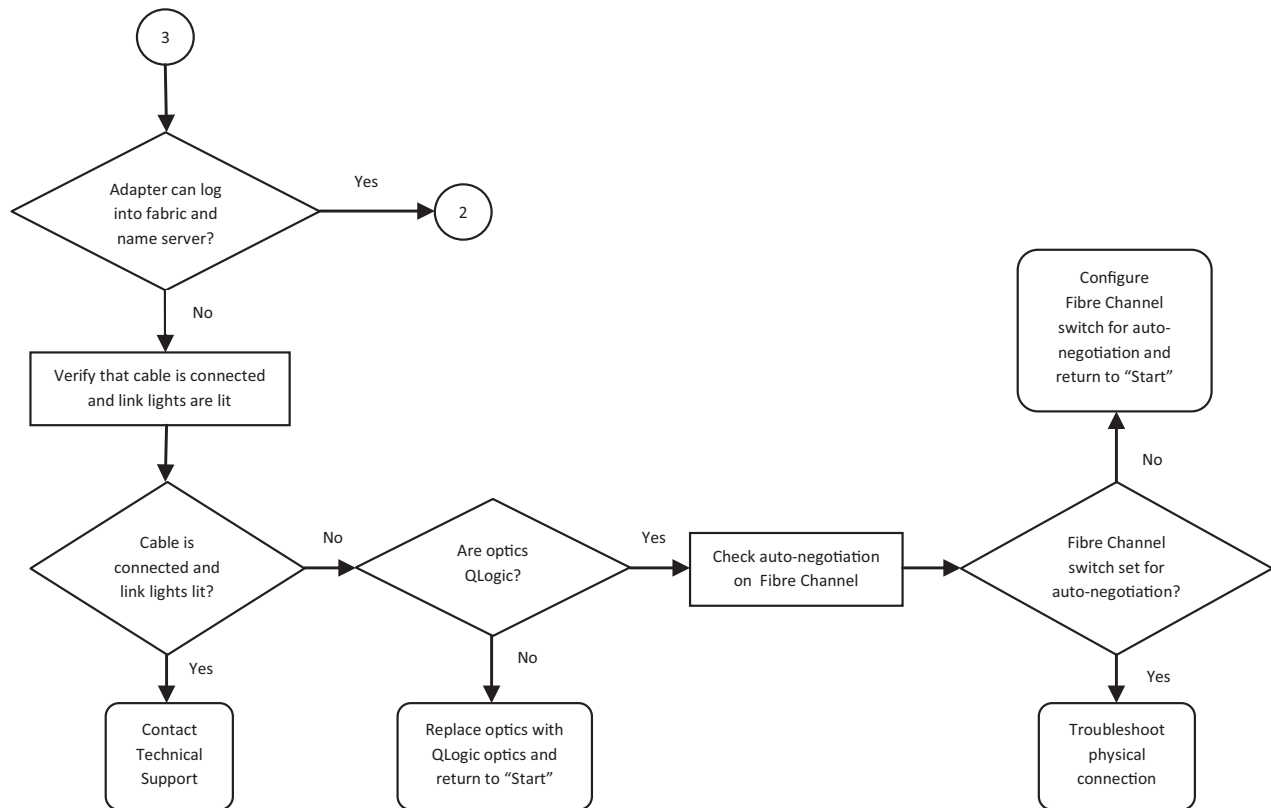

Figure A-2. Fibre Channel Troubleshooting Diagram (2 of 2)

Troubleshooting with a Diagnostic Port (D_Port)

Use the D_Port (diagnostic port) feature on the QLogic 2700 Series Adapters to identify and isolate link failures resulting from faulty modules (link, cable, or SFP) by running diagnostics over a Fibre Channel link.

- The D_Port feature is supported on Windows, Linux, and ESXi.
- The D_Port feature is not supported on the QME2742-DEL adapter.
- D_Port can be run only in *dynamic* mode; it does not support *static* mode.
- D_Port requires a Fibre Channel Adapter that is linked to a Brocade or Cisco Fibre Channel 16G or 32G switch, and the supported Brocade or Cisco 16G or 32G Fibre Channel switch firmware.

Configure the diagnostic D_Port on the switch to dynamically allow a port to enter D_Port mode when a D_Port is configured on the switch end, and then return to operational mode when the test is completed. Also configure the switch to start and stop the diagnostic test on the adapter port. See the associated switch documentation for details.

NOTE

All QLogic-branded 32GFC SFP+ transceivers can run D_Port tests. If you have a supported non-QLogic branded transceiver, ensure that it supports the optical wrap (OWrap) and electrical wrap (EWrap) capability that is required for D_Port.

When a switch port is enabled as a D_Port, the QLogic 2700 Series Adapter automatically runs the basic diagnostic test at both ends of the link. The Brocade switch then runs the following additional tests:

- Electric loopback test
- Optical loopback test

You should run diagnostic port tests on multipath configured boot from SAN or fabric-assigned boot LUN. Running diagnostic port tests on single path boot from SAN or fabric-assigned boot LUN may cause issues with OS stability in true boot from SAN environments.

The following sections describe how to configure and run D_Port mode, and how to verify D_Port mode from the QConvergeConsole utilities:

- [Configuring D_Port on a Brocade Fibre Channel 16G or 32G Switch](#)
- [Configuring and Running Diagnostics Port on a Cisco Fibre Channel 16 or 32G Switch](#)
- [Checking D_Port Results from a Brocade Fibre Channel 16G or 32G Switch](#)
- [Verifying D_Port Mode with QConvergeConsole GUI](#)
- [Verifying D_Port Mode with Interactive QConvergeConsole CLI](#)
- [Verifying D_Port Mode with Noninteractive QConvergeConsole CLI](#)
- [Verifying D_Port Mode with QConvergeConsole Plug-ins](#)

Configuring D_Port on a Brocade Fibre Channel 16G or 32G Switch

To enable D_Port diagnostic mode:

From the Brocade Fibre Channel 16G or 32G switch, issue the following commands:

```
# portdisable <port#>
# portcfgdport --enable <port#>
# portenable <port#>
```

The D_Port test starts automatically.

To disable D_Port diagnostic mode:

From the Brocade Fibre Channel 16G or 32G switch, issue the following commands:

```
# portdisable <port_num>
# portcfgdport --disable <port_num>
# portenable <port_num>
```

The D_Port test stops.

Configuring and Running Diagnostics Port on a Cisco Fibre Channel 16 or 32G Switch

The following example configures and starts a diagnostic test on port 2 of a Cisco Fibre Channel 9396S or 97xx switch (NX-OS 8.2.1 or later). For more details about the switch, see the Cisco switch documentation.

```
Cisco# config t
Cisco# int fc 1/2
Cisco(config-if)# shut
Cisco(config-if)# switchport link-dia
Cisco(config-if)# no shut
Cisco(config-if)# diagnostic start interface fc 1/2 test link-dia
```

To check the diagnostic test status, type the following command:

```
Cisco(config-if)# show diagnostic result interface fc1/1 test
link-dia
PWWN of peer port: 21:00:00:24:ff:8f:c9:e0
Status: Supported (Reflector)
Reflector loopback capabilities: Xcvr-optical Electrical
Time of Test: Mon Feb 5 16:31:02 2018
Total time taken: 20 seconds
```

```
=====|=====|=====|=====|=====|=====|=====|=====|=====|=====|
          |          |          | Discards |          | Latency (ns) |          |          |          |          |
Loopback Level | Tx Frames | Rx Frames | IN | OUT |BAD WORDS|In-Switch|External|          | Status
=====|=====|=====|====|====|=====|=====|=====|=====|=====|
Remote-Switched(R) |          |          | 0| 0| 0|          |          |          |          | -NA-
Mac (R) |          |          | 0| 0| 0|          |          |          |          | -NA-
Xcvr-optical (R) | 7225275| 7225275| 0| 0| 0| 2112| 1064|          | Success
Electrical (R) | 20000| 20000|          | -NA- |          | -NA- | -NA- |          | Success
=====|=====|=====|=====|=====|=====|=====|=====|=====|=====|
```



```
Overall Status           : Success
Cable Length (approx. +/- 5 metres) : 10.4 metres
```

To disable the diagnostic port, type the following commands:

```
Cisco#int fc 1/2
Cisco(config-if)# shut
Cisco(config-if)# no switchport link-diag
Cisco(config-if)# no shut
```

Checking D_Port Results from a Brocade Fibre Channel 16G or 32G Switch

To view the D_Port test results from a Brocade Fibre Channel 16G or 32G switch:

1. To get the port number, issue the `switchshow` command:

```
# switchshow
```

The following example output identifies port 17:

```
17 17 011100 id N16 Online FC D-Port Loopback->Port 17
```

2. Issue the `portdporttest` command as follows:

```
# portdporttest --show <port_num>
```

For example:

```
# portdporttest --show 17
```

Following is an example output for this command.

```
portdporttest --show 17
```

```
D-Port Information:
```

```
=====
```

```
Port: 17
Remote WWPN: 21:00:00:0e:1e:11:4a:31
Mode: Automatic
No. of test frames: 1 Million
Test frame size: 1024 Bytes
FEC (enabled/option/active): Yes/No/No
CR (enabled/option/active): Yes/No/No
Start time: Thu Aug 14 01:45:37 2014
End time: Thu Aug 14 01:47:40 2014
Status: PASSED
=====
```

Test	Start time	Result	EST (HH:MM:SS)	Comments
Electrical loopback	01:46:08	PASSED	-----	-----
Optical loopback	01:46:54	PASSED	-----	-----
Link traffic test	-----	SKIPPED	-----	-----
Roundtrip link latency:		157 nano-seconds		
Estimated cable distance:		3 meters		
Buffers required:		1 (for 2112 byte frames at 16Gbps speed)s		

Verifying D_Port Mode with QConvergeConsole GUI

To verify D_Port mode in QConvergeConsole GUI:

1. In the QConvergeConsole left pane, click the **Host** tab.
2. On the Host page, expand a 2700 Series Adapter to view its port nodes.

If a port is in D_Port mode, the port node specifies **Loop Down, Diagnostic Mode**. [Figure A-3](#) shows an example.

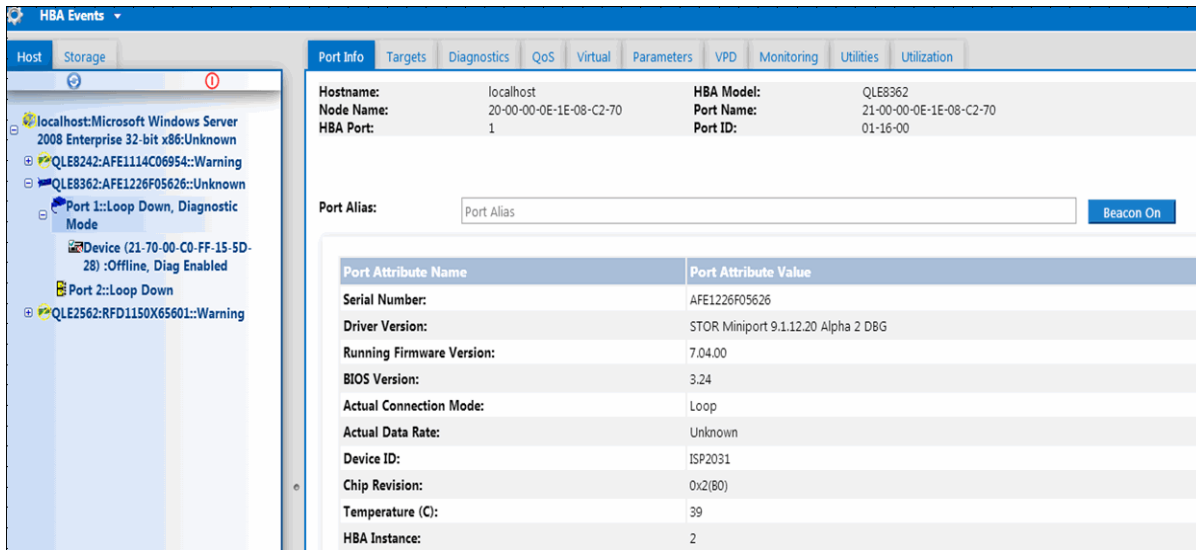

Figure A-3. D_Port Mode in QConvergeConsole GUI

Verifying D_Port Mode with Interactive QConvergeConsole CLI

To verify D_Port mode in interactive QConvergeConsole CLI:

1. From the main menu, select the **Adapter Information** option, and then select the adapter type (**Fibre Channel Adapter**).
2. From the **FC Adapter Information** menu, select **2 (FC Port Information)**.

The Adapter Information menu shows the affected port with a status of **Loop Down, Diagnostic Mo**. [Figure A-4](#) shows an example.

```
QConvergeConsole
CLI - Version 1.1.3 <Build 23>

FC Adapter Information
1: FC Adapter Information
2: FC Port Information
3: FC UPD Information
4: FC Target/LUN Information

<p or 0: Previous Menu; n or 98: Main Menu; ex or 99: Quit>
Please Enter Selection: 2

QConvergeConsole
CLI - Version 1.1.3 <Build 23>

Adapter Information
HBA Model QLE8362 SN: AFE1226F05626
1: Port 1: WWPN: 21-00-00-0E-1E-08-C2-70 Loop Down, Diagnostic Mo
2: Port 2: WWPN: 21-00-00-0E-1E-08-C2-71 Link Down
HBA Model QLE2562 SN: RFD1150X65601
3: Port 1: WWPN: 21-00-00-24-FF-36-48-40 SFP not installed
4: Port 2: WWPN: 21-00-00-24-FF-36-48-41 SFP not installed

<p or 0: Previous Menu; n or 98: Main Menu; ex or 99: Quit>
Please Enter Selection: _
```

Figure A-4. D_Port Mode in Interactive QConvergeConsole CLI

Verifying D_Port Mode with Noninteractive QConvergeConsole CLI

To verify D_Port mode in noninteractive QConvergeConsole CLI, issue the following command:

```
quacli -pr fc -g
```

All the 2700 Series Adapters are listed. The affected port shows a status of **Loop Down, Diagnostic Mo**. [Figure A-5](#) shows an example.

```
Administrator: Command Prompt
C:\>qacucli -pr fc -g
-----
Host Name           : WIN-PPMYRM90WP4
OS Type             : Microsoft Windows Server 2008 Enterprise 32-bit x86
OS Version          : Service Pack 2 (Build 6002)
SDM API Version     : 1.28.0.116 QLSDM.DLL
-----
HBA Model QLE8242 (SN AFE114C06954):
  Port 1 WWPN 21-00-00-0E-1E-05-32-CB (HBA instance 4) Link Down
  Port 2 WWPN 21-00-00-0E-1E-05-32-CF (HBA instance 5) Link Down
HBA Model QLE8362 (SN AFE1226F05626):
  Port 1 WWPN 21-00-00-0E-1E-08-C2-70 (HBA instance 2) Loop Down, Diagnostic Mo
  Port 2 WWPN 21-00-00-0E-1E-08-C2-71 (HBA instance 3) Link Down
HBA Model QLE2562 (SN RFD1150X65601):
  Port 1 WWPN 21-00-00-24-FF-36-48-40 (HBA instance 0) SFP not installed
  Port 2 WWPN 21-00-00-24-FF-36-48-41 (HBA instance 1) SFP not installed
-----
Total QLogic HBA(s) : 3
```

Figure A-5. D_Port Mode in Noninteractive QConvergeConsole CLI

For more information, refer to the section about the Fibre Channel noninteractive commands in the *User's Guide—QConvergeConsole CLI* (part number SN0054667-00).

Verifying D_Port Mode with QConvergeConsole Plug-ins

For information about verifying D_Port mode using QConvergeConsole VMware vCenter Server Plug-in and QConvergeConsole VMware vSphere Web Client Plug-in, see the “Managing Fibre Channel Adapters” section in the *User's Guide—QConvergeConsole Plug-ins for VMware vSphere* (part number SN0054677-00).

B Specifications

This appendix provides specifications for the QLE27xx -DEL Adapters.

Physical Characteristics

Table B-1 lists the physical characteristics for the QLE27xx -DEL Adapters.

Table B-1. Physical Characteristics

Adapter	Type	Bracket Installed	Length	Width
QLE2740-DEL	Low profile PCIe card	Full height	6.6 inches	2.731 inches
QLE2740L-DEL	Low profile PCIe card	Low profile	6.6 inches	2.731 inches
QLE2742-DEL	Low profile PCIe card	Full height	6.6 inches	2.731 inches
QLE2742L-DEL	Low profile PCIe card	Low profile	6.6 inches	2.731 inches
QME2742-DEL	Dell PowerEdge mezzanine adapter	—	Conforms to the Dell mezzanine card form factor	
QLE2770-DEL	Low profile PCIe card	Full height	6.6 inches	2.731 inches
QLE2270L-DEL	Low profile PCIe card	Low profile	6.6 inches	2.731 inches
QLE2772-DEL	Low profile PCIe card	Full height	6.6 inches	2.731 inches
QLE2772L-DEL	Low profile PCIe card	Low profile	6.6 inches	2.731 inches

Power Requirements

Table B-2 lists the power requirements for the QLE27xx -DEL Adapters.

Table B-2. Power Requirements

Adapter	Nominal Power	Maximum Power
QLE2740-DEL	8.6W	10.65W
QLE2740L-DEL	8.6W	10.65W
QLE2742-DEL	9.3W	11.5W
QLE2742L-DEL	9.3W	11.5W
QME2742-DEL	7W	8.3W
QLE2770-DEL	9W	11.2W
QLE2770L-DEL	9W	11.2W
QLE2772-DEL	11.4W	14.3W
QLE2772L-DEL	11.4W	14.3W

Standards Specifications

Standards specifications for the QLE27xx -DEL Adapters include the following:

- Fibre Channel Tape (FC-TAPE) Profile
- PCI Express Base Specification, rev. 4.0 (Only for QLE277x)
- *PCI Express Base Specification*, rev. 3.0
- *PCI Express Card Electromechanical Specification*, rev. 2.0
- *PCI Bus Power Management Interface Specification*, rev. 1.2
- *SCSI-3 Fibre Channel Protocol (SCSI-FCP)*
- *SCSI Fibre Channel Protocol-2 (FCP-2)*
- *Second Generation FC Generic Services (FC-GS-2)*
- *Third Generation FC Generic Services (FC-GS-3)*

Interface Specifications

Table B-3 list the interface specifications for the QLE27xx -DEL Adapters.

Table B-3. Interface Specifications

Port Type	Media
32Gb SFP+	SFF-8431 Specification for SFP+, Revision 3.2

Environmental Specifications

Table B-4 lists the environmental specifications for the QLE27xx -DEL Adapters.

Table B-4. Environmental Specifications

Characteristic	Value
Temperature	
Operational: All models	0°C to 55°C (32°F to 131°F)
Storage: All models	-20°C to 70°C (-4°F to 158°F)
Humidity	
Relative (noncondensing)	10% to 90%
Storage	5% to 95%

C QConvergeConsole GUI

This appendix provides the following information about QConvergeConsole GUI:

- [Introduction to QConvergeConsole GUI](#)
- [“Downloading QConvergeConsole Documentation” on page 130](#)
- [“Downloading and Installing Management Agents” on page 130](#)
- [“Installing QConvergeConsole GUI” on page 131](#)
- [“What Is in the QConvergeConsole Help System” on page 134](#)

NOTE

For information on installing QConvergeConsole GUI, refer to the *Installation Guide—QConvergeConsole GUI* (part number SN0051105-00). All procedural information for the QConvergeConsole GUI utility is covered in the *QConvergeConsole Help*.

Introduction to QConvergeConsole GUI

QConvergeConsole GUI is a Web-based client and server GUI management tool that provides centralized management and configuration of QLogic adapters within the entire network (LAN and SAN).

On the server side, QConvergeConsole GUI runs as an Apache Tomcat™ application server. After QConvergeConsole GUI is launched on the application server, you can connect to QConvergeConsole GUI through a browser, either locally on the server or remotely from another computer. Your browser window becomes the client used to connect to servers that host the QLogic adapters and connected storage devices within the network.

Use the QConvergeConsole GUI main window to connect to servers that host QLogic adapters. Each host server can include a combination of the following QLogic adapters:

- 32Gb Fibre Channel Adapters (QLE274x-DEL, QLE274xL-DEL)
- 32Gb Fibre Channel Mezzanine Card (QME2742-DEL)

Note the following:

- QConvergeConsole GUI works with the Windows Server, Red Hat Linux® Advanced Server and Enterprise Server, Novell® SUSE® Linux Enterprise Server (SLES®), and Oracle Linux—Unbreakable Enterprise Kernel (UEK). Multiple operating system support allows control of heterogeneous environments.
- QConvergeConsole GUI runs on the following Web browsers: Google Chrome™, Mozilla® Firefox®, Microsoft® Internet Explorer®, Opera®, Apple® Safari®. For details on browser versions, see the QConvergeConsole *Readme*, which you can download at www.marvell.com.

NOTE

Some auxiliary help features, such as the Search and Index tools, may not work properly in every Web browser.

Downloading QConvergeConsole Documentation

To download the *Installation Guide—QConvergeConsole GUI* (part number SN0051105-00), go to www.marvell.com.

Downloading and Installing Management Agents

To manage the adapters on a local or remote host, the *management agents* (also called *agents*) used by the host's adapters must already be installed on the host. The agent for Fibre Channel is `qlremote`.

To connect to a remote host, at least one management agent used by any of the host's adapters must be installed and running on the host. Only protocols whose agents are installed and running are shown under the host's system tree node.

Management agents are *not* automatically installed by the QConvergeConsole GUI installer and must be downloaded and installed separately. You can download the agents from the Marvell Web site Downloads page, or using the built-in Agent Installer.

Installing the Agents from the Marvell Web Site

To obtain the agents from the Marvell Web site and install them (Windows and Linux, all versions):

1. Go to www.marvell.com.
2. Point to **Support**, and then under **Driver Downloads**, click **Marvell QLogic/FastLinQ Drivers**.

3. On the Downloads and Documentation page, click **Adapters**, and then select the **by Model** button.
4. To define a search, click an item in each selection column, and then click **Go**.
5. Download the following for each adapter on the host server:
 - SuperInstaller
 - Readme* and *Release Notes*
6. Install the agents by running the SuperInstaller. For detailed information on running the SuperInstaller, refer to the *Readme* and *Release Notes*.

Installing the Agents Using the Built-in Agent Installer

To access the QCC Agent Installer within QConvergeConsole GUI:

1. Point to the gear icon , point to **Help**, and then click **Download Agent Installers**.

The QCC Agent Installer Utility opens in a separate window and lists links for the platform that the utility has detected.
2. For each agent installer to download, click the link.
3. In the File Download dialog box, click **Save**.

NOTE

For detailed installation instructions, refer to the *Installation Guide—QConvergeConsole GUI* (part number SN0051105-00).

Installing QConvergeConsole GUI

Refer to the installation procedure for your operating system.

- [Installing QConvergeConsole in a Windows Environment](#)
- [Installing QConvergeConsole in a Linux Environment](#)
- [Installing QConvergeConsole in Silent Mode](#)

Installing QConvergeConsole in a Windows Environment

The QConvergeConsole Installer for Windows is a self-extracting utility that installs QConvergeConsole and related files.

NOTE

Before you begin, read the *QConvergeConsole Release Notes* and *Readme* documents for important, up-to-date product information.

To install QConvergeConsole in a Windows environment:

1. Locate the directory where you downloaded the installation file, and then double-click the following file:
`QConvergeConsole_Installer_Windows_<version>.exe`
2. If an Open File security dialog box appears, click **Run**.
The InstallAnywhere utility prepares to install QConvergeConsole.
3. In the Tomcat Port Number Setup dialog box, enter a valid port number in the range 1025–65536, or accept the default port number, 8080. Then click **Next** to continue.
4. In the next dialog box, select **Yes** if you want a localhost-only installation. If you do not want a localhost-only installation, select **No**.

NOTE

The localhost-only option installs QConvergeConsole locally so that you must run it locally (remote connection is not possible). To disable the option, you must uninstall QConvergeConsole and then reinstall it, selecting **No** in this step.

5. In the Pre-Installation Summary dialog box, verify that the information is correct, and then click **Install** to proceed.
The installer shows the progress of the installation.
A message box prompts you to confirm if you want to enable the SSL feature, which allows data to be encrypted within a secure layer before passing it to and from the server.
6. To enable the SSL feature, click **Yes**. Or to disable SSL, click **No**.
7. In the Install Complete dialog box, click **Done** to exit the installer.

You have installed QConvergeConsole on your server.

Installing QConvergeConsole in a Linux Environment

You have the option of installing QConvergeConsole in a Linux environment using either a GUI or CLI method. To install from the CLI, see [“Installing QConvergeConsole in Silent Mode” on page 134](#).

You can graphically install QConvergeConsole on a Linux host by running a Virtual Network Computing (VNC®) program on a Windows host. The TightVNC Viewer, a VNC program, can remotely control QConvergeConsole installation on a Linux host.

To install QConvergeConsole in a Linux environment:

1. Open the directory containing the installer file, which is one of the following:
 - QConvergeConsole_Installer_Linux_i386_<version>.bin
 - QConvergeConsole_Installer_Linux_x64_<version>.bin
2. In the terminal window, verify that the installer file has permission to execute by issuing the `ls -lt` command at the prompt.
3. To install QConvergeConsole, double-click the QConvergeConsole installer `.bin` file.

A prompt asks if you want to run or view the contents of the `.bin` file.

4. Click **Run in Terminal**.

The installer extracts the files and installs QConvergeConsole in the following directory:

```
/opt/QLogic_Corporation/QConvergeConsole
```

The InstallAnywhere window prepares to install QConvergeConsole.

5. In the installation Introduction dialog box, click **Next**.
6. In the Tomcat Port Number Setup dialog box, enter a valid port number in the range 1025–65536, or accept the default port number, 8080. Then click **Next** to continue.
7. In the next dialog box, select **Yes** if you want a localhost-only installation. If you do not want a localhost-only installation, select **No**.

NOTE

The localhost-only option installs QConvergeConsole locally so that you must run it locally (remote connection is not possible). To disable the option, you must uninstall QConvergeConsole and then reinstall it, selecting **No** in this step.

8. In the Pre-Installation Summary dialog box, read the information, and then click **Install**. During the installation, the installer notifies you of the status.
9. In the Install Complete dialog box, click **Done** to exit the installer.

You have installed QConvergeConsole on your server.

Installing QConvergeConsole in Silent Mode

You can install QConvergeConsole from a command prompt in silent mode.

To run the installer in silent mode, issue the following command:

```
<installer_file_name> -i silent -DUSER_INPUT_PORT_NUMBER=<A_NUMBER>
```

What Is in the QConvergeConsole Help System

To access the *QConvergeConsole Help* system while the GUI utility is running, point to the gear icon , point to **Help**, and then click **Browse Contents**. The help system provides topics containing details of the following:

- **QConvergeConsole Overview** describes the purpose and scope of QConvergeConsole and lists the features, supported OSs, and supported Web browsers.
- **Getting Started** shows how to start using QConvergeConsole and the help system. It also describes how to initiate automatic e-mail notifications and set security on adapters installed for a selected host.
- **Managing Host Connections** describes how to connect to a host, create and use a host group, view host information, use host configuration files, and disconnect from one or more host servers.
- **Displaying Host Information** describes how to view general and iSCSI host information.
- **Displaying Adapter Information** describes how to view general adapter information, use adapter utilities, and manage the HBA event log.
- **Displaying Device Information** describes how to view information about devices (disk or tape), targets, and LUNs.
- **Using Reports** describes the different types of reports and how to generate, view, and save them using QConvergeConsole's report facility.

- **Managing Fibre Channel and FCoE Adapters** describes how to do the following for a Fibre Channel Adapter (2400/2500/2600/2700 Series) or Converged Network Adapter (8100/8200/8300 Series):
 - ❑ View and edit adapter-specific information for the selected adapter
 - ❑ View and modify adapter configuration and settings
 - ❑ Update the adapter's Flash memory on a Fibre Channel or an FCoE driver
- **Managing Fibre Channel and FCoE Ports** describes how to do the following for a port on a Fibre Channel Adapter or a Converged Network Adapter:
 - ❑ View and modify the parameters and statistics for the selected port
 - ❑ Use the advanced utilities, manage virtual ports, and run diagnostics
- **Managing iSCSI Ports** describes the parameters on the iSCSI port management pages for the 4000 Series iSCSI and 8200/8300 Series Converged Network Adapters.
- **Managing Gigabit Ethernet Adapters** describes the parameters and configuration options provided on the NIC port management pages for QLE84xx, QL41000, and QL45000 Series FastLinQ Intelligent Ethernet Adapters and Converged Network Adapters.
- **Managing Ethernet (NIC) Ports** describes the parameters and configuration options provided on the NIC port management pages for 3200 Series Intelligent Ethernet Adapters and 8100/8200/8300 Series Converged Network Adapters.
- **Using the Wizards** provides step-by-step instructions for each of the wizards built into QConvergeConsole.
- **Troubleshooting** describes tools you can use to resolve any problems that can occur when installing and using QConvergeConsole. It also provides the procedures for tracing QConvergeConsole GUI and agent activity, if directed to do so by your authorized service provider.
- **Technical Support** explains how to obtain technical support, gives instructions for downloading software and documentation, and provides contact information.
- **Glossary** provides definitions of key terms.

D Regulatory Information

This appendix provides warranty, regulatory, and compliance information for the Fibre Channel Adapters covered in this guide.

Warranty

For information about your Dell warranty, see your system documentation.

Regulatory and Compliance Information

Laser Safety, FDA Notice

This product complies with DHHS Rules 21CFR Chapter I, Subchapter J. This product has been designed and manufactured according to IEC60825-1 on the safety label of laser product.

CLASS I LASER

Class 1 Laser Product	Caution —Class 1 laser radiation when open Do not view directly with optical instruments
Appareil laser de classe 1	Attention —Radiation laser de classe 1 Ne pas regarder directement avec des instruments optiques
Produkt der Laser Klasse 1	Vorsicht —Laserstrahlung der Klasse 1 bei geöffneter Abdeckung Direktes Ansehen mit optischen Instrumenten vermeiden
Luokan 1 Laserlaite	Varoitus —Luokan 1 lasersäteilyä, kun laite on auki Älä katso suoraan laitteeseen käyttämällä optisia instrumenttejä

Agency Certification

The following section contains a summary of EMI/EMC test specifications performed on model HD8310405 and CU0310421 to comply with radiated emission, radiated immunity, and product safety standards.

EMI and EMC Requirements

FCC Rules, CFR Title 47, Part 15, Subpart B: Class A

FCC compliance information statement: This device complies with Part 15 of the FCC Rules. Operation is subject to the following two conditions: (1) this device may not cause harmful interference, and (2) this device must accept any interference received, including interference that may cause undesired operation.

Industry Canada, ICES-003:2004: Class A

This Class A digital apparatus complies with Canadian ICES-003.
Cet appareil numérique de la classe A est conforme à la norme NMB-003 du Canada.

CE Mark 2004/108/EC EMC Directive Compliance

EN55022:2010/CISPR 22:2009+A1:2010: Class A

EN55024:2010

EN61000-3-2:2006 A1+A2:2009

EN61000-3-3:2008

EN61000-4-2: ESD

EN61000-4-3: RF Electro Magnetic Field

EN61000-4-4: Fast Transient/Burst

EN61000-4-5: Fast Surge Common/Differential

EN61000-4-6: RF Conducted Susceptibility

EN61000-4-8: Power Frequency Magnetic Field

EN61000-4-11: Voltage Dips and Interrupt

VCCI: 20011-04; Class A

AS/NZS; CISPR 22:2009+A1:2010 Class A

Korea Certification

KC-RRA KN22 KN24 (2011) Class A



Product Name/Model—2700 Series Adapter
Certification Holder—QLogic Corporation
Manufactured Date—Refer to date code listed on product
Manufacturer/Country of Origin—QLogic Corporation/USA

A class equipment (Business purpose info/ telecommunications equipment)	As this equipment has undergone EMC registration for business purpose, the seller and/or the buyer is asked to beware of this point and in case a wrongful sale or purchase has been made, it is asked that a change to household use be made.
---	--

Korean Language Format—Class A

A급 기기 (업무용 정보통신기기)

이 기기는 업무용으로 전자파적합등록을 한 기기이오니 판매자 또는 사용자는 이 점을 주의하시기 바라며, 만약 잘못판매 또는 구입하였을 때에는 가정용으로 교환하시기 바랍니다.

Product Safety Compliance

UL, cUL Product Safety

UL60950-1 (2nd Edition), 2007
CSA C22.2 60950-1-07 (2nd Edition) 2007

Use only with listed ITE or equivalent.

Complies with 21 CFR 1040.10 and 1040.11.

Complies with 21 CFR 1040.10 and 1040.11.

For use with UL Listed Servers or equivalent.

Power off the computer and all attached devices such as monitors, printers, and external components before installing the accessory card or equivalent.

2006/95/EC Low Voltage Directive

TUV EN60950-1:2006+A11+A1+A12 2nd Edition
TUV IEC 60950-1:2005 2nd Edition Am 1:2009 CB

E Adapter LEDs

This appendix describes the LEDs on the 2700 Series Adapters.

Figure E-1 shows the QLE274x and QME2742 32Gb Adapter port with three LEDs:

- The green LED on the left is 32Gb.
- The green LED in the middle is 16Gb.
- The green LED on the right is 8Gb.

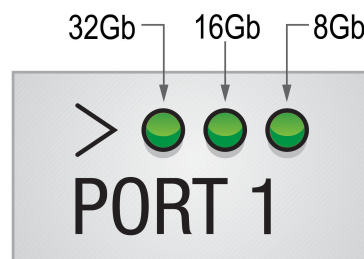

Figure E-1. QLE274x and QME2742 32Gb Adapter LEDs

Table E-1 defines the LED behavior for the QLE274x and QME2742 32Gb Adapter.

Table E-1. QLE274x and QME2742 32Gb Adapter LED Scheme

LED	Power Off	Power On (Before Firmware Initialization)	Power On (After Firmware Initialization)	Firmware Fault	8Gbps Link Up and Active	16Gbps Link Up and Active	32Gbps Link Up and Active	Beaconing
Green LED (32Gbps)	Off	On	Flashing	Flashing in sequence	Off	Off	On or flashing	Flashing
Green LED (16Gbps)	Off	On	Flashing	Flashing in sequence	Off	On or flashing	Off	Off
Green LED (8Gbps)	Off	On	Flashing	Flashing in sequence	On or flashing	Off	Off	Flashing

F Revision History

Document Revision History	
Revision A, March 21, 2016	
Revision B, April 19, 2016	
Revision C, February 1, 2017	
Revision D, August 24, 2017	
Revision E, December 19, 2017	
Revision F, April 13, 2018	
Revision G, January 29, 2018	
Revision H, June 14, 2019	
Revision J, October 28, 2019	
Changes	Sections Affected
<p>Addition of QLE277x-DEL adapters.</p> <p>Update to operating system support.</p> <p>Addition of bullet to reference Revision History appendix.</p> <p>Addition of PCIe 4.0 to PCIe Bus Slot Considerations.</p> <p>Changes made to uninstall command for removal of the QLogic Adapter CIM Provider.</p> <p>Updated all screens for Configuring the UEFI Driver section.</p> <p>Updates to supported operating systems for NVMe.</p> <p>Update to Linux OOB support for NVMe.</p> <p>Changes to driver and QConvergeConsole CLI versions in Host Setup.</p> <p>Updated Windows Registry entries to enable NVME.</p> <p>Addition of QLE277x-DEL adapters to Physical Characteristics and Power sections in Specifications appendix.</p>	<p>“Supported Operating Systems” on page xiv</p> <p>“User’s Guide Content” on page x</p> <p>“PCIe Bus Slot Considerations” on page 2</p> <p>“Uninstalling the QLogic Adapter CIM Provider” on page 27</p> <p>“Configuring the UEFI Driver” on page 56</p> <p>“Operating Systems” on page 104</p> <p>“Host Software” on page 105</p> <p>“Windows Host Setup” on page 110</p> <p>“Verifying the Availability of FC-NVMe Devices” on page 111</p> <p>“Physical Characteristics” on page 126 and “Power Requirements” on page 127</p>



Marvell Technology Group
<http://www.marvell.com>

Marvell. Moving Forward Faster