

Overview

HP Elite Mini 800 G9 Desktop PC



1. Type-C® SuperSpeed USB 20Gbps signaling rate port (charge support up to 5V/3A)
2. Type-A SuperSpeed USB 10Gbps signaling rate port
3. Type-A SuperSpeed USB 10Gbps signaling rate port (Charge support up to 5V/1.5A)
4. Combo Audio Jack with CTIA and OMTP headset support
5. Dual-state power button
6. Hard drive activity light

Overview

HP Elite Mini 800 G9 Desktop PC

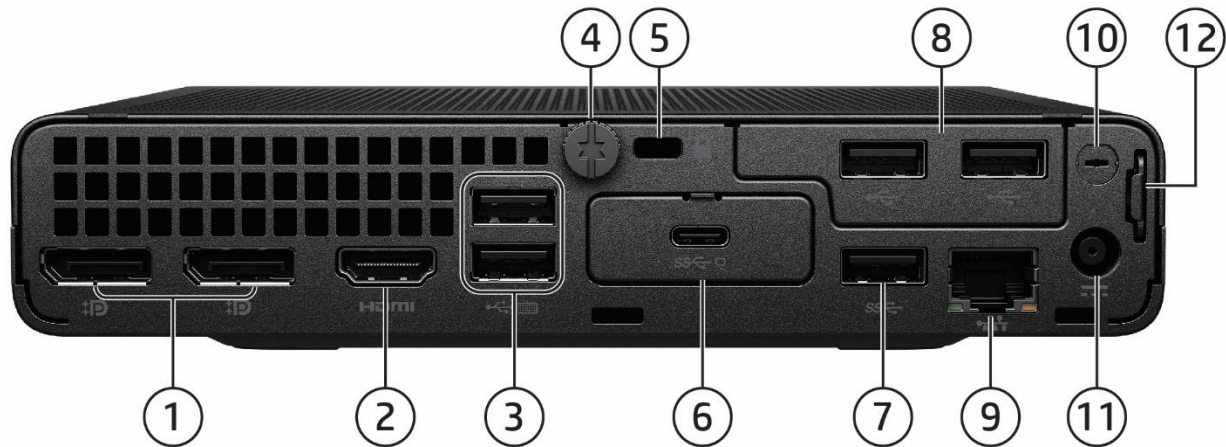

1. (2) Dual-Mode DisplayPort™ 1.4a (DP++)
2. HDMI port 2.1
3. (2) Type-A SuperSpeed USB 10Gbps signaling rate port (Supporting wake from S4/S5 with keyboard/mouse connected and enabled in BIOS)
4. Cover release thumbscrew
5. Standard cable lock slot (10 mm)
6. (1) Flex Port 1, choice of:
 - HDMI 2.1
 - VGA
 - DisplayPort™
 - Type-C™ SuperSpeed USB 10Gbps signaling rate port w/ DisplayPort™ Alt Mode and 100W Power Intake
 - Intel® I225-LM 2.5 Gigabit Network Connection LOM (non-vPro)
 - Dual Type A SuperSpeed USB 5Gbps signaling rate port
 - Fiber NIC 1Gbps¹
 - Serial²
 - Thunderbolt 3.0 with USB 4.0²
7. Type-A SuperSpeed USB 10Gbps signaling rate port
8. (1) Flex Port 2³, choice of:
 - NVIDIA GeForce 3050 Ti discrete GPU
 - Dual Type-A Hi-Speed USB 480Mbps signaling rate port
 - Serial
 - Second external antenna
9. RJ45 network connector
10. External WLAN antenna opening³
11. Power connector
12. Retractable Padlock loop

Not shown

Slots

- (1) Internal M.2 2230 connector for WLAN
- (2) Internal M.2 SSD storage 2280 connector⁴

Bays

- (1) 2.5- inch SATA drive Bay (not available on discrete graphics sku)

Mounting

Support for

- VESA Sleeve Standalone
- Quick Release Bracket
- B300/B500 Mounting bracket
- Integrated Work Center Stand

1. Fiber NIC 1Gbps cards would not be available in some selected Europe countries and Korea. And Does not support PXE boot.
2. Sold separately or as an optional feature.
3. Must be configured at time of purchase.
4. When a 2nd M.2 SSD is installed after purchase in 65W CPU SKU configs, then After Market Option SATA Drive Bay Kit v2 (13L70AA) is needed.

Overview

HP Elite SFF 800 G9 Desktop PC

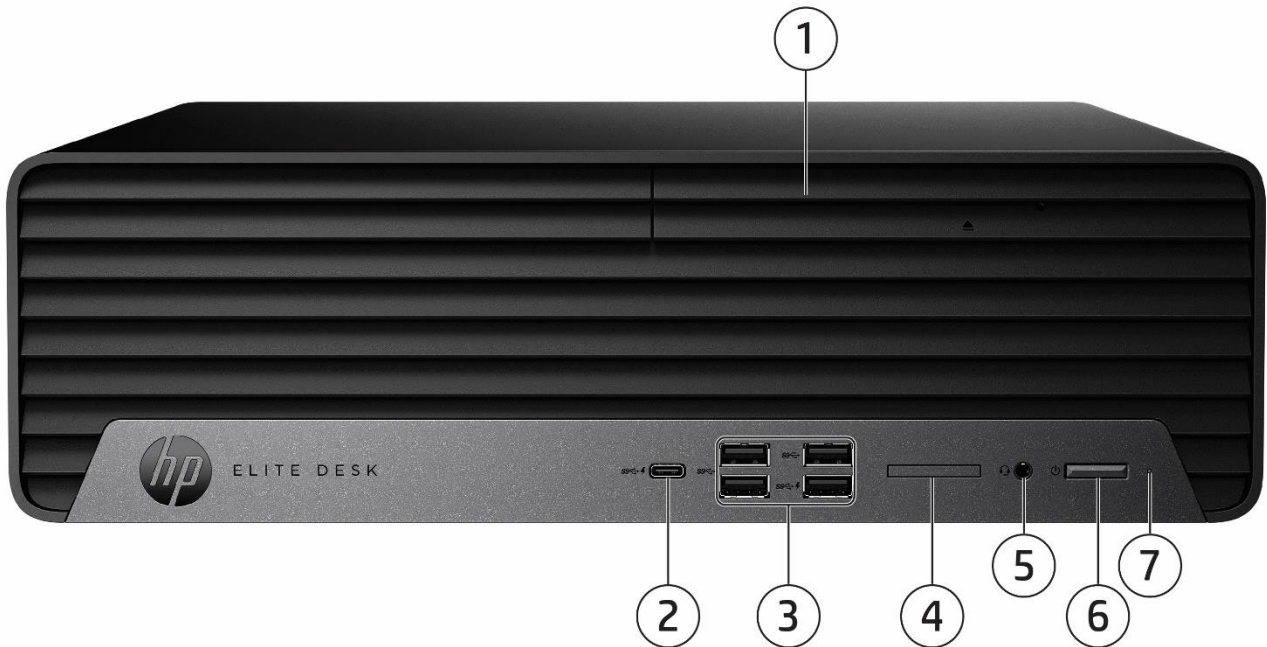

1. Slim optical drive (optional)
2. Type-C® SuperSpeed USB 20Gbps signaling rate port (charge support up to 5V/3A)
3. (4) Type A SuperSpeed USB 10Gbps signaling rate port (1 with charge support up to 5V/1.5A)
4. SD 4 Card Reader (optional)
5. Combo Audio Jack with CTIA and OMTP headset support
6. Dual-state power button
7. Hard drive activity light

Not shown

- (1) PCI Express Gen4 x16¹
- (1) PCI Express Gen3 x16 (wired as x4)
- (2) PCI Express x1
- (3) M.2 (1 as M.2 2230 socket for WLAN/BT and 2 as M.2 2280 socket for storage)

1. Only discrete graphics cards can be inserted.

Overview

HP Elite SFF 800 G9 Desktop PC

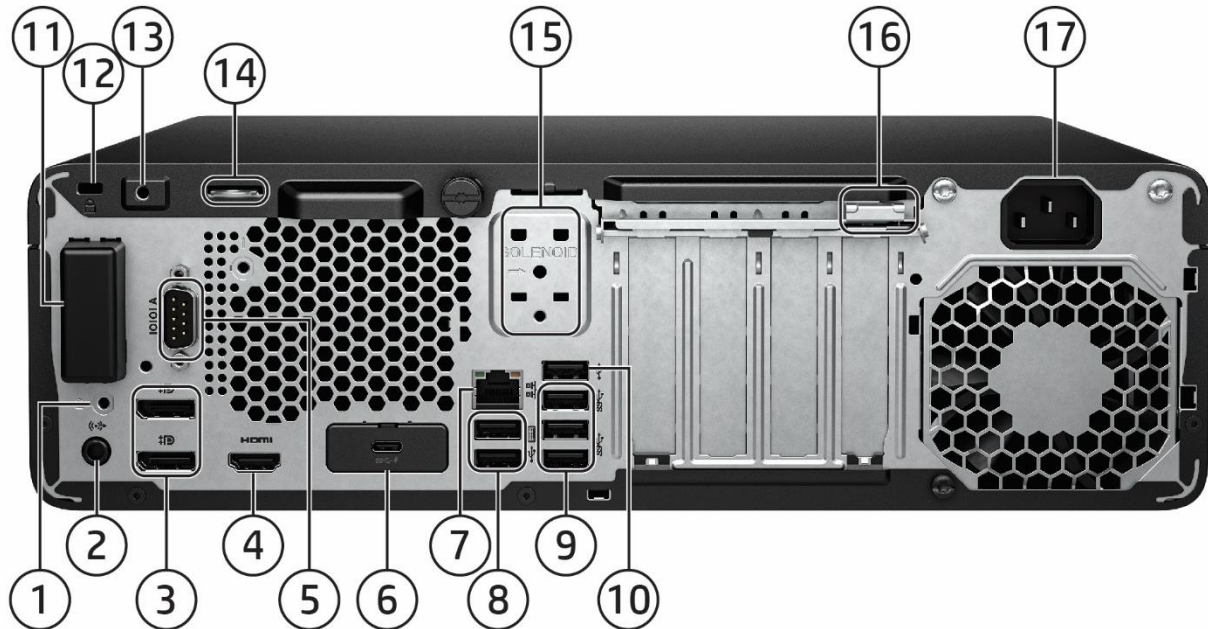

- | | |
|---|--|
| <ol style="list-style-type: none"> 1. External antenna (select products only) 2. Audio line-out jack (supports line-in re-tasking) 3. (2) Dual-Mode DisplayPort™ 1.4a (DP++) 4. HDMI port 1.4b 5. Optional Serial port (shown here installed) 6. Optional port, choice of (shown here USB-C® installed): <ul style="list-style-type: none"> • DisplayPort™ 1.4a • Serial • HDMI 2.1 • Dual Type-A SuperSpeed USB 5Gbps signaling rate port • USB-C® SuperSpeed 10Gbps signaling rate port (Alt Mode DP 1.4 with 15W output) • VGA 7. RJ45 network connector | <ol style="list-style-type: none"> 8. (2) Type A Hi-Speed USB 480 Mbps signaling rate port with wake from S4/S5 9. (3) Type A SuperSpeed USB 5Gbps signaling rate port 10. (1) Type A Hi-Speed USB 480 Mbps signaling rate port 11. Internal WLAN antenna cover (optional, shown here not installed) 12. Standard cable lock slot 13. Business Lock (optional, shown here not installed) 14. Pad lock 15. Intrusion sensor / hood lock (optional, shown here not installed) 16. Integrated keyboard/mouse wire hoop 17. Power cord connector |
|---|--|

Not shown

Optional Ports

Thunderbolt™ 3 port card¹

PS/2 & serial port card (connected to the mainboard via a flyer cable)¹

Parallel port¹

1. Each of the legacy port options would occupy one rear slot.

Bays

(2) 3.5" internal storage drive bay

(1) Slim optical drive bay (ODD or removable storage)

Overview

HP Elite Tower 800/880 G9 Desktop PC

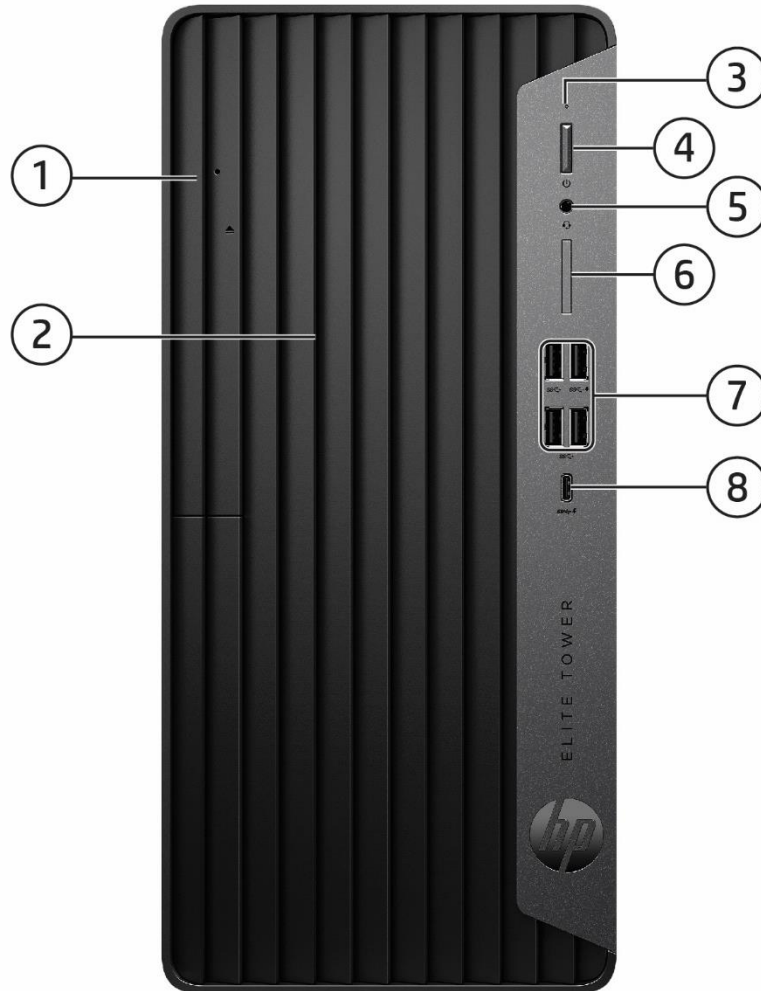

1. Slim optical drive bay (optional)
2. Slim optical bay for M.2 SSD (optional)
3. Hard drive activity light
4. Dual-state power button
5. Combo Audio Jack with CTIA and OMTP headset support
6. SD card 4.0 reader (optional)
7. (4) Type-A SuperSpeed USB 10Gbps signaling rate port (1 with charge support up to 5V/1.5A)
8. Type-C® SuperSpeed USB 20Gbps signaling rate port (charge support up to 5V/3A)

Not shown

- (1) PCI Express Gen4 x16¹
- (1) PCI Express Gen3 x16 (wired as x4)
- (2) PCI Gen3 x1
- (3) M.2 (1 as M.2 2230 socket for WLAN/BT and 2 as M.2 2280 socket for storage)

1. Only discrete graphics cards can be inserted.

Overview

HP Elite Tower Desk 800/880 G9 Desktop PC

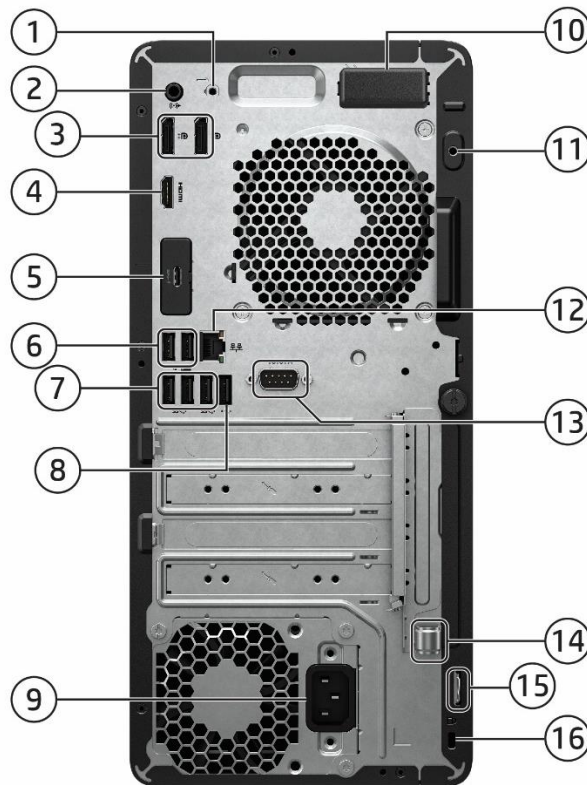

- | | |
|--|---|
| <ol style="list-style-type: none"> 1. External WLAN antenna (select products only) 2. Audio line-out jack (supports line-in re-tasking) 3. (2) Dual-Mode DisplayPort™ 1.4a (DP++) 4. HDMI port 1.4b 5. Flex port, choice of (shown here HDMI installed): <ul style="list-style-type: none"> • DisplayPort™ 1.4a • HDMI 2.1 • VGA • USB-C® SuperSpeed USB 10Gbps signaling rate port (USB-C® option has alt mode DisplayPort™ 1.4 and 15W output) 6. (2) Type A Hi-Speed USB 480 Mbps signaling rate port with wake from S4/S5 | <ol style="list-style-type: none"> 7. (3) Type A SuperSpeed USB 5Gbps signaling rate port 8. (1) Type A Hi-Speed USB 480 Mbps signaling rate port 9. Power cord connector 10. Internal WLAN antenna (optional, shown here installed) 11. Business Lock (optional, shown here not installed) 12. RJ-45 (network) jack 13. Serial port (optional, shown here installed) 14. Integrated keyboard/mouse wire hoop 15. Pad Lock 16. Standard cable lock slot |
|--|---|

Not shown

Optional ports

- Thunderbolt™ 3 card¹
- PS/2 & serial port card (connected to mainboard via a flyer cable)¹
- Parallel Port¹

Bays

- (2) 3.5" internal storage drive bay
- (2) Slim optical drive bay (optional, ODD and removable storage)

¹ Each of the legacy options will occupy one rear slot.

Overview

HP EliteOne 840 23.8 inch & 870 27 inch G9 All-in-One Desktop PC Touch/Non-Touch



- 1. Camera (optional)
- 2. Speakers (optional)

- 3. Wireless Charger (in base) (optional)

Overview

HP EliteOne 840 23.8 inch & 870 27 inch G9 All-in-One Desktop PC Touch/Non-Touch

5MP Webcam with Temporal Noise Reduction (TNR) (optional)

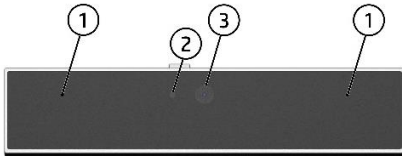

1. Dual Microphones
2. Webcam Light
3. Webcam

5MP Webcam +IR Sensor + Time-of-Flight (TOF) Sensor (optional)

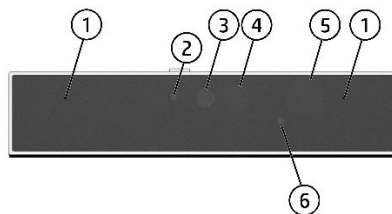

1. Dual Microphones
2. Webcam Light
3. Webcam
4. IR Sensor
5. IR Light
6. CLS Sensor

16MP (4MP Binning) Swivel Webcam +IR Sensor + Color Light Sensor + Time of Flight Sensor (TOF) (optional)

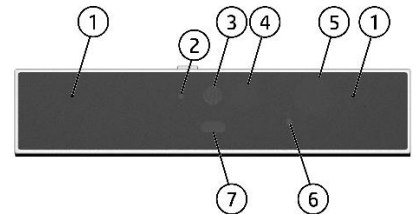

1. Dual Microphones
2. Webcam Light
3. Webcam
4. IR Sensor
5. IR Light
6. CLS Sensor
7. TOF Sensor

Overview

HP EliteOne 840 23.8 inch & 870 27 inch G9 All-in-One Desktop PC Touch/Non-Touch



1. Type-A SuperSpeed USB 10Gbps signaling rate port (charge support up to 5V/3A)
2. Type-C® SuperSpeed USB 20Gbps signaling rate port (charge support up to (5V/3A)
3. Combo Audio Jack with CTIA and OMTP headset Support

Overview

HP EliteOne 840 23.8 inch G9 All-in-One Desktop PC Touch/Non-Touch

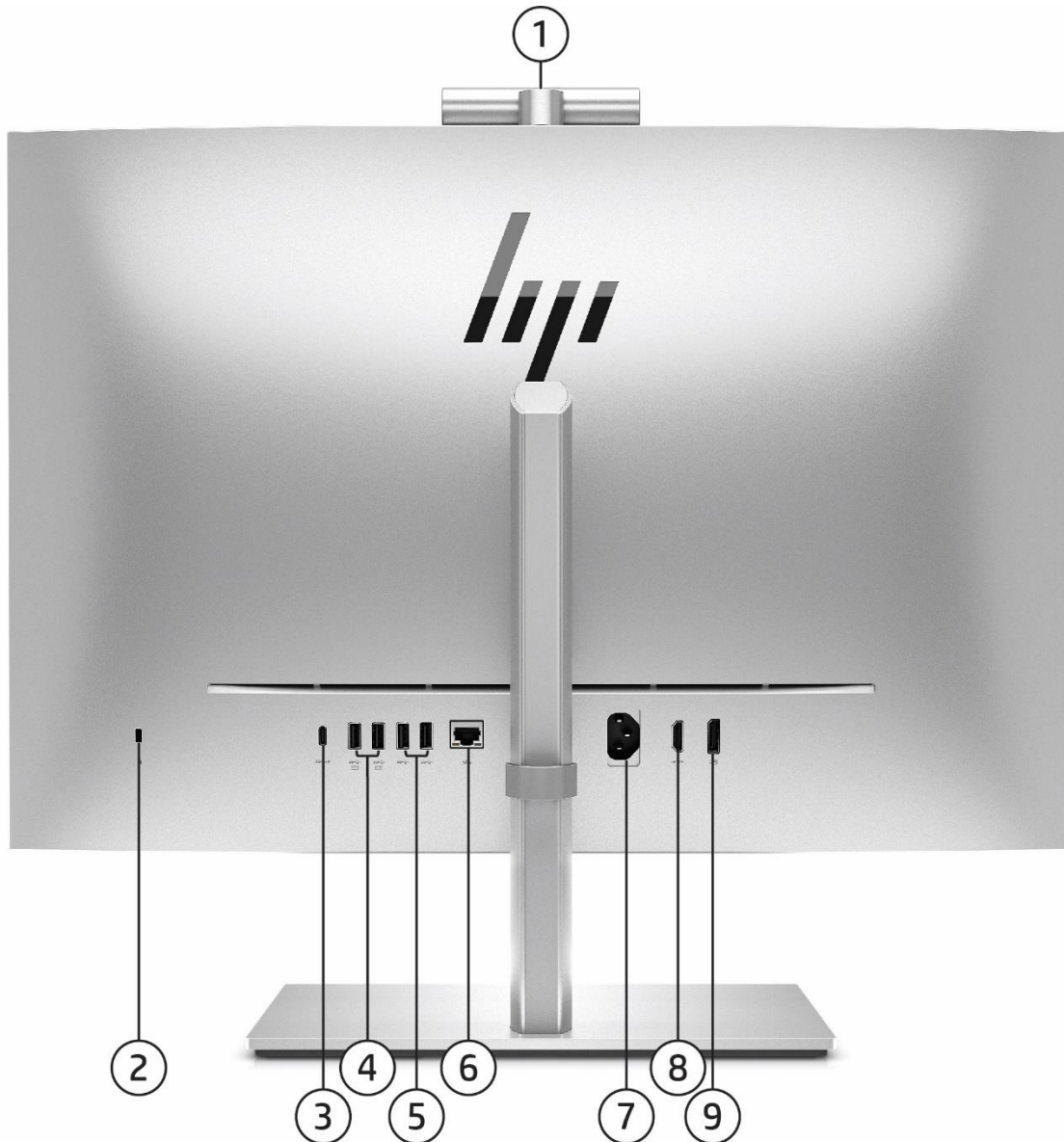

Rear components and rear ports

- | | |
|---|--------------------------------------|
| 1. Camera (optional) | 6. RJ-45 network connector/jack |
| 2. Standard Cable Lock Slot | 7. Power Connector |
| 3. Type-C® SuperSpeed USB 10Gbps signaling rate port (USB-C® option has alt mode DisplayPort™ 1.4 and 15W output) | 8. HDMI-in 1.4 connector |
| 4. Type-A SuperSpeed USB 5Gbps signaling rate port (x2) | 9. Dual-Mode DisplayPort™ 1.4 (DP++) |
| 5. Type-A SuperSpeed USB 10Gbps signaling rate port (x2) | |

Overview

HP EliteOne 870 27 inch G9 All-in-One Desktop PC Touch/Non-Touch

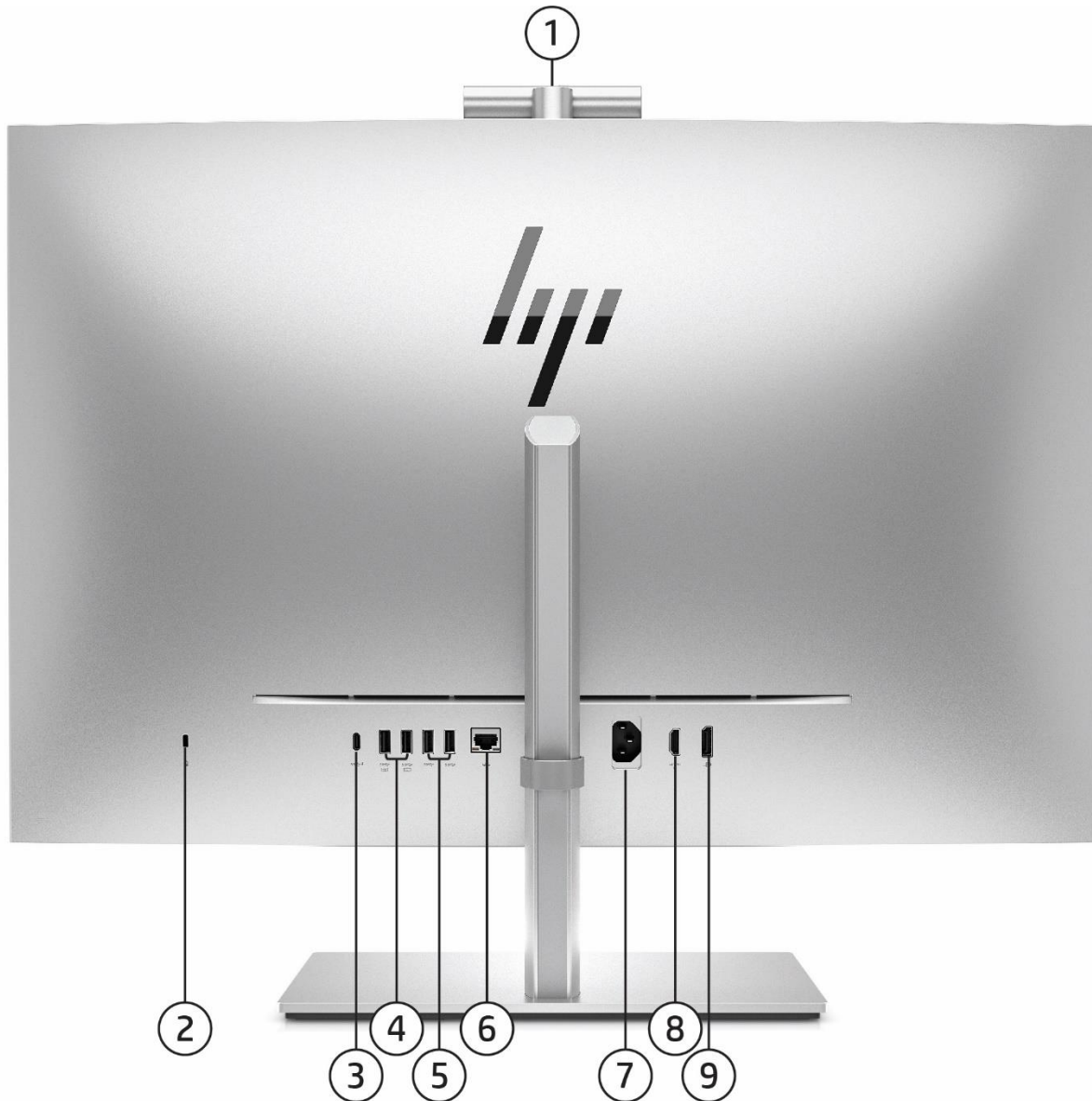

Rear components and rear ports

- | | |
|---|-------------------------------------|
| 1. Camera (optional) | 6. RJ-45 network connector/jack |
| 2. Standard Cable Lock Slot | 7. Power Connector |
| 3. Type-C® SuperSpeed USB 10Gbps signaling rate port (USB-C® option has alt mode DisplayPort™ 1.4 and 15W output) | 8. HDMI-in 1.4 connector |
| 4. Type-A SuperSpeed USB 5Gbps signaling rate port (x2) | 9. Dual-Mode DisplayPort™1.4 (DP++) |
| 5. Type-A SuperSpeed USB 10Gbps signaling rate port (x2) | |

Overview

HP EliteOne 840 23.8 inch & 870 27 inch G9 All-in-One Desktop PC Touch/Non-Touch

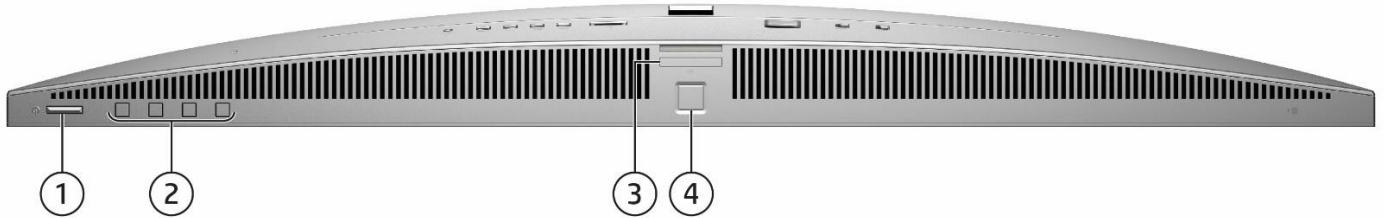

Bottom

1. Dual-State Power button
2. OSD control buttons
3. SD card reader 4.0 (optional)
4. Fingerprint Sensor (optional)

Not shown

Slots

- (1) internal M.2 PCIe x1 connector for optional wireless NIC
- (3) internal M.2 PCIe x4 connector for optional M.2 SSD storage

VESA

Support for VESA 100 mounting system on back of PC chassis (mounting hardware sold separately)

Features

AT A GLANCE

- Choice of four form factors: Mini, Small Form Factor, Tower Desktop PC and All-In-One
- HP developed and engineered UEFI V2.7 BIOS supporting security, manageability, and software image stability
- Intel® Q670 chipset supporting Intel® 12th & 13th generation Core™ processors, featuring integrated Intel® UHD Graphics and Intel® vPro® Technology (available with Core i5-12500(T), i5-13500(T) and above processors)
- Support up to three (3) M.2 storage slots (All-in-One)
- Intel® UHD graphics with optional NVIDIA & AMD Radeon™ discrete graphics
- Intel® Ethernet Connection I219LM GbE LOM integrated network connection
- Intel® Wi-Fi 6E AX211 (2x2) and Bluetooth® 5.3 Wireless Card².
- DDR5 Synchronous Dynamic Random Access Memory (SDRAM) (Transfer rates up to 4800 MT/s for Mini and AIO, up to 4400 MT/s for Tower and SFF)
- 5600MHz DDR5 Synchronous Dynamic Random Access Memory (SDRAM) (Transfer rates up to 5200 MT/s for AIO)**
- Support up to 8 monitors via two standard DisplayPort™ 1.4a ports, one standard HDMI 2.1 (Mini) or HDMI 1.4b (Tower/SFF), and a configurable Flex I/O port for video options and a discrete graphics card on Tower, SFF and Mini. All-in-One supports up to two additional monitors via DisplayPort™, or Type-C® USB in alternate mode.
- Configurable FlexPort which provides the following choices: HDMI 2.1, Serial, VGA, DisplayPort™ 1.4a, or USB Type-C® with DisplayPort™ 1.4 (USB Type-C® with DisplayPort™ 1.4 with Power Delivery [PD] on Mini), Thunderbolt 3 (PCIe card on TWR, SFF), Thunderbolt 3 with USB4.0 (port on Mini), and Dual USB Type-A for (Tower, SFF and Mini). See Ports section for port availability by platform. FlexPort is not supported on All-in-One.
- Power consumption of Desktop Mini PC varies per configuration, for the best user experience, please connect PC power cord while using USB-C® cable via Super Speed USB Type-C® port in the rear side of the platform.
- 2nd FlexPort available for configuration on the HP Elite Mini G9 Desktop PCs with the following ports: mini-DisplayPort™ ports and micro-HDMI (when configured with discrete graphic card), Serial, Dual USB Type-A, and 2nd external antenna.
- Configurable NVIDIA® GeForce® discrete graphics card with (3) mini-DisplayPort™ ports and (1) micro-HDMI video port for Mini to support up to (8) monitors with 4K resolution
- Configurable, NVIDIA® GeForce® VR ready and NVIDIA® Quadro® discrete graphics on Tower¹
- Models can be configured with multiple data drives in a RAID array and support RAID 1 configured from factory. Systems can be put into RAID1 and RAID0 configurations outside of the factory by adding the appropriate 2nd storage device. To enable RAID1 function, system should be configured with the same type and capacity storage device. SFF and TWR desktop PCs support a 3rd non-RAID storage when 2 drives are configured with RAID; the Mini desktop PC does not support a 3rd non-RAID drive when 2 drives are configured with RAID.
- Audio by Bang & Olufsen (All-in-One)
- HP Eye Ease TÜV Certified Integrated Low Blue Light Panels (All-in-One)
- TÜV Low Noise Certified
- Multicamera software support of an additional webcam (optional) (sold separately) (All-in-One)
- Enhanced Security with HP Security Suite (Refer to Security Section for details)
- ENERGY STAR® certified models available. EPEAT® registered where applicable. Based on US EPEAT® registration according to IEEE 1680.1-2018 EPEAT®. EPEAT® status varies by country. Visit <http://www.epeat.net> for more information.
- CCC, CECP and SEPA Certified (TWR/SFF/Mini Desktop/All-in-One)
- TCO Edge for All-in-One & TCO 9.0 for Tower/SFF/Mini Desktop
- PC chassis and all internal components and modules are manufactured with low halogen content
- Dust filter available for the following platforms (Mini Desktop PC SFFs and Tower)
- Protected by HP Services, including limited warranties up to 1-1-1 (terms and conditions vary by country; certain restrictions and exclusions apply); Care Packs are available up to 5 years Next Business Day Onsite Hardware Support.
- Compliance with CE (Class B) / FCC (Class B) / UL (UL60950-1 /UL62368-1) / CSA (CSA C22.2 No.60950-1-07 / CSA C22.2 No. 62368-1-14) / ICES-003 / CCC / VCCI (Class B) / KCC (Class B)

1. VR-ready as optional feature, specific configuration to support: 800 TWR with the Nvidia GeForce 3070 LRH card.

NOTE: See important legal disclosures for all listed specs in their respective feature sections

Features

PRODUCT NAME

- HP Elite Mini 800 G9 Desktop PC
- HP Elite SFF 800 G9 Desktop PC
- HP Elite Tower 800/880 G9 Desktop PC
- HP EliteOne 840 23.8 inch G9 All-in-One Desktop PC
- HP EliteOne 870 27 inch G9 All-in-One Desktop PC

OPERATING SYSTEM

- Preinstalled**
- Windows 11 Pro¹
 - Windows 11 Pro Education¹
 - Windows 11 Home - HP recommends Windows 11 Pro for business¹
 - Windows 11 Home Single Language - HP recommends Windows 11 Pro for business¹
 - Windows 11 Pro (preinstalled with Windows 10 Pro Downgrade)^{1,2}
 - Windows 11 Pro (Windows 11 Enterprise or Windows 10 Enterprise available with a Volume Licensing Agreement)¹
 - FreeDOS

1. Not all features are available in all editions or versions of Windows. Systems may require upgraded and/or separately purchased hardware, drivers, software or BIOS update to take full advantage of Windows functionality. Windows is automatically updated and enabled. High speed internet and Microsoft account required. ISP fees may apply and additional requirements may apply over time for updates. See <http://www.windows.com>.

2. This system is preinstalled with Windows 10 Pro software and also comes with a license for Windows 11 Pro software and provision for recovery software. You may only use one version of the Windows software at a time. Switching between versions will require you to uninstall one version and install the other version. You must back up all data (files, photos, etc.) before uninstalling and installing operating systems to avoid loss of your data.

CHIPSET

	<u>Mini</u>	<u>SFF</u>	<u>TWR</u>	<u>AiO</u>
Intel® Q670	<u>X</u>	<u>X</u>	<u>X</u>	<u>X</u>

Features

PROCESSORS

Intel® 12th Generation Core™ Processors	<u>Mini</u>	<u>SFF</u>	<u>TWR</u>	<u>AiO</u>
Intel® Core™ i9-12900 Processor with Intel® UHD Graphics 770 (2.4GHz, up to 5.1 GHz with Intel® Turbo Boost Max Technology ¹ , 30MB L3 cache, 16 cores) 65W ² . Supports Intel® vPro® Technology ³	X	X	X	X
Intel® Core™ i9-12900T Processor with Intel® UHD Graphics 770 (1.4GHz, up to 4.9GHz with Intel® Turbo Boost Technology ¹ , 30MB cache, 16 cores) 35W ² . Supports Intel® vPro® Technology ³	X			
Intel® Core™ i7-12700 processor with Intel® UHD Graphics 770 (2.1 GHz, up to 4.9 GHz with Intel® Turbo Boost Technology ¹ , 25 MB L3 cache, 12 cores) 65W ² . Supports Intel® vPro® Technology ³	X	X	X	X
Intel® Core™ i7-12700T Processor with Intel® UHD Graphics 770 (1.4 GHz, up to 4.7 GHz with Intel® Turbo Boost Technology ¹ , 25MB cache, 12 cores) 35W ² . Supports Intel® vPro® Technology ³	X			
Intel® Core™ i5-12600 processor with Intel® UHD Graphics 770 (3.3 GHz, up to 4.8 GHz with Intel Turbo Boost Technology ¹ , 18 MB cache, 6 cores) 65W ² . Supports Intel® vPro® Technology ³	X	X	X	X
Intel® Core™ i5-12600T processor with Intel® UHD Graphics 770 (2.1GHz, up to 4.6 GHz with Intel Turbo Boost Technology ¹ , 18 MB cache, 6 cores) 35W ² . Supports Intel® vPro® Technology ³	X			
Intel® Core™ i5-12500 processor with Intel® UHD Graphics 770 (3.0GHz, up to 4.6 GHz with Intel Turbo Boost Technology ¹ , 18 MB cache, 6 cores) 65W ² . Supports Intel® vPro® Technology ³	X	X	X	X
Intel® Core™ i5-12500T processor with Intel® UHD Graphics 770 (2.0GHz, up to 4.4 GHz with Intel Turbo Boost Technology ¹ , 18 MB cache, 6 cores) 35W ² . Supports Intel® vPro® Technology ³	X			
Intel® Core™ i5-12400 processor with Intel® UHD Graphics 730 (2.5 GHz, up to 4.4 GHz with Intel Turbo Boost Technology ¹ , 18 MB cache, 6 cores) 65W ² .	X	X	X	X
Intel® Core™ i5-12400T processor with Intel® UHD Graphics 730 (1.8GHz, up to 4.2 GHz with Intel Turbo Boost Technology ¹ , 18 MB cache, 6 cores) 35W ² .	X			
Intel® Core™ i3-12300 processor with Intel® UHD Graphics 730 (3.5GHz, up to 4.4 GHz with Intel Turbo Boost Technology ¹ , 12 MB cache, 4 cores) 65W ² .	X	X	X	X
Intel® Core™ i3-12300T processor with Intel® UHD Graphics 730 (2.3GHz, up to 4.2 GHz with Intel Turbo Boost Technology ¹ , 12 MB cache, 4 cores) 35W ² .	X			
Intel® Core™ i3-12100 processor with Intel® UHD Graphics 730 (3.3GHz, up to 4.3 GHz with Intel Turbo Boost Technology ¹ , 12 MB cache, 4 cores) 65W ² .	X	X	X	X

Features

Intel® Core™ i3-12100T processor with Intel® UHD Graphics 730 (2.2GHz, up to 4.1 GHz with Intel Turbo Boost Technology ¹ , 12 MB cache, 4 cores) 35W ² .	X			
Intel® 13th Generation Core™ Processors	Mini	SFF	TWR	AiO
Intel® Core™ i9-13900 Processor with Intel® UHD Graphics 770 (P-core Max turbo frequency up to 5.2 GHz, up to 5.5 GHz with Intel® Turbo Boost Max Technology ¹ , 36MB L3 cache, 24 cores) 65W ² . Supports Intel® vPro® Technology ³	X	X	X	X
Intel® Core™ i9-13900T Processor with Intel® UHD Graphics 770 (P-core Max turbo frequency up to 5.1 GHz, up to 5.3GHz with Intel® Turbo Boost Technology ¹ , 36MB cache, 24 cores) 35W ² . Supports Intel® vPro® Technology ³	X			
Intel® Core™ i7-13700 processor with Intel® UHD Graphics 770 (P-core Max turbo frequency up to 5.1 GHz, up to 5.2 GHz with Intel® Turbo Boost Technology ¹ , 30 MB L3 cache, 16 cores) 65W ² . Supports Intel® vPro® Technology ³	X	X	X	X
Intel® Core™ i7-13700T Processor with Intel® UHD Graphics 770 (P-core Max turbo frequency up to 4.8 GHz, up to 4.9 GHz with Intel® Turbo Boost Technology ¹ , 30MB cache, 16 cores) 35W ² . Supports Intel® vPro® Technology ³	X			
Intel® Core™ i5-13600 processor with Intel® UHD Graphics 770 (P-core Max turbo frequency up to 5.0 GHz, 24 MB cache, 14 cores) 65W ² . Supports Intel® vPro® Technology ³	X	X	X	X
Intel® Core™ i5-13600T processor with Intel® UHD Graphics 770 (P-core Max turbo frequency up to 4.8 GHz, 20 MB cache, 14 cores) 35W ² . Supports Intel® vPro® Technology ³	X			
Intel® Core™ i5-13500 processor with Intel® UHD Graphics 770 (P-core Max turbo frequency up to 4.8 GHz, 24 MB cache, 14 cores) 65W ² . Supports Intel® vPro® Technology ³	X	X	X	X
Intel® Core™ i5-13500T processor with Intel® UHD Graphics 770 (P-core Max turbo frequency up to 4.6 GHz, , 20 MB cache, 14 cores) 35W ² . Supports Intel® vPro® Technology ³	X			
Intel® Core™ i5-13400 processor with Intel® UHD Graphics 730 (P-core Max turbo frequency up to 4.6 GHz, 20 MB cache, 10 cores) 65W ² .	X	X	X	X
Intel® Core™ i5-13400T processor with Intel® UHD Graphics 730 (P-core Max turbo frequency up to 4.4 GHz,, 20 MB cache, 10 cores) 35W ² .	X			
Intel® Core™ i3-13100 processor with Intel® UHD Graphics 730 (P-core Max turbo frequency up to 4.5 GHz, 12 MB cache, 4 cores) 65W ² .	X	X	X	X
Intel® Core™ i3-13100T processor with Intel® UHD Graphics 730 (P-core Max turbo frequency up to 4.2 GHz, , 12 MB cache, 4 cores) 35W ² .	X			

1. Intel® Turbo Boost technology requires a PC with a processor with Intel Turbo Boost capability. Intel Turbo Boost performance varies depending on hardware, software and overall system. See <http://www.intel.com/technology/turboboost> for more information.

2. Multi-core is designed to improve performance of certain software products. Not all customers or software applications will necessarily benefit from use of this technology. Performance and clock frequency will vary depending on application workload and your hardware and software



Features

configurations. Intel's numbering, branding and/or naming is not a configuration measurement of higher performance.

3. For full Intel® vPro® functionality, Windows 10 Pro 64 bit, a vPro supported processor, vPro enabled chipset, vPro enabled wired LAN and/or WLAN card and TPM 2.0 are required. See <http://intel.com/vpro>. Some functionality of vPro technology, such as Intel Active management technology and Intel Virtualization technology, requires additional 3rd party software in order to run. Availability of future "virtual appliances" applications for Intel vPro technology is dependent on 3rd party software providers. Compatibility of this generation of Intel vPro technology-based hardware with future "virtual appliances" is yet to be determined.

GRAPHICS

Integrated Intel® Graphics

	<u>Mini</u>	<u>SFF</u>	<u>TWR</u>	<u>AiO</u>
Intel® UHD Graphics 770 (integrated in 12 th & 13 th gen Core i5-1x500(T), and above processors)	X	X	X	X
Intel® UHD Graphics 730 (integrated in 12 th & 13 th gen Core i5-1x400(T), and i3 processors)	X	X	X	X

Optional Discrete Graphics Solutions

	<u>Mini</u>	<u>SFF</u>	<u>TWR</u>	<u>AiO</u>
NVIDIA® GeForce® RTX 3070 8GB GDDR6 LHR Graphics card ¹			X	
NVIDIA® GeForce® RTX 3050Ti 4GB GDDR6 Graphics card	X ²			X
NVIDIA® GeForce® RTX 3050 8GB GDDR6 Graphics card ^{3,4}			X	
NVIDIA® GeForce® RTX 3060 12GB GDDR6 Graphics card ³			X	
NVIDIA® T400 2GB GDDR6 3 mDP Graphics card ⁵		X	X	
NVIDIA® T400 4GB GDDR6 Graphics card		X	X	
Intel® Arc™ A380 6GB GDDR6 Graphics card ⁴			X	
AMD Radeon™ RX 6300 2GB GDDR6 Graphics card		X	X	

1. Requires the 550W chassis

2. Only available on the Desktop Mini with a 35W Processor and supports (3) Mini DP 1.4 Ports and (1) Micro –HDMI 2.0 port in order to drive up to 8 displays directly on the Desktop Mini.

3. Not available with the 260W chassis.

4. Only available with the 13th Generation processors.

5. Only available with the 12th Generation processors.

Adapters and Cables

	<u>Mini</u>	<u>SFF</u>	<u>TWR</u>	<u>AiO</u>
HP DisplayPort™ Cable	X	X	X	X
HP DisplayPort™ to DVI-D Adapter	X			X
HP DisplayPort™ to HDMI True 4K Adapter	X	X	X	X
HP DisplayPort™ to VGA Adapter	X	X	X	X
HP USB to Serial Port Adapter	X	X	X	X
HP USB-C® to HDMI Adapter				X
HP USB-C® to DisplayPort™ Adapter				X
HP HDMI Standard Cable Kit (HDMI)		X	X	X
50cm USB-C Cable (100W power delivery)	X			

Features

STORAGE

NOTE: Starting November 1, 2023, HP PCs with Windows require Windows to be installed on SSD. HDD can only be configured as additional data drives and not as the boot drive.

3.5 inch SATA Hard Disk Drives (HDD)

	<u>Mini</u>	<u>SFF</u>	<u>TWR</u>	<u>AiO</u>
500GB* 7200RPM SATA HDD		X	X	
1TB* 7200RPM SATA HDD		X	X	
2TB* 7200RPM SATA HDD		X	X	

2.5 inch SATA Hard Disk Drives (HDD)

	<u>Mini</u>	<u>SFF**</u>	<u>TWR**</u>	<u>AiO</u>
500GB* 7200RPM SATA HDD	X	X	X	
1TB* 7200RPM SATA HDD	X	X	X	
2TB* 5400RPM SATA HDD	X			
500GB 7200RPM Self Encrypted OPAL2 SATA HDD**	X	X	X	

* Storage DriveLock does not work with Self Encrypting or Optane based storage.

** 2.5 inch SATA Hard Disk Drives are only available with the removable Hard Disk Drive carrier, and as the primary drive only on Tower and SFF.

M.2 PCIe NVMe Solid State Drives (SSD)¹

	<u>Mini</u>	<u>SFF</u>	<u>TWR</u>	<u>AiO</u>
256GB M.2 2280 PCIe NVMe SSD	X	X	X	X
512GB M.2 2280 PCIe NVMe SSD	X	X	X	X
1TB M.2 2280 PCIe NVMe SSD	X	X	X	X
256GB M.2 2280 PCIe NVMe Three Layer Cell SSD ³	X	X	X	X
512GB M.2 2280 PCIe NVMe Three Layer Cell SSD	X	X	X	X
1TB M.2 2280 PCIe NVMe Three Layer Cell SSD	X	X	X	X
2TB M.2 2280 PCIe NVMe Three Layer Cell SSD	X	X	X	X
256GB M.2 2280 PCIe NVMe Self Encrypted OPAL2 Three Layer Cell SSD ^{2, 3}	X	X	X	X
512GB M.2 2280 PCIe NVMe Self Encrypted OPAL2 Three Layer Cell SSD ²	X	X	X	X
256GB M.2 2280 PCIe OPAL2 NVMe SSD	X	X	X	X

1. For hard drives and solid state drives, GB = 1 billion bytes. TB = 1 trillion bytes. Actual formatted capacity is less. Up to 36 GB (for Windows) of system disk is reserved for the system recovery software

2. Storage DriveLock does not work with Self Encrypting or Optane based storage

3. Only available with the 12th Generation processors.

Optical Disc Drives

	<u>Mini</u>	<u>SFF</u>	<u>TWR</u>	<u>AiO</u>
HP 9.5mm Slim DVD-ROM Drive ¹		X	X	
HP 9.5mm Slim DVD Writer Drive ¹		X	X	

1. HD-DVD disks cannot be played on this drive. No support for DVD-RAM. Actual speeds may vary. Don't copy copyright-protected materials. Double Layer discs can store more data than single layer discs. Discs burned with this drive may not be compatible with many existing single-layer DVD drives and players.

Media Card Reader

	<u>Mini</u>	<u>SFF</u>	<u>TWR</u>	<u>AiO</u>
SD 4.0 with 5-in-1 Interface (Supports SD, SDXC, SDHC, UHS-I, UHS-II)		X	X	X

Features

NOTE: For hard drives and solid state drives, GB = 1 billion bytes. TB = 1 trillion bytes. Actual formatted capacity is less. Up to 36 GB (for Windows) of system disk is reserved for the system recovery software.

Features

MEMORY

Memory Type

	<u>Mini</u>	<u>SFF*</u>	<u>TWR*</u>	<u>AiO</u>
DDR5-4800 (Transfer rates up to 4800 MT/s), Max 64 GB, 2 SO-DIMM	X			X
DDR5-4800 UDIMM module, Max 128 GB, 4 DIMM slots		X	X	
DDR5-5600 (Transfer rates up to 5600 MT/s), Max 64 GB, 2 SO-DIMM				X

***NOTE:** Memory modules support data transfer rates up to 4800 MT/s; system speed up to 4400 MT/s, following Intel's design guideline. Actual data rate is determined by the system configuration.

***NOTE:** System architecture design is 2 DIMMS per channel and the population starts from the furthest memory slot from the processor.

***NOTE:** Symmetric configurations are required for the 2 DIMMs within the same memory channel.

***NOTE:** To achieve optimal memory speed, HP strongly recommends using identical memory modules (e.g., same capacity, same part number and from the same supplier) within the same memory channel

***NOTE:** All memory slots are customer accessible / upgradeable.

Memory Configuration

	<u>Mini</u>	<u>SFF</u>	<u>TWR</u>	<u>AiO</u>
8GB (1 x 8GB)	X	X	X	X
16GB (2 x 8GB)	X	X	X	X
32GB (4 x 8GB)		X	X	
16GB (1 x 16GB)	X	X	X	X
32GB (2 x 16GB)	X	X	X	X
64GB (4 x 16GB)		X	X	
32GB (1 x 32GB)	X	X	X	X
64GB (2 x 32GB)	X	X	X	X
128GB (4 x 32GB)		X	X	

Features

NETWORKING/COMMUNICATIONS

Ethernet (RJ-45)

	<u>Mini</u>	<u>SFF</u>	<u>TWR</u>	<u>AiO</u>
Intel® I219-LM 1 Gigabit Network Connection LOM (vPro)	X	X	X	X
Intel® Ethernet Network Adapter I225 (optional)	X	X	X	

Wireless

	<u>Mini</u>	<u>SFF</u>	<u>TWR</u>	<u>AiO</u>
Intel® Wi-Fi 6E AX211 + BT5.3 Wireless Card (802.11AX 2x2 vPro, supporting gigabit data rate ¹)	X	X	X	X
Intel® Wi-Fi 6E AX211 + BT5.3 Wireless Card (802.11AX 2x2 non-vPro, supporting gigabit data rate ¹)	X	X	X	X
Realtek RTL8852BE 802.11ax ² 2x2 Wi-Fi® 6 ¹ + BT5.3 Wireless Card	X	X	X	X

1. Wi-Fi 6 is designed to support gigabit data rate when transferring files between two devices connected to the same router. Requires a wireless router, sold separately, that supports 80MHz and higher channels.

2. Usage of the 6GHz band relies on Windows 11 Operating System support.

NOTE: All HP G9 Minis and AiOs support Wi-Fi 6E. HP 800 G9 TWR/SFF desktops with Intel® 13th Gen CPUs support Wi-Fi 6E.

NOTE: The HP 800 G9 TWR/SFF requires Intel® 13th Gen processor to support Wi-Fi 6E and requires a Wi-Fi 6E router, sold separately, to function in the 6GHz band. Availability of public wireless access points limited. Wi-Fi 6E is backwards compatible with prior 802.11 specs. Available in countries where Wi-Fi 6E is supported. For HP 800 G9 TWR/SFF without Intel® 13th Gen processors, the product does not support Wi-Fi 6E standard and does not operate under 6GHz band. The product is compatible with 6GHz and other routers, sold separately, which have capability to operate in 2.4GHz and 5GHz, in compliance with Wi-Fi 6 and prior 802.11 specs. The actual throughput depends on network condition and router configuration. Internet service required and public wireless access points are limited.

NOTE: WiFi-6E might be restricted by local regulation and only available in countries where Wi-Fi 6E is supported. HP will enable countries in the future by upgrading BIOS in default as the technology becomes available in more regions.

KEYBOARDS AND POINTING DEVICES

Keyboards

	<u>Mini</u>	<u>SFF</u>	<u>TWR</u>	<u>AiO</u>
HP Wired Desktop 320K Keyboard	X	X	X	X
HP USB Business Slim Wired SmartCard CCID Keyboard	X	X	X	X
HP Business Slim PS/2 Wired Keyboard		X	X	
HP 125 Wired Keyboard	X	X	X	X
HP 125 AntiMicrobial Wired Keyboard (China Only)	X	X	X	X

Keyboard and Mouse Combo

	<u>Mini</u>	<u>SFF</u>	<u>TWR</u>	<u>AiO</u>
HP 655 Wireless Keyboard and Mouse Combo	X	X	X	X

Mouse

	<u>Mini</u>	<u>SFF</u>	<u>TWR</u>	<u>AiO</u>
HP Wired 320M Mouse	X	X	X	X
HP PS/2 Mouse		X	X	
HP Wired 125 Mouse	X	X	X	X
HP Wired 128 Laser Mouse	X	X	X	X
HP Wired 125 Antimicrobial Mouse (China only)	X	X	X	X

Features

SECURITY

	<u>Mini</u>	<u>SFF</u>	<u>TWR</u>	<u>AiO</u>
TPM 2.0 endpoint security controller (Infineon SLB9672/Nuvoton NPCT760HABYX) shipped with Windows 11. Common Criteria EAL4+ Certified. FIPS 140-2 Level 2 Certified.	X	X	X	X
Solenoid Lock & Intrusion Sensor (optional)		X	X	
Intrusion Sensor for Mini/AiO (integrated in the PCA, can be enabled/disabled through BIOS)	X			X
Support for chassis cable lock devices	X (10 mm barrel or smaller)	X	X	X
Support for chassis padlocks devices	X	X	X	
HP Fingerprint Sensor (optional)				X
SATA port disablement (via BIOS)	X	X	X	
Serial, USB enable / disable (via BIOS)	X	X	X	X
Serial, parallel, USB enable / disable (via BIOS)	X	X	X	X
Optional USB Port Disable at factory (user configurable via BIOS)	X	X	X	X
Removable media write/boot control	X	X	X	X
Power-on password (via BIOS)	X	X	X	X
Setup password (via BIOS)	X	X	X	X

Features

PORTS

I/O Ports – Internal Ports

	<u>Mini</u>	<u>SFF</u>	<u>TWR</u>	<u>AiO</u>
PCI Express 4.0 x16		1	1	
PCI Express 3.0 x16 (wired as x4)		1	1	
PCI Express 3.0 x1		2	2	
SATA 3.0 (6Gbps) port.		4	4	
Internal SATA storage connector	1			
M.2 PCIe	(1) M.2 PCIe3 x1 2230 (for WLAN) (1) M.2 PCIe4 x4 2280 (for storage) (1) M.2 PCIe4 x4 2280 (for storage)	(1) M.2 PCIe 3 x1 2230 (for WLAN) (2) M.2 PCIe 4 x4 2280 (for storage)	(1) M.2 PCIe 3 x1 2230 (for WLAN) (2) M.2 PCIe 4 x4 2280 (for storage)	(1) M.2 WLAN+BT Combo; (3) M.2 2280 for NVME SSD storage. One attached to CPU PCIe Gen 4.0, Two attached to PCH PCIe Gen 3.0

NOTE: M.2 SSD attached to CPU is PCIe Gen 4, the other two M.2 are PCIe Gen 3 (AiO).

NOTE: For Mini with M.2 Storage config, there will be no SATA drive bracket. If you plan to use or upgrade the storage with any 2.5" SATA drive, please select a DM SATA Drive Bracket (available as both factory configured and after-market option).

NOTE: PCI slots for TWR are full height and SFF are low profile.

Standard User Accessible Ports

	<u>Mini</u>	<u>SFF</u>	<u>TWR</u>	<u>AiO</u>
Type-A Hi-Speed USB 480Mbps signaling rate port		3 (rear)	3(rear)	
Type-A SuperSpeed USB 5 Gbps signaling rate port		3 (rear)	3 (rear)	2 (rear)
Type-A SuperSpeed USB 10 Gbps signaling rate port	2(front) 3 (rear)	4 (front)	4 (front)	2 (rear) 1 (side)
Type-C® SuperSpeed USB 10Gbps signaling rate port (USB-C® option has alt mode DisplayPort™ 1.4 and 15W output)				1 (rear)
Type-C® SuperSpeed USB 20Gbps signaling rate port	1 (front)	1 (front)	1 (front)	1 (side)
Video ¹	2 DisplayPort™ 1.4a 1 HDMI 2.1	2 DisplayPort™ 1.4a 1 HDMI 1.4b	2 DisplayPort™ 1.4a 1 HDMI 1.4b	1 DisplayPort™ 1.4 (rear) 1 USB Type-C® with alt mode display (rear) 1 HDMI-In (rear)
Audio	1 Combo Audio Jack with CTIA and OMTP headset support (front)	1 Universal Audio Jack with CTIA and OMPT headset support (front); 1 Audio-Line-in/Line out (rear)	1 Universal Audio Jack with CTIA and OMPT headset support (front); 1 Audio-Line-in/Line out (rear)	1 CTIA/OMTP UAJ (side)

1. For actual resolution supported, refer to the Graphics section of this document.

Features

(1) Flexible Port 1, choice of one of the following:

	<u>Mini</u>	<u>SFF</u>	<u>TWR</u>	<u>AiO</u>
Dual Type-A SuperSpeed USB 5 Gbps signaling rate port	1	1	1	
Type-C® SuperSpeed USB 10Gbps signaling rate port	1 SuperSpeed USB 10Gbps signaling rate port w/ DisplayPort™ Alt Mode and power intake via USB Type-C® Power Delivery up to 100W	1	1	
Thunderbolt™ 3.0 with USB 4.0 ¹	1 ²	1	1	
Video	1 DisplayPort™ 1.4a <u>or</u> HDMI 2.1 <u>or</u> VGA	1 DisplayPort™ 1.4a <u>or</u> HDMI 2.1 <u>or</u> VGA	1 DisplayPort™ 1.4a <u>or</u> HDMI 2.1 <u>or</u> VGA	
Serial	1 ²	1	1	
Fiber NIC Adapter	1 1 Gbps NIC			
RJ-45 Ethernet NIC	1 2.5GbE			

1. Occupies a PCIe slot on TWR/SFF. Available in Q3, 2021.

2. Sold separately or as an optional feature.

(1) Flexible Port 2, choice of one of the following:

	<u>Mini</u>	<u>SFF</u>	<u>TWR</u>	<u>AiO</u>
Type-A USB	1 Dual Type-A Hi-Speed USB 480Mbps signaling rate port			
Serial	1			
Discrete Graphics	1			
2 nd External antenna	1			

NOTE: For Desktop Mini with M.2 Storage config, there will be no SATA drive bracket. If you plan to use or upgrade the storage with any 2.5" SATA drive, please select a DM SATA Drive Bracket (available as both factory configured and after market option).

Bays

	<u>Mini</u>	<u>SFF</u>	<u>TWR</u>	<u>AiO</u>
Slim Optical Disc Drive (ODD or removable storage, optional)		1	2	
SD Card Reader (optional)		1	1	1
2.5" Internal Storage Drive	1 ³			
3.5" Internal Storage Drive		2	2	

3. SATA 2.5" internal storage drive cannot be selected if discrete graphic card is selected.

Features

USB SPECIFICATION AND MARKETING NAME MAPPING TABLE

Marketing Name	Technical Terminology
Hi-Speed USB 480Mbps signaling rate	USB 2.0
SuperSpeed USB 5Gbps signaling rate	USB 3.2 Gen 1
SuperSpeed USB 10Gbps signaling rate	USB 3.2 Gen 2
SuperSpeed USB 20Gbps signaling rate	USB 3.2 Gen 2x2

Features

SOFTWARE COMPONENTS AND APPLICATIONS WITH WINDOWS

Software

- HP Easy Clean¹
- HP QuickDrop²
- HP PC Hardware Diagnostics UEFI
- HP Desktop Support Utilities
- HP Privacy Settings
- HP Setup Integrated OOBE
- HP Support Assistant³
- HP Notifications
- HP Connection Optimizer
- HP Smart Support⁴
- HP Services Scan⁵
- Buy Microsoft Office (sold separately)
- myHP_with Multicamera support (AIO&Mini)

Manageability Features

- HP Connect for Microsoft Endpoint Manager⁶
- HP Image Assistant Gen5 (download)
- HP Manageability Integration Kit (download)⁷
- HP Client Management Script Library (download)
- HP Patch Assistant (download)⁸
- HP Driver Packs (download)
- HP Cloud Recovery⁹
- HP Client Catalog (download)

Security Management

- HP Wolf Security for Business¹⁰ includes:
 - HP Sure Click¹¹
 - HP Sure Sense 2¹²
 - HP Sure Run¹³
 - HP Sure Recover¹⁴
 - HP Sure Start¹⁵
 - HP Tamper Lock¹⁶
 - HP Sure Admin¹⁷

BIOS

- HP BIOSphere Gen6¹⁸
- HP Secure Erase¹⁹
- HP DriveLock & Automatic DriveLock
- BIOS Update via Network
- Absolute Persistence Module²⁰
- TPM 2.0 Embedded Security Chip (Common Criteria EAL4+ Certified) (FIPS 140-2 Level 2 Certified)

1. HP Easy Clean requires Windows 10 RS3 and will disable the keyboard, touchscreen, and clickpad only. Ports are not disabled. See user guide for cleaning instructions.

2. HP Quick Drop requires Internet access and Windows 10 or higher PC preinstalled with HP QuickDrop app and either an Android device (phone or tablet) running Android 7 or higher with the Android HP QuickDrop app, and /or an iOS device (phone or tablet) running iOS 12 or higher with the iOS HP QuickDrop app.

3. HP Support Assistant requires Windows and Internet Access

4. HP Smart Support requires HP TechPulse to be installed. For more information about how to enable or to download HP Smart Support please visit <http://www.hp.com/smart-support>.

5. HP Services Scan is provided with Windows Update on select products and will check entitlement on each hardware device to determine if an HP TechPulse-enabled service has been purchased, and will download applicable software automatically. HP TechPulse is a telemetry and analytics platform that provides critical data around devices and applications and is not sold as a standalone service. HP TechPulse follows stringent GDPR privacy regulations and is ISO27001, ISO27701, ISO27017 and SOC2 Type2 certified for Information Security. Internet access with connection to

Features

TechPulse portal is required. For full system requirements or to disable this feature, please visit <http://www.hpdaas.com/requirements>. Not applicable in China.

6. HP Connect for Microsoft Endpoint Manager is available from the Azure Market Place for HP Pro, Elite, Z and Point-of-Sale PCs managed with Microsoft Endpoint Manager. Subscription to Microsoft Endpoint Manager required and sold separately. Network connection required.
7. HP Manageability Integration Kit can be downloaded from <http://www.hp.com/go/clientmanagement>.
8. HP Patch Assistant available on select HP PCs with the HP Manageability Kit that are managed through Microsoft System Center Configuration Manager. HP Manageability Integration Kit can be downloaded from <http://www8.hp.com/us/en/ads/clientmanagement/overview.html>.
9. HP Cloud Recovery is available for Z by HP, HP Elite and Pro desktops and laptops PCs with Intel® or AMD processors and requires an open, wired network connection. Note: You must back up important files, data, photos, videos, etc. before use to avoid loss of data. Detail, please refer to: <https://support.hp.com/us-en/document/c05115630>.
10. HP Wolf Security for Business requires Windows 10 or higher, includes various HP security features and is available on HP Pro, Elite, RPOS and Workstation products. See product details for included security features and OS requirement.
11. HP Sure Click requires Windows 10 Pro or higher or Enterprise. See https://bit.ly/2PrLT6A_SureClick for complete details.
12. HP Sure Sense 2 is available on select HP PCs with Windows 10 Pro, Windows 10 Enterprise, Windows 11 Pro, or Windows 11 Enterprise OS.
13. HP Sure Run Gen5 is available on select HP PCs and requires Windows 10 and higher.
14. HP Sure Recover Gen5 with Embedded Reimaging is an optional feature which requires Windows 10 and higher must be configured at purchase. You must back up important files, data, photos, videos, etc. before use to avoid loss of data. Network based recovery using Wi-Fi is only available on PCs with Intel Wi-Fi Module
15. HP Sure Start Gen7 is available on select HP PCs and requires Windows 10 and higher
16. Enable/disable by customers or IT administrator with administrator authority.
17. HP Sure Admin requires Windows 10 or higher, HP BIOS, HP Manageability Integration Kit from <http://www.hp.com/go/clientmanagement> and HP Sure Admin Local Access Authenticator smartphone app from the Android or Apple store
18. HP BIOSphere Gen6 features may vary depending on the platform and configuration.
19. HP Secure Erase for the methods outlined in the National Institute of Standards and Technology Special Publication 800-88 "Clear" sanitation method. HP Secure Erase does not support platforms with Intel® Optane™.
20. Absolute firmware module is shipped turned off and can only be activated with the purchase a license subscription and full activation of the software agent. License subscriptions can be purchased for terms ranging multiple years. Service is limited, check with Absolute for availability outside the U.S. Certain conditions apply. For full details visit: <https://www.absolute.com/about/legal/agreements/absolute/>.

Features

UNIT ENVIRONMENT AND OPERATING CONDITIONS

ENERGY STAR® certified models available

ENERGY STAR® certified. EPEAT® registered where applicable. Based on US EPEAT® registration according to IEEE 1680.1-2018 EPEAT®. EPEAT® status varies by country. Visit <http://www.epeat.net> for more information.

Low halogen (chassis, all internal components and modules)¹

TAA compliant models available

1. External power supplies, power cords, cables and peripherals are not Low Halogen. Service parts obtained after purchase may not be Low Halogen.

UNIT ENVIRONMENT AND OPERATING CONDITIONS

General Unit Operating Guidelines

- Keep the computer away from excessive moisture, direct moisture and the extremes of heat and cold, to ensure that unit is operated within the specified operating range.
- Leave a 10.2 cm (4 in) clearance on all vented sides of the computer to permit the required airflow.
- Never restrict airflow into the computer by blocking any vents or air intakes.
- Do not stack computers on top of each other or place computers so near each other that they are subject to each other's re-circulated or preheated air.
- Occasionally clean the air vents on the front, back, and any other vented side of the computer. Lint, dust and other foreign matter can block the vents and limit the airflow.
- If the computer is to be operated within a separate enclosure, intake and exhaust ventilation must be provided on the enclosure, and the same operating guidelines listed above will still apply.

Temperature Range	Operating: 50° to 95° F (10° to 35° C) ² Non-operating: -22° to 149° F (-30° to 65° C)
Relative Humidity	Operating: 10% to 90% (non-condensing at ambient) Non-operating: 5% to 95% (non-condensing at ambient)
Maximum Altitude (unpressurized)	Operating: 5000m Non-operating: 50000ft (15240 m)

2. Operating temperature is de-rated 1.0 deg C per 300 m (1000 ft) to 3000 m (10,000 ft) above sea level, no direct sustained sunlight. Maximum rate of change is 10 deg C/Hr. The upper limit may be limited by the type and number of options installed.

Features

ENVIRONMENTAL & INDUSTRY

HP Elite Mini 800 G9 Desktop PC

Eco-Label Certifications & declarations	<p>This product has received or is in the process of being certified to the following approvals and may be labeled with one or more of these marks:</p> <ul style="list-style-type: none"> • IT ECO declaration • US ENERGY STAR® • US Federal Energy Management Program (FEMP) • EPEAT® Gold registered in the United States. See http://www.epeat.net for registration status in your country. • TCO Certified • China Energy Conservation Program (CECP) • China State Environmental Protection Administration (SEPA) • Taiwan Green Mark • Korea Eco-label • Japan PC Green label • Commission Regulation (EC) No 617/2013 (ErP Lot 3) 		
Sustainable Impact Specifications	<ul style="list-style-type: none"> • Ocean-bound plastic in Frame, Panel and Speaker¹ • 40% post-consumer recycled plastic² • Low halogen³ • Outside Box and corrugated cushions are 100% sustainably sourced and recyclable⁴ • Molded Paper Pulp Cushion inside box is 100% sustainably sourced and recyclable⁵ • Bulk packaging available⁶ 		
System Configuration	<p>The configuration used for the Energy Consumption and Declared Noise Emissions data for the Desktop model is based on a “Typically Configured Desktop.”</p>		
Energy Consumption (in accordance with US ENERGY STAR® test method)	115VAC, 60Hz	230VAC, 50Hz	100VAC, 50Hz
Normal (Short idle)	7.38 W	7.49 W	7.18 W
Normal Operation (Long idle)	2.34 W	2.42 W	2.18 W
Sleep	2.26 W	2.34 W	2.1 W
Off	0.63 W	0.71 W	0.47 W
	<p>NOTE: Energy efficiency data listed is for an ENERGY STAR® certified product if offered within the model family. HP computers marked with the ENERGY STAR® Logo are compliant with the applicable U.S. Environmental Protection Agency (EPA) ENERGY STAR® specifications for computers. If a model family does not offer ENERGY STAR® certified configurations, then energy efficiency data listed is for a typically configured PC featuring a hard disk drive, a high efficiency power supply, and a Microsoft Windows® operating system.</p>		
Heat Dissipation*	115VAC, 60Hz	230VAC, 50Hz	100VAC, 50Hz
Normal Operation (Short idle)	25.2 BTU/hr	25.6 BTU/hr	24.6 BTU/hr
Normal Operation (Long idle)	8 BTU/hr	8.3 BTU/hr	7.5 BTU/hr
Sleep	7.7 BTU/hr	8 BTU/hr	7.2 BTU/hr
Off	2.2 BTU/hr	2.4 BTU/hr	1.6 BTU/hr
	<p>NOTE: Heat dissipation is calculated based on the measured watts, assuming the service level is attained for one hour.</p>		
Declared Noise Emissions (in accordance with ISO 7779 and ISO 9296)	Sound Power (L _{WAd} , bels)		Sound Pressure (L _{pAm} , decibels)
Typically Configured – Idle	2.7		17

Features

Fixed Disk – Random writes	2.7	17
Longevity and Upgrading	<p>This product can be upgraded, possibly extending its useful life by several years. Upgradeable features and/or components contained in the product may include:</p> <p>Spare parts are available throughout the warranty period and or for up to “5” years after the end of production.</p>	
Additional Information	<ul style="list-style-type: none"> • This product is in compliance with the Restrictions of Hazardous Substances (RoHS) directive - 2011/65/EC. • This HP product is designed to comply with the Waste Electrical and Electronic Equipment (WEEE) Directive – 2002/96/EC. • This product is in compliance with California Proposition 65 (State of California; Safe Drinking Water and Toxic Enforcement Act of 1986). • This product is in compliance with the IEEE 1680 (EPEAT) standard at the Gold level, see http://www.epeat.net • Plastics parts weighing over 25 grams used in the product are marked per ISO11469 and ISO1043. • This product is 92.7% recycle-able when properly disposed of at end of life. 	
Packaging Materials	External:	<p>PAPER/Corrugated 405 g</p> <p>PAPER/Molded pulp 74 g</p> <p>Internal: PLASTIC/Polyethylene low density - LDPE 5 g</p> <p>The plastic packaging material contains at least 80.0% recycled content.</p> <p>The corrugated paper packaging materials contains at least 80.0% recycled content.</p>
RoHS Compliance	<p>HP Inc. complies fully with materials regulations. We were among the first companies to extend the restrictions in the European Union (EU) Restriction of Hazardous Substances (RoHS) Directive to our products worldwide through the HP GSE. HP has contributed to the development of related legislation in Europe, as well as China, India, and Vietnam.</p> <p>We believe the RoHS directive and similar laws play an important role in promoting industry-wide elimination of substances of concern. We have supported the inclusion of additional substances—including PVC, BFRs, and certain phthalates—in future RoHS legislation that pertains to electrical and electronics products.</p> <p>We met our voluntary objective to achieve worldwide compliance with the new EU RoHS requirements for virtually all relevant products by July 2013, and we will continue to extend the scope of the commitment to include further restricted substances as regulations continue to evolve.</p> <p>To obtain a copy of the HP RoHS Compliance Statement, see: HP RoHS position statement.</p>	
Material Usage	<p>This product does not contain any of the following substances in excess of regulatory limits (refer to the HP General Specification for the Environment at http://www.hp.com/hpinfo/globalcitizenship/environment/pdf/gse.pdf):</p> <ul style="list-style-type: none"> • Asbestos • Certain Azo Colorants • Certain Brominated Flame Retardants – may not be used as flame retardants in plastics • Cadmium • Chlorinated Hydrocarbons • Chlorinated Paraffins • Formaldehyde • Halogenated Diphenyl Methanes • Lead carbonates and sulfates • Lead and Lead compounds • Mercuric Oxide Batteries • Nickel – finishes must not be used on the external surface designed to be frequently handled or carried by the user. • Ozone Depleting Substances 	

Features

	<ul style="list-style-type: none"> • Polybrominated Biphenyls (PBBs) • Polybrominated Biphenyl Ethers (PBBEs) • Polybrominated Biphenyl Oxides (PBBOs) • Polychlorinated Biphenyl (PCB) • Polychlorinated Terphenyls (PCT) • Polyvinyl Chloride (PVC) – except for wires and cables, and certain retail packaging has been voluntarily removed from most applications. • Radioactive Substances • Tributyl Tin (TBT), Triphenyl Tin (TPT), Tributyl Tin Oxide (TBTO)
Packaging Usage	<p>HP follows these guidelines to decrease the environmental impact of product packaging:</p> <ul style="list-style-type: none"> • Eliminate the use of heavy metals such as lead, chromium, mercury and cadmium in packaging materials. • Eliminate the use of ozone-depleting substances (ODS) in packaging materials. • Design packaging materials for ease of disassembly. • Maximize the use of post-consumer recycled content materials in packaging materials. • Use readily recyclable packaging materials such as paper and corrugated materials. • Reduce size and weight of packages to improve transportation fuel efficiency. • Plastic packaging materials are marked according to ISO 11469 and DIN 6120 standards.
End-of-life Management and Recycling	<p>HP Inc. offers end-of-life HP product return and recycling programs in many geographic areas. To recycle your product, please go to: http://www.hp.com/go/reuse-recycle or contact your nearest HP sales office. Products returned to HP will be recycled, recovered or disposed of in a responsible manner.</p> <p>The EU WEEE directive (2002/95/EC) requires manufacturers to provide treatment information for each product type for use by treatment facilities. This information (product disassembly instructions) is posted on the Hewlett Packard web site at: http://www.hp.com/go/recyclers. These instructions may be used by recyclers and other WEEE treatment facilities as well as HP OEM customers who integrate and re-sell HP equipment.</p> <p>Global Citizenship Report http://www.hp.com/hpinfo/globalcitizenship/gcreport/index.html</p> <p>Eco-label certifications http://www8.hp.com/us/en/hp-information/environment/ecolabels.html</p> <p>ISO 14001 certificates: http://h20195.www2.hp.com/V2/GetDocument.aspx?docname=c04755842 and http://www.hp.com/hpinfo/globalcitizenship/environment/pdf/cert.pdf</p>
footnotes	<ol style="list-style-type: none"> 1. Percentage of ocean-bound plastic contained in each component varies by product. 2. Recycled plastic content percentage is based on the definition set in the IEEE 1680.1-2018 standard. 3. External power supplies, WWAN modules, power cords, cables and peripherals excluded. 100% outer box packaging and corrugated cushions made from sustainably sourced certified and recycled fibers. 4. 100% outer box packaging and corrugated cushions made from sustainably sourced certified and recycled fibers. 5. Fiber cushions made from 100% recycled wood fiber and organic materials. 6. Plastic cushions are made from from >90% recycled plastic.

Features

HP Elite SFF 800 G9 Desktop PC

Eco-Label Certifications & declarations	<p>This product has received or is in the process of being certified to the following approvals and may be labeled with one or more of these marks:</p> <ul style="list-style-type: none"> • IT ECO declaration • US ENERGY STAR® • US Federal Energy Management Program (FEMP) • EPEAT® Gold registered in the United States. See http://www.epeat.net for registration status in your country. • TCO Certified • China Energy Conservation Program (CECP) • China State Environmental Protection Administration (SEPA) • Taiwan Green Mark • Korea Eco-label • Japan PC Green label • Commission Regulation (EC) No 617/2013 (ErP Lot 3) 		
Sustainable Impact Specifications	<ul style="list-style-type: none"> • Ocean-bound plastic in CPU Fan, Speaker¹ • 58.6% post-consumer recycled plastic² • 9.9% recycled metal • Low halogen • Outside Box and corrugated cushions are 100% sustainably sourced and recyclable³ • Molded Paper Pulp Cushion inside box is 100% sustainably sourced and recyclable⁴ • Bulk packaging available⁵ 		
System Configuration	<p>The configuration used for the Energy Consumption and Declared Noise Emissions data for the Desktop model is based on a “Typically Configured Desktop.”</p>		
Energy Consumption (in accordance with US ENERGY STAR® test method)	115VAC, 60Hz	230VAC, 50Hz	100VAC, 50Hz
Normal Operation (Short idle)	11.6 W	11.9 W	11.6 W
Normal Operation (Long idle)	10.4 W	11 W	11 W
Sleep	0.9 W	0.9 W	0.9 W
Off	0.7 W	0.7 W	0.6 W
	<p>NOTE: Energy efficiency data listed is for an ENERGY STAR® compliant product if offered within the model family. HP computers marked with the ENERGY STAR® Logo are compliant with the applicable U.S. Environmental Protection Agency (EPA) ENERGY STAR® specifications for computers. If a model family does not offer ENERGY STAR® compliant configurations, then energy efficiency data listed is for a typically configured PC featuring a hard disk drive, a high efficiency power supply, and a Microsoft Windows® operating system.</p>		
Heat Dissipation*	115VAC, 60Hz	230VAC, 50Hz	100VAC, 50Hz
Normal Operation (Short idle)	39.672 BTU/hr	40.698 BTU/hr	39.672 BTU/hr
Normal Operation (Long idle)	35.568 BTU/hr	37.62 BTU/hr	37.62 BTU/hr
Sleep	3.078 BTU/hr	3.078 BTU/hr	3.078 BTU/hr
Off	2.394 BTU/hr	2.394 BTU/hr	2.052 BTU/hr
	<p>NOTE: Heat dissipation is calculated based on the measured watts, assuming the service level is attained for one hour.</p>		
Declared Noise Emissions (in accordance with ISO 7779 and ISO 9296)	Sound Power (L _{WAd} , bels)		Sound Pressure (L _{pAm} , decibels)

Features

Typically Configured – Idle	3.0	20.8
Fixed Disk–Random writes	3.3	21.2
Optical Drive – Sequential reads	4.5	29
Longevity and Upgrading	<p>This product can be upgraded, possibly extending its useful life by several years. Upgradeable features and/or components contained in the product may include:</p> <p>Spare parts are available throughout the warranty period and or for up to “5” years after the end of production.</p>	
Additional Information	<ul style="list-style-type: none"> • This product is in compliance with the Restrictions of Hazardous Substances (RoHS) directive - 2011/65/EC. • This HP product is designed to comply with the Waste Electrical and Electronic Equipment (WEEE) Directive – 2002/96/EC. • This product is in compliance with California Proposition 65 (State of California; Safe Drinking Water and Toxic Enforcement Act of 1986). • This product is in compliance with the IEEE 1680 (EPEAT) standard at the Gold level, see http://www.epeat.net • Plastics parts weighing over 25 grams used in the product are marked per ISO11469 and ISO1043. • This product is 92.9% recycle-able when properly disposed of at end of life. 	
Packaging Materials	External:	<p>PAPER/Corrugated 1158 g</p> <p>PAPER/Molded Pulp 590 g</p> <p>Internal: PLASTIC/Polyethylene low density - LDPE 26 g</p>
		The plastic packaging material contains at least 0.0% recycled content.
		The corrugated paper packaging materials contains at least 35.0% recycled content.
RoHS Compliance	<p>HP Inc. complies fully with materials regulations. We were among the first companies to extend the restrictions in the European Union (EU) Restriction of Hazardous Substances (RoHS) Directive to our products worldwide through the HP GSE. HP has contributed to the development of related legislation in Europe, as well as China, India, and Vietnam.</p> <p>We believe the RoHS directive and similar laws play an important role in promoting industry-wide elimination of substances of concern. We have supported the inclusion of additional substances—including PVC, BFRs, and certain phthalates—in future RoHS legislation that pertains to electrical and electronics products.</p> <p>We met our voluntary objective to achieve worldwide compliance with the new EU RoHS requirements for virtually all relevant products by July 2013, and we will continue to extend the scope of the commitment to include further restricted substances as regulations continue to evolve.</p> <p>To obtain a copy of the HP RoHS Compliance Statement, see: HP RoHS position statement.</p>	
Material Usage	<ul style="list-style-type: none"> • This product does not contain any of the following substances in excess of regulatory limits (refer to the HP General Specification for the Environment at http://www.hp.com/hpinfo/globalcitizenship/environment/supplychain/gen_specifications.html): • Asbestos • Certain Azo Colorants • Certain Brominated Flame Retardants – may not be used as flame retardants in plastics • Cadmium • Chlorinated Hydrocarbons • Chlorinated Paraffins • Bis(2-Ethylhexyl) phthalate (DEHP) • Benzyl butyl phthalate (BBP) 	

Features

	<ul style="list-style-type: none"> • Dibutyl phthalate (DBP) • Diisobutyl phthalate (DIBP) • Formaldehyde • Halogenated Diphenyl Methanes • Lead carbonates and sulfates • Lead and Lead compounds • Mercuric Oxide Batteries • Nickel – finishes must not be used on the external surface designed to be frequently handled or carried by the user. • Ozone Depleting Substances • Polybrominated Biphenyls (PBBs) • Polybrominated Biphenyl Ethers (PBBEs) • Polybrominated Biphenyl Oxides (PBBOs) • Polychlorinated Biphenyl (PCB) • Polychlorinated Terphenyls (PCT) • Polyvinyl Chloride (PVC) – except for wires and cables, and certain retail packaging has been voluntarily removed from most applications. • Radioactive Substances • Tributyl Tin (TBT), Triphenyl Tin (TPT), Tributyl Tin Oxide (TBTO)
Packaging Usage	<p>HP follows these guidelines to decrease the environmental impact of product packaging:</p> <ul style="list-style-type: none"> • Eliminate the use of heavy metals such as lead, chromium, mercury and cadmium in packaging materials. • Eliminate the use of ozone-depleting substances (ODS) in packaging materials. • Design packaging materials for ease of disassembly. • Maximize the use of post-consumer recycled content materials in packaging materials. • Use readily recyclable packaging materials such as paper and corrugated materials. • Reduce size and weight of packages to improve transportation fuel efficiency. • Plastic packaging materials are marked according to ISO 11469 and DIN 6120 standards.
End-of-life Management and Recycling	<p>HP Inc. offers end-of-life HP product return and recycling programs in many geographic areas. To recycle your product, please go to: http://www.hp.com/go/reuse-recycle or contact your nearest HP sales office. Products returned to HP will be recycled, recovered or disposed of in a responsible manner.</p> <p>The EU WEEE directive (2002/95/EC) requires manufacturers to provide treatment information for each product type for use by treatment facilities. This information (product disassembly instructions) is posted on the Hewlett Packard web site at: http://www.hp.com/go/recyclers. These instructions may be used by recyclers and other WEEE treatment facilities as well as HP OEM customers who integrate and re-sell HP equipment.</p> <p>Global Citizenship Report http://www.hp.com/hpinfo/globalcitizenship/gcreport/index.html Eco-label certifications http://www8.hp.com/us/en/hp-information/environment/ecolabels.html ISO 14001 certificates: http://h20195.www2.hp.com/V2/GetDocument.aspx?docname=c04755842 and http://www.hp.com/hpinfo/globalcitizenship/environment/pdf/cert.pdf</p>
footnotes	<ol style="list-style-type: none"> 1. Percentage of ocean-bound plastic contained in each component varies by product. 2. Recycled plastic content percentage is based on the definition set in the IEEE 1680.1-2018 standard. 3. 100% outer box packaging and corrugated cushions made from sustainably sourced certified and recycled fibers. 4. Fiber cushions made from 100% recycled wood fiber and organic materials. 5. Plastic cushions are made from >90% recycled plastic.

Features

HP Elite Tower 800 G9 Desktop PC

Eco-Label Certifications & declarations	<p>This product has received or is in the process of being certified to the following approvals and may be labeled with one or more of these marks:</p> <ul style="list-style-type: none"> • IT ECO declaration • US ENERGY STAR® • US Federal Energy Management Program (FEMP) • EPEAT® Gold registered in the United States. See http://www.epeat.net for registration status in your country. • TCO Certified • China Energy Conservation Program (CECP) • China State Environmental Protection Administration (SEPA) • Taiwan Green Mark • Korea Eco-label • Japan PC Green label • Commission Regulation (EC) No 617/2013 (ErP Lot 3) 		
Sustainable Impact Specifications	<ul style="list-style-type: none"> • Ocean-bound plastic in System and CPU Fan, Speaker¹ • 60% post-consumer recycled plastic² • Outside Box and corrugated cushions are 100% sustainably sourced and recyclable³ • Molded Paper Pulp Cushion inside box is 100% sustainably sourced and recyclable⁴ • Bulk packaging available⁵ 		
System Configuration	<p>The configuration used for the Energy Consumption and Declared Noise Emissions data for the Desktop model is based on a Typically Configured Desktop.</p>		
Energy Consumption (in accordance with US ENERGY STAR® test method)	115VAC, 60Hz	230VAC, 50Hz	100VAC, 60Hz
Normal Operation (Short idle)	12.3 W	12.6 W	12.5 W
Normal Operation (Long idle)	11.4 W	11.1 W	11.4 W
Sleep	1 W	1 W	0.9 W
Off	0.6 W	0.7 W	0.6 W
	<p>NOTE: Energy efficiency data listed is for an ENERGY STAR® compliant product if offered within the model family. HP computers marked with the ENERGY STAR® Logo are compliant with the applicable U.S. Environmental Protection Agency (EPA) ENERGY STAR® specifications for computers. If a model family does not offer ENERGY STAR® compliant configurations, then energy efficiency data listed is for a typically configured PC featuring a hard disk drive, a high efficiency power supply, and a Microsoft Windows® operating system.</p>		
Heat Dissipation*	115VAC, 60Hz	230VAC, 50Hz	100VAC, 60Hz
Normal Operation (Short idle)	42.1 BTU/hr	43.1 BTU/hr	42.8 BTU/hr
Normal Operation (Long idle)	39 BTU/hr	38 BTU/hr	39 BTU/hr
Sleep	3.4 BTU/hr	11.6 BTU/hr	3.1 BTU/hr
Off	2.1 BTU/hr	2.4 BTU/hr	2.1 BTU/hr
	<p>NOTE: Heat dissipation is calculated based on the measured watts, assuming the service level is attained for one hour.</p>		
Declared Noise Emissions (in accordance with ISO 7779 and ISO 9296)	Sound Power (L _{WAd} , bels)		Sound Pressure (L _{pAm} , decibels)
Typically Configured – Idle	3.1		19
Fixed Disk–Random writes	3.3		21

Features

<p>Longevity and Upgrading</p>	<p>This product can be upgraded, possibly extending its useful life by several years. Upgradeable features and/or components contained in the product may include:</p> <p>Spare parts are available throughout the warranty period and or for up to “5” years after the end of production.</p>		
<p>Additional Information</p>	<ul style="list-style-type: none"> • This product is in compliance with the Restrictions of Hazardous Substances (RoHS) directive - 2011/65/EC. • This HP product is designed to comply with the Waste Electrical and Electronic Equipment (WEEE) Directive – 2002/96/EC. • This product is in compliance with California Proposition 65 (State of California; Safe Drinking Water and Toxic Enforcement Act of 1986). • This product is in compliance with the IEEE 1680 (EPEAT) standard at the Gold level, see http://www.epeat.net • Plastics parts weighing over 25 grams used in the product are marked per ISO11469 and ISO1043. • This product is 93.4% recycle-able when properly disposed of at end of life 		
<p>Packaging Materials</p>	<p>External:</p>	<p>PAPER/Corrugated</p>	<p>1106 g</p>
		<p>PAPER/Molded Pulp</p>	<p>666 g</p>
	<p>Internal:</p>	<p>PLASTIC/Polyethylene low density - LDPE</p>	<p>40 g</p>
	<p>The plastic packaging material contains at least 0.0% recycled content.</p>		
	<p>The corrugated paper packaging materials contains at least 35.0% recycled content.</p>		
<p>RoHS Compliance</p>	<p>HP Inc. complies fully with materials regulations. We were among the first companies to extend the restrictions in the European Union (EU) Restriction of Hazardous Substances (RoHS) Directive to our products worldwide through the HP GSE. HP has contributed to the development of related legislation in Europe, as well as China, India, and Vietnam.</p> <p>We believe the RoHS directive and similar laws play an important role in promoting industry-wide elimination of substances of concern. We have supported the inclusion of additional substances—including PVC, BFRs, and certain phthalates—in future RoHS legislation that pertains to electrical and electronics products.</p> <p>We met our voluntary objective to achieve worldwide compliance with the new EU RoHS requirements for virtually all relevant products by July 2013, and we will continue to extend the scope of the commitment to include further restricted substances as regulations continue to evolve.</p> <p>To obtain a copy of the HP RoHS Compliance Statement, see: HP RoHS position statement.</p>		
<p>Material Usage</p>	<p>This product does not contain any of the following substances in excess of regulatory limits (refer to the HP General Specification for the Environment at http://www.hp.com/hpinfo/globalcitizenship/environment/supplychain/gen_specifications.html):</p> <ul style="list-style-type: none"> • Asbestos • Certain Azo Colorants • Certain Brominated Flame Retardants – may not be used as flame retardants in plastics • Cadmium • Chlorinated Hydrocarbons • Chlorinated Paraffins • Bis(2-Ethylhexyl) phthalate (DEHP) • Benzyl butyl phthalate (BBP) • Dibutyl phthalate (DBP) • Diisobutyl phthalate (DIBP) • Formaldehyde • Halogenated Diphenyl Methanes • Lead carbonates and sulfates • Lead and Lead compounds 		

Features

	<ul style="list-style-type: none"> • Mercuric Oxide Batteries • Nickel – finishes must not be used on the external surface designed to be frequently handled or carried by the user. • Ozone Depleting Substances • Polybrominated Biphenyls (PBBs) • Polybrominated Biphenyl Ethers (PBBEs) • Polybrominated Biphenyl Oxides (PBBOs) • Polychlorinated Biphenyl (PCB) • Polychlorinated Terphenyls (PCT) • Polyvinyl Chloride (PVC) – except for wires and cables, and certain retail packaging has been voluntarily removed from most applications. • Radioactive Substances • Tributyl Tin (TBT), Triphenyl Tin (TPT), Tributyl Tin Oxide (TBTO)
Packaging Usage	<p>HP follows these guidelines to decrease the environmental impact of product packaging:</p> <ul style="list-style-type: none"> • Eliminate the use of heavy metals such as lead, chromium, mercury and cadmium in packaging materials. • Eliminate the use of ozone-depleting substances (ODS) in packaging materials. • Design packaging materials for ease of disassembly. • Maximize the use of post-consumer recycled content materials in packaging materials. • Use readily recyclable packaging materials such as paper and corrugated materials. • Reduce size and weight of packages to improve transportation fuel efficiency. • Plastic packaging materials are marked according to ISO 11469 and DIN 6120 standards.
End-of-life Management and Recycling	<p>HP Inc. offers end-of-life HP product return and recycling programs in many geographic areas. To recycle your product, please go to: http://www.hp.com/go/reuse-recycle or contact your nearest HP sales office. Products returned to HP will be recycled, recovered or disposed of in a responsible manner.</p> <p>The EU WEEE directive (2002/95/EC) requires manufacturers to provide treatment information for each product type for use by treatment facilities. This information (product disassembly instructions) is posted on the Hewlett Packard web site at: http://www.hp.com/go/recyclers. These instructions may be used by recyclers and other WEEE treatment facilities as well as HP OEM customers who integrate and re-sell HP equipment.</p> <p>Global Citizenship Report http://www.hp.com/hpinfo/globalcitizenship/gcreport/index.html Eco-label certifications http://www8.hp.com/us/en/hp-information/environment/ecolabels.html ISO 14001 certificates: http://h20195.www2.hp.com/V2/GetDocument.aspx?docname=c04755842 and http://www.hp.com/hpinfo/globalcitizenship/environment/pdf/cert.pdf</p>
footnotes	<ol style="list-style-type: none"> 1. Percentage of ocean-bound plastic contained in each component varies by product. 2. Recycled plastic content percentage is based on the definition set in the IEEE 1680.1-2018 standard. 3. 100% outer box packaging and corrugated cushions made from sustainably sourced certified and recycled fibers. 4. Fiber cushions made from 100% recycled wood fiber and organic materials. 5. Plastic cushions are made from >90% recycled plastic.

Features

HP Elite Tower 880 G9 Desktop PC

Eco-Label Certifications & declarations	<p>This product has received or is in the process of being certified to the following approvals and may be labeled with one or more of these marks:</p> <ul style="list-style-type: none"> • IT ECO declaration • US ENERGY STAR® • US Federal Energy Management Program (FEMP) • EPEAT¹ Gold registered in the United States. See http://www.epeat.net for registration status in your country. • TCO Certified • China Energy Conservation Program (CECP) • China State Environmental Protection Administration (SEPA) • Taiwan Green Mark • Korea Eco-label • Japan PC Green label • Commission Regulation (EC) No 617/2013 (ErP Lot 3) 		
Sustainable Impact Specifications	<ul style="list-style-type: none"> • Ocean-bound plastic in System and CPU Fan, Speaker¹ • 60% post-consumer recycled plastic² • Outside Box and corrugated cushions are 100% sustainably sourced and recyclable³ • Molded Paper Pulp Cushion inside box is 100% sustainably sourced and recyclable⁴ • Bulk packaging available⁵ 		
System Configuration	<p>The configuration used for the Energy Consumption and Declared Noise Emissions data for the Desktop model is based on a Typically Configured Desktop.</p>		
Energy Consumption (in accordance with US ENERGY STAR® test method)	115VAC, 60Hz	230VAC, 50Hz	100VAC, 60Hz
Normal Operation (Short idle)	12.3 W	12.6 W	12.5 W
Normal Operation (Long idle)	11.4 W	11.1 W	11.4 W
Sleep	1 W	1 W	0.9 W
Off	0.6 W	0.7 W	0.6 W
	<p>NOTE: Energy efficiency data listed is for an ENERGY STAR® compliant product if offered within the model family. HP computers marked with the ENERGY STAR® Logo are compliant with the applicable U.S. Environmental Protection Agency (EPA) ENERGY STAR® specifications for computers. If a model family does not offer ENERGY STAR® compliant configurations, then energy efficiency data listed is for a typically configured PC featuring a hard disk drive, a high efficiency power supply, and a Microsoft Windows® operating system.</p>		
Heat Dissipation*	115VAC, 60Hz	230VAC, 50Hz	100VAC, 60Hz
Normal Operation (Short idle)	42.1 BTU/hr	43.1 BTU/hr	42.8 BTU/hr
Normal Operation (Long idle)	39 BTU/hr	38 BTU/hr	39 BTU/hr
Sleep	3.4 BTU/hr	11.6 BTU/hr	3.1 BTU/hr
Off	2.1 BTU/hr	2.4 BTU/hr	2.1 BTU/hr
	<p>NOTE: Heat dissipation is calculated based on the measured watts, assuming the service level is attained for one hour.</p>		
Declared Noise Emissions (in accordance with ISO 7779 and ISO 9296)	Sound Power (L _{WAd} , bels)		Sound Pressure (L _{pAm} , decibels)
Typically Configured – Idle	3.1		19
Fixed Disk–Random writes	3.3		21

Features

<p>Longevity and Upgrading</p>	<p>This product can be upgraded, possibly extending its useful life by several years. Upgradeable features and/or components contained in the product may include:</p> <p>Spare parts are available throughout the warranty period and or for up to “5” years after the end of production.</p>		
<p>Additional Information</p>	<ul style="list-style-type: none"> • This product is in compliance with the Restrictions of Hazardous Substances (RoHS) directive - 2011/65/EC. • This HP product is designed to comply with the Waste Electrical and Electronic Equipment (WEEE) Directive – 2002/96/EC. • This product is in compliance with California Proposition 65 (State of California; Safe Drinking Water and Toxic Enforcement Act of 1986). • This product is in compliance with the IEEE 1680 (EPEAT) standard at the Gold level, see http://www.epeat.net • Plastics parts weighing over 25 grams used in the product are marked per ISO11469 and ISO1043. • This product is 93.4% recycle-able when properly disposed of at end of life 		
<p>Packaging Materials</p>	<p>External:</p>	<p>PAPER/Corrugated</p>	<p>1106 g</p>
		<p>PAPER/Molded Pulp</p>	<p>666 g</p>
	<p>Internal:</p>	<p>PLASTIC/Polyethylene low density - LDPE</p>	<p>40 g</p>
	<p>The plastic packaging material contains at least 0.0% recycled content.</p>		
	<p>The corrugated paper packaging materials contains at least 35.0% recycled content.</p>		
<p>RoHS Compliance</p>	<p>HP Inc. complies fully with materials regulations. We were among the first companies to extend the restrictions in the European Union (EU) Restriction of Hazardous Substances (RoHS) Directive to our products worldwide through the HP GSE. HP has contributed to the development of related legislation in Europe, as well as China, India, and Vietnam.</p> <p>We believe the RoHS directive and similar laws play an important role in promoting industry-wide elimination of substances of concern. We have supported the inclusion of additional substances—including PVC, BFRs, and certain phthalates—in future RoHS legislation that pertains to electrical and electronics products.</p> <p>We met our voluntary objective to achieve worldwide compliance with the new EU RoHS requirements for virtually all relevant products by July 2013, and we will continue to extend the scope of the commitment to include further restricted substances as regulations continue to evolve.</p> <p>To obtain a copy of the HP RoHS Compliance Statement, see: HP RoHS position statement.</p>		
<p>Material Usage</p>	<p>This product does not contain any of the following substances in excess of regulatory limits (refer to the HP General Specification for the Environment at http://www.hp.com/hpinfo/globalcitizenship/environment/supplychain/gen_specifications.html):</p> <ul style="list-style-type: none"> • Asbestos • Certain Azo Colorants • Certain Brominated Flame Retardants – may not be used as flame retardants in plastics • Cadmium • Chlorinated Hydrocarbons • Chlorinated Paraffins • Bis(2-Ethylhexyl) phthalate (DEHP) • Benzyl butyl phthalate (BBP) • Dibutyl phthalate (DBP) • Diisobutyl phthalate (DIBP) • Formaldehyde • Halogenated Diphenyl Methanes • Lead carbonates and sulfates • Lead and Lead compounds 		

Features

	<ul style="list-style-type: none"> • Mercuric Oxide Batteries • Nickel – finishes must not be used on the external surface designed to be frequently handled or carried by the user. • Ozone Depleting Substances • Polybrominated Biphenyls (PBBs) • Polybrominated Biphenyl Ethers (PBBEs) • Polybrominated Biphenyl Oxides (PBBOs) • Polychlorinated Biphenyl (PCB) • Polychlorinated Terphenyls (PCT) • Polyvinyl Chloride (PVC) – except for wires and cables, and certain retail packaging has been voluntarily removed from most applications. • Radioactive Substances • Tributyl Tin (TBT), Triphenyl Tin (TPT), Tributyl Tin Oxide (TBTO)
Packaging Usage	<p>HP follows these guidelines to decrease the environmental impact of product packaging:</p> <ul style="list-style-type: none"> • Eliminate the use of heavy metals such as lead, chromium, mercury and cadmium in packaging materials. • Eliminate the use of ozone-depleting substances (ODS) in packaging materials. • Design packaging materials for ease of disassembly. • Maximize the use of post-consumer recycled content materials in packaging materials. • Use readily recyclable packaging materials such as paper and corrugated materials. • Reduce size and weight of packages to improve transportation fuel efficiency. • Plastic packaging materials are marked according to ISO 11469 and DIN 6120 standards.
End-of-life Management and Recycling	<p>HP Inc. offers end-of-life HP product return and recycling programs in many geographic areas. To recycle your product, please go to: http://www.hp.com/go/reuse-recycle or contact your nearest HP sales office. Products returned to HP will be recycled, recovered or disposed of in a responsible manner.</p> <p>The EU WEEE directive (2002/95/EC) requires manufacturers to provide treatment information for each product type for use by treatment facilities. This information (product disassembly instructions) is posted on the Hewlett Packard web site at: http://www.hp.com/go/recyclers. These instructions may be used by recyclers and other WEEE treatment facilities as well as HP OEM customers who integrate and re-sell HP equipment.</p> <p>Global Citizenship Report http://www.hp.com/hpinfo/globalcitizenship/gcreport/index.html Eco-label certifications http://www8.hp.com/us/en/hp-information/environment/ecolabels.html ISO 14001 certificates: http://h20195.www2.hp.com/V2/GetDocument.aspx?docname=c04755842 and http://www.hp.com/hpinfo/globalcitizenship/environment/pdf/cert.pdf</p>
footnotes	<ol style="list-style-type: none"> 1. Percentage of ocean-bound plastic contained in each component varies by product. 2. Recycled plastic content percentage is based on the definition set in the IEEE 1680.1-2018 standard. 3. 100% outer box packaging and corrugated cushions made from sustainably sourced certified and recycled fibers. 4. Fiber cushions made from 100% recycled wood fiber and organic materials. 5. Plastic cushions are made from >90% recycled plastic.

Features

HP EliteOne 840 23.8-inch G9 All-in-One Desktop PC

Eco-Label Certifications & declarations	<p>This product has received or is in the process of being certified to the following approvals and may be labeled with one or more of these marks:</p> <ul style="list-style-type: none"> • IT ECO declaration • US ENERGY STAR® • US Federal Energy Management Program (FEMP) • EPEAT[®] Gold registered in the United States. See http://www.epeat.net for registration status in your country. • TCO Certified • China Energy Conservation Program (CECP) • China State Environmental Protection Administration (SEPA) • Taiwan Green Mark • Korea Eco-label • Japan PC Green label • Commission Regulation (EC) No 617/2013 (ErP Lot 3) 		
Sustainable Impact Specifications	<ul style="list-style-type: none"> • Ocean-bound plastic in Rear cover, Speaker Box¹ • 65% post-consumer recycled plastic² • Outside Box and corrugated cushions are 100% sustainably sourced and recyclable³ • Molded Paper Pulp Cushion inside box is 100% sustainably sourced and recyclable⁴ • Bulk packaging available⁵ 		
System Configuration	<p>The configuration used for the Energy Consumption and Declared Noise Emissions data for the All-in-One PC model is based on a typically configured PC featuring a hard disk drive, a high efficiency power supply, and a Microsoft Windows® operating system.</p>		
Energy Consumption (in accordance with US ENERGY STAR® test method)	115VAC, 60Hz	230VAC, 50Hz	100VAC, 50Hz
Normal Operation (Short idle)	19.88 W	19.96 W	19.69 W
Normal Operation (Long idle)	2.94 W	3.02 W	2.78 W
Sleep	2.93 W	3.01 W	2.77 W
Off	0.81 W	0.82 W	0.79 W
	<p>NOTE: Energy efficiency data listed is for an ENERGY STAR® compliant product if offered within the model family. HP computers marked with the ENERGY STAR® Logo are compliant with the applicable U.S. Environmental Protection Agency (EPA) ENERGY STAR® specifications for computers. If a model family does not offer ENERGY STAR® compliant configurations, then energy efficiency data listed is for a typically configured PC featuring a hard disk drive, a high efficiency power supply, and a Microsoft Windows® operating system.</p>		
Heat Dissipation*	115VAC, 60Hz	230VAC, 50Hz	100VAC, 50Hz
Normal Operation (Short idle)	68 BTU/hr	68.3 BTU/hr	67.3 BTU/hr
Normal Operation (Long idle)	10.1 BTU/hr	10.3 BTU/hr	9.5 BTU/hr
Sleep	10 BTU/hr	10.3 BTU/hr	9.5 BTU/hr
Off	2.8 BTU/hr	2.8 BTU/hr	2.7 BTU/hr
	<p>NOTE: Heat dissipation is calculated based on the measured watts, assuming the service level is attained for one hour.</p>		
Declared Noise Emissions (in accordance with ISO 7779 and ISO 9296)	Sound Power (L _{WAd} , bels)		Sound Pressure (L _{pAm} , decibels)
Typically Configured – Idle	2.6		15.4

Features

Fixed Disk – Random writes	2.6	15.4	
Longevity and Upgrading	<p>This product can be upgraded, possibly extending its useful life by several years. Upgradeable features and/or components contained in the product may include:</p> <ul style="list-style-type: none"> • 6 USB ports • 2 memory slots • 1 Mini PCIe half-length slot • 1 MXM 3.0 Type A - 35W slot • 1 mSATA slot • 1 2.5" internal bay supporting up to Two 2.5" hard drives (HDD/SSD/SED/SSHD) • 1 5.25" external supporting optical drive <p>Spare parts are available throughout the warranty period and or for up to “5” years after the end of production.</p>		
Additional Information	<ul style="list-style-type: none"> • This product is in compliance with the Restrictions of Hazardous Substances (RoHS) directive - 2011/65/EC. • This HP product is designed to comply with the Waste Electrical and Electronic Equipment (WEEE) Directive – 2002/96/EC. • This product is in compliance with California Proposition 65 (State of California; Safe Drinking Water and Toxic Enforcement Act of 1986). • This product is in compliance with the IEEE 1680 (EPEAT) standard at the Gold level, see http://www.epeat.net • Plastics parts weighing over 25 grams used in the product are marked per ISO11469 and ISO1043. • This product is 97.5% recycle-able when properly disposed of at end of life. 		
Packaging Materials	External:	PAPER/Paper	1240 g
		PAPER/Molded Pulp	1489 g
	Internal:	PLASTIC/Other	49 g
	The plastic packaging material contains at least xx% recycled content.		
The corrugated paper packaging materials contains at least xx% recycled content.			
RoHS Compliance	<p>HP Inc. complies fully with materials regulations. We were among the first companies to extend the restrictions in the European Union (EU) Restriction of Hazardous Substances (RoHS) Directive to our products worldwide through the HP GSE. HP has contributed to the development of related legislation in Europe, as well as China, India, and Vietnam.</p> <p>We believe the RoHS directive and similar laws play an important role in promoting industry-wide elimination of substances of concern. We have supported the inclusion of additional substances—including PVC, BFRs, and certain phthalates—in future RoHS legislation that pertains to electrical and electronics products.</p> <p>We met our voluntary objective to achieve worldwide compliance with the new EU RoHS requirements for virtually all relevant products by July 2013, and we will continue to extend the scope of the commitment to include further restricted substances as regulations continue to evolve.</p> <p>To obtain a copy of the HP RoHS Compliance Statement, see HP RoHS position statement.</p>		
Material Usage	<p>This product does not contain any of the following substances in excess of regulatory limits (refer to the HP General Specification for the Environment at http://www.hp.com/hpinfo/globalcitizenship/environment/supplychain/gen_specifications.html):</p> <ul style="list-style-type: none"> • Asbestos • Certain Azo Colorants • Certain Brominated Flame Retardants – may not be used as flame retardants in plastics • Cadmium • Chlorinated Hydrocarbons 		

Features

	<ul style="list-style-type: none"> • Chlorinated Paraffins • Bis(2-Ethylhexyl) phthalate (DEHP) • Benzyl butyl phthalate (BBP) • Dibutyl phthalate (DBP) • Diisobutyl phthalate (DIBP) • Formaldehyde • Halogenated Diphenyl Methanes • Lead carbonates and sulfates • Lead and Lead compounds • Mercuric Oxide Batteries • Nickel – finishes must not be used on the external surface designed to be frequently handled or carried by the user. • Ozone Depleting Substances • Polybrominated Biphenyls (PBBs) • Polybrominated Biphenyl Ethers (PBBEs) • Polybrominated Biphenyl Oxides (PBBOs) • Polychlorinated Biphenyl (PCB) • Polychlorinated Terphenyls (PCT) • Polyvinyl Chloride (PVC) – except for wires and cables, and certain retail packaging has been voluntarily removed from most applications. • Radioactive Substances • Tributyl Tin (TBT), Triphenyl Tin (TPT), Tributyl Tin Oxide (TBTO)
Packaging Usage	<p>HP follows these guidelines to decrease the environmental impact of product packaging:</p> <ul style="list-style-type: none"> • Eliminate the use of heavy metals such as lead, chromium, mercury and cadmium in packaging materials. • Eliminate the use of ozone-depleting substances (ODS) in packaging materials. • Design packaging materials for ease of disassembly. • Maximize the use of post-consumer recycled content materials in packaging materials. • Use readily recyclable packaging materials such as paper and corrugated materials. • Reduce size and weight of packages to improve transportation fuel efficiency. • Plastic packaging materials are marked according to ISO 11469 and DIN 6120 standards.
End-of-life Management and Recycling	<p>HP Inc. offers end-of-life HP product return and recycling programs in many geographic areas. To recycle your product, please go to: http://www.hp.com/go/reuse-recycle or contact your nearest HP sales office. Products returned to HP will be recycled, recovered or disposed of in a responsible manner.</p> <p>The EU WEEE directive (2002/95/EC) requires manufacturers to provide treatment information for each product type for use by treatment facilities. This information (product disassembly instructions) is posted on the Hewlett Packard web site at: http://www.hp.com/go/recyclers. These instructions may be used by recyclers and other WEEE treatment facilities as well as HP OEM customers who integrate and re-sell HP equipment.</p> <p>Global Citizenship Report http://www.hp.com/hpinfo/globalcitizenship/gcreport/index.html Eco-label certifications http://www8.hp.com/us/en/hp-information/environment/ecolabels.html ISO 14001 certificates: http://www.hp.com/hpinfo/globalcitizenship/environment/pdf/PC_GBU_Product_Design_ISO_14K_Certificate.pdf and http://www.hp.com/hpinfo/globalcitizenship/environment/pdf/cert.pdf</p>
HP, Inc. Corporate Environmental Information	<p>For more information about HP's commitment to the environment:</p> <p style="text-align: center;">Global Citizenship Report</p>

Features

	<p>http://www.hp.com/hpinfo/globalcitizenship/gcreport/index.html</p> <p>Eco-label certifications</p> <p>http://www8.hp.com/us/en/hp-information/environment/ecolabels.html</p> <p>ISO 14001 certificates:</p> <p>http://h20195.www2.hp.com/V2/GetDocument.aspx?docname=c04755842</p> <p>and</p> <p>http://www.hp.com/hpinfo/globalcitizenship/environment/pdf/cert.pdf</p>
footnotes	<ol style="list-style-type: none">1. Percentage of ocean-bound plastic contained in each component varies by product.2. Recycled plastic content percentage is based on the definition set in the IEEE 1680.1-2018 standard.3. 100% outer box packaging and corrugated cushions made from sustainably sourced certified and recycled fibers.4. Fiber cushions made from 100% recycled wood fiber and organic materials.5. Plastic cushions are made from >90% recycled plastic.

Features

HP EliteOne 870 27-inch G9 All-in-One Desktop PC

Eco-Label Certifications & declarations	<p>This product has received or is in the process of being certified to the following approvals and may be labeled with one or more of these marks:</p> <ul style="list-style-type: none"> • IT ECO declaration • US ENERGY STAR® • US Federal Energy Management Program (FEMP) • EPEAT¹ Gold registered in the United States. See http://www.epeat.net for registration status in your country. • TCO Certified • China Energy Conservation Program (CECP) • China State Environmental Protection Administration (SEPA) • Taiwan Green Mark • Korea Eco-label • Japan PC Green label • Commission Regulation (EC) No 617/2013 (ErP Lot 3) 		
Sustainable Impact Specifications	<ul style="list-style-type: none"> • Ocean-bound plastic in Rear cover, Speaker Box¹ • 70% post-consumer recycled plastic² • External Power Supply 90% Efficiency³ • Outside Box and corrugated cushions are 100% sustainably sourced and recyclable⁴ • Molded Paper Pulp Cushion inside box is 100% sustainably sourced and recyclable⁵ • Bulk packaging available⁶ 		
System Configuration	<p>The configuration used for the Energy Consumption and Declared Noise Emissions data for the All-in-One PC model is based on a typically configured PC featuring a hard disk drive, a high efficiency power supply, and a Microsoft Windows® operating system.</p>		
Energy Consumption (in accordance with US ENERGY STAR® test method)	115VAC, 60Hz	230VAC, 50Hz	100VAC, 60Hz
Normal Operation (Short idle)	25.79 W	25.88 W	25.61 W
Normal Operation (Long idle)	2.99 W	3.08 W	2.81 W
Sleep	2.96 W	3.05 W	2.78 W
Off	0.86 W	0.87 W	0.84 W
	<p>Note: Energy efficiency data listed is for an ENERGY STAR® compliant product if offered within the model family. HP computers marked with the ENERGY STAR® Logo are compliant with the applicable U.S. Environmental Protection Agency (EPA) ENERGY STAR® specifications for computers. If a model family does not offer ENERGY STAR® compliant configurations, then energy efficiency data listed is for a typically configured PC featuring a hard disk drive, a high efficiency power supply, and a Microsoft Windows® operating system.</p>		
Heat Dissipation*	115VAC, 60Hz	230VAC, 50Hz	100VAC, 60Hz
Normal Operation (Short idle)	184.2 BTU/hr	184.9 BTU/hr	182.9 BTU/hr
Normal Operation (Long idle)	21.4 BTU/hr	22 BTU/hr	20.1 BTU/hr
Sleep	21.1 BTU/hr	21.8 BTU/hr	19.9 BTU/hr
Off	6.1 BTU/hr	6.2 BTU/hr	6 BTU/hr
	<p>NOTE: Heat dissipation is calculated based on the measured watts, assuming the service level is attained for one hour.</p>		
Declared Noise Emissions (in accordance with ISO 7779 and ISO 9296)	Sound Power (L _{WAd} , bels)		Sound Pressure (L _{pAm} , decibels)

Features

Typically Configured – Idle	2.6	15.4
Fixed Disk – Random writes	2.6	15.4
Longevity and Upgrading	<p>This product can be upgraded, possibly extending its useful life by several years. Upgradeable features and/or components contained in the product may include:</p> <ul style="list-style-type: none"> • 6 USB ports • 2 memory slots • 1 Mini PCIe half-length slot • 1 MXM 3.0 Type A - 35W slot • 1 mSATA slot • 1 2.5" internal bay supporting up to Two 2.5" hard drives (HDD/SSD/SED/SSHD) • 1 5.25" external supporting optical drive <p>Spare parts are available throughout the warranty period and or for up to "5" years after the end of production.</p>	
Additional Information	<ul style="list-style-type: none"> • This product is in compliance with the Restrictions of Hazardous Substances (RoHS) directive - 2011/65/EC. • This HP product is designed to comply with the Waste Electrical and Electronic Equipment (WEEE) Directive – 2002/96/EC. • This product is in compliance with California Proposition 65 (State of California; Safe Drinking Water and Toxic Enforcement Act of 1986). • This product is in compliance with the IEEE 1680 (EPEAT) standard at the Gold level, see http://www.epeat.net • Plastics parts weighing over 25 grams used in the product are marked per ISO11469 and ISO1043. • This product is 97.9% recycle-able when properly disposed of at end of life 	
Packaging Materials	External:	PAPER/Paper 244 g COMPOSITE/paper/carton+plastic 4450 g Internal: PLASTIC/Polyethylene low density - LDPE 26 g The plastic packaging material contains at least xx% recycled content. The corrugated paper packaging materials contains at least xx% recycled content.
RoHS Compliance	<p>HP Inc. complies fully with materials regulations. We were among the first companies to extend the restrictions in the European Union (EU) Restriction of Hazardous Substances (RoHS) Directive to our products worldwide through the HP GSE. HP has contributed to the development of related legislation in Europe, as well as China, India, and Vietnam.</p> <p>We believe the RoHS directive and similar laws play an important role in promoting industry-wide elimination of substances of concern. We have supported the inclusion of additional substances—including PVC, BFRs, and certain phthalates—in future RoHS legislation that pertains to electrical and electronics products.</p> <p>We met our voluntary objective to achieve worldwide compliance with the new EU RoHS requirements for virtually all relevant products by July 2013, and we will continue to extend the scope of the commitment to include further restricted substances as regulations continue to evolve.</p> <p>To obtain a copy of the HP RoHS Compliance Statement, see: HP RoHS position statement.</p>	
Material Usage	<p>This product does not contain any of the following substances in excess of regulatory limits (refer to the HP General Specification for the Environment at http://www.hp.com/hpinfo/globalcitizenship/environment/supplychain/gen_specifications.html):</p>	

Features

	<ul style="list-style-type: none"> • Asbestos • Certain Azo Colorants • Certain Brominated Flame Retardants – may not be used as flame retardants in plastics • Cadmium • Chlorinated Hydrocarbons • Chlorinated Paraffins • Bis(2-Ethylhexyl) phthalate (DEHP) • Benzyl butyl phthalate (BBP) • Dibutyl phthalate (DBP) • Diisobutyl phthalate (DIBP) • Formaldehyde • Halogenated Diphenyl Methanes • Lead carbonates and sulfates • Lead and Lead compounds • Mercuric Oxide Batteries • Nickel – finishes must not be used on the external surface designed to be frequently handled or carried by the user. • Ozone Depleting Substances • Polybrominated Biphenyls (PBBs) • Polybrominated Biphenyl Ethers (PBBEs) • Polybrominated Biphenyl Oxides (PBBOs) • Polychlorinated Biphenyl (PCB) • Polychlorinated Terphenyls (PCT) • Polyvinyl Chloride (PVC) – except for wires and cables, and certain retail packaging has been voluntarily removed from most applications. • Radioactive Substances • Tributyl Tin (TBT), Triphenyl Tin (TPT), Tributyl Tin Oxide (TBTO)
Packaging Usage	<p>HP follows these guidelines to decrease the environmental impact of product packaging:</p> <ul style="list-style-type: none"> • Eliminate the use of heavy metals such as lead, chromium, mercury and cadmium in packaging materials. • Eliminate the use of ozone-depleting substances (ODS) in packaging materials. • Design packaging materials for ease of disassembly. • Maximize the use of post-consumer recycled content materials in packaging materials. • Use readily recyclable packaging materials such as paper and corrugated materials. • Reduce size and weight of packages to improve transportation fuel efficiency. • Plastic packaging materials are marked according to ISO 11469 and DIN 6120 standards.
End-of-life Management and Recycling	<p>HP Inc. offers end-of-life HP product return and recycling programs in many geographic areas. To recycle your product, please go to: http://www.hp.com/go/reuse-recycle or contact your nearest HP sales office. Products returned to HP will be recycled, recovered or disposed of in a responsible manner.</p> <p>The EU WEEE directive (2002/95/EC) requires manufacturers to provide treatment information for each product type for use by treatment facilities. This information (product disassembly instructions) is posted on the Hewlett Packard web site at: http://www.hp.com/go/recyclers. These instructions may be used by recyclers and other WEEE treatment facilities as well as HP OEM customers who integrate and re-sell HP equipment.</p>
HP, Inc. Corporate Environmental Information	<p>For more information about HP's commitment to the environment:</p> <p>Global Citizenship Report http://www.hp.com/hpinfo/globalcitizenship/gcreport/index.html Eco-label certifications http://www8.hp.com/us/en/hp-information/environment/ecolabels.html ISO 14001 certificates:</p>

Features

	<p>http://h20195.www2.hp.com/V2/GetDocument.aspx?docname=c04755842 and http://www.hp.com/hpinfo/globalcitizenship/environment/pdf/cert.pdf</p>
footnotes	<ol style="list-style-type: none">1. Percentage of ocean-bound plastic contained in each component varies by product.2. Recycled plastic content percentage is based on the definition set in the IEEE 1680.1-2018 standard.3. External power supplies, WWAN modules, power cords, cables and peripherals excluded. 100% outer box packaging and corrugated cushions made from sustainably sourced certified and recycled fibers.4. 100% outer box packaging and corrugated cushions made from sustainably sourced certified and recycled fibers.5. Fiber cushions made from 100% recycled wood fiber and organic materials.6. Plastic cushions are made from from >90% recycled plastic.

Features

SERVICE AND SUPPORT

On-site Warranty¹: One-year (1-1-1) limited warranty delivers one year of on-site, next business day² service for parts and labor support. Service offers terms up to 5 years by choosing an optional HP Care Pack. To choose the right level of service for your HP product, visit HP Care Pack Central: <http://www.hp.com/go/cpc>.³

1. Terms and conditions may vary by country. Certain restrictions and exclusions apply. Other warranty variations may be offered in your region.
2. On-site service may be provided pursuant to a service contract between HP and an authorized HP third-party provider and is not available in certain countries. Global service response times are based on commercially reasonable best effort and may vary by country.
3. Service levels and response times for HP Care Packs may vary depending on your geographic location. Service starts on date of hardware purchase. Restrictions and limitations apply. For details, visit www.hp.com/go/cpc. HP services are governed by the applicable HP terms and conditions of service provided or indicated to Customer at the time of purchase. Customer may have additional statutory rights according to applicable local laws, and such rights are not in any way affected by the HP terms and conditions of service or the HP Limited Warranty provided with your HP Product.

CERTIFICATION AND COMPLIANCE

Energy Efficiency Compliance

ENERGY STAR[®] certified. EPEAT[®] registered where applicable. EPEAT[®] registration varies by country. See <http://www.epeat.net> for registration status by country. According to IEEE 1680.1-2018.

PROCESSORS

12th and 13th Generation Intel® Core™ Processors

All HP EliteDesk 800 G9 Business PC models featuring this technology include processors that are part of the Intel® Stable Image Platform Program (SIPP) designed to ensure the stability promise inherent in the value proposition of the HP Elite series G9 Desktop Business PC.

Intel® Management Engine (ME) v16 – An advanced set of remote management features and functionality which provides network administrators the latest and most effective tools to remotely discover, heal, and protect networked client systems regardless of the system's health or power state. AMT 16 includes the following advanced management functions:

- Support for configuration of Intel ME 16.0 capabilities
- No reset after provisioning
- Support for Intel Enterprise Digital Fence
- The Platform Discovery Utility can now discover these additional Intel products:
 - Public Key Infrastructure
- Profile Editor and Profile Editor Plugin Interface
- Required Permissions for Solutions Framework

Technical Specifications – Display Panel Specifications

DISPLAY PANEL SPECIFICATIONS

NOTE: All specifications represent the typical specifications provided by HP's component manufacturers; actual performance may vary either higher or lower. For All in One only Intel® HD Graphics (integrated).

23.8" diagonal IPS widescreen WLED backlit anti-glare LCD (1920 x 1080) Projected Capacitive Touch supports up to 10 touch-points

Support HW low blue light feature

Type	IPS WLED Backlit LCD
Active area (mm)	527.04 x 296.46
Native resolution (HxV)	1920 x 1080
Refresh rate	60 Hz @ 1920 x 1080
Aspect ratio	16:9
Pixel pitch (HxV)(mm)	0.2745 x 0.2745
Contrast ratio	1000:1
Brightness	300nits*
Viewing angle (HxV)	178° x 178°
Backlight lamp life (to half brightness)	30,000 hours minimum
Color support	Up to 16.7 million colors with 8 Bit (6 Bit + FRC)
Color gamut	sRGB 99%
Anti-glare	Yes
Response time	14ms
Default color temperature	Warm (6500K)

NOTE*: Actual brightness will be lower with touchscreen

23.8" diagonal IPS widescreen WLED backlit anti-glare LCD (1920 x 1080) non-touch

Support HW low blue light feature

Type	IPS WLED Backlit LCD
Active area (mm)	527.04 x 296.46
Native resolution (HxV)	1920 x 1080
Refresh rate	60 Hz @ 1920 x 1080
Aspect ratio	16:9
Pixel pitch (HxV)(mm)	0.2745 x 0.2745
Contrast ratio	1000:1
Brightness	250nits*
Viewing angle (HxV)	178° x 178°
Backlight lamp life (to half brightness)	30,000 hours minimum
Color support	Up to 16.7 million colors with 8 Bit (6 Bit + FRC)
Color gamut	NTSC 72%
Anti-glare	Yes
Response time	14ms
Default color temperature	Warm (6500K)

Technical Specifications – Display Panel Specifications

27.0" diagonal IPS widescreen WLED backlit anti-glare LCD (1920 x 1080) non-touch

Support HW low blue light feature

Type	IPS WLED Backlit LCD
Active area (mm)	597.888 x 336.312
Native resolution (HxV)	1920 x 1080
Refresh rate	60 Hz @ 1920 x 1080
Aspect ratio	16:9
Pixel pitch (HxV)(mm)	0.3114 x 0.3114
Contrast ratio	1000:1
Brightness	250nits*
Viewing angle (HxV)	178° x 178°
Backlight lamp life (to half brightness)	30,000 hours minimum
Color support	Up to 16.7 million colors with 8 Bit(6 Bit + FRC)
Color gamut	NTSC 72%
Anti-glare	Yes
Response time	14ms
Default color temperature	Warm (6500K)

NOTE*: Actual brightness will be lower with touchscreen

27.0" diagonal IPS widescreen WLED backlit anti-glare LCD (2560 x 1440) non-touch

Support HW low blue light feature

Type	IPS WLED Backlit LCD
Active area (mm)	596.736 x 335.664
Native resolution (HxV)	2560 x 1440
Refresh rate	60 Hz @ 2560 x 1440
Aspect ratio	16:9
Pixel pitch (HxV)(mm)	0.2331 x 0.2331
Contrast ratio	1000:1
Brightness*	250nits*
Viewing angle (HxV)	178° x 178°
Backlight lamp life (to half brightness)	30,000 hours minimum
Color support	Up to 16.7 million colors with 8 bit (True)
Color gamut	NTSC 72%
Anti-glare	Yes
Response time	14ms
Default color temperature	Warm (6500K)

NOTE*: Actual brightness will be lower with touchscreen.

For 27" touch optional models, a glass touch cover panel is used over the anti-glare panel which sits beneath. The top cover-glass is not anti-glare.

Technical Specifications – Display Panel Specifications

27.0" diagonal IPS widescreen WLED backlit LCD (2560 x 1440) Touch Projected Capacitive Touch supports up to 10 touch-points

Support HW low blue light feature

Type	IPS WLED Backlit LCD
Active area (mm)	596.736 x 335.664
Native resolution (HxV)	2560 x 1440
Refresh rate	60 Hz @ 2560 x 1440
Aspect ratio	16:9
Pixel pitch (HxV)(mm)	0.2331 x 0.2331
Contrast ratio	1000:1
Brightness*	250nits*
Viewing angle (HxV)	178° x 178°
Backlight lamp life (to half brightness)	30,000 hours minimum
Color support	Up to 16.7 million colors with 8 bit (True)
Color gamut	NTSC 72%
Anti-glare	No
Response time	14ms
Default color temperature	Warm (6500K)

NOTE*: Actual brightness will be lower with touchscreen.

For 27" touch optional models, a glass touch cover panel is used over the anti-glare panel which sits beneath. The top cover-glass is not anti-glare.

Technical Specifications – Stand Specifications

Adjustable Height Stand:	Height - Vertical/Landscape Adjustment	130mm (± 2 mm)
	Portrait Adjustment	No portrait
	Tilt Angle	-5° to +18° ($\pm 2^\circ$) in landscape and portrait
	Rotation (Swivel)	90° (left 45°[+0/-2°], right 45°[+0/-2°])
	Pivot	No pivot
Recline Stand:	Height - Vertical Adjustment	No height
	Tilt Angle	+35°(+/-3°) to +60°(+/-3°)
	Rotation (swivel)	No swivel

Technical Specifications – Graphics

GRAPHICS

HP Elite Mini 800 G9 Desktop PC

Intel® HD Graphics (integrated)	Integrated
VGA Controller	Multimode capable; supports HDCP, Display Port Audio (2 streams), HBR2 link rates and Multi-Stream Technology for a maximum of 2 displays connected to any output controlled by Intel® Graphics
DisplayPort™	Supports HDMI 2.1 features Supports HDCP 2.3 Supports audio over HDMI
HDMI (on board /optional)	VGA output
VGA (optional)	DisplayPort™ over the optional USB-C® module
USB-C® DP Alt Mode (optional)	The actual amount of maximum graphics memory can be >4GB. System memory is allocated for graphics as needed using Intel's Dynamic Video Memory Technology (DVMT), to provide an optimal balance between graphics and system memory use.
Memory	up to 16 bits/color HEVC 10b Enc/12b Dec HW VP9 12b Dec HW HDR Rec. 2020 DX12
Maximum Color Depth	4096 x 2304 @60Hz
Graphics/Video API Support	4096 x 2160@60Hz 2048 x 1536@ 60Hz 5120 x 2160@ 60Hz 3840 x 2160@ 60Hz 5120 x 3200@60Hz
Max resolution (DP)	
Max resolution (HDMI)	
Max resolution (option VGA)	
Max resolution (option DP)	
Max resolution (option HDMI)	
Max resolution (option Type C)	
NVIDIA® GeForce 3050Ti Graphics Card	
Engine Clock	Base: 1222.5MHZ Boost: 1485MHZ
Memory Clock	5501 MHz
Memory Size (width)	4GB (128-bit)
Memory Type	GDDR6
Max. Resolution (DP)	5120x3200@60Hz
Max. Resolution (HDMI)	4096x2160x24 bpp@60Hz
HDCP Compliance	Yes
Total power consumption (W)	60W

Technical Specifications – Graphics

HP Elite SFF 800 G9 Desktop PC

Intel® HD Graphics (integrated)	Integrated
VGA Controller	Multimode capable; supports HDCP, Display Port Audio), Onboard support HBR2 link rates/option DP support to HBR3 and Multi-Stream Technology for a maximum of 3-displays connected to any output controlled by Intel® Graphics
DisplayPort™	Supports HDMI 2.1 features (onboard HDMI support HDMI1.4; Option HDMI support HDMI 2.1)
HDMI (onboard / optional)	Supports HDCP 2.3 (Support HDCP 1.4/2.3) Supports audio over HDMI
VGA (optional)	VGA output
USB-C® DP Alt Mode (optional)	DisplayPort™ over the optional USB-C® module (Support DP1.4 HBR2)
Memory	The actual amount of maximum graphics memory can be >4GB. System memory is allocated for graphics as needed using Intel's Dynamic Video Memory Technology (DVMT), to provide an optimal balance between graphics and system memory use.
Maximum Color Depth	up to 16 bits/color
Graphics/Video API Support	HEVC 10b Enc/12b Dec HW VP9 12b Dec HW à AV1 decode support 8/10b, 4:2:0 HDR Rec. 2020 DX12
Max. Resolution (VGA Option)	2048 x 1536@60Hz
Max. Resolution (Onboard HDMI)	1920 x 1080@60Hz
Max. Resolution (Option HDMI)	3840 x 2160@60Hz
Max. Resolution (On board DP)	HBR2: 4096 x 2304@60hz 24 bpp
Max. Resolution (Option DP)	HBR3: 5120 x3200 @60hz 24 bpp
Max. Resolution (Option Type C)	DP HBR2: 4096 x2304 @60hz 24bpp

NVIDIA® T400 2GB Graphics Card

Engine Clock	2100 MHz
Memory Clock	5001 MHz
Memory Size (width)	2GB (64-bit)
Memory Type	256M x 16 GDDR6
Max. Resolution (DP)	7680x4320@120Hz
Multi Display Support	4 displays
HDCP Compliance	Yes
Rear I/O connectors (bracket)	mDPx3
Cooling (active/passive)	Active fan-sink (Active cooling with dynamic speed)
Total power consumption (W)	30W
PCB form-factor with bracket	LP PCB with LP bracket

Technical Specifications – Graphics

NVIDIA® T400 4GB Graphics Card

Engine Clock	2100 MHz
Memory Clock	5001 MHz
Memory Size (width)	4GB (64-bit)
Memory Type	512M x 16 GDDR6
Max. Resolution (DP)	7680x4320@120Hz
Multi Display Support	4 displays
HDCP Compliance	Yes
Rear I/O connectors (bracket)	mDPx3
Cooling (active/passive)	Active fan-sink (Active cooling with dynamic speed)
Total power consumption (W)	30W
PCB form-factor with bracket	LP PCB with LP bracket

MD Radeon™ RX 6300 2GB GDDR6 Graphics card

Engine Clock	Base: 1512 Mhz Boost: 2040 Mhz
Memory Size / Width	2GB / 32bit
Graphic Memory Type / Clock	512Mx32 GDDR6 ,1 pcs / 16Gbps
Max. Resolution (HDMI)	7680x4320@60Hz
Max. Resolution (DP)	7680x4320@120Hz
Multi Display Support	2 displays
HDCP Compliance	Yes
Rear I/O connectors (bracket)	HDMIx1+ DPx1 (LP)
Cooling (active/passive)	Active
Total power consumption (W)	32W
Form-factor	X:160.2mm/Y:68.9mm/Z: 22.6mm PCB with single slot

Technical Specifications – Graphics

HP Elite Tower 800 G9 Desktop PC

Intel® UHD Graphics (integrated)	
VGA Controller	Integrated
DisplayPort™	Multimode capable; supports HDCP, Display Port Audio, Onboard support HBR2 link rates/option DP support to HBR3 and Multi-Stream Technology for a maximum of 3 displays connected to any output controlled by Intel® Graphics
HDMI (onboard / optional)	Supports HDMI 2.1 features (onboard HDMI support HDMI1.4; Option HDMI support HDMI 2.1) Supports HDCP 2.3 (Support HDCP 1.4/2.3) Supports audio over HDMI
VGA (optional)	VGA output
USB-C® DP Alt Mode (optional)	DisplayPort™ over the optional USB-C® module (Support DP1.4 HBR2)
Memory	The actual amount of maximum graphics memory can be >4GB. System memory is allocated for graphics as needed using Intel's Dynamic Video Memory Technology (DVMT), to provide an optimal balance between graphics and system memory use.
Maximum Color Depth	up to 16 bits/color
Graphics/Video API Support	HEVC 10b Enc/12b Dec HW VP9 12b Dec HW à AV1 decode support 8/10b, 4:2:0 HDR Rec. 2020 DX12
Max. Resolution (VGA Option)	2048 x 1536@60Hz
Max. Resolution (Onboard HDMI)	1920 x 1080@60Hz
Max. Resolution (Option HDMI)	3840 x 2160@60Hz
Max. Resolution (Option HDMI)	3840 x 2160@60Hz
Max. Resolution (On board DP)	HBR2: 4096 x 2304@60hz 24 bpp
Max. Resolution (Option DP)	HBR3: 5120 x 3200 @60hz 24 bpp
Max. Resolution (Option Type C)	DP HBR2: 4096 x 2304 @60hz 24bpp

NVIDIA® GeForce® RTX 3070 LHR Graphics Card

Engine Clock	1730 MHz
Memory Clock	8000 MHz
Memory Size(width)	8 GB (256-bit)
Memory Type	256M x 32 GDDR6
Max. Resolution (HDMI)	7680x4320@60Hz
Max. Resolution (DP)	7680x4320@60Hz
Multi Display Support	4 displays
HDCP Compliance	Yes
Rear I/O connectors (bracket)	HDMIx1 + DPx3
Cooling (active/passive)	Active fan-sink (Active cooling with dynamic speed)
Total power consumption (W)	<220W
PCB form-factor with bracket	ATX (Full height) PCB with ATX dual slot bracket

NOTE: 12 pins connector requires for RTX3070 with 550W PSU

Technical Specifications – Graphics

NVIDIA® GeForce® RTX 3060 LHR Graphics Card

Engine Clock	Base: 1320 Mhz Boost: 1777 Mhz
Frame Buffer Size / Width	12GB / 192bit
Graphic Memory Type / Clock	512Mx16 GDDR6 @ 6 pcs / 16Gbps
Max. Resolution (HDMI)	7680x4320@60Hz
Max. Resolution (DP)	7680x4320@60Hz
Multi Display Support	4 displays
HDCP Compliance	Yes
Rear I/O connectors (bracket)	HDMIx1+ DPx3
Cooling (active/passive)	Active fansink with 4 pin fan control
Total power consumption (W)	170W
PCB form-factor with bracket	ATX (X:188mm/Y:111.15mm/Z: 34.80mm) PCB with ATX dual slot bracket

NOTE: 8 pins connector requires for RTX3060 with 400W PSU

NVIDIA® GeForce® RTX 3050 8GB GDDR6 Graphics Card

Engine Clock	Base: 1515 Mhz Boost: 1755 Mhz
Frame Buffer Size / Width	8GB/128bit
Graphic Memory Type / Clock	512Mx32 GDDR6 @ 4 pcs/14Gbps
Max. Resolution (HDMI)	7680x4320@60Hz
Max. Resolution (DP)	7680x4320@60Hz
Multi Display Support	4 displays
HDCP Compliance	Yes
Rear I/O connectors (bracket)	HDMIx1+ DPx3
Cooling (active/passive)	Active fansink with 4 pin fan control
Total power consumption (W)	120W
Form-factor	ATX (X:144.7mm/Y:111.15mm/Z: 36.70mm) PCB with ATX dual slot bracket

NOTE: 8 pins connector requires for RTX3050 with 400W PSU

NVIDIA® T400 2GB Graphics Card

Engine Clock	2100 MHz
Memory Clock	5001 MHz
Memory Size (width)	2GB (64-bit)
Memory Type	256M x 16 GDDR6
Max. Resolution (DP)	7680x4320@120Hz
Multi Display Support	4 displays
HDCP Compliance	Yes
Rear I/O connectors (bracket)	mDPx3
Cooling (active/passive)	Active fan-sink (Active cooling with dynamic speed)
Total power consumption (W)	30W

Technical Specifications – Graphics

NVIDIA® T400 4GB Graphics Card

Engine Clock	2100 MHz
Memory Clock	5001 MHz
Memory Size (width)	4GB (64-bit)
Memory Type	512M x 16 GDDR6
Max. Resolution (DP)	7680x4320@120Hz
Multi Display Support	4 displays
HDCP Compliance	Yes
Rear I/O connectors (bracket)	mDPx3
Cooling (active/passive)	Active fan-sink (Active cooling with dynamic speed)
Total power consumption (W)	30W
PCB form-factor with bracket	LP PCB with LP bracket

Intel® Arc™ A380 6GB GDDR6 Graphics card⁴

Engine Clock	2150Mhz
Frame Buffer Size / Width	6GB/96bit
Graphic Memory Type / Clock	GDDR6 ,3 pcs/15.5Gbps
Max. Resolution (HDMI)	4096 x2160@60Hz
Max. Resolution (DP)	7680x4320@60Hz
Multi Display Support	4 displays
HDCP Compliance	Yes
Rear I/O connectors (bracket)	DP x3 + HDMI x1
Cooling (active/passive)	Active
Total power consumption (W)	75W

AMD Radeon™ RX 6300 2GB GDDR6 Graphics card

Engine Clock	Base: 1512 Mhz Boost: 2040 Mhz
Memory Size/Width	2GB/32bit
Graphic Memory Type/Clock	512Mx32 GDDR6 ,1 pcs/16Gbps
Max. Resolution (HDMI)	7680x4320@60Hz
Max. Resolution (DP)	7680x4320@120Hz
Multi Display Support	2 displays
HDCP Compliance	Yes
Rear I/O connectors (bracket)	HDMIx1 + DPx1 (FH)
Cooling (active/passive)	Active
Total power consumption (W)	32W
Form-factor	X:160.2mm/Y:68.9mm/Z: 22.6mm PCB with single slot

Technical Specifications – Graphics

HP EliteOne 840 23.8 inch G9 All-in-One Desktop PC

Intel® UHD Graphics (integrated)	Integrated
VGA Controller	Multimode capable; supports HDCP, Display Port Audio (2 streams), HBR3 link rates and Multi-Stream Technology for a maximum of 3 displays (including the integrated panel and all attached displays)
DisplayPort™ 1.4	Support HDMI-In
HDMI-in Memory	The actual amount of maximum graphics memory can be >4GB. System memory is allocated for graphics as needed using Intel's Dynamic Video Memory Technology (DVMT), to provide an optimal balance between graphics and system memory use.
Maximum Color Depth	up to 10 bits/color
Graphics/Video API Support	HEVC 10b Enc/Dec HW VP9 10b Dec HW HDR Rec. 2020 DX12
Max. Resolution (DP)	5120 x 3200@60Hz
Max. Resolution (Type C)	5120 x 3200@60Hz

NVIDIA® GeForce 3050Ti Graphics Card

Engine Clock	735 MHz
Memory Clock	5501 MHz
Memory Size (width)	4GB (128-bit)
Memory Type	GDDR6
Max. Resolution (DP)	5120x3200@60Hz
HDCP Compliance	Yes
Total power consumption (W)	35W

Technical Specifications – Graphics

HP EliteOne 870 27 inch G9 All-in-One Desktop PC

Intel® UHD Graphics (integrated)	
VGA Controller	Integrated
DisplayPort™ 1.4	Multimode capable; supports HDCP, Display Port Audio (2 streams), HBR3link rates and Multi-Stream Technology for a maximum of 3 displays (including the integrated panel and all attached displays)
HDMI-in	Support HDMI-In
Memory	The actual amount of maximum graphics memory can be >4GB. System memory is allocated for graphics as needed using Intel's Dynamic Video Memory Technology (DVMT), to provide an optimal balance between graphics and system memory use.
Maximum Color Depth	up to 10 bits/color
Graphics/Video API Support	HEVC 10b Enc/Dec HW VP9 10b Dec HW HDR Rec. 2020 DX12
Max. Resolution (DP)	5120 x 3200@60Hz
Max. Resolution (Type C)	5120 x 3200@60Hz

NVIDIA® GeForce 3050Ti Graphics Card

Engine Clock	735 MHz
Memory Clock	5501 MHz
Memory Size (width)	4GB (128-bit)
Memory Type	GDDR6
Max. Resolution (DP)	5120x3200@60Hz
HDCP Compliance	Yes
Total power consumption (W)	35W

Technical Specifications – Storage

STORAGE

NOTE: Starting November 1, 2023, HP PCs with Windows require Windows to be installed on SSD. HDD can only be configured as additional data drives and not as the boot drive.

500GB 7200RPM 3.5in SATA HDD

Capacity	500GB
Rotational Speed	7,200 rpm
Interface	SATA 6.0 Gb/s
Buffer Size	32 MB
Logical Blocks	976,773,168
Seek Time	11 ms (Average)
Height	1 in/2.54 cm
Width	Media diameter: 3.5 in/8.89 cm Physical size: 4 in/10.2 cm
Operating Temperature	41° to 131° F (5° to 55° C)

NOTE: For storage drives, GB = 1 billion bytes. TB = 1 trillion bytes. Actual formatted capacity is less. Up to 36GB (for Windows) is reserved for system recovery software.

1TB 7200RPM 3.5in SATA HDD

Capacity	1TB
Rotational Speed	7,200 rpm
Interface	SATA 6 Gb/s
Buffer Size	64 MB
Logical Blocks	1,953,525,168
Seek Time	11 ms (Average)
Height	1 in/2.54 cm
Width (nominal)	Media diameter: 3.5 in/8.89 cm Physical size: 4 in/10.2 cm
Operating Temperature	41° to 131° F (5° to 55° C)

NOTE: For storage drives, GB = 1 billion bytes. TB = 1 trillion bytes. Actual formatted capacity is less. Up to 36GB (for Windows) is reserved for system recovery software.

2TB 7200RPM 3.5in SATA HDD

Capacity	2TB
Rotational Speed	7,200 rpm
Interface	SATA 6 Gb/s
Buffer Size	128 MB
Logical Blocks	3,907,050,336
Seek Time	11 ms (Average)
Height	1.028 in/26.11 mm
Width (nominal)	Media diameter: 3.5 in/88.9 mm Physical size: 4 in/102 mm
Operating Temperature	41° to 131° F (5° to 55° C)

Technical Specifications – Storage

NOTE: For storage drives, GB = 1 billion bytes. TB = 1 trillion bytes. Actual formatted capacity is less. Up to 36GB (for Windows) is reserved for system recovery software.

500GB 7200RPM 2.5in SATA HDD

Capacity	500GB
Rotational Speed	7,200 rpm
Interface	SATA 6 Gb/s
Buffer Size	Up to 128 MB
Logical Blocks	976,773,168
Seek Time	12 ms (Average)
Height	0.283 in/7.2 mm (Max.)
Width (nominal)	2.75 in/70 mm (nominal)
Operating Temperature	41° to 131° F (5° to 55° C)

NOTE: For storage drives, GB = 1 billion bytes. TB = 1 trillion bytes. Actual formatted capacity is less. Up to 36GB (for Windows) is reserved for system recovery software.

1TB 7200RPM 2.5in SATA HDD

Capacity	1TB
Rotational Speed	7,200 rpm
Interface	SATA 6 Gb/s
Buffer Size	Up to 128 MB
Logical Blocks	1,953,525,168
Seek Time	12 ms (Average)
Height	0.283 in/7.2 mm (Max.)
Width (nominal)	2.75 in/70 mm (nominal)
Operating Temperature	41° to 131° F (5° to 55° C)

NOTE: For storage drives, GB = 1 billion bytes. TB = 1 trillion bytes. Actual formatted capacity is less. Up to 36GB (for Windows) is reserved for system recovery software.

2TB 5400RPM 2.5in SATA HDD

Capacity	2TB
Rotational Speed	5,400 rpm
Interface	SATA 6 Gb/s
Buffer Size	128 MB
Logical Blocks	3,907,050,336
Seek Time	12 ms (Average)
Height	0.374 in/9.5 mm (nominal)
Width (nominal)	2.75 in/70 mm (nominal)
Operating Temperature	41° to 131° F (5° to 55° C)

NOTE: For storage drives, GB = 1 billion bytes. TB = 1 trillion bytes. Actual formatted capacity is less. Up to 36GB (for Windows) is reserved for system recovery software.

Technical Specifications – Storage

500GB 7200RPM 2.5in Self Encrypted OPAL2 SATA HDD

Capacity	500GB
Architecture	Self-Encrypting (SED) Solid State Drive with SATA interface
Interface	SATA 6 Gb/s
Buffer Size	128 MB
Logical Blocks	976,773,168
Seek Time	12 ms (Average)
Height	0.283 in/7.2 mm (Max.)
Width	2.75 in/70 mm (nominal)
Operating Temperature	41° to 131° F (5° to 55° C)

NOTE: For storage drives, GB = 1 billion bytes. TB = 1 trillion bytes. Actual formatted capacity is less. Up to 36GB (for Windows) is reserved for system recovery software.

256GB M.2 2280 PCIe NVMe SSD

Capacity	256GB
Interface	PCIe NVMe
Minimum Sequential Read	2000 MB/s \pm 10%
Minimum Sequential Write	900 MB/s \pm 10%
Logical Blocks	500,118,192
Features	TRIM; L1.2

NOTE: For storage drives, GB = 1 billion bytes. TB = 1 trillion bytes. Actual formatted capacity is less. Up to 36GB (for Windows) is reserved for system recovery software.

512GB M.2 2280 PCIe NVMe SSD

Capacity	512GB
Interface	PCIe NVMe
Minimum Sequential Read	2200 MB/s \pm 10%
Minimum Sequential Write	1000 MB/s \pm 10%
Logical Blocks	1,000,215,216
Features	TRIM; L1.2

NOTE: For storage drives, GB = 1 billion bytes. TB = 1 trillion bytes. Actual formatted capacity is less. Up to 36GB (for Windows) is reserved for system recovery software.

1TB M.2 2280 PCIe NVMe SSD

Capacity	1TB
Interface	PCIe NVMe
Minimum Sequential Read	2200 MB/s \pm 10%
Minimum Sequential Write	1600 MB/s \pm 10%
Logical Blocks	2,000,409,264
Features	TRIM; L1.2

NOTE: For storage drives, GB = 1 billion bytes. TB = 1 trillion bytes. Actual formatted capacity is less. Up to 36GB (for Windows) is reserved for system recovery software.

Technical Specifications – Storage

256GB M.2 2280 PCIe NVMe Three Layer Cell SSD

Capacity	256GB
Interface	PCIe Gen4x4
Minimum Sequential Read	4000 MB/s \pm 10%
Minimum Sequential Write	2000 MB/s \pm 10%
Logical Blocks	500,118,192
Features	TRIM; L1.2; Pyrite 2.0

NOTE: For storage drives, GB = 1 billion bytes. TB = 1 trillion bytes. Actual formatted capacity is less. Up to 36GB (for Windows) is reserved for system recovery software.

512GB M.2 2280 PCIe NVMe Three Layer Cell SSD

Capacity	512GB
Interface	PCIe Gen4x4
Minimum Sequential Read	6400 MB/s \pm 10%
Minimum Sequential Write	3500 MB/s \pm 10%
Logical Blocks	1,000,215,216
Features	TRIM; L1.2; Pyrite 2.0

NOTE: For storage drives, GB = 1 billion bytes. TB = 1 trillion bytes. Actual formatted capacity is less. Up to 36GB (for Windows) is reserved for system recovery software.

1TB M.2 2280 PCIe NVMe Three Layer Cell SSD

Capacity	1TB
Interface	PCIe Gen4x4
Minimum Sequential Read	6400 MB/s \pm 10%
Minimum Sequential Write	5000 MB/s \pm 10%
Logical Blocks	2,000,409,264
Features	TRIM; L1.2; Pyrite 2.0

NOTE: For storage drives, GB = 1 billion bytes. TB = 1 trillion bytes. Actual formatted capacity is less. Up to 36GB (for Windows) is reserved for system recovery software.

2TB M.2 2280 PCIe NVMe Three Layer Cell SSD

Capacity	2TB
Interface	PCIe Gen4x4
Minimum Sequential Read	6400 MB/s \pm 10%
Minimum Sequential Write	5000 MB/s \pm 10%
Logical Blocks	4,000,797,360
Features	TRIM; L1.2; Pyrite 2.0

NOTE: For storage drives, GB = 1 billion bytes. TB = 1 trillion bytes. Actual formatted capacity is less. Up to 36GB (for Windows) is reserved for system recovery software.

Technical Specifications – Storage

256GB M.2 2280 PCIe NVMe Self Encrypted OPAL2 Value SSD

Capacity	256GB
Interface	PCIe NVMe
Minimum Sequential Read	2000 MB/s ±10%
Minimum Sequential Write	900 MB/s ±10%
Logical Blocks	500,118,192
Features	Pyrite 2.0; TRIM; L1.2

NOTE: For storage drives, GB = 1 billion bytes. TB = 1 trillion bytes. Actual formatted capacity is less. Up to 36GB (for Windows) is reserved for system recovery software.

256GB M.2 2280 PCIe NVMe Self Encrypted OPAL2 Three Layer Cell SSD

Capacity	256GB
Interface	PCIe Gen4x4
Minimum Sequential Read	4000 MB/s ±10%
Minimum Sequential Write	2000 MB/s ±10%
Logical Blocks	500,118,192
Features	TRIM; L1.2; TCG Opal 2.0

NOTE: For storage drives, GB = 1 billion bytes. TB = 1 trillion bytes. Actual formatted capacity is less. Up to 36GB (for Windows) is reserved for system recovery software.

512GB M.2 2280 PCIe NVMe Self Encrypted OPAL2 Three Layer Cell SSD

Capacity	512GB
Interface	PCIe Gen4x4
Minimum Sequential Read	6400 MB/s ±10%
Minimum Sequential Write	3500 MB/s ±10%
Logical Blocks	1,000,215,216
Features	TRIM; L1.2; TCG Opal 2.0

NOTE: For storage drives, GB = 1 billion bytes. TB = 1 trillion bytes. Actual formatted capacity is less. Up to 36GB (for Windows) is reserved for system recovery software.

OPTICAL DISC DRIVES

HP 9.5mm Slim DVD-ROM Drive

Height	9.5 mm height
Orientation	Either horizontal or vertical
Interface type	SATA/ATAPI
Dimensions (W x H x D)	5.04 x 0.37 x 5.0 in (128 x 9.5 x 127 mm) without bezel
Weight (max)	Up to 0.31 lb (140g) without bezel
Read Speeds	DVD+R/-R/+RW/ -RW/+R DL /-R DL Up to 8X DVD-ROM Up to 8X CD-ROM, CD-R Up to 24X CD-RW Up to 24X
Access time (typical reads, including settling)	Random: DVD-ROM: 170 ms (typical), CD-ROM: 170 ms (typical) Full stroke: DVD-ROM: 320 ms (typical), CD-ROM: 320 ms (typical)

Technical Specifications – Storage

Power	Source Slimline SATA DC power receptacle DC Power Requirement 5 VDC ± 5%-100 mV ripple p-p DC Current 5 VDC (< 1000 mA typical, 1600 mA maximum)
Environmental conditions (operating - non-condensing)	Temperature 41° to 122° F (5° to 50° C) Relative Humidity 10% to 80% Maximum Wet Bulb Temperature 84° F (29° C)
HP 9.5mm Slim DVD Writer Drive	
Height	9.5 mm height
Orientation	Either horizontal or vertical
Interface type	SATA/ATAPI
Disc recording capacity	Up to 8.5 GB DL or 4.7 GB standard
Dimensions (W x H x D)	5.04 x 0.37 x 5.0 in (128 x 9.5 x 127 mm) without bezel
Weight (max)	0.31 lb (140 g)
Write Speeds	DVD-R DL - Up to 6X DVD+R - Up to 8X DVD+RW - Up to 8X DVD+R DL - Up to 6X DVD-R - Up to 8X DVD-RW - Up to 6X CD-R - Up to 24X CD-RW - Up to 10X DVD-RW, DVD+RW - Up to 8X
Read Speeds	DVD-R DL, DVD+R DL - Up to 8X DVD+R, DVD-R - Up to 8X DVD-ROM DL, DVD-ROM - Up to 8X CD-ROM, CD-R - Up to 24X CD-RW - Up to 24X
Access time (typical reads, including settling)	Random DVD-ROM: 170 ms (typical), CD-ROM: 170 ms (typical) Full Stroke DVD-ROM: 320 ms (typical), CD-ROM: 320 ms (typical) Stop Time 6 seconds (typical)
Power	Source Slimline SATA DC power receptacle DC Power Requirement 5 VDC ± 5%-100 mV ripple p-p DC Current 5 VDC (< 1000 mA typical, 1600 mA maximum)
Environmental conditions (operating - non-condensing)	Temperature 41° to 122° F (5° to 50° C) Relative Humidity 10% to 80% Maximum Wet Bulb Temperature 84° F (29° C)

NETWORKING AND COMMUNICATIONS

Intel® I219-LM 1 Gigabit Network Connection LOM (vPro)	
Connector	RJ-45
System Interface	PCI (Intel proprietary) + SMBus
Data rates supported	10 Mbit/s operation (10BASE-T; IEEE 802.3i; IEEE 802.3 clauses 13-14) 100 Mbit/s operation (100BASE-TX; IEEE 802.3u; IEEE 802.3 clauses 21-30) 1000 Mbit/s operation (1000BASE-T; IEEE 802.3ab; IEEE 802.3 clauses 40) Auto-Negotiation (Automatic Speed Selection) Full Duplex Operation at all Speeds, Half Duplex operation at 10 and 100 Mbit/s
IEEE Compliance	IEEE 802.1p QoS (Quality of Service) Support IEEE 802.1q VLAN support IEEE 802.3x Flow Control (IEEE 802.3 clauses 31-32; configurable) IEEE 802.3az EEE (Energy Efficient Ethernet)
Performance	TCP/IP/UDP Checksum Offload (configurable) Protocol Offload (ARP & NS) Large send offload and Giant send offload Receiving Side Scaling (Hash Mode Only) Jumbo Frame 9K
Power consumption	Cable Disconnection: 25mW 100Mbps Full Run: 450mW 1000bp Full Run: 1000mW WoL Enable(S3/S4/S5): 50mW WoL Disable(S3/S4/S5): 25mW
Power Management	ACPI compliant – multiple power modes Situation-sensitive features reduce power consumption Advanced link down power saving for reducing link down power consumption
Management Interface	Auto MDI/MDIX Crossover cable detection
IT Manageability	Wake-on-LAN from modern standby or sleep state (Magic Packet and Microsoft Wake-Up Frame); Wake-on-LAN from off (Magic Packet only) PXE 2.1 Remote Boot Statistics Gathering (SNMP MIB II, Ethernet-like MIB, Ethernet MIB (802.3x, clause 30)) Comprehensive diagnostic and configuration software suite Virtual Cable Doctor for Ethernet cable status
Security & Manageability	Intel® vPro™ support with appropriate Intel® chipset components

Intel® I225-LM 2.5 Gigabit Network Connection LOM (non-vPro)	
Connector	RJ-45
System Interface	PCI(Intel proprietary) + SMBus
Data rates supported	1. 10 Mbit/s operation (10BASE-T; IEEE 802.3i; IEEE 802.3 clauses 13-14) 2. 100 Mbit/s operation (100BASE-TX; IEEE 802.3u; IEEE 802.3 clauses 21-30) 3. 1000 Mbit/s operation (1000BASE-T; IEEE 802.3ab; IEEE 802.3 clauses 40) 4. 2.5 Gbit/s operation (2.5GBASE-T; IEEE 802.3bz Clause 126) 5. Auto-Negotiation (Automatic Speed Selection) Full Duplex Operation at all Speeds, Half Duplex operation at 10, 100 & 1000 Mbit/s
IEEE Compliance	IEEE 802.1p QoS (Quality of Service) Support IEEE 802.1q VLAN support IEEE 802.3x Flow Control (IEEE 802.3 clauses 31-32; configurable) IEEE 802.3az EEE (Energy Efficient Ethernet) IEEE 802.3i 10BASE-T IEEE 802.3u 100BASE-TX IEEE 802.3ab 1000BAE-T IEEE 802.3bz 2.5GBASE-T

Technical Specifications – Networking

Performance	TCP/IP/UDP Checksum Offload (configurable) Protocol Offload (ARP & NS) Large send offload and Giant send offload Receiving Side Scaling (Hash Mode Only) Jumbo Frame 9K
Power consumption	Cable Disconnection: 25mW 100Mbps Full Run: 450mW 1000bp Full Run: 1000mW WoL Enable(S3/S4/S5): 50mW WoL Disable(S3/S4/S5): 25mW
Power Management	ACPI compliant – multiple power modes Situation-sensitive features reduce power consumption Advanced link down power saving for reducing link down power consumption
Management Interface	Auto MDI/MDIX Crossover cable detection
IT Manageability	Wake-on-LAN from modern standby or sleep state (Magic Packet and Microsoft Wake-Up Frame); Wake-on-LAN from off (Magic Packet only) PXE 2.1 Remote Boot Statistics Gathering (SNMP MIB II, Ethernet-like MIB, Ethernet MIB (802.3x, clause 30)) Comprehensive diagnostic and configuration software suite Virtual Cable Doctor for Ethernet cable status
Security & Manageability	Intel® non-vPro™ support with appropriate Intel® chipset components

Technical Specifications – Networking

Realtek RTL8852BE 802.11ax 2x2 Wi-Fi® + BT5.3 Wireless Card (802.11ax 2x2, supporting gigabit data rate)¹	
Wireless LAN Standards	IEEE 802.11a IEEE 802.11b IEEE 802.11g IEEE 802.11n IEEE 802.11ac IEEE 802.11ax IEEE 802.11d IEEE 802.11e IEEE 802.11h IEEE 802.11i IEEE 802.11k IEEE 802.11r IEEE 802.11v
Interoperability	Wi-Fi® certified modules
Frequency Band	802.11b/g/n/ax • 2.402 – 2.482 GHz 802.11a/n/ac/ax • 4.9 – 4.95 GHz (Japan) • 5.15 – 5.25 GHz • 5.25 – 5.35 GHz • 5.47 – 5.725 GHz • 5.825 – 5.850 GHz
Data Rates	• 802.11b: 1, 2, 5.5, 11 Mbps • 802.11g: 6, 9, 12, 18, 24, 36, 48, 54 Mbps • 802.11a: 6, 9, 12, 18, 24, 36, 48, 54 Mbps • 802.11n: max 300Mbps • 802.11ac: max 866.7Mbps • 802.11ax: max 1201Mbps
Modulation	Direct Sequence Spread Spectrum BPSK, QPSK, CCK, 16-QAM, 64-QAM, 256-QAM, 1024QAM
Security²	• IEEE and Wi-Fi® certified 64 / 128 bit WEP encryption for a/b/g mode only • AES-CCMP: 128 bit in hardware • 802.1x authentication • WPA, WPA2: 802.1x. WPA-PSK, WPA2-PSK, TKIP, and AES. • WPA2 certification • WPA3 certification • IEEE 802.11i • WAPI
Network Architecture Models	Ad-hoc (Peer to Peer) Infrastructure (Access Point Required)
Roaming	IEEE 802.11 compliant roaming between access points
Output Power³	• 802.11b: +18.5dBm minimum • 802.11g: +17.5dBm minimum • 802.11a: +18.5dBm minimum • 802.11n HT20(2.4GHz): +15.5dBm minimum • 802.11n HT40(2.4GHz): +14.5dBm minimum • 802.11n HT20(5GHz): +15.5dBm minimum • 802.11n HT40(5GHz): +14.5dBm minimum • 802.11ac VHT80(5GHz): +11.5dBm minimum • 802.11ax HE40(2.4GHz): +10dBm minimum • 802.11ax HE80(5GHz): +10dBm minimum
Power Consumption	• Transmit mode: 2.5 W • Receive mode: 2 W

Technical Specifications – Networking

	<ul style="list-style-type: none"> • Idle mode (PSP): 180 mW (WLAN Associated) • Idle mode: 50 mW (WLAN unassociated) • Connected Standby/Modern Standby: 10mW • Radio disabled: 8 mW
Power Management	ACPI and PCI Express compliant power management 802.11 compliant power saving mode
Receiver Sensitivity⁴	802.11b, 1Mbps: -93.5dBm maximum 802.11b, 11Mbps: -84dBm maximum 802.11a/g, 6Mbps: -86dBm maximum 802.11a/g, 54Mbps: -72dBm maximum 802.11n, MCS07: -67dBm maximum 802.11n, MCS15: -64dBm maximum 802.11ac, MCS0: -84dBm maximum 802.11ac, MCS9: -59dBm maximum 802.11ax, MCS11(HE40): -57dBm maximum 802.11ax, MCS11(HE80): -54dBm maximum
Antenna type	High efficiency antenna with spatial diversity, mounted in the display enclosure Two embedded dual band 2.4/5 GHz antennas are provided to the card to support WLAN MIMO communications and Bluetooth communications
Form Factor	PCI-Express M.2 MiniCard
Dimensions	1. Type 2230: 2.3 x 22.0 x 30.0 mm 2. Type 1216: 1.67 x 12.0 x 16.0 mm
Weight	1. Type 2230: 2.8g 2. Type 126: 1.3g
Operating Voltage	3.3v +/- 9%
Temperature	Operating: 14° to 158° F (-10° to 70° C) Non-operating: -40° to 176° F (-40° to 80° C)
Humidity	Operating: 10% to 90% (non-condensing) Non-operating: 5% to 95% (non-condensing)
Altitude	Operating: 0 to 10,000 ft (3,048 m) Non-operating: 0 to 50,000 ft (15,240 m)
LED Activity	LED Amber – Radio OFF; LED OFF – Radio ON
HP Integrated Module with Bluetooth 4.0/4.1/4.2/5.0/5.1/5.2/5.3 Wireless Card Technology	
Bluetooth® Specification	4.0/4.1/4.2/5.0/5.1/5.2/5.3 Wireless Card Compliant
Frequency Band	2402 to 2480 MHz
Number of Available Channels	Legacy: 0~79 (1 MHz/CH) BLE: 0~39 (2 MHz/CH)
Data Rates and Throughput	Legacy: 3 Mbps data rate; throughput up to 2.17 Mbps BLE: 1 Mbps data rate; throughput up to 0.2 Mbps Legacy: Synchronous Connection Oriented links up to 3, 64 kbps, voice channels Legacy: Asynchronous Connection Less links 2178.1 kbps/177.1 kbps asymmetric (3-DH5) or 864 kbps symmetric (3-EV5)
Transmit Power	The Bluetooth component shall operate as a Class II Bluetooth device with a maximum transmit power of + 4 dBm for BR and EDR.
Power Consumption	Peak (Tx): 330 mW Peak (Rx): 230 mW Selective Suspend: 17 mW
Electrical Interface	Microsoft Windows Bluetooth Software
Bluetooth® Software Supported	Microsoft Windows ACPI, and USB Bus Support

Technical Specifications – Networking

Link Topology	
Power Management	FCC (47 CFR) Part 15C, Section 15.247 & 15.249
Certifications	<p>ETS 300 328, ETS 300 826</p> <p>Low Voltage Directive IEC950</p> <p>UL, CSA, and CE Mark Peak (Tx): 330 mW</p> <p>Peak (Rx): 230 mW</p> <p>Selective Suspend: 17 mW</p>
Power Management	Microsoft Windows Bluetooth Software
Certifications	
Bluetooth Profiles Supported	<p>BT4.1-ESR 5/6/7 Compliance</p> <p>LE Link Layer Ping</p> <p>LE Dual Mode</p> <p>LE Link Layer</p> <p>LE Low Duty Cycle Directed Advertising</p> <p>LE L2CAP Connection Oriented Channels</p> <p>Train Nudging & Interlaced Scan</p> <p>BT4.2 ESR08 Compliance</p> <p>LE Secure Connection- Basic/Full</p> <p>LE Privacy 1.2 –Link Layer Privacy</p> <p>LE Privacy 1.2 –Extended Scanner Filter Policies</p> <p>LE Data Packet Length Extension</p> <p>FAX Profile (FAX)</p> <p>Basic Imaging Profile (BIP)2</p> <p>Headset Profile (HSP)</p> <p>Hands Free Profile (HFP)</p> <p>Advanced Audio Distribution Profile (A2DP)</p> <p>BT5.1</p> <p>ESR9/10 Compliance</p> <p>LE Advertisement Extensions</p> <p>Channel Selection Algo</p> <p>Limited High Duty Cycle Non-Connectable Advertising</p> <p>2Mbps LE</p> <p>LE Long Range</p>

1. Wireless access point and Internet service required and sold separately. Availability of public wireless access points limited. Wi-Fi 6 (802.11ax) is backwards compatible with prior 802.11 specs. Wi-Fi 6 is designed to support gigabit data rate when transferring files between two devices connected to the same router. Requires a wireless router, sold separately, that supports 80MHz and higher channels. Wireless access point and Internet service required and sold separately. Availability of public wireless access points limited. Wi-Fi 6 (802.11ax) is backwards compatible with prior 802.11 specs
2. Check latest software/driver release for updates on supported security features.
3. The FCC has declared as of September 1, 2014 products that utilize passive scanning on channel 12/13 and are capable of transmitting must fully comply with requirements of 15.247 or otherwise disable those channels.
4. Receiver sensitivity is measured at a packet error rate of 8% for 802.11b (CKK modulation) and a packet error rate of 10% for 802.11a/g (OFDM modulation).

Technical Specifications – Networking and Communications

Intel AX211 Wi-Fi 6E +BT 5.3 Wireless Card M.2 160MHz CNVi WW WLAN¹	
Wireless LAN Standards	IEEE 802.11a IEEE 802.11b IEEE 802.11g IEEE 802.11n IEEE 802.11ac IEEE 802.11ax IEEE 802.11d IEEE 802.11e IEEE 802.11h IEEE 802.11i IEEE 802.11k IEEE 802.11r IEEE 802.11v
Interoperability	Wi-Fi6 certified
Frequency Band	802.11b/g/n/ax • 2.402 – 2.482 GHz 802.11a/n/ac/ax • 4.9 – 4.95 GHz (Japan) • 5.15 – 5.25 GHz • 5.25 – 5.35 GHz • 5.47 – 5.725 GHz • 5.825 – 5.850 GHz • 5.955 – 6.415 GHz • 6.435 – 6.515 GHz • 6.535 – 6.875 GHz • 6.895 – 7.115 GHz
Data Rates	• 802.11b: 1, 2, 5.5, 11 Mbps • 802.11g: 6, 9, 12, 18, 24, 36, 48, 54 Mbps • 802.11a: 6, 9, 12, 18, 24, 36, 48, 54 Mbps • 802.11n: max 300Mbps • 802.11ac: 1733Mbps • 802.11ax: max 2.4Gbps
Modulation	Direct Sequence Spread Spectrum OFDM, BPSK, QPSK, CCK, 16-QAM, 64-QAM, 256-QAM, 1024QAM
Security²	• IEEE and Wi-Fi [®] compliant 64 / 128 bit WEP encryption for a/b/g mode only • AES-CCMP: 128 bit in hardware • 802.1x authentication • WPA, WPA2: 802.1x. WPA-PSK, WPA2-PSK, TKIP, and AES. • WPA2 certification • WPA3 certification • IEEE 802.11i • WAPI
Network Architecture Models	Ad-hoc (Peer to Peer) Infrastructure (Access Point Required)
Roaming	IEEE 802.11 compliant roaming between access points
Output Power³	• 802.11b: +17dBm minimum • 802.11g: +16dBm minimum • 802.11a: +17dBm minimum • 802.11n HT20(2.4GHz): +14dBm minimum • 802.11n HT40(2.4GHz): +13dBm minimum • 802.11n HT20(5GHz): +14dBm minimum

Technical Specifications – Networking and Communications

	<ul style="list-style-type: none"> • 802.11n HT40(5GHz): +13dBm minimum • 802.11ac VHT80(5GHz): +10dBm minimum • 802.11ac VHT160(5GHz): +10dBm minimum • 802.11ax HE40(2.4GHz): +12dBm minimum • 802.11ax HE80(5GHz): +10dBm minimum • 802.11ax HE160(5GHz): +10dBm minimum
Power Consumption	<ul style="list-style-type: none"> • Transmit mode 2.0 W • Receive mode 1.6 W • Idle mode (PSP) 180 mW (WLAN Associated) • Idle mode 50 mW (WLAN unassociated) • Connected Standby 10mW • Radio disabled 8 mW
Power Management	ACPI and PCI Express compliant power management 802.11 compliant power saving mode
Receiver Sensitivity⁴	<ul style="list-style-type: none"> • 802.11b, 1Mbps: -93.5dBm maximum • 802.11b, 11Mbps: -84dBm maximum • 802.11a/g, 6Mbps: -86dBm maximum • 802.11a/g, 54Mbps: -72dBm maximum • 802.11n, MCS07: -67dBm maximum • 802.11n, MCS15: -64dBm maximum • 802.11ac, MCS0(VHT80): -84dBm maximum • 802.11ac, MCS9(VHT80): -59dBm maximum • 802.11ac, MCS9(VHT160): -58.5dBm maximum • 802.11ax, MCS11(HE40): -57dBm maximum • 802.11ax, MCS11(HE80): -54dBm maximum • 802.11ax, MCS11(HE160): -53.5dBm maximum
Antenna type	High efficiency antenna with spatial diversity, mounted in the display enclosure Two embedded dual band 2.4/5/6 GHz antennas are provided to the card to support WLAN MIMO communications and Bluetooth communications
Form Factor	PCI-Express M.2 MiniCard
Dimensions	1. Type 2230: 2.3 x 22.0 x 30.0 mm 2. Type 1216: 1.67 x 12.0 x 16.0 mm
Weight	1. Type 2230: 2.8g 2. Type 1216: 1.3g
Operating Voltage	3.3v +/- 9%
Temperature	Operating: 14° to 158° F (-10° to 70° C) Non-operating: -40° to 176° F (-40° to 80° C)
Humidity	Operating: 10% to 90% (non-condensing) Non-operating: 5% to 95% (non-condensing)
Altitude	Operating: 0 to 10,000 ft (3,048 m) Non-operating: 0 to 50,000 ft (15,240 m)
LED Activity	LED Amber – Radio OFF; LED OFF – Radio ON
HP Integrated Module with Bluetooth 4.0/4.1/4.2/5.0/5.1/5.2/5.3 Wireless Card Technology	
Bluetooth® Specification	4.0/4.1/4.2/5.0/5.1/5.2/5.3 Wireless Card Compliant
Frequency Band	2402 to 2480 MHz
Number of Available Channels	Legacy: 0~79 (1 MHz/CH) BLE: 0~39 (2 MHz/CH)
Data Rates and Throughput	Legacy: 3 Mbps data rate; throughput up to 2.17 Mbps BLE: 1 Mbps data rate; throughput up to 0.2 Mbps Legacy: Synchronous Connection Oriented links up to 3, 64 kbps, voice channels Legacy: Asynchronous Connection Less links 2178.1 kbps/177.1 kbps asymmetric (3-DH5) or 864 kbps symmetric (3-EV5)

Technical Specifications – Networking and Communications

Transmit Power	The Bluetooth component shall operate as a Class II Bluetooth device with a maximum transmit power of + 9.5 dBm for BR and EDR.
Power Consumption	Peak (Tx): 330 mW Peak (Rx): 230 mW Selective Suspend: 17 mW
Bluetooth® Software Supported Link Topology	Microsoft Windows Bluetooth Software
Power Management	Microsoft Windows ACPI, and USB Bus Support
Certifications	FCC (47 CFR) Part 15C, Section 15.247 & 15.249
Power Management Certifications	ETS 300 328, ETS 300 826 Low Voltage Directive IEC950 UL, CSA, and CE Mark
Bluetooth Profiles Supported	BT4.1-ESR 5/6/7 Compliance LE Link Layer Ping LE Dual Mode LE Link Layer LE Low Duty Cycle Directed Advertising LE L2CAP Connection Oriented Channels Train Nudging & Interlaced Scan BT4.2 ESR08 Compliance LE Secure Connection- Basic/Full LE Privacy 1.2 –Link Layer Privacy LE Privacy 1.2 –Extended Scanner Filter Policies LE Data Packet Length Extension FAX Profile (FAX) Basic Imaging Profile (BIP)2 Headset Profile (HSP) Hands Free Profile (HFP) Advanced Audio Distribution Profile (A2DP) BT5.2 ESR9/10 Compliance LE Advertisement Extensions Channel Selection Algo Limited High Duty Cycle Non-Connectable Advertising 2Mbps LE LE Long Range

1. Wi-Fi 6E requires a Wi-Fi 6E router, sold separately, to function in the 6GHz band. Availability of public wireless access points limited. Wi-Fi 6E is backwards compatible with prior 802.11 specs. And available in countries where Wi-Fi 6E is supported. Wi-Fi 6E is designed to support gigabit data rate when transferring files between two devices connected to the same router. Requires a wireless router, sold separately, that supports 80MHz and higher channels.
2. Check latest software/driver release for updates on supported security features.
3. The FCC has declared as of September 1, 2014 products that utilize passive scanning on channel 12/13 and are capable of transmitting must fully comply with requirements of 15.247 or otherwise disable those channels.
4. Receiver sensitivity is measured at a packet error rate of 8% for 802.11b (CKK modulation) and a packet error rate of 10% for 802.11a/g (OFDM modulation).
5. Usage of the 6GHz band relies on Windows 11 Operating System support.

Technical Specifications – Networking and Communications

Intel AX211 Wi-Fi 6E +BT 5.3 Wireless Card M.2 vPro 160MHz CNVi WW WLAN¹	
Wireless LAN Standards	IEEE 802.11a IEEE 802.11b IEEE 802.11g IEEE 802.11n IEEE 802.11ac IEEE 802.11ax IEEE 802.11d IEEE 802.11e IEEE 802.11h IEEE 802.11i IEEE 802.11k IEEE 802.11r IEEE 802.11v
Interoperability	Wi-Fi6 certified
Frequency Band	802.11b/g/n/ax • 2.402 – 2.482 GHz 802.11a/n/ac/ax • 4.9 – 4.95 GHz (Japan) • 5.15 – 5.25 GHz • 5.25 – 5.35 GHz • 5.47 – 5.725 GHz • 5.825 – 5.850 GHz • 5.955 – 6.415 GHz • 6.435 – 6.515 GHz • 6.535 – 6.875 GHz • 6.895 – 7.115 GHz
Data Rates	• 802.11b: 1, 2, 5.5, 11 Mbps • 802.11g: 6, 9, 12, 18, 24, 36, 48, 54 Mbps • 802.11a: 6, 9, 12, 18, 24, 36, 48, 54 Mbps • 802.11n: max 300Mbps • 802.11ac: 1733Mbps • 802.11ax: max 2.4Gbps
Modulation	Direct Sequence Spread Spectrum OFDM, BPSK, QPSK, CCK, 16-QAM, 64-QAM, 256-QAM, 1024QAM
Security²	• IEEE and Wi-Fi [®] compliant 64 / 128 bit WEP encryption for a/b/g mode only • AES-CCMP: 128 bit in hardware • 802.1x authentication • WPA, WPA2: 802.1x. WPA-PSK, WPA2-PSK, TKIP, and AES. • WPA2 certification • WPA3 certification • IEEE 802.11i • WAPI
Network Architecture Models	Ad-hoc (Peer to Peer) Infrastructure (Access Point Required)
Roaming	IEEE 802.11 compliant roaming between access points
Output Power³	• 802.11b: +17dBm minimum • 802.11g: +16dBm minimum • 802.11a: +17dBm minimum • 802.11n HT20(2.4GHz): +14dBm minimum • 802.11n HT40(2.4GHz): +13dBm minimum • 802.11n HT20(5GHz): +14dBm minimum

Technical Specifications – Networking and Communications

	<ul style="list-style-type: none"> • 802.11n HT40(5GHz): +13dBm minimum • 802.11ac VHT80(5GHz): +10dBm minimum • 802.11ac VHT160(5GHz): +10dBm minimum • 802.11ax HE40(2.4GHz): +12dBm minimum • 802.11ax HE80(5GHz): +10dBm minimum • 802.11ax HE160(5GHz): +10dBm minimum
Power Consumption	<ul style="list-style-type: none"> • Transmit mode 2.0 W • Receive mode 1.6 W • Idle mode (PSP) 180 mW (WLAN Associated) • Idle mode 50 mW (WLAN unassociated) • Connected Standby 10mW • Radio disabled 8 mW
Power Management	ACPI and PCI Express compliant power management 802.11 compliant power saving mode
Receiver Sensitivity⁴	<ul style="list-style-type: none"> • 802.11b, 1Mbps: -93.5dBm maximum • 802.11b, 11Mbps: -84dBm maximum • 802.11a/g, 6Mbps: -86dBm maximum • 802.11a/g, 54Mbps: -72dBm maximum • 802.11n, MCS07: -67dBm maximum • 802.11n, MCS15: -64dBm maximum • 802.11ac, MCS0(VHT80): -84dBm maximum • 802.11ac, MCS9(VHT80): -59dBm maximum • 802.11ac, MCS9(VHT160): -58.5dBm maximum • 802.11ax, MCS11(HE40): -57dBm maximum • 802.11ax, MCS11(HE80): -54dBm maximum • 802.11ax, MCS11(HE160): -53.5dBm maximum
Antenna type	High efficiency antenna with spatial diversity, mounted in the display enclosure Two embedded dual band 2.4/5/6 GHz antennas are provided to the card to support WLAN MIMO communications and Bluetooth communications
Form Factor	PCI-Express M.2 MiniCard
Dimensions	1. Type 2230: 2.3 x 22.0 x 30.0 mm 2. Type 1216: 1.67 x 12.0 x 16.0 mm
Weight	1. Type 2230: 2.8g 2. Type 1216: 1.3g
Operating Voltage	3.3v +/- 9%
Temperature	Operating: 14° to 158° F (-10° to 70° C) Non-operating: -40° to 176° F (-40° to 80° C)
Humidity	Operating: 10% to 90% (non-condensing) Non-operating: 5% to 95% (non-condensing)
Altitude	Operating: 0 to 10,000 ft (3,048 m) Non-operating: 0 to 50,000 ft (15,240 m)
LED Activity	LED Amber – Radio OFF; LED OFF – Radio ON
HP Integrated Module with Bluetooth 4.0/4.1/4.2/5.0/5.1/5.2/5.3 Wireless Card Technology	
Bluetooth® Specification	4.0/4.1/4.2/5.0/5.1/5.2/5.3 Wireless Card Compliant
Frequency Band	2402 to 2480 MHz
Number of Available Channels	Legacy: 0~79 (1 MHz/CH) BLE: 0~39 (2 MHz/CH)
Data Rates and Throughput	Legacy: 3 Mbps data rate; throughput up to 2.17 Mbps BLE: 1 Mbps data rate; throughput up to 0.2 Mbps Legacy: Synchronous Connection Oriented links up to 3, 64 kbps, voice channels Legacy: Asynchronous Connection Less links 2178.1 kbps/177.1 kbps asymmetric (3-DH5) or 864 kbps symmetric (3-EV5)

Technical Specifications – Networking and Communications

Transmit Power	The Bluetooth component shall operate as a Class II Bluetooth device with a maximum transmit power of + 9.5 dBm for BR and EDR.
Power Consumption	Peak (Tx): 330 mW Peak (Rx): 230 mW Selective Suspend: 17 mW
Bluetooth® Software Supported Link Topology	Microsoft Windows Bluetooth Software
Power Management	Microsoft Windows ACPI, and USB Bus Support
Certifications	FCC (47 CFR) Part 15C, Section 15.247 & 15.249
Power Management Certifications	ETS 300 328, ETS 300 826 Low Voltage Directive IEC950 UL, CSA, and CE Mark
Bluetooth Profiles Supported	BT4.1-ESR 5/6/7 Compliance LE Link Layer Ping LE Dual Mode LE Link Layer LE Low Duty Cycle Directed Advertising LE L2CAP Connection Oriented Channels Train Nudging & Interlaced Scan BT4.2 ESR08 Compliance LE Secure Connection- Basic/Full LE Privacy 1.2 –Link Layer Privacy LE Privacy 1.2 –Extended Scanner Filter Policies LE Data Packet Length Extension FAX Profile (FAX) Basic Imaging Profile (BIP)2 Headset Profile (HSP) Hands Free Profile (HFP) Advanced Audio Distribution Profile (A2DP) BT5.2 ESR9/10 Compliance LE Advertisement Extensions Channel Selection Algo Limited High Duty Cycle Non-Connectable Advertising 2Mbps LE LE Long Range

1. Wi-Fi 6E requires a Wi-Fi 6E router, sold separately, to function in the 6GHz band. Availability of public wireless access points limited. Wi-Fi 6E is backwards compatible with prior 802.11 specs. And available in countries where Wi-Fi 6E is supported. Wi-Fi 6E is designed to support gigabit data rate when transferring files between two devices connected to the same router. Requires a wireless router, sold separately, that supports 80MHz and higher channels.
2. Check latest software/driver release for updates on supported security features.
3. The FCC has declared as of September 1, 2014 products that utilize passive scanning on channel 12/13 and are capable of transmitting must fully comply with requirements of 15.247 or otherwise disable those channels.
4. Receiver sensitivity is measured at a packet error rate of 8% for 802.11b (CKK modulation) and a packet error rate of 10% for 802.11a/g (OFDM modulation).
5. Usage of the 6GHz band relies on Windows 11 Operating System support.

Technical Specifications – Networking and Communications

HP Flex 1GbE Fiber LC Single Port	
Connector	Fiber
Cabling	1 GbE over Category OM1 (or better) up to 100m
Controller	Microchip LAN7801
Data Rates Supported	100/1000 Mbps
Compliance	IEE 802.1q priority encoding/tagging (QoS, CoS) IEE 802.1q VLAN tagging IEE 802.3x flow control
Bus Architecture	USB
Power requirement	Requires 3.3V (Integrated regulators for code Vdc)
Boot ROM support	Yes
Network transfer mode	Full-duplex; Half duplex
Network transfer rate	100BASE-X (Half-duplex) 100Mbps 1000BASE-X (Half-duplex) 1000Mbps 1000BASE-X (Full-duplex) 2000Mbps
Operating temperature	32° to 95° F (0° to 35°C)
calvin	1.5 x 1.7 x 0.75 in (3.84 x 4.3 x 1.9 cm)
Operating System Driver Support	Windows 11 64-Bit Windows 10 64-Bit Linux®

Technical Specifications – Input/Output Devices

I/O DEVICES

HP Business Slim Standalone USB/PS2 Wired Keyboard		
Physical Characteristics	Keys	104, 105, 106, 107, 109 layout (depending upon country)
	Dimensions (LxWxH)	171.97 x 68.35 x 8.27 in (436.8± 1.5 x 137.6± 1.0 x 21.0± 1.0 cm)
	Weight	1.32 lb (0.6± 0.08 kg)
Electrical	Operating voltage	4.4-5.25VDC
	Power consumption	50-mA maximum (with 5 VDC power supplied and three LEDs ON)/
	System interface	USB or PS/2
	ESD	Contact Discharge: 2, 4,6,8KV Air Discharge: 2, 4, 8,10,12.5KV
	EMI - RFI	Conforms to FCC rules for a Class B computing device
Mechanical	Keycaps	Low-profile design
	Switch actuation	60±12.5g nominal peak force with tactile feedback
	Switch life	10 million keystrokes (Life tester)
	Switch type	Contamination-resistant switch membrane
	Key-leveling mechanisms	For all double-wide and greater-length keys
	Cable length	6 ft (1.8 m)
Environmental	Acoustics	43-dBA maximum sound pressure level
	Operating temperature	50° to 122° F (10° to 50° C)
	Non-operating temperature	Minus 30 degress to 60 degress Celsius
	Operating humidity	10% to 90% (non-condensing at ambient)
	Non-operating humidity	20% to 80% (non-condensing at ambient)
	Operating shock	40 g, six surfaces
	Non-operating shock	80 g, six surfaces
	Operating vibration	2-g peak acceleration
	Non-operating vibration	4-g peak acceleration
	Drop (out of box)	26 in (66 cm) on carpet, six-drop sequence
	Drop (in box)	30 in (76.2 cm) on concrete, 16-drop sequence
Approvals	UL, FCC, CE Mark, TUV GS, VCCI, BSMI, RCM, KCC	
Ergonomic compliance	ANSI HFS 100, ISO 9241-4, and TUVGS	

Technical Specifications – Input/Output Devices

HP USB Business Slim Wired SmartCard CCID Keyboard		
Physical Characteristics	Keys	104, 105, 109 layout (depending upon country)
	Dimensions (LxWxH)	17.34 x 5.68 x 0.78in (440.6 x 144.5 x 1.98 cm)
	Weight	1.32 lb (598g)
Electrical	Operating voltage	5 VDC, +/-5%
	Power consumption	100mA (All LED on)
	System interface	USB Type A plug connector
	ESD	Contact Discharge: 8 KV Air Discharge: 12.5 KV
	EMI - RFI	Conforms to FCC rules for a Class B computing device
Mechanical	Keycaps	Low-profile design
	Switch actuation	60±10g nominal peak force with tactile feedback
	Switch life	10 million keystrokes (Life tester)
	Switch type	Contamination-resistant switch membrane
	Key-leveling mechanisms	For all double-wide and greater-length keys
	Cable length	6 ft (1.8 m)
Environmental	Acoustics	43-dBA maximum sound pressure level
	Operating temperature	50° to 122° F (10° to 50° C)
	Non-operating temperature	-22° to 140° F (-30° to 60° C)
	Operating humidity	10% to 90% (non-condensing at ambient)
	Non-operating humidity	20% to 80% (non-condensing at ambient)
	Operating shock	40 g, six surfaces
	Non-operating shock	80 g, six surfaces
	Operating vibration	2-g peak acceleration
	Non-operating vibration	4-g peak acceleration
	Drop (out of box)	26 in (66 cm) on carpet, six-drop sequence
	Drop (in box)	30 in (76.2 cm) on concrete, 16-drop sequence
Approvals	CE Marking, TUV, EAC, FCC, cULus/CSAus, ICES, RCM, VCCI, KCC, BSMI	
Ergonomic compliance	ISO 9241-4, TUVGS	

Technical Specifications – Input/Output Devices

HP 125 (AntiMicrobial) Wired Keyboard (China only)		
Physical Characteristics	Keys	104/105/107/109layout (depending upon country)
	Dimensions (LxWxH)	436 x 138 x24.7 mm
	Weight	471g
Electrical	Operating voltage	5V +- 5%
	Power consumption	50mA
	System interface	USB Type A plug connector
	ESD	Contact Discharge: 8 KV Air Discharge: 12.5 KV
	EMI - RFI	Conforms to FCC rules for a Class B computing device
Mechanical	Keycaps	Low-profile design
	Switch actuation	55±10g nominal peak force with tactile feedback
	Switch life	10 million keystrokes (Life tester)
	Switch type	Contamination-resistant switch membrane
	Key-leveling mechanisms	For all double-wide and greater-length keys
	Cable length	1.8 m
Environmental	Acoustics	43-dBA maximum sound pressure level
	Operating temperature	50° to 122° F (10° to 50° C)
	Non-operating temperature	-4° to 149° F (-20° to 65° C)
	Operating humidity	10% to 95% (non-condensing at ambient)
	Non-operating humidity	0% to 95% (non-condensing at ambient)
	Operating shock	40 g, six surfaces
	Non-operating shock	80 g, six surfaces
	Operating vibration	2-g peak acceleration
	Non-operating vibration	4-g peak acceleration
	Drop (out of box)	26 in (66 cm) on carpet, six-drop sequence
	Drop (in box)	30 in (76.2 cm) on concrete, 16-drop sequence
Approvals	UL, cUL, FCC, CE, TUV GS, VCCI, BSMI, RCM, KCC, USB-IF, WHQL, EN/IEC 60601-1	
Ergonomic compliance	ANSI HFS 100, ISO 9241-4, and TUVGS	

Technical Specifications – Input/Output Devices

HP 655 wireless Keyboard		
Physical Characteristics	Keys	104, 105, 107,109 layouts
	Dimensions (LxWxH)	16.86 x 4.55 x 0.71 in (428.22 x 115.47 x 18.06 mm)
	Weight	0.96 lb (435g)
Electrical	Operating voltage	3 VDC, +/-5%
	Power consumption	20 mA Max (All LED on)
	System interface	2.4GHz Wireless
	ESD	Contact Discharge: 8 KV Air Discharge: 15 KV
	EMI - RFI	Conforms to FCC rules for a Class B computing device
Mechanical	Keycaps	Plunger, 2.0 mm key travel
	Key actuation	60±10g nominal peak force with tactile feedback
	Key life	10 million keystrokes (Life tester)
	Key structure type	Rubber dome & Membrane
	Key-leveling mechanisms	For all double-wide and greater-length keys
Environmental	Operating temperature	50° to 122° F (10° to 50° C)
	Non-operating temperature	-22° to 140° F (-30° to 60° C)
	Operating humidity	10% to 90% (non-condensing at ambient)
	Non-operating humidity	20% to 80% (non-condensing at ambient)
	Operating shock	40 g, six surfaces
	Non-operating shock	80 g, six surfaces
	Operating vibration	2-g peak acceleration
	Non-operating vibration	4-g peak acceleration
	Drop (out of box)	26 in (66 cm) on carpet, six-drop sequence
	Drop (in box)	30 in (76.2 cm) on concrete, 16-drop sequence
Approvals	CB, CE, FCC, cULus, ICES, IC, I TRC, TRA, CASA, UA, EAC, CNC, ANATEL, NOM-NYCE SCT, IFETEL, MPTC, RCM, BIS, PosTel, VCCI, TELEC, KC, MCMC, IDA, BSMI, NCC, DWLF&M, TP-BY, MOC	
Ergonomic compliance	TUVGS	

Technical Specifications – Input/Output Devices

HP Wired Desktop 320K Keyboard				
Physical Characteristics	Keys	104, 105, 107, 109 layouts		
	Dimensions(LxWxH)	18.86*4.55*0.66 in (426.2 x 110.9 x 16.7 mm)		
	Weight	1.00 lb(452g)		
Electrical	Operating voltage	5 VDC, +/-5%		
	Power consumption	50 mA Max (All LED on)		
	System interface	USB Port		
	ESD	Contact Discharge: 8 KV Air Discharge: 15 KV (Class B)		
	EMI - RFI	European Standard EN 55022: 2006+A1: 2007, Class B. FCC/CFR 47: Part 15 Class B		
Mechanical	Keycaps	2.0mm +/-0.2mm at 120gf Key travel		
Environmental	Operating temperature	10° C to 90° C		
	Non-operating temperature	-30° C to 95° C		
	Operating humidity	N/A		
	Non-operating humidity	10% to 90% (non-condensing at ambient)		
	Operating shock	N/A		
	Non-operating shock	i. Half-Sine Shock – End-Use Handling, Non-Operational Sample size: 5pcs. Condition: Sample power off. Axis: X, Y, Z axis (all 6 faces) – sample normal mode of operation. Number of shocks: 1 shock/face. Pulse duration: < 3 ms Velocity change: 50lps (inch-per-second)- 65lps desired.		
		ii. Trapezoidal Shock- Transportation Environment, Non-Operational Sample size: 5pcs. Condition: Sample power off. Orientation: All six faces: Front, Rear, Left, Right, Bottom, and Top. Configuration: As intended for shipment Number of shocks: 1 shock/face. Minimum faired acceleration: 30G's. Test also at 40 and 50G's to find margin. Velocity change: 266lps (inch-per-second) for product mass (m) 20<m<40lb		
	Operating vibration	Frequency (Hz)	Slope (dB/oct)	PSD (g²/Hz)
		5-350	0	0.0001
		350-500	-6	-
500		-	0.00005	
(~0.21G _{rms}) Total Test time: 10 minutes				
Non-operating vibration	Frequency (Hz)	Slope (dB/oct)	PSD (g²/Hz)	
	5.100	0	0.015	
	100-137	-6	-	
	137-350	0	0.008	
	350-500	-6	-	

Technical Specifications – Input/Output Devices

		500	-	0.0039
	Drop (out of box)	76cm on carpet, six-drop sequence		
	Drop (in box)	10 times drop including 6 faces, one corner and 3 edges on rigid surface. Drop Height: 91cm		
Approvals	CB, CE, FCC, ICES, EAC, NOM-NYCE SCT, RCM, BIS, VCCI, KC, BSMI			
Ergonomic compliance	TUVGS			

HP PS/2 Mouse		
Dimensions (HxLxW)	4.53 x 2.48 x 1.46 in (115.2x 63 x 37 mm)	
Weight	0.22lb (101.6g)	
Environmental	Operating temperature	41° to 122° F (5° to 50° C)
	Non-operating temperature	(-4° to 140° F)(-20° to 60° C)
	Operating humidity	10% to 85% (non-condensing at ambient)
	Non-operating humidity	5% to 95% (non-condensing at ambient)
	Operating shock	40 g, six surfaces
	Non-operating shock	80 g, six surfaces
	Operating vibration	2-g peak acceleration
	Non-operating vibration	4-g peak acceleration
Electrical	Tracking speed	30 inch/sec (max)
	Tracking acceleration	8G(max), 1G=9.8m/s ²
	System interface	PS/2
Mechanical	Switch actuation	60±15g nominal peak force with tactile feedback
	Switch life	3 million keystrokes (Life tester)
	Switch type	Contamination-resistant switch membrane
	Key-leveling mechanisms	For all double-wide and greater-length keys
	Cable length	6 ft (1.8 m)
	Color	Jack Black
Regulatory approvals	Compliant	UL, FCC, CE Mark, TUV GS, VCCI, BSMI, RCM, KCC

Technical Specifications – Input/Output Devices

HP Wired Desktop 320M Mouse				
Physical Characteristics	Keys	Left/right key		
	Dimensions(LxWxH)	4.09 x2.50 x 1.40 in (103.8x 63.4 x 35.5 mm)		
	Weight	0.16 lb(72g)		
Electrical	Operating voltage	5 VDC, +/-0.25V		
	Power consumption	100 mA Max		
	System interface	USB Port		
	ESD	Contact Discharge: 8 KV Air Discharge: 15 KV (Class B)		
	EMI - RFI	European Standard EN 55022: 2006+A1: 2007, Class B. FCC/CFR 47: Part 15 Class B		
Mechanical	Keycaps	0.3mm key travel		
	Key actuation	75±20g		
	Key life	1million cycles		
	Key structure type	Tact Switch		
	Key-leveling mechanisms	N/A		
Environmental	Operating temperature	10° to 90° C		
	Non-operating temperature	-30° C to 95° C		
	Operating humidity	N/A		
	Non-operating humidity	10% to 90% (non-condensing at ambient)		
	Operating shock	N/A		
	Non-operating shock	i. Half-Sine Shock – End-Use Handling, Non-Operational Sample size: 5pcs. Condition: Sample power off. Axis: X, Y, Z axis (all 6 faces) – sample normal mode of operation. Number of shocks: 1 shock/face. Pulse duration: < 3 ms Velocity change: 50lps (inch-per-second)- 65lps desired.		
		ii. Trapezoidal Shock- Transportation Environment, Non-Operational Sample size: 5pcs. Condition: Sample power off. Orientation: All six faces: Front, Rear, Left, Right, Bottom, and Top. Configuration: As intended for shipment Number of shocks: 1 shock/face. Minimum faired acceleration: 30G's. Test also at 40 and 50G's to find margin. Velocity change: 266lps (inch-per-second) for product mass (m) 20<m<40lb		
	Operating vibration	Frequency (Hz)	Slope (dB/oct)	PSD (g²/Hz)
		5-350	0	0.0001
		350-500	-6	-
500		-	0.00005	
(~0.21G _{rms})				
Total Test time: 10 minutes				

Technical Specifications – Input/Output Devices

		Frequency (Hz)	Slope (dB/oct)	PSD (g ² /Hz)
	Non-operating vibration	5.100	0	0.015
		100-137	-6	-
		137-350	0	0.008
		350-500	-6	-
		500	-	0.0039
	Drop (out of box)	76cm on carpet, six-drop sequence		
	Drop (in box)	N/A		
Approvals	CB, CE, FCC, cULus, ICES, EAC, NOM-NYCE SCT, RCM, VCCI, KC, BSMI			
Ergonomic compliance	TUVGS			

HP 655 wireless Mouse		
Dimensions (HxLxW)	4.74 x 2.75 x 1.63 in (120.29 x 69.97 x 41.39 mm)	
Weight	0.194lb (88g)	
Environmental	Operating temperature	50° to 122° F (10° to 50° C)
	Non-operating temperature	-22° to 140° F (-30° to 60° C)
	Operating humidity	10% to 90% (non-condensing at ambient)
	Non-operating humidity	20% to 80% (non-condensing at ambient)
	Operating shock	40 g, six surfaces
	Non-operating shock	80 g, six surfaces
	Operating vibration	2-g peak acceleration
	Non-operating vibration	4-g peak acceleration
Electrical	Operating voltage	3 VDC, +/-5%
	Power consumption (typical)	10 mA Max
	Resolution	1,200 DPI (Default)
	Sensor	Pixart PAW3222DB-TJDS
	Tracking speed	10G(max), 1G=9.8m/s ²
	Tracking acceleration	2.4GHz Wireless
Mechanical	Color	Jack Black
Regulatory approvals	Compliant	CB, CE, FCC, cULus, ICES, IC, TRC, TRA, ICASA, UA, EAC, CNC, ANATEL, NOM-NYCE SCT, IFETEL, MPTC, RCM, PosTel, VCCI, TELEC, KC, MCMC, IDA, BSMI, NCC, DWLF&M, TP-BY, MOC
Ergonomic compliance	Compliant	TUVGS

Technical Specifications – Input/Output Devices

HP USB 125 (Antimicrobial)/128 Laser Mouse (China only)		
Dimensions (HxLxW)	112 x 63 x 36.2 mm (LxWxH)	
Weight	85 g	
Environmental	Operating temperature	50° to 122° F (10° to 50° C)
	Non-operating temperature	-22° to 140° F (-30° to 60° C)
	Operating humidity	10% to 90% (non-condensing at ambient)
	Non-operating humidity	20% to 80% (non-condensing at ambient)
	Operating shock	40 g, six surfaces
	Non-operating shock	80 g, six surfaces
	Operating vibration	2-g peak acceleration
	Non-operating vibration	4-g peak acceleration
Electrical	Operating voltage	5 VDC, +/-5%
	Power consumption (typical)	100mA
	Resolution	1,200 DPI
	Sensor	Optical/ Laser USB mouse sensor
	Tracking speed	30 inch/sec (max)
	Tracking acceleration	8G(max), 1G=9.8m/s ²
Mechanical	Connector	USB
	Cable length	6 ft (1.8 m)
	Color	Jack Black
Regulatory approvals	Compliant	UL, FCC, CE Mark, TUV GS, VCCI, BSMI, RCM, KCC, EAC

Technical Specifications – Audio/Multimedia

AUDIO/MULTIMEDIA

HP Elite Mini 800 G9 Desktop PC

Type	Integrated
HD Stereo Codec	Realtek ALC3252
Audio I/O Ports	combo audio jack with CTIA and OMTP headset support
Internal Speaker Amplifier	2W class D mono amplifier for the internal speaker only. External speakers must be powered
Multi-streaming Capable	Playback multi-streaming can be enabled in the audio control panel to allow independent audio streams to be sent to/from the front and rear jacks or integrated speaker.
Sampling	Independent sampling rates for DAC's and ADC's; supports resolutions from 16 to 24-bit; 44.1 kHz to 192 kHz for DAC and 44.1 kHz to 192 kHz for ADC
Wavetable Syntheses	Yes - Uses OS soft wavetable
Analog Audio	Yes
# of Channels on Line-Out	Stereo (Left & Right channels)
Internal Speaker	Yes

HP Elite SFF 800 G9 Desktop PC

Type	Integrated
HD Stereo Codec	Realtek ALC 3252
Audio I/O Ports	Front: Headset connector supports a CTIA and OMTP style headset and is re-taskable as a Line-in, Line-out, Microphone-in or Headphone-out port Rear: Line-out, Line-in*, 3.5mm and support stereo and re-tasking
Internal Speaker Amplifier	2W class D mono amplifier for the internal speaker only. External speakers must be powered
Multi-streaming Capable	Playback multi-streaming can be enabled in the audio control panel to allow independent audio streams to be sent to/from the front and rear jacks or integrated speaker.
Sampling	Independent sampling rates for DAC's and ADC's; supports resolutions from 16 to 24-bit; 44.1 kHz to 192 kHz for DAC and 44.1 kHz to 96 kHz for ADC
Wavetable Syntheses	Yes - Uses OS soft wavetable
Analog Audio	Yes
# of Channels on Line-Out	Stereo (Left & Right channels)
Internal Speaker	Yes

***NOTE:** System default is line-out. Line-in / Line-out can be adjusted through the audio setting

Technical Specifications – Audio/Multimedia

HP Elite Tower 800/880 G9 Desktop PC

Type	Integrated
HD Stereo Codec	Realtek ALC 3252
Audio I/O Ports	Front: Headset connector supports a CTIA and OMTP style headset and is re-taskable as a Line-in, Line-out, Microphone-in or Headphone-out port Rear: Line-out, Line-in*, 3.5mm and support stereo and retasking
Internal Speaker Amplifier	2W class D mono amplifier for the internal speaker only. External speakers must be powered
Multi-streaming Capable	Playback multi-streaming can be enabled in the audio control panel to allow independent audio streams to be sent to/from the front and rear jacks or integrated speaker.
Sampling	Independent sampling rates for DAC's and ADC's; supports resolutions from 16 to 24-bit; 44.1 kHz to 192 kHz for DAC and 44.1 kHz to 192 kHz for ADC
Wavetable Syntheses	Yes - Uses OS soft wavetable
Analog Audio	Yes
# of Channels on Line-Out	Stereo (Left & Right channels)

***NOTE:** System default is line-out. Line-in / Line-out can be adjusted through the audio setting

HP EliteOne 840 23.8 in & 870 27 in G9 All-in-One Desktop PC's

Bang & Olufsen Audio

Type	Integrated
HD Stereo Codec	Realtek ALC3274
Audio I/O Ports	Side headset connector supports a CTIA/OMTP style headset and is re-taskable as a Line-in, Line-out, Microphone-in or Headphone-out port All ports are 3.5mm and support stereo
Internal Speaker Amplifier	5W per channel class D stereo amplifier for the internal speakers only
Multi-streaming Capable	Playback multi-streaming can be enabled in the audio control panel to allow independent audio streams to be sent to/from the front and rear jacks or integrated speakers.
Sampling	Independent sampling rates for DAC's and ADC's; supports resolutions from 16 to 24-bit; 44.1 kHz to 192 kHz for DAC and 44.1 kHz to 192 kHz for ADC
Wavetable Syntheses	Yes - Uses OS soft wavetable
Analog Audio	Yes
# of Channels on Line-Out	Stereo (Left & Right channels)
Internal Speaker	Yes - Stereo

Technical Specifications – Integrated Webcam and Microphone

INTEGRATED WEBCAM AND MICROPHONE

Integrated Webcam and Microphone

Optional integrated 5 MP Swivel Webcam with integrated dual array digital microphones; 88° FOV

Optional integrated 5 MP Swivel Webcam + IR Sensor + Color Light Sensor with integrated dual array digital microphones (Supports Windows Hello); 80° FOV

Optional integrated 16MP binned Swivel Webcam + IR Sensor + Color Light Sensor + Time of Flight Sensor (TOF) (Supports Windows Hello); 80° FOV

NOTE: All HP devices which carry the Bang & Olufsen brand are custom-tuned with Bang & Olufsen's acoustical engineers for precise sound experience in business use.

INTEGRATED FINGERPRINT SENSOR

Sensor type: Touch

Fingerprint matching: Performed on device

Anti-Spoofing: Yes

Windows Hello Support: Yes

Encryption: On sensor

FIPS Compliant: No

Technical Specifications – Power

POWER

HP Elite Mini 800 G9 Desktop PC (35W)

Unit Environment and Operating Conditions

Temperature Range	Operating: 5°C ~35°C Non-Operating: -40°C ~66°C
Relative Humidity	Operating 5% to 90% relative humidity at max inlet temperature Non-Operating 5% to 90% relative humidity at max inlet temperature
Maximum Altitude (unpressurized)	Operating: 5000m Non-operating: 50,000 ft. (15240 m)

HP Elite Mini 800 G9 Desktop PC (65W)

Unit Environment and Operating Conditions

Temperature Range	Operating: 5°C ~35°C Non-Operating: -40°C ~66°C
Relative Humidity	Operating 5% to 90% relative humidity at max inlet temperature Non-Operating 5% to 90% relative humidity at max inlet temperature
Maximum Altitude (unpressurized)	Operating: 5000m Non-operating: 50,000 ft. (15240 m)

HP Elite SFF 800 G9 Desktop PC

Unit Environment and Operating Conditions

Temperature Range	Operating: 5°C ~35°C Non-Operating: -40°C ~66°C
Relative Humidity	Operating 5% to 90% relative humidity at max inlet temperature Non-Operating 5% to 90% relative humidity at max inlet temperature
Maximum Altitude (unpressurized)	Operating: 5000m Non-operating: 50,000 ft. (15240 m)

HP Elite Tower 800 G9 Desktop PC

Unit Environment and Operating Conditions

Temperature Range	Operating: 5°C ~35°C Non-Operating: -40°C ~66°C
Relative Humidity	Operating 5% to 90% relative humidity at max inlet temperature Non-Operating 5% to 90% relative humidity at max inlet temperature
Maximum Altitude (unpressurized)	Operating: 5000m Non-operating: 50,000 ft. (15240 m)

HP EliteOne 840 23.8 in & 870 27 in G9 All-in-One Desktop PC

Unit Environment and Operating Conditions

Temperature Range	Operating: 5°C ~45°C Non-Operating: -40°C ~66°C
Relative Humidity	Operating 5% to 90% relative humidity at max inlet temperature Non-Operating 5% to 90% relative humidity at max inlet temperature
Maximum Altitude (unpressurized)	Operating: 5000m Non-operating: 50,000 ft. (15240 m)

Technical Specifications – Power

	Mini	SFF	TWR	AiO
External Power Supplies¹	90W EPS, active PFC, 88% average efficiency at 115V & 89% at 230Vac 120W EPS, active PFC, 88% average efficiency at 115V & 89% at 230Vac 150W EPS, active PFC, 88% efficiency in 115Vac / 89% efficiency in 230Vac 180W EPS, active PFC, 88% average efficiency at 115V & 89% at 230Vac 200W EPS, active PFC, 88% average efficiency at 115V & 89% at 230Vac	N/A	N/A	N/A
80 PLUS Platinum	N/A	260W active PFC / 80 PLUS Platinum 400W active PFC / 80 PLUS Platinum Platinum 90/92/89% efficient at 20/50/100% load (115V) 91/93/90% efficient at 20/50/100% load (230V)	550W active PFC / 80 PLUS Platinum 260W active PFC / 80 PLUS Platinum 400W active PFC / 80 PLUS Platinum 90/92/89% efficient at 20/50/100% load (115V) 91/93/90% efficient at 20/50/100% load (230V)	240W active PFC / 80 PLUS Platinum 280W active PFC / 80 PLUS Platinum 90/92/89% efficient at 20/50/100% load (115V) 91/93/90% efficient at 20/50/100% load (230V)
Operating Voltage Range	90Vac~264Vac	90Vac~264Vac	90Vac~264Vac	90Vac~264Vac
Rated Voltage Range	100Vac~240Vac	100Vac~240Vac	100Vac~240Vac	100Vac~240Vac
Rated Line Frequency	50HZ~60HZ	50HZ~60HZ	50HZ~60HZ	50HZ~60HZ
Operating Line Frequency	47HZ~63HZ	47HZ~63HZ	47HZ~63HZ	47HZ~63HZ
Rated Input Current with Energy Efficient* Power Supply	90W ≤ 1.7A 120W ≤ 1.7A 150W ≤ 2.5A 180W ≤ 2.5A 200W ≤ 3.0A	260W Platinum ≤ 3.1A 400W Platinum ≤ 5.2A	260W Platinum ≤ 3.1A 400W Platinum ≤ 5.2A 550W Platinum ≤ 6.6A	240W ≤ 3.0A 280W ≤ 3.2A
DC Output	+19.5V	+12V	+12V	+20V

1. External power supplies, power cords, cables and peripherals are not low halogen. Service parts obtained after purchase may not be low halogen.

Technical Specifications – Power

	Mini	SFF	TWR	AiO
Current Leakage (NFPA 99: 2012)	Less than 500 microamps of leakage current at 264 Vac with the ground wire disconnected, as required for Non-patient Electrical Appliances and Equipment used in a patient care facility or that contact patients in normal use. Per section 10.3.5.1. Less than 100 microamps of leakage current at 264 Vac with the ground wire intact with normal polarity, as required for Non-patient Electrical Appliances and Equipment used in a patient care facility or that contact patients in normal use. Per section 10.3.5.1.	Less than 500 microamps of leakage current at 264 Vac with the ground wire disconnected, as required for Non-patient Electrical Appliances and Equipment used in a patient care facility or that contact patients in normal use. Per section 10.3.5.1. Less than 100 microamps of leakage current at 264 Vac with the ground wire intact with normal polarity, as required for Non-patient Electrical Appliances and Equipment used in a patient care facility or that contact patients in normal use. Per section 10.3.5.1.	Less than 500 microamps of leakage current at 264 Vac with the ground wire disconnected, as required for Non-patient Electrical Appliances and Equipment used in a patient care facility or that contact patients in normal use. Per section 10.3.5.1. Less than 100 microamps of leakage current at 264 Vac with the ground wire intact with normal polarity, as required for Non-patient Electrical Appliances and Equipment used in a patient care facility or that contact patients in normal use. Per section 10.3.5.1.	Less than 500 microamps of leakage current at 264 Vac with the ground wire disconnected, as required for Non-patient Electrical Appliances and Equipment used in a patient care facility or that contact patients in normal use. Per section 10.3.5.1. Less than 100 microamps of leakage current at 264 Vac with the ground wire intact with normal polarity, as required for Non-patient Electrical Appliances and Equipment used in a patient care facility or that contact patients in normal use. Per section 10.3.5.1.
Power Supply Fan	N/A	70 mm variable speed	70 mm variable speed	N/A
Power cord length	6.0 ft. (1.83 m) ^{1,2}	6.0 ft. (1.83 m) ²	6.0 ft. (1.83 m) ²	6.0 ft. (1.83 m) ^{1,2}
External Power Adapter	External power	Internal power	Internal power supply	Internal power supply
Dimensions	90W: 126 x 50 x 30mm 120W: 138 x 68.5 x 25.4 mm 150W: 148 x 75.5 x 25.4 mm 180W: 165.5 x 79 x 25.4 mm 200W: 165.5 x 79 x 25.4 mm	165 x 95 x 73 mm	165 x 95 x 73 mm	90 x 130 x 26 mm
Total Cord Length	6.0 ft. (1.83 m)	6.0 ft. (1.83 m)	6.0 ft. (1.83 m)	6.0 ft. (1.83 m)

1. Power cord length will be varied from different type of cords start from 1.8m.

2. The length of India power cord is 2.0m

Technical Specifications – Power

AC Adaptor		Eris+ 200W
Dimensions		6.5 x 3.11 x 1.0 in (16.5 x 7.9 x 2.54 cm)
Weight		530 g (+/- 10 g)
Input	Input Efficiency	Average Efficiency of 25%, 50%, 75%, 100% load condition with 115 Vac / 230 Vac Spec: 88% at 115 Vac and 89 % at 230 Vac
	Input Frequency Range	47-63 Hz
	Input AC current	Max. 3.0 A at 90 Vac
Output	Output Power	200W
	DC Output	19.5V
	Hold-up Time	5 ms at 115 Vac input
	Output Over Current Protection	< 21.0A
Leakage Current		Shall not exceed 50uA when tested at 250 Vac/50 Hz in a normal operating condition
AC connector (Ac Inlet)		C14
DC Plug		7.4 mm Barrel Type
Environmental Design	Operating Temperature	32°F to 95°F (0° to 35°C)
	Non-operating (storage) Temperature	-4°F to 185°F (-20° to 85°C)
	Altitude	0 to 16,400 ft (0 to 5000 m)
	Humidity	20% to 95%
	Storage Humidity	10% to 95%
EMI and Safety Certifications		*CE Mark - full compliance with LVD and EMC directives * Worldwide safety standards - IEC60950-1 and/or IEC62368-1 2&3 ed, EN60950-1 and/or EN62368-1, UL62368-1 , Class I, SELV; Agency approvals - cULus, CCC, BIS, PSE(J62368), EN55032 Class B, FCC Class B, CISPR32 Class B, CCC, NOM-001 NYCE, EAEU, Australia MTBF - over 100,000 hours at 35°C ambient condition

HP EliteOne 840 23.8 in & 870 27 in G9 All-in-One Desktop PC

Wireless Charger General Description

Operating Voltage	12~13V (DC) After Qi certificate, this range are optimum voltage.
Nominal Input voltage	12.6V (DC) (The optimum working voltage)
Input Current	Typ. 1.5A (2A max.)
Max Input Power	<24W
Standby Current (No load)	Average current=12.5mA Max. (Q/Ping period= 500ms Avg. Power 150mW Max.)
Over Voltage Protection	15V Max.
Over Current Protection	2.1A± 10%

Technical Specifications – Power

The power supply shall comply with harmonic input current requirements as detailed in EN61000-3-2 and JEIDA MITI standards. The harmonic input current requirements must be met under the following operating conditions:

Load Requirements: 50% and 100%

Input Voltage: 230Vac/50Hz.

For active power factor correction the power factor at 50% & 100% loads shall be greater than 0.9 over the entire nominal input voltage range (100-127VAC and 200-240VAC).

Condition	Standard Efficiency	82/85/82%	85/88/85%	87/90/87%	90/92/89%	Input Voltage
10% of Rated Load	-	75%	81%	84%	86%	115Vac/60HZ
20% of Rated Load	-	82%	85%	87%	90%	115Vac/60HZ
50% of Rated Load	-	85%	88%	90%	92%	115Vac/60HZ
	PF>0.9	PF>0.9	PF>0.9	PF>0.9	PF>0.95	
100% of Rated Load	70%	82%	85%	87%	89%	115Vac/60HZ
	PF>0.9	PF>0.9	PF>0.9	PF>0.9	PF>0.9	230Vac/50HZ

Technical Specifications – Weights and Dimensions

WEIGHTS & DIMENSIONS

	<u>Mini</u>	<u>SFF</u>	<u>TWR</u>	<u>AiO</u>
Chassis (WxDxH)	6.97 x 6.89 x 1.35 in 177 x 175 x 34 mm	12.12 x 13.3 x 3.94 in 308x 338 x 100 mm	6.1 x 12.13 x 13.27 in 155 x 308 x 337 mm	See table below.
System Volume	63.4 cu in 1.05 L	635.11 cu in 10.4 L	981.9 cu in 16.1 L	See table below.
System Weight	3.13 lb 1.42 kg	11.11 lb 5.04 kg	13.56 lb 6.15 kg	See table below.
Max Supported Weight (desktop orientation)	0 lb/kg	77 lb 35 kg	77 lb 35 kg	See table below.
Stand Dimensions	160 x 117 x 18.5 mm	151.8 x 200 x 37.2mm	N/A	See table below.
Packaging (WxDxH)	19.6 x 5.2 x 9.3 in 498 x132 x 235 mm	15.71 x 19.65 x 9.06 in 399 x 499 x 230 mm MPP: 15.71 x 19.65 x 9.06 in (399 x 499 x 230 mm)	15.75 x 19.65 x 11.30 in (400 x 499 x 287 mm) MPP: 15.75 x 19.65 x 11.30 in (400 x 499 x 287 mm)	See table below.
Shipping Weight	2.95 kg 6.49 lb	17.0 lb (7.72 kg) MPP: 17.44 lb (7.92 kg)	19.54 lb (8.87 kg) MPP: 20.35 lb (9.24kg)	See table below.
Multipack Packaging (10 units)	20.28 x16.54 x 25 in 515 x 420 x 636 mm	8 units per pack 32 units per pallet 1200 x 1000 x 1317 mm (include the pallet)	5-units per pack 20 per pallet 1200 x 1000 x 1310 mm (including pallet)	
Palletization Profile	10-units per layer 10 layers max 100 units per pallet 46.3 x 39.2 x 57.7 in, 1175 x 996 x 2125 mm (including pallet)	6 units per layer 10 layers max 60 units per pallet 1200 x 1000 x 2438 mm (include the pallet)	6-units per layer 8 layer max 48 per pallet 47.24 x 39.37 x 95.12 in, 1200 x 1000 x 2416 mm (including pallet)	10-units per layer 4-layers max 40-units per pallet (sea) 1200 x 1000 x 2470 mm

Technical Specifications – Weights and Dimensions

STANDS AND DIMENSIONS

HP EliteOne G9 AIO Adjustable Height Stand – 23.8"

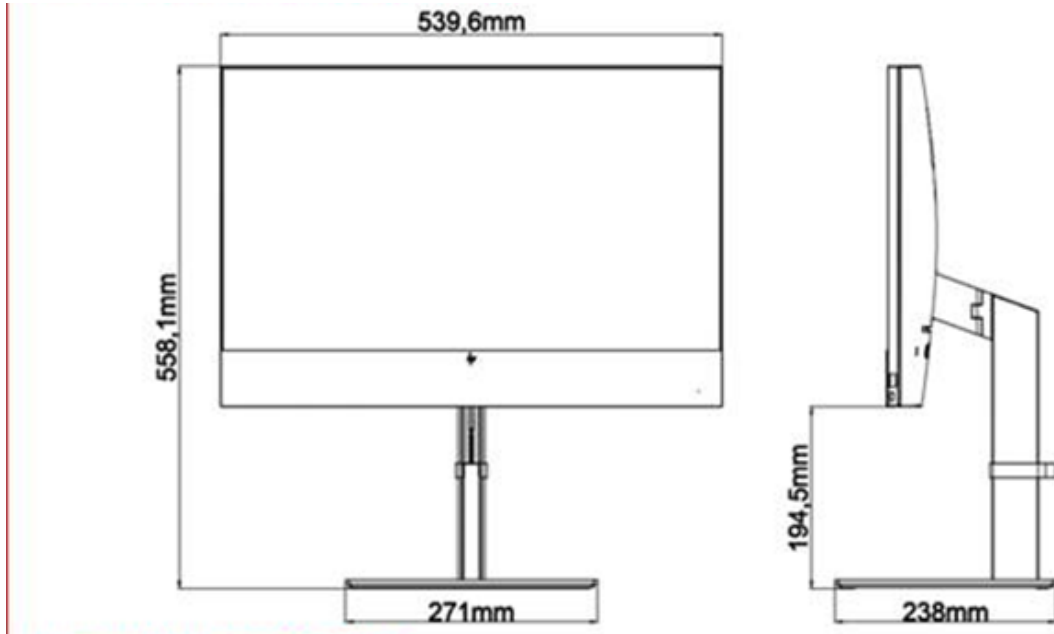

HP EliteOne G9 AIO Recline Stand – 23.8"

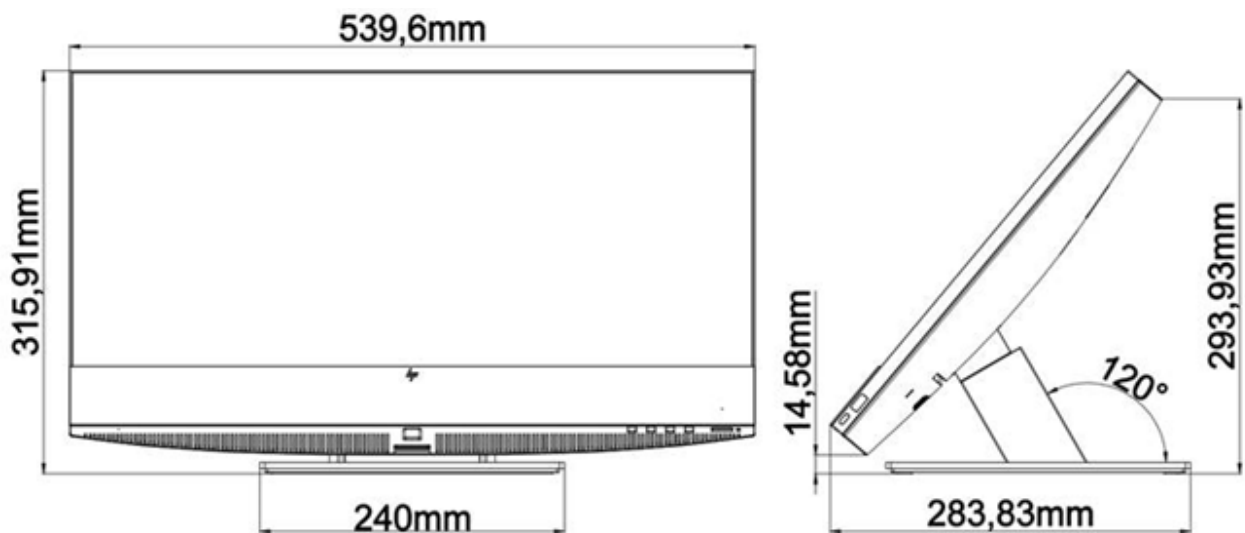

Technical Specifications – Weights and Dimensions

HP EliteOne G9 AIO Adjustable Height Stand – 27”

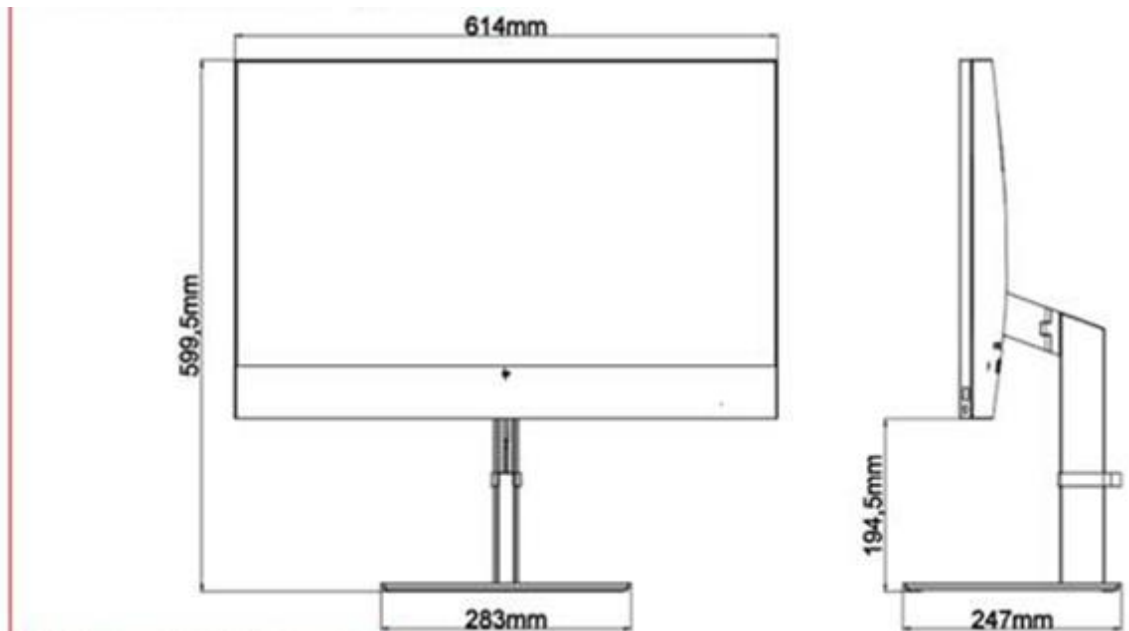

HP EliteOne G9 AIO Recline Stand – 27”

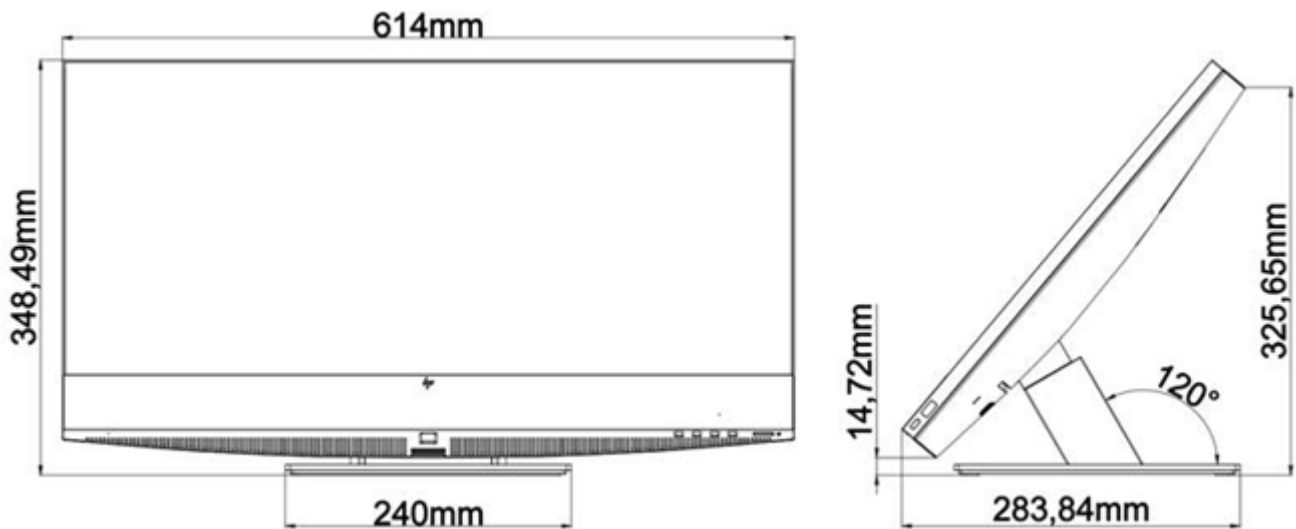

Adjustable Height Stand:	Height - Vertical/Landscape Adjustment	130mm (±2 mm)
	Portrait Adjustment	No portrait
	Tilt Angle	-5° to +18° (±2°) in landscape and portrait
	Rotation (Swivel)	90° (left 45°[+0/-2°], right 45°[+0/-2°])
	Pivot	No pivot

Recline Stand:	Height - Vertical Adjustment	No height
	Tilt Angle	+35°(+/-3°) to +60°(+/-3°)
	Rotation (swivel)	No swivel

Technical Specifications – Weights and Dimensions

ALL-IN-ONE WEIGHTS AND DIMENSIONS

Weight without Touch Panel – 23.8”

Product Weight (DIS) Unboxed	Without Stand 15.39 lb 6.98 kg	Adjustable Height Stand (WLC) 20.55 lb 9.32 kg Adjustable Height Stand 20.42 lb 9.26 kg	Recline Stand 18.96 lb 8.6 kg
Shipping Weight Boxed EPE	Without Stand 22.22 lb 10.08 kg	Adjustable Height Stand 27.56 lb 12.5 kg	Recline Stand 25.93 lb 11.76 kg
Shipping Weight Boxed MPP	Without Stand 22.3 lb 10.12 kg	Adjustable Height Stand 27.64 lb 12.54 kg	Recline Stand 26.01 lb 11.8 kg
Shipping Weight Pallet (30 units) EPE	Without Stand 666.6 lb 302.4 kg	Adjustable Height Stand 826.8 lb 375 kg	Recline Stand 777.79 lb 352.8 kg
Shipping Weight Pallet (30 units) MPP	Without Stand 669 lb 303.6 kg	Adjustable Height Stand 829.2 lb 376.2 kg	Recline Stand 780.3 lb 354 kg

Weight with Touch Panel – 23.8”

Product Weight Unboxed	Without Stand 14.59 lb 6.62 kg	Adjustable Height Stand (WLC) 19.75 lb 8.96 kg Adjustable Height Stand 19.62 lb 8.9 kg	Recline Stand 18.16 lb 8.24 kg
Shipping Weight Boxed EPE	Without Stand 24.6 lb 11.16 kg	Adjustable Height Stand 29.94 lb 13.58 kg	Recline Stand 28.31 lb 12.88 kg
Shipping Weight Boxed MPP	Without Stand 24.68 lb 11.2 kg	Adjustable Height Stand 30.02 lb 13.62 kg	Recline Stand 28.39 lb 12.88 kg
Shipping Weight Pallet (30 units) EPE	Without Stand 738 lb 334.8 kg	Adjustable Height Stand 898.2 lb 407.4 kg	Recline Stand 849.3 lb 385.2 kg
Shipping Weight Boxed MPP	Without Stand 740.4 lb 336 kg	Adjustable Height Stand 900.6 lb 408.6 kg	Recline Stand 851.7 lb 386.4 kg

Technical Specifications – Weights and Dimensions

Dimensions (WxDxH) – 23.8”

Product Dimensions (Non-touch)	Without Stand 539.6 x 52.3 x 386.63 mm	Adjustable Height Stand (-5 ~ 20) degrees 539.6x238x558.1 mm	Recline Stand (30 ~ 60) degrees 539.6x283.82x315.91 mm
Product Dimensions (In-cell Touch)	Without Stand 539.6x52.3x386.63 mm	Adjustable Height Stand (-5 ~ 20) degrees 539.6x238x558.1 mm	Recline Stand (30 ~ 60) degrees 539.6x283.83x315.91 mm

Shipping Dimensions – 23.8”

Shipping Dimensions Boxed	Without Stand 628 x 186 x 675 mm	Adjustable Height Stand 628 x 186 x 675 mm	Recline Stand 628 x 186 x 675 mm
Shipping Dimensions Pallet Pallet (30 units)	Without Stand 1180 x 874 x 2180 mm	Adjustable Height 1180 x 874 x 2180 mm	Recline Stand 1180 x 874 x 2180 mm

Weight without Touch Panel – 27”

Product Weight Unboxed	Without Stand 18.58 lb 8.43 kg	Adjustable Height Stand 23.98 lb 10.88 kg	Recline Stand 22.15 lb 10.05 kg
Shipping Weight Boxed Hybrid : 4351 g	Without Stand 27.38 lb 12.42 kg	Adjustable Height Stand 33.22 lb 15.07 kg	Recline Stand 31.09 lb 14.10 kg
Shipping Weight Pallet (18 units) EPE: 2210 g	Without Stand 426.59 lb 193.5 kg	Adjustable Height Stand 531.75 lb 241.2 kg	Recline Stand 493.26 lb 223.74 kg
Shipping Weight Pallet (18 units) Hybrid : 4351 g	Without Stand 492.86 lb 223.56 kg	Adjustable Height Stand 598.025 lb 271.26 kg	Recline Stand 559.53 lb 253.8 kg

Weight with Touch Panel – 27”

Product Weight Unboxed	Without Stand (QHD DIS) 20.17 lb 9.15 kg	Adjustable Height Stand 25.57 lb 11.6 kg	Recline Stand 23.74 lb 10.77 Kg
Shipping Weight Boxed	Without Stand 23.70 lb 10.75 kg	Adjustable Height Stand 29.54 lb 13.4 kg	Recline Snd 27.40 lb 12.43 kg
Shipping Weight Pallet (18 units)	Without Stand 465.3 lb 211.5 kg	Adjustable Height Stand 570.24 lb 259.2 kg	Recline Stand 531.83 lb 241.74 kg

QuickSpecs

Technical Specifications – Weights and Dimensions

Dimensions (WxDxH) – 27”

Product Dimensions (Non-touch)	Without Stand 614 x 52.3 x 428.2 mm	Adjustable Height Stand (-5 ~ 20) degrees 614 x 247 x 599.5 mm	Recline Stand Stand (35 ~ 60) degrees 614 x 283.83 x 348.49 mm
Product Dimensions (In-cell Touch)	Without Stand 614 x 52.3 x 428.2 mm	Adjustable Height Stand (-5 ~ 20) degrees 614 x 247 x 599.5 mm	Recline Stand Stand (35 ~ 60) degrees 614 x 283.83 x 348.49 mm

Shipping Dimensions – 27”

Shipping Dimensions Boxed	Without Stand 742 x 237 x 640 mm	Adjustable Height Stand 742 x 237 x 640 mm	Recline Stand 742 x 237 x 640 mm
Shipping Dimensions Pallet Pallet (18 units)	Without Stand 1180 x 958 x 2076 mm	Adjustable Height 1180 x 958 x 2076 mm	Recline Stand 1180 x 958 x 2076 mm

MISCELLANEOUS FEATURES

Management Features

- Advanced Configuration and Power Management Interface (ACPI). Allows the system to wake from a low power mode. Controls system power consumption, making it possible to place individual cards and peripherals in a low-power or powered-off state without affecting other elements of the system.
- Intel® Wired for Management support; industry wide initiative to make Intel® architecture based PCs, servers and mobile computers more inherently manageable out-of-the-box and over the network
- Dual State Power Button; acts as both an on/off button and a suspend-to-sleep button

Serviceability Features

- Dual colored power LED on front of computer to indicate either normal or fault condition
- Diagnostic LED Explanation Table:
 - Power LED will blink red 2 to 5 times, then blink white 2 or more times, then repeat (with beep tones for each blink initially):
 - 2 red + 2 white User must provide file for BIOS recovery (USB storage typically)
 - 2 red + 3 white User must enter a key sequence to proceed with recovery by policy
 - 2 red + 4 white BIOS recovery is in progress
 - 3 red + 2 white Memory could not be initialized
 - 3 red + 3 white Graphics adaptor could not be found
 - 3 red + 4 white Power supply failure / not connected
 - 3 red + 5 white Processor not installed
 - 3 red + 6 white Current processor does not support an enabled feature
 - 4 red + 2 white Processor has exceeded its temperature threshold / system thermal shutdown
 - 4 red + 3 white System internal temperature has exceeded its threshold
 - 5 red + 2 white System controller firmware is not valid
 - 5 red + 3 white System controller detected BIOS is not executing
 - 5 red + 4 white BIOS could not complete initialization / PCA failure
 - 5 red + 5 white System controller rebooted the system after a health or recovery timer triggered
- HP PC Hardware Diagnostics UEFI:
 - This utility enables hardware level testing outside the operating system on many components. The diagnostics can be invoked by pressing F2 at POST, and is available as a download from HP Support
- System/Emergency ROM
- Flash ROM
- CMOS Battery
- Holder for easy replacement
- 1 Aux Power LED on System PCA
- Processor ZIF Socket for easy Upgrade
- Over-Temp Warning on Screen (Requires IM Agents)
- DIMM Connectors for easy Upgrade
- Clear CMOS Button
- NIC LEDs (integrated) (Green & Amber)
- Dual Color Power and HD LED - To Indicate Normal Operations and Fault Conditions
- Color coordinated cables and connectors
- Tool-less Hood Removal
- Front power switch
- System memory can be upgraded without removing the system board or any internal components
- Tool-less Hard Drive, CD & Diskette Removal (For MT, SFF, and DM only)
- Green Pull Tabs, and Quick Release Latches for easy Identification

Technical Specifications – Miscellaneous Features

Additional Features	Description
Tower Orientation	Product can be oriented as either a desktop (horizontal) or a tower (vertical) for Tower, SFF, and Mini only. SFF/Mini requires optional stand.
Drive Lock	Implementation of the industry standard ATA Security feature set. When enabled, it prevents software access to user data on the drive until one or two user-defined passwords are provided.
Boot Sectors Protection	MBR and GPT sectors of the hard drive are critical to booting the operating system. By saving the MBR or GPT data (depending on the how the OS was installed), the BIOS will be able to monitor for changes and allow the user to override them with the backup copy at boot-up.
Drive Protection System	DPS Access through F10 Setup during Boot (for SATA hard drive only) A diagnostic hard drive self- test. It scans critical physical components and every sector of the hard drive for physical faults and then reports any faults to the user Running independently of the operating system, it can be accessed through a Windows-based diagnostics utility or through the computer's setup procedure. It produces an evaluation on whether the hard drive is the source of the problem and needs to be replaced The system expands on the Self-Monitoring, Analysis, and Reporting Technology (SMART), a continuously running systems diagnostic that alerts the user to certain types of failures
SMART Technology (Self-Monitoring, Analysis and Reporting Technology)	Allows hard drives to monitor their own health and to raise flags if imminent failures were predicted
SMART I - Drive Failure Prediction	Predicts failures before they occur. Tracks fault prediction and failure indication parameters such as re-allocated sector count, spin retry count, calibration retry count
SMART II - Off-Line Data Collection	By avoiding actual hard drive failures, SMART hard drives act as "insurance" against unplanned user downtime and potential data loss from hard drive failure
SMART III - Off-Line Read Scanning with Defect Reallocation	IOEDC: I/O Error Detection Circuitry
SMART IV - End-to-End CRC for hard drives	Detects errors in Read/Write buffers on HDD cache RAM

AFTER MARKET OPTIONS

HP Presence Accessories	Mini	SFF	TWR	AiO	Part Number
HP Presence Hub	X				4V977AA
HP Presence Audio Video Bar	X				4V974AA
HP Presence See 4K AI Camera	X				4V975AA
HP Presence Talk Satellite Microphones (2)	X				4V976AA
HP Presence No Audio Control Center	X				4V978AA
HP Presence 15m Type-C Cable Kit	X				4V972AA
HP Presence 30m Type-C Cable Kit	X				4V973AA
HP Presence Control Table Mount Kit	X				4V979AA
HP Presence See Table Lock Kit	X				54N70AA
HP Presence Control Table Wall Mount Kit	X				4V980AA

Graphics Solutions	Mini	SFF	TWR	AiO	Part Number
NVIDIA T400 2GB GDDR6 3mDP		X	X		340K8AA
NVIDIA T400 4GB GDDR6 3mDP		X	X		5Z7E0AA
AMD Radeon RX 6300 2GB GDDR6 DP+HDMI		X	X		TBU
HP DisplayPort to HDMI True 4k Adapter	X	X	X	X	2JA63AA
HP DVI Cable Kit		X	X		DC198A
HP HDMI Standard Cable Kit	X	X	X	X	T6F94AA
HP DisplayPort to VGA Adapter	X	X	X	X	AS615AA
HP DisplayPort to DVI-D Adapter	X	X	X	X	FH973AA
HP USB-C To DisplayPort Adapter	X	X	X	X	N9K78AA
HP Single Mini Display Port Adapter to Display Port Adapter	X				2MY05AA

Desktop Mini Accessories	Mini	SFF	TWR	AiO	Part Number
HP Desktop Mini Port Cover v3	X (Discrete GPU skus not supported)				13L69AA
HP Desktop Mini 2.5" SATA Drive Bay kit v2	X (Discrete GPU skus not supported)				13L70AA
HP Desktop Mini 90W Power Supply Kit	X				L4R65AA
HP Desktop Mini Lock Box V2	X (Discrete GPU skus not supported)				3EJ57AA
HP Desktop Mini DVD-Writer ODD Expansion Module	X				K9Q83AA
HP Desktop Mini Security/Dual VESA Sleeve v3	X (95W and discrete GPU skus not supported)				13L67AA

Technical Specifications – After Market Options

HP Desktop Mini Security/Dual VESA Sleeve v3 with Power Supply Holder	X (Discrete GPU skus not supported)				13L68AA
HP B250 PC Mounting Bracket	X				8RA46AA
HP B200 PC Mounting Bracket	x				762T5AA
HP B300 PC Mounting Bracket	X				2DW53AA
HP B300 PC Mounting Bracket with Power Supply Holder	X (Discrete GPU skus and 150W/180W adapter not supported)				7DB37AA
HP Desktop Mini Vertical Chassis Stand	X				G1K23AA
HP 150W Elite Mini EPS Holder*	X				657R3AA
HP Quick Release Bracket 2	X			X	6KD15AA
HP Integrated Work Center Stand 5	X				G1V61AA
HP B550 PC Mounting Bracket	X				16U00AA
HP B560 PC Mounting Bracket	X				763U8AA
HP Desktop Mini 65w Power Supply Kit*	x				L2X04AA
HP Quick Release Monitor Arm	X				762U0AA

NOTE*: Compatible with HP B300 PC Mounting Bracket (2DW53AA) and HP Desktop Mini Security Dual/VESA Sleeve v3 (13L67AA).

AIO Accessories	Mini	SFF	TWR	AiO	Part Number
HP EliteOne G9 VESA Plate				X	6H1W8AA

Data Storage Drives	Mini	SFF	TWR	AiO	Part Number
HP PCIe Gen 4 NVME TLC M.2 512GB SSD	X	X	X	X	406L8AA
HP PCIe Gen 4 NVME TLC M.2 1TB SSD	X	X	X	X	406L7AA
HP 500GB 7200PRM SATA 3.5" Hard Drive		X	X		QK554AA
HP 1TB 7200rpm SATA 3.5" Hard Drive		X	X		QK555AA
HP 2TB 7200rpm SATA 3.5" Hard Drive		X	X		QB576AA

Input Devices	Mini	SFF	TWR	AiO	Part Number
HP 125 Wired Keyboard	X	X	X	X	266C9AA
HP 225 Antimicrobial Wired Mouse and Keyboard Combo (China only)	X	X	X	X	286K3AA
HP 225 Wired Mouse and Keyboard Combo	X	X	X	X	286J4AA
HP 125 Wired Mouse	X	X	X	X	265A9AA
HP 128 Laser Wired Mouse	X	X	X	X	265D9AA
HP Wired Desktop 320K Keyboard	X	X	X	X	9SR37AA

Technical Specifications – After Market Options

HP Wired Desktop 320M Mouse	X	X	X	X	9VA80AA
HP Wired Desktop 320MK Mouse and Keyboard	X	X	X	X	9SR36AA
HP USB Business Slim CCID SmartCard Keyboard	X	X	X	X	Z9H48AA
HP 655 Wireless Keyboard and Mouse Combo	X	X	X	X	4R009AA
HP 455 Programmable Wireless Keyboard	X	X	X	X	4R177AA

System Memory	Mini	SFF	TWR	AiO	Part Number
HP 8GB DDR5-4800 UDIMM		X	X		4M9X9AA
HP 16GB DDR5-4800 UDIMM		X	X		4M9Y0AA
HP 32GB DDR5-4800 UDIMM		X	X		4M9Y2AA
HP 8GB DDR5-4800 SODIMM	X			X	4M9Y4AA
HP 16GB DDR5-4800 SODIMM	X			X	4M9Y5AA
HP 32GB DDR5-4800 SODIMM	X			X	4M9Y7AA
HP 8GB DDR5-5600 SODIMM				X	79U70AA
HP 16GB DDR5-5600 SODIMM				X	79U71AA
HP 32GB DDR5-5600 SODIMM				X	79U72AA

Multimedia Devices	Mini	SFF	TWR	AiO	Part Number
HP S101 Speaker Bar	X	X	X	X	5UU40AA
HP Stereo 3.5mm Headset G2	X	X	X	X	428K7AA
HP Stereo USB Headset G2	X	X	X	X	428K6AA

Security Devices	Mini	SFF	TWR	AiO	Part Number
HP Business PC Security Lock v3 Kit		X	X	X	3XJ17AA
HP Keyed Cable Lock 10mm	X	X	X	X	T1A62AA
HP Master Keyed Cable Lock 10mm	X	X	X	X	T1A63AA

I/O Devices	Mini	SFF	TWR	AiO	Part Number
HP DisplayPort Port Flex IO v2	X	X	X		13L54AA
HP Type-C® USB 3.1 Gen2 Port Flex IO v2		X	X		13L59AA
HP USB 3.1 Gen1 x2 Module Flex IO v2	X (Not Available on discrete GPU SKUs)	X	X		13L58AA
HP VGA Port Flex IO v2	X	X	X		13L53AA
HP Serial Port Flex IO 2 nd v2	X (Not Available on discrete GPU SKUs)				13L57AA
HP Internal Serial Port (in rear wall)		X	X		3TK82AA
HP PCIe x1 Parallel Port Card		X	X		N1M40AA
HP Serial/PS/2 Adapter Kit (in PCIe slot)		X	X		1VD82AA
HP USB to Serial Port Adapter	X	X	X	X	J7B60AA
HP USB-C to Display Port Adapter	X	X	X	X	N9K78AA

Technical Specifications – After Market Options

HP Single Mini Display Port Adapter to Display Port Adapter	X (Only Available with GPU SKUs)				2MY05AA
HP Serial Port v3 Flex IO	X	X	X		5B895AA
HP TBT v3 Flex IO	X				440A5AA
HP HDMI Port Flex IO v2	X	X	X		13L55AA
HP Parallel Port Adapter	X	X	X		KD061AA

NOTE: For more detail on HP I/O Devices please refer to the [HP FLEX IO Option Cards QuickSpecs](http://h20195.www2.hp.com/v2/GetDocument.aspx?docname=c06042607). URL is: <http://h20195.www2.hp.com/v2/GetDocument.aspx?docname=c06042607>

Communication Devices	Mini	SFF	TWR	AiO	Part Number
Intel® Ethernet I225-T1 GbE NIC		X	X		406L9AA
Intel Wi-Fi 6 AX210 ax 2x2 + BT5.2 non-vPro		X	X		340L7AA

Change Log

© Copyright 2023 HP Development Company, L.P.

The information contained herein is subject to change without notice. The only warranties for HP products are set forth in the express limited warranty statements accompanying such products. Nothing herein should be construed as constituting an additional warranty. HP shall not be liable for technical or editorial errors or omissions contained herein. Microsoft and Windows are registered trademarks or trademarks of Microsoft Corporation in the U.S. and/or other countries. Intel, Celeron, Core, Pentium are registered trademarks or trademarks of Intel Corporation in the U.S. and/or other countries. Bluetooth® is a trademark of its proprietor, used by HP, Inc. under license. USB Type-C® and USB-C® are trademarks of USB Implementers Forum. NVIDIA, GeForce and NVS are trademarks and/or registered trademarks of NVIDIA Corporation in the U.S. and other countries. AMD and Radeon are trademarks of Advanced Micro Devices, Inc. ENERGY STAR is a registered trademark owned by the U.S. Environmental Protection Agency. DisplayPort™ and the DisplayPort™ logo are trademarks owned by the Video Electronics Standards Association (VESA®) in the United States and other countries.

Date	Version History	Action	Description of Change
May 30, 2023	From v1 to v2	Update	T1000 8GB GDDR6 removed / HP Sure Key Cable Lock removed / All SSD specs tables corrected.
June 5, 2023	From v2 to v3	Addition	Notes added to RTX 3050 8GB GDDR6, RTX 3060 LHR and RTX 3070 LHR Graphics GC's.
June 20, 2023	From v3 to v4	Correction	Not shown tables in front call out images for TWR's and SFF corrected
June 27, 2023	From v4 to v5	Removal	"And will be ready in post launch" removed from AAG section
June 28, 2023	From v5 to v6	Update	SFF Environmental table updated
July 5, 2023	From v6 to v7	Removal	"-T1" from Network Adapter I225, in NET & COM section
July 12, 2023	From v7 to v8	Update	AiO's back call out images corrected
July 17, 2023	From v8 to v9	Update	TWR call outs front image updated
August 29, 2023	From v9 to v10	Update	Adjustable high stand and Recline stand tables corrected in pages 54 and 100
	From v10 to v11		
	From v11 to v12		
	From v12 to v13		
	From v13 to v14		
	From v14 to v15		
	From v15 to v16		
	From v16 to v17		
	From v17 to v18		
	From v18 to v19		
	From v19 to v20		
	From v20 to v21		
	From v21 to v22		
	From v22 to v23		
	From v23 to v24		
	From v24 to v25		
	From v25 to v26		
	From v26 to v27		
	From v27 to v28		
	From v28 to v29		
	From v29 to v30		
	From v30 to v31		