



Maintenance and Service Guide

SUMMARY

This guide provides maintenance information about such topics as spare parts, removal and replacement of parts, security, and backing up.

Legal information

© Copyright 2023 HP Development Company, L.P.

AMD is a trademark of Advanced Micro Devices, Inc. Bluetooth is a trademark owned by its proprietor and used by HP Inc. under license. Chrome is a trademark of Google LLC. The terms HDMI, HDMI High-Definition Multimedia Interface, and the HDMI Logo are trademarks or registered trademarks of HDMI Licensing Administrator, Inc. Intel, Core, Iris, Thunderbolt, and vPro are trademarks of Intel Corporation or its subsidiaries in the U.S. and/or other countries. Microsoft and Windows are either registered trademarks or trademarks of Microsoft Corporation in the United States and/or other countries. NVIDIA, GeForce RTX, and RTX are trademarks and/or registered trademarks of NVIDIA Corporation in the U.S. and other countries. NVMe is a registered trademark of NVM Express. PCIe is a US registered trademark of PCI-SIG. microSD™ is a trademark or registered trademark of SD-3C LLC. USB Type-C is a registered trademark of USB Implementers Forum. DisplayPort™ and the DisplayPort™ logo are trademarks owned by the Video Electronics Standards Association (VESA) in the United States and other countries. Wi-Fi is a registered trademark of Wi-Fi Alliance.

The information contained herein is subject to change without notice. The only warranties for HP products and services are set forth in the express warranty statements accompanying such products and services. Nothing herein should be construed as constituting an additional warranty. HP shall not be liable for technical or editorial errors or omissions contained herein.

First Edition: May 2023

Document Part Number: N41738-001

Product notice

This guide describes features that are common to most models. Some features may not be available on your computer.

Not all features are available in all editions or versions of Windows. Systems may require upgraded and/or separately purchased hardware, drivers, software or BIOS update to take full advantage of Windows functionality. Windows is automatically updated, which is always enabled. High-speed internet and Microsoft account required. ISP fees may apply and additional requirements may apply over time for updates. See <http://www.microsoft.com>.

If your product ships with Windows in S

Mode: Windows in S Mode works exclusively with apps from the Microsoft Store within Windows. Certain default settings, features, and apps cannot be changed. Some accessories and apps that are compatible with Windows may not work (including some antivirus, PDF writers, driver utilities, and accessibility apps), and performance may vary, even if you switch out of S Mode. If you switch to Windows, you cannot switch back to S Mode. Learn more at Windows.com/SmodeFAQ.

To access the latest user guides, go to <http://www.hp.com/support>, and follow the instructions to find your product. Then select **Manuals**.

Software terms

By installing, copying, downloading, or otherwise using any software product preinstalled on this computer, you agree to be bound by the terms of the HP End User License Agreement (EULA). If you do not accept these license terms, your sole remedy is to return the entire unused product (hardware and software) within 14 days for a full refund subject to the refund policy of your seller.

For any further information or to request a full refund of the price of the computer, please contact your seller.

Safety warning notice

Reduce the possibility of heat-related injuries or of overheating the computer by following the practices described.

⚠ WARNING! To reduce the possibility of heat-related injuries or of overheating the computer, do not place the computer directly on your lap or obstruct the computer air vents. Use the computer only on a hard, flat surface. Do not allow another hard surface, such as an adjoining optional printer, or a soft surface, such as pillows or rugs or clothing, to block airflow. Also, do not allow the AC adapter to come into contact with the skin or a soft surface, such as pillows or rugs or clothing, during operation. The computer and the AC adapter comply with the user-accessible surface temperature limits defined by applicable safety standards.

Table of contents

1 Product description	1
2 Components	5
Locating hardware	5
Locating software.....	5
Right.....	5
Left.....	6
Display	8
Low blue light mode (select products only).....	8
Keyboard area	9
Touchpad	10
Touchpad settings	10
Adjusting touchpad settings.....	10
Turning on the touchpad	10
Touchpad components	10
Lights	11
Button, speakers, and fingerprint reader	13
Special keys.....	14
Bottom	16
Labels	17
3 Illustrated parts catalog	19
Computer major components.....	19
Display assembly subcomponents	25
Miscellaneous parts.....	27
4 Removal and replacement procedures preliminary requirements	31
Tools required	31
Service considerations.....	31
Plastic parts.....	31
Cables and connectors.....	31
Drive handling	31
Electrostatic discharge information.....	32
Generating static electricity.....	32

Preventing electrostatic damage to equipment.....	33
Personal grounding methods and equipment.....	33
Grounding the work area.....	34
Recommended materials and equipment.....	34
Cleaning your computer.....	35
Enabling HP Easy Clean (select products only).....	35
Removing dirt and debris from your computer.....	35
Cleaning your computer with a disinfectant.....	36
Caring for wood veneer (select products only).....	37
Packaging and transporting guidelines.....	37
Accessing support information.....	38
5 Removal and replacement procedures for authorized service provider parts.....	40
Component replacement procedures.....	40
Preparation for disassembly.....	40
Bottom cover.....	40
Solid-state drive.....	42
Bottom speakers.....	44
Battery.....	46
Memory modules.....	47
Fans.....	49
Heat sink.....	49
Display assembly.....	51
System board.....	62
Wireless antenna.....	66
Fingerprint reader cable.....	67
Fingerprint reader.....	68
Transfer board cable.....	69
Transfer board.....	70
Touchpad cable.....	71
Touchpad.....	72
RTC battery.....	73
Top speakers.....	74
Audio jack.....	75
Top cover with keyboard.....	76
6 Computer Setup (BIOS), TPM, and HP Sure Start.....	78
Using Computer Setup.....	78
Navigating and selecting in Computer Setup.....	78
Restoring factory settings in Computer Setup.....	79
Updating the BIOS.....	79
Determining the BIOS version.....	79
Preparing for a BIOS update.....	79
Downloading a BIOS update.....	80
Installing a BIOS update.....	80
Changing the boot order using the f9 prompt.....	80
TPM BIOS settings (select products only).....	81
Using HP Sure Start (select products only).....	81

7 Backing up, restoring, and recovering	82
Backing up information and creating recovery media	82
Using Windows tools for backing up	82
Using the HP Cloud Recovery Download Tool to create recovery media (select products only)	82
Restoring and recovering your system	83
Creating a system restore	83
Restoring and recovery methods	83
Recovering using HP Recovery media	83
Changing the computer boot order	84
Using HP Sure Recover (select products only)	84
8 Using HP PC Hardware Diagnostics	85
Using HP PC Hardware Diagnostics Windows (select products only)	85
Using an HP PC Hardware Diagnostics Windows hardware failure ID code	85
Accessing HP PC Hardware Diagnostics Windows	85
Accessing HP PC Hardware Diagnostics Windows from HP Support Assistant	85
Accessing HP PC Hardware Diagnostics Windows from the Start menu (select products only)	86
Downloading HP PC Hardware Diagnostics Windows	86
Downloading the latest HP PC Hardware Diagnostics Windows version from HP	86
Downloading the HP PC Hardware Diagnostics Windows from the Microsoft Store	86
Downloading HP Hardware Diagnostics Windows by product name or number (select products only)	87
Installing HP PC Hardware Diagnostics Windows	87
Using HP PC Hardware Diagnostics UEFI	87
Using an HP PC Hardware Diagnostics UEFI hardware failure ID code	87
Starting HP PC Hardware Diagnostics UEFI	87
Starting HP PC Hardware Diagnostics UEFI through HP Hotkey Support software (select products only)	88
Downloading HP PC Hardware Diagnostics UEFI to a USB flash drive	88
Downloading the latest HP PC Hardware Diagnostics UEFI version	89
Downloading HP PC Hardware Diagnostics UEFI by product name or number (select products only)	89
Using Remote HP PC Hardware Diagnostics UEFI settings (select products only)	89
Downloading Remote HP PC Hardware Diagnostics UEFI	89
Downloading the latest Remote HP PC Hardware Diagnostics UEFI version	89
Downloading Remote HP PC Hardware Diagnostics UEFI by product name or number	89
Customizing Remote HP PC Hardware Diagnostics UEFI settings	90
9 Specifications	91
Computer specifications	91
Display specifications	92
Solid-state drive specifications	92
10 Statement of memory volatility	94
Current BIOS steps	94
Nonvolatile memory usage	96
Questions and answers	97

Using HP Sure Start (select products only).....	98
11 Power cord set requirements.....	99
Requirements for all countries	99
Requirements for specific countries and regions.....	99
12 Recycling.....	102
Index.....	103

1 Product description

This table provides detailed product information.

Table 1-1 Product components and their descriptions

Category	Description
Product Name	HP ZBook Studio 16 inch G10 Mobile Workstation PC
Processors	Intel® Core® i9-13900H 2.6 GHz processor (14 cores, 24 MB L3 cache, 45 W) Intel Core i9-13900HK 2.6 GHz processor (14 cores, 24 MB L3 cache, 45 W) Intel Core i7-13800H 2.5 GHz processor (14 cores, 24 MB L3 cache, 45 W) Intel Core i7-13700H 2.4 GHz processor (14 cores, 24 MB L3 cache, 45 W) Intel Core i5-13600H 2.8 GHz processor (12 cores, 18 MB L3 cache, 45 W)
Chipset	Intel integrated soldered-on-circuit (SoC)
Display	40.6 cm (16.0 in), liquid crystal display (LCD), wide quad ultra extended graphics array (WQUXGA), DreamColor (3840 × 2400), antiglare, light-emitting diode (LED), ultrawide viewing angle (UWVA), DCI-P3, 100% CG, embedded DisplayPort™ (eDP) 1.4 + panel self-refresh (PSR), bent, nontouchscreen (nTS) display panel with narrow bezel; typical brightness: 500 nits 40.6 cm (16.0 in), LCD, WQUXGA (3840 × 2400), brightview, organic light-emitting diode (OLED) + low blue light (LBL), UWVA, DCI-P3, 100% CG, eDP 1.4 + PSR, bent, nTS display panel with narrow bezel; typical brightness: 400 nits 40.6 cm (16.0 in), LCD, WQUXGA (3840 × 2400), brightview, OLED + LBL, UWVA, DCI-P3, 100% CG, eDP 1.4 + PSR, bent, direct bonding touchscreen (DBTS) display panel with narrow bezel; typical brightness: 400 nits 40.6 cm (16.0 in), LCD, widescreen ultra extended graphics array (WUXGA) (1900 × 1200), antiglare, white light-emitting diode (WLED) + LBL, UWVA, sRGB, 100% CG, eDP 1.4 + PSR2, bent, nTS display panel with narrow bezel; typical brightness: 400 nits
Graphics controller	Intel Iris™ Xe NVIDIA® GeForce RTX® 4080 with 12 GB memory NVIDIA GeForce RTX 4070 with 8 GB memory NVIDIA RTX® 4000 with 12 GB memory NVIDIA RTX 3000 with 8 GB memory NVIDIA RTX 2000 with 8 GB memory NVIDIA RTX A1000 with 6 GB memory

Table 1-1 Product components and their descriptions (continued)

Category	Description
Graphics memory	<p>Graphics double data rate (GDDR6) 512 MB × 32, 1.35 V, 20 GBps graphics memory</p> <p>GDDR6 512 MB × 32, 1.35 V, 18 GBps graphic memory</p> <p>GDDR6 512 MB × 32, 1.35 V, 16 GBps graphic memory</p>
Memory	<p>Double data rate (DDR5)-5600 and DDR5-4800</p> <p>Two memory module slots (small outline dual in-line memory modules (SODIMMs) supporting up to 64 GB of RAM in the following configurations:</p> <p>DDR5-5600, 1.1 V</p> <ul style="list-style-type: none"> • 64 GB (2 × 32 GB) • 48 GB (1 × 32 GB + 1 × 16) • 40 GB (1 × 32 GB + 1 × 8) • 32 GB (1 × 32 GB or 2 × 16) • 24 GB (1 × 16 GB + 1 × 8) • 16 GB (1 × 16 GB or 2 × 8) • 8 GB (1 × 8 GB) <p>DDR5-4800, 1.1 V</p> <ul style="list-style-type: none"> • 64 GB (2 × 32 GB) • 48 GB (1 × 32 GB + 1 × 16) • 40 GB (1 × 32 GB + 1 × 8) • 32 GB (1 × 32 GB or 2 × 16) • 24 GB (1 × 16 GB + 1 × 8) • 16 GB (1 × 16 GB or 2 × 8) • 8 GB (1 × 8 GB)
Storage - solid-state drive	<p>Support for the following solid-state drives:</p> <ul style="list-style-type: none"> • 4 TB, M.2 2280, Peripheral Component Interconnect Express (PCIe®-4×4), Non-Volatile Memory Express (NVMe®), dual-sided solid-state drive with three-layer cell (TLC) • 2 TB, M.2 2280, PCIe-4×4, NVMe solid-state drive with TLC • 1 TB, M.2 2280, PCIe-4×4, NVMe solid-state drive with TLC • 1 TB, M.2 2280, PCIe-4×4, NVMe, self-encrypting solid-state drive with TLC and OPAL2 • 512 GB, M.2 2280, PCIe-4×4, NVMe solid-state drive with TLC • 512 GB, M.2 2280, PCIe-4×4, NVMe, self-encrypting solid-state drive with TLC and OPAL2
Audio and video	<p>Audio brand: BANG and OLUFSEN</p> <p>Support for quad speakers</p> <p>HP True Vision Camera: integrated, high-definition (HD), USB 2.0, narrow field-of-view (NFOV), fixed, infrared (IR)</p> <p>Dual-array microphone</p>

Table 1-1 Product components and their descriptions (continued)

Category	Description
Card reader	microSD® media reader slot
Wireless	Integrated Intel AX211 Wi-Fi® 6E + Bluetooth® 5.3 M.2 1216 vPro® 160 MHz CNVi worldwide (WW) wireless local area network (WLAN) module
Ports	<p>Hot plug/unplug and autodetect for correct output to wide-aspect vs. standard-aspect video</p> <ul style="list-style-type: none"> • Audio-out (headphone)/Audio-in (microphone) combo jack • High-Definition Multimedia Interface® (HDMI®) port • SIM card slot (select products only) • Smart card reader (select products only) • USB 5 Gbps port • USB 5 Gbps port with HP Sleep and Charge • USB Type-C® power connector and 5 Gbps ports with HP Sleep and Charge and DisplayPort output (2) • USB Type-C power connector and Thunderbolt™ ports with HP Sleep and Charge and DisplayPort output (2)
Keyboard/pointing devices	<p>Keyboard: Backlit, island-style, notebook PC keyboard with Clickpad, image sensor, numeric keypad in soft grey finish</p> <ul style="list-style-type: none"> • Backlit, island-style, RGB, spill-resistant, Z Command, quiet keyboard with Clickpad and image sensor • Backlit, island-style, RGB, spill-resistant, quiet keyboard with Clickpad and image sensor • Backlit, island-style, spill-resistant, quiet keyboard with Clickpad and image sensor <p>Touchpad</p> <p>Clickpad with image sensor</p> <p>Multitouch gestures enabled</p> <p>Precision touchpad support</p> <p>Taps enabled as default</p>
Power requirements	<p>6 cell, 86 Whr, Long Life, polymer battery</p> <p>HP Fast Charge Technology</p> <p>200 W HP Smart AC adapter (power factor correction [PFC], right-angle barrel, slim 4.5 mm, 3 pin)</p> <p>150 W HP Smart AC adapter (power factor correction [PFC], right-angle barrel, slim 4.5 mm, 3 pin)</p> <p>C13, 1.8 m (6.0 ft), HF power cord (conventional with sticker and straight plug)</p> <p>C13, 1.0 m (3.3 ft), power cord (premium with tag)</p> <p>C5, 1.0 m (3.3 ft), HF power cord (conventional with sticker and straight plug)</p> <p>C5, 1.0 m (3.3 ft), HF power cord (premium with sticker and straight plug)</p> <p>C5, 1.0 m (3.3 ft), power cord (premium with tag)</p>

Table 1-1 Product components and their descriptions (continued)

Category	Description
Security	Fingerprint reader
	HP combination nano cable lock
	HP essential combination nano cable lock
Sensor	Ambient light sensor
Operating system	FreeDOS
	Windows® 11 Home
	Windows 11 Home Single Language
	Windows 11 Pro
	Windows 11 Pro (preinstalled with Windows 10 Pro Downgrade)
	Windows 11 Pro (Windows 11 Enterprise or Windows 10 Enterprise available with a Volume Licensing Agreement)
	Windows 11 Pro Education
Serviceability	End user replaceable part: AC adapter

2 Components

Your computer features top-rated components. This chapter provides details about your components, where they are located, and how they work.

Locating hardware

Use these instructions to find out what hardware is installed on your computer.

- Select the **Search** icon (select products only) in the taskbar, type `device manager` in the search box, and then select the **Device Manager** app.

A list displays all the devices installed on your computer.

For information about system hardware components and the system BIOS version number, press `fn+esc` (select products only).

Locating software

Use these instructions to find out what software is installed on your computer:

- Right-click the **Start** button, and then select **Apps and Features**.

Right

Use the illustration and table to identify the components on the right side of the computer.

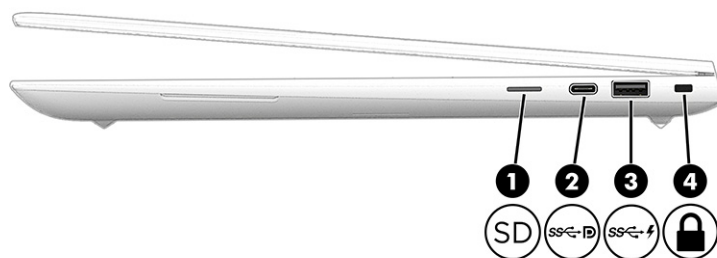

Table 2-1 Right-side components and their descriptions

Component	Description
<p>(1)  microSD™ memory card reader</p>	<p>Reads optional memory cards that store, manage, share, or access information.</p> <p>To insert a card:</p> <ol style="list-style-type: none"> 1. Hold the card label-side up, with the connectors facing the computer. 2. Insert the card into the memory card reader, and then press in on the card until it is firmly seated. <p>To remove a card:</p> <ul style="list-style-type: none"> ■ Press in on the card, and then remove it from the memory card reader.
<p>(2)  USB Type-C 10 Gbps signaling rate power connector port with HP Sleep and Charge and DisplayPort output</p>	<p>Connects an AC adapter that has a USB Type-C connector, supplying power to the computer and, if needed, charging the computer battery.</p> <p>- and -</p> <p>Connects a USB device, provides high-speed data transfer, and (for select products) charges small devices (such as a smartphone) when the computer is on or in Sleep mode.</p> <p>NOTE: Use a standard USB Type-C charging cable or cable adapter (purchased separately) when charging a small external device.</p> <p>- and -</p> <p>Connects a display device that has a USB Type-C connector, providing DisplayPort output.</p>
<p>(3)  USB port with 5 Gbps signaling rate and HP Sleep and Charge</p>	<p>Connects a USB device, provides high-speed data transfer, and charges small devices (such as a smartphone), even when the computer is off.</p> <p>NOTE: Use a standard USB Type-A charging cable or cable adapter (purchased separately) when charging a small external device.</p>
<p>(4)  Security cable slot</p>	<p>Attaches an optional security cable to the computer.</p> <p>NOTE: The security cable is designed to act as a deterrent, but it might not prevent the computer from being mishandled or stolen.</p>

Left

Use the illustration and table to identify the components on the left side of the computer.

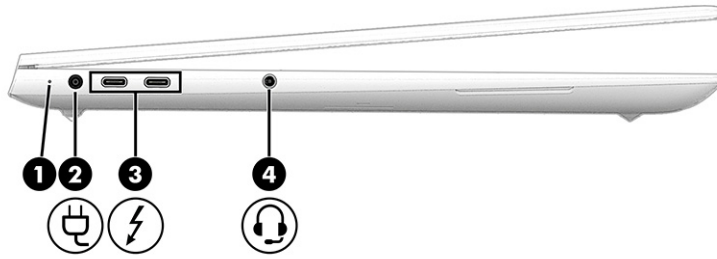

Table 2-2 Left-side components and their descriptions



Component	Description
(1) Battery light	<p>When AC power is connected:</p> <ul style="list-style-type: none"> • White: The battery charge is greater than 90 percent. • Amber: The battery charge is from 0 to 90 percent. • Off: The battery is not charging. <p>When AC power is disconnected (battery not charging):</p> <ul style="list-style-type: none"> • Blinking amber: The battery has reached a low battery level. When the battery has reached a critical battery level, the battery light begins blinking rapidly. • Off: The battery is not charging.
(2)  Power connector	Connects an AC adapter.
(3)  USB Type-C 40 Gbps signaling rate power connector and Thunderbolt port with HP Sleep and Charge and DisplayPort output (2)	<p>Connect an AC adapter that has a USB Type-C connector, supplying power to the computer and, if needed, charging the computer battery.</p> <p>- and -</p> <p>Connect a USB device, provides high-speed data transfer, and charges small devices (such as a smartphone), even when the computer is off.</p> <p>NOTE: Use a standard USB Type-C charging cable or cable adapter (purchased separately) when charging a small external device.</p> <p>- and -</p> <p>Connect a display device that has a USB Type-C connector, providing DisplayPort output.</p> <p>NOTE: Your computer might also support a Thunderbolt docking station.</p>

Table 2-2 Left-side components and their descriptions (continued)

Component	Description
(4)  Audio-out (headphone)/Audio-in (microphone) combo jack	<p>Connects optional powered stereo speakers, headphones, earbuds, a headset, or a television audio cable. Also connects an optional headset microphone. This jack does not support optional standalone microphones.</p> <p>WARNING! To reduce the risk of personal injury, adjust the volume before putting on headphones, earbuds, or a headset. For additional safety information, see the <i>Regulatory, Safety, and Environmental Notices</i>.</p> <p>To access this guide:</p> <ul style="list-style-type: none">■ Select the Search icon in the taskbar, type HP Documentation in the search box, and then select HP Documentation. <p>NOTE: When a device is connected to the jack, the computer speakers are disabled.</p>

Display

Use the illustration and table to identify the display components.

Low blue light mode (select products only)

Your computer display is shipped from the factory in low blue light mode for improved eye comfort and safety. Also, blue light mode automatically adjusts blue light emissions when you are using the computer at night or for reading.

-  **WARNING!** To reduce the risk of serious injury, read the *Safety & Comfort Guide*. It describes proper workstation setup and proper posture, health, and work habits for computer users. The *Safety & Comfort Guide* also provides important electrical and mechanical safety information. The *Safety & Comfort Guide* is available on the web at <http://www.hp.com/ergo>.

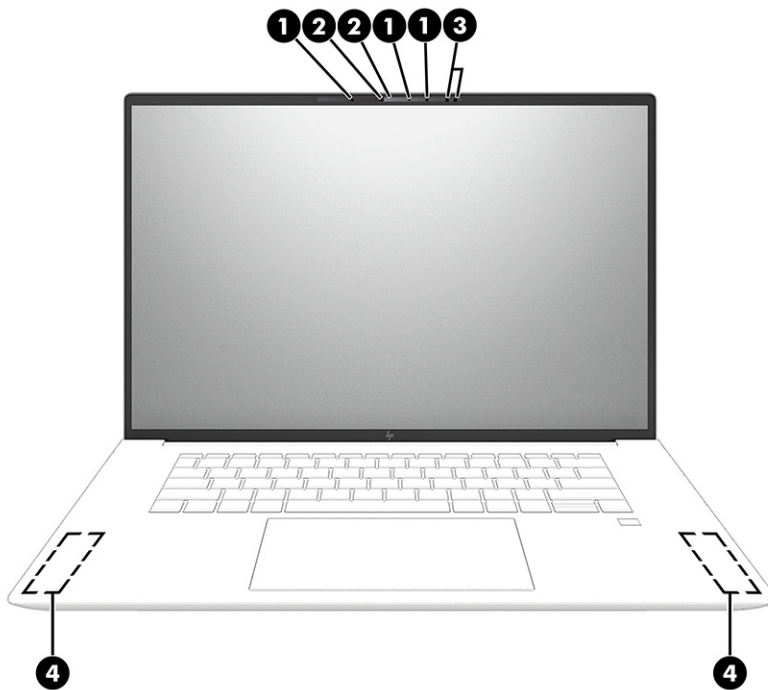

Table 2-3 Display components and their descriptions

Component	Description
(1) Camera lights	On: One or more cameras are in use.
(2) Cameras	Allow you to video chat, record video, and record still images. Some cameras also allow a facial recognition logon to Windows, instead of a password logon. NOTE: Camera functions vary depending on the camera hardware and software installed on your product.
(3) Ambient light sensors (2) (select products only)	Adjust the brightness of the display, depending on the ambient light.
(4) WLAN antennas (2)*	Send and receive wireless signals to communicate with wireless local area networks (WLANs).

*The antennas are not visible from the outside of the computer. For optimal transmission, keep the areas immediately around the antennas free from obstructions.

For wireless regulatory notices, see the section of the *Regulatory, Safety, and Environmental Notices* that applies to your country or region.

To access this guide:

- Select the **Search** icon in the taskbar, type `HP Documentation` in the search box, and then select **HP Documentation**.

Keyboard area

Keyboards can vary by language.



NOTE: The keyboard, including the function keys and power button (select products only), is disabled in stand, tent, and tablet modes. To enable the keyboard, including the power button, change to the clamshell mode.

Touchpad

The touchpad settings and components are described here.

Touchpad settings

You learn how to adjust the touchpad settings and components here.

Adjusting touchpad settings

Use these steps to adjust touchpad settings and gestures.

1. Select the **Search** icon (select products only) in the taskbar, type `touchpad settings` in the search box, and then press `enter`.
2. Choose a setting.

Turning on the touchpad

Follow these steps to turn on the touchpad.

1. Select the **Search** icon (select products only) in the taskbar, type `touchpad settings` in the search box, and then press `enter`.
2. Using an external mouse, click the **Touchpad** button.

If you are not using an external mouse, press the `Tab` key repeatedly until the pointer rests on the **touchpad** button. Then press the `spacebar` to select the button.

Touchpad components

Use the illustration and table to identify the touchpad components.

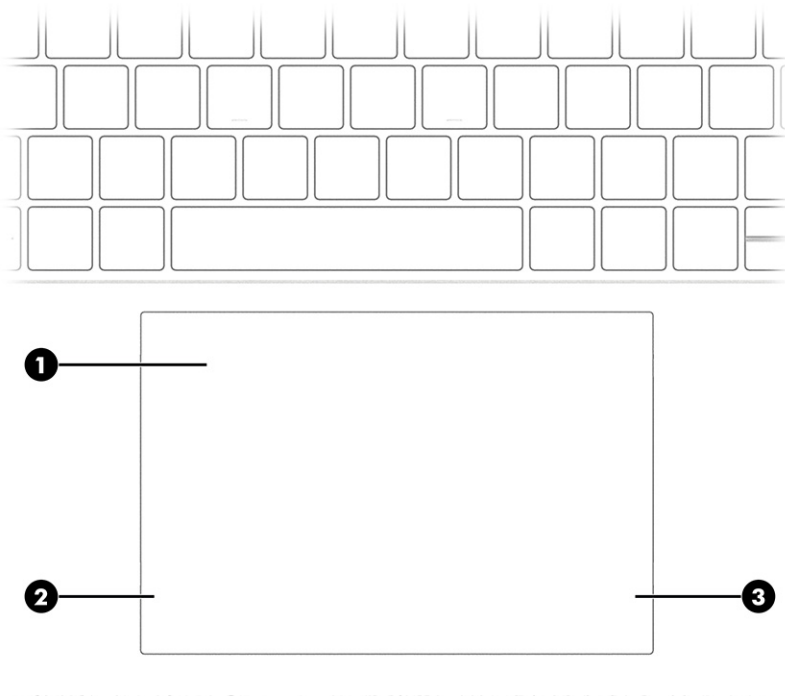



Table 2-4 Touchpad components and their descriptions

Component	Description
(1) Touchpad zone	Reads your finger gestures to move the pointer or activate items on the screen.
(2) Left control zone	Textured area that allows you to perform additional gestures.
(3) Right control zone	Textured area that allows you to perform additional gestures.

Lights

Use the illustration and table to identify the lights on the computer.

 **NOTE:** Your computer might look slightly different from the illustration in this section.

 **NOTE:** You can configure various keyboards. The features and keyboard layout might vary depending on the model.

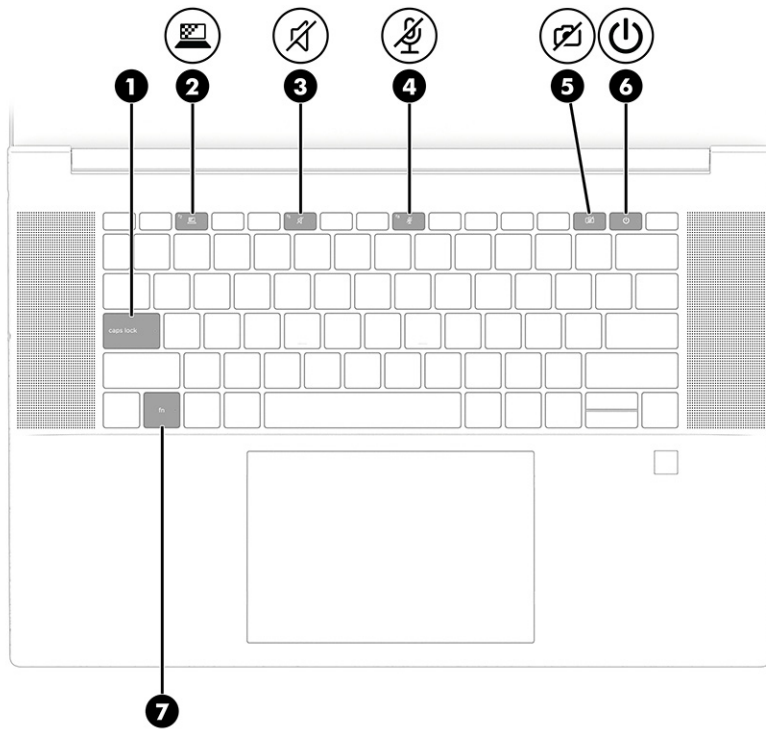







Table 2-5 Lights and their descriptions

Component	Description
(1) Caps lock light	On: Caps lock is on, which switches the key input to all capital letters.
(2)  Privacy key light (select products only)	On: Privacy screen is on, which helps prevent side-angle viewing.
(3)  Mute light	<ul style="list-style-type: none"> • On: Computer sound is off. • Off: Computer sound is on.
(4)  Microphone mute light	<ul style="list-style-type: none"> • On: Microphone is off. • Off: Microphone is on.
(5)  Camera privacy light	<ul style="list-style-type: none"> • On: Camera is disabled. • Off: Camera is enabled.
(6)  Power light	<ul style="list-style-type: none"> • On: The computer is on. • Blinking (select products only): The computer is in the Sleep state, a power-saving state. The computer shuts off power to the display and other unnecessary components. • Off: Depending on your computer model, the computer is off, in Hibernation, or in Sleep. Hibernation is the power-saving state that uses the least amount of power.
(7) Fn lock light	On: The fn key is locked.

Button, speakers, and fingerprint reader

Fingerprint readers can be located on the touchpad, on a side panel of the computer, or on the top cover below the keyboard.

IMPORTANT: To verify that your computer supports fingerprint reader sign-in, select the **Search** icon in the taskbar, type **Sign-in options** in the search box, and then select the **Sign-on options** app. If **Fingerprint recognition** is not listed as an option, then your notebook does not include a fingerprint reader.

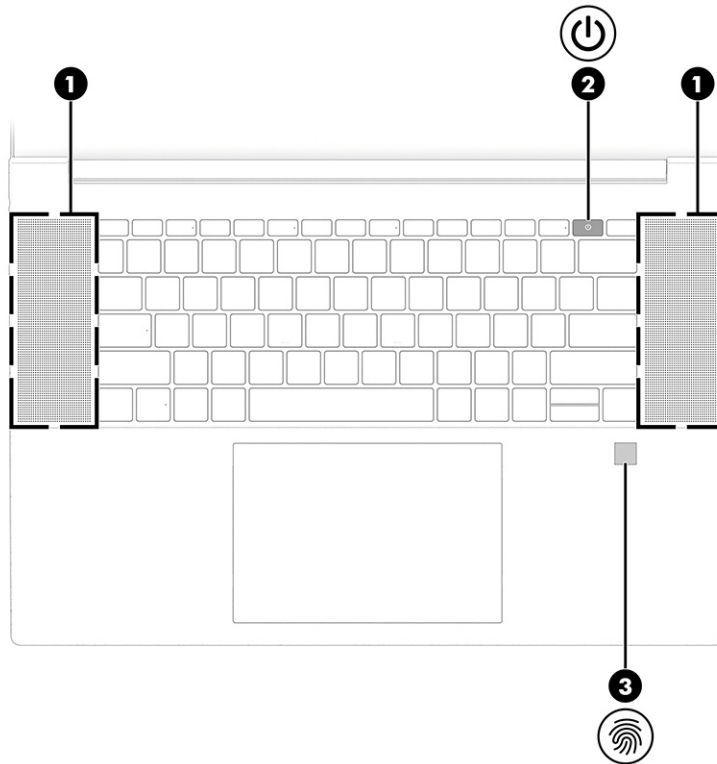





Table 2-6 Button, speakers, and fingerprint reader and their descriptions

Component	Description
(1) Speakers (2)	Produce sound.

Table 2-6 Button, speakers, and fingerprint reader and their descriptions (continued)

Component	Description
(2)  Power button	<ul style="list-style-type: none">• When the computer is off, press the button briefly to turn on the computer.• When the computer is on, press the button briefly to initiate Sleep.• When the computer is in the Sleep state, press the button briefly to exit Sleep (select products only).• When the computer is in Hibernation, press the button briefly to exit Hibernation. <p>IMPORTANT: Pressing and holding down the power button results in the loss of unsaved information.</p> <p>If the computer has stopped responding and shutdown procedures are ineffective, press and hold the power button for at least 4 seconds to turn off the computer.</p> <p>To learn more about your power settings, use the Power icon.</p> <ul style="list-style-type: none">• Right-click the Power icon , and then select Power and sleep settings.
(3)  Fingerprint reader (select products only)	<p>Allows a fingerprint logon to Windows, instead of a password logon.</p> <ul style="list-style-type: none">■ Swipe down across the fingerprint reader. <p>IMPORTANT: To prevent fingerprint logon issues, make sure when you register your fingerprint that all sides of your finger are registered by the fingerprint reader.</p>

Special keys

Use the illustration and table to identify the special keys.



NOTE: Your computer might look slightly different from the illustration in this section.



NOTE: You can configure various keyboards. The features and keyboard layout might vary depending on the model.

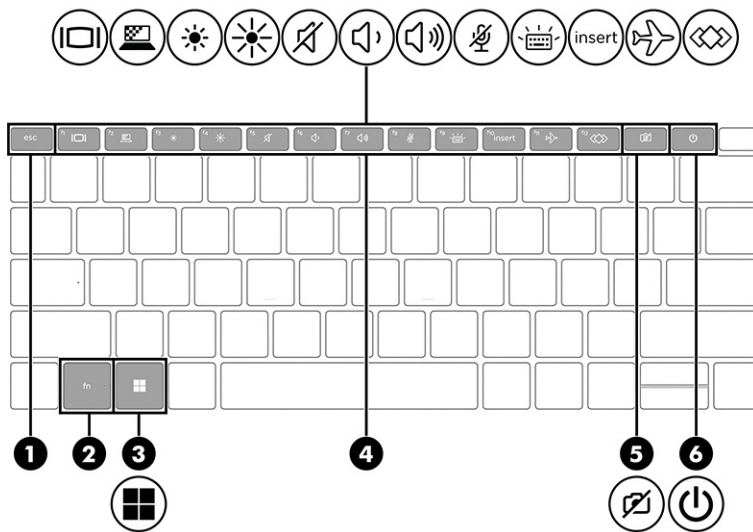

Table 2-7 Special keys and their descriptions





Component	Description
(1) <code>esc</code> key	Displays system information when pressed in combination with the <code>fn</code> key.
(2) <code>fn</code> key	Executes frequently used system functions when pressed in combination with another key. Such key combinations are called <i>hot keys</i> .
(3)  Windows key	Opens the Start menu. NOTE: Pressing the Windows key again will close the Start menu.
(4) Action keys	Execute frequently used system functions.
(5)  Camera privacy key	Turns the camera off and on.

Table 2-7 Special keys and their descriptions (continued)

Component	Description
(6)  Power button	<ul style="list-style-type: none"> • When the computer is off, press the button briefly to turn on the computer. • When the computer is on, press the button briefly to initiate Sleep. • When the computer is in the Sleep state, press the button briefly to exit Sleep (select products only). • When the computer is in Hibernation, press the button briefly to exit Hibernation. <p>IMPORTANT: Pressing and holding down the power button results in the loss of unsaved information.</p> <p>If the computer has stopped responding and shutdown procedures are ineffective, press and hold the power button for at least 4 seconds to turn off the computer.</p> <p>To learn more about your power settings, use the Power icon.</p> <ul style="list-style-type: none"> • Right-click the Power icon , and then select Power and sleep settings.

Bottom

Use the illustration and table to identify the bottom components.

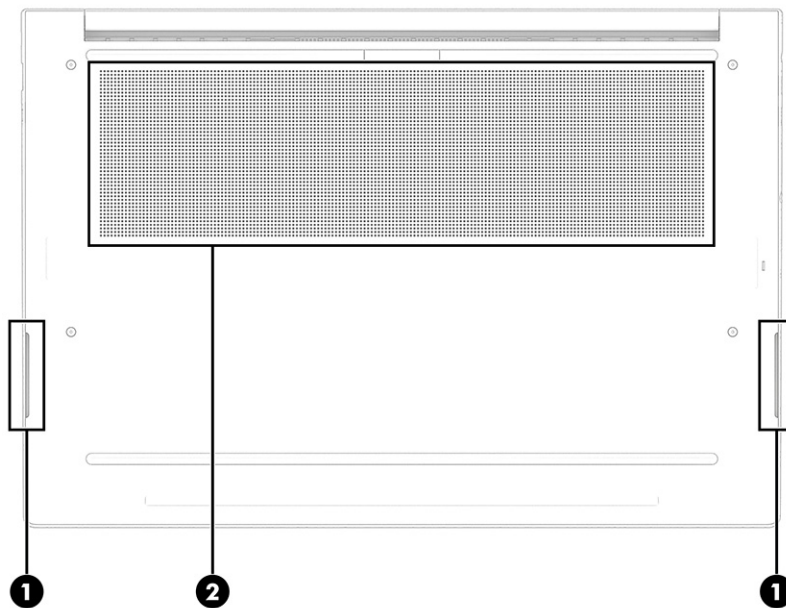

Table 2-8 Bottom components and their descriptions

Component	Description
(1) Speakers (2)	Produce sound.

Table 2-8 Bottom components and their descriptions (continued)

Component	Description
(2) Vent	Enables airflow to cool internal components. NOTE: The computer fan starts up automatically to cool internal components and prevent overheating. It is normal for the internal fan to cycle on and off during routine operation.

Labels

The labels affixed to the computer provide information that you might need when you troubleshoot system problems or travel internationally with the computer. Labels can be in paper form or imprinted on the product.

 **IMPORTANT:** Check the following locations for the labels described in this section: the bottom of the computer, inside the battery bay, under the service door, on the back of the display, or on the bottom of a tablet kickstand.

- Service label—Provides important information to identify your computer. When contacting support, you may be asked for the serial number, the product number, or the model number. Locate this information before you contact support.

Your service label will resemble one of the following examples. Refer to the illustration that most closely matches the service label on your computer.

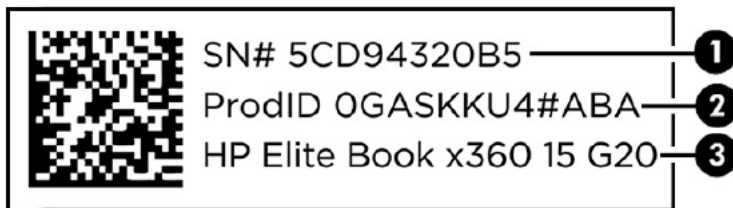

Table 2-9 Service label components and their descriptions

Component	Description
(1)	Serial number
(2)	Product ID
(3)	HP product name

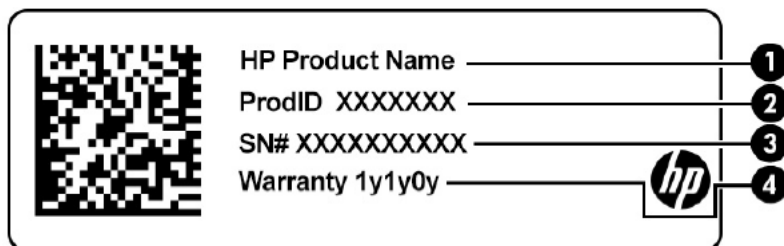

Table 2-10 Service label components and their descriptions

Component	
(1)	HP product name
(2)	Product ID
(3)	Serial number
(4)	Warranty period

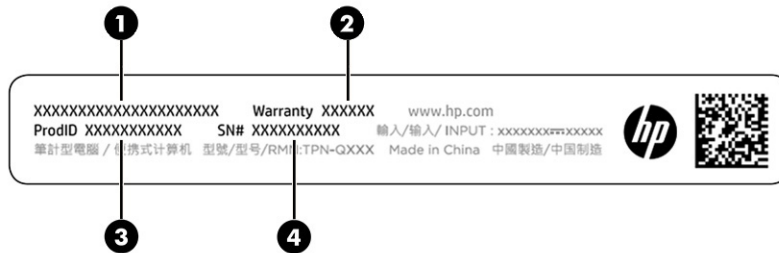

Table 2-11 Service label components and their descriptions

Component	
(1)	HP product name
(2)	Warranty period
(3)	Product ID
(4)	Serial number

- Regulatory labels—Provide regulatory information about the computer.
- Wireless certification labels—Provide information about optional wireless devices and the approval markings for the countries or regions in which the devices have been approved for use.

3 Illustrated parts catalog

Use this table to determine the spare parts that are available for the computer.

Computer major components

To identify the computer major components, use this illustration and table.

 **NOTE:** HP continually improves and changes product parts. For complete and current information about supported parts for your computer, go to <http://partsurfer.hp.com>, select your country or region, and then follow the on-screen instructions.

 **NOTE:** Details about your computer, including model, serial number, product key, and length of warranty, are on the service tag at the bottom of your computer.

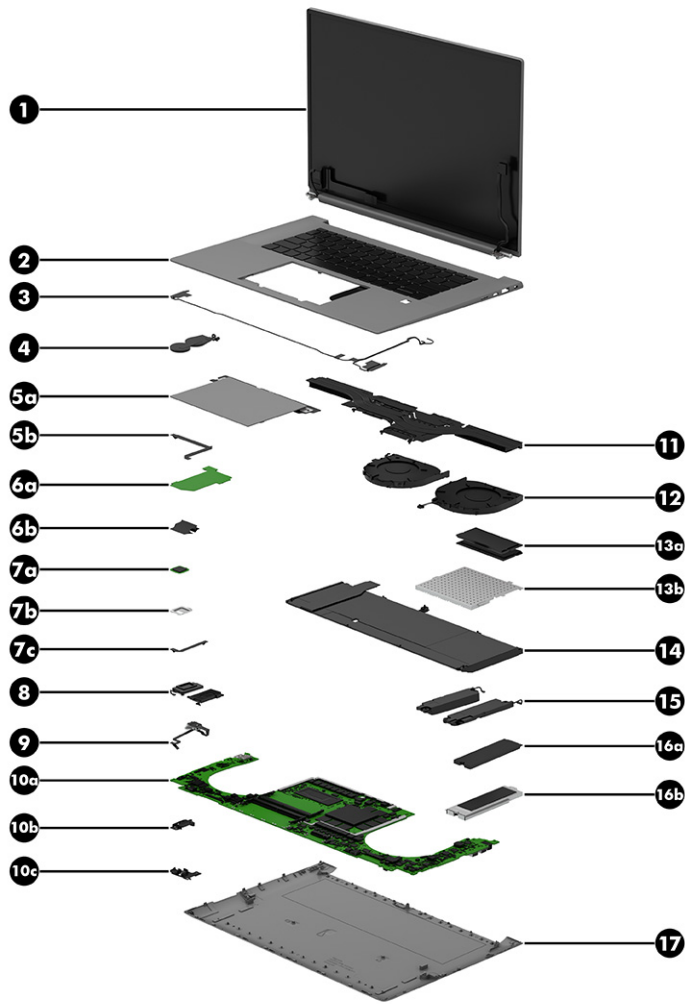

Table 3-1 Computer major component descriptions and part numbers

Item	Component	Spare part number
(1)	Display assembly: Display spare parts are available as subcomponents, not as whole units. Display subcomponent spare parts are available. For spare part information, see Display assembly subcomponents on page 25 .	
(2)	Top cover with keyboard with backlight and Z Command key for use with computer models equipped with an RGB webcam (includes backlight cable and keyboard cable; available only in France, Germany, the United Kingdom, and the United States)	N10946-xxx
	Top cover with keyboard with backlight for use with computer models equipped with an RGB webcam (includes backlight cable and keyboard cable)	N10945-xxx
	Top cover with keyboard with backlight (includes backlight cable and keyboard cable)	N10947-xxx
	For use in country or region:	Country code:
	For use in Belgium	-A41
	For use in Brazil	-201
	For use in Bulgaria	-261
	For use in the Czech Republic and Slovakia	-FL1
	For use in Denmark	-081

Table 3-1 Computer major component descriptions and part numbers (continued)

Item	Component	Spare part number
	For use in Denmark, Finland, and Norway	-DH1
	For use in France	-051
	For use in French Canada	-DB1
	For use in Germany	-041
	For use in Greece	-151
	For use in Hungary	-211
	For use in Iceland	-DD1
	For use in India	-D61
	For use in Israel	-BB1
	For use in Italy	-061
	For use in Kazakhstan	-DF1
	For use in Latin America	-161
	For use in the Netherlands	-B31
	For use in Northwest Africa	-FP1
	For use in Norway	-091
	For use in Portugal	-131
	For use in Romania	-271
	For use in Russia	-251
	For use in Saudi Arabia	-171
	For use in Slovenia	-BA1
	For use in South Korea	-AD1
	For use in Spain	-071
	For use in Sweden and Finland	-B71
	For use in Switzerland	-BG1
	For use in Taiwan	-AB1
	For use in Thailand	-281
	For use in Turkey	-141
	For use in Turkey F	-541
	For use in Ukraine	-BD1
	For use in the United Kingdom	-031
	For use in the United States	-001
(3)	Wireless antenna (includes main antenna and auxiliary antenna cables, transceivers, and double-sided adhesive)	N10931-001
(4)	RTC battery (includes cable and double-sided adhesive)	N10921-001

Table 3-1 Computer major component descriptions and part numbers (continued)

Item	Component	Spare part number
(5a)	Touchpad	N10923-001
	NOTE: The touchpad spare part kit does not include the touchpad cable. The touchpad cable is included in the Cable Kit, spare part number N10935-001.	
(5b)	Touchpad cable (included in the Cable Kit, spare part number N10935-001)	
(6a)	Transfer board (includes double-sided adhesive)	N10919-001
	NOTE: The transfer board spare part kit does not include the transfer board cable. The transfer board cable is included in the Cable Kit, spare part number N10935-001.	
(6b)	Transfer board cable (included in the Cable Kit, spare part number N10935-001)	
(7a)	Fingerprint reader	N10920-001
	NOTE: The fingerprint reader spare part kit does not include the fingerprint reader bracket or the fingerprint reader cable. The fingerprint reader bracket is included in the Bracket Kit, spare part number N10940-001. The fingerprint reader cable is included in the Cable Kit, spare part number N10935-001.	
(7b)	Fingerprint reader bracket (included in the Bracket Kit, spare part number N10940-001)	
(7c)	Fingerprint reader cable (included in the Cable Kit, spare part number N10935-001)	
(8)	Top speakers (included in the Speaker Kit, spare part number N51007-001; includes left and right top speakers, left and right bottom speakers, cables, and 4 rubber isolators)	
(9)	Audio jack (includes cable)	N10939-001
(10a)	System board (includes integrated processor and replacement thermal material):	
	Equipped with an Intel i9-13900HK processor, an NVIDIA® RTX® A4X graphics controller with 12 GB of discrete memory, and the Windows 11 operating system	N51000-601
	Equipped with an Intel i9-13900HK processor, an NVIDIA RTX A4X graphics controller with 12 GB of discrete memory, and a non-Windows operating system	N51000-001
	Equipped with an Intel i9-13900H processor, an NVIDIA RTX A4X graphics controller with 12 GB of discrete memory, and the Windows 11 operating system	N51001-601
	Equipped with an Intel i9-13900H processor, an NVIDIA RTX A4X graphics controller with 12 GB of discrete memory, and a non-Windows operating system	N51001-001
	Equipped with an Intel i9-13900HK processor, an NVIDIA RTX 4080 graphics controller with 12 GB of discrete memory, and the Windows 11 operating system	N50998-601
	Equipped with an Intel i9-13900HK processor, an NVIDIA RTX 4080 graphics controller with 12 GB of discrete memory, and a non-Windows operating system	N50998-001
	Equipped with an Intel i9-13900H processor, an NVIDIA RTX 4080 graphics controller with 12 GB of discrete memory, and the Windows 11 operating system	N50999-601
	Equipped with an Intel i9-13900H processor, an NVIDIA RTX 4080 graphics controller with 12 GB of discrete memory, and a non-Windows operating system	N50999-001
	Equipped with an Intel i9-13900HK processor, an NVIDIA RTX A3X graphics controller with 8 GB of discrete memory, and the Windows 11 operating system	N50992-601
	Equipped with an Intel i9-13900HK processor, an NVIDIA RTX A3X graphics controller with 8 GB of discrete memory, and a non-Windows operating system	N50992-001
	Equipped with an Intel i9-13900H processor, an NVIDIA RTX A3X graphics controller with 8 GB of discrete memory, and the Windows 11 operating system	N50993-601

Table 3-1 Computer major component descriptions and part numbers (continued)

Item	Component	Spare part number
	Equipped with an Intel i9-13900H processor, an NVIDIA RTX A3X graphics controller with 8 GB of discrete memory, and a non-Windows operating system	N50993-001
	Equipped with an Intel i9-13900HK processor, an NVIDIA RTX A2X graphics controller with 8 GB of discrete memory, and the Windows 11 operating system	N50988-601
	Equipped with an Intel i9-13900HK processor, an NVIDIA RTX A2X graphics controller with 8 GB of discrete memory, and a non-Windows operating system	N50988-001
	Equipped with an Intel i9-13900H processor, an NVIDIA RTX A2X graphics controller with 8 GB of discrete memory, and the Windows 11 operating system	N50989-601
	Equipped with an Intel i9-13900H processor, an NVIDIA RTX A2X graphics controller with 8 GB of discrete memory, and a non-Windows operating system	N50989-001
	Equipped with an Intel i9-13900HK processor, an NVIDIA RTX 4070 graphics controller with 8 GB of discrete memory, and the Windows 11 operating system	N50996-601
	Equipped with an Intel i9-13900HK processor, an NVIDIA RTX 4070 graphics controller with 8 GB of discrete memory, and a non-Windows operating system	N50996-001
	Equipped with an Intel i9-13900H processor, an NVIDIA RTX 4070 graphics controller with 8 GB of discrete memory, and the Windows 11 operating system	N50997-601
	Equipped with an Intel i9-13900H processor, an NVIDIA RTX 4070 graphics controller with 8 GB of discrete memory, and a non-Windows operating system	N50997-001
	Equipped with an Intel i9-13900HK processor, an NVIDIA RTX A1X graphics controller with 6 GB of discrete memory, and the Windows 11 operating system	N50984-601
	Equipped with an Intel i9-13900HK processor, an NVIDIA RTX A1X graphics controller with 6 GB of discrete memory, and a non-Windows operating system	N50984-001
	Equipped with an Intel i9-13900H processor, an NVIDIA RTX A1X graphics controller with 6 GB of discrete memory, and the Windows 11 operating system	N50985-601
	Equipped with an Intel i9-13900H processor, an NVIDIA RTX A1X graphics controller with 6 GB of discrete memory, and a non-Windows operating system	N50985-001
	Equipped with an Intel i7-13800H processor, an NVIDIA RTX A4X graphics controller with 12 GB of discrete memory, and the Windows 11 operating system	N50995-601
	Equipped with an Intel i7-13800H processor, an NVIDIA RTX A4X graphics controller with 12 GB of discrete memory, and a non-Windows operating system	N50995-001
	Equipped with an Intel i7-13800H processor, an NVIDIA RTX 4080 graphics controller with 12 GB of discrete memory, and the Windows 11 operating system	N50980-601
	Equipped with an Intel i7-13800H processor, an NVIDIA RTX 4080 graphics controller with 12 GB of discrete memory, and a non-Windows operating system	N50980-001
	Equipped with an Intel i7-13800H processor, an NVIDIA RTX A3X graphics controller with 8 GB of discrete memory, and the Windows 11 operating system	N50991-601
	Equipped with an Intel i7-13800H processor, an NVIDIA RTX A3X graphics controller with 8 GB of discrete memory, and a non-Windows operating system	N50991-001
	Equipped with an Intel i7-13800H processor, an NVIDIA RTX A2X graphics controller with 8 GB of discrete memory, and the Windows 11 operating system	N50987-601
	Equipped with an Intel i7-13800H processor, an NVIDIA RTX A2X graphics controller with 8 GB of discrete memory, and a non-Windows operating system	N50987-001
	Equipped with an Intel i7-13800H processor, an NVIDIA RTX 4070 graphics controller with 8 GB of discrete memory, and the Windows 11 operating system	N50978-601

Table 3-1 Computer major component descriptions and part numbers (continued)

Item	Component	Spare part number
	Equipped with an Intel i7-13800H processor, an NVIDIA RTX 4070 graphics controller with 8 GB of discrete memory, and a non-Windows operating system	N50978-001
	Equipped with an Intel i7-13800H processor, an NVIDIA RTX A1X graphics controller with 6 GB of discrete memory, and the Windows 11 operating system	N50983-601
	Equipped with an Intel i7-13800H processor, an NVIDIA RTX A1X graphics controller with 6 GB of discrete memory, and a non-Windows operating system	N50983-001
	Equipped with an Intel i7-13700H processor, an NVIDIA RTX A4X graphics controller with 12 GB of discrete memory, and the Windows 11 operating system	N50994-601
	Equipped with an Intel i7-13700H processor, an NVIDIA RTX A4X graphics controller with 12 GB of discrete memory, and a non-Windows operating system	N50994-001
	Equipped with an Intel i7-13700H processor, an NVIDIA RTX 4080 graphics controller with 12 GB of discrete memory, and the Windows 11 operating system	N50979-601
	Equipped with an Intel i7-13700H processor, an NVIDIA RTX 4080 graphics controller with 12 GB of discrete memory, and a non-Windows operating system	N50979-001
	Equipped with an Intel i7-13700H processor, an NVIDIA RTX A3X graphics controller with 8 GB of discrete memory, and the Windows 11 operating system	N50990-601
	Equipped with an Intel i7-13700H processor, an NVIDIA RTX A3X graphics controller with 8 GB of discrete memory, and a non-Windows operating system	N50990-001
	Equipped with an Intel i7-13700H processor, an NVIDIA RTX A2X graphics controller with 8 GB of discrete memory, and the Windows 11 operating system	N50986-601
	Equipped with an Intel i7-13700H processor, an NVIDIA RTX A2X graphics controller with 8 GB of discrete memory, and a non-Windows operating system	N50986-001
	Equipped with an Intel i7-13700H processor, an NVIDIA RTX 4070 graphics controller with 8 GB of discrete memory, and the Windows 11 operating system	N50977-601
	Equipped with an Intel i7-13700H processor, an NVIDIA RTX 4070 graphics controller with 8 GB of discrete memory, and a non-Windows operating system	N50977-001
	Equipped with an Intel i7-13700H processor, an NVIDIA RTX A1X graphics controller with 6 GB of discrete memory, and the Windows 11 operating system	N50982-601
	Equipped with an Intel i7-13700H processor, an NVIDIA RTX A1X graphics controller with 6 GB of discrete memory, and a non-Windows operating system	N50982-001
	Equipped with an Intel i5-13600H processor, an NVIDIA RTX A1X graphics controller with 6 GB of discrete memory, and the Windows 11 operating system	N50981-601
	Equipped with an Intel i7-13800H processor, a graphics subsystem with UMA memory, and the Windows 11 operating system	N51004-601
	Equipped with an Intel i7-13800H processor, a graphics subsystem with UMA memory, and a non-Windows operating system	N51004-001
	Equipped with an Intel i7-13700H processor, a graphics subsystem with UMA memory, and the Windows 11 operating system	N51003-601
	Equipped with an Intel i7-13700H processor, a graphics subsystem with UMA memory, and a non-Windows operating system	N51003-001
	Equipped with an Intel i5-13600H processor, a graphics subsystem with UMA memory, and the Windows 11 operating system	N51004-601
	Equipped with an Intel i5-13600H processor, a graphics subsystem with UMA memory, and a non-Windows operating system	N51004-001

Table 3-1 Computer major component descriptions and part numbers (continued)

Item	Component	Spare part number
	System Board Repair Kit (not illustrated)	N56255-888
(11)	Heat sink (includes captive screws and replacement thermal material):	
	For use with system boards equipped with a graphics subsystem with discrete memory and an Intel i-9 or Intel i-8 processor	N10927-001
	For use with system boards equipped with a graphics subsystem with discrete memory and an Intel i-7 or Intel i-6 processor	N51005-001
	For use with system boards equipped with a graphics subsystem with UMA memory	N10925-001
(12)	Fan Kit (includes left and right fans, captive screws, and cables)	N10924-001
(13a)	Memory modules (2, SODIMM, DDR5-5600, 1.1 V, NECC):	
	32 GB	N51121-001
	16 GB	N38627-001
	8 GB	N37792-002
	Memory modules (2, SODIMM, DDR5-4800, 1.1 V, NECC):	
	32 GB	N19982-001
	16 GB	M97596-002
	8 GB	M97595-002
(13b)	Memory module shield (included in the Shield Kit, spare part number N10942-001)	
(14)	Battery (6 cell, 86 Whr, Li-ion)	M82230-005
(15)	Bottom speakers (included in the Speaker Kit, spare part number N51007-001; includes left and right top speakers, left and right bottom speakers, cables, and 4 rubber isolators)	
(16a)	Solid-state drive:	
	4 TB, M.2 2280, PCIe-4×4, NVMe, dual-sided solid-state drive with TLC	N06219-002
	2 TB, M.2 2280, PCIe-4×4, NVMe solid-state drive with TLC	M52027-002
	1 TB, M.2 2280, PCIe-4×4, NVMe solid-state drive with TLC	M16560-002
	1 TB, M.2 2280, PCIe-4×4, NVMe, self-encrypting solid-state drive with TLC	N23415-002
	512 GB, M.2 2280, PCIe-4×4, NVMe solid-state drive with TLC	M17436-002
	512 GB, M.2 2280, PCIe-4×4, self-encrypting solid-state drive with TLC	M52031-002
(16b)	Solid-state drive shield (included in the Shield Kit, spare part number N10942-001)	
(17)	Bottom cover (includes rubber feet)	N51006-001

Display assembly subcomponents

To identify the display assembly subcomponents, use this illustration and table.

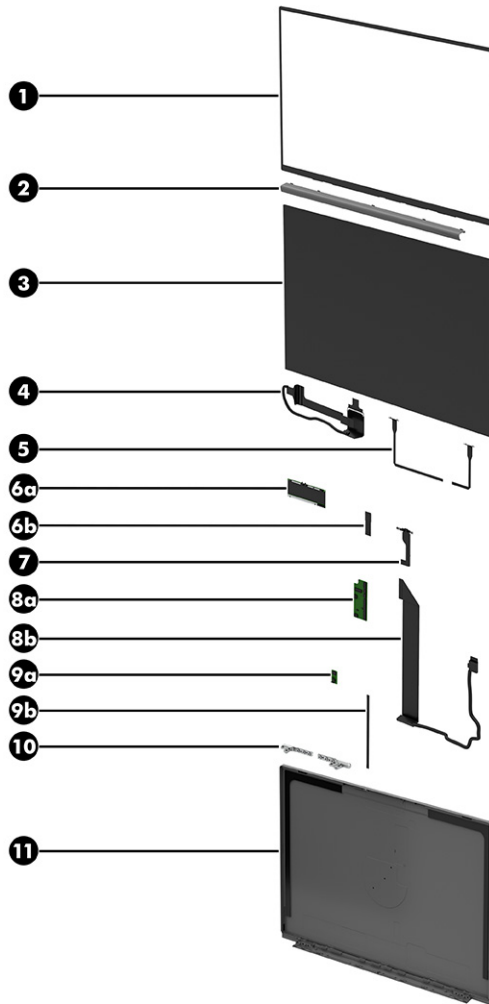

Table 3-2 Display component descriptions and part numbers

Item	Component	Spare part number
(1)	Display bezel	N10930-001
	Display Adhesive Kit (not illustrated)	N10938-001
(2)	Hinge cover	N10937-001
(3)	Display panel assembly:	
	40.6 cm (16.0 in), DreamColor, WQUXGA, antiglare, LED, UWVA, nTOP display panel assembly; typical brightness: 500 nits	N51321-001
	40.6 cm (16.0 in), OLED, WQUXGA, brightview, UWVA, TOP display panel assembly; typical brightness: 400 nits	N51322-001
	40.6 cm (16.0 in), OLED, WQUXGA, antiglare, UWVA, TOP display panel assembly; typical brightness: 400 nits	N10910-001
(4)	Display panel cable	N10933-001
(5)	Microphone Kit (includes left and right microphones, cables, and double-sided adhesive)	N10936-001
(6a)	Webcam (includes double-sided adhesive)	N51318-001

Table 3-2 Display component descriptions and part numbers (continued)

Item	Component	Spare part number
(6b)	Webcam cable (includes double-sided adhesive)	N10934-001
(7)	ALS board (includes double-sided adhesive)	N10915-001
(8a)	Sensor board (includes double-sided adhesive)	N10917-001
(8b)	Sensor board cable (includes double-sided adhesive)	N13578-001
(9a)	Motion board (includes double-sided adhesive)	N10918-001
(9b)	Motion board cable (included in the Display Cable Kit, spare part number N10933-001; includes double-sided adhesive)	
(10)	Display Hinge Kit (includes left and right hinges)	N10932-001
(11)	Display back cover	N54630-001

Miscellaneous parts

To identify the miscellaneous parts, use this table.

Table 3-3 Miscellaneous part descriptions and part numbers

Component	Spare part number
AC adapters	
280 W AC adapter (PFC, 3 pin, 7.4 mm barrel, slim)	M52952-001
200 W HP Smart AC adapter (PFC, 4.5 mm barrel)	L00895-003
200 W AC adapter (PFC, RC, 3 pin, 4.5 mm barrel)	L74881-001
150 W HP Smart (PFC, 4.5 mm barrel, slim)	L32661-001
Adapter:	
HP USB Type-C-to-DisplayPort adapter	831753-001
HP USB Type-C-to-HDMI 2.0 adapter	935325-001
HP USB Type-C-to-RJ45 adapter	M95985-001
HP USB Type-C-to-RJ45 adapter, FD	918779-001
HP USB Type-C-to-VGA adapter	831751-001
HP executive 16 in laptop backpack	N19979-001
HP Thunderbolt 4 280 W cable (0.8 m [2.6 ft])	M88059-001
HP G4 dock (280 W, with combination cable)	M97106-001
Duckhead adapter for use in Japan	L33517-001
Insulator Kit (includes insulators for the motion board, sensor board, top cover with keyboard, transfer board, and webcam)	N51320-001
HP USB keyboard for use in the United States	L95712-001
HP nano lock	918431-001
HP Sure Key cable lock	L65088-001

Table 3-3 Miscellaneous part descriptions and part numbers (continued)

Component	Spare part number
Mouse:	
HP 128 laser wired mouse	M27885-001
HP Bluetooth travel mouse	L62043-001
HP USB mouse	L95713-001
HP USB External DV D+-RW Drive	747080-001
Plastics Kit (includes fingerprint reader foil, fingerprint reader insert, memory module thermal pads, SD card insert, webcam holder, and WLAN antenna cover)	N51319-001
Power cord (C13, 1.8 m [6.0 ft], high frequency (HF), conventional with tag):	
For use in Denmark	M54992-001
For use in Europe	M54990-001
For use in Switzerland	M54994-001
Power cord (C13, 1.8 m [6.0 ft], conventional with sticker):	
For use in Argentina	L82622-001
For use in Australia	L82623-001
For use in Japan	L82624-001
Power cord (C13, 1.0 m [3.3 ft], low wattage [LW], premium with tag):	
For use in Argentina	N24670-001
For use in Denmark	N24672-001
For use in Europe	N24669-001
For use in India	N24679-001
For use in Israel	N24678-001
For use in Japan	N24680-001
For use in North America	N24671-001
For use in the People's Republic of China	N24676-001
For use in the South Africa	N24674-001
For use in the South Korea	N24675-001
For use in Switzerland	N24673-001
For use in Taiwan	N24677-001
For use in Thailand	N51106-001
For use in the United Kingdom	N24668-001
Power cord (C13, 1.0 m [3.3 ft], premium with sticker) + AC adapter bundle for use in Thailand	M85413-001
Power cord (C13, 1.0 m [3.3 ft], premium with tag):	
For use in Argentina	N32029-001
For use in Brazil	N32030-001
For use in Italy	N32031-001

Table 3-3 Miscellaneous part descriptions and part numbers (continued)

Component	Spare part number
Power cord (C5, 1.0 m [3.3 ft], HF, conventional with sticker):	
For use in Denmark	M79264-001
For use in Europe	M79266-001
For use in Israel	M82712-001
For use in Switzerland	M79265-001
For use in the United Kingdom	M82711-001
Power cord (C5, 1.0 m [3.3 ft], HF, premium with sticker):	
For use in Denmark	N17810-001
For use in Europe	N17812-001
For use in Switzerland	N17811-001
Power cord (C5, 1.0 m [3.3 ft], conventional with tag):	
For use in Argentina	L31379-001
For use in Australia	L31380-001
For use in Brazil	L31381-001
For use in Denmark	L31382-001
For use in Europe	L31383-001
For use in India	L31385-001
For use in Israel	L31384-001
For use in Italy	L31386-001
For use in Japan	L31387-001
For use in North America	L31389-001
For use in the People's Republic of China	L31390-001
For use in the South Africa	L31391-001
For use in the South Korea	L31388-001
For use in Switzerland	L31392-001
For use in Taiwan	L31394-001
For use in Thailand	L31393-001
For use in the United Kingdom	L31395-001
Power cord (C5, 1.0 m [3.3 ft], premium with tag) for use in Brazil	L30770-001
Power cord (C5, 1.0 m [3.3 ft], conventional with tag) + AC adapter bundle for use in Thailand	M85422-001
Power cord (1.8 m [6.0 ft], black, 3-prong, DH):	
For use in Brazil	491683-202
For use in Denmark	491683-081
For use in Europe	491683-021

Table 3-3 Miscellaneous part descriptions and part numbers (continued)

Component	Spare part number
For use in India	491683-D61
For use in Israel	491683-BB1
For use in Italy	491683-061
For use in North America	491683-001
For use in the People's Republic of China	491683-AA1
For use in the South America	491683-L31
For use in the South Korea	491683-AD1
For use in Switzerland	491683-111
For use in Taiwan	491683-AB1
For use in Thailand	491683-201
For use in the United Kingdom	491683-031
Screw Kit	N10944-001

4 Removal and replacement procedures preliminary requirements

Use this information to properly prepare to disassemble and reassemble the computer.

Tools required

You need the following tools to complete the removal and replacement procedures:

- Tweezers
- Nonconductive, nonmarking pry tool
- Magnetic Phillips P1 screwdriver

Service considerations

The following sections include some of the considerations that you must keep in mind during disassembly and assembly procedures.

 **NOTE:** As you remove each subassembly from the computer, place the subassembly (and all accompanying screws) away from the work area to prevent damage.

Plastic parts

Using excessive force during disassembly and reassembly can damage plastic parts.

Cables and connectors

Handle cables with extreme care to avoid damage.

 **IMPORTANT:** When servicing the computer, be sure that cables are placed in their proper locations during the reassembly process. Improper cable placement can damage the computer.

Apply only the tension required to unseat or seat the cables during removal and insertion. Handle cables by the connector whenever possible. In all cases, avoid bending, twisting, or tearing cables. Be sure that cables are routed so that they cannot be caught or snagged as you remove or replace parts. Handle flex cables with extreme care; these cables tear easily.

Drive handling

Note the following guidelines when handling drives.

 **IMPORTANT:** Drives are fragile components. Handle them with care. To prevent damage to the computer, damage to a drive, or loss of information, observe these precautions:

- Before removing or inserting a hard drive, shut down the computer. If you are unsure whether the computer is off or in Hibernation, turn the computer on, and then shut it down through the operating system.
 - Before handling a drive, be sure that you are discharged of static electricity. While handling a drive, avoid touching the connector.
 - Before removing an optical drive, be sure that a disc is not in the drive, and be sure that the optical drive tray is closed.
 - Handle drives on surfaces covered with at least 2.54 cm (1 inch) of shock-proof foam.
 - Avoid dropping drives from any height onto any surface.
 - After removing a hard drive or an optical drive, place it in a static-proof bag.
 - Avoid exposing an internal hard drive to products that have magnetic fields, such as monitors or speakers.
 - Avoid exposing a drive to temperature extremes or liquids.
 - If a drive must be mailed, place the drive in a bubble pack mailer or other suitable form of protective packaging, and label the package “FRAGILE.”
-

Electrostatic discharge information

A sudden discharge of static electricity from your finger or other conductor can destroy static-sensitive devices or microcircuitry. Often the spark is neither felt nor heard, but damage occurs. An electronic device exposed to electrostatic discharge (ESD) might not appear to be affected at all and can work perfectly throughout a normal cycle. The device might function normally for a while, but it has been degraded in the internal layers, reducing its life expectancy.

Networks built into many integrated circuits provide some protection, but in many cases, the discharge contains enough power to alter device parameters or melt silicon junctions.

 **IMPORTANT:** To prevent damage to the device when you remove or install internal components, observe these precautions:

- Keep components in their electrostatic-safe containers until you are ready to install them.
 - Before touching an electronic component, discharge static electricity by using the guidelines described in [Personal grounding methods and equipment on page 33](#).
 - Avoid touching pins, leads, and circuitry. Handle electronic components as little as possible.
 - If you remove a component, place it in an electrostatic-safe container.
-

Generating static electricity

Follow these static electricity guidelines:

- Different activities generate different amounts of static electricity.
- Static electricity increases as humidity decreases.

Table 4-1 Static electricity occurrence based on activity and humidity

Event	Relative humidity		
	55%	40%	10%
Walking across carpet	7,500 V	15,000 V	35,000 V
Walking across vinyl floor	3,000 V	5,000 V	12,000 V
Motions of bench worker	400 V	800 V	6,000 V
Removing dual in-line packages (DIPs) from plastic tube	400 V	700 V	2,000 V
Removing DIPs from vinyl tray	2,000 V	4,000 V	11,500 V
Removing DIPs from polystyrene foam	3,500 V	5,000 V	14,500 V
Removing bubble pack from PCB (printed circuit board)	7,000 V	20,000 V	26,500 V
Packing PCBs in foam-lined box	5,000 V	11,000 V	21,000 V

Multiple electric components can be packaged together in plastic tubes, trays, or polystyrene foam.



NOTE: As little as 700 V of static electricity can degrade a product.

Preventing electrostatic damage to equipment

Many electronic components are sensitive to ESD. Circuitry design and structure determine the degree of sensitivity.

The following packaging and grounding precautions are necessary to prevent static electricity damage to electronic components:

- To avoid hand contact, transport products in static-safe containers such as tubes, bags, or boxes.
- Protect all electrostatic parts and assemblies with conductive or approved containers or packaging.
- Keep electrostatic-sensitive parts in their containers until they arrive at static-free stations.
- Place items on a grounded surface before removing them from their container.
- Always be properly grounded when touching a sensitive component or assembly.
- Avoid contact with pins, leads, or circuitry.
- Place reusable electrostatic-sensitive parts from assemblies in protective packaging or conductive foam.

Personal grounding methods and equipment

Using certain equipment can prevent static electricity damage to electronic components.

- **Wrist straps** are flexible straps with a maximum of $1\text{ M}\Omega \pm 10\%$ resistance in the ground cords. To provide proper ground, a strap must be worn snug against bare skin. The ground cord must be connected and fit snugly into the banana plug connector on the grounding mat or workstation.
- You can use **heel straps, toe straps, and boot straps** at standing workstations. These straps are compatible with most types of shoes or boots. On conductive floors or dissipative floor mats, use them on both feet with a maximum of $1\text{ M}\Omega \pm 10\%$ resistance between the operator and ground.

Table 4-2 Static shielding protection levels

Static shielding protection levels	
Method	Voltage
Antistatic plastic	1,500
Carbon-loaded plastic	7,500
Metallized laminate	15,000

Grounding the work area

To prevent static damage at the work area, follow these precautions:

- Cover the work surface with approved static-dissipative material.
- Use a wrist strap connected to a properly grounded work surface and use properly grounded tools and equipment.
- Use static-dissipative mats, foot straps, or air ionizers to give added protection.
- Handle electrostatic sensitive components, parts, and assemblies by the case or PCB laminate. Handle them only at static-free work areas.
- Turn off power and input signals before inserting and removing connectors or test equipment.
- Use fixtures made of static-safe materials when fixtures must directly contact dissipative surfaces.
- Keep the work area free of nonconductive materials, such as ordinary plastic assembly aids and polystyrene foam.
- Use conductive field service tools, such as cutters, screwdrivers, and vacuums.
- Avoid contact with pins, leads, or circuitry.

Recommended materials and equipment

HP recommends certain materials and equipment to prevent static electricity:

- Antistatic tape
- Antistatic smocks, aprons, or sleeve protectors
- Conductive bins and other assembly or soldering aids
- Conductive foam
- Conductive tabletop workstations with ground cord of $1\text{ M}\Omega \pm 10\%$ resistance
- Static-dissipative table or floor mats with hard tie to ground
- Field service kits
- Static awareness labels
- Wrist straps and footwear straps providing $1\text{ M}\Omega \pm 10\%$ resistance
- Material handling packages

- Conductive plastic bags
- Conductive plastic tubes
- Conductive tote boxes
- Opaque shielding bags
- Transparent metallized shielding bags
- Transparent shielding tubes

Cleaning your computer

Cleaning your computer regularly removes dirt and debris so that your device continues to operate at its best. Use the following information to safely clean the external surfaces of your computer.

Enabling HP Easy Clean (select products only)

HP Easy Clean helps you to avoid accidental input while you clean the computer surfaces. This software disables devices such as the keyboard, touch screen, and touchpad for a preset amount of time so that you can clean all computer surfaces.

1. Start HP Easy Clean in one of the following ways:
 - Select the **Start** menu, and then select **HP Easy Clean**.
- or -
 - Select the **HP Easy Clean** icon in the taskbar.
- or -
 - Select **Start**, and then select the **HP Easy Clean** tile.
2. Now that your device is disabled for a short period, see [Removing dirt and debris from your computer on page 35](#) for the recommended steps to clean the high-touch, external surfaces on your computer. After you remove the dirt and debris, you can also clean the surfaces with a disinfectant. See [Cleaning your computer with a disinfectant on page 36](#) for guidelines to help prevent the spread of harmful bacteria and viruses.

Removing dirt and debris from your computer

Here are the recommended steps to clean dirt and debris from your computer.

For computers with wood veneer, see [Caring for wood veneer \(select products only\) on page 37](#).

1. Wear disposable gloves made of latex (or nitrile gloves, if you are latex-sensitive) when cleaning the surfaces.
2. Turn off your device and unplug the power cord and other connected external devices. Remove any installed batteries from items such as wireless keyboards.

 **CAUTION:** To prevent electric shock or damage to components, never clean a product while it is turned on or plugged in.

3. Moisten a microfiber cloth with water. The cloth should be moist, but not dripping wet.

 **IMPORTANT:** To avoid damaging the surface, avoid abrasive cloths, towels, and paper towels.

4. Wipe the exterior of the product gently with the moistened cloth.

 **IMPORTANT:** Keep liquids away from the product. Avoid getting moisture in any openings. If liquid makes its way inside your HP product, it can cause damage to the product. Do not spray liquids directly on the product. Do not use aerosol sprays, solvents, abrasives, or cleaners containing hydrogen peroxide or bleach that might damage the finish.

5. Start with the display (if applicable). Wipe carefully in one direction, and move from the top of the display to the bottom. Finish with any flexible cables, like power cord, keyboard cable, and USB cables.
6. Be sure that surfaces have completely air-dried before turning the device on after cleaning.
7. Discard the gloves after each cleaning. Clean your hands immediately after you remove the gloves.

See [Cleaning your computer with a disinfectant on page 36](#) for recommended steps to clean the high-touch, external surfaces on your computer to help prevent the spread of harmful bacteria and viruses.

Cleaning your computer with a disinfectant

The World Health Organization (WHO) recommends cleaning surfaces, followed by disinfection, as a best practice for preventing the spread of viral respiratory illnesses and harmful bacteria.

After cleaning the external surfaces of your computer using the steps in [Removing dirt and debris from your computer on page 35](#), [Caring for wood veneer \(select products only\) on page 37](#), or both, you might also choose to clean the surfaces with a disinfectant. A disinfectant that is within HP's cleaning guidelines is an alcohol solution consisting of 70% isopropyl alcohol and 30% water. This solution is also known as rubbing alcohol and is sold in most stores.

Follow these steps when disinfecting high-touch, external surfaces on your computer:

1. Wear disposable gloves made of latex (or nitrile gloves, if you are latex-sensitive) when cleaning the surfaces.
2. Turn off your device and unplug the power cord and other connected external devices. Remove any installed batteries from items such as wireless keyboards.

 **CAUTION:** To prevent electric shock or damage to components, never clean a product while it is turned on or plugged in.

3. Moisten a microfiber cloth with a mixture of 70% isopropyl alcohol and 30% water. The cloth should be moist, but not dripping wet.

 **CAUTION:** Do not use any of the following chemicals or any solutions that contain them, including spray-based surface cleaners: bleach, peroxides (including hydrogen peroxide), acetone, ammonia, ethyl alcohol, methylene chloride, or any petroleum-based materials, such as gasoline, paint thinner, benzene, or toluene.

 **IMPORTANT:** To avoid damaging the surface, avoid abrasive cloths, towels, and paper towels.

4. Wipe the exterior of the product gently with the moistened cloth.

 **IMPORTANT:** Keep liquids away from the product. Avoid getting moisture in any openings. If liquid makes its way inside your HP product, it can cause damage to the product. Do not spray liquids directly on the product. Do not use aerosol sprays, solvents, abrasives, or cleaners containing hydrogen peroxide or bleach that might damage the finish.

5. Start with the display (if applicable). Wipe carefully in one direction, and move from the top of the display to the bottom. Finish with any flexible cables, like power cord, keyboard cable, and USB cables.
6. Be sure that surfaces have completely air-dried before turning the device on after cleaning.
7. Discard the gloves after each cleaning. Clean your hands immediately after you remove the gloves.

Caring for wood veneer (select products only)

Your product might feature high-quality wood veneer. As with all natural wood products, proper care is important for best results over the life of the product. Because of the nature of natural wood, you might see unique variations in the grain pattern or subtle variations in color, which are normal.

- Clean the wood with a dry, static-free microfiber cloth or chamois.
- Avoid cleaning products containing substances such as ammonia, methylene chloride, acetone, turpentine, or other petroleum-based solvents.
- Do not expose the wood to sun or moisture for long periods of time.
- If the wood becomes wet, dry it by dabbing with an absorbent, lint-free cloth.
- Avoid contact with any substance that might dye or discolor the wood.
- Avoid contact with sharp objects or rough surfaces that might scratch the wood.

See [Removing dirt and debris from your computer on page 35](#) for the recommended steps to clean the high-touch, external surfaces on your computer. After you remove the dirt and debris, you can also clean the surfaces with a disinfectant. See [Cleaning your computer with a disinfectant on page 36](#) for sanitizing guidelines to help prevent the spread of harmful bacteria and viruses.

Packaging and transporting guidelines

Follow these grounding guidelines when packaging and transporting equipment:

- To avoid hand contact, transport products in static-safe tubes, bags, or boxes.
- Protect ESD-sensitive parts and assemblies with conductive or approved containers or packaging.
- Keep ESD-sensitive parts in their containers until the parts arrive at static-free workstations.
- Place items on a grounded surface before removing items from their containers.
- Always be properly grounded when touching a component or assembly.
- Store reusable ESD-sensitive parts from assemblies in protective packaging or nonconductive foam.

- Use transporters and conveyors made of antistatic belts and roller bushings. Be sure that mechanized equipment used for moving materials is wired to ground and that proper materials are selected to avoid static charging. When grounding is not possible, use an ionizer to dissipate electric charges.

Accessing support information

To find the HP support that you need, use this information.

Table 4-3 Support information locations



Service consideration	Path to access information
Records of reported failure incidents stored on the computer	<p>Windows®:</p> <p>Preoperating system failures are logged in the BIOS Event Log. To view the BIOS Event Log:</p> <ol style="list-style-type: none"> 1. Press the power button. 2. Immediately and repeatedly press esc when the power button light turns white. <p>NOTE: If you do not press esc at the appropriate time, you must restart the computer and again repeatedly press esc when the power button light turns white to access the utility.</p> <ol style="list-style-type: none"> 3. Press f10 to enter the BIOS setup. 4. (On commercial products) Under the Main tab, select BIOS event log, and then select View BIOS Event Log. <p>- or -</p> <p>(On consumer products) Under the Main tab, select System Log.</p> <p>Post-operating system failures are logged in the Event Viewer.</p> <ol style="list-style-type: none"> 1. Turn on the computer and allow the operating system to open. 2. Select the search icon  in the taskbar. 3. Type <code>Event Viewer</code>, and then press enter. 4. Select the log from the left panel. Details display in the right panel. <p>Chrome™:</p> <ol style="list-style-type: none"> 1. Go to support.google.com/chrome. 2. Search <code>collect Chrome device logs</code>.
Technical bulletins	<p>To locate technical bulletins:</p> <ol style="list-style-type: none"> 1. Go to www.hp.com. 2. Place the cursor over Problem solving to display more options. 3. Select Support & Troubleshooting. 4. Type the serial number, product number, or product name to go to the product support page. 5. Select Advisories to view technical bulletins.

Table 4-3 Support information locations (continued)

Service consideration	Path to access information
Repair professionals	To locate repair professionals: <ol style="list-style-type: none"><li data-bbox="703 312 932 333">1. Go to www.hp.com.<li data-bbox="703 361 1362 382">2. Place the cursor over Support resources to display more options.<li data-bbox="703 409 1091 430">3. Select Authorized service providers.
Component and diagnosis information, failure detection, and required action	To locate diagnosis information and actions: <ol style="list-style-type: none"><li data-bbox="703 512 1203 533">1. Go to http://www.hp.com/go/techcenter/pcdiags.<li data-bbox="703 560 932 581">2. Select Get Support.<li data-bbox="703 609 1445 653">3. Near the bottom of the window, select Notebook PCs, and then select your location.

5 Removal and replacement procedures for authorized service provider parts

This chapter provides removal and replacement procedures for authorized service provider parts.

 **IMPORTANT:** Only an authorized service provider should access the components described in this chapter. Accessing these parts can damage the computer or void the warranty.

 **NOTE:** Details about your computer, including model, serial number, product key, and length of warranty, are on the service tag at the bottom of your computer.

Component replacement procedures

To remove and replace computer components, use these procedures.

 **NOTE:** HP continually improves and changes product parts. For complete and current information about supported parts for your computer, go to <http://partsurfer.hp.com>, select your country or region, and then follow the on-screen instructions.

You must remove, replace, or loosen as many as 65 screws when you service the parts described in this chapter. Make special note of each screw size and location during removal and replacement.

Preparation for disassembly

To remove and replace computer components, use these procedures.

See [Removal and replacement procedures preliminary requirements on page 31](#) for initial safety procedures.

1. Turn off the computer. If you are unsure whether the computer is off or in Hibernation, turn the computer on, and then shut it down through the operating system.
2. Disconnect the power from the computer by unplugging the power cord from the computer.
3. Disconnect all external devices from the computer.

Bottom cover

To remove the bottom cover, use this procedure and illustration.

Table 5-1 Bottom cover description and part number

Description	Spare part number
Bottom cover (includes rubber feet)	N51006-001

Before removing the bottom cover, prepare the computer for disassembly (see [Preparation for disassembly on page 40](#)).

Remove the bottom cover:

1. Position the computer upside down with the front toward you.
2. Slide the screw cover **(1)** to the left, and then rotate the screw cover clockwise **(2)** until the screw is accessible.
3. Loosen the five Torx5 captive screws **(3)** that secure the bottom cover to the computer.

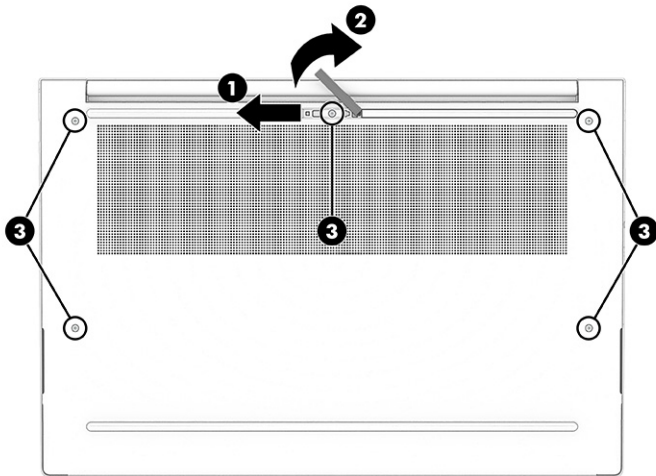

4. Use a nonmarking, nonconductive tool **(1)** to separate the rear edge of the bottom cover **(2)** from the computer.

- Remove the bottom cover (3) from the computer.

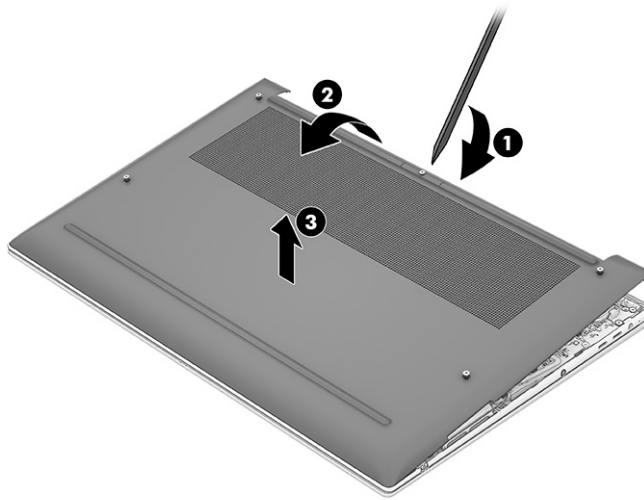

- Inspect the thermal pad on the surfaces of the solid-state drive shield and the bottom cover each time the bottom cover is removed. If the thermal pad is torn, missing part of the pad, or dirty, thoroughly clean the thermal pad from the surfaces of the solid-state drive shield and the bottom cover. The following illustration shows the replacement thermal pad locations.

A thermal pad is used on the solid-state drive shield (1) and the bottom cover area (2) that services it.

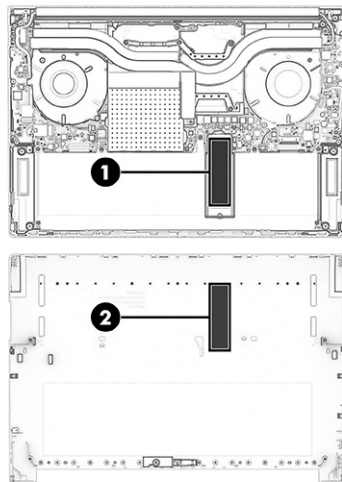

To install the bottom cover, reverse the removal procedure.

Solid-state drive

To remove the solid-state drive, use this procedure and illustration.

Table 5-2 Solid-state drive descriptions and part numbers

Description	Spare part number
4 TB, M.2 2280, PCIe-4x4, NVMe, dual-sided solid-state drive with TLC	N06219-002

Table 5-2 Solid-state drive descriptions and part numbers (continued)

Description	Spare part number
2 TB, M.2 2280, PCIe-4×4, NVMe solid-state drive with TLC	M52027-002
1 TB, M.2 2280, PCIe-4×4, NVMe solid-state drive with TLC	M16560-002
1 TB, M.2 2280, PCIe-4×4, NVMe, SED solid-state drive with TLC	N23415-002
512 GB, M.2 2280, PCIe-4×4, NVMe solid-state drive with TLC	M17436-002
512 GB, M.2 2280, PCIe-4×4, SED solid-state drive with TLC	M52031-002

Before removing the solid-state drive, follow these steps:

1. Prepare the computer for disassembly (see [Preparation for disassembly on page 40](#)).
2. Remove the bottom cover (see [Bottom cover on page 40](#)).

Remove the solid-state drive:

1. Disconnect the battery cable from the system board.

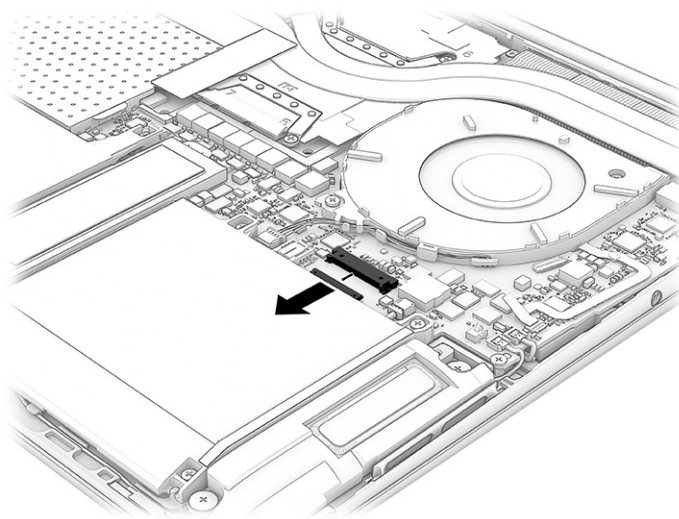

2. Remove the two Phillips M2.0 × 3.2 screw **(1)** that secures the solid-state drive and solid-state drive shield to the system board.
3. Lift and remove the solid-state drive shield **(2)**.

The solid-state drive shield is included in the Shield Kit, spare part number N10942-001.

4. Remove the solid-state drive (3) by pulling the drive away from the slot at an angle.

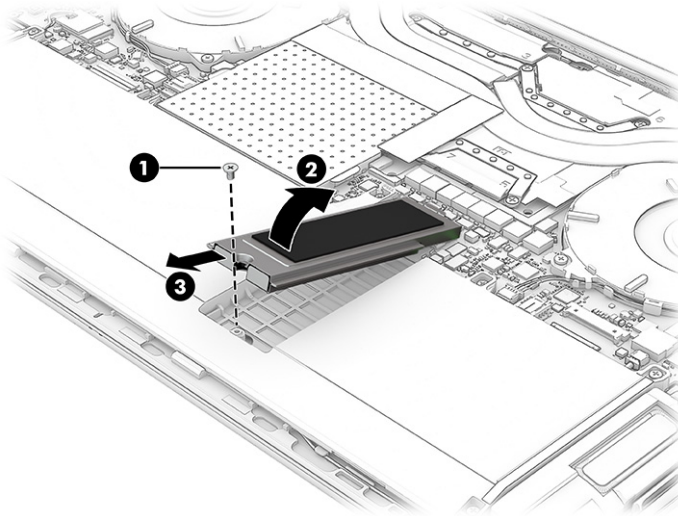

5. Inspect the thermal pad on the surfaces of the solid-state drive and the solid-state drive shield each time the shield is removed. If the thermal pad is torn, missing part of the pad, or dirty, thoroughly clean the thermal pad from the surfaces of the solid-state drive and solid-state drive shield. The following illustration shows the replacement thermal pad locations. The following illustration shows the replacement thermal pad locations.

A thermal pad is used on the solid-state drive (1) and on the solid-state drive shield area (2) that services it.

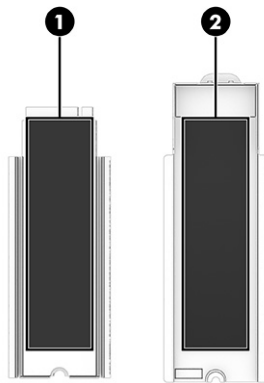

To install the solid-state drive, reverse the removal procedure.

 **NOTE:** Solid-state drives are designed with a notch to prevent incorrect insertion.

Bottom speakers

To remove the bottom speakers, use this procedure and illustration.

Table 5-3 Bottom speakers description and part number

Description	Spare part number
Bottom speakers (included in the Speaker Kit, spare part number N51007-001; includes left and right top speakers, left and right bottom speakers, cables, and 4 rubber isolators)	

Before removing the bottom speakers, follow these steps:

1. Prepare the computer for disassembly (see [Preparation for disassembly on page 40](#)).
2. Remove the bottom cover (see [Bottom cover on page 40](#)).

Remove the bottom speakers:

1. Disconnect the battery cable from the system board.

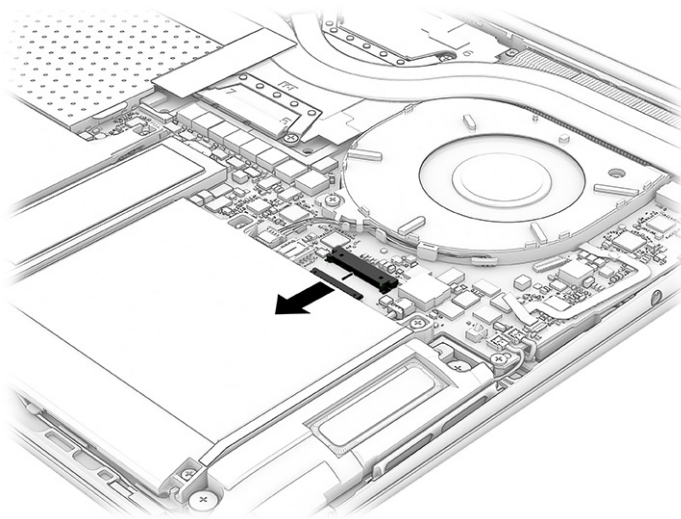

2. Disconnect the bottom speaker cables **(1)** from the system board.
3. Remove the four Phillips M2.0 × 2.4 broadhead screws **(2)** that secure the bottom speakers to the computer.
4. Remove the bottom speakers **(3)** from the computer.

When removing the bottom speakers, make note of the location of the four rubber isolator locations **(4)**. The absence of or damage to these isolators can result in degraded speaker performance.

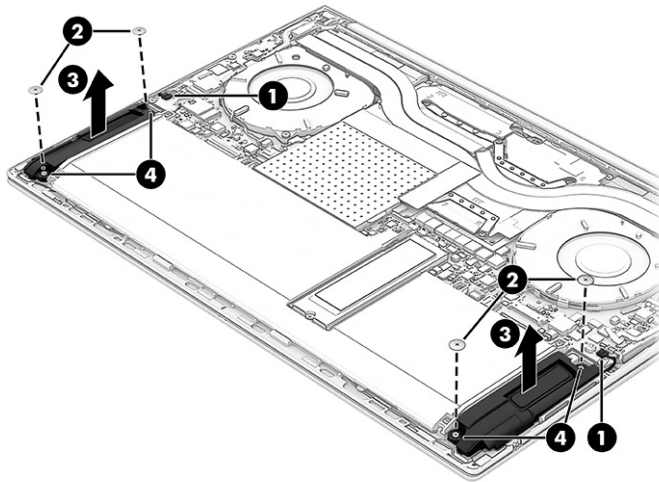

To install the bottom speakers, reverse the removal procedure.

Battery

To remove the battery, use this procedure and illustration.

Table 5-4 Battery description and part number

Description	Spare part number
Battery (6 cell, 86 Whr, Li-ion)	M82230-005

⚠ WARNING! To avoid personal injury and damage to the product:

- Do *not* puncture, twist, or crack the battery.
- Do *not* cause an external puncture or rupture to the battery. They can cause a short inside the battery, which can result in battery thermal runaway.
- Do *not* handle or touch the battery enclosure with sharp objects such as tweezers or pliers, which might puncture the battery.
- Do *not* compress or squeeze the battery case with tools or heavy objects stacked on top of the case. These actions can apply undue force on the battery.
- Do *not* touch the connectors with any metallic surface or object, such as metal tools, screws, or coins, which can cause shorting across the connectors.

Before removing the battery, follow these steps:

1. Prepare the computer for disassembly (see [Preparation for disassembly on page 40](#)).
2. Remove the bottom cover (see [Bottom cover on page 40](#)).

⚠ WARNING! To reduce potential safety issues, use only the user-replaceable battery provided with the computer, a replacement battery provided by HP, or a compatible battery purchased from HP.

 **IMPORTANT:** Removing a battery that is the sole power source for the computer can cause loss of information. To prevent loss of information, save your work or shut down the computer through Windows before you remove the battery.

Remove the battery:

1. Loosen the seven Phillips captive screws (1) that secure the battery to the computer.
2. Swing the rear edge of the battery (2) up and forward until it rests at an angle.
3. Remove the battery (3) by sliding it up and back at an angle.

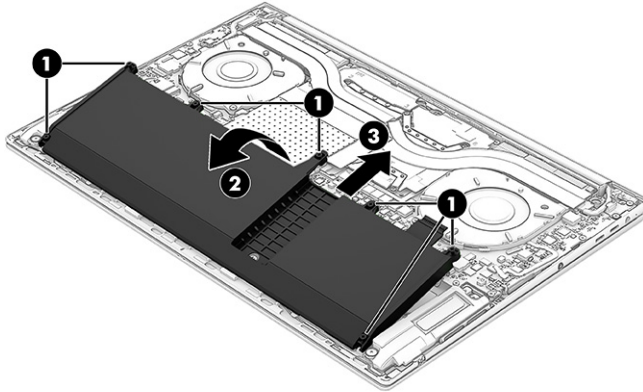

To insert the battery, reverse the removal procedure.

Memory modules

To remove the memory modules, use this procedure and illustration.

Table 5-5 Memory module descriptions and part numbers

Description	Spare part number
Memory modules (2, SODIMM, DDR5-5600, 1.1 V, NECC):	
32 GB	N51121-001
16 GB	N38627-001
8 GB	N37792-002
Memory modules (2, SODIMM, DDR5-4800, 1.1 V, NECC):	
32 GB	N19982-001
16 GB	M97596-002
8 GB	M97595-002
Memory module shield (included in the Shield Kit, spare part number N10942-001)	

Before removing the memory modules, follow these steps:

1. Prepare the computer for disassembly (see [Preparation for disassembly on page 40](#)).
2. Remove the bottom cover (see [Bottom cover on page 40](#)).

3. Remove the battery (see [Battery on page 46](#)).

If you are replacing a memory module, remove the existing memory module:

1. Release the tape (1) that secures the memory module shield to the heat sink.
2. Lift and remove the memory module shield (2) from the system board.

The memory module shield is included in the Shield Kit, spare part number N10942-001.

When installing the memory module shield, be sure that the edges of the shield fit into all the clips that are built into the system board.

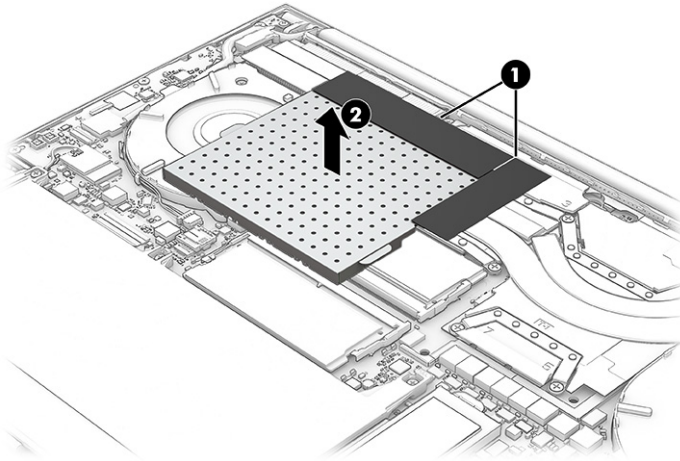

3. Spread the two retention clips outward (1) until the memory module tilts up at a 45° angle, and then remove the module (2). Use the same procedure to remove all memory modules.

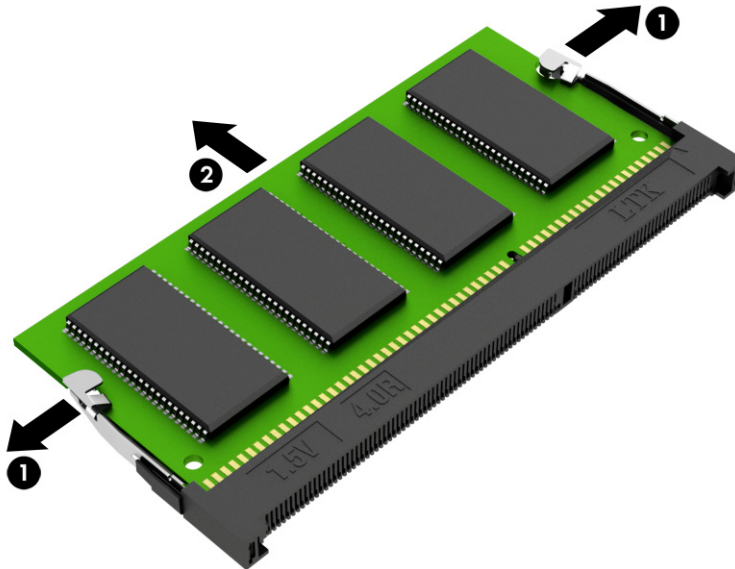

To install a memory module, reverse the removal procedure.



NOTE: Memory modules are designed with a notch to prevent incorrect insertion.

Fans

To remove the fans, use this procedure and illustration.

Table 5-6 Fans description and part number

Description	Spare part number
Fan Kit (includes left and right fans, captive screws, and cables)	N10924-001

Before removing the fans, follow these steps:

1. Prepare the computer for disassembly (see [Preparation for disassembly on page 40](#)).
2. Remove the bottom cover (see [Bottom cover on page 40](#)).
3. Disconnect the battery cable from the system board (see [Battery on page 46](#)).

Remove the fans:

1. Release the webcam cable from the retention clips **(1)** that are built into the right fans.
2. Disconnect the fan cables **(2)** from the system board.
3. Loosen the four Phillips captive screws **(3)** that secure the fans to the computer.
4. Remove the fans **(4)**.

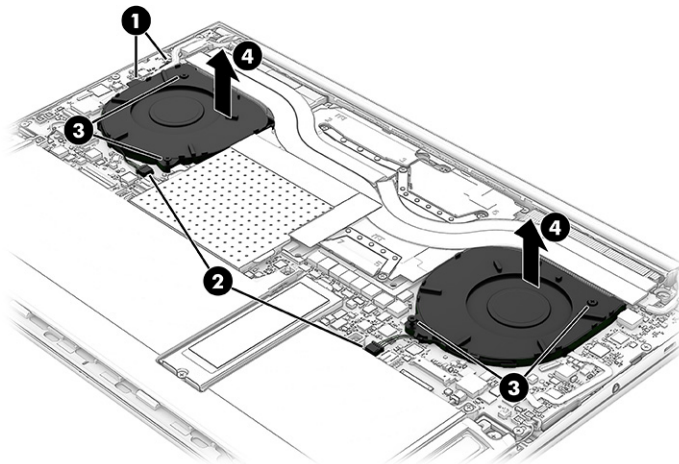

To install the fans, reverse the removal procedure.

Heat sink

To remove the heat sink, use these procedures and illustrations.

Table 5-7 Heat sink descriptions and part numbers

Description	Spare part number
Heat sink (includes captive screws and replacement thermal material):	
For use with system boards equipped with a graphics subsystem with discrete memory and an Intel i-9 or Intel i-8 processor	N10927-001

Table 5-7 Heat sink descriptions and part numbers (continued)

Description	Spare part number
For use with system boards equipped with a graphics subsystem with discrete memory and an Intel i-7 or Intel i-6 processor	N51005-001
For use with system boards equipped with a graphics subsystem with UMA memory	N10925-001

Before removing the heat sink, follow these steps:

1. Prepare the computer for disassembly (see [Preparation for disassembly on page 40](#)).
2. Remove the bottom cover (see [Bottom cover on page 40](#)).
3. Disconnect the battery cable from the system board (see [Battery on page 46](#)).

Remove the heat sink:

1. Release the tape (1) that secures the memory module shield to the heat sink.
2. In the order indicated on the heat sink, loosen the seven Phillips captive screws (2) that secure the heat sink to the computer.
3. Remove the heat sink (3) from the computer.

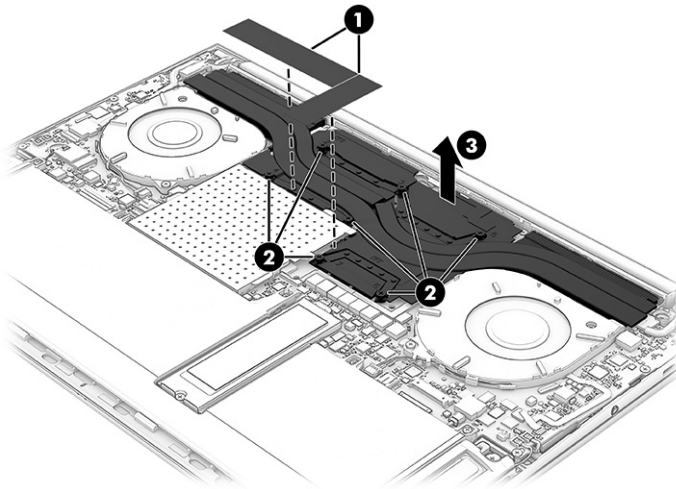

4. Inspect the thermal material on the surfaces of the system board and the heat sink each time the heat sink is removed. If the thermal pad is torn, missing part of the pad, or dirty, or if the thermal paste is dirty, thoroughly clean the thermal material from the surfaces of the system board and the heat sink. The following illustration shows the replacement thermal material locations.

Thermal paste is used on the system board processor (1) and on the heat sink area (2) that services it. Thermal paste is also used on the VGA component (3) and on the heat sink area (4) that services it.

Thermal pads are used on multiple system board components (5) and on the heat sink areas (6) that service them.

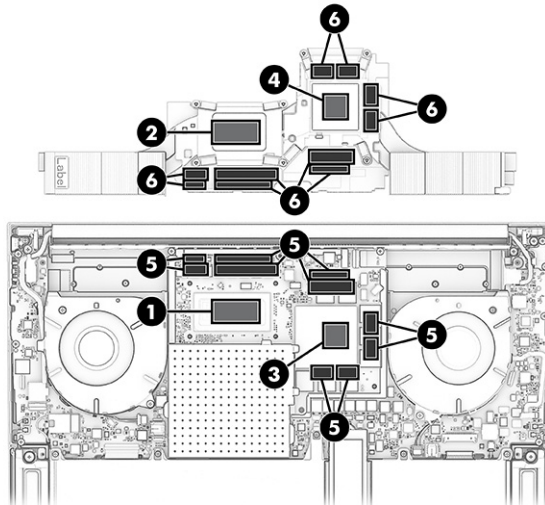

To install the heat sink, reverse the removal procedure.

Display assembly

To remove and disassemble the display assembly, use these procedures and illustrations.

Before removing the display assembly, follow these steps:

1. Prepare the computer for disassembly (see [Preparation for disassembly on page 40](#)).
2. Remove the bottom cover (see [Bottom cover on page 40](#)).
3. Disconnect the battery cable from the system board (see [Battery on page 46](#)).
4. Remove the heat sink (see [Heat sink on page 49](#)).

Remove the display assembly:

1. Release the zero insertion force (ZIF) connector (1) the webcam cable is connected to, and then disconnect the webcam cable from the system board.
2. Release the webcam cable from the retention clips (2) that are built into the right fan and I/O bracket.

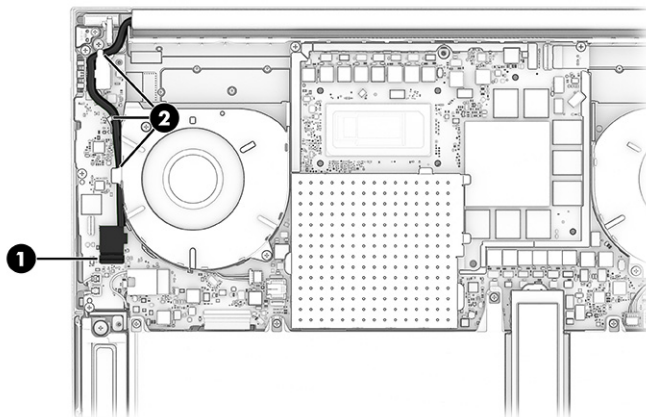

3. Release the ZIF connector **(1)** the display panel cable is connected to, and then disconnect the display panel cable from the system board.
4. Release the display panel cable from the retention clips **(6)** that are built into the computer.

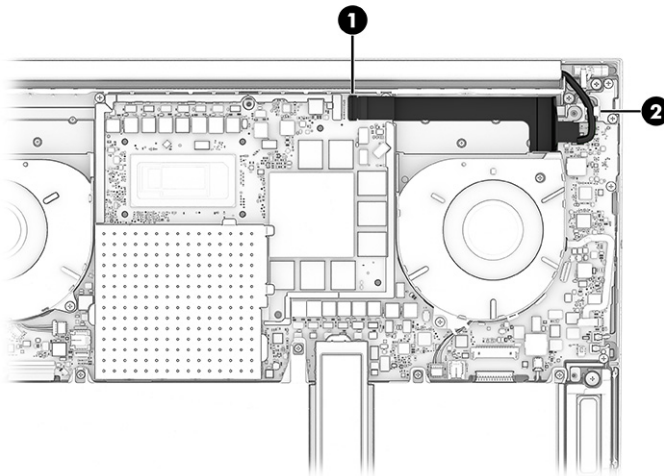

5. Remove the six Phillips M2.0 × 3.8 screws that secure the display assembly to the computer.

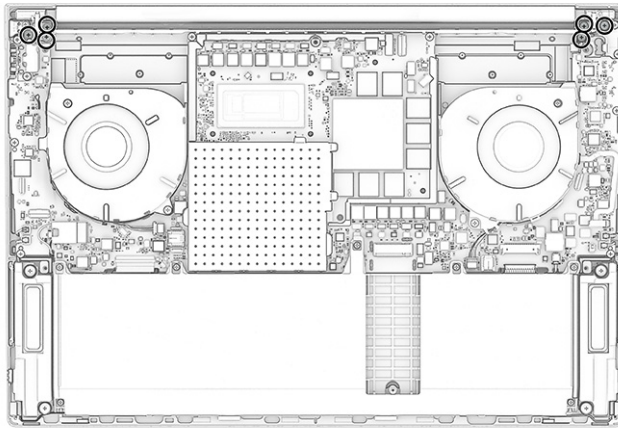

6. Swing the top edge of the display assembly **(1)** away from the computer until it is open to a 90-degree angle.
7. Separate the display assembly **(2)** from the computer.

8. Remove the display assembly **(3)** from the computer.

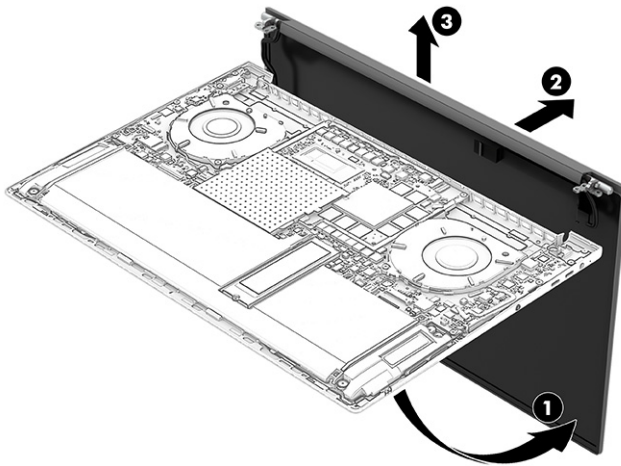

9. To remove the display bezel or any of the internal display components, follow these steps.
 - a. Remove the display assembly.
 - b. Use a thin, non-conductive tool **(1)** to separate the left side of the hinge cover **(2)** from the display assembly.
 - c. Remove the hinge cover **(3)**.

The hinge cover is available using spare part number N10937-001.

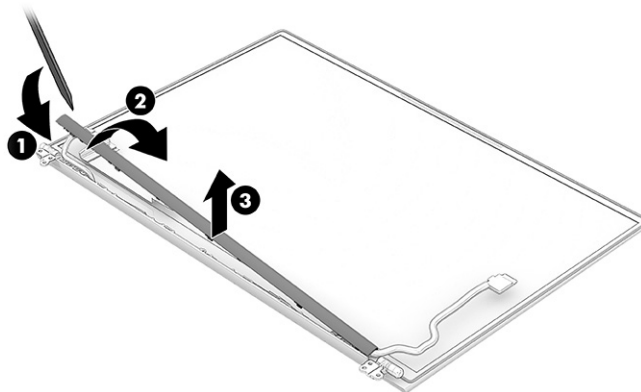

- d. Use a thin, non-conductive tool to separate the bottom edge **(1)** of the display bezel from the display back cover.
- e. Separate the left **(2)** and right edges of the display bezel from the display back cover.
- f. Separate the top edge **(3)** of the display bezel from the display back cover.
- g. Remove the display bezel **(4)**.

The display bezel is available using spare part number N10930-001.

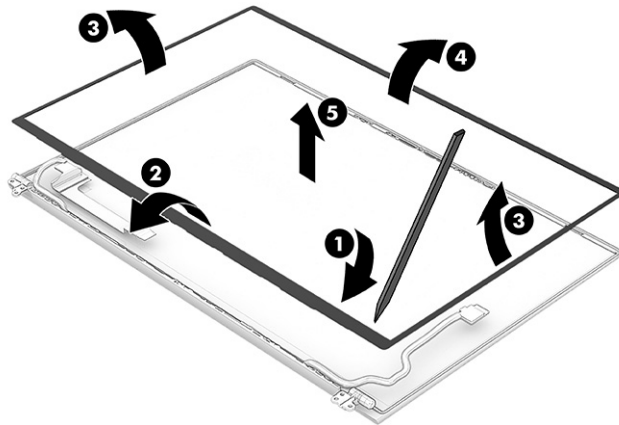

10. To remove the display panel assembly:

- a. Remove the display assembly.
- b. Remove the display bezel.
- c. The display panel assembly is secured to the display back cover with tape that is installed under the bottom corners (1) of the display panel assembly. To remove the panel, use tweezers to grasp the end of the tape. While turning the tweezers, wrap the tape around the tweezers (2) as you continue to pull the tape out (3) from behind the display panel. You must pull the tape multiple times before it is completely removed.

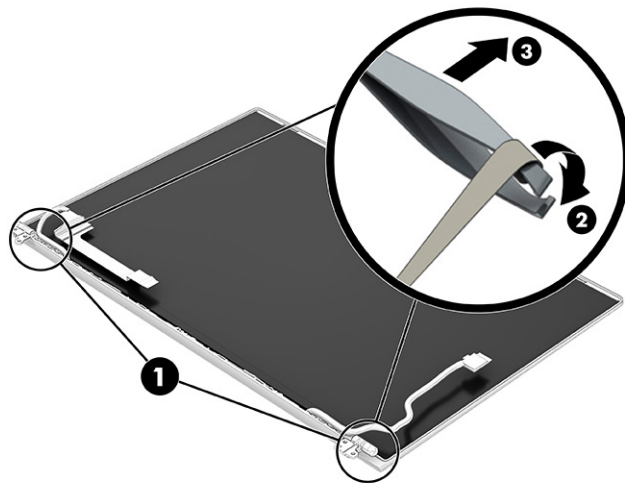

- d. Swing the top edge of the display back cover (1) up and away from the display panel assembly.
- e. Release the adhesive support strip (2) that secures the display panel connector to the display panel assembly.
- f. Release the support bar (3) that secures the display panel connector to the display panel assembly.

- g. Disconnect the display panel cable from the display panel assembly (4).

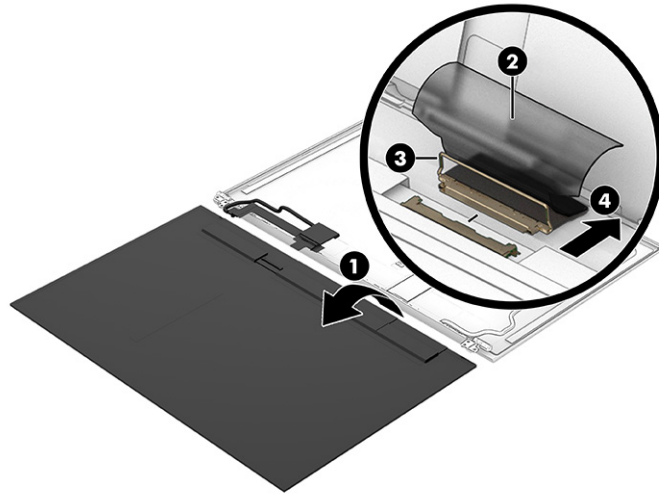

- h. Remove the display panel assembly.

The display panel assembly is available using the following spare part numbers:

- N51321-001: 40.6 cm (16.0 in), DreamColor, WQUXGA, antiglare, LED, UWVA, nTOP display panel assembly; typical brightness: 500 nits
- N51322-001: 40.6 cm (16.0 in), OLED, WQUXGA, brightview, UWVA, TOP display panel assembly; typical brightness: 400 nits
- N10910-001: 40.6 cm (16.0 in), OLED, WQUXGA, antiglare, UWVA, TOP display panel assembly; typical brightness: 400 nits

11. To remove the microphones:

- Remove the display assembly.
- Remove the display bezel.
- Remove the display panel assembly.
- Release the low insertion force (LIF) connectors (1) the microphone cables are connected to, and then disconnect the microphone cables from the sensor board.
- Remove the four Phillips M1.5 × 2.0 screws (2) that secure the microphones to the display back cover.
- Detach the microphone cables (3) from the display back cover. The microphone cables are attached to the display back cover with double-sided adhesive.
- Remove the microphones (4).

The microphones are available using spare part number N10936-001.

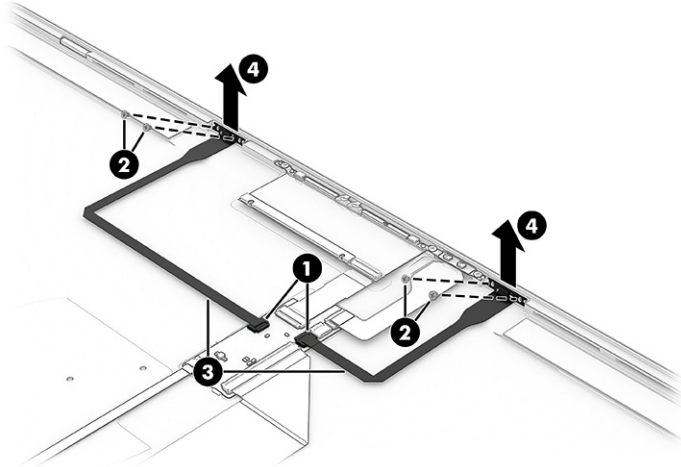

12. To remove the webcam cable:

- a. Remove the display assembly.
- b. Remove the display bezel.
- c. Remove the display panel assembly.
- d. Release the LIF connector (1) the webcam cable is connected to, and then disconnect the webcam cable from the sensor board.
- e. Release the LIF connector (2) the webcam cable is connected to, and then disconnect the webcam cable from the webcam.
- f. Remove the webcam cable (3).

The webcam cable is available using spare part number N10934-001.

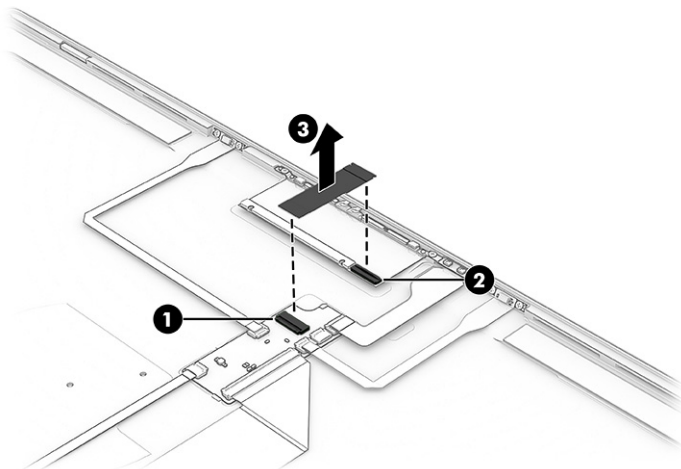

13. To remove the webcam:

- a. Remove the display assembly.
- b. Remove the display bezel.

- c. Remove the display panel assembly.
- d. Remove the webcam cable.
- e. Detach the webcam from the display back cover. The webcam is attached to the display back cover with double-sided adhesive.

The webcam is available using spare part number N51318-001.

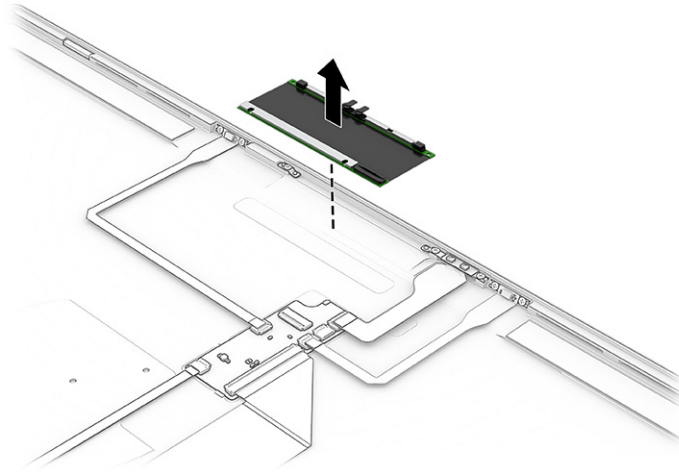

14. To remove the ALS board:

- a. Remove the display assembly.
- b. Remove the display bezel.
- c. Remove the display panel assembly.
- d. Remove the two Phillips M1.5 × 2.0 screws **(1)** that secure the ALS board to the display back cover.
- e. Release the LIF connector **(2)** the ALS board cable is connected to, and then disconnect the ALS board cable from the sensor board.
- f. Detach the ALS board cable **(3)** from the display back cover. The ALS board cable is attached to the display back cover with double-sided adhesive.
- g. Remove the ALS board **(4)** and cable.

The ALS board and cable are available using spare part number N10915-001.

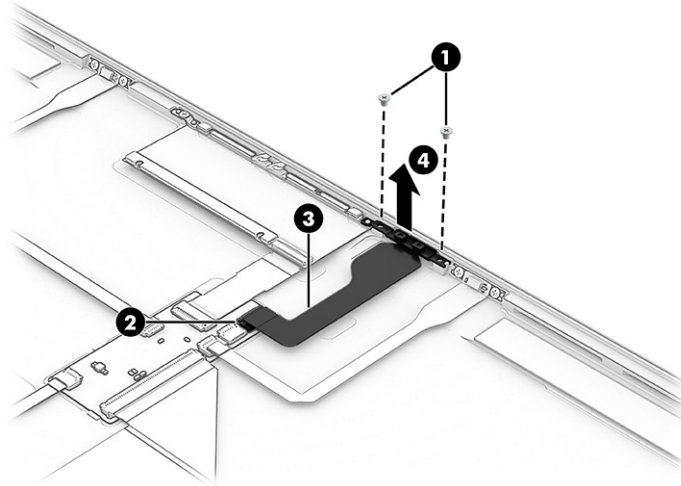

15. To remove the motion board cable:

- a. Remove the display assembly.
- b. Remove the display bezel.
- c. Remove the display panel assembly.
- d. Release the LIF connector (1) the motion board cable is connected to, and then disconnect the motion board cable from the sensor board.
- e. Release the LIF connector (2) the motion board cable is connected to, and then disconnect the motion board cable from the motion board.
- f. Detach the motion board cable (3) from the display back cover. The motion board cable is attached to the display back cover with double-sided adhesive.

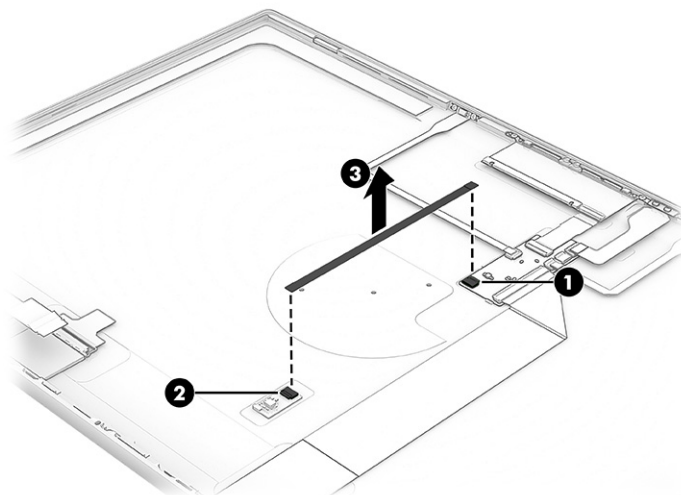

- g. Remove the motion board cable.

The motion board cable is included in the Display Cable Kit, spare part number N10933-001.

16. To remove the motion board:

- a. Remove the display assembly.
- b. Remove the display bezel.
- c. Remove the display panel assembly.
- d. Remove the motion board cable.
- e. Detach the motion board from the display back cover. The motion board is attached to the display back cover with double-sided adhesive.

The motion board is available using spare part number N10918-001.

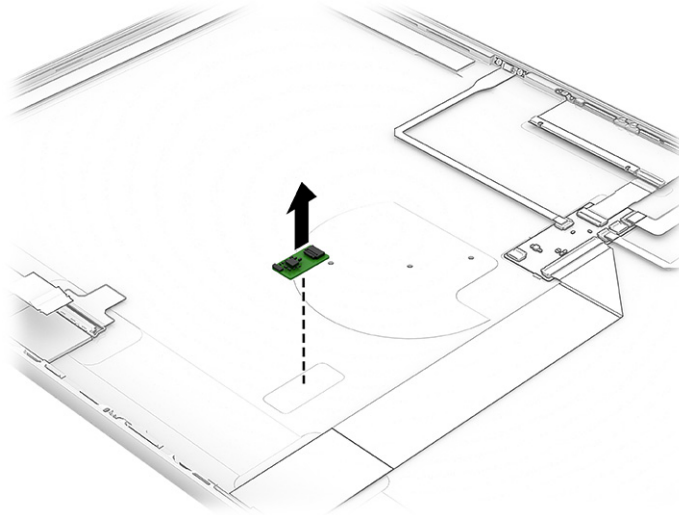

17. To remove the sensor board cable:
 - a. Remove the display assembly.
 - b. Remove the display bezel.
 - c. Remove the display panel assembly.
 - d. Release the ZIF connector **(1)** the sensor board cable is connected to, and then disconnect the sensor board cable from the sensor board.
 - e. Detach the sensor board cable **(2)** from the display back cover. The sensor board cable is attached to the display back cover with double-sided adhesive.

- f. Release the sensor board cable from the retention clips **(3)** and routing channel that secure the sensor board cable to the display back cover.

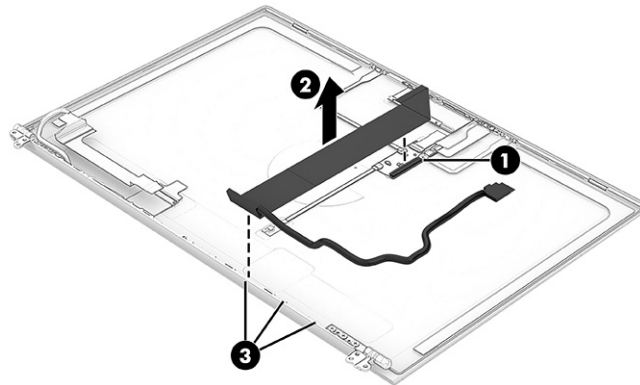

- g. Remove the sensor board cable.
The sensor board cable is available using spare part number N13578-001.
18. To remove the sensor board:
- a. Remove the display assembly.
 - b. Remove the display bezel.
 - c. Remove the display panel assembly.
 - d. Remove the sensor board cable.
 - e. Release the LIF connectors **(1)** the microphone cables are connected to, and then disconnect the microphone cables from the sensor board.
 - f. Release the LIF connector **(2)** the webcam cable is connected to, and then disconnect the webcam cable from the sensor board.
 - g. Release the LIF connector **(3)** the ALS board cable is connected to, and then disconnect the ALS board cable from the sensor board.
 - h. Release the LIF connector **(4)** the motion board cable is connected to, and then disconnect the motion board cable from the sensor board.

- i. Detach the sensor board (5) from the display back cover. The sensor board is attached to the display back cover with double-sided adhesive.

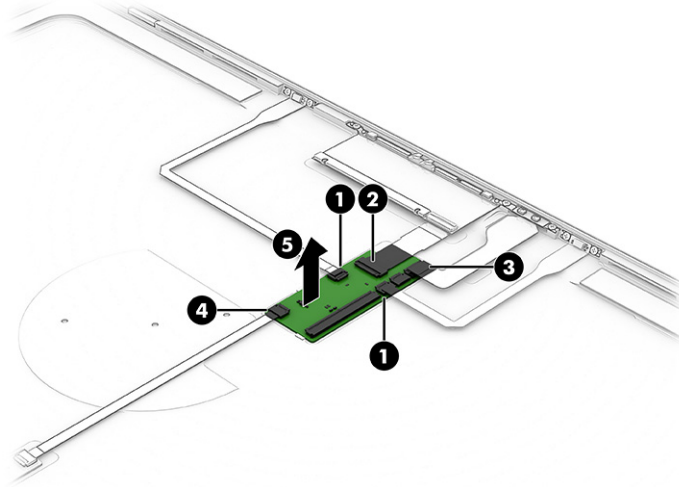

- j. Remove the sensor board.
The sensor board is available using spare part number N10918-001.

19. To remove the hinges:

- a. Remove the display assembly.
- b. Remove the display bezel.
- c. Remove the display panel assembly.
- d. Remove the six Phillips M2.5 × 6.1 screws (1) that secure the hinges to the display panel assembly.
- e. Remove the hinges (2).

The hinges are available using spare part number N10932-001.

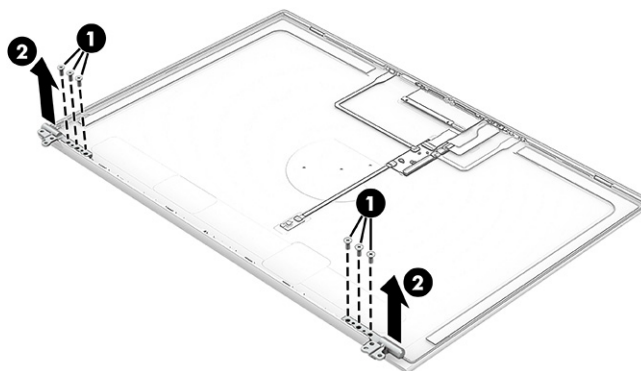

To reassemble and replace the display assembly, reverse the removal procedure.

System board

To remove the system board, use these procedures and illustrations.

Table 5-8 System board descriptions and part numbers

Description	Spare part number
The system board spare part kit includes an integrated processor and replacement thermal material.	
Equipped with an Intel i9-13900HK processor, an NVIDIA® RTX® A4X graphics controller with 12 GB of discrete memory, and the Windows 11 operating system	N51000-601
Equipped with an Intel i9-13900HK processor, an NVIDIA RTX A4X graphics controller with 12 GB of discrete memory, and a non-Windows operating system	N51000-001
Equipped with an Intel i9-13900H processor, an NVIDIA RTX A4X graphics controller with 12 GB of discrete memory, and the Windows 11 operating system	N51001-601
Equipped with an Intel i9-13900H processor, an NVIDIA RTX A4X graphics controller with 12 GB of discrete memory, and a non-Windows operating system	N51001-001
Equipped with an Intel i9-13900HK processor, an NVIDIA RTX 4080 graphics controller with 12 GB of discrete memory, and the Windows 11 operating system	N50998-601
Equipped with an Intel i9-13900HK processor, an NVIDIA RTX 4080 graphics controller with 12 GB of discrete memory, and a non-Windows operating system	N50998-001
Equipped with an Intel i9-13900H processor, an NVIDIA RTX 4080 graphics controller with 12 GB of discrete memory, and the Windows 11 operating system	N50999-601
Equipped with an Intel i9-13900H processor, an NVIDIA RTX 4080 graphics controller with 12 GB of discrete memory, and a non-Windows operating system	N50999-001
Equipped with an Intel i9-13900HK processor, an NVIDIA RTX A3X graphics controller with 8 GB of discrete memory, and the Windows 11 operating system	N50992-601
Equipped with an Intel i9-13900HK processor, an NVIDIA RTX A3X graphics controller with 8 GB of discrete memory, and a non-Windows operating system	N50992-001
Equipped with an Intel i9-13900H processor, an NVIDIA RTX A3X graphics controller with 8 GB of discrete memory, and the Windows 11 operating system	N50993-601
Equipped with an Intel i9-13900H processor, an NVIDIA RTX A3X graphics controller with 8 GB of discrete memory, and a non-Windows operating system	N50993-001
Equipped with an Intel i9-13900HK processor, an NVIDIA RTX A2X graphics controller with 8 GB of discrete memory, and the Windows 11 operating system	N50988-601
Equipped with an Intel i9-13900HK processor, an NVIDIA RTX A2X graphics controller with 8 GB of discrete memory, and a non-Windows operating system	N50988-001
Equipped with an Intel i9-13900H processor, an NVIDIA RTX A2X graphics controller with 8 GB of discrete memory, and the Windows 11 operating system	N50989-601
Equipped with an Intel i9-13900H processor, an NVIDIA RTX A2X graphics controller with 8 GB of discrete memory, and a non-Windows operating system	N50989-001
Equipped with an Intel i9-13900HK processor, an NVIDIA RTX 4070 graphics controller with 8 GB of discrete memory, and the Windows 11 operating system	N50996-601
Equipped with an Intel i9-13900HK processor, an NVIDIA RTX 4070 graphics controller with 8 GB of discrete memory, and a non-Windows operating system	N50996-001
Equipped with an Intel i9-13900H processor, an NVIDIA RTX 4070 graphics controller with 8 GB of discrete memory, and the Windows 11 operating system	N50997-601
Equipped with an Intel i9-13900H processor, an NVIDIA RTX 4070 graphics controller with 8 GB of discrete memory, and a non-Windows operating system	N50997-001

Table 5-8 System board descriptions and part numbers (continued)

Description	Spare part number
Equipped with an Intel i9-13900HK processor, an NVIDIA RTX A1X graphics controller with 6 GB of discrete memory, and the Windows 11 operating system	N50984-601
Equipped with an Intel i9-13900HK processor, an NVIDIA RTX A1X graphics controller with 6 GB of discrete memory, and a non-Windows operating system	N50984-001
Equipped with an Intel i9-13900H processor, an NVIDIA RTX A1X graphics controller with 6 GB of discrete memory, and the Windows 11 operating system	N50985-601
Equipped with an Intel i9-13900H processor, an NVIDIA RTX A1X graphics controller with 6 GB of discrete memory, and a non-Windows operating system	N50985-001
Equipped with an Intel i7-13800H processor, an NVIDIA RTX A4X graphics controller with 12 GB of discrete memory, and the Windows 11 operating system	N50995-601
Equipped with an Intel i7-13800H processor, an NVIDIA RTX A4X graphics controller with 12 GB of discrete memory, and a non-Windows operating system	N50995-001
Equipped with an Intel i7-13800H processor, an NVIDIA RTX 4080 graphics controller with 12 GB of discrete memory, and the Windows 11 operating system	N50980-601
Equipped with an Intel i7-13800H processor, an NVIDIA RTX 4080 graphics controller with 12 GB of discrete memory, and a non-Windows operating system	N50980-001
Equipped with an Intel i7-13800H processor, an NVIDIA RTX A3X graphics controller with 8 GB of discrete memory, and the Windows 11 operating system	N50991-601
Equipped with an Intel i7-13800H processor, an NVIDIA RTX A3X graphics controller with 8 GB of discrete memory, and a non-Windows operating system	N50991-001
Equipped with an Intel i7-13800H processor, an NVIDIA RTX A2X graphics controller with 8 GB of discrete memory, and the Windows 11 operating system	N50987-601
Equipped with an Intel i7-13800H processor, an NVIDIA RTX A2X graphics controller with 8 GB of discrete memory, and a non-Windows operating system	N50987-001
Equipped with an Intel i7-13800H processor, an NVIDIA RTX 4070 graphics controller with 8 GB of discrete memory, and the Windows 11 operating system	N50978-601
Equipped with an Intel i7-13800H processor, an NVIDIA RTX 4070 graphics controller with 8 GB of discrete memory, and a non-Windows operating system	N50978-001
Equipped with an Intel i7-13800H processor, an NVIDIA RTX A1X graphics controller with 6 GB of discrete memory, and the Windows 11 operating system	N50983-601
Equipped with an Intel i7-13800H processor, an NVIDIA RTX A1X graphics controller with 6 GB of discrete memory, and a non-Windows operating system	N50983-001
Equipped with an Intel i7-13700H processor, an NVIDIA RTX A4X graphics controller with 12 GB of discrete memory, and the Windows 11 operating system	N50994-601
Equipped with an Intel i7-13700H processor, an NVIDIA RTX A4X graphics controller with 12 GB of discrete memory, and a non-Windows operating system	N50994-001
Equipped with an Intel i7-13700H processor, an NVIDIA RTX 4080 graphics controller with 12 GB of discrete memory, and the Windows 11 operating system	N50979-601
Equipped with an Intel i7-13700H processor, an NVIDIA RTX 4080 graphics controller with 12 GB of discrete memory, and a non-Windows operating system	N50979-001
Equipped with an Intel i7-13700H processor, an NVIDIA RTX A3X graphics controller with 8 GB of discrete memory, and the Windows 11 operating system	N50990-601
Equipped with an Intel i7-13700H processor, an NVIDIA RTX A3X graphics controller with 8 GB of discrete memory, and a non-Windows operating system	N50990-001

Table 5-8 System board descriptions and part numbers (continued)

Description	Spare part number
Equipped with an Intel i7-13700H processor, an NVIDIA RTX A2X graphics controller with 8 GB of discrete memory, and the Windows 11 operating system	N50986-601
Equipped with an Intel i7-13700H processor, an NVIDIA RTX A2X graphics controller with 8 GB of discrete memory, and a non-Windows operating system	N50986-001
Equipped with an Intel i7-13700H processor, an NVIDIA RTX 4070 graphics controller with 8 GB of discrete memory, and the Windows 11 operating system	N50977-601
Equipped with an Intel i7-13700H processor, an NVIDIA RTX 4070 graphics controller with 8 GB of discrete memory, and a non-Windows operating system	N50977-001
Equipped with an Intel i7-13700H processor, an NVIDIA RTX A1X graphics controller with 6 GB of discrete memory, and the Windows 11 operating system	N50982-601
Equipped with an Intel i7-13700H processor, an NVIDIA RTX A1X graphics controller with 6 GB of discrete memory, and a non-Windows operating system	N50982-001
Equipped with an Intel i5-13600H processor, an NVIDIA RTX A1X graphics controller with 6 GB of discrete memory, and the Windows 11 operating system	N50981-601
Equipped with an Intel i7-13800H processor, a graphics subsystem with UMA memory, and the Windows 11 operating system	N51004-601
Equipped with an Intel i7-13800H processor, a graphics subsystem with UMA memory, and a non-Windows operating system	N51004-001
Equipped with an Intel i7-13700H processor, a graphics subsystem with UMA memory, and the Windows 11 operating system	N51003-601
Equipped with an Intel i7-13700H processor, a graphics subsystem with UMA memory, and a non-Windows operating system	N51003-001
Equipped with an Intel i5-13600H processor, a graphics subsystem with UMA memory, and the Windows 11 operating system	N51004-601
Equipped with an Intel i5-13600H processor, a graphics subsystem with UMA memory, and a non-Windows operating system	N51004-001
System Board Repair Kit (not illustrated)	N56255-888

Before removing the system board, follow these steps:

1. Prepare the computer for disassembly (see [Preparation for disassembly on page 40](#)).
2. Remove the bottom cover (see [Bottom cover on page 40](#)).
3. Remove the solid-state drive (see [Solid-state drive on page 42](#)).
4. Remove the battery (see [Battery on page 46](#)).
5. Remove the fans (see [Fans on page 49](#)).
6. Remove the heat sink (see [Heat sink on page 49](#)).

When you replace the system board, be sure to remove the memory modules (see [Memory modules on page 47](#)) from the defective system board and install them on the replacement system board.

Remove the system board:

1. Release the ZIF connector **(1)** the display panel cable is connected to, and then disconnect the display panel cable from the system board.
2. Release the display panel cable from the retention clips **(2)** that are built into the computer.
3. Disconnect the following cables from the system board:
 - Audio jack ZIF cable **(3)**
 - Top speaker cables **(4)**
 - Bottom speaker cables **(5)**
 - RTC battery cable **(6)**
 - Transfer board ZIF cable **(7)**
4. Detach the WLAN antenna cover **(8)** from the WLAN module. The WLAN antenna cover is attached to the WLAN module with double-sided adhesive.

 **NOTE:** The WLAN antenna cover is included in the Plastics Kit, spare part number N51319-001.

5. Carefully disconnect the WLAN module antenna cables **(9)** from the WLAN module.

 **NOTE:** Computer models have either one or two WLAN module antenna cables. On models with two antenna cables, the #1 white WLAN module antenna cable connects to the WLAN module #1 Main terminal. The #2 black WLAN module antenna cable connects to the WLAN module #1 Aux terminal.

6. Release the ZIF connector **(10)** the webcam cable is connected to, and then disconnect the webcam cable from the system board.
7. Release the webcam cable from the retention clips **(11)** that are built into the I/O bracket.

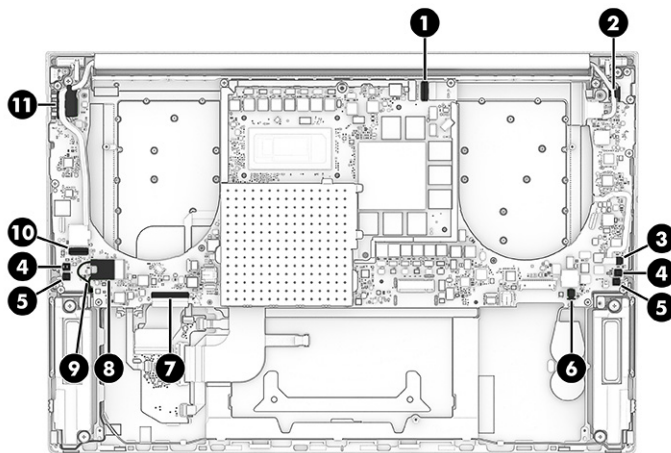

8. Remove the ten Phillips M2.0 × 4.9 screws **(1)** that secure the system board to the computer
9. Remove the left-side **(2)** and right-side I/O brackets **(3)**.

 **NOTE:** The I/O brackets are included in the Plastics Kit, spare part number N51319-001.

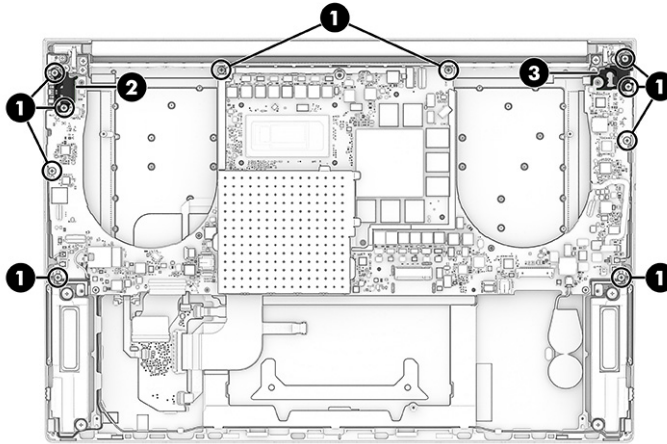

10. Remove the SD card insert (1) from the SD card slot.



NOTE: The SD card insert is included in the Plastics Kit, spare part number N51319-001.

11. Lift the rear edge of the system board (2) until it rests at an angle.

12. Slide the system board (3) up and back at an angle to remove it.

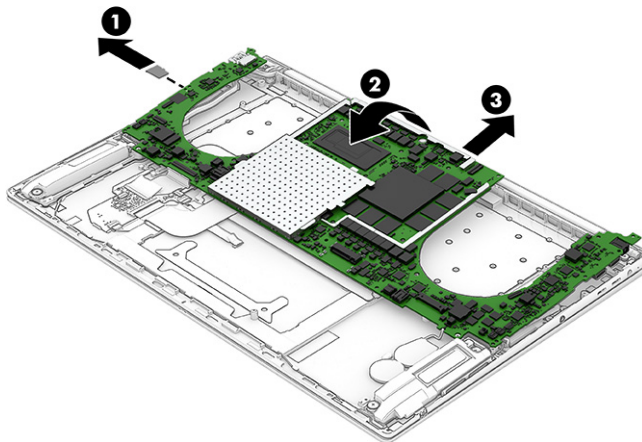

To install the system board, reverse the removal procedure.

Wireless antenna

To remove the wireless antenna, use this procedure and illustration.

Table 5-9 Wireless antenna description and part number

Description	Spare part number
Wireless antenna (includes main antenna and auxiliary antenna cables, transceivers, and double-sided adhesive)	N10931-001

Before removing the wireless antenna, follow these steps:

1. Prepare the computer for disassembly (see [Preparation for disassembly on page 40](#)).
2. Remove the bottom cover (see [Bottom cover on page 40](#)).
3. Remove the solid-state drive (see [Solid-state drive on page 42](#)).
4. Remove the battery (see [Battery on page 46](#)).
5. Remove the fans (see [Fans on page 49](#)).
6. Remove the heat sink (see [Heat sink on page 49](#)).
7. Remove the system board (see [System board on page 62](#)).

Remove the wireless antenna:

1. Release the tape **(1)** that secures the wireless antenna cables to the computer.
2. Release the wireless antenna cables from the retention clips **(2)** and channels that are built into the computer.
3. Detach the wireless antenna transceivers **(3)** from the computer. The wireless antenna transceivers are attached to the computer with double-sided adhesive.

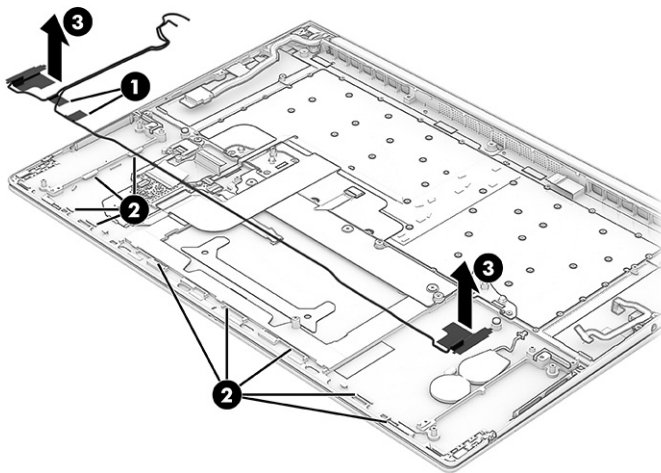

4. Remove the wireless antenna.

To install the wireless antenna, reverse the removal procedure.

Fingerprint reader cable

To remove the fingerprint reader cable, use this procedure and illustration.

 **NOTE:** The fingerprint reader cable is included in the Cable Kit, spare part number N10935-001.

Before removing the fingerprint reader cable, follow these steps:

1. Prepare the computer for disassembly (see [Preparation for disassembly on page 40](#)).
2. Remove the bottom cover (see [Bottom cover on page 40](#)).
3. Remove the solid-state drive (see [Solid-state drive on page 42](#)).

4. Remove the battery (see [Battery on page 46](#)).
5. Remove the fans (see [Fans on page 49](#)).
6. Remove the heat sink (see [Heat sink on page 49](#)).
7. Remove the system board (see [System board on page 62](#)).

Remove the fingerprint reader cable:

1. Release the ZIF connector (1) the fingerprint reader cable is connected to, and then disconnect the fingerprint reader cable from the fingerprint reader.
2. Release the ZIF connector (2) the fingerprint reader cable is connected to, and then disconnect the fingerprint reader cable from the transfer board.
3. Detach the fingerprint reader cable (3) from the computer. The fingerprint reader cable is attached to the computer with double-sided adhesive.

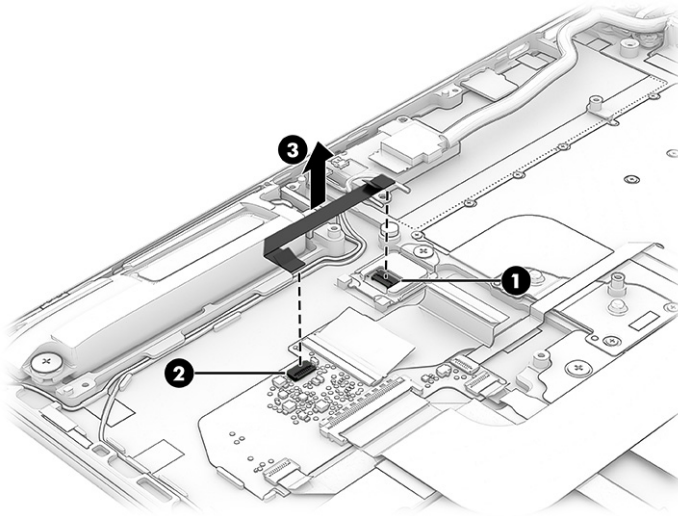

4. Remove the fingerprint reader cable.

To install the fingerprint reader cable, reverse the removal procedure.

Fingerprint reader

To remove the fingerprint reader, use this procedure and illustration.

Table 5-10 Fingerprint reader description and part number

Description	Spare part number
Fingerprint reader	N10920-001

NOTE: The fingerprint reader spare part kit does not include the fingerprint reader bracket or the fingerprint reader cable. The fingerprint reader bracket is included in the Bracket Kit, spare part number N10940-001. The fingerprint reader cable is included in the Cable Kit, spare part number N10935-001.

Before removing the fingerprint reader, follow these steps:

1. Prepare the computer for disassembly (see [Preparation for disassembly on page 40](#)).

2. Remove the bottom cover (see [Bottom cover on page 40](#)).
3. Remove the solid-state drive (see [Solid-state drive on page 42](#)).
4. Remove the battery (see [Battery on page 46](#)).
5. Remove the fans (see [Fans on page 49](#)).
6. Remove the heat sink (see [Heat sink on page 49](#)).
7. Remove the system board (see [System board on page 62](#)).
8. Remove the fingerprint reader cable (see [Fingerprint reader cable on page 67](#)).

Remove the fingerprint reader:

1. Remove the Phillips M2.0 × 2.5 screw **(1)** that secures the fingerprint reader and bracket to the computer.
2. Remove the fingerprint reader bracket **(2)**.
The fingerprint reader bracket is included in the Bracket Kit, spare part number N10940-001.
3. Remove the fingerprint reader **(3)**.

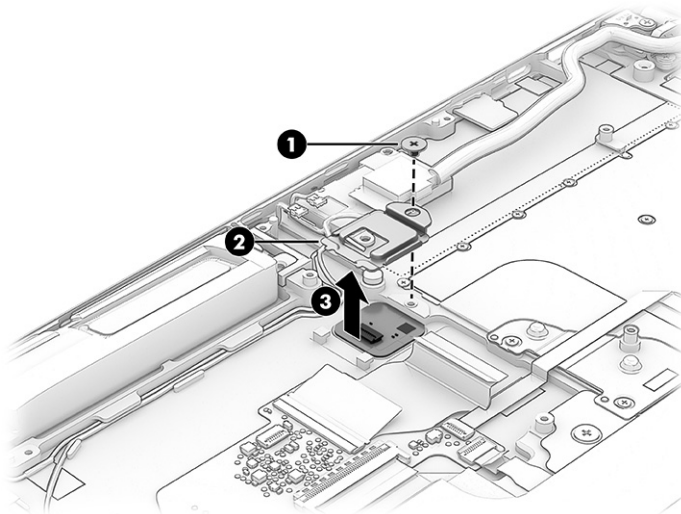

To install the fingerprint reader, reverse the removal procedure.

Transfer board cable

To remove the transfer board cable, use this procedure and illustration.

 **NOTE:** The transfer board cable is included in the Cable Kit, spare part number N10935-001.

Before removing the transfer board cable, follow these steps:

1. Prepare the computer for disassembly (see [Preparation for disassembly on page 40](#)).
2. Remove the bottom cover (see [Bottom cover on page 40](#)).
3. Remove the solid-state drive (see [Solid-state drive on page 42](#)).

4. Remove the battery (see [Battery on page 46](#)).
5. Remove the fans (see [Fans on page 49](#)).
6. Remove the heat sink (see [Heat sink on page 49](#)).
7. Remove the system board (see [System board on page 62](#)).

Remove the transfer board cable:

1. Release the ZIF connector (1) the transfer board cable is connected to, and then disconnect the transfer board cable from the transfer board.
2. Remove the transfer board cable (2) from the computer.

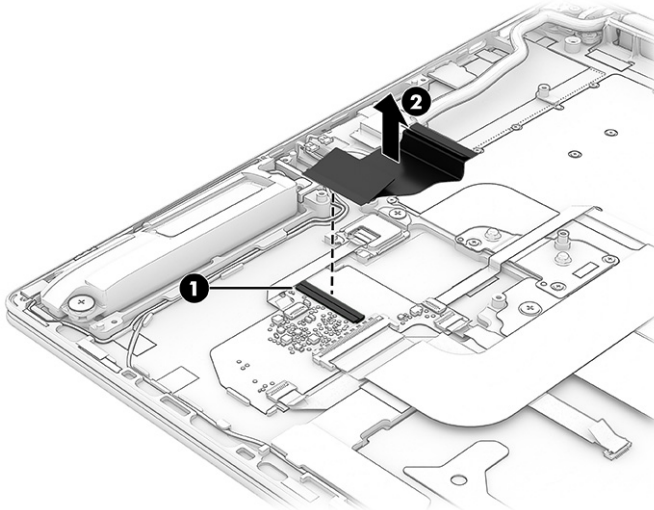

To install the transfer board cable, reverse the removal procedure.

Transfer board

To remove the transfer board, use this procedure and illustration.

Table 5-11 Transfer board description and part number

Description	Spare part number
Transfer board (includes double-sided adhesive)	N10919-001
NOTE: The transfer board spare part kit does not include the transfer board cable. The transfer board cable is included in the Cable Kit, spare part number N08556-001.	

Before removing the transfer board, follow these steps:

1. Prepare the computer for disassembly (see [Preparation for disassembly on page 40](#)).
2. Remove the bottom cover (see [Bottom cover on page 40](#)).
3. Remove the solid-state drive (see [Solid-state drive on page 42](#)).
4. Remove the battery (see [Battery on page 46](#)).
5. Remove the fans (see [Fans on page 49](#)).

6. Remove the heat sink (see [Heat sink on page 49](#)).
7. Remove the system board (see [System board on page 62](#)).
8. Remove the transfer board cable (see [Transfer board cable on page 69](#)).

Remove the transfer board:

1. Release the ZIF connector **(1)** the fingerprint reader cable is connected to, and then disconnect the fingerprint reader cable from the transfer board.
2. Release the ZIF connector **(2)** the backlight cable is connected to, and then disconnect the backlight cable from the transfer board.
3. Release the ZIF connector **(3)** the RGB cable is connected to, and then disconnect the RGB cable from the transfer board.
4. Release the ZIF connector **(4)** the keyboard cable is connected to, and then disconnect the keyboard cable from the transfer board.
5. Release the ZIF connector **(5)** the touchpad cable is connected to, and then disconnect the touchpad cable from the transfer board.
6. Detach the transfer board **(6)** from the computer. The transfer board is attached to the computer with double-sided adhesive.

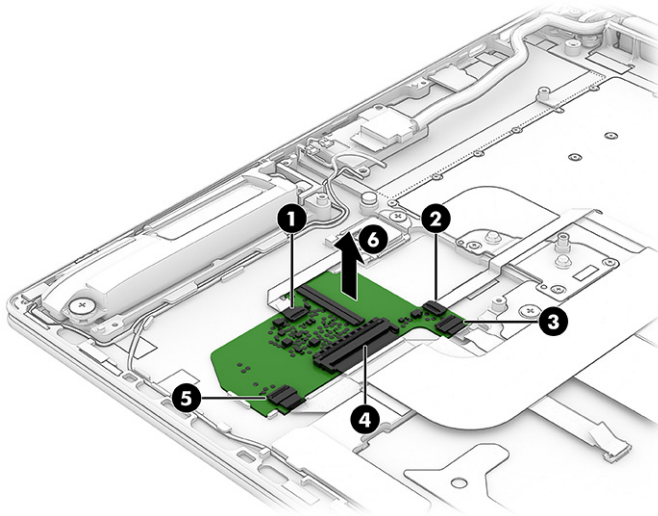

7. Remove the transfer board.

To install the transfer board, reverse the removal procedure.

Touchpad cable

To remove the touchpad cable, use this procedure and illustration.

 **NOTE:** The touchpad cable is included in the Cable Kit, spare part number N10935-001.

Before removing the touchpad cable, follow these steps:

1. Prepare the computer for disassembly (see [Preparation for disassembly on page 40](#)).
2. Remove the bottom cover (see [Bottom cover on page 40](#)).

3. Remove the solid-state drive (see [Solid-state drive on page 42](#)).
4. Remove the battery (see [Battery on page 46](#)).
5. Remove the fans (see [Fans on page 49](#)).
6. Remove the heat sink (see [Heat sink on page 49](#)).
7. Remove the system board (see [System board on page 62](#)).

Remove the touchpad cable:

1. Release the ZIF connector **(1)** the touchpad cable is connected to, and then disconnect the touchpad cable from the transfer board.
2. Release the ZIF connector **(2)** the touchpad cable is connected to, and then disconnect the touchpad cable from the touchpad.
3. Detach the touchpad cable **(3)** from the computer. The touchpad cable is attached to the computer with double-sided adhesive.

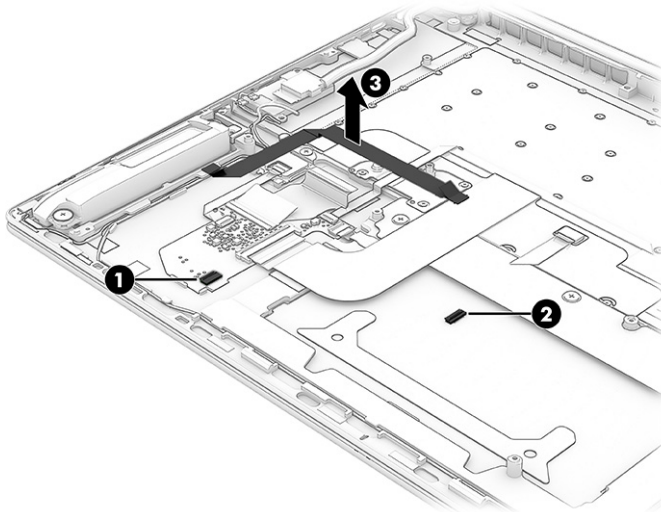

4. Remove the touchpad cable.

To install the touchpad cable, reverse the removal procedure.

Touchpad

To remove the touchpad, use this procedure and illustration.

Table 5-12 Touchpad description and part number

Description	Spare part number
Touchpad	N10923-001

NOTE: The touchpad spare part kit does not include the touchpad cable. The touchpad cable is available using spare part number N10935-001.

Before removing the touchpad, follow these steps:

1. Prepare the computer for disassembly (see [Preparation for disassembly on page 40](#)).
2. Remove the bottom cover (see [Bottom cover on page 40](#)).
3. Remove the solid-state drive (see [Solid-state drive on page 42](#)).
4. Remove the battery (see [Battery on page 46](#)).
5. Remove the fans (see [Fans on page 49](#)).
6. Remove the heat sink (see [Heat sink on page 49](#)).
7. Remove the system board (see [System board on page 62](#)).
8. Remove the touchpad cable (see [Touchpad cable on page 71](#)).

Remove the touchpad:

1. Remove the three Phillips M2.0 × 2.5 broad head screws (1) that secure the touchpad to the computer.
2. Remove the shielding material (2) that secures the touchpad to the computer.
3. Lift the top edge of the touchpad (3) until it rests at an angle.
4. Slide the touchpad (4) up and away from the computer and remove it.

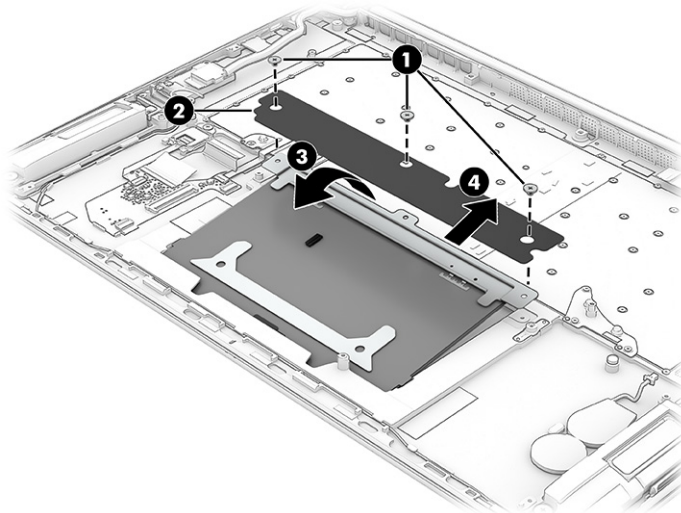

To install the touchpad, reverse the removal procedure.

RTC battery

To remove the RTC battery, use this procedure and illustration.

Table 5-13 RTC battery description and part number

Description	Spare part number
RTC battery (includes cable and double-sided adhesive)	N10921-001

Before removing the RTC battery, follow these steps:

1. Prepare the computer for disassembly (see [Preparation for disassembly on page 40](#)).
2. Remove the bottom cover (see [Bottom cover on page 40](#)).
3. Remove the solid-state drive (see [Solid-state drive on page 42](#)).
4. Remove the battery (see [Battery on page 46](#)).
5. Remove the fans (see [Fans on page 49](#)).
6. Remove the heat sink (see [Heat sink on page 49](#)).
7. Remove the system board (see [System board on page 62](#)).

Remove the RTC battery:

1. Detach the RTC battery from the computer. The RTC battery is attached to the computer with double-sided adhesive.

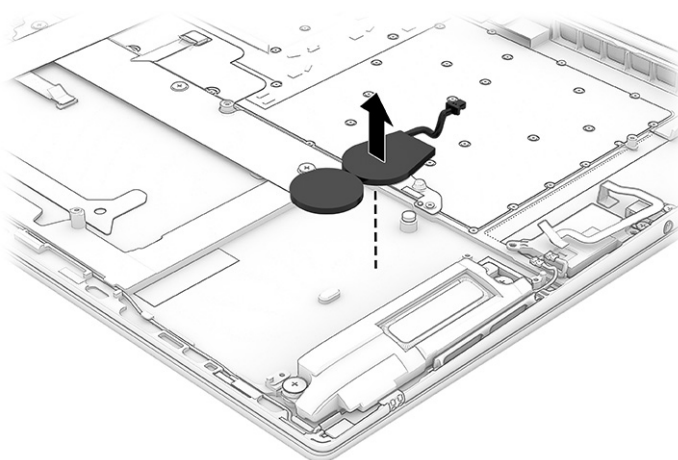

2. Remove the RTC battery.

To install the RTC battery, reverse the removal procedure.

Top speakers

To remove the top speakers, use this procedure and illustration.

Table 5-14 Top speakers description and part number

Description	Spare part number
Top speakers (included in the Speaker Kit, spare part number N51007-001; includes left and right top speakers, left and right bottom speakers, cables, and 4 rubber isolators)	

Before removing the top speakers, follow these steps:

1. Prepare the computer for disassembly (see [Preparation for disassembly on page 40](#)).
2. Remove the bottom cover (see [Bottom cover on page 40](#)).
3. Remove the solid-state drive (see [Solid-state drive on page 42](#)).

4. Remove the battery (see [Battery on page 46](#)).
5. Remove the fans (see [Fans on page 49](#)).
6. Remove the heat sink (see [Heat sink on page 49](#)).
7. Remove the system board (see [System board on page 62](#)).

Remove the top speakers:

- Detach the top speakers from the computer. The top speakers are attached to the computer with double-sided adhesive.

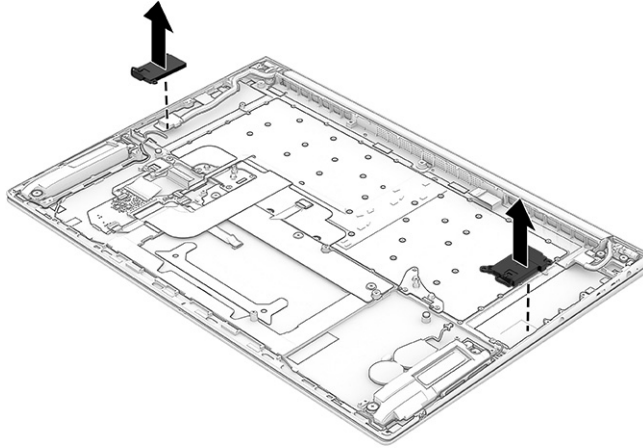

To install the top speakers, reverse the removal procedure.

Audio jack

To remove the audio jack, use this procedure and illustration.

Table 5-15 Audio jack description and part number

Description	Spare part number
Audio jack (includes cable)	N10939-001

Before removing the audio jack, follow these steps:

1. Prepare the computer for disassembly (see [Preparation for disassembly on page 40](#)).
2. Remove the bottom cover (see [Bottom cover on page 40](#)).
3. Remove the solid-state drive (see [Solid-state drive on page 42](#)).
4. Remove the battery (see [Battery on page 46](#)).
5. Remove the fans (see [Fans on page 49](#)).
6. Remove the heat sink (see [Heat sink on page 49](#)).
7. Remove the system board (see [System board on page 62](#)).

Remove the audio jack:

1. Remove the two Phillips M2.0 × 3.3 screws (1) that secure the audio jack to the computer.
2. Remove the audio jack (2).

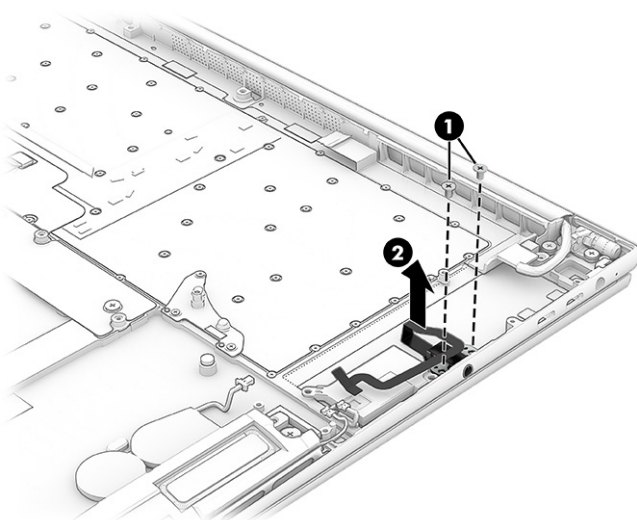

To install the audio jack, reverse the removal procedure.

Top cover with keyboard

The top cover with keyboard remains after removing all other spare parts from the computer. In this section, the first table provides the main spare part number for the top cover with keyboard. The second table provides the country codes.

Table 5-16 Top cover with keyboard descriptions and part numbers

Description	Spare part number
Top cover with keyboard with backlight and Z Command key for use with computer models equipped with an RGB webcam (includes backlight cable and keyboard cable; available only in France, Germany, the United Kingdom, and the United States)	N10946-xxx
Top cover with keyboard with backlight for use with computer models equipped with an RGB webcam (includes backlight cable and keyboard cable)	N10945-xxx
Top cover with keyboard with backlight (includes backlight cable and keyboard cable)	N10947-xxx

Table 5-17 Spare part country codes

For use in country or region	Country code	For use in country or region	Country code	For use in country or region	Country code
Belgium	-A41	Israel	-BB1	Slovenia	-BA1
The Czech Republic and Slovakia	-FL1	Italy	-061	Spain	-071
Denmark, Finland, and Norway	-DH1	The Netherlands	-B31	Switzerland	-BG1
France	-051	Portugal	-131	Turkey	-141

Table 5-17 Spare part country codes (continued)

For use in country or region	Country code	For use in country or region	Country code	For use in country or region	Country code
French Canada	-DB1	Romania	-271	Ukraine	-BD1
Germany	-041	Russia	-251	United Kingdom	-031
Greece	-151	Saudi Arabia	-171	United States	-001
Hungary	-211				

6 Computer Setup (BIOS), TPM, and HP Sure Start

HP provides several tools to help set up and protect your computer.

Using Computer Setup

Computer Setup, or Basic Input/Output System (BIOS), controls communication between all the input and output devices on the system (such as hard drives, display, keyboard, mouse, and printer). Computer Setup includes settings for types of devices installed, the startup sequence of the computer, and amount of system and extended memory.

 **NOTE:** Use extreme care when making changes in Computer Setup. Errors can prevent the computer from operating properly.

To start Computer Setup, turn on or restart the computer, and when the HP logo appears, press **f10** to enter Computer Setup.

Navigating and selecting in Computer Setup

You can navigate and select in Computer Setup using one or more methods.

- To select a menu or a menu item, use the **tab** key and the keyboard arrow keys and then press **enter**, or use a pointing device to select the item.
- To scroll up and down, select the up arrow or the down arrow in the upper-right corner of the screen, or use the up arrow key or the down arrow key on the keyboard.
- To close open dialog boxes and return to the main Computer Setup screen, press **esc**, and then follow the on-screen instructions.

To exit Computer Setup, choose one of the following methods:

- To exit Computer Setup menus without saving your changes, select **Main**, select **Ignore Changes and Exit**, and then select **Yes**.

 **NOTE:** If you are using arrow keys to highlight your choice, you must then press **enter**.

- To save your changes and exit Computer Setup menus, select **Main**, select **Save Changes and Exit**, and then select **Yes**.

 **NOTE:** If you are using arrow keys to highlight your choice, you must then press **enter**.

Your changes go into effect when the computer restarts.

Restoring factory settings in Computer Setup

To return all settings in Computer Setup to the values that were set at the factory, follow these steps.

 **NOTE:** Restoring defaults will not change the hard drive mode.

1. Start Computer Setup. See [Using Computer Setup on page 78](#).
2. Select **Main**, select **Apply Factory Defaults and Exit**, and then select **Yes**.

 **NOTE:** If you are using arrow keys to highlight your choice, you must then press [enter](#).

 **NOTE:** On select products, the selections might display **Restore Defaults** instead of **Apply Factory Defaults and Exit**.

Your changes go into effect when the computer restarts.

 **NOTE:** Your password settings and security settings are not changed when you restore the factory settings.

Updating the BIOS

Updated versions of the BIOS might be available on the HP website. Most BIOS updates on the HP website are packaged in compressed files called *SoftPaqs*.

Some download packages contain a file named *Readme.txt*, which contains information regarding installing and troubleshooting the file.

Determining the BIOS version

To decide whether you need to update Computer Setup (BIOS), first determine the BIOS version on your computer.

If you are already in Windows, you can access BIOS version information (also known as *ROM date* and *System BIOS*) by pressing **fn+esc** (select products only). Or you can use Computer Setup.

1. Start Computer Setup. See [Using Computer Setup on page 78](#).
2. Select **Main**, and then select **System Information**.
3. To exit Computer Setup menus without saving your changes, select **Main**, select **Ignore Changes and Exit**, and then select **Yes**.

 **NOTE:** If you are using arrow keys to highlight your choice, you must then press [enter](#).

To check for later BIOS versions, see [Preparing for a BIOS update on page 79](#).

Preparing for a BIOS update

Be sure to follow all prerequisites before downloading and installing a BIOS update.

 **IMPORTANT:** To reduce the risk of damage to the computer or an unsuccessful installation, download and install a BIOS update only when the computer is connected to reliable external power using the AC adapter. Do not download or install a BIOS update while the computer is running on battery power, docked in an optional docking device, or connected to an optional power source. During the download and installation, follow these instructions:

Do not disconnect power on the computer by unplugging the power cord from the AC outlet.

Do not shut down the computer or initiate Sleep.

Do not insert, remove, connect, or disconnect any device, cable, or cord.

Downloading a BIOS update

After you review the prerequisites, you can check for and download BIOS updates.

1. Select the **Search** icon in the taskbar, type `support` in the search box, and then select the **HP Support Assistant** app.

- or -
Select the question mark icon (select products only) in the taskbar.
2. Select **Updates**, and then select **Check for updates and messages**.
3. Follow the on-screen instructions.
4. At the download area, follow these steps:
 - a. Identify the most recent BIOS update and compare it to the BIOS version currently installed on your computer. Make a note of the date, name, or other identifier. You might need this information to locate the update later, after it has been downloaded to your hard drive.
 - b. Follow the on-screen instructions to download your selection to the hard drive.

Make a note of the path to the location on your hard drive where the BIOS update is downloaded. You will need to access this path when you are ready to install the update.



NOTE: If you connect your computer to a network, consult the network administrator before installing any software updates, especially system BIOS updates.

Installing a BIOS update

BIOS installation procedures vary. Follow any instructions that are displayed on the screen after the download is complete. If no instructions are displayed, follow these steps.

1. Select the **Search** icon in the taskbar, type `file` in the search box, and then select **File Explorer**.
2. Select your hard drive designation. The hard drive designation is typically Local Disk (C:).
3. Using the hard drive path you recorded earlier, open the folder that contains the update.
4. Double-click the file that has an `.exe` extension (for example, `filename.exe`).

The BIOS installation begins.
5. Complete the installation by following the on-screen instructions.



NOTE: After a message on the screen reports a successful installation, you can delete the downloaded file from your hard drive.

Changing the boot order using the f9 prompt

To dynamically choose a boot device for the current startup sequence, follow these steps.

1. Access the Boot Device Options menu:
 - Turn on or restart the computer, and when the HP logo appears, press **f9** to enter the Boot Device Options menu.
2. Select a boot device, press **enter**, and then follow the on-screen instructions.

TPM BIOS settings (select products only)

TPM provides additional security for your computer. You can modify the TPM settings in Computer Setup (BIOS).

 **IMPORTANT:** Before enabling Trusted Platform Module (TPM) functionality on this system, you must ensure that your intended use of TPM complies with relevant local laws, regulations and policies, and approvals or licenses must be obtained if applicable. For any compliance issues arising from your operation or usage of TPM that violates the previously mentioned requirement, you shall bear all the liabilities wholly and solely. HP will not be responsible for any related liabilities.

 **NOTE:** If you change the TPM setting to Hidden, TPM is not visible in the operating system.

To access TPM settings in Computer Setup:

1. Start Computer Setup. See [Using Computer Setup on page 78](#).
2. Select **Security**, select **TPM Embedded Security**, and then follow the on-screen instructions.

Using HP Sure Start (select products only)

Select computer models are configured with HP Sure Start, a technology that monitors the computer's BIOS for attacks or corruption. If the BIOS becomes corrupted or is attacked, HP Sure Start automatically restores the BIOS to its previously safe state, without user intervention.

HP Sure Start is configured and already enabled so that most users can use the HP Sure Start default configuration. Advanced users can customize the default configuration.

To access the latest documentation on HP Sure Start, go to <http://www.hp.com/support>. Select **Find your product**, and then follow the on-screen instructions.

7 Backing up, restoring, and recovering

You can use Windows tools or HP software to back up your information, create a restore point, reset your computer, create recovery media, or restore your computer to its factory state. Performing these standard procedures can return your computer to a working state faster.

 **IMPORTANT:** If you are performing recovery procedures on a tablet, the tablet battery must be at least 70% charged before you start the recovery process.

 **IMPORTANT:** For a tablet with a detachable keyboard, connect the tablet to the keyboard base before beginning any recovery process.

Backing up information and creating recovery media

These methods of creating recovery media and backups are available on select products only.

Using Windows tools for backing up

HP recommends that you back up your information immediately after initial setup. You can do this task either using Windows Backup locally with an external USB flash drive or using online tools.

 **NOTE:** If computer storage is 32 GB or less, Microsoft® System Restore is disabled by default.

Using the HP Cloud Recovery Download Tool to create recovery media (select products only)

You can use the HP Cloud Recovery Download Tool to create HP Recovery media on a bootable USB flash drive.

For details:

- Go to <http://www.hp.com>, search for HP Cloud Recovery, and then select the result that matches the type of computer that you have.

 **NOTE:** If you cannot create recovery media yourself, contact support to obtain recovery discs. Go to <http://www.hp.com/support>, select your country or region, and then follow the on-screen instructions.

 **IMPORTANT:** HP recommends that you follow the [Restoring and recovery methods on page 83](#) to restore your computer before you obtain and use the HP recovery discs. Using a recent backup can return your machine to a working state sooner than using the HP recovery discs. After the system is restored, reinstalling all the operating system software released since your initial purchase can be a lengthy process.

Restoring and recovering your system

You have several tools available to recover your system both within and outside of Windows if the desktop cannot load.

HP recommends that you attempt to restore your system using the [Restoring and recovery methods on page 83](#).

Creating a system restore

System Restore is available in Windows. The System Restore software can automatically or manually create restore points, or snapshots, of the system files and settings on the computer at a particular point.

When you use System Restore, it returns your computer to its state at the time you made the restore point. Your personal files and documents should not be affected.

Restoring and recovery methods

After you run the first method, test to see whether the issue still exists before you proceed to the next method, which might now be unnecessary.

1. Run a Microsoft System Restore.
2. Run Reset this PC.



NOTE: The options **Remove everything** and then **Fully clean the drive** can take several hours to complete and leave no information on your computer. It is the safest way to reset your computer before you recycle it.

3. Recover using HP Recovery media. For more information, see [Recovering using HP Recovery media on page 83](#).

For more information about the first two methods, see the Get Help app:

- Select the **Start** button, select **All apps**, select the **Get Help** app, and then enter the task you want to perform.



NOTE: You must be connected to the internet to access the Get Help app.

Recovering using HP Recovery media

You can use HP Recovery media to recover the operating system and drivers that were installed at the factory. On select products, you can create recovery media on a bootable USB flash drive using the HP Cloud Recovery Download Tool.

For details, see [Using the HP Cloud Recovery Download Tool to create recovery media \(select products only\) on page 82](#).



NOTE: If you cannot create recovery media yourself, contact support to obtain recovery discs. Go to <http://www.hp.com/support>, select your country or region, and then follow the on-screen instructions.

To recover your system:

- Insert the HP Recovery media, and then restart the computer.

 **NOTE:** HP recommends that you follow the [Restoring and recovery methods on page 83](#) to restore your computer before you obtain and use the HP recovery discs. Using a recent backup can return your machine to a working state sooner than using the HP recovery discs. After the system is restored, reinstalling all the operating system software released since your initial purchase can be a lengthy process.

Changing the computer boot order

If your computer does not restart using the HP Recovery media, you can change the computer boot order, which is the order of devices listed in BIOS for startup information. You can select an optical drive or a USB flash drive, depending on the location of your HP Recovery media.

 **IMPORTANT:** For a tablet with a detachable keyboard, connect the tablet to the keyboard base before beginning these steps.

To change the boot order:

1. Insert the HP Recovery media.
2. Access the system **Startup** menu.
 - For computers or tablets with keyboards attached, turn on or restart the computer or tablet, quickly press **esc**, and then press **f9** for boot options.
 - For tablets without keyboards, turn on or restart the tablet, quickly press and hold the volume up button, and then select **f9**.

– or –

Turn on or restart the tablet, quickly press and hold the volume down button, and then select **f9**.
3. Select the optical drive or USB flash drive from which you want to boot, and then follow the on-screen instructions.

Using HP Sure Recover (select products only)

Select computer models are configured with HP Sure Recover, a PC operating system (OS) recovery solution built into the hardware and software. HP Sure Recover can fully restore the HP OS image without installed recovery software.

Using HP Sure Recover, an administrator or user can restore the system and install:

- Latest version of the operating system
- Platform-specific device drivers
- Software applications, in the case of a custom image

To access the latest documentation for HP Sure Recover, go to <http://www.hp.com/support>. Follow the on-screen instructions to find your product and locate your documentation.

8 Using HP PC Hardware Diagnostics

You can use the HP PC Hardware Diagnostics utility to determine whether your computer hardware is running properly. The three versions are HP PC Hardware Diagnostics Windows, HP PC Hardware Diagnostics UEFI (Unified Extensible Firmware Interface), and (for select products only) Remote HP PC Hardware Diagnostics UEFI, a firmware feature.

Using HP PC Hardware Diagnostics Windows (select products only)

HP PC Hardware Diagnostics Windows is a Windows-based utility that allows you to run diagnostic tests to determine whether the computer hardware is functioning properly. The tool runs within the Windows operating system to diagnose hardware failures.

If HP PC Hardware Diagnostics Windows is not installed on your computer, you must download and install it. To download HP PC Hardware Diagnostics Windows, see [Downloading HP PC Hardware Diagnostics Windows on page 86](#).

Using an HP PC Hardware Diagnostics Windows hardware failure ID code

When HP PC Hardware Diagnostics Windows detects a failure that requires hardware replacement, a 24-digit failure ID code is generated for select component tests. For interactive tests, such as keyboard, mouse, or audio and video palette, you must perform troubleshooting steps before you can receive a failure ID.

- You have several options after you receive a failure ID:
 - Select **Next** to open the Event Automation Service (EAS) page, where you can log the case.
 - Scan the QR code with your mobile device, which takes you to the EAS page, where you can log the case.
 - Select the box next to the 24-digit failure ID to copy your failure code and send it to support.

Accessing HP PC Hardware Diagnostics Windows

After HP PC Hardware Diagnostics Windows is installed, you can access it from HP Support Assistant or the Start menu.

Accessing HP PC Hardware Diagnostics Windows from HP Support Assistant

After HP PC Hardware Diagnostics Windows is installed, follow these steps to access it from HP Support Assistant:

1. Complete one of the following tasks:
 - Select the **Search** icon in the taskbar, type `support` in the search box, and then select the **HP Support Assistant** app.
 - Select the question mark icon in the taskbar.
2. Select **Fixes & Diagnostics**.
3. Select **Run hardware diagnostics**, and then select **Launch**.
4. When the tool opens, select the type of diagnostic test that you want to run, and then follow the on-screen instructions.

 **NOTE:** To stop a diagnostic test, select **Cancel**.

Accessing HP PC Hardware Diagnostics Windows from the Start menu (select products only)

After HP PC Hardware Diagnostics Windows is installed, follow these steps to access it from the Start menu:

1. Select the **Start** button, and then select **All apps**.
2. Select **HP PC Hardware Diagnostics Windows**.
3. When the tool opens, select the type of diagnostic test that you want to run, and then follow the on-screen instructions.

 **NOTE:** To stop a diagnostic test, select **Cancel**.

Downloading HP PC Hardware Diagnostics Windows

The HP PC Hardware Diagnostics Windows downloading instructions are provided in English only. You must use a Windows computer to download this tool because only .exe files are provided.

Downloading the latest HP PC Hardware Diagnostics Windows version from HP

To download HP PC Hardware Diagnostics Windows from HP, follow these steps:

1. Go to <http://www.hp.com/go/techcenter/pcdiags>. The HP PC Diagnostics home page is displayed.
2. Select **Download HP Diagnostics Windows**, and then select the specific Windows diagnostics version to download to your computer or a USB flash drive.

The tool downloads to the selected location.

Downloading the HP PC Hardware Diagnostics Windows from the Microsoft Store

You can download the HP PC Hardware Diagnostics Windows from the Microsoft Store:

1. Select the Microsoft Store app on your desktop or select the **Search** icon in the taskbar, and then type `Microsoft Store` in the search box.
2. Type `HP PC Hardware Diagnostics Windows` in the **Microsoft Store** search box.
3. Follow the on-screen directions.

The tool downloads to the selected location.

Downloading HP Hardware Diagnostics Windows by product name or number (select products only)

You can download HP PC Hardware Diagnostics Windows by product name or number.

 **NOTE:** For some products, you might have to download the software to a USB flash drive by using the product name or number.

1. Go to <http://www.hp.com/support>.
2. Select **Software and Drivers**, select your type of product, and then enter the product name or number in the search box that is displayed.
3. In the **Diagnostics** section, select **Download**, and then follow the on-screen instructions to select the specific Windows diagnostics version to be downloaded to your computer or USB flash drive.

The tool downloads to the selected location.

Installing HP PC Hardware Diagnostics Windows

To install HP PC Hardware Diagnostics Windows, navigate to the folder on your computer or the USB flash drive where the .exe file downloaded, double-click the .exe file, and then follow the on-screen instructions.

Using HP PC Hardware Diagnostics UEFI

HP PC Hardware Diagnostics Unified Extensible Firmware Interface (UEFI) allows you to run diagnostic tests to determine whether the computer hardware is functioning properly. The tool runs outside the operating system so that it can isolate hardware failures from issues that are caused by the operating system or other software components.

 **NOTE:** For some products, you must use a Windows computer and a USB flash drive to download and create the HP UEFI support environment because only .exe files are provided. For more information, see [Downloading HP PC Hardware Diagnostics UEFI to a USB flash drive on page 88](#).

If your PC does not start in Windows, you can use HP PC Hardware Diagnostics UEFI to diagnose hardware issues.

Using an HP PC Hardware Diagnostics UEFI hardware failure ID code

When HP PC Hardware Diagnostics UEFI detects a failure that requires hardware replacement, a 24-digit failure ID code is generated.

For assistance in solving the problem, complete one of these tasks:

- Select **Contact HP**, accept the HP privacy disclaimer, and then use a mobile device to scan the failure ID code that appears on the next screen. The HP Customer Support - Service Center page appears with your failure ID and product number automatically filled in. Follow the on-screen instructions.
- Contact support, and provide the failure ID code.

Starting HP PC Hardware Diagnostics UEFI

To start HP PC Hardware Diagnostics UEFI, follow this procedure.

1. Turn on or restart the computer, and quickly press **esc**.
2. Press **f2**.

The BIOS searches three places for the diagnostic tools, in the following order:

- a. Connected USB flash drive



NOTE: To download the HP PC Hardware Diagnostics UEFI tool to a USB flash drive, see [Downloading the latest HP PC Hardware Diagnostics UEFI version on page 89](#).

- b. Hard drive

- c. BIOS

3. When the diagnostic tool opens, select the type of diagnostic test that you want to run, and then follow the on-screen instructions.

Starting HP PC Hardware Diagnostics UEFI through HP Hotkey Support software (select products only)

This section describes how to start HP PC Hardware Diagnostics UEFI through HP Hotkey Support software.



NOTE: You must disable fast boot to access HP PC Hardware Diagnostics UEFI from the HP System Information application. To disable fast boot:

1. Turn on or restart the computer, and when the HP logo appears, press **f10** to enter Computer Setup.
2. Select **Advanced**, and then select **Boot Options**.
3. Clear **Fast Boot**.
4. Select **Save Changes and Exit**, and then select **Yes**.

1. From the **Start** menu, open the HP System Information Application or enter **fn+esc**.
2. In HP System Information screen, select **Run System Diagnostics**, select **Yes** to run the application, and then select **Restart**.



IMPORTANT: To prevent loss of data, save your work in all open apps before restarting your computer.



NOTE: When the restart is complete, the computer will boot to HP PC Hardware Diagnostics UEFI Application. Proceed with the troubleshooting tests.

Downloading HP PC Hardware Diagnostics UEFI to a USB flash drive

Downloading HP PC Hardware Diagnostics UEFI to a USB flash drive can be useful in some situations.

- HP PC Hardware Diagnostics UEFI is not included in the preinstallation image.
- HP PC Hardware Diagnostics UEFI is not included in the HP Tool partition.
- The hard drive is damaged.



NOTE: The HP PC Hardware Diagnostics UEFI downloading instructions are provided in English only, and you must use a Windows computer to download and create the HP UEFI support environment because only .exe files are provided.

Downloading the latest HP PC Hardware Diagnostics UEFI version

To download the latest HP PC Hardware Diagnostics UEFI version to a USB flash drive, follow this procedure:

1. Go to <http://www.hp.com/go/techcenter/pcdiags>. The HP PC Diagnostics home page is displayed.
2. Select **Download HP Diagnostics UEFI**, and then select **Run**.

Downloading HP PC Hardware Diagnostics UEFI by product name or number (select products only)

You can download HP PC Hardware Diagnostics UEFI by product name or number (select products only) to a USB flash drive.



NOTE: For some products, you might have to download the software to a USB flash drive by using the product name or number.

1. Go to <http://www.hp.com/support>.
2. Enter the product name or number, select your computer, and then select your operating system.
3. In the **Diagnostics** section, follow the on-screen instructions to select and download the specific UEFI Diagnostics version for your computer.

Using Remote HP PC Hardware Diagnostics UEFI settings (select products only)

Remote HP PC Hardware Diagnostics UEFI is a firmware (BIOS) feature that downloads HP PC Hardware Diagnostics UEFI to your computer. It can then run the diagnostics on your computer, and it might upload results to a preconfigured server.

For more information about Remote HP PC Hardware Diagnostics UEFI, go to <http://www.hp.com/go/techcenter/pcdiags>, and then select **Find out more**.

Downloading Remote HP PC Hardware Diagnostics UEFI

Remote HP PC Hardware Diagnostics UEFI is also available as a SoftPaq that you can download to a server.

Downloading the latest Remote HP PC Hardware Diagnostics UEFI version

You can download the latest Remote HP PC Hardware Diagnostics UEFI version to a USB flash drive.

1. Go to <http://www.hp.com/go/techcenter/pcdiags>. The HP PC Diagnostics home page is displayed.
2. Select **Download Remote Diagnostics**, and then select **Run**.

Downloading Remote HP PC Hardware Diagnostics UEFI by product name or number

You can download Remote HP PC Hardware Diagnostics UEFI by product name or number.



NOTE: For some products, you might have to download the software by using the product name or number.

1. Go to <http://www.hp.com/support>.

2. Select **Software and Drivers**, select your type of product, enter the product name or number in the search box that is displayed, select your computer, and then select your operating system.
3. In the **Diagnostics** section, follow the on-screen instructions to select and download the **Remote UEFI** version for the product.

Customizing Remote HP PC Hardware Diagnostics UEFI settings

Using the Remote HP PC Hardware Diagnostics setting in Computer Setup (BIOS), you can perform several customizations.

- Set a schedule for running diagnostics unattended. You can also start diagnostics immediately in interactive mode by selecting **Execute Remote HP PC Hardware Diagnostics UEFI**.
- Set the location for downloading the diagnostic tools. This feature provides access to the tools from the HP website or from a server that has been preconfigured for use. Your computer does not require the traditional local storage (such as a hard drive or USB flash drive) to run remote diagnostics.
- Set a location for storing the test results. You can also set the user name and password that you use for uploads.
- Display status information about the diagnostics runs previously.

To customize Remote HP PC Hardware Diagnostics UEFI settings, follow these steps:

1. Turn on or restart the computer, and when the HP logo appears, press **f10** to enter Computer Setup.
2. Select **Advanced**, and then select **Settings**.
3. Make your customization selections.
4. Select **Exit**, then select **Save Changes and Exit** to save your settings.

Your changes take effect when the computer restarts.

9 Specifications

This chapter provides specifications for your computer system.

Computer specifications

This section provides specifications for your computer. When you travel with your computer, the computer dimensions and weights, as well as input power ratings and operating specifications, provide helpful information.

Table 9-1 Computer specifications

	Metric	U.S.
Dimensions		
Width	35.6 cm	14.0 in
Depth	24.2 cm	9.5 in
Height (front to back)	1.9 cm	0.8 in
Weight	1.7 kg	3.8 lbs
Input power		
Operating voltage and current	19.5 V DC @ 2.31 A - 45 W	
	19.5 V DC @ 3.33 A - 65 W	
	19.5 V DC @ 4.62 A - 90 W	
	19.5 V DC @ 7.70 A - 150 W	
	19.5 V DC @ 10.3 A - 200 W	
Temperature		
Operating	5°C to 35°C	41°F to 95°F
Nonoperating	-20°C to 60°C	-4°F to 140°F
Relative humidity (noncondensing)		
Operating	10% to 90%	
Nonoperating	5% to 95%	
Maximum altitude (unpressurized)		
Operating	-15 m to 3,048 m	-50 ft to 10,000 ft
Nonoperating	-15 m to 12,192 m	-50 ft to 40,000 ft

Table 9-1 Computer specifications (continued)

	Metric	U.S.
NOTE: Applicable product safety standards specify thermal limits for plastic surfaces. The device operates well within this range of temperatures.		

Display specifications

This section provides specifications for your display.

Table 9-2 Display specifications

	Metric	U.S.
Active diagonal size	40.6 cm	16.0 in
Resolution	3840 × 2400 1920 × 1200	
Surface treatment	Antiglare Brighview	
Brightness	500 nits 400 nits	
Viewing angle	UWVA	
Backlight	OLED + LBL WLED + LBL LED	
Display panel interface	eDP 1.4 + PSR2 eDP 1.4 + PSR	

Solid-state drive specifications

This section provides specifications for your solid-state drives.

Table 9-3 Solid-state drive specifications

	256 GB*	512 GB*	1TB*
Dimensions			
Height	1.0 mm	1.0 mm	1.0 mm
Length	50.8 mm	50.8 mm	50.8 mm
Width	28.9 mm	28.9 mm	28.9 mm
Weight	< 10 g	< 10 g	< 10 g
Interface type			
Ready time, maximum (to not busy)	1.0 ms	< 1.0 ms	1.0 ms

Table 9-3 Solid-state drive specifications (continued)

	256 GB*	512 GB*	1 TB*
Access times, logical	0.1 ms	0.1 ms	0.1 ms
Transfer rate			
Sequential read	up to 2150 MBps	up to 2150 MBps	up to 2150 MBps
Random read	Up to 300,000 IOPs	Up to 300,000 IOPs	Up to 300,000 IOPs
Sequential write	up to 1550 MBps	up to 1550 MBps	up to 1550 MBps
Random write	Up to 100,000 IOPs	Up to 100,000 IOPs	Up to 100,000 IOPs
Total logical sectors	468,883,296	1,000,215,216	1,500,336,388
Operating temperature	0°C to 70°C (32°F to 158°F)		
*1 GB = 1 billion bytes when referring to hard drive storage capacity. Actual accessible capacity is less. Actual drive specifications might differ slightly.			
NOTE: Certain restrictions and exclusions apply. Contact support for details.			

10 Statement of memory volatility

For general information regarding nonvolatile memory in HP business computers, and to restore nonvolatile memory that can contain personal data after the system has been turned off and the hard drive has been removed, use these instructions.

HP business computer products that use Intel®-based or AMD®-based system boards contain volatile DDR memory. The amount of nonvolatile memory present in the system depends upon the system configuration. Intel-based and AMD-based system boards contain nonvolatile memory subcomponents as originally shipped from HP, with the following assumptions:

- No subsequent modifications were made to the system.
- No applications, features, or functionality were added to or installed on the system.

Following system shutdown and removal of all power sources from an HP business computer system, personal data can remain on volatile system memory (DIMMs) for a finite period of time and also remains in nonvolatile memory. Use the following steps to remove personal data from the computer, including the nonvolatile memory found in Intel-based and AMD-based system boards.



NOTE: If your tablet has a keyboard base, connect to the keyboard base before beginning steps in this chapter.

Current BIOS steps

Use these instructions to restore nonvolatile memory.

1. Follow these steps to restore the nonvolatile memory that can contain personal data. Restoring or reprogramming nonvolatile memory that does not store personal data is neither necessary nor recommended.

- a. Turn on or restart the computer, and then quickly press **esc**.



NOTE: If the system has a BIOS administrator password, type the password at the prompt.

- b. Select **Main**, select **Apply Factory Defaults and Exit**, and then select **Yes** to load defaults. The computer restarts.
- c. During the restart, press **esc** while the "Press the ESC key for Startup Menu" message is displayed at the bottom of the screen.



NOTE: If the system has a BIOS administrator password, type the password at the prompt.

- d. Select the **Security** menu, select **Restore Security Settings to Factory Defaults**, and then select **Yes** to restore security level defaults. The computer restarts.
- e. During the restart, press **esc** while the "Press the ESC key for Startup Menu" message is displayed at the bottom of the screen.



NOTE: If the system has a BIOS administrator password, type the password at the prompt.

- f. If an asset or ownership tag is set, select the **Security** menu and scroll down to the **Utilities** menu. Select **System IDs**, and then select **Asset Tracking Number**. Clear the tag, and then make the selection to return to the prior menu.
- g. If a DriveLock password is set, select the **Security** menu, and scroll down to **Hard Drive Utilities** under the **Utilities** menu. Select **Hard Drive Utilities**, select **DriveLock**, and then clear the check box for **DriveLock password on restart**. Select **OK** to proceed.
- h. Select the **Main** menu, and then select **Reset BIOS Security to factory default**. Select **Yes** at the warning message. The computer restarts.
- i. During the restart, press **esc** while the "Press the ESC key for Startup Menu" message is displayed at the bottom of the screen.



NOTE: If the system has a BIOS administrator password, type the password at the prompt.

- j. Select the **Main** menu, select **Apply Factory Defaults and Exit**, select **Yes** to save changes and exit, and then select **Shutdown**.
 - k. Restart the system. If the system has a Trusted Platform Module (TPM), fingerprint reader, or both, one or two prompts will appear—one to clear the TPM and the other to Reset Fingerprint Sensor. Press or tap **f1** to accept or **f2** to reject.
 - l. Remove all power and system batteries for at least 24 hours.
2. Complete one of the following:
- Remove and retain the storage drive.
- or -
 - Clear the drive contents by using a third-party utility designed to erase data from an SSD.
- or -
 - Clear the contents of the drive by using the following BIOS Setup Secure Erase command option steps:



NOTE: If you clear data using Secure Erase, you cannot recover it.

- a. Turn on or restart the computer, and then quickly press **esc**.
- b. Select the **Security** menu and scroll down to the **esc** menu.
- c. Select **Hard Drive Utilities**.
- d. Under **Utilities**, select **Secure Erase**, select the hard drive storing the data you want to clear, and then follow the on-screen instructions to continue.
- or -

Clear the contents of the drive using the following Disk Sanitizer commands steps:

- i. Turn on or restart the computer, and then quickly press **esc**.
- ii. Select the **Security** menu and scroll down to the **Utilities** menu.
- iii. Select **Hard Drive Utilities**.
- iv. Under **Utilities**, select **Disk Sanitizer**, select the hard drive with the data that you want to clear, and then follow the on-screen instructions to continue.

 **NOTE:** The amount of time it takes for Disk Sanitizer to run can take several hours. Plug the computer into an AC outlet before starting.

Nonvolatile memory usage

Use this table to troubleshoot nonvolatile memory usage.

Table 10-1 Troubleshooting steps for nonvolatile memory usage

Description	Volatility description	Storage user data	How to erase
Primary storage device, holds the OS, applications, and application settings	Non-volatile, 8-256 GB of eMMC or NVMe SSD storage, removable	Yes ¹	Follow instructions below under “Erase the Primary Storage Device”
System memory (RAM), holds transient data during system operation	Volatile, SODIMM socket. Removable (4 GB/8 GB/16 GB)	Yes	Unplug unit from power
Permanent system BIOS settings	Non-volatile; 16 KB; stored	No ²	Follow instructions below under “Clearing BIOS Settings”
System boot ROM (BIOS)	Non-volatile memory, 128 Mbit (16 MB) socketed, removable	No	Download the latest BIOS for your model from the HP website and follow the instructions to flash the BIOS that are on the website
RTC (CMOS) RAM	Volatile memory, 256 bytes located in AMD embedded System on Chip (SoC)	No	Unplug unit from main power, remove top cover and press Clear CMOS button
Keyboard/mouse (ROM)	Non-volatile, 2 KB embedded in the super I/O controller (SIO2)	Yes	N/A
Keyboard/mouse (RAM)	Volatile, 256 bytes embedded in the super I/O controller (SIO2)	No	Unplug unit from main power
LOM EEPROM	Non-volatile, 2 MB embedded in LAN controller	No	N/A
Trusted Platform Module (TPM)	Non-volatile; 51 KB ROM for firmware and 38 KB system parametric data	No ³	Follow instructions below under “Clearing TPM”

¹ Under typical operation, the only user data stored on the primary storage device are preferences for device configuration and settings for connections. However, the administrator can configure the system to allow users to store data locally.

² Only user data potentially stored in BIOS Settings are the ownership and asset tags, administrator password, and startup password.

³ The Trusted Platform Module may contain encrypted passwords or certificates generated from user or administrator input.

Questions and answers

Use this section to answer your questions about nonvolatile memory.

1. How can the BIOS settings be restored (returned to factory settings)?

 **IMPORTANT:** The restore defaults feature does not securely erase any information on your hard drive. See question and answer 6 for steps to securely erase information.

The restore defaults feature does not reset the Custom Secure Boot keys. See question and answer 7 for information about resetting the keys.

- a. Turn on or restart the computer, and then quickly press `esc`.
- b. Select **Main**, and then select **Apply Factory Defaults and Exit**.
- c. Follow the on-screen instructions.
- d. Select **Main**, select **Save Changes and Exit**, and then follow the on-screen instructions.

2. What is a UEFI BIOS, and how is it different from a legacy BIOS?

The Unified Extensible Firmware Interface (UEFI) BIOS is an industry-standard software interface between the platform firmware and an operating system (OS). It replaces the older BIOS architecture but supports much of the legacy BIOS functionality.

Like the legacy BIOS, the UEFI BIOS provides an interface to display the system information and configuration settings and to change the configuration of your computer before an OS is loaded. BIOS provides a secure runtime environment that supports a Graphic User Interface (GUI). In this environment, you can use either a pointing device (touch screen, touchpad, pointing stick, or USB mouse) or the keyboard to navigate and make menu and configuration selections. The UEFI BIOS also contains basic system diagnostics.

The UEFI BIOS provides functionality beyond that of the legacy BIOS. In addition, the UEFI BIOS works to initialize the computer's hardware before loading and executing the OS; the runtime environment allows the loading and execution of software programs from storage devices to provide more functionality, such as advanced hardware diagnostics (with the ability to display more detailed system information) and advanced firmware management and recovery software.

HP has provided options in Computer Setup (BIOS) to allow you to run in legacy BIOS, if required by the operating system. Examples of this requirement would be if you upgrade or downgrade the OS.

3. Where is the UEFI BIOS located?

The UEFI BIOS is located on a flash memory chip. You must use a utility to write to the chip.

4. What kind of configuration data is stored on the DIMM Serial Presence Detect (SPD) memory module? How would this data be written?

The DIMM SPD memory contains information about the memory module, such as size, serial number, data width, speed and timing, voltage, and thermal information. This information is written by the module manufacturer and stored on an EEPROM. You cannot write to this EEPROM when the memory module is installed in a computer. Third-party tools do exist that can write to the EEPROM when the memory module is not installed in a computer. Various third-party tools are available to read SPD memory.

5. What is meant by "Restore the nonvolatile memory found in Intel-based system boards"?

This message relates to clearing the Real Time Clock (RTC) CMOS memory that contains computer configuration data.

6. How can the BIOS security be reset to factory defaults and erase the data?

 **IMPORTANT:** Resetting results in the loss of information.

These steps do not reset Custom Secure Boot Keys. See question and answer 7 for information about resetting the keys.

- a. Turn on or restart the computer, and then quickly press **esc**.
- b. Select **Main**, and then select **Reset Security to Factory Defaults**.
- c. Follow the on-screen instructions.
- d. Select **Main**, select **Save Changes and Exit**, and then follow the on-screen instructions.

7. How can the Custom Secure Boot Keys be reset?

Secure Boot is a feature to ensure that only authenticated code can start on a platform. If you enabled Secure Boot and created Custom Secure Boot Keys, disabling Secure Boot does not clear the keys. You must also select to clear the Custom Secure Boot Keys. Use the same Secure Boot access procedure that you used to create the Custom Secure Boot Keys, but select to clear or delete all Secure Boot Keys.

- a. Turn on or restart the computer, and then quickly press **esc**.
- b. Select the **Security** menu, select **Secure Boot Configuration**, and then follow the on-screen instructions.
- c. At the **Secure Boot Configuration** window, select **Secure Boot**, select **Clear Secure Boot Keys**, and then follow the on-screen instructions to continue.

Using HP Sure Start (select products only)

Select computer models are configured with HP Sure Start, a technology that continuously monitors your computer's BIOS for attacks or corruption.

If the BIOS becomes corrupted or is attacked, HP Sure Start restores the BIOS to its previously safe state, without user intervention. Those select computer models ship with HP Sure Start configured and enabled. HP Sure Start is configured and already enabled so that most users can use the HP Sure Start default configuration. Advanced users can customize the default configuration.

To access the latest documentation on HP Sure Start, go to <http://www.hp.com/support>.

11 Power cord set requirements

This chapter provides power cord requirements for countries and regions.

The wide-range input feature of the computer permits it to operate from any line voltage from 100 V AC to 120 V AC, or from 220 V AC to 240 V AC.

The three-conductor power cord set included with the computer meets the requirements for use in the country or region where the equipment is purchased.

Power cord sets for use in other countries or regions must meet the requirements of the country and region where the computer is used.

Requirements for all countries

These power cord requirements are applicable to all countries and regions.

- The length of the power cord set must be at least **1.0 m** (3.3 ft) and no more than **2.0 m** (6.5 ft).
- All power cord sets must be approved by an acceptable accredited agency responsible for evaluation in the country or region where the power cord set will be used.
- The power cord sets must have a minimum current capacity of 10 A and a nominal voltage rating of 125 V AC or 250 V AC, as required by the power system of each country or region.
- The appliance coupler must meet the mechanical configuration of an EN 60 320/IEC 320 Standard Sheet C13 connector for mating with the appliance inlet on the back of the computer.

Requirements for specific countries and regions

To determine power cord requirements for specific countries and regions, use this table.

Table 11-1 Power cord requirements for specific countries and regions

Country/region	Accredited agency	Applicable note number
Argentina	IRAM	1
Australia	SAA	1
Austria	OVE	1
Belgium	CEBEC	1
Brazil	ABNT	1
Canada	CSA	2

Table 11-1 Power cord requirements for specific countries and regions (continued)

Country/region	Accredited agency	Applicable note number
Chile	IMQ	1
Denmark	DEMKO	1
Finland	FIMKO	1
France	UTE	1
Germany	VDE	1
India	BIS	1
Israel	SII	1
Italy	IMQ	1
Japan	JIS	3
Netherlands	KEMA	1
New Zealand	SANZ	1
Norway	NEMKO	1
People's Republic of China	CCC	4
Saudi Arabia	SASO	7
Singapore	PSB	1
South Africa	SABS	1
South Korea	KTL	5
Sweden	SEMKO	1
Switzerland	SEV	1
Taiwan	BSMI	6
Thailand	TISI	1
United Kingdom	ASTA	1
United States	UL	2

Table 11-1 Power cord requirements for specific countries and regions (continued)

Country/region	Accredited agency	Applicable note number
		1. The flexible cord must be Type HO5VV-F, three-conductor, 0.75 mm ² conductor size. Power cord set fittings (appliance coupler and wall plug) must bear the certification mark of the agency responsible for evaluation in the country or region where it will be used.
		2. The flexible cord must be Type SVT/SJT or equivalent, No. 18 AWG, three-conductor. The wall plug must be a two-pole grounding type with a NEMA 5-15P (15 A, 125 V AC) or NEMA 6-15P (15 A, 250 V AC) configuration. CSA or C-UL mark. UL file number must be on each element.
		3. The appliance coupler, flexible cord, and wall plug must bear a T mark and registration number in accordance with the Japanese Dentori Law. The flexible cord must be Type VCTF, three-conductor, 0.75 mm ² or 1.25 mm ² conductor size. The wall plug must be a two-pole grounding type with a Japanese Industrial Standard C8303 (7 A, 125 V AC) configuration.
		4. The flexible cord must be Type RVV, three-conductor, 0.75 mm ² conductor size. Power cord set fittings (appliance coupler and wall plug) must bear the CCC certification mark.
		5. The flexible cord must be Type H05VV-F three-conductor, 0.75 mm ² conductor size. KTL logo and individual approval number must be on each element. Approval number and logo must be printed on a flag label.
		6. The flexible cord must be Type HVCTF three-conductor, 1.25 mm ² conductor size. Power cord set fittings (appliance coupler, cable, and wall plug) must bear the BSMI certification mark.
		7. For 127 V AC, the flexible cord must be Type SVT or SJT 3-conductor, 18 AWG, with plug NEMA 5-15P (15 A, 125 V AC), with UL and CSA or C-UL marks. For 240 V AC, the flexible cord must be Type H05VV-F three-conductor, 0.75 mm ² or 1.00 mm ² conductor size, with plug BS 1363/A with BSI or ASTA marks.

12 Recycling

When a nonrechargeable or rechargeable battery has reached the end of its useful life, do not dispose of the battery in general household waste. Follow the local laws and regulations in your area for battery disposal.

HP encourages customers to recycle used electronic hardware, HP original print cartridges, and rechargeable batteries. For more information about recycling programs, see the HP website at <http://www.hp.com/recycle>.

Index

A

- AC adapter
 - product description 3
 - spare part numbers 27
- adapter, spare part numbers 27
- ALS board
 - illustrated 27
 - removal 57
 - spare part number 27, 57
- antenna
 - illustrated 21
 - removal 66
 - spare part number 21, 66
- audio jack
 - illustrated 22
 - removal 75
 - spare part number 22, 75
- audio-out (headphone)/audio-in (microphone) combo jack, identifying 8
- audio, product description 2

B

- backpack, spare part number 27
- backup, creating 82
- backups 82
- battery
 - illustrated 25
 - removal 46
 - spare part number 25, 46
- battery light 7
- bezel
 - spare part number 53
- BIOS
 - determining version 79
 - downloading an update 79, 80
 - updating 79
- boot order
 - changing using the f9 prompt 80
- boot order, changing 84

- bottom cover
 - illustrated 25
 - removal 40
 - spare part number 25, 40
- bottom speaker
 - removal 44
 - spare part number 44
- bottom speakers
 - illustrated 25
 - spare part number 22, 25
- buttons
 - power 14, 16

C

- cable, spare part number 27
- camera 9
 - identifying 9
- camera light, identifying 9
- camera privacy key, identifying 15
- camera privacy light, identifying 12
- caps lock light, identifying 12
- card reader, product description 3
- caring for your computer 35
- cautions
 - electrostatic discharge 31, 32
- chipset, product description 1
- cleaning your computer 35
 - caring for wood veneer 37
 - disinfecting 36
 - HP Easy Clean 35
 - removing dirt and debris 35
- components
 - bottom 16
 - display 8
 - keyboard area 9
 - left side 6
 - right side 5
- Computer Setup
 - navigating and selecting 78

- restoring factory settings 79
- starting 78
- computer specifications 91
- connector, power 7
- control zone 11

D

- display
 - specifications 91, 92
- Display Adhesive Kit, spare part number 26
- display assembly
 - removal 51
 - subcomponents 25
- display back cover
 - illustrated 27
 - spare part number 27
 - spare part numbers 55
- display bezel
 - illustrated 26
 - removal 53
 - spare part number 26
- display components 8
- display panel
 - product description 1
- display panel assembly
 - illustrated 26
 - removal 54
 - spare part numbers 26
- display panel cable
 - illustrated 26
 - spare part number 26
- dock, spare part number 27
- duckhead adapter, spare part number 27

E

- electrostatic discharge (ESD) 31, 32
 - preventing damage 31-33
- esc key, identifying 15

- F**
- fan
 - illustrated 25
 - spare part numbers 25
- fans
 - removal 49
 - spare part number 49
- fingerprint reader
 - illustrated 22
 - removal 68
 - spare part number 22, 68
- fingerprint reader bracket
 - illustrated 22
 - removal 69
 - spare part number 22, 69
- fingerprint reader cable
 - illustrated 22
 - removal 67
 - spare part number 22, 67
- fingerprint reader, identifying 14
- fn key, identifying 15
- fn lock light, identifying 12
- G**
- graphics controller
 - product description 1
- graphics memory
 - product description 2
- grounding methods 31-33
- guidelines
 - packaging 31, 37
 - transporting 31, 37
 - workstation 31
- H**
- hard drive
 - specifications 91
- hardware, locating 5
- heat sink
 - illustrated 25
 - removal 49
 - spare part numbers 25, 49
- hinge
 - illustrated 27
 - removal 61
 - spare part number 27, 61
- hinge cover
 - illustrated 26
 - removal 53
 - spare part number 26, 53
- HP PC Hardware Diagnostics UEFI
 - downloading 88
 - failure ID code 87
- HP Hotkey Support
 - software 88
 - starting 87, 88
 - using 87
- HP PC Hardware Diagnostics
 - Windows
 - accessing 85, 86
 - downloading 86
 - failure ID code 85
 - installing 87
 - using 85
- HP Recovery media
 - recovery 83
- HP Sure Recover 84
- HP Sure Start 94, 98
- I**
- I/O bracket
 - removal 65
 - spare part number 65
- illustrated parts catalog 19
- Insulator Kit
 - contents 27
 - spare part number 27
- J**
- jacks
 - audio-out (headphone)/audio-in (microphone) combo 8
- K**
- keyboard
 - product description 3
- keyboard, spare part number 27
- keys
 - camera privacy 15
 - esc 15
 - fn 15
 - Windows 15
- L**
- labels
 - contents 17
 - locations 17
- left control zone, identifying 11
- left side components 6
- lights
 - AC adapter and battery 7
 - battery 7
 - camera 9
 - camera privacy 12
 - caps lock 12
 - fn lock 12
 - microphone mute 12
 - power 12
 - privacy key 12
- lights, mute 12
- lock, spare part numbers 27
- low blue light mode 8
- M**
- memory
 - nonvolatile 94
 - volatile 94
- memory module
 - illustrated 25
 - product description 2
 - removal 47
 - spare part numbers 25, 47
- memory module shield
 - illustrated 25
 - removal 48
 - spare part number 48
- memory moduleshield
 - spare part number 25
- microphone
 - illustrated 26
 - product description 2
 - removal 55
 - spare part number 26, 55
- microphone mute light, identifying 12
- microSD memory card reader, identifying 6
- model name 1
- motion board
 - illustrated 27
 - removal 58
 - spare part number 27, 59
- motion board cable
 - illustrated 27
 - removal 58
 - spare part number 27, 58
- mouse, spare part numbers 28
- mute light, identifying 12
- N**
- nonvolatile memory 94
- O**
- operating system, product description 4
- optical drive, spare part number 28

P

- packaging guidelines 31, 37
- Plastics Kit
 - contents 28
 - spare part number 28
- pointing device, product description 3
- ports
 - USB port with 5 Gbps signaling rate and HP Sleep and Charge 6
 - USB Type-C 10 Gbps signaling rate power connector port with HP Sleep and Charge and DisplayPort output 6
 - USB Type-C 40 Gbps signaling rate power connector and Thunderbolt port with HP Sleep and Charge 7
- ports, product description 3
- power button, identifying 14, 16
- power connector
 - identifying 7
 - identifying USB Type-C 7
- power cord
 - requirements for all countries 99
 - requirements for specific countries and regions 99
 - set requirements 99
 - spare part numbers 28, 29
- power lights 12
- power requirements, product description 3
- privacy key light 12
- processor
 - product description 1
- product description
 - audio 2
 - card reader 3
 - chipset 1
 - display panel 1
 - graphics controller 1
 - graphics memory 2
 - keyboard 3
 - memory module 2
 - microphone 2
 - operating system 4
 - pointing device 3
 - ports 3
 - power requirements 3
 - processors 1
 - product name 1
 - security 4

- sensors 4
- serviceability 4
- storage 2
- video 2
- wireless 3

product name 1

R

- recovery 82, 83
 - discs 83
 - media 83
 - USB flash drive 83
- recovery media 82
 - creating using HP Cloud Recovery Download Tool 82
 - creating using Windows tools 82
- Remote HP PC Hardware Diagnostics UEFI settings customizing 90
- using 89
- removal and replacement procedures 40
- removing personal data from volatile system memory 94
- restoring 82
- restoring and recovery methods 83
- right control zone, identifying 11
- right side components 5
- RTC battery
 - illustrated 21
 - spare part number 21

S

- Screw Kit, spare part number 30
- SD card insert
 - removal 66
 - spare part number 66
- security cable slot, identifying 6
- security, product description 4
- sensor board
 - illustrated 27
 - removal 60
 - spare part number 27, 61
- sensor board cable
 - illustrated 27
 - removal 59
 - spare part number 27, 60
- sensors, product description 4
- serviceability, product description 4

- setup utility
 - navigating and selecting 78
 - restoring factory settings 79
- Shield Kit, spare part number 25
- slots
 - security cable 6
- software, locating 5
- solid-state drive
 - illustrated 25
 - removal 42
 - spare part numbers 25, 42
 - specifications 92
- solid-state drive shield
 - illustrated 25
 - removal 43
 - spare part number 25, 43
- spare part country codes 76
- speaker
 - removal 44
 - spare part numbers 44
- Speaker Kit, spare part number 22, 25
- speakers
 - illustrated 22, 25
 - spare part number 22, 25
- speakers, identifying 13, 16
- special keys, using 14
- specifications
 - computer 91
 - display 91, 92
 - hard drive 91
 - solid-state drive 92
- static electricity 31, 32
- storage
 - product description 2
- support information 38
- Sure Start
 - using 81
- system board
 - illustrated 22
 - removal 62
 - spare part numbers 22, 62
- System Board Repair Kit, spare part number 25
- system memory, removing
 - personal data from volatile 94
- system restore 83
- system restore point, creating 82

T

- top cover with keyboard
 - illustrated 20
 - spare part numbers 20, 76

- top speakers
 - illustrated 22
 - removal 74
 - spare part number 74
- touchpad
 - illustrated 22
 - removal 72
 - settings 10
 - spare part number 22, 72
- touchpad cable
 - illustrated 22
 - removal 71
 - spare part number 22, 71
- touchpad settings, adjusting 10
- touchpad zone, identifying 11
- TPM settings 81
- transfer board
 - illustrated 22
 - removal 70
 - spare part number 22, 70
- transfer board cable
 - illustrated 22
 - removal 69
 - spare part number 22, 69
- transporting guidelines 31, 37

U

- USB port 5 Gbps signaling rate and HP Sleep and Charge, identifying 6
- USB Type-C 10 Gbps signaling rate power connector port with HP Sleep and Charge and DisplayPort output, identifying 6
- USB Type-C 40 Gbps signaling rate power connector and Thunderbolt port with HP Sleep and Charge, identifying 7

V

- vents, identifying 17
- video, product description 2

W

- webcam
 - illustrated 26
 - removal 56
 - spare part number 26, 57
- webcam cable
 - illustrated 27
 - removal 56
 - spare part number 27, 56

- Windows
 - backup 82
 - recovery media 82
 - system restore point 82
- Windows key, identifying 15
- Windows tools, using 82
- wireless antenna
 - illustrated 21
 - removal 66
 - spare part number 21, 66
- wireless antennas, identifying 9
- wireless, product description 3
- WLAN antenna
 - illustrated 21
 - removal 66
 - spare part number 21, 66
- WLAN antenna cover
 - removal 65
 - spare part number 65
- WLAN antennas, identifying 9
- workstation guidelines 31