

User's Guide

XGS2220 Series

30/54-port GbE/SFP Smart Managed Layer-3 Switch

Default Login Details

LAN IP Address	http://setup.zyxel or http://DHCP-assigned IP or http://192.168.1.1
User Name	admin
Password	1234

Version 4.80 Edition 3, 08/2023

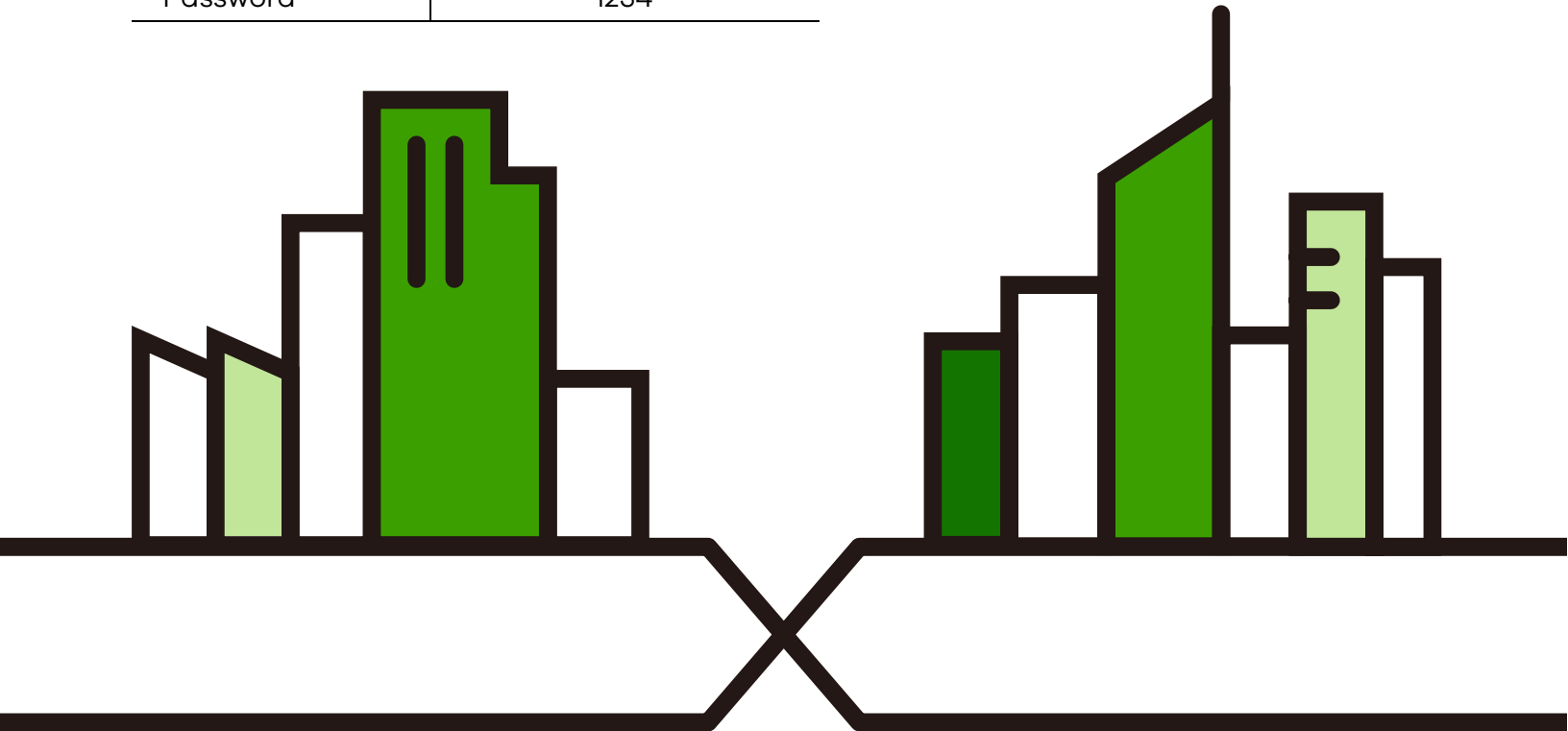

IMPORTANT!

READ CAREFULLY BEFORE USE.

KEEP THIS GUIDE FOR FUTURE REFERENCE.

This is a User's Guide for a series of products. Not all products support all firmware features. Screenshots and graphics in this book may differ slightly from your products due to differences in your product firmware or your computer operating system. Every effort has been made to ensure that the information in this manual is accurate.

Note: The version number on the cover page refers to the Switch's latest firmware version to which this User's Guide applies.

Related Documentation

- Quick Start Guide
The Quick Start Guide shows how to connect the Switch.
- CLI Reference Guide
This guide explains how to use the Command-Line Interface (CLI) to configure the Switch.

Note: It is recommended you use the Web Configurator to configure the Switch.

- Web Configurator Online Help
Click the help link for a description of the fields in the Switch menus.
- Nebula Control Center (NCC) User's Guide
Go to nebula.zyxel.com or support.zyxel.com to get this User's Guide on how to configure the Switch using Nebula.
- More Information
Go to support.zyxel.com to find other information on the Switch.



Document Conventions

Warnings and Notes

These are how warnings and notes are shown in this guide.

Warnings tell you about things that could harm you or your device.









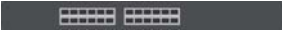

Note: Notes tell you other important information (for example, other things you may need to configure or helpful tips) or recommendations.

Syntax Conventions

- All models may be referred to as the "Switch" in this guide.
- Product labels, screen names, field labels and field choices are all in **bold** font.
- A right angle bracket (>) within a screen name denotes a mouse click. For example, **SYSTEM > IP Setup > Network Proxy Configuration** means you first click **SYSTEM** in the navigation panel, then the **IP Setup** sub menu, then **Network Proxy Configuration** to get to that screen.

Icons Used in Figures

Figures in this user guide may use the following generic icons. The Switch icon is not an exact representation of your device.

Switch 	Generic Router 	Wireless Router / Access Point 
Generic Switch 	Smart TV 	Desktop 
Laptop 	IP Camera 	Printer 
Server 		

Contents Overview

User's Guide	27
Getting to Know Your Switch	28
Hardware Installation and Connection	41
Hardware Panels	45
Technical Reference	57
Web Configurator	58
Initial Setup Example	101
Tutorials	106
DASHBOARD	117
MONITOR	123
ARP Table	124
IP Table	126
IPv6 Neighbor Table	128
MAC Table	130
Neighbor	133
Path MTU Table	139
Port Status	140
Routing Table	149
System Information	151
System Log	156
SYSTEM	157
Cloud Management	158
General Setup	160
Interface Setup	164
IP Setup	166
IPv6	173
Logins	190
SNMP	192
Stacking	203
Switch Setup	211
Syslog Setup	214
Time Range	217
PORT	220
Auto PD Recovery	221
Flex Link	226
Green Ethernet	230
Link Aggregation	234

Link Layer Discovery Protocol (LLDP)	245
OAM	272
PoE Setup	282
Port Setup	291
ZULD	294
SWITCHING	300
Layer 2 Protocol Tunneling	301
Loop Guard	306
MAC Pinning	310
Mirroring	313
Multicast	315
Static Multicast Forwarding	346
PPPoE	351
Differentiated Services	360
Queuing Method	365
Priority Queue	369
Bandwidth Control	371
sFlow	374
Spanning Tree Protocol	378
Static MAC Filtering	410
Static MAC Forwarding	412
VLAN	415
VLAN Isolation	442
VLAN Mapping	445
VLAN Stacking	450
NETWORKING	459
ARP Setup	460
DHCP	466
Static Route	480
SECURITY	484
AAA	485
Access Control	499
Classifier	509
Policy Rule	518
Anti-Arpscan	524
BPDU Guard	531
Storm Control	535
Error-Disable	538
IP Source Guard	546
DHCP Snooping	551
ARP Inspection	563
Port Authentication	584
Port Security	599

MAINTENANCE	603
Networked AV Mode	629
Troubleshooting and Appendices	688
Troubleshooting	689

Table of Contents

Document Conventions	3
Contents Overview	4
Table of Contents	7
Part I: User's Guide.....	27
Chapter 1	
Getting to Know Your Switch	28
1.1 Introduction	28
1.1.1 Multi-Gigabit	29
1.1.2 Stacking Mode	30
1.1.3 Management Modes	31
1.1.4 Mode Changing	32
1.1.5 ZON Utility	34
1.1.6 Web Configurator Networked AV Mode	34
1.1.7 PoE	35
1.2 Example Applications	36
1.2.1 PoE Example Application	36
1.2.2 Backbone Example Application	36
1.2.3 Bridging or Fiber Optic Uplink Example Application	37
1.2.4 High Performance Switching Example	37
1.2.5 IEEE 802.1Q VLAN Application Examples	38
1.2.6 IPv6 Support	39
1.3 Ways to Manage the Switch	39
1.4 Good Habits for Managing the Switch	40
Chapter 2	
Hardware Installation and Connection	41
2.1 Installation Scenarios	41
2.2 Safety Precautions	41
2.3 Freestanding Installation Procedure	41
2.4 Mounting the Switch on a Rack	42
2.4.1 Installation Requirements	42
2.4.2 Precautions	42
2.4.3 Attaching the Mounting Brackets to the Switch	43
2.4.4 Mounting the Switch on a Rack	43

Chapter 3	
Hardware Panels.....	45
3.1 Front Panel Connections	45
3.1.1 Multi-Gigabit Ethernet Ports	46
3.1.2 SFP/SFP+ Slots	47
3.1.3 Console Port	49
3.2 Rear Panel	49
3.2.1 Grounding	50
3.2.2 AC Power Connection	52
3.3 LEDs	54
Part II: Technical Reference.....	57
Chapter 4	
Web Configurator.....	58
4.1 Overview	58
4.2 System Login	58
4.3 Zyxel One Network (ZON) Utility	63
4.3.1 Requirements	63
4.3.2 Run the ZON Utility	63
4.4 Networked AV Mode Wizard	67
4.4.1 Basic Settings	67
4.4.2 Advanced Settings	72
4.5 Wizard	77
4.5.1 Basic	78
4.5.2 Protection	83
4.5.3 VLAN	85
4.5.4 QoS	86
4.6 Web Configurator Layout	87
4.6.1 Tables and Lists	95
4.6.2 Change Your Password	97
4.7 Save Your Configuration	97
4.8 Switch Lockout	97
4.9 Reset the Switch	98
4.9.1 Reboot the Switch	98
4.9.2 Reload the Configuration File	98
4.10 Log Out of the Web Configurator	99
4.11 Help	99
Chapter 5	
Initial Setup Example	101

5.1 Overview	101
5.1.1 Create a VLAN	101
5.1.2 Set Port VID	102
5.1.3 Configure Switch Management IP Address	103
Chapter 6	
Tutorials	106
6.1 Overview	106
6.2 How to Use DHCPv4 Snooping on the Switch	106
6.3 How to Use DHCPv4 Relay on the Switch	110
6.3.1 DHCP Relay Tutorial Introduction	110
6.3.2 Create a VLAN	110
6.3.3 Configure DHCPv4 Relay	113
6.3.4 Troubleshooting	114
6.4 How to Use Auto Configuration through a DHCP Server on the Switch	114
Chapter 7	
DASHBOARD	117
7.1 New User Interface	117
7.2 DASHBOARD	117
7.2.1 Port Status	121
7.2.2 Quick Links to Use	122
Chapter 8	
MONITOR.....	123
Chapter 9	
ARP Table.....	124
9.1 ARP Table Overview	124
9.1.1 What You Can Do	124
9.1.2 What You Need to Know	124
9.2 Viewing the ARP Table	124
Chapter 10	
IP Table.....	126
10.1 IP Table Overview	126
10.2 Viewing the IP Table	127
Chapter 11	
IPv6 Neighbor Table.....	128
11.1 IPv6 Neighbor Table Overview	128
11.2 Viewing the IPv6 Neighbor Table	128

Chapter 12	
MAC Table	130
12.1 MAC Table Overview	130
12.1.1 What You Can Do	130
12.1.2 What You Need to Know	130
12.2 Viewing the MAC Table	131
Chapter 13	
Neighbor	133
13.1 Neighbor Overview	133
13.1.1 What You Can Do	133
13.2 Neighbor	133
13.2.1 Neighbor Details	135
Chapter 14	
Path MTU Table	139
14.1 Path MTU Overview	139
14.2 Viewing the Path MTU Table	139
Chapter 15	
Port Status	140
15.0.1 What You Can Do	140
15.1 Port Status	140
15.1.1 Port Details	142
15.2 DDMI	144
15.2.1 DDMI Details	145
15.3 Port Utilization	147
Chapter 16	
Routing Table	149
16.1 Routing Table Overview	149
16.1.1 What You Can Do	149
16.2 IPv4 Routing Table	149
16.3 IPv6 Routing Table	150
Chapter 17	
System Information	151
17.0.1 What You Can Do	151
17.1 System Information	151
17.2 Hardware Monitor (Stacking Mode)	153
Chapter 18	
System Log	156

18.1 System Log Overview	156
18.2 System Log	156
Chapter 19	
SYSTEM	157
Chapter 20	
Cloud Management.....	158
20.1 Cloud Management Overview	158
20.2 Nebula Center Control Discovery	158
Chapter 21	
General Setup.....	160
21.1 General Setup	160
21.2 Hardware Monitor Setup	162
Chapter 22	
Interface Setup.....	164
22.1 Interface Setup Overview	164
22.2 Interface Setup	164
22.2.1 Add/Edit Interfaces	165
Chapter 23	
IP Setup	166
23.1 IP Setup Overview	166
23.1.1 What You Can Do	166
23.1.2 IP Interfaces	166
23.2 <i>IP Status</i>	167
23.2.1 IP Status Details	167
23.3 IP Setup	169
23.3.1 Add/Edit IP Interfaces	170
23.4 Network Proxy Configuration	171
Chapter 24	
IPv6.....	173
24.1 IPv6 Overview	173
24.1.1 What You Can Do	173
24.2 IPv6 Status	173
24.2.1 IPv6 Interface Status Details	174
24.3 IPv6 Global Setup	176
24.4 IPv6 Interface Setup	177
24.4.1 Edit an IPv6 Interface	178
24.5 IPv6 Link-Local Address Setup	178
24.5.1 Edit an IPv6 Link-Local Address	179

24.6 IPv6 Global Address Setup	180
24.6.1 Add/Edit an IPv6 Global Address	180
24.7 IPv6 Neighbor Discovery Setup	181
24.7.1 Edit an IPv6 Neighbor Discovery	182
24.8 IPv6 Router Discovery Setup	183
24.8.1 Edit IPv6 Router Discovery	183
24.9 IPv6 Prefix Setup	184
24.9.1 Add/Edit IPv6 Prefix	185
24.10 IPv6 Neighbor Setup	186
24.10.1 Add/Edit IPv6 Neighbor	187
24.11 DHCPv6 Client Setup	187
24.11.1 Edit DHCPv6 Client	188
Chapter 25	
Logins	190
25.1 Set Up Login Accounts	190
Chapter 26	
SNMP	192
26.1 SNMP Overview	192
26.1.1 What You Can Do	192
26.2 Configure SNMP	192
26.3 Configure SNMP User	194
26.3.1 Add/Edit SNMP User	194
26.4 SNMP Trap Group	196
26.5 Enable or Disable Sending of SNMP Traps on a Port	197
26.6 Technical Reference	198
26.6.1 About SNMP	198
Chapter 27	
Stacking	203
27.1 Stacking Overview	203
27.1.1 What You Can Do	203
27.1.2 What you need to know	203
27.2 Stacking Status	204
27.2.1 Stacking Slot Details	205
27.3 Stacking Setup	207
27.4 Stacking Port Setup	209
Chapter 28	
Switch Setup	211
28.1 Switch Setup Overview	211
28.1.1 Introduction to VLANs	211

28.2 Switch Setup	211
Chapter 29	
Syslog Setup	214
29.1 Syslog Overview	214
29.1.1 What You Can Do	214
29.2 Syslog Setup	214
29.2.1 Add/Edit a Syslog Server	216
Chapter 30	
Time Range.....	217
30.1 Time Range Overview	217
30.1.1 What You Can Do	217
30.2 Configuring Time Range	217
30.2.1 Add/Edit Time Range	218
Chapter 31	
PORT	220
Chapter 32	
Auto PD Recovery.....	221
32.1 Auto PD Recovery (for PoE models only) Overview	221
32.1.1 What You Can Do	221
32.2 Auto PD Recovery	221
32.2.1 Activate the Automatic PD Recovery	223
Chapter 33	
Flex Link	226
33.1 Flex Link Overview	226
33.1.1 What You Can Do	226
33.2 Flex Link Status	226
33.3 Flex Link Setup	227
33.3.1 Add/Edit Flex Link	228
Chapter 34	
Green Ethernet	230
34.1 Green Ethernet Overview	230
34.2 Configuring Green Ethernet	230
Chapter 35	
Link Aggregation	234
35.1 Link Aggregation Overview	234
35.1.1 What You Can Do	234
35.1.2 What You Need to Know	234

35.2 Link Aggregation Status	236
35.3 Link Aggregation Setting	237
35.4 Link Aggregation Control Protocol	240
35.5 Technical Reference	243
35.5.1 Static Trunking Example	243
Chapter 36	
Link Layer Discovery Protocol (LLDP)	245
36.1 LLDP Overview	245
36.2 LLDP-MED Overview	246
36.2.1 What You Can Do – LLDP	247
36.2.2 What You Can Do – LLDP MED	247
36.3 LLDP Local Status	247
36.3.1 LLDP Local Port Status Details	249
36.4 LLDP Remote Status	252
36.4.1 LLDP Remote Port Status Details	253
36.5 LLDP Setup	258
36.6 Basic TLV Setting	261
36.7 Org-specific TLV Setting	263
36.8 LLDP-MED Setup	264
36.9 LLDP-MED Network Policy	266
36.9.1 Add/Edit LLDP-MED Network Policy	267
36.10 LLDP-MED Location	268
36.10.1 Add/Edit LLDP-MED Location	268
Chapter 37	
OAM	272
37.1 OAM Overview	272
37.1.1 What You Can Do	272
37.2 OAM Status	272
37.2.1 OAM Details	274
37.3 OAM Setup	278
37.4 OAM Remote Loopback	280
Chapter 38	
PoE Setup	282
38.1 PoE Status (for PoE models only)	282
38.2 PoE Setup	285
38.3 PoE Time Range Setup	288
38.3.1 Add/Edit PoE Time Range	289
Chapter 39	
Port Setup.....	291

39.1 Port Setup	291
Chapter 40	
ZULD.....	294
40.1 ZULD Overview	294
40.1.1 What You Can Do	294
40.1.2 What You Need to Know	294
40.2 ZULD Status	295
40.3 ZULD Setup	297
Chapter 41	
SWITCHING.....	300
Chapter 42	
Layer 2 Protocol Tunneling.....	301
42.1 Layer 2 Protocol Tunneling Overview	301
42.1.1 What You Can Do	301
42.1.2 What You Need to Know	301
42.2 Configuring Layer 2 Protocol Tunneling	302
Chapter 43	
Loop Guard.....	306
43.1 Loop Guard Overview	306
43.1.1 What You Can Do	306
43.1.2 What You Need to Know	306
43.2 Loop Guard Setup	308
Chapter 44	
MAC Pinning.....	310
44.1 MAC Pinning Overview	310
44.2 MAC Pinning Configuration	310
Chapter 45	
Mirroring.....	313
45.1 Mirroring Overview	313
45.2 Local Port Mirroring	313
Chapter 46	
Multicast.....	315
46.1 Multicast Overview	315
46.1.1 What You Can Do – IPv6 Multicast	315
46.1.2 What You Can Do – MVR	316
46.1.3 What You Need to Know	316
46.2 IPv4 Multicast Status	319

46.3 IGMP Snooping	320
46.4 IGMP Snooping VLAN	324
46.4.1 Add/Edit IGMP Snooping VLANs	325
46.5 IGMP Filtering Profile	326
46.5.1 Add IGMP Filtering Profile	327
46.5.2 Add IGMP Filtering Rule	327
46.6 IPv6 Multicast Status	328
46.7 MLD Snooping-proxy	329
46.8 MLD Snooping-proxy VLAN	329
46.8.1 Add/Edit MLD Snooping-proxy VLAN	330
46.9 MLD Snooping-proxy Port Role Setting	332
46.10 MLD Snooping-proxy Filtering	334
46.11 MLD Snooping-proxy Filtering Profile	336
46.11.1 Add MLD Snooping-proxy Filtering Profile	337
46.11.2 Add MLD Snooping-proxy Filtering Rule	338
46.12 MVR Configuration	338
46.12.1 Add/Edit MVR	339
46.13 MVR Group Setup	341
46.13.1 Add/Edit MVR Group	342
46.13.2 MVR Configuration Example	343
Chapter 47	
Static Multicast Forwarding	346
47.1 Static Multicast Forwarding Overview	346
47.1.1 What You Can Do	346
47.1.2 What You Need To Know	346
47.2 Static Multicast Forwarding By MAC	347
47.2.1 Add/Edit Static Multicast Forwarding By MAC	348
47.3 Configure a Static Multicast IPv4 Address	349
47.3.1 Add/Edit a Static Multicast Address By IP	349
Chapter 48	
PPPoE	351
48.1 PPPoE Intermediate Agent Overview	351
48.1.1 What You Can Do	351
48.1.2 What You Need to Know	351
48.2 PPPoE Intermediate Agent	353
48.3 PPPoE IA Port	355
48.4 PPPoE IA Port VLAN	356
48.5 PPPoE IA VLAN	358
Chapter 49	
Differentiated Services	360

49.1 DiffServ Overview	360
49.1.1 What You Can Do	360
49.1.2 What You Need to Know	360
49.2 Activating DiffServ	361
49.3 DSCP-to-IEEE 802.1p Priority Settings	363
49.3.1 Configuring DSCP Settings	363
Chapter 50	
Queuing Method.....	365
50.1 Queuing Method Overview	365
50.1.1 What You Can Do	365
50.1.2 What You Need to Know	365
50.2 Configuring Queuing	366
Chapter 51	
Priority Queue.....	369
51.1 Priority Queue Overview	369
51.1.1 What You Can Do	369
51.2 Assign Priority Queue	369
Chapter 52	
Bandwidth Control	371
52.1 Bandwidth Control Overview	371
52.1.1 What You Can Do	371
52.1.2 CIR and PIR	371
52.2 Bandwidth Control Setup	371
Chapter 53	
sFlow.....	374
53.1 sFlow Overview	374
53.2 sFlow Port Configuration	374
53.3 sFlow Collector Configuration	376
53.3.1 Add/Edit sFlow Collector	377
Chapter 54	
Spanning Tree Protocol	378
54.1 Spanning Tree Protocol Overview	378
54.1.1 What You Can Do	378
54.1.2 What You Need to Know	378
54.2 Spanning Tree Protocol Status	381
54.3 Spanning Tree Setup	382
54.4 Rapid Spanning Tree Protocol Status	385
54.5 Configure Rapid Spanning Tree Protocol	387

54.6 Multiple Rapid Spanning Tree Protocol	391
54.7 Configure Multiple Rapid Spanning Tree Protocol	393
54.8 Multiple Spanning Tree Protocol Status	397
54.9 Configure Multiple Spanning Tree Protocol	401
54.9.1 Add/Edit Multiple Spanning Tree	403
54.10 Multiple Spanning Tree Protocol Port Setup	405
54.11 Technical Reference	407
54.11.1 MSTP Network Example	407
54.11.2 MST Region	407
54.11.3 MST Instance	408
54.11.4 Common and Internal Spanning Tree (CIST)	408
Chapter 55	
Static MAC Filtering.....	410
55.1 Static MAC Filtering Overview	410
55.1.1 What You Can Do	410
55.2 Configure a Static MAC Filtering Rule	410
55.2.1 Add/Edit a Static MAC Filtering Rule	411
Chapter 56	
Static MAC Forwarding.....	412
56.1 Static MAC Forwarding Overview	412
56.1.1 What You Can Do	412
56.2 Configure Static MAC Forwarding	412
56.2.1 Add/Edit Static MAC Forwarding Rules	413
Chapter 57	
VLAN.....	415
57.1 VLAN Overview	415
57.1.1 What You Can Do	415
57.1.2 What You Need to Know	415
57.2 Introduction to IEEE 802.1Q Tagged VLANs	416
57.3 VLAN Status	418
57.3.1 VLAN Details	419
57.4 Configure a Static VLAN	421
57.4.1 Add/Edit a Static VLAN	421
57.5 VLAN Port Setup	423
57.6 Configure GVRP	425
57.7 Subnet Based VLAN	427
57.8 Configuring Subnet Based VLAN	428
57.8.1 Add/Edit Subnet Based VLAN	429
57.9 Protocol Based VLAN	430
57.10 Configuring Protocol Based VLAN	430

57.10.1 Add/Edit a Protocol Based VLAN	431
57.11 Voice VLAN	433
57.11.1 Add/Edit a Voice VLAN	434
57.12 MAC Based VLAN	435
57.12.1 Add/Edit a MAC Based VLAN	436
57.13 Vendor ID Based VLAN	437
57.13.1 Add/Edit a Vendor ID Based VLAN	437
57.14 Port-Based VLAN Setup	438
57.15 Configure a Port-Based VLAN	439
Chapter 58	
VLAN Isolation	442
58.1 VLAN Isolation Overview	442
58.2 Configuring VLAN Isolation	442
58.2.1 Add/Edit a VLAN Isolation Rule	443
Chapter 59	
VLAN Mapping	445
59.1 VLAN Mapping Overview	445
59.1.1 VLAN Mapping Example	445
59.1.2 What You Can Do	445
59.2 Enable VLAN Mapping	446
59.3 VLAN Mapping Setup	447
59.3.1 Add/Edit VLAN Mapping	448
Chapter 60	
VLAN Stacking.....	450
60.1 VLAN Stacking Overview	450
60.1.1 VLAN Stacking Example	450
60.2 VLAN Stacking Port Roles	451
60.3 VLAN Tag Format	451
60.3.1 Frame Format	452
60.4 Configuring VLAN Stacking	452
60.5 Port-Based Q-in-Q	454
60.6 Selective Q-in-Q	456
60.6.1 Add/Edit Selective Q-in-Q	457
Chapter 61	
NETWORKING.....	459
Chapter 62	
ARP Setup.....	460
62.1 ARP Overview	460
62.1.1 What You Can Do	460

62.1.2 What You Need to Know	460
62.2 ARP Learning	462
62.3 Static ARP	464
62.3.1 Add/Edit Static ARP	465
Chapter 63	
DHCP	466
63.1 DHCP Overview	466
63.1.1 What You Can Do	466
63.1.2 What You Need to Know	466
63.2 DHCPv4 Relay Status	467
63.3 DHCPv4 Option 82 Profile	467
63.3.1 Add/Edit a DHCPv4 Option 82 Profile	468
63.4 Configuring DHCPv4 Smart Relay	469
63.4.1 Add/Edit DHCPv4 Global Relay Port	470
63.4.2 DHCP Smart Relay Configuration Example	471
63.5 DHCPv4 VLAN Setting	473
63.5.1 Add/Edit DHCPv4 VLAN Setting	473
63.5.2 Add/Edit DHCPv4 VLAN Port	474
63.6 DHCPv6 Relay	475
63.6.1 Add/Edit DHCPv6 Relay	476
63.7 DHCP Server Guard	477
Chapter 64	
Static Route.....	480
64.1 Static Routing Overview	480
64.1.1 What You Can Do	480
64.2 IPv4 Static Route	481
64.2.1 Add/Edit IPv4 Static Route	481
64.3 IPv6 Static Route	482
64.3.1 Add/Edit IPv6 Static Route	483
Chapter 65	
SECURITY	484
Chapter 66	
AAA	485
66.1 Authentication, Authorization and Accounting (AAA)	485
66.1.1 What You Can Do	485
66.1.2 What You Need to Know	485
66.2 RADIUS Server Setup	486
66.3 TACACS+ Server Setup	488
66.4 AAA Setup	490
66.5 Technical Reference	493

66.5.1 Vendor Specific Attribute	493
66.5.2 Supported RADIUS Attributes	495
66.5.3 Attributes Used for Authentication	495
66.5.4 Attributes Used for Accounting	496
Chapter 67	
Access Control.....	499
67.1 Access Control Overview	499
67.1.1 What You Can Do	499
67.2 Service Access Control	499
67.3 Remote Management	500
67.4 Account Security	501
67.5 Technical Reference	503
67.5.1 SSH Overview	503
67.5.2 Introduction to HTTPS	505
67.5.3 Google Chrome Warning Messages	507
Chapter 68	
Classifier.....	509
68.1 Classifier Overview	509
68.1.1 What You Can Do	509
68.1.2 What You Need to Know	509
68.2 Classifier Status	510
68.3 Classifier Setup	510
68.3.1 Add/Edit a Classifier	512
68.4 Classifier Global Setting	515
68.5 Classifier Example	516
Chapter 69	
Policy Rule	518
69.1 Policy Rules Overview	518
69.1.1 What You Can Do	518
69.1.2 DiffServ	518
69.1.3 DSCP and Per-Hop Behavior	518
69.2 Policy Rules	519
69.2.1 Add/Edit a Policy Rule	519
69.3 Policy Example	522
Chapter 70	
Anti-Arpscan	524
70.1 Anti-Arpscan Overview	524
70.1.1 What You Can Do	524
70.1.2 What You Need to Know	524

70.2 Anti-Arpscan Status	525
70.3 Anti-Arpscan Host Status	526
70.4 Anti-Arpscan Setup	527
70.5 Anti-Arpscan Trust Host	529
70.5.1 Add/Edit Anti-Arpscan Trust Hosts	529
Chapter 71	
BPDU Guard	531
71.1 BPDU Guard Overview	531
71.2 BPDU Guard Status	531
71.3 BPDU Guard Setup	532
Chapter 72	
Storm Control.....	535
72.1 Storm Control Overview	535
72.1.1 What You Can Do	535
72.2 Storm Control Setup	535
Chapter 73	
Error-Disable	538
73.1 Error-Disable Overview	538
73.1.1 CPU Protection Overview	538
73.1.2 Error-Disable Recovery Overview	538
73.1.3 What You Can Do	538
73.2 Error-Disable Status	539
73.3 CPU Protection Setup	541
73.4 Error-Disable Detect Setup	543
73.5 Error-Disable Recovery Setup	544
Chapter 74	
IP Source Guard	546
74.1 IP Source Guard Overview	546
74.1.1 What You Can Do	547
74.2 IPv4 Source Guard	548
74.3 IPv4 Source Guard Static Binding	548
74.3.1 Add/Edit IPv4 Source Guard Static Binding	550
Chapter 75	
DHCP Snooping.....	551
75.1 DHCP Snooping Overview	551
75.1.1 What You Can Do	552
75.2 DHCP Snooping Status	552
75.3 DHCP Snooping Setup	555

75.4 DHCP Snooping Port Setup	556
75.5 DHCP Snooping VLAN Setup	558
75.6 DHCP Snooping VLAN Port Setup	559
75.6.1 Add/EDIT DHCP Snooping VLAN Ports	560
75.7 Technical Reference	561
75.7.1 DHCP Snooping Overview	561
Chapter 76	
ARP Inspection	563
76.1 ARP Inspection Status	563
76.2 ARP Inspection VLAN Status	564
76.3 ARP Inspection Log Status	564
76.4 ARP Inspection Setup	565
76.5 ARP Inspection Port Setup	567
76.6 ARP Inspection VLAN Setup	569
76.7 IPv6 Source Guard	570
76.8 IPv6 Source Binding Status	570
76.9 IPv6 Static Binding	571
76.9.1 Add/Edit IPv6 Static Binding	572
76.10 IPv6 Source Guard Policy	573
76.10.1 Add/Edit an IPv6 Source Guard Policy	574
76.11 IPv6 Source Guard Port Setup	575
76.12 IPv6 Snooping Policy Setup	576
76.12.1 Add/Edit a IPv6 Snooping Policy	577
76.13 IPv6 Snooping VLAN Setup	578
76.13.1 Add/Edit an IPv6 Snooping VLAN	579
76.14 IPv6 DHCP Trust Setup	579
76.15 Technical Reference	581
76.15.1 ARP Inspection Overview	581
Chapter 77	
Port Authentication	584
77.1 Port Authentication Overview	584
77.1.1 What You Can Do	584
77.1.2 What You Need to Know	585
77.1.3 MAC Authentication	585
77.2 Activate IEEE 802.1x Security	586
77.3 Activate MAC Authentication	588
77.4 Guest VLAN	591
77.5 Compound Authentication	594
77.6 Technical Reference	595
77.6.1 IEEE 802.1x	596
77.6.2 RADIUS	596

77.6.3 EAP (Extensible Authentication Protocol) Authentication	597
77.6.4 EAPOL (EAP over LAN)	598
Chapter 78	
Port Security.....	599
78.1 Port Security Overview	599
78.2 About Port Security	599
78.3 Port Security Setup	599
Chapter 79	
MAINTENANCE.....	603
79.1 Overview	603
79.1.1 What You Can Do	603
79.2 Certificates	603
79.2.1 HTTPS Certificates	605
79.3 Technical Reference	605
79.3.1 FTP Command Line	605
79.3.2 Filename Conventions	606
79.3.3 FTP Command Line Procedure	607
79.3.4 GUI-based FTP Clients	607
79.3.5 FTP Restrictions	607
79.4 Cluster Management Overview	608
79.4.1 What You Can Do	608
79.5 Cluster Management Status	608
79.6 Clustering Management Setup	609
79.7 Technical Reference	611
79.7.1 Cluster Member Switch Management	611
79.8 Restore Configuration	613
79.9 Backup Configuration	613
79.10 Auto Configuration	614
79.11 Erase Running-Configuration	615
79.12 Save Configuration	616
79.13 Configure Clone	617
79.14 Diagnostic	619
79.15 Firmware Upgrade	622
79.16 Reboot System	625
79.17 Tech-Support	627
79.17.1 Tech-Support Download	628
Chapter 80	
Networked AV Mode.....	629
80.1 Overview	629
80.2 Help	629

80.3 Summary	629
80.4 MONITOR	631
80.5 What You Can Do	631
80.6 System Information	631
80.7 SYSTEM	633
80.8 What You Can Do	633
80.9 Cloud Management	634
80.10 General Setup	635
80.11 IP Setup	637
80.11.1 Add/Edit IP Interfaces	638
80.12 Logins	639
80.13 Configure SNMP	641
80.14 Configure SNMP User	643
80.14.1 Add/Edit SNMP User	644
80.15 Configure SNMP Trap Group	645
80.16 Enable or Disable Sending of SNMP Traps on a Port	646
80.17 PORT	647
80.18 Link Aggregation	648
80.18.1 What You Can Do	648
80.19 Link Aggregation Status	648
80.20 Link Aggregation Setting	650
80.21 Link Aggregation Control Protocol	651
80.22 PoE Status	653
80.23 PoE Setup	655
80.24 Port Setup	658
80.25 SWITCHING	660
80.26 Port Mirroring	660
80.27 Multicast	661
80.27.1 What You Can Do	661
80.28 IPv4 Multicast Status	661
80.29 IGMP Snooping	662
80.30 IGMP Snooping VLAN	666
80.30.1 Add/Edit IGMP Snooping VLANs	667
80.31 IGMP Filtering Profile	668
80.31.1 Add IGMP Filtering Profile	669
80.31.2 Add IGMP Filtering Rule	669
80.32 VLAN	670
80.32.1 What You Can Do	670
80.32.2 What You Need to Know	670
80.33 VLAN Status	673
80.33.1 VLAN Details	674
80.34 Configure a Static VLAN	675
80.34.1 Add/Edit a Static VLAN	676

80.35 VLAN Port Setup	677
80.36 SECURITY	678
80.37 Access Control	678
80.37.1 What You Can Do	679
80.38 Service Access Control	679
80.39 Remote Management	680
80.40 Storm Control	681
80.41 MAINTENANCE	682
80.42 What You Can Do	682
80.43 Restore Configuration	682
80.44 Backup Configuration	683
80.45 Save Configuration	684
80.46 Firmware Upgrade	684
80.47 Reboot System	685
80.48 Tech-Support	686
80.48.1 Tech-Support Download	686
Part III: Troubleshooting and Appendices.....	688
Chapter 81	
Troubleshooting.....	689
81.1 Power, Hardware Connections, and LEDs	689
81.2 Switch Access and Login	690
81.3 Switch Configuration	692
81.4 PoE Supply	692
81.5 Nebula Registration	693
Appendix A Customer Support	694
Appendix B Common Services.....	699
Appendix C IPv6.....	702
Appendix D Legal Information	710
Index	715

PART I

User's Guide

CHAPTER 1

Getting to Know Your Switch

1.1 Introduction

This chapter introduces the main features and applications of the Switch.

The XGS2220 Series consists of the following models:

- XGS2220-30
- XGS2220-30HP
- XGS2220-30F
- XGS2220-54
- XGS2220-54HP
- XGS2220-54FP

References to PoE model in this User's Guide only apply to XGS2220-30HP, XGS2220-54HP, and XGS2220-54FP.

The Switch is a stackable, layer-3, Gigabit Ethernet (GbE) switch with one power slot for single power supply. The Switch provides six 10 GbE ports for uplink. By integrating router functions, the Switch performs wire-speed layer-3 routing in addition to layer-2 switching.

With its built-in Web Configurator, including the Zyxel One Network (ZON) Neighbor Management feature, viewing, managing and configuring the Switch and its neighboring devices is easy. The Switch can also be managed through Telnet, any terminal emulator program on the console port, or third-party SNMP management.

In addition, Zyxel offers a proprietary software program called Zyxel One Network (ZON) Utility, it is a utility tool that assists you to set up and maintain network devices in a more simple and efficient way. You can download the ZON Utility at www.zyxel.com and install it on a computer.

All models are referred to as the "Switch" in this guide.

The Switch supports NebulaFlex for hybrid mode which can set the Switch to operate in either standalone or Nebula cloud management mode. When the Switch is in standalone mode, it can be configured and managed by the Web Configurator. When the Switch is in Nebula cloud management mode, it can be managed and provisioned by the Zyxel Nebula Control Center (NCC).

The following table describes the hardware features of the Switch by model.

Table 1 XGS2220 Series Comparison Table

FEATURE	XGS2220-30	XGS2220-30HP	XGS2220-30F	XGS2220-54	XGS2220-54HP	XGS2220-54FP
Stacking Mode	Yes	Yes	Yes	Yes	Yes	Yes
10/100/1000 Mbps Ethernet Ports	24	24	No	48	48	48

Table 1 XGS2220 Series Comparison Table (continued)

FEATURE	XGS2220-30	XGS2220-30HP	XGS2220-30F	XGS2220-54	XGS2220-54HP	XGS2220-54FP
10/100/1000 Mbps PoE Ports	No	24	No	No	48	48
100/1000 Mbps SFP Interface	No	No	24	No	No	No
1/10 Gbps SFP+ Interface	4	4	4	4	4	4
1000 Mbps / 2.5/5/10 Gbps Ethernet Ports	2	2	2	2	2	2
1000 Mbps / 2.5/5/10 Gbps PoE Ports	No	2	No	No	2	2
Smart FAN	1 (8,500 RPM)	3 (8,500 RPM)	2 (8,500 RPM)	2 (8,500 RPM)	4 (8,500 RPM)	1 (8,500 RPM) 2 (16,000 RPM)
Console Port	USB-C	USB-C	USB-C	USB-C	USB-C	USB-C

The last four 10G ports can also be used for stacking. Use the four 10G fiber ports. When working in stacking mode, the Switch can operate together with other Switches of the same model and firmware version and allows you to remotely manage them from one switch using one single IP address.

This section shows a few examples of using the Switch in various network environments.

1.1.1 Multi-Gigabit

A 10 Gigabit port supports speeds of 10G if the connected device supports 10G and a Cat 6a (up to 100 m) or Cat 6 cable (up to 50 m) is used. The speed drops to 1G if these criteria are not met; it drops to 100M if a Cat 5 cable is used (up to 100 m).

If a network device such as a 5G network card, gaming computer, server, Network Attached Storage (NAS) or Access Point (AP) only supports 2.5 Gigabit or 5 Gigabit connectivity, then the maximum speed potential of these devices is never reached.

In addition, at the time of writing, most existing cabling is Cat 5e or Cat 6, further limiting maximum speed or distance potential.

Multi-Gigabit (IEEE 802.3bz) solves these problems by additionally supporting 2.5 Gigabit and 5 Gigabit Ethernet connections over Cat 5e and higher Ethernet cables. Multi-Gigabit ports are also backward compatible with 100 Mbps and 1 Gigabit ports.

Figure 1 Multi-Gigabit Application

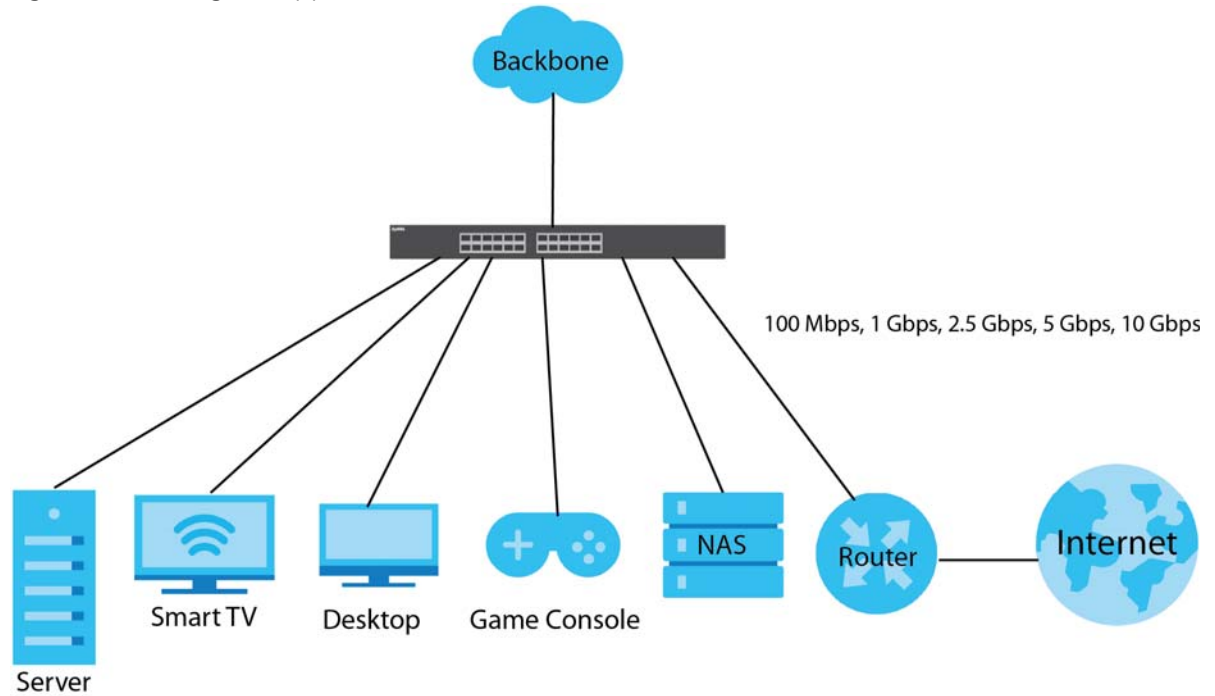

See the following table for the cables required and distance limitation to attain the corresponding speed.

Table 2 Cable Types

CABLE	TRANSMISSION SPEED	MAXIMUM DISTANCE	BANDWIDTH CAPACITY
Category 5	100M	100 m	100 MHz
Category 5e or better	1G / 2.5G / 5G*	100 m	100 MHz
Category 6	5G / 10G	100 m / 55 m	250 MHz
Category 6a	10G	100 m	500 MHz
Category 7	10G	100 m	600 MHz

* A high quality Category 5e cable can support 5 Gbps and up to 100 m with no electromagnetic interference.

Note: Make sure to select the correct speed for the port in **PORT > Port Setup**.

1.1.2 Stacking Mode

The Switch can work in Stacking mode and directly connect to other switches. The switches then operate together and act as a single switch or a virtual chassis. The stackable switches can be managed from a master switch in the stack.

Note: To set the Switch to Stacking mode, go to the **SYSTEM > Stacking > Stacking Setup** screen.

Note: When the Switch is in Stacking mode, it uses the default static IP address 192.168.1.1.

Note: Make sure the stacking port is connected to the specified media type: **SFP+** transceiver or an SFP+ Direct Attach Copper (**DAC10G**) that you set in **SYSTEM > Stacking > Stacking Port Setup**. Default is **SFP+**.

Figure 2 Stacking Example

1.1.3 Management Modes

NebulaFlex means you can set the Switch to operate in either standalone or cloud mode (but not both at the same time).

Use the DHCP-assigned IP address to access the Web Configurator. To know the IP address, use the NCC, the ZON utility, or the console port if available. You can also use the domain name "setup.zyxel" to access the Web Configurator when you are directly connected to the Switch.

Note: Make sure your computer can connect to a DNS server through the Switch.

Use the Web Configurator to configure and manage the Switch directly in standalone mode or use Nebula Control Center (NCC) to configure and manage the Switch in cloud mode. The Nebula Control Center (NCC) is an alternative cloud-based network management system that allows you to remotely manage and monitor the Switch. You may also access a minimized version of the Web Configurator in cloud mode.

Nebula Cloud Management

To have Nebula manage the Switch, you must first register it at the Nebula web portal at <https://nebula.zyxel.com>, and ensure that **Nebula Control Center (NCC) Discovery** is enabled in **SYSTEM > Cloud Management** in the Switch Web Configurator.

Note: See the Switch's datasheet for the feature differences between standalone and Nebula cloud management modes. You can find the Switch's datasheet at the Zyxel website.

See the NCC (Nebula Control Center) User's Guide for how to configure the Switch using Nebula.

Figure 3 NCC Example Network Topology

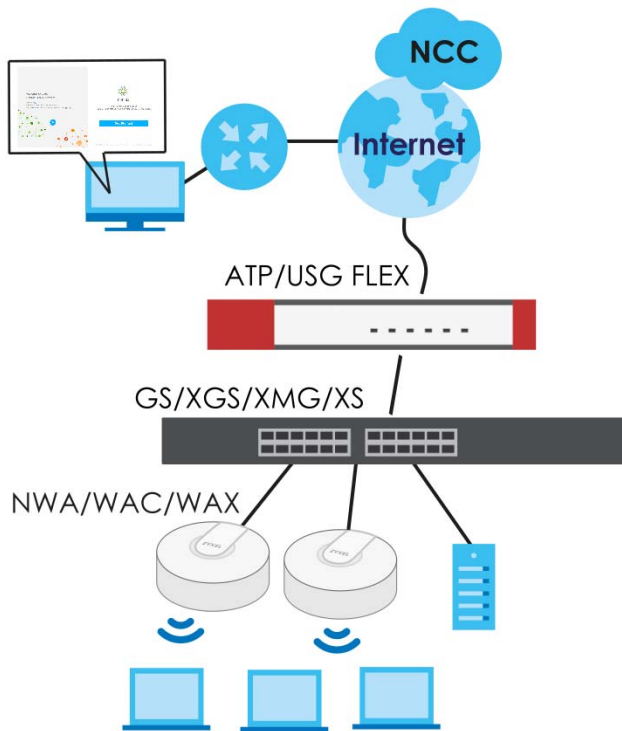

1.1.4 Mode Changing

This section describes how to change the Switch's management mode. Refer to the Switch's standalone mode User's Guide for LED descriptions, including **CLOUD** LED behavior.

From Standalone to Nebula Cloud Management

To manage your Switch through Nebula, connect the Switch to the Internet, and register it to a site and organization at the Nebula web portal (<https://nebula.zyxel.com>).

See the following steps or the Switch Quick Start Guide for registering the Switch.

Go to the NCC to Register the Switch

- 1 Go to the Nebula web portal in one of three ways.
 - Enter <https://nebula.zyxel.com> in a supported web browser. See the Nebula User's Guide for more information about supported browsers.
 - Click **Visit Nebula** in the Switch's login page.
 - Click the **Nebula Control Center** icon in the upper right of the Switch's Web Configurator.
- 2 Click **Get Started** in the Nebula web portal. Enter your myZyxel account information. You will be redirected to another screen where you can sign up for a myZyxel account if you do not have one.
- 3 Create an organization and a site (using the Nebula setup wizard) or select an existing site.

- 4 Register the Switch by entering its Registration MAC address and serial number and assign it to the site. The serial number and Registration MAC address can be found in the **DASHBOARD** screen or the device back label on the Switch.

Use the Zyxel Nebula Mobile App to Register the Switch

- 1 Download and open the Zyxel Nebula Mobile app in your mobile device (see [Section on page 159](#) to download the app). Click **Start** on the first page. Click **Create account** to create a myZyxel account or enter your existing account information to log in.
- 2 Create an organization and site, or select an existing site using the Zyxel Nebula Mobile app.
- 3 Select a site and scan the Switch's QR code or manually enter the information to add it to the site. You can find the QR code:
 - On a label on the Switch or
 - On its box or
 - In the Web Configurator at **SYSTEM > Cloud Management**.

See [Section 3.3 on page 54](#) for more information about the **CLOUD** LED or [Section Table 33 on page 119](#) for more information about the **Cloud Control Status** field in the **DASHBOARD** screen to see if the Switch goes into Nebula cloud management mode successfully.

The Switch goes into Cloud mode automatically after it can access the Nebula web portal and is successfully registered there. Its login password and settings are then overwritten with what you have configured in the Nebula web portal. To access the Web Configurator when the Switch is in Cloud mode, use the Local credentials password to login.

Note: The **Local credentials: Password** can be found in **Site-wide > Configure > Site settings > Device configuration** in the NCC portal. See the NCC User's Guide for more information.

Table 3 Management Method Comparison

MODE	ACCESS	LOGIN USER NAME	LOGIN PASSWORD	LOGIN IP ADDRESS/URL/DOMAIN NAME
Cloud mode	NCC (Nebula Control Center) portal	myZyxell account name	myZyxel account password	https://nebula.zyxel.com
	Web Configurator (Local GUI)	admin	Local credentials password	http://setup.zyxel OR http://DHCP-assigned IP OR a configured static IP address
Note: The Web Configurator (Local GUI) of Cloud mode supports limited features for troubleshooting use only.				
Standalone mode	Web Configurator	admin	1234	http://setup.zyxel OR http://DHCP-assigned IP OR http://192.168.1.1

From Nebula-managed to Standalone

To return to direct management standalone mode, remove (unregister) the Switch from the inventory in the Nebula web portal.

Note: When you change the Switch's management mode from Cloud mode to standalone mode, the Switch will reboot and restore its factory-default settings.

To unregister the Switch:

- 1 Go to the Nebula Control Center (<https://nebula.zyxel.com>).
- 2 Go to the **Organization-wide > License & inventory > Devices** screen.
- 3 Select the Switch you want to remove (unregister) from the organization.
- 4 Click **Actions**, then click **Remove from organization**.

It will take a while for the Switch to reboot and reset to factory default.

1.1.5 ZON Utility

With its built-in Web Configurator, including the Neighbor Management feature ([Section 13.1 on page 133](#)), viewing, managing and configuring the Switch and its neighboring devices is simplified.

In addition, Zyxel offers a proprietary software program called Zyxel One Network (ZON) Utility, it is a utility tool that assists you to set up and maintain network devices in a more simple and efficient way. You can download the ZON Utility at www.zyxel.com and install it on a PC (Windows operation system). For more information on ZON Utility see [Section 4.3 on page 63](#).

1.1.6 Web Configurator Networked AV Mode

Aside from the Web Configurator in Standard mode, you can switch to Networked AV mode that is specifically designed to simplify configuration and management of the Switch for AVoIP (Audio-Video over Internet Protocol) application. In AV over IP, the AV transmitter is the transmitter, the AV receiver is the receiver, and the matrix switch is a standard IP Switch. See [Section 4.4 on page 67](#) for details on using the Setup Wizard screen for configuring the Switch's Networked AV mode's basic and advanced settings.

Figure 4 Comparison Between Traditional AV and AVoIP Setups

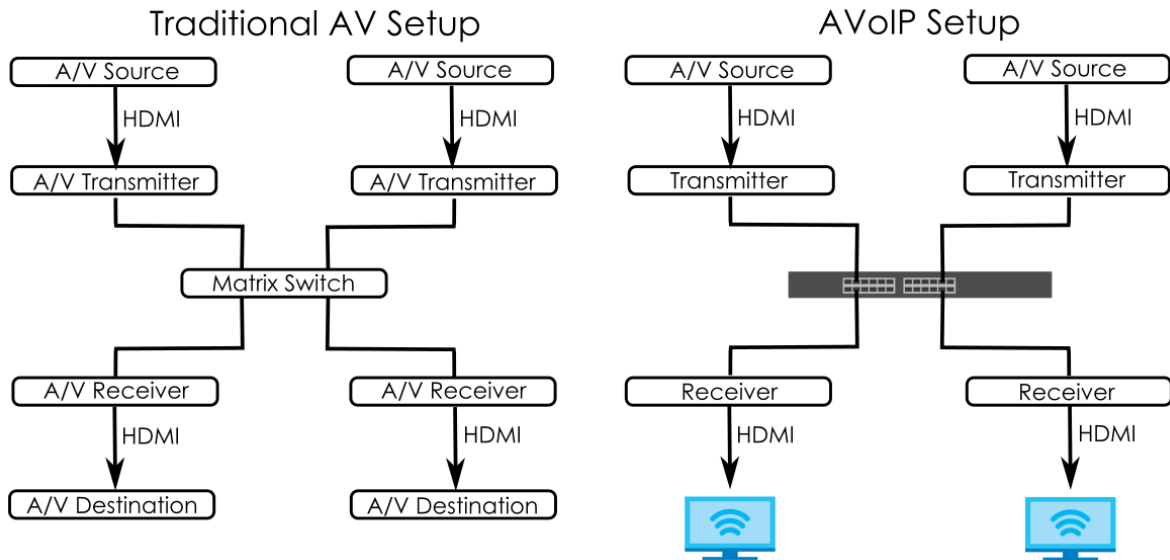

1.1.7 PoE

The Switch is a Power Sourcing Equipment (PSE) because it provides a source of power through its Ethernet ports. Each device that receives power through an Ethernet port is a Powered Device (PD).

The Switch can adjust the power supplied to each PD according to the PoE standard the PD supports. PoE standards are:

- IEEE 802.3af Power over Ethernet (PoE)
- IEEE 802.3at Power over Ethernet (PoE) +
- IEEE 802.3bt Power over Ethernet (PoE) ++

The following table describes the PoE features of the Switch by PoE standard.

Table 4 XGS2220 Series Models and PoE Features

POE FEATURES	XGS2220-30HP	XGS2220-54HP	XGS2220-54FP
IEEE 802.3at PoE+	Ports 1 – 16	Ports 1 – 40	Ports 1 – 40
IEEE 802.3bt PoE++	Ports 17 – 26	Ports 41 – 50	Ports 41 – 50
Power Management Mode	Consumption Classification (default)	Consumption Classification (default)	Consumption Classification (default)
PoE Power Budget	400 W	600 W	960 W

Table 5 PoE Standards

POE FEATURES	PoE	PoE+	PoE++
IEEE Standard	IEEE 802.3af	IEEE 802.3at	IEEE 802.3bt
PoE Type	Type 1	Type 2	Type 3
Switch Port Power			
IEEE Power Classification	Class 0, 1, 2, 3	Class 4	Class 5, 6
Maximum Power Per Port	15.4 W	30 W	60 W

Table 5 PoE Standards (continued)

PoE FEATURES	PoE	PoE+	PoE++
Port Voltage Range	44 – 57 V	50 – 57 V	50 – 57 V
Cables			
Twisted Pairs Used	2-pair	2-pair	4-pair
Supported Cables	Cat3 or better	Cat5 or better	Cat5 or better

1.2 Example Applications

This section shows a few examples of using the Switch in various network environments. Note that the Switch in the figure is just an example Switch and not your actual Switch.

1.2.1 PoE Example Application

The following example figure shows a Switch supplying PoE (Power over Ethernet) to Powered Devices (PDs) such as an IP camera, a wireless router, an IP telephone and a general outdoor router that are not within reach of a power outlet.

Figure 5 PoE Example Application

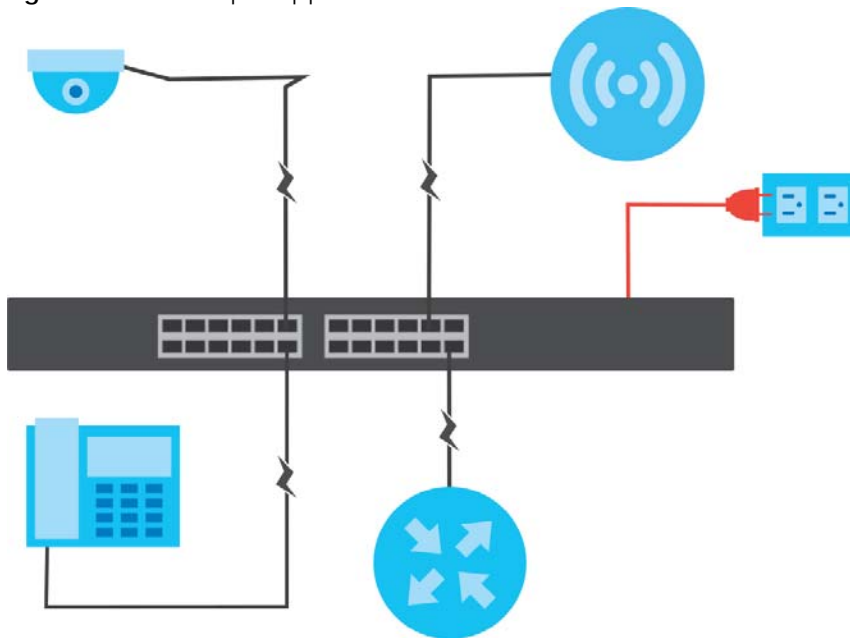

1.2.2 Backbone Example Application

The Switch is an ideal solution for small networks where rapid growth can be expected in the near future. The Switch can be used standalone for a group of heavy traffic users. You can connect computers and servers directly to the Switch's port or connect other switches to the Switch.

In this example, all computers can share high-speed applications on the server. To expand the network, simply add more networking devices such as switches, routers, computers, print servers, and so on.

Figure 6 Backbone Application

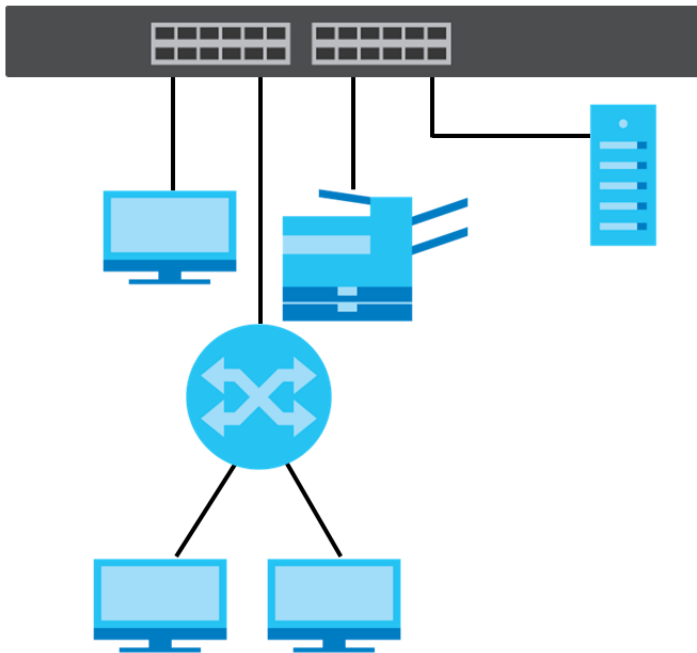

1.2.3 Bridging or Fiber Optic Uplink Example Application

In this example, the Switch connects different company departments (**RD** and **Sales**) to the corporate backbone. It can alleviate bandwidth contention and eliminate server and network bottlenecks. All users that need high bandwidth can connect to high-speed department servers through the Switch. You can provide a super-fast uplink connection by using a Gigabit Ethernet or SFP port on the Switch.

Moreover, the Switch eases supervision and maintenance by allowing network managers to centralize multiple servers at a single location.

Figure 7 Bridging Application

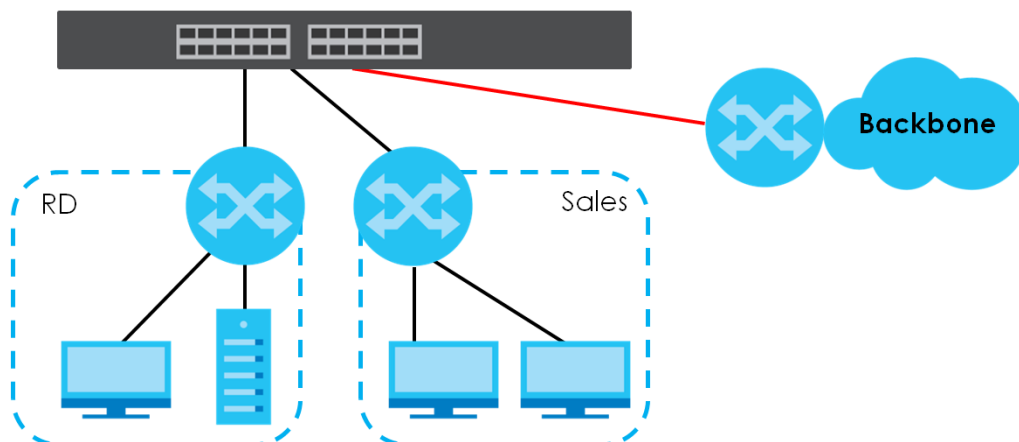

1.2.4 High Performance Switching Example

The Switch is ideal for connecting two geographically dispersed networks that need high bandwidth. In the following example, a company uses the 10 Gigabit uplink ports to connect the headquarters to a

branch office network. Within the headquarters network, a company can use trunking to group several physical ports into one logical higher-capacity link. Trunking can be used if for example, it is cheaper to use multiple lower-speed links than to under-utilize a high-speed, but more costly, single-port link.

Figure 8 High Performance Switching

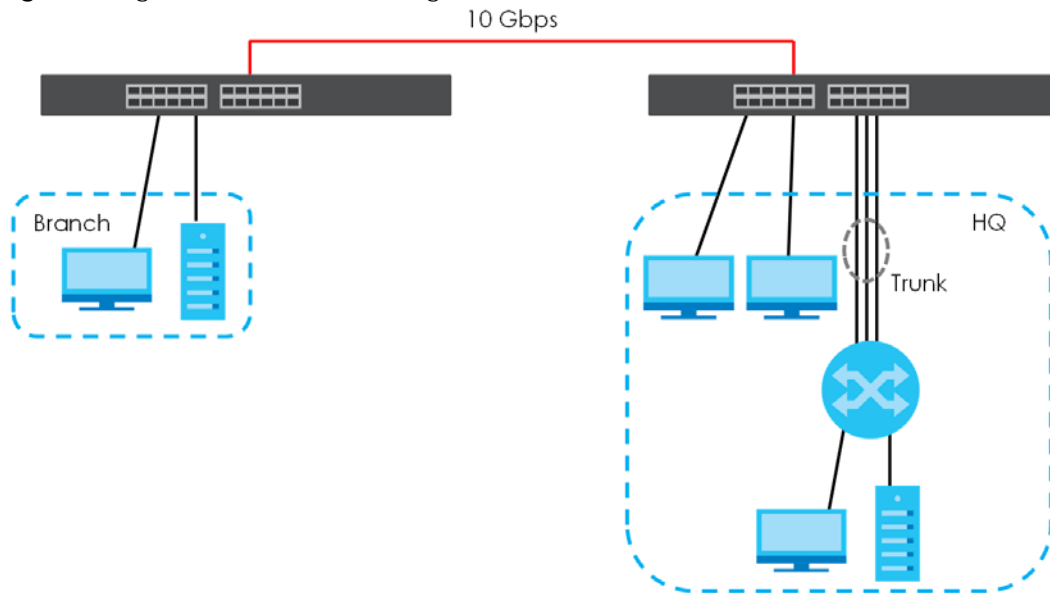

1.2.5 IEEE 802.1Q VLAN Application Examples

A VLAN (Virtual Local Area Network) allows a physical network to be partitioned into multiple logical networks. Stations on a logical network belong to one or more groups. With VLAN, a station cannot directly talk to or hear from stations that are not in the same groups unless such traffic first goes through a router.

1.2.5.1 Tag-based VLAN Example

Ports in the same VLAN group share the same frame broadcast domain thereby increase network performance through reduced broadcast traffic. VLAN groups can be modified at any time by adding, moving or changing ports without any re-cabling.

Shared resources such as a server can be used by all ports in the same VLAN as the server. In the following figure only ports that need access to the server need to be part of VLAN 1. Ports can belong to other VLAN groups too.

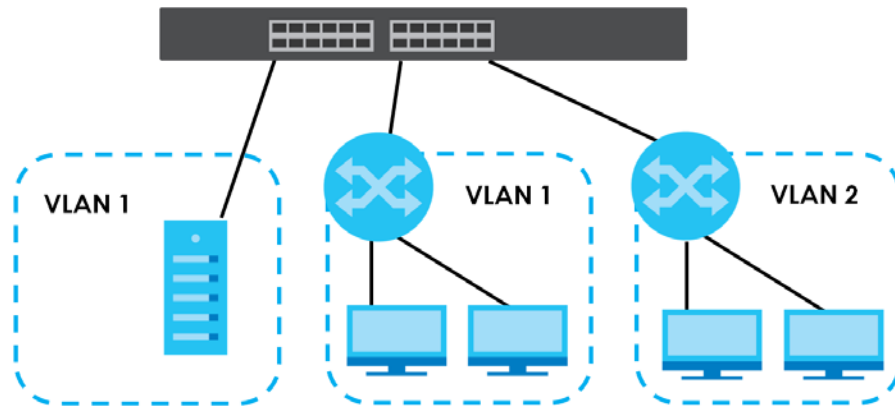
Figure 9 Shared Server Using VLAN Example

1.2.6 IPv6 Support

IPv6 (Internet Protocol version 6), is designed to enhance IP address size and features. The increase in IPv6 address size to 128 bits (from the 32-bit IPv4 address) allows up to 3.4×10^{38} IP addresses. At the time of writing, the Switch supports the following features.

- Static address assignment and stateless auto-configuration
- Neighbor Discovery Protocol (a protocol used to discover other IPv6 devices in a network)
- Remote Management using ping, SNMP, SSH, telnet, HTTP and FTP services
- ICMPv6 to report errors encountered in packet processing and perform diagnostic functions, such as "ping"
- IPv4/IPv6 dual stack; the Switch can run IPv4 and IPv6 at the same time
- DHCPv6 client and relay
- Multicast Listener Discovery (MLD) snooping and proxy

For more information on IPv6, refer to [Appendix C on page 702](#) and the CLI Reference Guide.

1.3 Ways to Manage the Switch

Use any of the following methods to manage the Switch.

- NCC (Zyxel Nebula Control Center). With the NCC, you can remotely manage and monitor the Switch through a cloud-based network management system. See the NCC User's Guide for detailed information about how to access the NCC and manage your Switch through the NCC. See the NCC User's Guide for how to configure Nebula managed devices.
- Web Configurator. This is recommended for everyday management of the Switch using a (supported) web browser. See [Chapter 4 on page 58](#).
- Command Line Interface. Line commands offer an alternative to the Web Configurator and in some cases are necessary to configure advanced features. See the CLI Reference Guide.
- FTP. Use File Transfer Protocol for firmware upgrades and configuration backup or restore. See [Section 79.3.1 on page 605](#).
- SNMP. The Switch can be monitored and/or managed by an SNMP manager. See [Section 26.6.1 on page 198](#).

- Cluster Management. Cluster Management allows you to manage multiple switches through one switch, called the cluster manager. See [Chapter 79 on page 608](#).
- ZON Utility. ZON Utility is a program designed to help you deploy and perform initial setup on a network more efficiently. See [Section 4.3 on page 63](#).

1.4 Good Habits for Managing the Switch

Do the following regularly to make the Switch more secure and to manage the Switch more effectively.

- Change the password. Use a password that is not easy to guess and that consists of different types of characters, such as numbers and letters.
- Write down the password and put it in a safe place.
- Back up the configuration (and make sure you know how to restore it). Restoring an earlier working configuration may be useful if the device becomes unstable or even crashes. If you forget your password, you will have to reset the Switch to its factory default settings. If you backed up an earlier configuration file, you would not have to totally re-configure the Switch. You could simply restore your last configuration.

CHAPTER 2

Hardware Installation and Connection

2.1 Installation Scenarios

This chapter shows you how to install and connect the Switch.

The Switch can be:

- Placed on a desktop.
- Rack-mounted on a standard EIA rack.

2.2 Safety Precautions

Please observe the following before using the Switch:

- It is recommended to ask an authorized technician to attach the Switch on a desk or to the rack or wall. Use the proper screws to prevent damage to the Switch. See the **Installation Requirements** sections in this chapter to know the types of screws and screwdrivers for each mounting method.
- Make sure there is at least 2 cm of clearance on the top and bottom of the Switch, and at least 5 cm of clearance on all four sides of the Switch. This allows air circulation for cooling.
- Do NOT block the ventilation holes nor store cables or power cords on the Switch. Allow clearance for the ventilation holes to prevent your Switch from overheating. This is especially crucial when your Switch does not have fans. Overheating could affect the performance of your Switch, or even damage it.
- The surface of the Switch could be hot when it is functioning. Do NOT put your hands on it. You may get burned. This could happen especially when you are using a fanless Switch.
- The Switches with fans are not suitable for use in locations where children are likely to be present.

To start using the Switch, simply connect the power cables to turn it on.

2.3 Freestanding Installation Procedure

- 1 Make sure the Switch is clean and dry.
- 2 Remove the adhesive backing from the rubber feet.

- 3 Attach the rubber feet to each corner on the bottom of the Switch. These rubber feet help protect the Switch from shock or vibration and ensure space between devices when stacking.

Figure 10 Attaching Rubber Feet

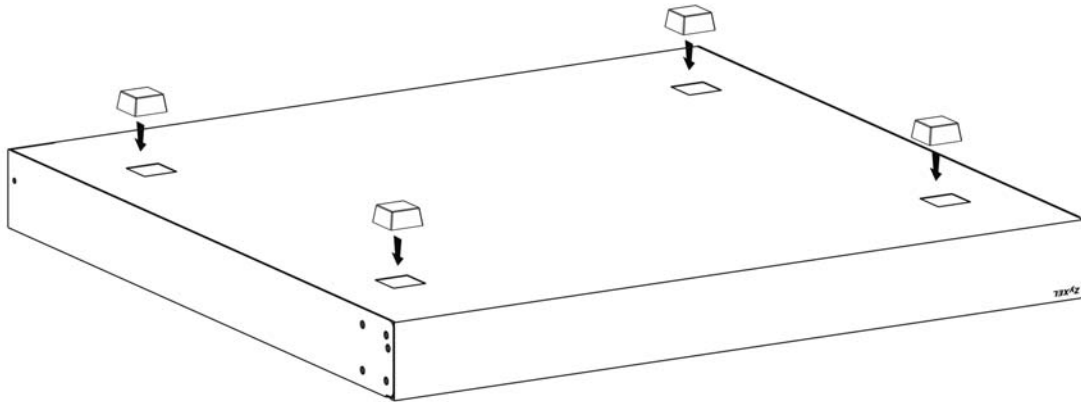

- 4 Set the Switch on a smooth, level surface strong enough to support the weight of the Switch and the connected cables. Make sure there is a power outlet nearby.

Cautions:

- Avoid stacking fanless Switches to prevent overheating.
- Ensure enough clearance around the Switch to allow air circulation for cooling.
- Do NOT remove the rubber feet as it provides space for air circulation.

2.4 Mounting the Switch on a Rack

The Switch can be mounted on an EIA standard size, 19-inch rack or in a wiring closet with other equipment. Follow the steps below to mount your Switch on a standard EIA rack using a rack-mounting kit.

Note: Make sure there is enough clearance between each equipment on the rack for air circulation.

2.4.1 Installation Requirements

- Two mounting brackets.
- Eight M3 flat head screws and a #2 Philips screwdriver.
- Four M5 flat head screws and a #2 Philips screwdriver.

2.4.2 Precautions

- Make sure the rack will safely support the combined weight of all the equipment it contains. The maximum weight a bracket can hold is 21.5 kg.
- Make sure the position of the Switch does not make the rack unstable or top-heavy. Take all necessary precautions to anchor the rack securely before installing the unit.

2.4.3 Attaching the Mounting Brackets to the Switch

- 1 Position a mounting bracket on one side of the Switch, lining up the four screw holes on the bracket with the screw holes on the side of the Switch.

Figure 11 Attaching the Mounting Brackets

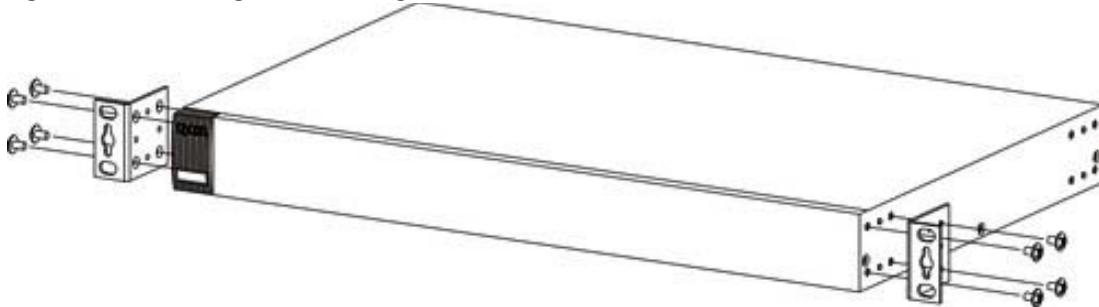

- 2 Using a #2 Philips screwdriver, install the M3 flat head screws through the mounting bracket holes into the Switch.
- 3 Repeat steps 1 and 2 to install the second mounting bracket on the other side of the Switch.
- 4 You may now mount the Switch on a rack. Proceed to the next section.

2.4.4 Mounting the Switch on a Rack

- 1 Position a mounting bracket (that is already attached to the Switch) on one side of the rack, lining up the two screw holes on the bracket with the screw holes on the side of the rack.

Figure 12 Mounting the Switch on a Rack

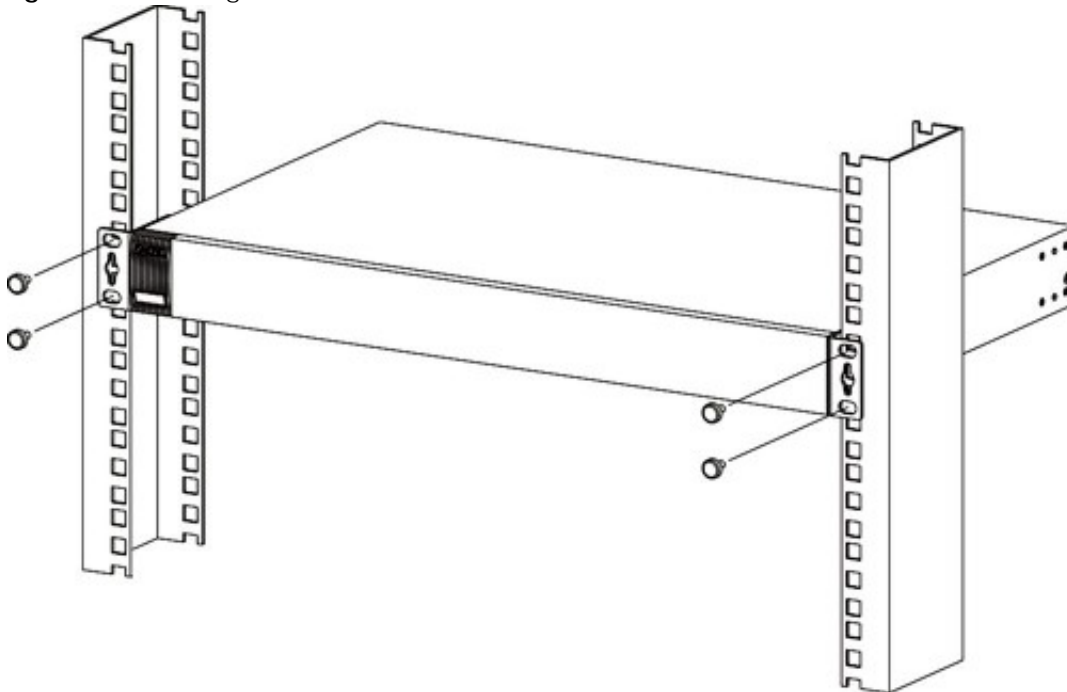

- 2 Using a #2 Philips screwdriver, install the M5 flat head screws through the mounting bracket holes into

the rack.

Note: Make sure you tighten all the four screws to prevent the Switch from getting slanted.

- 3** Repeat steps 1 and 2 to attach the second mounting bracket on the other side of the rack.

CHAPTER 3

Hardware Panels

This chapter describes the front panel and rear panel of the Switch and shows you how to make the hardware connections.

3.1 Front Panel Connections

The following figures show the front panels of the Switch.

Figure 13 Front Panel: XGS2220-30



Figure 14 Front Panel: XGS2220-30HP



Figure 15 Front Panel: XGS2220-30F



Figure 16 Front Panel: XGS2220-54



Figure 17 Front Panel: XGS2220-54HP



Figure 18 Front Panel: XGS2220-54FP



The following table describes the ports.

Table 6 Front Panel Connections

CONNECTOR	DESCRIPTION
24/48 1000Base-T RJ-45 Ethernet Ports	These are 10/100/1000Base-T auto-negotiating and auto-crossover Ethernet ports. Connect these ports to a computer, a hub, a router, or an Ethernet switch.
2 10GBase-T RJ-45 Ethernet Ports	These are 1/2.5/5/10G auto-negotiating and auto-crossover Ethernet ports. Connect these ports to a gaming computer, a NAS (network-attached storage), or a server.
16/40 1000Base-T RJ-45 PoE Ports	These are 10/100/1000Base-T auto-negotiating and auto-crossover IEEE802.3at PoE+ 30 W ports. Connect these ports to a PTZ (pan, tilt and zoom) camera, a WiFi 6 (802.11ax) router, a WiFi 6 (802.11ax) AP, or an Ethernet switch.
8 1000Base-T RJ-45 PoE Ports	These are 10/100/1000Base-T auto-negotiating and auto-crossover IEEE802.3bt PoE++ 60 W ports. Connect these ports to a PTZ (pan, tilt and zoom) camera, a WiFi 6 (802.11ax) router, a WiFi 6 (802.11ax) AP, or an Ethernet switch.
2 10GBase-T RJ-45 PoE Ports	These are 1G, 2.5G, 5G, and 10G auto-negotiating and auto-crossover IEEE802.3bt PoE++ 60 W ports. Connect these ports to a PTZ (pan, tilt and zoom) camera, a WiFi 6 (802.11ax) router, a WiFi 6 (802.11ax) AP, or an Ethernet switch.
4 1/10G SFP+ Slots	Use SFP+ transceivers in these ports for high-bandwidth backbone connections. You can also insert an SFP+ Direct Attach Copper (DAC) in the SFP+ slot.
Reset	Press the RESET button to reboot the Switch without turning the power off. See Section 3.3 on page 54 for more information about the LED behavior.
Restore	<p>IN STANDALONE MODE</p> <p>Press the RESTORE button for 3 to 7 seconds to have the Switch automatically reboot and restore the last-saved custom default file. See Section 3.3 on page 54 for more information about the LED behavior.</p> <p>Press the RESTORE button for more than 7 seconds to have the Switch automatically reboot and restore the factory default file. See Section 3.3 on page 54 for more information about the LED behavior.</p> <p>IN NEBULA CLOUD MODE</p> <p>Press the RESTORE button for more than 7 seconds to have the Switch automatically reboot and restore the factory default file.</p>

3.1.1 Multi-Gigabit Ethernet Ports

The Switch has 1000Base-T auto-negotiating, auto-crossover Ethernet ports. In 10/100/1000 Mbps Gigabit Ethernet, the speed can be 10 Mbps, 100 Mbps or 1000 Mbps. The duplex mode can be half duplex or full duplex.

An auto-negotiating port can detect and adjust to the optimum Ethernet speed (10/100/1000 Mbps) and duplex mode (full duplex or half duplex) of the connected device.

An auto-crossover (auto-MDI/MDI-X) port automatically works with a straight-through or crossover Ethernet cable.

When auto-negotiation is turned on, an Ethernet port negotiates with the peer automatically to determine the connection speed and duplex mode. If the peer Ethernet port does not support auto-

negotiation or turns off this feature, the Switch determines the connection speed by detecting the signal on the cable and using half duplex mode. When the Switch's auto-negotiation is turned off, an Ethernet port uses the pre-configured speed and duplex mode when making a connection, thereby requiring you to make sure that the settings of the peer Ethernet port are the same in order to connect.

3.1.1.1 Default Ethernet Negotiation Settings

The factory default negotiation settings for the Gigabit ports on the Switch are:

- Speed: Auto
- Duplex: Auto
- Flow control: Off
- Link Aggregation: Disabled

3.1.1.2 Auto-crossover

All ports support auto-crossover, that is auto-MDIX ports (Media Dependent Interface Crossover), so you may use either a straight-through Ethernet cable or crossover Ethernet cable for all Gigabit port connections. Auto-crossover ports automatically sense whether they need to function as crossover or straight ports, so crossover cables can connect both computers and switches or hubs.

3.1.2 SFP/SFP+ Slots

These are four slots for Small Form-Factor Pluggable (SFP) or SFP+ modules, such as an SFP or SFP+ transceiver. The SFP+ (SFP Plus) is an enhanced version of the SFP and supports data rates of 10 Gbps. A transceiver is a single unit that houses a transmitter and a receiver. Use a transceiver to connect a fiber optic cable to the Switch. The Switch does not come with transceivers. You must use transceivers that comply with the Small Form-Factor Pluggable (SFP) Transceiver MultiSource Agreement (MSA). See the SFF committee's INF-8074i specification Rev 1.0 for details.

You can change transceivers while the Switch is operating. You can use different transceivers to connect to Ethernet switches with different types of fiber optic connectors.

- Type: SFP or SFP+ connection interface
- Connection speed: 1 or 10 Gigabit per second (Gbps)

WARNING! To avoid possible eye injury, do not look into an operating fiber optic module's connectors.

HANDLING! All transceivers are static sensitive. To prevent damage from electrostatic discharge (ESD), it is recommended you attach an ESD preventive wrist strap to your wrist and to a bare metal surface when you install or remove a transceiver.

STORAGE! All modules are dust sensitive. When not in use, always keep the dust plug on. Avoid getting dust and other contaminant into the optical bores, as the optics do not work correctly when obstructed with dust.

3.1.2.1 Transceiver Installation

Use the following steps to install a transceiver.

- 1 Attach an ESD preventive wrist strap to your wrist and to a bare metal surface.

- 2 Align the transceiver in front of the slot opening.
- 3 Make sure the latch is in the lock position (latch styles vary), then insert the transceiver into the slot with the exposed section of PCB board facing down.
- 4 Press the transceiver firmly until it clicks into place.
- 5 The Switch automatically detects the installed transceiver. Check the LEDs to verify that it is functioning properly.
- 6 Remove the dust plugs from the transceiver and cables (dust plug styles vary).
- 7 Identify the signal transmission direction of the fiber optic cables and the transceiver. Insert the fiber optic cable into the transceiver.

Figure 19 Latch in the Lock Position

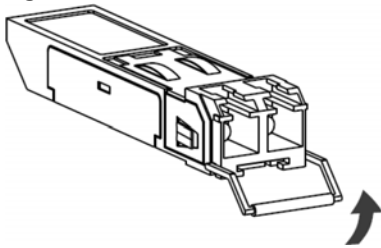

Figure 20 Transceiver Installation Example

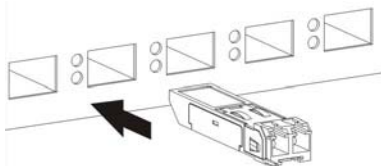
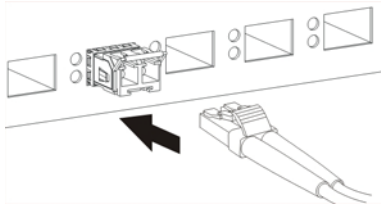

Figure 21 Connecting the Fiber Optic Cables



3.1.2.2 Transceiver Removal

Use the following steps to remove an SFP transceiver.

- 1 Attach an ESD preventive wrist strap to your wrist and to a bare metal surface on the chassis.
- 2 Remove the fiber optic cables from the transceiver.
- 3 Pull out the latch and down to unlock the transceiver (latch styles vary).

Note: Make sure the transceiver's latch is pushed all the way down, so the transceiver can be pulled out successfully.

- 4 Pull the latch, or use your thumb and index finger to grasp the tabs on both sides of the transceiver, and carefully slide it out of the slot.

Note: Do NOT pull the transceiver out by force. You could damage it. If the transceiver will not slide out, grasp the tabs on both sides of the transceiver with a slight up or down motion and carefully slide it out of the slot. If unsuccessful, contact Zyxel Support to prevent damage to your Switch and transceiver.

- 5 Insert the dust plug into the ports on the transceiver and the cables.

Figure 22 Removing the Fiber Optic Cables

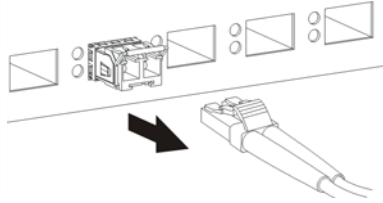

Figure 23 Opening the Transceiver's Latch Example

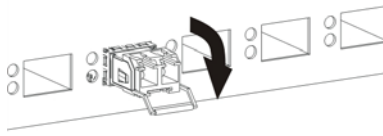
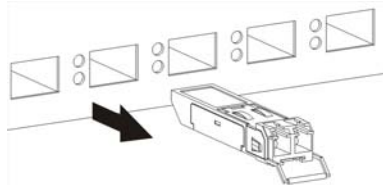

Figure 24 Transceiver Removal Example



3.1.3 Console Port

Without Access L3 License

With instructions from customer support, This USB Type C connector is for troubleshooting only.

With Access L3 License

When the Access L3 license is activated in your Switch, connect this port to your computer (using an USB Type C console cable) if you want to configure the Switch using the command line interface (CLI) through the console port.

3.2 Rear Panel

The following figures show the rear panel of the Switch. The rear panel contains:

Figure 25 Rear Panel: XGS2220-30

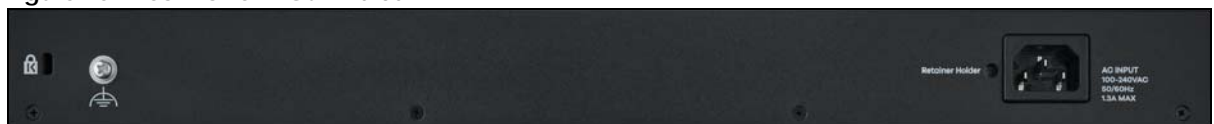
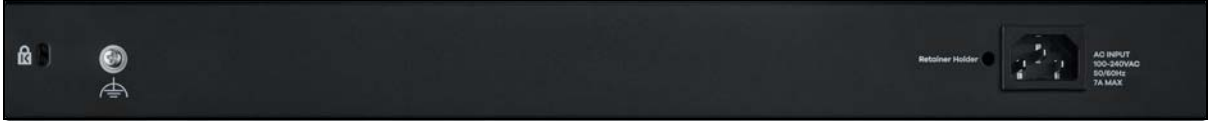
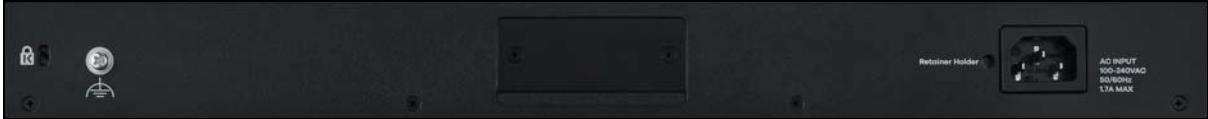
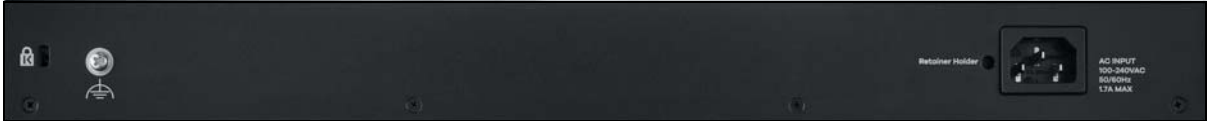
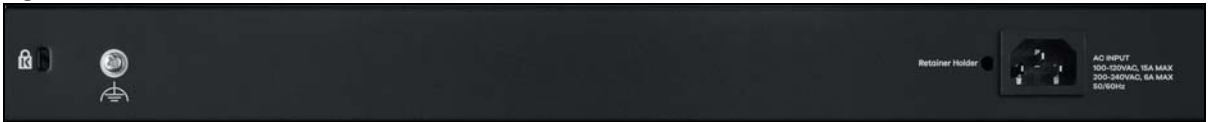

Figure 26 Rear Panel: XGS2220-30HP**Figure 27** Rear Panel: XGS2220-30F**Figure 28** Rear Panel: XGS2220-54**Figure 29** Rear Panel: XGS2220-54HP**Figure 30** Rear Panel: XGS2220-54FP

3.2.1 Grounding

Grounding is a safety measure to direct excess electric charge to the ground. It prevents damage to the Switch, and protects you from electrocution. Use the grounding screw on the rear panel and the ground wire of the AC power supply to ground the Switch.

The grounding terminal and AC power ground where you install the Switch must follow your country's regulations. Qualified service personnel must ensure the building's protective earthing terminals are valid terminals.

Installation of Ethernet cables must be separate from AC power lines. To avoid electric surge and electromagnetic interference, use a different electrical conduit or raceway (tube/trough or enclosed conduit for protecting electric wiring) that is 15 cm apart, or as specified by your country's electrical regulations.

Any device that is located outdoors and connected to this product must be properly grounded and surge protected. To the extent permissible by your country's applicable law, failure to follow these guidelines could result in damage to your Switch which may not be covered by its warranty.

Note: The specification for surge or ESD protection assumes that the Switch is properly grounded.

- 1 Remove the M4 ground screw from the Switch's rear panel.
- 2 Secure a green or yellow ground cable (16 AWG or smaller) to the Switch's rear panel using the M4 ground screw.

Figure 31 Grounding

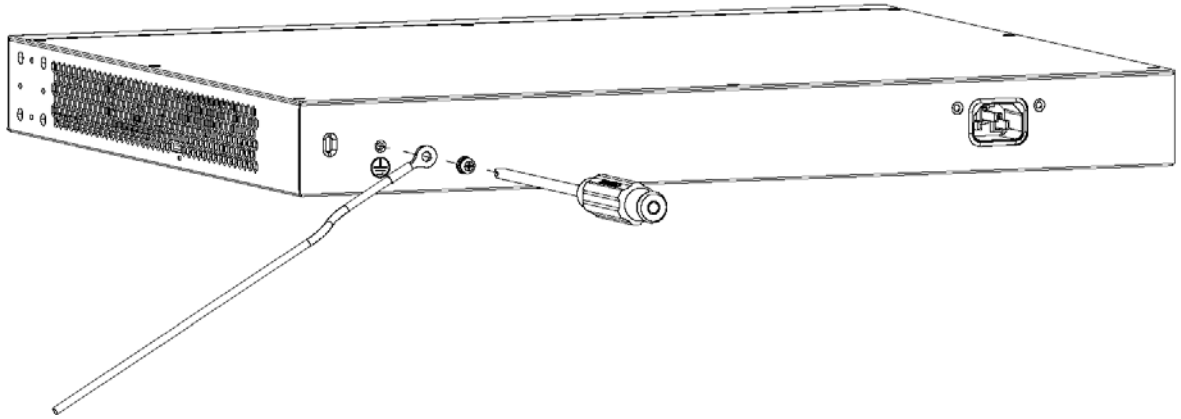

- 3 Attach the other end of the ground cable to a grounding bar located on the rack where you install the Switch or to an on-site grounding terminal.

Figure 32 Attach Ground Cable to Grounding Bar or On-site Grounding Terminal

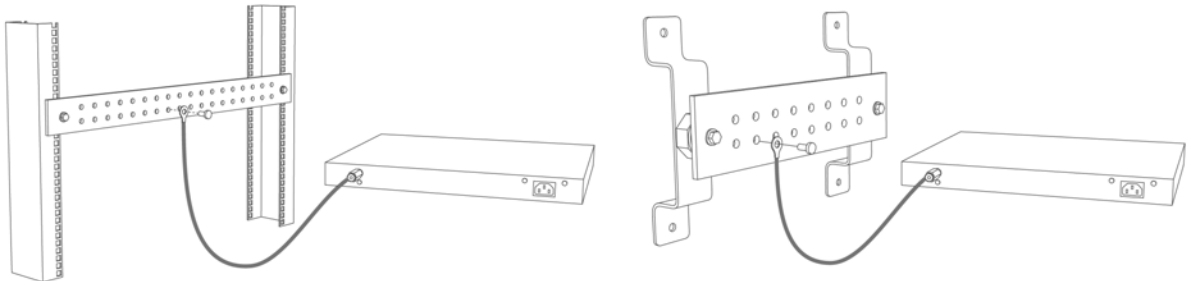

- 4 The grounding terminal of the server rack or on-site grounding terminal must also be grounded and connected to the building's main grounding electrode. Make sure the grounding terminal is connected to the buildings grounding electrode and has an earth resistance of less than 10 ohms, or according to your country's electrical regulations.

Figure 33 Connecting to the Building's Main Grounding Electrode

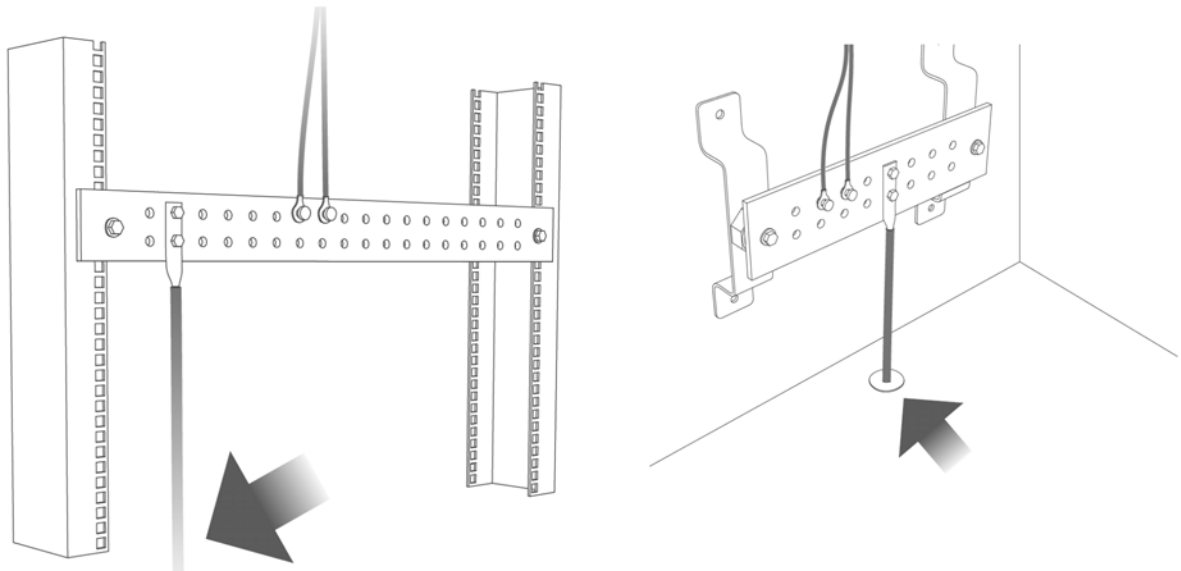

If you are uncertain that suitable grounding is available, contact the appropriate electrical inspection

authority or an electrician.

This device must be grounded. Do this before you make other connections.

3.2.2 AC Power Connection

Note: Make sure you are using the correct power source as shown on the panel and that no objects obstruct the airflow of the fans (located on the side of the unit).

To connect power to the Switch, insert the female end of the power cord to the AC power receptacle on the rear panel. Connect the other end of the supplied power cord to a power outlet.

Power Cord Requirement (XGS2220-54HP / XGS2220-54FP)

Make sure to use the provided or designated power cord for your Switch.

The following table describes the power cord requirements for XGS2220-54HP / XGS2220-54FP.

Table 7 XGS2220-54HP / XGS2220-54FP Power Cord Specifications

COUNTRIES	SPECIFICATION	SUPPLY VOLTAGE
Europe and United Kingdom	18 AWG	230 V
North America	14 AWG	110 V

Note: If you need to replace the power cord, contact your local vendor.

Installing the Retainer Clip

Install the retainer clip to prevent accidental removal of the power cord.

- 1 Loosely wrap the clip on the retainer to the power cord.

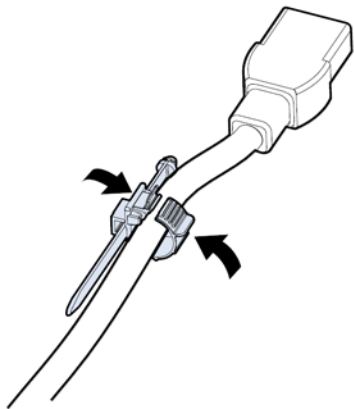

- 2 Push the pronged-end of the retainer clip into the **Retainer Holder** hole until it locks into place.

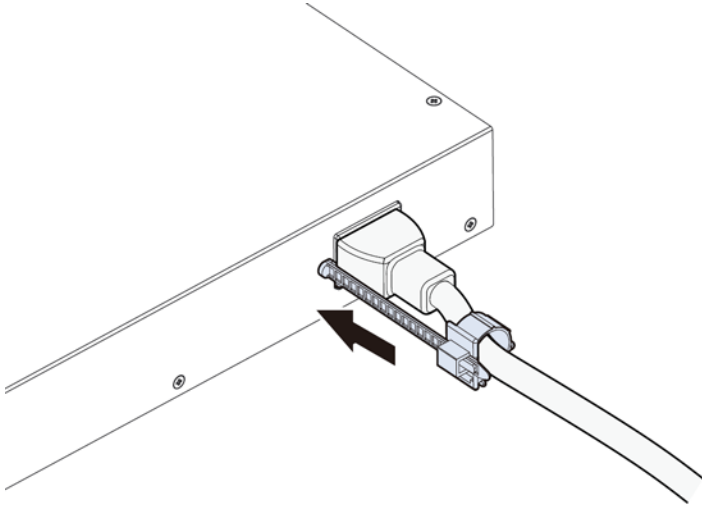

- 3** Slide the clip up to the end of the power cord.

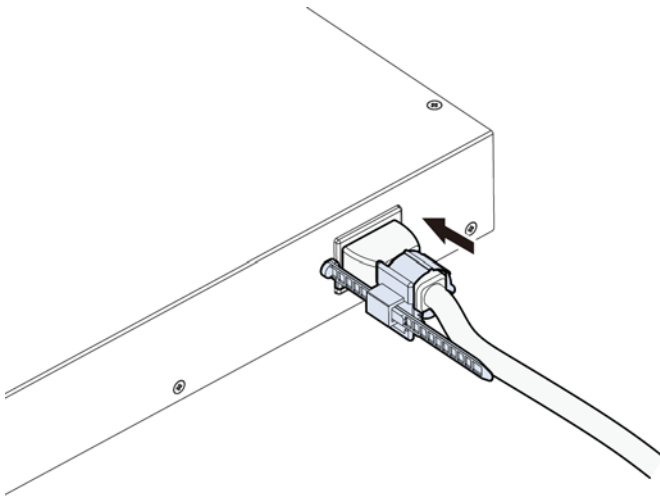

- 4** Close the clip tightly around the power cord until secure.

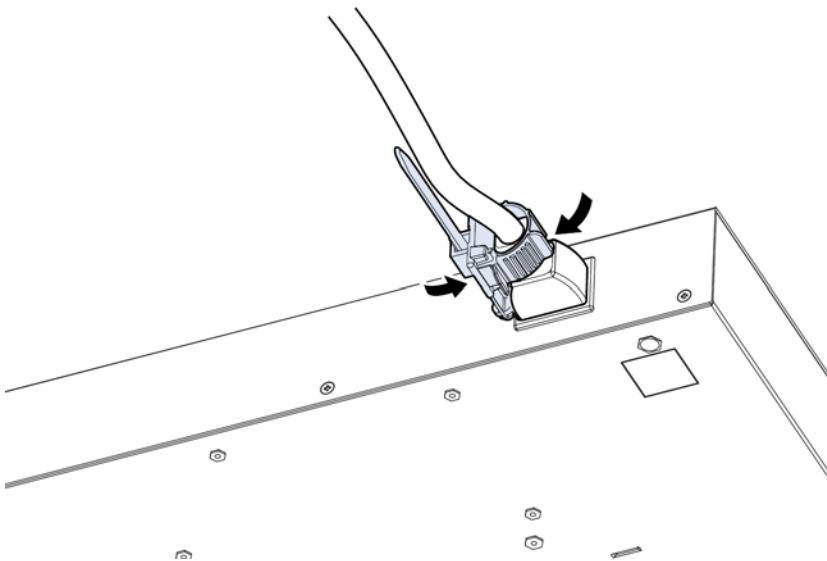

3.3 LEDs

After you connect the power to the Switch, view the LEDs to ensure proper functioning of the Switch and as an aid in troubleshooting.

Table 8 LED Descriptions

LED	COLOR	STATUS	DESCRIPTION
PWR/SYS	Green	On	The Switch is on and functioning properly.
		Blinking	The Switch is rebooting and performing self-diagnostic tests.
	Yellow	On	The Switch is functioning abnormally, FAN status alert/error, or the system power detected is under 10.8 V.
		Blinking	The Switch is returning to its factory default configuration settings.
		Off	The Switch is not receiving power from the power source.
CLOUD	Green	On	The Switch has successfully connected to the NCC (Nebula Control Center).
		Blinking	The Switch cannot connect to the NCC because it is not registered. Please register the Switch with NCC.
	Yellow	On	The Switch is registered with NCC but cannot connect to the NCC. Please check the Internet connection of the Switch.
		Blinking	The Switch is not registered with NCC and cannot connect to the NCC. Please check the Internet connection of the Switch and register the Switch with NCC.
		Off	The Switch is operating in standalone mode. Nebula Control Center (NCC) Discovery is disabled in SYSTEM > Cloud Management in the Switch Web Configurator.
LOCATOR	Blue	On	The Switch is uploading firmware. While the Switch is doing this, do not turn off the power.
		Blinking	Shows the actual location of the Switch between several devices in a rack. The default timer is 30 minutes when you are configuring the Switch.
		Off	The locator is not functioning or malfunctioning.
PoE MAX (XGS2220-30HP / XGS2220-54HP / XGS2220-54FP)	Red	On	PoE power usage is more than 95 percent of the power supplied budget.
	Yellow	On	PoE power usage is below 95 percent of the power supplied budget, but over 80 percent of the power supplied budget.
		Off	PoE power usage is below 80 percent of the power supplied budget.
STACK ID			The LED is showing the Stack ID number of the Switch. ID 0 means it is a standalone Switch.
PRIMARY	Green	On	The Switch is acting as a standalone switch or the master in stacking.
	Yellow	On	An error occurred when the Switch is selected as the master member in a stack.
		Off	The Switch is acting as a non-master member in a stack.

LED	COLOR	STATUS	DESCRIPTION
10M/100M/1000M Base-T Ports			
Link / ACT 1 – 24 (XGS2220-30 / XGS2220-30HP)	Green	On	The link to a 1000M Ethernet network is up.
		Blinking	The Switch is transmitting/receiving to/from a 1000M Ethernet network.
1 – 48 (XGS2220-54 / XGS2220-54HP / XGS2220-54FP)	Yellow	On	The link to a 10M/100M Ethernet network is up.
		Blinking	The Switch is transmitting/receiving to/from a 10M/100M Ethernet network.
		Off	The link to an Ethernet network is down.

1G/2.5G/5G/10G Base-T Ports			
Link / ACT 25 – 26 (XGS2220-30 / XGS2220-30HP / XGS2220-30F)	Blue	On	The link to a 10G Ethernet network is up.
		Blinking	The Switch is transmitting/receiving to/from a 10G Ethernet network.
49 – 50 (XGS2220-54 / XGS2220-54HP / XGS2220-54FP)	Green	On	The link to a 1G/2.5G/5G Ethernet network is up.
		Blinking	The Switch is transmitting/receiving to/from a 1G/2.5G/5G Ethernet network.
		Off	The link to an Ethernet network is down.

PoE Mode			
1 – 16 (XGS2220-30HP)	Green	On	Power supplied to all PoE Ethernet ports meets the IEEE 802.3at or IEEE 802.3af standard.
		Off	There is no power supplied.
1 – 40 (XGS2220-54HP / XGS2220-54FP)	Yellow	On	Power supplied to all PoE Ethernet ports meets the IEEE 802.3bt standard.
		Green	Power supplied to all PoE Ethernet ports meets the IEEE 802.3at / IEEE 802.3af standards.
17 – 26 (XGS2220-30HP)		On	Power supplied to all PoE Ethernet ports meets the IEEE 802.3at / IEEE 802.3af standards.
41 – 50 (XGS2220-54HP / XGS2220-54FP)		Off	There is no power supplied.

LED	COLOR	STATUS	DESCRIPTION
1G SFP Slots			
Link / ACT 1 – 24 (XGS2220-30F)	Green	On	The port has a successful 1000M connection.
		Blinking	The port is transmitting or receiving data at 1000M.
	Yellow	On	The port has a successful 100M connection.
		Blinking	The port is transmitting or receiving data at 100M.
		Off	This link is disconnected.

LED	COLOR	STATUS	DESCRIPTION
1G/10G SFP+ Slots			
Link / ACT 27 – 30 (XGS2220-30 / XGS2220-30HP / XGS2220-30F) 51 – 54 (XGS2220-54 / XGS2220-54HP / XGS2220-54FP)	Blue	On	The port has a successful 10G connection.
		Blinking	The port is transmitting or receiving data at 10G.
	Green	On	The port has a successful 1000M connection.
		Blinking	The port is transmitting or receiving data at 1000M.
		Off	This link is disconnected.

PART II

Technical Reference

CHAPTER 4

Web Configurator

4.1 Overview

This section introduces the configuration and functions of the Web Configurator.

The Web Configurator is an HTML-based management interface that allows easy system setup and management through Internet browser. Use a browser that supports HTML5, such as Microsoft Edge, Mozilla Firefox, or Google Chrome. The recommended minimum screen resolution is 1024 by 768 pixels.

In order to use the Web Configurator you need to allow:

- Web browser pop-up windows on your computer.
- JavaScript (enabled by default).
- Java permissions (enabled by default).

4.2 System Login

- 1 Start your web browser.
- 2 The Switch is a DHCP client by default. Type "http://DHCP-assigned IP" in the **Location** or **Address** field. Press [ENTER].

Note: You can always use the domain name "setup.zyxel" to access the Web Configurator whether the Switch is using a DHCP-assigned IP or static IP address. This requires your computer to be directly connected to the Switch. Make sure your computer can connect to a DNS server through the Switch.

If the Switch is not connected to a DHCP server, enter "http://" and the static IP address of the Switch (for example, the default management IP address is 192.168.1.1 through an in-band port) in the **Location** or **Address** field. Press [ENTER]. Your computer must be in the same subnet in order to access this website address.

Also, you can use the ZON Utility to check your Switch's IP address. See [Section 4.3 on page 63](#) for more information on the ZON utility.

- 3 The **Login** screen appears.

Figure 34 Web Configurator: Login

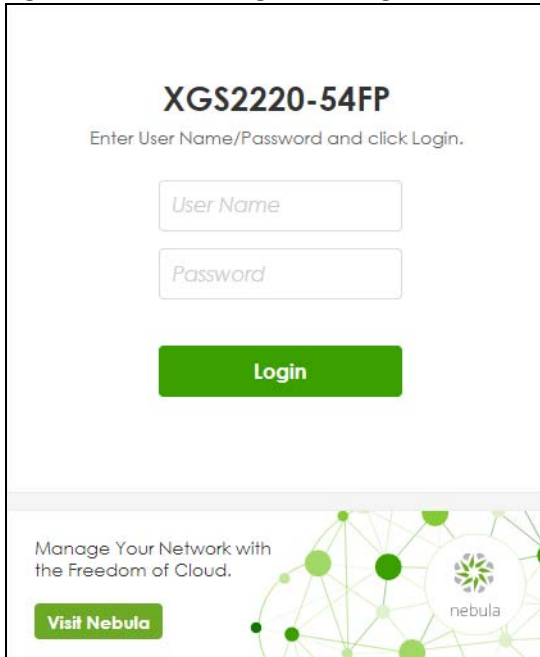

XGS2220-54FP
Enter User Name/Password and click Login.

User Name

Password

Login

Manage Your Network with the Freedom of Cloud.

Visit Nebula

nebula

- 4 Click the **Visit Nebula** button if you want to open the Zyxel Nebula Control Center (NCC) login page in a new tab or window. The NCC is a cloud-based network management system that allows you to remotely manage and monitor the Switch. See [Section 1.1.4 on page 32](#) for information on changing your Switch to Nebula Cloud management.

Figure 35 Visit Nebula

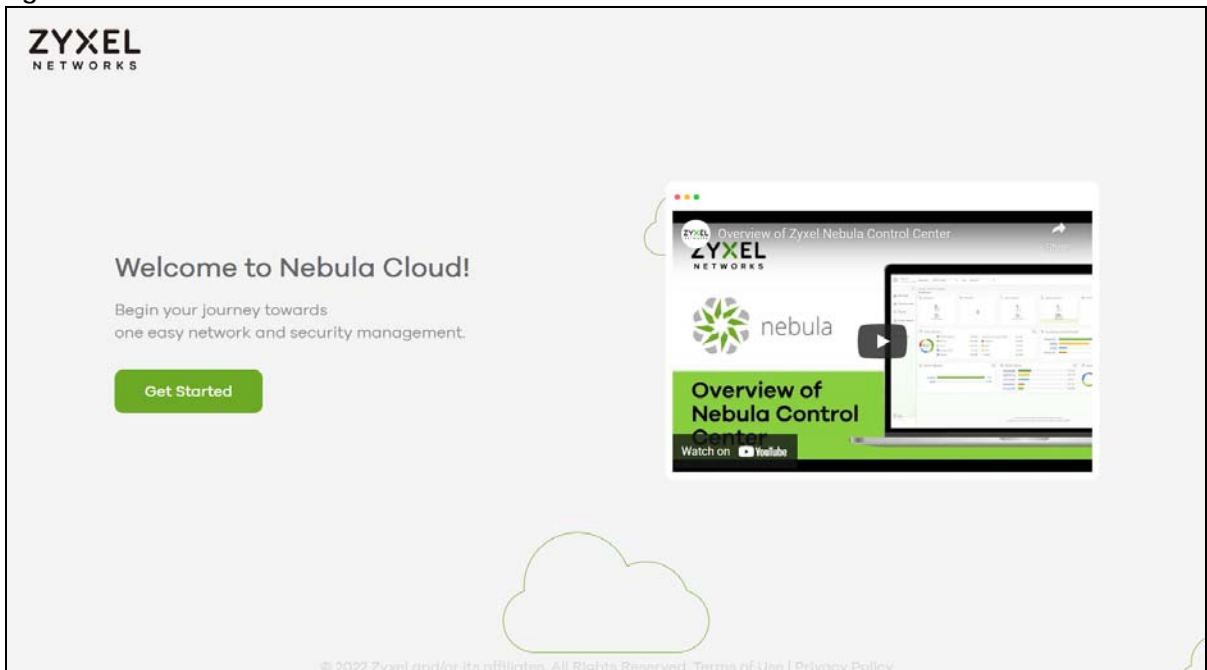

- 5 Alternatively, click **Login** to log into the Web Configurator to manage the Switch directly. The default user name is **admin** and associated default password is **1234**.
- 6 The **Select Mode** screen appears.

Figure 36 Select Mode

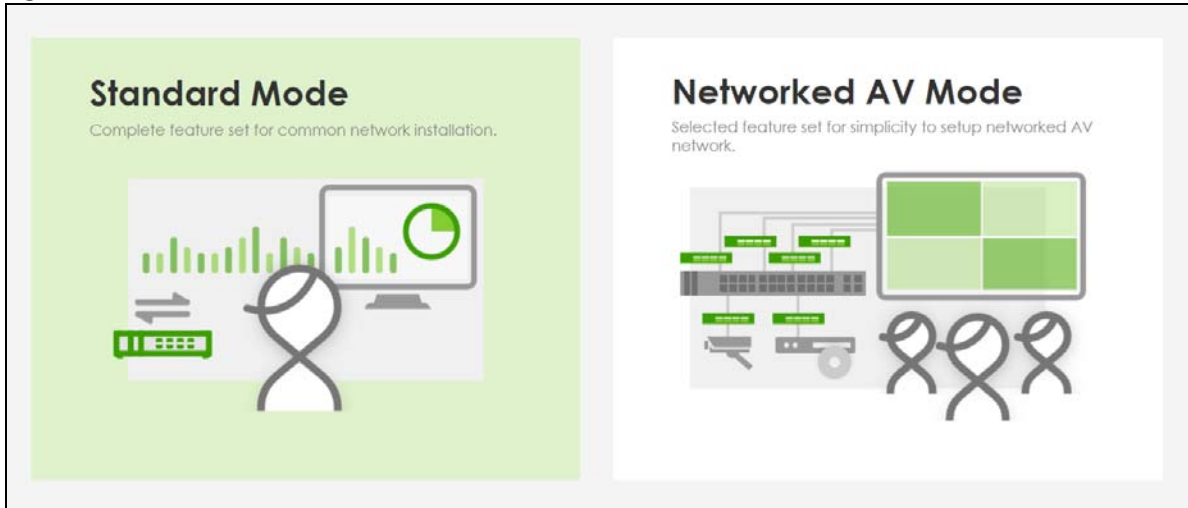

- 7 Select the Web Configurator in **Standard Mode** that has a complete set of configuration for network installation. Or select the Web Configurator in **Networked AV Mode** that has a set of menus specifically designed to simplify configuration and management of the Switch for AVoIP (Audio-Video over Internet Protocol) application.
- 8 If you select **Standard Mode**, go directly to step 10.
- 9 The **Setup Wizard** screen will appear after selecting the **Networked AV Mode**. You can use the **Setup Wizard** screen to configure the Switch's Networked AV mode's basic or advanced settings (see [Section 4.4 on page 67](#) for details).
 - Use the **Basic Settings** to configure networked AV operation on management VLAN. Such as the Switches' IP address, DNS server, system password, SNMP community, accept or skip the default Networked AV mode settings, and view a summary of the basic settings.
 - Use the **Advanced Settings** for networks that wants to separate networked AV VLAN from management VLAN, specify which ports connect to AVoIP application, and for setting link aggregation across switches.

Once you click the **Finish** button, the settings configured in the **Setup Wizard** screen will overwrite the existing settings.

Otherwise, click the **Exit** button. If you want to open the **Setup Wizard** screen later, click the **Wizard** icon in the upper right hand corner of the Web Configurator in Networked AV mode.

Figure 37 Web Configurator: Wizard

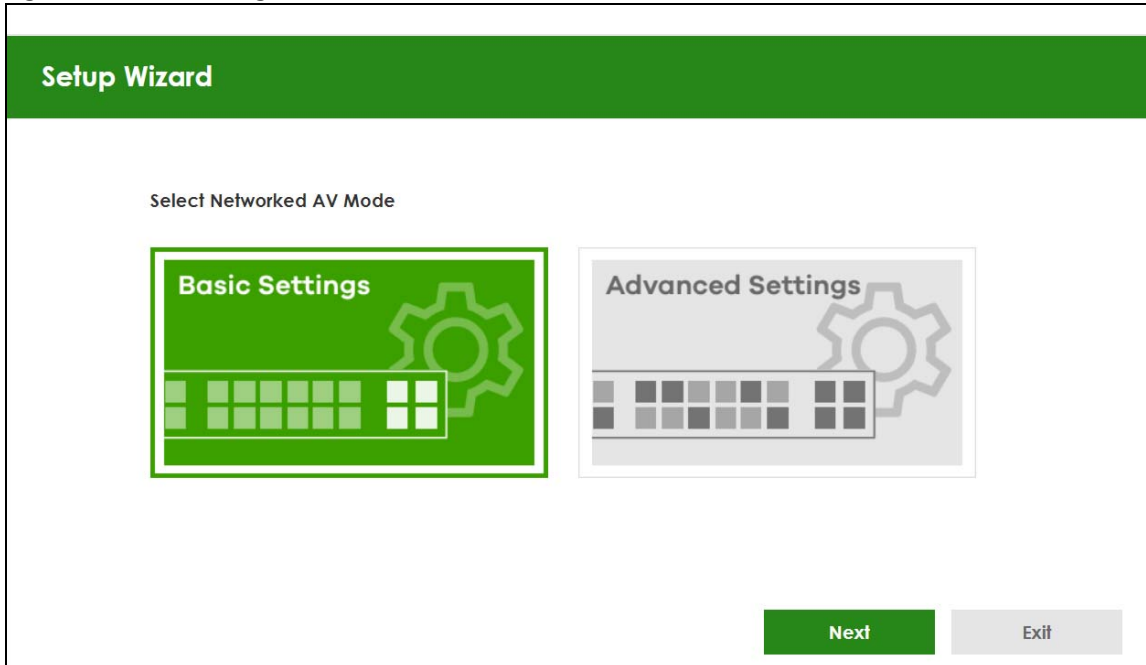

- 10 If you did not change the default administrator password and/or SNMP community values, a warning screen displays each time you log into the Web Configurator and select **Standard Mode**. Click **Password / SNMP** to open a screen where you can change the administrator password and SNMP community string simultaneously. Otherwise, click **Ignore** to close it.
- If you log into the Web Configurator and select **Networked AV Mode**, open the screen in the **Wizard > Step 2 Password** to change the administrator password and SNMP community string. Click **Finish** on the last step of the **Wizard** to save your settings.

Password/SNMP Setting

Figure 38 Web Configurator: Warning

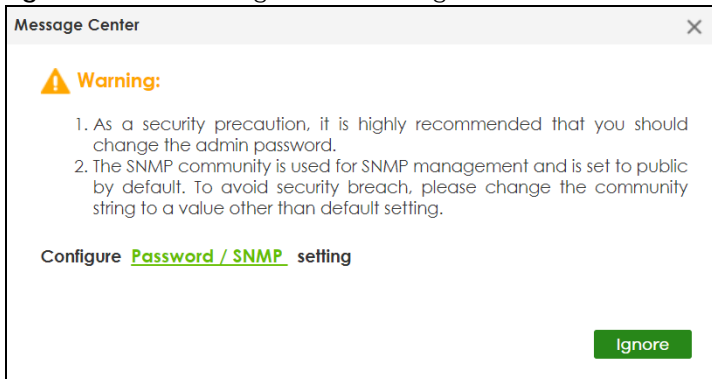

Figure 39 Web Configurator: Password/SNMP

Note: The input string of any field in this screen should not contain [?], [|], ['], ["], or [,]. In the **Password** fields, [space] is also not allowed.

Change the default administrator and/or SNMP passwords, and then click **Apply** to save your changes.

Table 9 Web Configurator: Password/SNMP

LABEL	DESCRIPTION
Password – Administrator	This is the default administrator account with the “admin” user name. You cannot change the default administrator user name.
Old Password	Enter the existing system password (1234 is the default password when shipped).
New Password	Enter your new system password. Up to 32 printable ASCII characters are allowed for the new password.
Retype to confirm	Re-enter your new system password for confirmation.
SNMP – General Setting	Use this section to specify the SNMP version and community (password) values.
Version	Select the SNMP version for the Switch. The SNMP version on the Switch must match the version on the SNMP manager. Choose SNMP version 2c (v2c), SNMP version 3 (v3) or both (v3v2c). Note: SNMP version 2c is backwards compatible with SNMP version 1.
Get Community	Enter the Get Community string, which is the password for the incoming Get- and GetNext-requests from the management station. The Get Community string is only used by SNMP managers using SNMP version 2c or lower.
Set Community	Enter the Set Community string, which is the password for the incoming Set- requests from the management station. The Set Community string is only used by SNMP managers using SNMP version 2c or lower.
Trap Community	Enter the Trap Community string, which is the password sent with each trap to the SNMP manager. The Trap Community string is only used by SNMP managers using SNMP version 2c or lower.
Apply	Click Apply to save your changes to the Switch’s run-time memory. The Switch loses these changes if it is turned off or loses power, so use the Save link on the top navigation panel to save your changes to the non-volatile memory when you are done configuring.
Cancel	Click Cancel to begin configuring this screen afresh.

4.3 Zyxel One Network (ZON) Utility

ZON Utility is a program designed to help you deploy and manage a network more efficiently. It detects devices automatically and allows you to do basic settings on devices in the network without having to be near it.

The ZON Utility issues requests through Zyxel Discovery Protocol (ZDP) and in response to the query, the device responds back with basic information including IP address, firmware version, location, system and model name in the same broadcast domain. The information is then displayed in the ZON Utility screen and you can perform tasks like basic configuration of the devices and batch firmware upgrade in it. You can download the ZON Utility at <https://www.zyxel.com/global/en/form/zon-utility-download> and unzip it first before installing it in a computer (Windows operating system).

4.3.1 Requirements

Before installing the ZON Utility in your computer, please make sure it meets the requirements listed below.

Operating System

At the time of writing, the ZON Utility is compatible with:

- Windows 7 (both 32-bit / 64-bit versions)
- Windows 8 (both 32-bit / 64-bit versions)
- Windows 8.1 (both 32-bit / 64-bit versions)
- Windows 10 (both 32-bit / 64-bit versions)
- Windows 11 (both 32-bit / 64-bit versions)

Hardware

Here are the minimum hardware requirements to use the ZON Utility on your computer.

- Core i3 processor
- 2 GB RAM
- 100 MB free hard disk
- WXGA (Wide XGA 1280 by 800)

4.3.2 Run the ZON Utility

- 1 Double-click the ZON Utility to run it.
- 2 The first time you run the ZON Utility, you will see if your device and firmware version support the ZON Utility. Click the **OK** button to close this screen.

Figure 40 Supported Devices and Versions

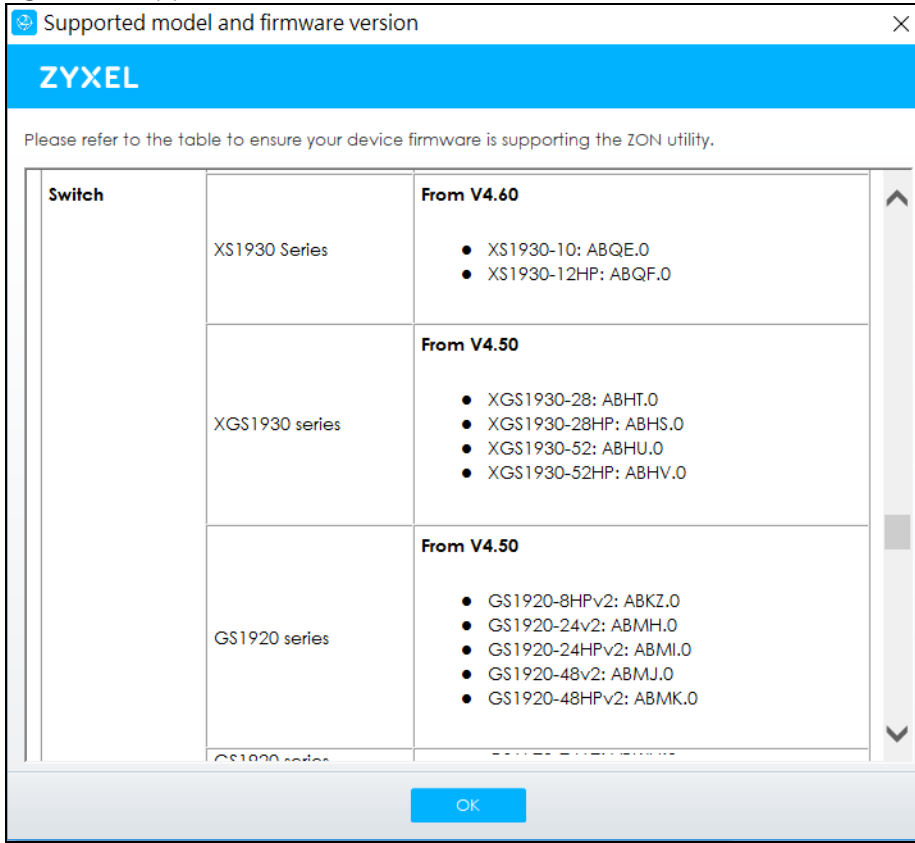

If you want to check the supported models and firmware versions later, you can click the **Show information about ZON** icon in the upper right of the screen. Then select the **Supported model and firmware version** link. If your device is not listed here, see the device release notes for ZON Utility support. The release notes are in the firmware zip file on the Zyxel web site.

Figure 41 ZON Utility Screen

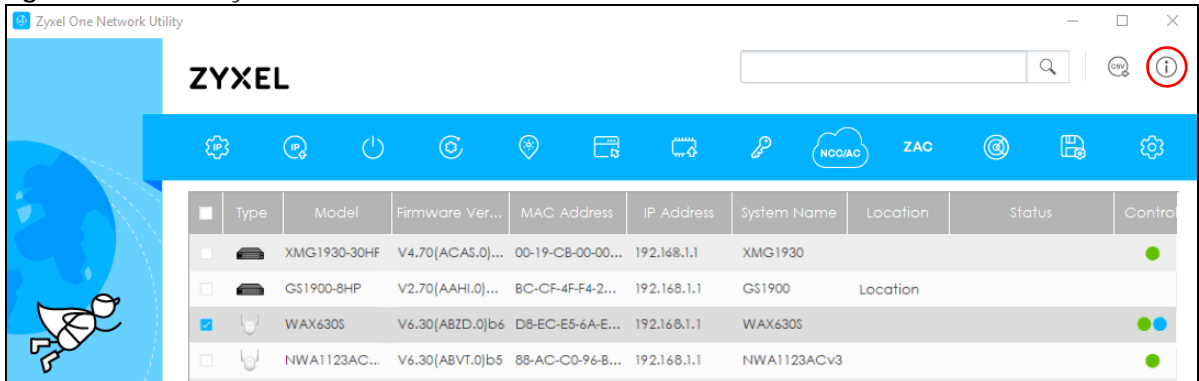

- 3 Select a network adapter to which your supported devices are connected.

Figure 42 Network Adapter

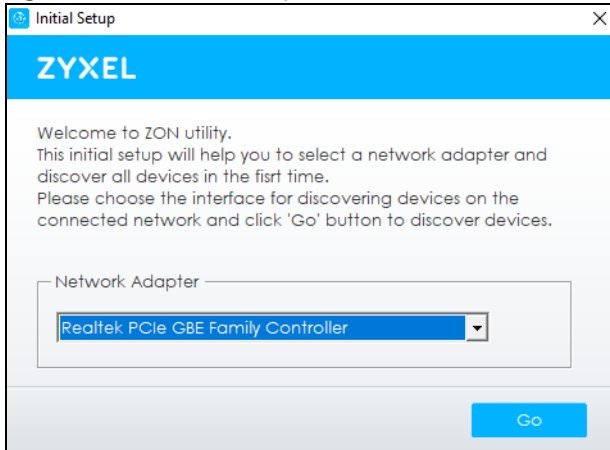

- 4 Click the **Go** button for the ZON Utility to discover all supported devices in your network.

Figure 43 Discovery

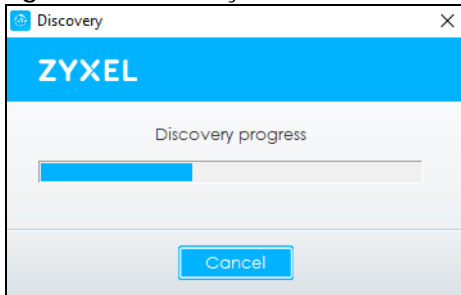

- 5 The ZON Utility screen shows the devices discovered.

Figure 44 ZON Utility Screen



- 6 Select a device and then use the icons to perform actions. Some functions may not be available for your devices.

Note: You must know the selected device admin password before taking actions on the device using the ZON Utility icons.

Figure 45 Password Prompt

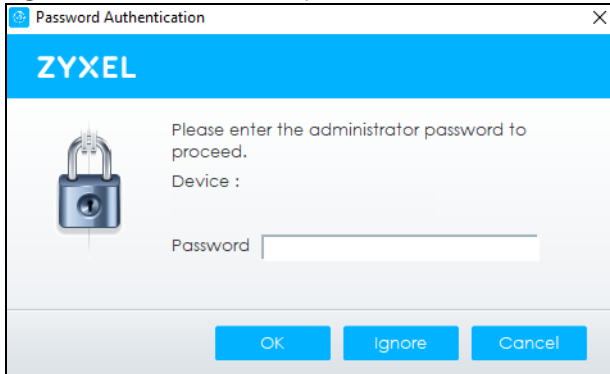

The following table describes the icons numbered from left to right in the ZON Utility screen.

Table 10 ZON Utility Icons

ICON	DESCRIPTION
1 IP Configuration	Change the selected device's IP address.
2 Renew IP Address	Update a DHCP-assigned dynamic IP address.
3 Reboot Device	Use this icon to restart the selected devices. This may be useful when troubleshooting or upgrading new firmware.
4 Reset Configuration to Default	Use this icon to reload the factory-default configuration file. This means that you will lose all previous configurations.
5 Locator LED	Use this icon to locate the selected device by causing its Locator LED to blink.
6 Web GUI	Use this to access the selected device Web Configurator from your browser. You will need a user name and password to log in.
7 Firmware Upgrade	Use this icon to upgrade new firmware to selected devices of the same model. Make sure you have downloaded the firmware from the Zyxel website to your computer and unzipped it in advance.
8 Change Password	Use this icon to change the admin password of the selected device. You must know the current admin password before changing to a new one.
9 Configure NCC Discovery	You must have Internet access to use this feature. Use this icon to enable or disable the Nebula Control Center (NCC) discovery feature on the selected device. If it is enabled, the selected device will try to connect to the NCC. Once the selected device is connected to and has registered in the NCC, it will go into the Nebula cloud management mode.
10 ZAC	Use this icon to run the Zyxel AP Configurator of the selected AP.
11 Clear and Rescan	Use this icon to clear the list and discover all devices on the connected network again.
12 Save Configuration	Use this icon to save configuration changes to permanent memory on a selected device.
13 Settings	Use this icon to select a network adapter for the computer on which the ZON utility is installed, and the utility language.

The following table describes the fields in the ZON Utility main screen.

Table 11 ZON Utility Fields

LABEL	DESCRIPTION
Type	This field displays an icon of the kind of device discovered.
Model	This field displays the model name of the discovered device.
Firmware Version	This field displays the firmware version of the discovered device.
MAC Address	This field displays the MAC address of the discovered device.

Table 11 ZON Utility Fields (continued)

LABEL	DESCRIPTION
IP Address	This field displays the IP address of an internal interface on the discovered device that first received a ZDP discovery request from the ZON Utility.
System Name	This field displays the system name of the discovered device.
Location	This field displays where the discovered device is.
Status	This field displays whether changes to the discovered device have been done successfully. As the Switch does not support IP Configuration , Renew IP address and Flash Locator LED , this field displays "Update failed", "Not support Renew IP address" and "Not support Flash Locator LED" respectively.
Controller Discovery	This field displays if the discovered device supports the Nebula Control Center (NCC) discovery feature. If it is enabled, the selected device will try to connect to the NCC. Once the selected device is connected to and has registered in the NCC, it will go into the Nebula cloud management mode.
Serial Number	Enter the admin password of the discovered device to display its serial number.
Hardware Version	This field displays the hardware version of the discovered device.
IPv6 Address	This field displays the IPv6 address on the discovered device that first received a ZDP discovery request from the ZON Utility.

4.4 Networked AV Mode Wizard

The **Setup Wizard** can be accessed using the following methods:

- When the Switch is in its factory-default state, selecting Networked AV mode will automatically access the **Setup Wizard**.
- When in Networked AV mode, click the **Wizard** link to access the **Setup Wizard**.

Figure 46 Wizard Link in Networked AV Mode



The **Setup Wizard** contains the following parts:

- Use the **Basic Settings** when networked AV service runs on management VLAN, using the combo/fiber port for inter-switch connection.
- Use the **Advanced Settings** when you need to specify the VLAN for networked AV service and configure the port's role manually.

4.4.1 Basic Settings

In **Basic Settings**, you can set up IP or DNS, set up your password, SNMP community, accept or skip the default Networked AV mode settings, and view finished results.

In order to set up your IP or DNS, please do the following. Click **Wizard** > **Basic Settings** > **Next** > **Step 1 IP** to access this screen.

Figure 47 Wizard > Basic Settings > Step 1 IP

1 IP **2** Password **3** Networked AV **4** Summary

STEP

Setup IP

Host Name:

IP Interface: Static IP Interface DHCP Client

VID:

IP Address:

IP Subnet Mask:

Default Gateway:

DNS Server:

Next **Cancel**

Each field is described in the following table.

Table 12 Wizard > Basic Settings > Step 1 IP

LABEL	DESCRIPTION
Host Name	This field displays a host name.
IP Interface	Select DHCP Client if the Switch is connected to a router with the DHCP server enabled. You then need to check the router for the IP address assigned to the Switch in order to access the Switch's Web Configurator again. Select Static IP Interface when the Switch is NOT connected to a router or you want to assign it a fixed IP address.
VID	This field displays the VLAN ID.
IP Address	The Switch needs an IP address for it to be managed over the network.
IP Subnet Mask	The subnet mask specifies the network number portion of an IP address.
Default Gateway	Type the IP address of the default outgoing gateway in dotted decimal notation, for example 192.168.1.254.
DNS Server	DNS (Domain Name System) is for mapping a domain name to its corresponding IP address and vice versa. Enter a domain name server IP address in order to be able to use a domain name instead of an IP address.
Next	Click Next to show the next screen.
Cancel	Click Cancel to exit this screen without saving.

After clicking **Next**, the **Password** screen appears.

Figure 48 Wizard > Basic Settings > Step 2 Password

1 IP **2** Password **3** Networked AV **4** Summary

STEP

Change administrator's password and SNMP

It is recommended to change password and SNMP community string to avoid potential security breach.

Administrator's Password

Current password:

New password:

Confirm password:

SNMP

SNMP: Enabled Disabled

Version:

Get Community:

Set Community:

Trap Community:

Note: The input string of any field in this screen should not contain [?], [|], ['], ["], or [,]. In the **Password** fields, [space] is also not allowed.

Each field is described in the following table.

Table 13 Wizard > Basic Settings > Step 2 Password

LABEL	DESCRIPTION
Administrator's Password	
Current password	Enter the existing system password (1234 is the default password when shipped).
New password	Enter your new system password. Up to 32 printable ASCII characters are allowed for the new password.
Confirm password	Re-enter your new system password for confirmation.
SNMP	
SNMP	Select Enabled to let the Switch act as an SNMP agent, which allows a manager station to manage and monitor the Switch through the network. Select Disabled to turn this feature off.
Version	Select the SNMP version for the Switch. The SNMP version on the Switch must match the version on the SNMP manager. Choose SNMP version 2c (v2c), SNMP version 3 (v3) or both (v3v2c). Note: SNMP version 2c is backwards compatible with SNMP version 1.
Get Community	Enter the Get Community string, which is the password for the incoming Get- and GetNextrequests from the management station. The Get Community string is only used by SNMP managers using SNMP version 2c or lower.
Set Community	Enter the Set Community string, which is the password for the incoming Set- requests from the management station. The Set Community string is only used by SNMP managers using SNMP version 2c or lower.

Table 13 Wizard > Basic Settings > Step 2 Password (continued)

LABEL	DESCRIPTION
Trap Community	Enter the Trap Community string, which is the password sent with each trap to the SNMP manager. The Trap Community string is only used by SNMP managers using SNMP version 2c or lower.
Previous	Click Previous to show the previous screen.
Next	Click Next to show the next screen.
Cancel	Click Cancel to exit this screen without saving.

After clicking **Next**, the **Networked AV** screen appears.

Figure 49 Wizard > Basic Settings > Step 3 Networked AV

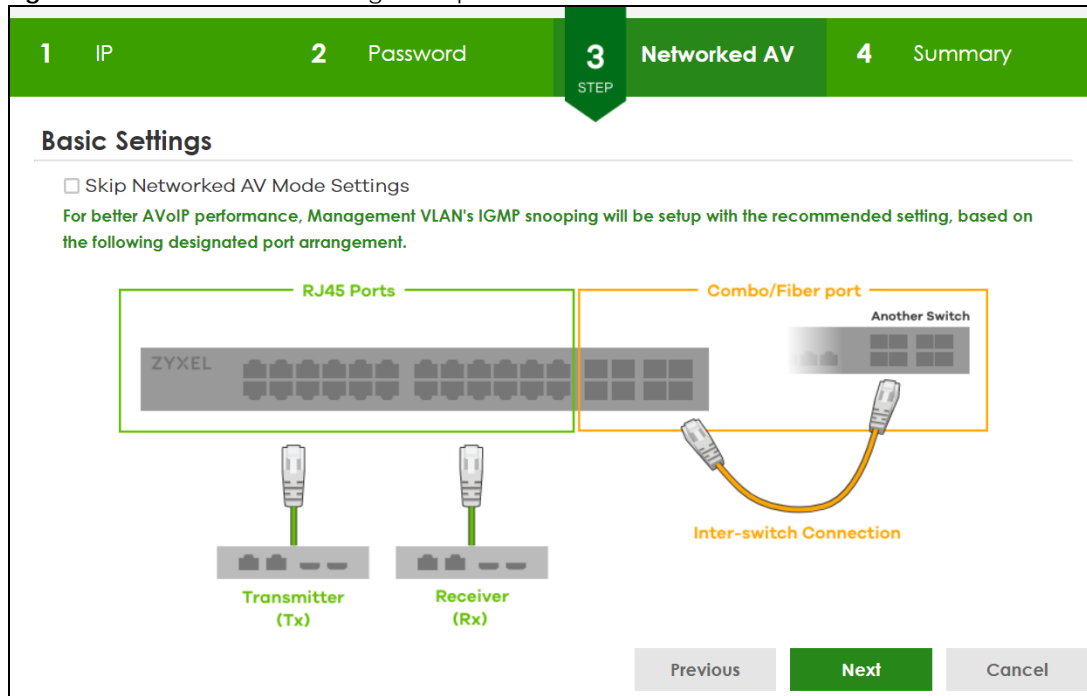

Each field is described in the following table.

Table 14 Wizard > Basic Settings > Step 3 Networked AV

LABEL	DESCRIPTION
Skip Networked AV Mode Settings	Click this option to avoid using the basic default AVoIP settings. The default AVoIP settings can be seen in Step 4 Summary under Networked AV – Basic Settings . Otherwise, clear the check box and follow the diagram for connecting RJ45 ports to audio and video equipment. The Inter-switch Connection is for connecting to another switch. Note: Use the Wizard > Advanced Settings > Step 3 Networked AV to configure connections for non-Audio-Video equipment (for example computer, NAS) to the RJ45 ports.
Previous	Click Previous to show the previous screen.
Next	Click Next to show the next screen.
Cancel	Click Cancel to exit this screen without saving.

After clicking **Next**, the **Summary** screen appears.

Figure 50 Wizard > Basic Settings > Step 4 Summary

1 IP		2 Password		3 Networked AV		4 Summary	
Summary							
Setup IP		Change administrator's password and activate SNMP			Networked AV - Basic Settings		
Host Name:	XGS2220	New password:		Networked AV VLAN:	1		
IP Interface:	DHCP Client	SNMP:	Disabled	Networked AV VLAN IP:	172.21.40.2		
VID:	1	Version:	v2c	IGMP Snooping:	Active		
IP Address:	172.21.40.2	Get Community:	public	IGMP Snooping Querier:	Active		
IP Subnet Mask:	255.255.252.0	Set Community:	public	Unknown Multicast Frame:	Drop		
Default Gateway:	172.21.43.254	Trap Community:	public	Transmitter/Receiver	1-50		
DNS Server:	172.21.10.1			Connected Port:	51-54		
				Inter-switch Connected Port:	51-54		
						<input type="button" value="Previous"/> <input type="button" value="Finish"/> <input type="button" value="Cancel"/>	

Each field is described in the following table.

Table 15 Wizard > Basic Settings > Step 4 Summary

LABEL	DESCRIPTION
Setup IP	
Host Name	This field displays a host name.
IP Interface	This field displays whether the WAN interface is using a DHCP IP address or a static IP address.
VID	This field displays the VLAN ID.
IP Address	This field displays the Switch's IP address for it to be managed over the network.
IP Subnet Mask	This field displays the subnet mask that specifies the network number portion of an IP address.
Default Gateway	This field displays the IP address of the default outgoing gateway in dotted decimal notation, for example 192.168.1.254.
DNS Server	This field displays the DNS (Domain Name System) for mapping a domain name to its corresponding IP address and so forth.
Change administrator's password and activate SNMP	
New Password	This field displays asterisks when a new password has been created.
SNMP	This field displays whether the Switch acts as an SNMP agent.
Version	This field displays the SNMP version for the Switch.
Get Community	This field displays the Get Community string.
Set Community	This field displays the Set Community string.
Trap Community	This field displays the Trap Community string.
Networked AV – Basic Settings	
Networked AV VLAN	This field displays the VLAN ID for the AVoIP network.

Table 15 Wizard > Basic Settings > Step 4 Summary (continued)

LABEL	DESCRIPTION
Networked AV VLAN IP	This field displays the Switch's IP address for it to be managed over the AVoIP network.
IGMP Snooping	This field displays Active when IGMP Snooping is enabled to forward group multicast traffic only to ports that are members of that group. Otherwise, it displays Inactive .
IGMP Snooping Querier	This field displays Active when the Switch is allowed to send IGMP General Query messages to the VLANs with the multicast hosts attached. Otherwise, it displays Inactive .
Unknown Multicast Frame	This field displays the action to perform when the Switch receives an unknown multicast frame. It displays Drop when the frames are discarded. It displays Flooding when the frames are sent to all ports.
Transmitter/Receiver Connected Port	This field shows the Switch's port numbers for connection to networked audio and video equipment.
Inter-switch Connected Port	This field shows the Switch's port numbers for connection to another switch.
Previous	Click Previous to show the previous screen.
Finish	Review the information and click Finish to create the task.
Cancel	Click Cancel to exit this screen without saving.

4.4.2 Advanced Settings

In **Advanced Settings**, you can set up IP or DNS, set up your password, SNMP community, configure Networked AV service to a VLAN, select and assign port role, link aggregation (trunking), and view finished results.

In order to set up your IP or DNS, please do the following. Click **Wizard > Advanced Settings > Step 1 IP** to access this screen.

Figure 51 Wizard > Advanced Settings > Step 1 IP

1 IP **2** Password **3** Networked AV **4** Summary

STEP

Setup IP

Host Name:

IP Interface: Static IP Interface DHCP Client

VID:

IP Address:

IP Subnet Mask:

Default Gateway:

DNS Server:

Next **Cancel**

Each field is described in the following table.

Table 16 Wizard > Advanced Settings > Step 1 IP

LABEL	DESCRIPTION
Host Name	This field displays a host name. You can enter a new host name here. Up to 64 printable ASCII characters are allowed except [?], [], ['], ["], or [,].
IP Interface	Select DHCP Client if the Switch is connected to a router with the DHCP server enabled. You then need to check the router for the IP address assigned to the Switch in order to access the Switch's Web Configurator again. Select Static IP Interface when the Switch is NOT connected to a router or you want to assign it a fixed IP address.
VID	This field displays the VLAN ID.
IP Address	The Switch needs an IP address for it to be managed over the network.
IP Subnet Mask	The subnet mask specifies the network number portion of an IP address.
Default Gateway	Type the IP address of the default outgoing gateway in dotted decimal notation, for example 192.168.1.254.
DNS Server	DNS (Domain Name System) is for mapping a domain name to its corresponding IP address and so forth. Enter a domain name server IP address in order to be able to use a domain name instead of an IP address.
Next	Click Next to show the next screen.
Cancel	Click Cancel to exit this screen without saving.

After clicking **Next**, the **Password** screen appears.

Figure 52 Wizard > Advanced Settings > Step 2 Password

1 IP **2** Password **3** Networked AV **4** Summary

STEP

Change administrator's password and SNMP

It is recommended to change password and SNMP community string to avoid potential security breach.

Administrator's Password

Current password:

New password:

Confirm password:

SNMP

SNMP: Enabled Disabled

Version:

Get Community:

Set Community:

Trap Community:

Note: The input string of any field in this screen should not contain [?], [|], ['], ["], or [,]. In the **Password** fields, [space] is also not allowed.

Each field is described in the following table.

Table 17 Wizard > Advanced Settings > Step 2 Password

LABEL	DESCRIPTION
Administrator's Password	
Current password	Type the existing system password (1234 is the default password when shipped).
New password	Enter your new system password. Up to 32 printable ASCII characters are allowed for the new password.
Confirm password	Re-enter your new system password for confirmation.
SNMP	
SNMP	Select Enabled to let the Switch act as an SNMP agent, which allows a manager station to manage and monitor the Switch through the network. Select Disabled to turn this feature off.
Version	Select the SNMP version for the Switch. The SNMP version on the Switch must match the version on the SNMP manager. Choose SNMP version 2c (v2c), SNMP version 3 (v3) or both (v3v2c). Note: SNMP version 2c is backwards compatible with SNMP version 1.
Get Community	Enter the Get Community string, which is the password for the incoming Get- and GetNextrequests from the management station. The Get Community string is only used by SNMP managers using SNMP version 2c or lower.
Set Community	Enter the Set Community string, which is the password for the incoming Set- requests from the management station. The Set Community string is only used by SNMP managers using SNMP version 2c or lower.

Table 17 Wizard > Advanced Settings > Step 2 Password (continued)

LABEL	DESCRIPTION
Trap Community	Enter the Trap Community string, which is the password sent with each trap to the SNMP manager. The Trap Community string is only used by SNMP managers using SNMP version 2c or lower.
Previous	Click Previous to show the previous screen.
Next	Click Next to show the next screen.
Cancel	Click Cancel to exit this screen without saving.

After clicking **Next**, the **Networked AV** screen appears.

Figure 53 Wizard > Advanced Settings > Step 3 Networked AV

Each field is described in the following table.

Table 18 Wizard > Advanced Settings > Step 3 Networked AV

LABEL	DESCRIPTION
Allocate networked AV service to a VLAN	
Networked AV VLAN	Enter a number between 1 and 4094 to create a VLAN for the AVoIP network (see Figure 4 on page 35 for details on an AVoIP network).
IP Address (Optional)	You must enter a different VLAN ID in the previous field (Networked AV VLAN) to be able to assign another IP address for the Switch to be managed over the AVoIP network.
IP Subnet Mask (Optional)	You must enter a different VLAN ID in the Networked AV VLAN field to be able to assign another subnet mask that specifies the network number portion of an IP address.
Select Ports and Assign a Port Role	

Table 18 Wizard > Advanced Settings > Step 3 Networked AV (continued)

LABEL	DESCRIPTION
Select all ports	After you create a VLAN, select the ports to be assigned to the Networked AV VLAN. Select all ports to assign the same role to all ports. You can select a port by clicking it. Then click any of the following: Click Tx/Rx to assign the ports for connecting to audio and video equipment. Click Inter-switch to assign the ports for connecting to other switches or gateway. Click Management to assign the ports for connecting to non-Audio-Video equipment (for example, computer and NAS) if your Networked AV VLAN is different from management VLAN.
Link aggregate	Select this option to aggregate multiple port bandwidth if you are connecting to another switch. Link aggregation (trunking) is the grouping of physical ports into one logical higher-capacity link.
Previous	Click Previous to show the previous screen.
Next	Click Next to show the next screen.
Cancel	Click Cancel to exit this screen without saving.

After clicking **Next**, the **Summary** screen appears.

Figure 54 Wizard > Advanced Settings > Step 4 Summary

1 IP **2** Password **3** Networked AV **4** **Summary**
STEP

Summary

Setup IP	Change administrator's password and activate SNMP	Networked AV - Advanced Settings
Host Name: XGS2220	New password:	Networked AV VLAN: 1
IP Interface: DHCP Client	SNMP: Disabled	Networked AV VLAN IP: 172.21.40.2
VID: 1	Version: v2c	IGMP Snooping: Active
IP Address: 172.21.40.2	Get Community: public	IGMP Snooping Querier: Active
IP Subnet Mask: 255.255.252.0	Set Community: public	Unknown Multicast Frame: Drop
Default Gateway: 172.21.43.254	Trap Community: public	Transmitter/Receiver
DNS Server: 172.21.10.1		Connected Port:
		Inter-switch Connected Port:

Previous **Finish** Cancel

Each field is described in the following table.

Table 19 Wizard > Advanced Settings > Step 4 Summary

LABEL	DESCRIPTION
Setup IP	
Host Name	This field displays a host name.

Table 19 Wizard > Advanced Settings > Step 4 Summary (continued)

LABEL	DESCRIPTION
IP Interface	This field displays whether the WAN interface is using a DHCP IP address or a static IP address.
VID	This field displays the VLAN ID.
IP Address	This field displays the Switches' IP address for it to be managed over the network.
IP Subnet Mask	This field displays the subnet mask that specifies the network number portion of an IP address.
Default Gateway	This field displays the IP address of the default outgoing gateway in dotted decimal notation, for example 192.168.1.254.
DNS Server	This field displays the DNS (Domain Name System) for mapping a domain name to its corresponding IP address and so forth.
Change administrator's password and activate SNMP	
New Password	This field displays asterisks when a new password has been created.
SNMP	This field displays whether the Switch acts as an SNMP agent.
Version	This field displays the SNMP version for the Switch.
Get Community	This field displays the Get Community string.
Set Community	This field displays the Set Community string.
Trap Community	This field displays the Trap Community string.
Networked AV – Advanced Settings	
Networked AV VLAN	This field displays the VLAN ID for the AVoIP network.
Networked AV VLAN IP	This field displays the corresponding VLAN ID's IP address for the AVoIP network.
IGMP Snooping	This field displays Active when IGMP Snooping is enabled to forward group multicast traffic only to ports that are members of that group. Otherwise, it displays Inactive .
IGMP Snooping Querier	This field displays Active when the Switch is allowed to send IGMP General Query messages to the VLANs with the multicast hosts attached. Otherwise, it displays Inactive .
Unknown Multicast Frame	This field displays the action to perform when the Switch receives an unknown multicast frame. It displays Drop when the frames are discarded. It displays Flooding when the frames are sent to all ports.
Transmitter/ Receiver Connected Port	This field shows the Switches' port numbers for connection to networked audio and video equipment.
Inter-switch Connected Port (Link Aggregation)	This field shows the Switches' port numbers for connection to another switch.
Previous	Click Previous to show the previous screen.
Finish	Review the information and click Finish to create the task.
Cancel	Click Cancel to exit this screen without saving.

4.5 Wizard

The **Setup Wizard** contains the following parts:

- **Basic** – to configure the Switch IP address, DNS server, system password, SNMP community and link aggregation (trunking).
- **Protection** – to enable loop guard and broadcast storm control on the Switch and its ports.
- **VLAN** – to create a static VLAN, assign ports to the VLAN and set the ports to tag or untag outgoing frames.
- **QoS** – to determine a port's IEEE 802.1p priority level for QoS.

Figure 55 Setup Wizard

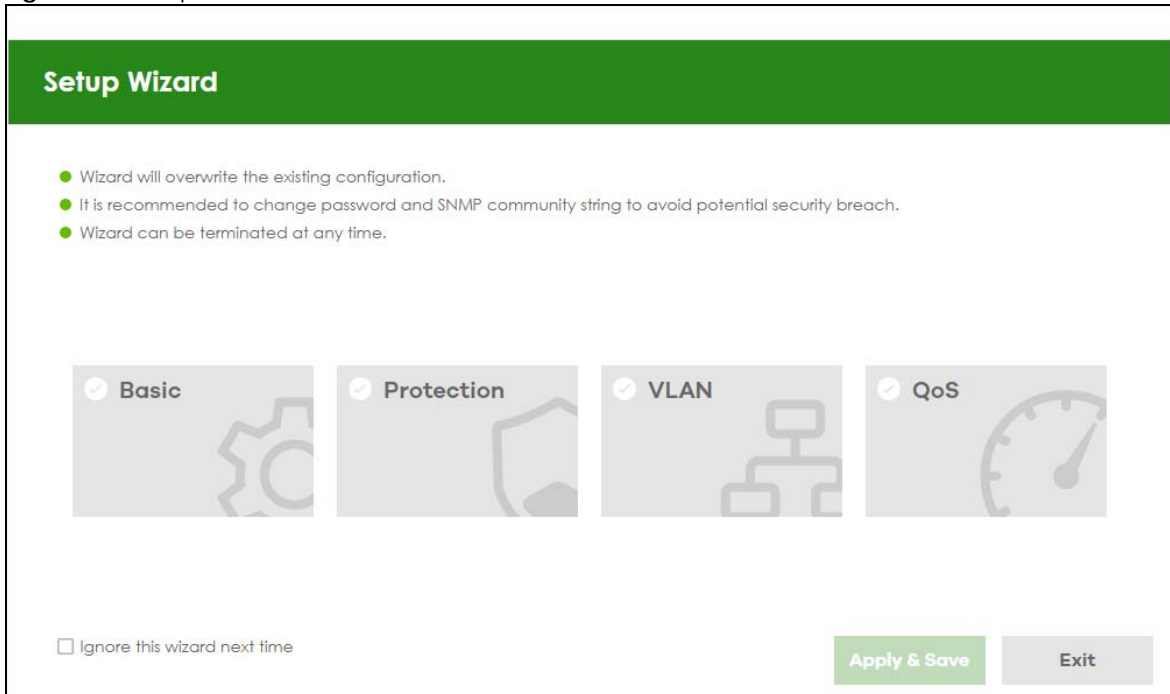

4.5.1 Basic

In **Basic**, you can set up IP/DNS, set up your password, SNMP community, link aggregation, and view finished results.

In order to set up your IP/DNS, please do the following. Click **Wizard > Basic > Step 1 IP** to access this screen.

Figure 56 Wizard > Basic > Step 1 IP

The screenshot shows the 'Setup IP' configuration screen. At the top, a green progress bar indicates the current step is '1 IP', with other steps being '2 Password', '3 Link Aggregation', and '4 Summary'. Below the progress bar, the 'Setup IP' section contains the following fields:

- Host Name: XGS2220
- IP Interface: Static IP Address DHCP Client
- VID: 1
- IP Address: 172.21.40.2
- IP Subnet Mask: 255.255.252.0
- Default Gateway: 172.21.43.254
- DNS Server: 172.21.10.1

At the bottom right, there are two buttons: 'Next' (highlighted in green) and 'Cancel'.

Each field is described in the following table.

Table 20 Wizard > Basic > Step 1 IP

LABEL	DESCRIPTION
Host Name	This field displays a host name. Enter a string to set a new host name. The host name should not contain [?], [], ['], ["], or [,].
IP Interface	Select DHCP Client if the Switch is connected to a router with the DHCP server enabled. You then need to check the router for the IP address assigned to the Switch in order to access the Switch's Web Configurator again. Select Static IP Address when the Switch is NOT connected to a router or you want to assign it a fixed IP address.
VID	This field displays the VLAN ID.
IP Address	The Switch needs an IP address for it to be managed over the network.
IP Subnet Mask	The subnet mask specifies the network number portion of an IP address.
Default Gateway	Type the IP address of the default outgoing gateway in dotted decimal notation, for example 192.168.1.254.
DNS Server	DNS (Domain Name System) is for mapping a domain name to its corresponding IP address and so forth. Enter a domain name server IP address in order to be able to use a domain name instead of an IP address.
Next	Click Next to show the next screen.
Cancel	Click Cancel to exit this screen without saving.

After clicking **Next**, the **Password** screen appears.

Figure 57 Wizard > Basic > Step 2 Password

1 IP **2** **STEP** Password **3** Link Aggregation **4** Summary

Change administrator's password and SNMP

It is recommended to change password and SNMP community string to avoid potential security breach.

Administrator's Password

Current password:

New password:

Confirm password:

SNMP

SNMP: Enabled Disabled

Version:

Get Community:

Set Community:

Trap Community:

Previous **Next** Cancel

Note: The input string of any field in this screen should not contain [?], [|], ['], ["], or [,]. In the **Password** fields, [space] is also not allowed.

Each field is described in the following table.

Table 21 Wizard > Basic > Step 2 Password

LABEL	DESCRIPTION
Administrator's Password	
Current password	Type the existing system password (1234 is the default password when shipped).
New password	Enter your new system password. Up to 32 printable ASCII characters are allowed for the new password.
Confirm password	Retype your new system password for confirmation.
SNMP	
SNMP	Select Enabled to let the Switch act as an SNMP agent, which allows a manager station to manage and monitor the Switch through the network. Select Disabled to turn this feature off.
Version	Select the SNMP version for the Switch. The SNMP version on the Switch must match the version on the SNMP manager. Choose SNMP version 2c (v2c), SNMP version 3 (v3) or both (v3v2c). Note: SNMP version 2c is backwards compatible with SNMP version 1.
Get Community	Enter the Get Community string, which is the password for the incoming Get- and GetNextrequests from the management station. The Get Community string is only used by SNMP managers using SNMP version 2c or lower.
Set Community	Enter the Set Community string, which is the password for the incoming Set- requests from the management station. The Set Community string is only used by SNMP managers using SNMP version 2c or lower.

Table 21 Wizard > Basic > Step 2 Password (continued)

LABEL	DESCRIPTION
Trap Community	Enter the Trap Community string, which is the password sent with each trap to the SNMP manager. The Trap Community string is only used by SNMP managers using SNMP version 2c or lower.
Previous	Click Previous to show the previous screen.
Next	Click Next to show the next screen.
Cancel	Click Cancel to exit this screen without saving.

After clicking **Next**, the **Link Aggregation** screen appears.

Figure 58 Wizard > Basic > Step 3 Link Aggregation

Each field is described in the following table.

Table 22 Wizard > Basic > Step 3 Link Aggregation

LABEL	DESCRIPTION
Link Aggregation	
T1-Tx	Click the arrows to add or delete icons located on the left to desired preference. Select Static if the ports are configured as static members of a trunk group. Select LACP if the ports are configured to join a trunk group through LACP.
Previous	Click Previous to show the previous screen.
Next	Click Next to show the next screen.
Cancel	Click Cancel to exit this screen without saving.

After clicking **Next**, the **Summary** screen appears.

Figure 59 Wizard > Basic > Step 4 Summary

Each field is described in the following table.

Table 23 Wizard > Basic > Step 4 Summary

LABEL	DESCRIPTION
Setup IP	
Host Name	This field displays a host name.
IP Interface	This field displays whether the WAN interface is using a DHCP IP address or a static IP address.
VID	This field displays the VLAN ID.
IP Address	The Switch needs an IP address for it to be managed over the network.
IP Subnet Mask	The subnet mask specifies the network number portion of an IP address.
Default Gateway	Type the IP address of the default outgoing gateway in dotted decimal notation, for example 192.168.1.254.
DNS Server	DNS (Domain Name System) is for mapping a domain name to its corresponding IP address and vice versa. Enter a domain name server IP address in order to be able to use a domain name instead of an IP address.
Change administrator's password and activate SNMP	
New Password	This field displays asterisks when a new password has been created.
SNMP	This field displays whether the Switch acts as an SNMP agent.
Version	This field displays the SNMP version for the Switch.
Get Community	This field displays the Get Community string.
Set Community	This field displays the Set Community string.
Trap Community	This field displays the Trap Community string.
Link Aggregation	
Group	This field displays the group number.
Type	This field displays Static or LACP of this group.
Member	This field displays the members of this group.

Table 23 Wizard > Basic > Step 4 Summary (continued)

LABEL	DESCRIPTION
Previous	Click Previous to show the previous screen.
Finish	Review the information and click Finish to create the task.
Cancel	Click Cancel to exit this screen without saving.

4.5.2 Protection

In **Protection**, you can set up loop guard and broadcast storm control.

In order to set up loop guard, please do the following. Click **Wizard > Protection > Step 1 Loop Guard** to access this screen.

Figure 60 Wizard > Protection > Step 1 Loop Guard

Each field is described in the following table.

Table 24 Wizard > Protection > Step 1 Loop Guard

LABEL	DESCRIPTION
Loop Guard	
Select all ports	Select all ports to enable the loop guard feature on all ports. You can select a port by clicking it.
Next	Click Next to show the next screen.
Cancel	Click Cancel to exit this screen without saving.

After clicking **Next**, the **Broadcast Storm Control** screen appears.

Figure 61 Wizard > Protection > Step 2 Broadcast Storm Control

Each field is described in the following table.

Table 25 Wizard > Protection > Step 2 Broadcast Storm Control

LABEL	DESCRIPTION
Broadcast Storm Control	
Select all ports	Select all ports to apply settings on all ports. You can select a port by clicking it.
Broadcast pkt/s	Specify how many broadcast packets the port receives per second.
Previous	Click Previous to show the previous screen.
Next	Click Next to show the next screen.
Cancel	Click Cancel to exit this screen without saving.

After clicking **Next**, the **Summary** screen appears.

Figure 62 Wizard > Protection > Step 3 Summary

Each field is described in the following table.

Table 26 Wizard > Protection > Step 3 Summary

LABEL	DESCRIPTION
Summary	
Loop Guard	If the loop guard feature is enabled on a port, the Switch will prevent loops on this port.
Broadcast Storm Control	If the broadcast storm control feature is enabled on a port, the number of broadcast packets the Switch receives per second will be limited on this port.
Previous	Click Previous to show the previous screen.
Finish	Review the information and click Finish to create the task.
Cancel	Click Cancel to exit this screen without saving.

4.5.3 VLAN

In **VLAN**, you can create VLAN, and tag VLAN settings.

Click **Wizard > VLAN > VLAN Setting** to access this screen.

Figure 63 Wizard > VLAN > VLAN Setting

Each field is described in the following table.

Table 27 Wizard > VLAN > VLAN Setting

LABEL	DESCRIPTION
VLAN Setting	
Default VLAN 1 / Access Untagged port	After you create a VLAN and select the VLAN ID from the drop-down list box, select ports and use the right arrow to add them as the untagged ports to a VLAN group.
VLAN member port	
VLAN	Type a number between 2 and 4094 to create a VLAN.
Trunk Tagged port	Select ports and use the downward arrow to add them as the tagged ports to the VLAN groups you created.
Finish	Review the information and click Finish to create the task.
Cancel	Click Cancel to exit this screen without saving.

4.5.4 QoS

In **QoS**, you can create QoS settings.

In order to create QoS settings, please do the following. Click **Wizard > QoS > QoS Setting** to access this screen.

Figure 64 Wizard > QoS > QoS Setting

Each field is described in the following table.

Table 28 Wizard > QoS > QoS Setting

LABEL	DESCRIPTION
QoS Setting	
Select all ports	Select all ports to apply settings on all ports. You can select a port by clicking it.
High	Select ports and click the High button, so they will have high priority. The port's IEEE 802.1p priority level will be set to 5. Use the PORT > Port Setup screen to adjust the value.
Medium	Select ports and click the Medium button and, so they will have medium priority. The port's IEEE 802.1p priority level will be set to 3. Use the PORT > Port Setup screen to adjust the value.
Low	Select ports and click the Low button, so they will have low priority. The port's IEEE 802.1p priority level will be set to 1. Use the PORT > Port Setup screen to adjust the value.
Finish	Review the information and click Finish to create the task.
Cancel	Click Cancel to exit this screen without saving.

4.6 Web Configurator Layout

The **DASHBOARD** screen is the first screen that displays when you access the Web Configurator.

This guide uses the XGS2220-54FP screens as examples. The screens may vary slightly for different models. The following figure shows the navigating components of a Web Configurator screen.

Figure 65 Web Configurator Layout

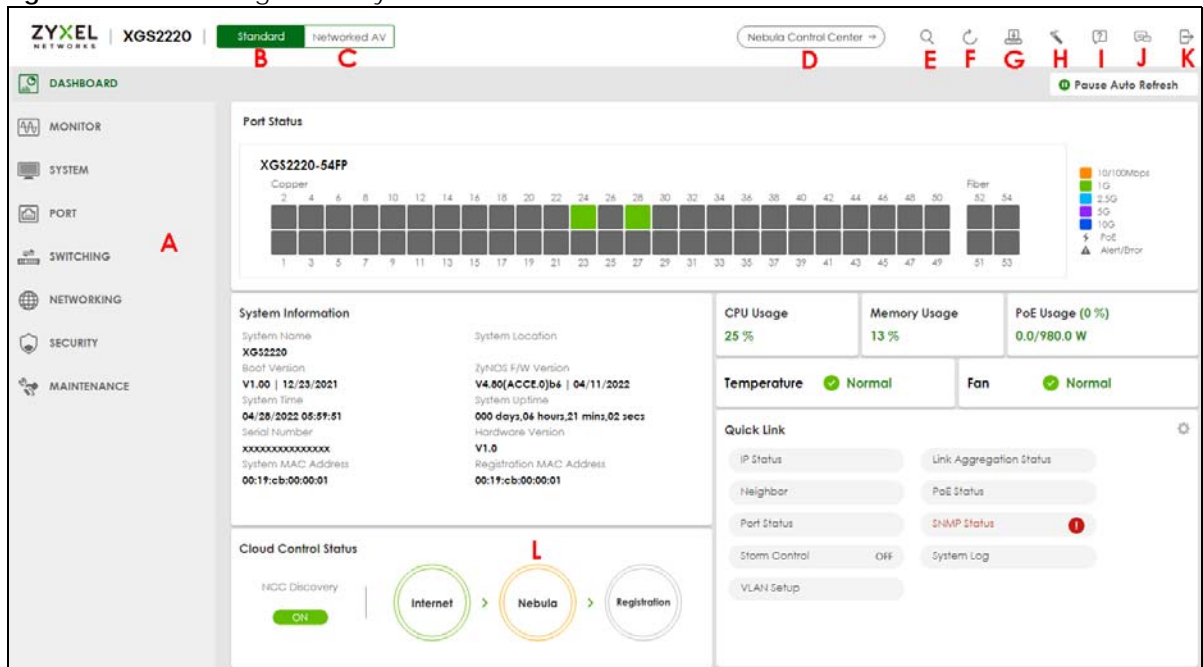

A – Click the menu items to open sub-menu links, and then click on a sub-menu link to open the screen in the main window.

B, C, D, E, F, G, H, I, J, K – These are quick links which allow you to perform certain tasks no matter which screen you are currently working in.

B, C – Click this icon to switch between the Web Configurator’s **Standard** or **Networked AV** mode.

D – Click this icon to go to the NCC (Nebula Control Center) portal website.

E – Click this icon to search for specific configurations or status you are looking for. Enter the keywords and click the result link. This will direct you to the specific configuration or status page.

F – Click this icon to update the information in the screen you are currently viewing.

G – Click this icon to save your configuration into the Switch’s non-volatile memory. Non-volatile memory is the configuration of your Switch that stays the same even if the Switch’s power is turned off.

H – Click this icon to display the **Setup Wizard** that contains the **Basic**, **Protection**, **VLAN**, and **QoS** setup screens.

I – Click this icon to display web help pages. The help pages provide descriptions for all of the configuration screens.

J – Click this icon to go to the ZyXel Community Biz Forum.

K – Click this icon to log out of the Web Configurator.

L – This displays the Nebula Cloud Control Status. The ON/OFF switch displays if **NCC Discovery** is enabled. If a status circle turns Orange, it means the Switch is unable to connect to NCC. Hover the mouse over the status circle to check the diagnostic message. You can also click the ON/OFF switch to go to the **SYSTEM > Cloud Management** screen and check the diagnostic messages. See [Section Table 50 on page 159](#) for more information.

In the navigation panel, click a main link to reveal a list of sub-menu links.

The following table describes the links in the navigation panel. The navigation panel varies depending on the product model you use.

Table 29 Navigation Panel Links (Standard Mode)

LINK	DESCRIPTION
DASHBOARD	This link takes you to the main dashboard screen that displays general system and device information.
MONITOR	
ARP Table	This link takes you to a screen that displays the current ARP table of the Switch. You can view the IP and MAC address mapping, VLAN ID, ARP aging time, and ARP entry type of a device attached to a port.
IP Table	This link takes you to a screen where you can view the IP address and VLAN ID of a device attached to a port.
IPv6 Neighbor Table	This link takes you to a screen where you can view the Switch's IPv6 neighbor table.
MAC Table	This link takes you to a screen where you can view the MAC address and VLAN ID of a device attach to a port. You can also view what kind of MAC address it is.
Neighbor	This link takes you to a screen where you can view neighbor devices (including non-Zyxel devices) connected to the Switch.
Path MTU Table	This link takes you to a screen where you can view the IPv6 path MTU information on the Switch.
Port Status	This link takes you to a screen where you can view the port statistics.
Routing Table	Click the link to unfold the following sub-link menu.
IPv4 Routing Table	This link takes you to a screen where you can view the IPv4 routing table for routing information including IP interface and hop count to certain network destinations.
IPv6 Routing Table	This link takes you to a screen where you can view the IPv6 routing table for routing information including IP interface and hop count to certain network destinations.
System Information	This link takes you to a screen that displays general system information.
System Log	This link takes you to a screen where you can view the system log including fail log and system status.
SYSTEM	
Cloud Management	This link takes you to a screen where you can enable or disable the Nebula Control Center (NCC) Discovery feature and view the NCC connection status. If Nebula Control Center (NCC) Discovery is enabled, you can have the Switch search for the NCC (Nebula Control Center). The screen also displays a QR code containing the Switch's serial number and MAC address for handy registration of the Switch at NCC.
General Setup	This link takes you to a screen where you can configure general identification information about the Switch.
Hardware Monitor Setup	This link takes you to a screen where you can configure hardware monitor related features such as SFP Detect .
Interface Setup	This link takes you to a screen where you can configure settings for individual interface type and ID.

Table 29 Navigation Panel Links (Standard Mode) (continued)

LINK	DESCRIPTION
IP Setup	This link takes you to a screen where you can configure the DHCP client, and a static IP address (IP address and subnet mask).
IPv6	Click the link to unfold the following sub-link menu.
IPv6 Status	This link takes you to a screen where you can view the IPv6 table and DNS server.
IPv6 Global Setup	This link takes you to a screen where you can configure the global IPv6 settings.
IPv6 Interface Setup	This link takes you to a screen where you can view and configure IPv6 interfaces.
IPv6 Addressing	This link takes you to a screen where you can view and configure IPv6 link-local and global addresses.
IPv6 Neighbor Discovery	This link takes you to a screen where you can view and configure neighbor discovery settings on each interface.
IPv6 Neighbor Setup	configure static IPv6 neighbor entries in the Switch's IPv6 neighbor table.
DHCPv6 Client Setup	This link takes you to a screen where you can configure the Switch's DHCP settings when it is acting as a DHCPv6 client.
Logins	This link takes you to a screen where you can change the system login password, as well as configure up to four login details.
SNMP	This link takes you to screens where you can specify the SNMP version and community (password) values, configure where to send SNMP traps from the Switch, enable loopguard/errdisable/poe/linkup/linkdown/lldp/transceiver-ddm/storm-control on the Switch, specify the types of SNMP traps that should be sent to each SNMP manager, and add/edit user information.
Stacking	This link takes you to screens where you can view the stacking status in the stacking system, enable stacking on the Switch, and configure stacking details.
Switch Setup	This link takes you to a screen where you can set up global Switch parameters such as VLAN type.
Syslog Setup	This link takes you to a screen where you can configure the Switch's system logging settings and configure a list of external syslog servers.
Time Range	This link takes you to a screen where you can configure time range for time-oriented features like Classifier.
PORT	
Auto PD Recovery	This link takes you to a screen where you can enable and configure Auto PD Recovery on the Switch.
Flex Link	This screen takes you to a screen where you can view configure backup links in the Data Link layer.
Green Ethernet	This link takes you to a screen where you can configure the Switch to reduce port power consumption.
Link Aggregation	This link takes you to a screen where you can logically aggregate physical links to form one logical, higher-bandwidth link.
LLDP	Click the link to unfold the following sub-link menu.
LLDP	This link takes you to screens where you can view LLDP information and configure LLDP and TLV settings.
LLDP MED	This link takes you to screens where you can configure LLDP-MED parameters.
OAM	This link takes you to screens where you can enable Ethernet OAM on the Switch, view the configuration of ports on which Ethernet OAM is enabled and perform remote-loopback tests.

Table 29 Navigation Panel Links (Standard Mode) (continued)

LINK	DESCRIPTION
PoE Setup	For PoE models. This link takes you to a screen where you can set priorities, PoE power-up settings and schedule so that the Switch is able to reserve and allocate power to certain PDs.
Port Setup	This link takes you to a screen where you can configure settings for individual Switch ports.
ZULD	This link takes you to screens where you can enable ZULD on a port and configure related settings.
SWITCHING	
Layer 2 Protocol Tunneling	This link takes you to a screen where you can configure L2PT (Layer 2 Protocol Tunneling) settings on the Switch.
Loop Guard	This link takes you to a screen where you can configure protection against network loops that occur on the edge of your network.
MAC Pinning	This link takes you to a screen where you can set specific ports to have priority over other ports in MAC address learning.
Mirroring	Click the link to unfold the following sub-link menu.
Mirroring	This link take you to a screen where you can copy traffic from one port or ports to another port in order to examine the traffic from the first port without interference.
Multicast	Click the link to unfold the following sub-link menu.
IPv4 Multicast	This link takes you to screen where you can configure various IPv4 multicast features, IGMP snooping, filtering and create multicast VLANs.
IPv6 Multicast	This link takes you to screen where you can configure various IPv6 multicast features, MLD snooping-proxy, filtering and create multicast VLANs.
MVR	This link takes you to screens where you can create multicast VLANs and select the receiver ports and a source port for each multicast VLAN.
Static Multicast Forwarding By MAC	This link takes you to a screen where you can configure static multicast MAC addresses for port(s). These static multicast MAC addresses do not age out.
Static Multicast Forwarding By IP	This link takes you to a screen where you can configure static multicast IP addresses for port(s). These static multicast IP addresses do not age out.
PPPoE Intermediate Agent	This link takes you to screens where you can enable PPPoE (Point-to-Point Protocol over Ethernet) Intermediate Agent and configure per-port, per-port-per-VLAN settings.
QoS	Click the link to unfold the following sub-link menu.
Diffserv	This link takes you to screens where you can enable DiffServ, configure marking rules and set DSCP-to-IEEE802.1p mappings.
Queuing Method	This link takes you to a screen where you can set priorities for the queues of the Switch. This distributes bandwidth across the different traffic queues.
Priority Queue	This link takes you to a screen where you can set priority tags for different traffic types and specify the priority levels.
Bandwidth Control	This link takes you to a screen where you can cap the maximum bandwidth allowed on a port.
sFlow	This link takes you to screens where you can configure sFlow settings on the Switch.
Spanning Tree Protocol	Click the link to unfold the following sub-link menu.
Spanning Tree Protocol Status	This link takes you to a screen where you can view the STP status in the different STP modes (RSTP, MRSTP or MSTP) you can configure on the Switch.

Table 29 Navigation Panel Links (Standard Mode) (continued)

LINK	DESCRIPTION
Spanning Tree Setup	This link takes you to a screen where you can activate one of the STP modes (RSTP, MRSTP or MSTP) on the Switch.
RSTP	This link takes you to a screen where you can configure the RSTP (Rapid Spanning Tree Protocol) settings on the Switch.
MRSTP	This link takes you to a screen where you can configure the MRSTP (Multiple Rapid Spanning Tree Protocol) settings on the Switch.
MSTP	This link takes you to a screen where you can configure the MSTP (Multiple Spanning Tree Protocol) settings on the Switch.
Static MAC Filtering	This link takes you to a screen to set up static MAC filtering rules.
Static MAC Forwarding	This link takes you to a screen where you can configure static MAC addresses for a port. These static MAC addresses do not age out.
VLAN	Click the link to unfold the following sub-link menu.
VLAN Status	This link takes you to a screen where you can view and search all VLAN groups.
VLAN Setup	This link takes you to screens where you can: <ul style="list-style-type: none"> • configure port-based or 802.1Q VLAN. • view detailed port settings and status of the VLAN group. • configure and view 802.1Q VLAN parameters for the Switch. • configure the static VLAN settings on a port.
Subnet Based VLAN Setup	This link takes you to a screen where you can set up VLANs that allow you to group traffic into logical VLANs based on the source IP subnet you specify.
Protocol Based VLAN Setup	This link takes you to a screen where you can set up VLANs that allow you to group traffic into logical VLANs based on the protocol you specify.
Voice VLAN Setup	This link takes you to a screen where you can set up VLANs that allow you to group voice traffic with defined priority and enable the Switch port to carry the voice traffic separately from data traffic to ensure the sound quality does NOT deteriorate.
MAC Based VLAN Setup	This link takes you to a screen where you can set up VLANs that allow you to group untagged packets into logical VLANs based on the source MAC address of the packet. This eliminates the need to reconfigure the Switch when you change ports. The Switch will forward the packets based on the source MAC address you set up previously.
Vendor ID Based VLAN Setup	This link takes you to screens where you can set up VLANs that allow you to group untagged packets into logical VLANs based on the source MAC address of the packet. You can specify a mask for the MAC address to create a MAC address filter and enter a weight to set the VLAN rule's priority.
VLAN Isolation	This link takes you to a screen where you can block traffic between ports in a VLAN on the Switch.
VLAN Mapping	This link takes you to screens where you can configure VLAN mapping settings on the Switch.
VLAN Stacking	This link takes you to screens where you can activate and configure VLAN stacking.
NETWORKING	
ARP Setup	Click the link to unfold the following sub-link menu.
ARP Learning	This link takes you to a screen where you can configure ARP learning mode on a per-port basis.
Static ARP	This link takes you to a screen where you can create static ARP entries which do not age out.
DHCP	Click the link to unfold the following sub-link menu.
DHCPv4 Relay	This link takes you to screens where you can view DHCPv4 relay status, mode, and configure DHCPv4 relay settings.
DHCPv6 Relay	This link takes you to a screen where you can enable and configure DHCPv6 relay.

Table 29 Navigation Panel Links (Standard Mode) (continued)

LINK	DESCRIPTION
DHCP Server Guard	This link takes you to a screen where you can specify whether ports are trusted or untrusted ports for DHCP packets.
Static Routing	Click the link to unfold the following sub-link menu.
IPv4 Static Route	This link takes you to a screen where you can configure IPv4 static routes. A static route defines how the Switch should forward traffic by destination IP address and subnet mask.
IPv6 Static Route	This link takes you to a screen where you can configure IPv6 static routes. A static route defines how the Switch should forward traffic by destination IP address and prefix length.
SECURITY	
AAA	Click the link to unfold the following sub-link menu.
RADIUS Server Setup	This link takes you to a screen where you can configure your RADIUS (Remote Authentication Dial-In User Service) server settings for authentication.
TACACS+ Server Setup	This link takes you to a screen where you can configure your TACACS+ (Terminal Access Controller Access Control System Plus) server settings for authentication.
AAA Setup	This link takes you to a screen where you can configure authentication, authorization and accounting services through external servers. The external servers can be either RADIUS or TACACS+ (Terminal Access Controller Access Control System Plus).
Access Control	Click the link to unfold the following sub-link menu.
Service Access Control	This link takes you to a screen where you can decide what services you may use to access the Switch.
Remote Management	This link takes you to a screen where you can specify a group of one or more "trusted computers" from which an administrator may use a service to manage the Switch.
Account Security	This link takes you to a screen where you can configure account security settings on the Switch.
ACL	Click the link to unfold the following sub-link menu.
Classifier	This link takes you to screens where you can configure the Switch to group packets based on the specified criteria.
Policy Rule	This link takes you to a screen where you can configure the Switch to perform special treatment on the grouped packets.
Anti-Arpscan	This link takes you to screens where you can enable anti-arpscan on the Switch and ports, and view the port state. You can also create trusted hosts, view blocked hosts and unblock them.
BPDUGuard	This link takes you to screens where you can enable BPDU guard on the Switch and ports, and view the port state.
Storm Control	This link takes you to a screen to set up broadcast filters.
Errdisable	This link takes you to screens where you can view errdisable status and configure errdisable settings in CPU protection, errdisable detect, and errdisable recovery.
IPv4 Source Guard	Click the link to unfold the following sub-link menu.
IP Source Guard	This link takes you to screens where you can configure filtering of unauthorized DHCP and ARP packets in your network.
ARP Inspection	This link takes you to screens where you can view ARP inspection status, and configure ARP inspection settings on ports or VLANs. You can use ARP inspection to filter unauthorized ARP packets on the network.
IPv6 Source Guard	Click the link to unfold the following sub-link menu.
IPv6 Static Binding	The link takes you to screens where you can view IPv6 static binding status and manually create IPv6 source guard static binding entries.

Table 29 Navigation Panel Links (Standard Mode) (continued)

LINK	DESCRIPTION
IPv6 Source Guard	The link takes you to screens where you can define policies to have IPv6 source guard forward valid addresses and/or prefixes and allow or block data traffic from all link-local addresses, and apply the configured IPv6 source guard policy to a port.
IPv6 Snooping	The link takes you to screens where you can set up DHCPv6 snooping policies for the binding table and enable the policies on VLAN interfaces.
DHCPv6 Trust Setup	The link takes you to a screen where you can specify which ports are trusted for DHCPv6 snooping.
Port Authentication	Click the link to unfold the following sub-link menu. These links take you to screens where you can configure IEEE 802.1x port authentication as well as MAC authentication for clients communicating through the Switch.
Compound Authentication Mode	The link takes you to a screen where you can allow network access for clients that pass either IEEE 802.1x authentication or MAC authentication, or pass both IEEE 802.1x authentication and MAC authentication.
Port Security	This link takes you to a screen where you can activate MAC address learning and set the maximum number of MAC addresses to learn on a port.
MAINTENANCE	
Certificates	The link takes you to a screen where you can import the Switch's CA-signed certificates.
Cluster Management	This link takes you to a screen where you can configure clustering management and view its status.
Configuration	Click the link to unfold the following sub-link menu.
Auto Configuration	This link takes you to a screen where you can overwrite the running configuration stored in the Switch's RAM.
Configure Clone	This link takes you to a screen where you can copy the basic and advanced settings from a source port to a destination port or ports.
Diagnostic	This link takes you to a screen where you can ping IP addresses, run traceroute, test ports and show the location of the Switch.
Firmware Upgrade	This link takes you to a screen to upload firmware to your Switch.
Reboot System	This link takes you to a screen to reboot the Switch without turning the power off.
Tech-Support	This link takes you to a screen where you can download related log reports for issue analysis. Log reports include CPU history and utilization, crash and memory.

The following table describes the links in the navigation panel when the Switch is in Networked AV mode.

Table 30 Navigation Panel Links (Networked AV Mode)

LINK	DESCRIPTION
SUMMARY	This screen displays the Switch's front panel port status, connected ports, used power, Nebula Cloud Control status, and Networked AV status.
MONITOR	
System Information	This link takes you to a screen that displays general system information.
SYSTEM	
General Setup	This link takes you to a screen where you can configure general identification information about the Switch.
IP Setup	This screen allows you to configure the IP address and subnet mask (necessary for Switch management) and set up to 64 IP routing domains.

Table 30 Navigation Panel Links (Networked AV Mode) (continued)

LINK	DESCRIPTION
Logins	This link takes you to a screen where you can change the system login password, as well as configure up to four login details.
SNMP	This link takes you to screens where you can specify the SNMP version and community (password) values, configure where to send SNMP traps from the Switch, enable loopguard/errdisable/poe/linkup/linkdown/lldp/transceiver-ddm/storm-control on the Switch, specify the types of SNMP traps that should be sent to each SNMP manager, and add/edit user information.
PORT	
Link Aggregation	This link takes you to screens where you can logically aggregate physical links to form one logical, higher-bandwidth link.
PoE Setup	For PoE models. This link takes you to a screen where you can set priorities, PoE power-up settings and schedule so that the Switch is able to reserve and allocate power to certain PDs.
Port Setup	This screen allows you to configure settings for individual Switch ports.
SWITCHING	
Mirroring	This link takes you to screens where you can copy traffic from one port or ports to another port in order that you can examine the traffic from the first port without interference.
Multicast	This link takes you to screens where you can view multicast group information, configure various multicast features like IGMP snooping and filtering profile, and create multicast VLANs.
VLAN	This link takes you to screens where you can view and search all static VLAN groups, view detailed port settings and status of the static VLAN group, configure a static VLAN for the Switch, and configure the static VLAN (IEEE 802.1Q) settings on a port.
SECURITY	
Access Control	
Service Access Control	This link takes you to a screen where you can decide what services you may use to access the Switch.
Remote Management	This link takes you to a screen where you can specify a group of one or more “trusted computers” from which an administrator may use a service to manage the Switch.
Storm Control	This link takes you to a screen to set up broadcast filters.
MAINTENANCE	
Configuration	
Restore Configuration	This link takes you to a screen where you can upload a stored device configuration file.
Backup Configuration	This link takes you to a screen where you can save your Switch’s configurations (settings) for later use.
Save Configuration	This link takes you to a screen where you can save the current configuration (settings) to a specific configuration file on the Switch.
Firmware Upgrade	This link takes you to a screen to upload firmware to your Switch.
Reboot System	This link takes you to a screen to reboot the Switch without turning the power off.
Tech-Support	This link takes you to a screen where you can download related log reports for issue analysis. Log reports include CPU history and utilization, crash and memory.

4.6.1 Tables and Lists

The Web Configurator tables and lists provide several options for how to work with their entries.

4.6.1.1 Working with Table Entries

Tables have tool icons for working with table entries as shown next. You can select one or more entries, or select the check box in the heading row to select all entries. Use the tool icons to modify the selected entries.

Figure 66 Working with a Table

<input type="checkbox"/>	Index	IP Address	IP Subnet Mask	VID	Type
<input type="checkbox"/>	1	192.168.3.115	255.255.255.0	1	Static
<input type="checkbox"/>	2	172.21.40.3	255.255.252.0	1	DHCP

The following table describes the most common table icons.

Table 31 Common Table Icons

LABEL	DESCRIPTION
	Select an entry's check box to select a specific entry. Otherwise, select the check box in the table heading row to select all entries.
Add/Edit	Click this to create a new entry or edit a selected entry. A configuration screen where you can add a new entry or modify the settings of the selected entry will open. In some configuration screens, the Add/Edit button is replaced by the Edit button. This means you can only edit the existing entries in the table.
Delete	To remove entries, select the entries and click Delete .

When viewing a list, you can click on an index number to view more details about the entry. If the list has more than one page, click the arrow button to navigate to different pages of entries.

Figure 67 Working on a List

The Number of VLAN: 13

Index	VID	Name	Tagged Port	Untagged Port	Elapsed Time	Status
1	1	1		1-28	19:35:49	Static
2	2	2			0:01:36	Static
3	3	3			0:01:30	Static
4	4	4			0:01:22	Static
5	8	8			0:00:57	Static
6	9	9			0:00:52	Static
7	10	10			0:00:45	Static
8	11	11			0:00:40	Static
9	12	12			0:00:34	Static
10	13	13			0:00:21	Static

4.6.2 Change Your Password

After you log in for the first time, it is recommended you change the default administrator password. Click **SYSTEM** > **Logins** to display the next screen.

Figure 68 Change Administrator Login Password

Logins

Administrator

Old Password

New Password

Retype to confirm

⚠ Please record your new password whenever you change it. The system will lock you out if you have forgotten your password.

Edit Logins

Login	User Name	Password	Retype to confirm	Privilege
1	<input type="text"/>	<input type="text"/>	<input type="text"/>	<input type="text"/>
2	<input type="text"/>	<input type="text"/>	<input type="text"/>	<input type="text"/>
3	<input type="text"/>	<input type="text"/>	<input type="text"/>	<input type="text"/>
4	<input type="text"/>	<input type="text"/>	<input type="text"/>	<input type="text"/>

Apply Cancel

4.7 Save Your Configuration

When you are done modifying the settings in a screen, click **Apply** to save your changes back to the run-time memory. Settings in the run-time memory are lost when the Switch's power is turned off.

Click the **Save** link in the upper right of the Web Configurator to save your configuration to non-volatile memory. Non-volatile memory refers to the Switch's storage that remains even if the Switch's power is turned off.

Note: Use the **Save** link when you are done with a configuration session.

4.8 Switch Lockout

You could block yourself (and all others) from managing the Switch if you do one of the following:

- 1 Delete the management VLAN (default is VLAN 1).
- 2 Delete all port-based VLANs with the CPU port as a member. The "CPU port" is the management port of the Switch.

- 3 Filter all traffic to the CPU port.
- 4 Disable all ports.
- 5 Misconfigure the text configuration file.
- 6 Forget the password and/or IP address.
- 7 Prevent all services from accessing the Switch.
- 8 Change a service port number but forget it.
- 9 You forgot to log out of the Switch from a computer before logging in again on another computer.

Note: Be careful not to lock yourself and others out of the Switch.

4.9 Reset the Switch

If you lock yourself (and others) from the Switch or forget the administrator password, you will need to reload the factory-default configuration file or reset the Switch back to the factory defaults.

See [Section 3.1 on page 45](#) to see how to use the **RESTORE** button to restore the factory default file.

4.9.1 Reboot the Switch

Press the **RESET** button to reboot the Switch without turning the power off. See [Section 3.3 on page 54](#) for more information about the LED behavior.

4.9.2 Reload the Configuration File

Uploading the factory-default configuration file replaces the current configuration file with the factory-default configuration file. This means that you will lose all previous configurations and the speed of the console port will be reset to the default of 115200 bps with 8 data bit, no parity, one stop bit and flow control set to none. The password will also be reset to "1234" and the IP address to 192.168.1.1 or DHCP-assigned IP.

To upload the configuration file, do the following:

- 1 Connect to the console port using a computer with terminal emulation software.
- 2 Disconnect and reconnect the Switch's power to begin a session. When you reconnect the Switch's power, you will see the initial screen.
- 3 When you see the message "Press any key to enter Debug Mode within 3 seconds ..." press any key to enter debug mode.
- 4 Enter `at1c` after the "Enter Debug Mode" message.
- 5 Wait for the "Starting XMODEM upload" message before activating XMODEM upload on your terminal.

- 6 After a configuration file upload, type `atgo` to restart the Switch.

Figure 69 Resetting the Switch: through the Console Port

```

Bootbase Version: V1.00 | 02/21/2016 15:43:29
RAM: Size = 1048576 Kbytes
FLASH: 64M

ZyNOS Version: V4.60(ABML.0) | 04/18/2017 11:41:8

Press any key to enter debug mode within 1 second.
.....
Enter Debug Mode
ras> atlc
Starting XMODEM upload (CRC mode)....
CCCCCCCCCCCCCCCC
Total 393216 bytes received.
Erasing..
.....
OK
ras> atgo

```

The Switch is now reinitialized with a default configuration file including the default password of "1234".

4.10 Log Out of the Web Configurator

Click **Logout** in a screen to exit the Web Configurator. You have to log in with your password again after you log out. This is recommended after you finish a management session for security reasons.

Figure 70 Logout button



4.11 Help

The Web Configurator's online help has descriptions of individual screens and some supplementary information.

Click the **Help** icon on a Web Configurator screen to view an online help description (shown as below) of that screen.

Figure 71 Online Web Help

The screenshot displays the ZyXel Networks online web help interface. At the top, there is a search bar with the placeholder text "Enter search term or phrase" and navigation icons for search, back, forward, home, and accessibility. Below the search bar is a navigation menu on the left with categories like "Getting to Know Your Switch", "Hardware Installation and Connection", "Web Configurator", "DASHBOARD", "MONITOR", "SYSTEM", "PORT", "SWITCHING", "NETWORKING", "SECURITY", and "MAINTENANCE". The "DASHBOARD" category is selected, showing a sub-menu with "New User Interface", "DASHBOARD", "Port Status", and "Quick Links to Use".

The main content area is titled "DASHBOARD" and contains the following text:

This screen displays general device information, system status, system resource usage, and port status.

The following table describes the labels in this screen.

DASHBOARD

LABEL	DESCRIPTION
Pause Auto Refresh	The DASHBOARD screen automatically refreshes every 30 seconds. Click this to disable the auto refresh. Click Resume Auto Refresh to enable.
Port Status	This displays individual port type, status, and connection speed of the Switch. Click on a port to open the port's status panel. Use the status panel to enable/disable a port and view its basic information. For example, link speed and port utilization. In Stacking mode, this displays the port status of the slot (Switch) selected in the SLOT field.

CHAPTER 5

Initial Setup Example

5.1 Overview

This chapter shows how to set up the Switch for an example network.

The following lists the configuration steps for the initial setup:

- [Create a VLAN](#)
- [Set Port VID](#)
- [Configure Switch Management IP Address](#)

5.1.1 Create a VLAN

VLANs confine broadcast frames to the VLAN group in which the ports belongs. You can do this with port-based VLAN or tagged static VLAN with fixed port members.

In this example, you want to configure port 1 as a member of VLAN 2.

Figure 72 Initial Setup Network Example: VLAN

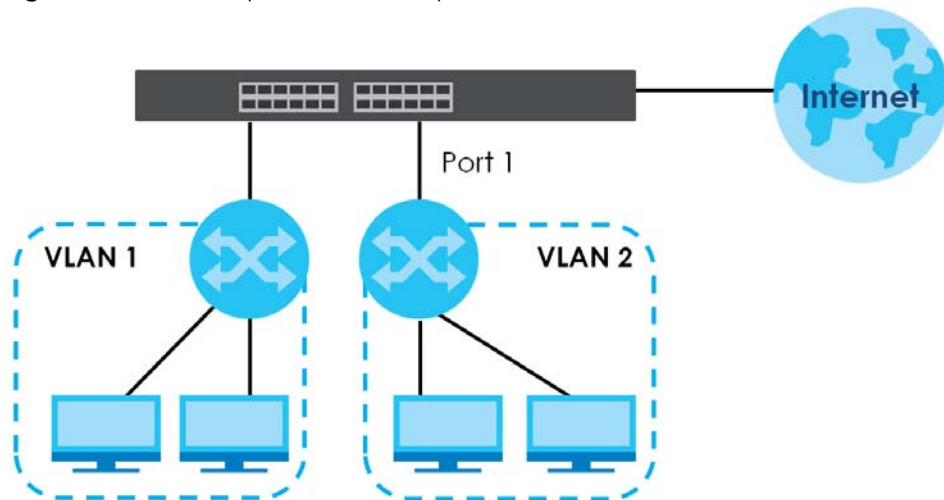

- 1 Go to the **SWITCHING > VLAN > VLAN Setup > Static VLAN** screen. Click **Add/Edit**.

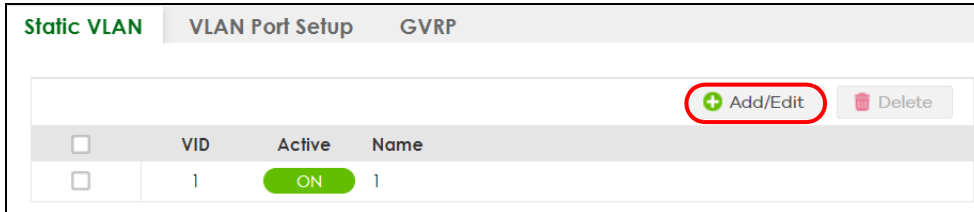

- The following screen appears. Click the switch to set this VLAN to **Active**, enter a descriptive name in the **Name** field and enter "2" in the **VLAN Group ID** field for the **VLAN2** network.

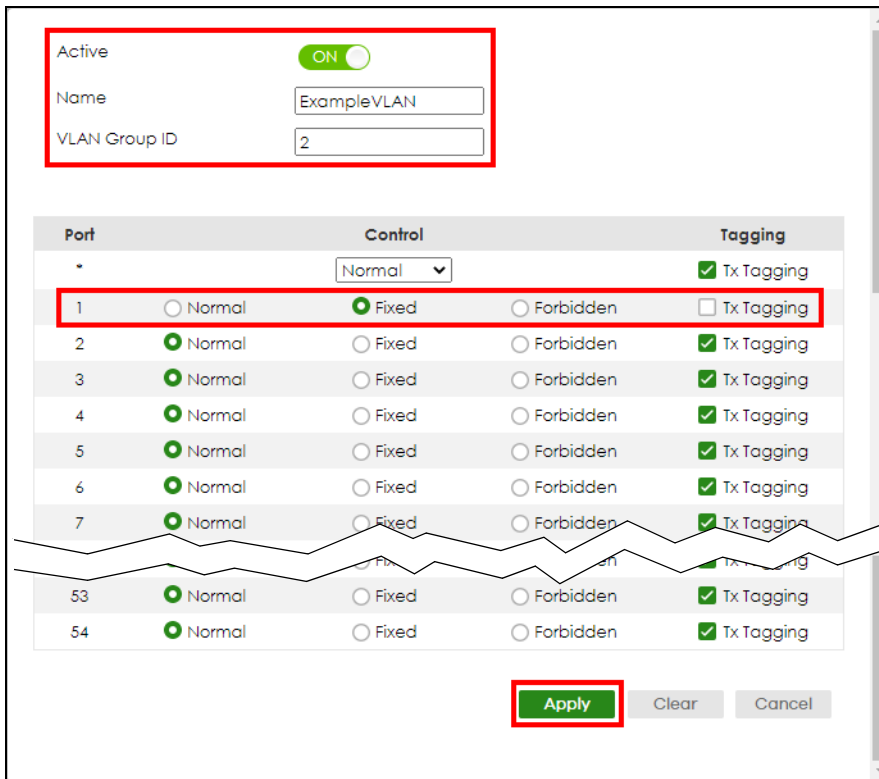

Note: The **VLAN Group ID** field in this screen and the **VID** field in the **SYSTEM > IP Setup > IP Status** screen refer to the same VLAN ID.

- Since the **VLAN2** network is connected to port 1 on the Switch, select **Fixed** to configure port 1 to be a permanent member of the VLAN only.
- To ensure that VLAN-unaware devices (such as computers and hubs) can receive frames properly, clear the **Tx Tagging** check box to set the Switch to remove VLAN tags before sending.
- Click **Apply** to save the settings to the run-time memory. Settings in the run-time memory are lost when the Switch's power is turned off.

5.1.2 Set Port VID

Use PVID to add a tag to incoming untagged frames received on that port so that the frames are forwarded to the VLAN group that the tag defines.

In the example network, configure 2 as the port VID on port 1 so that any untagged frames received on

that port get sent to VLAN 2.

Figure 73 Initial Setup Network Example: Port VID

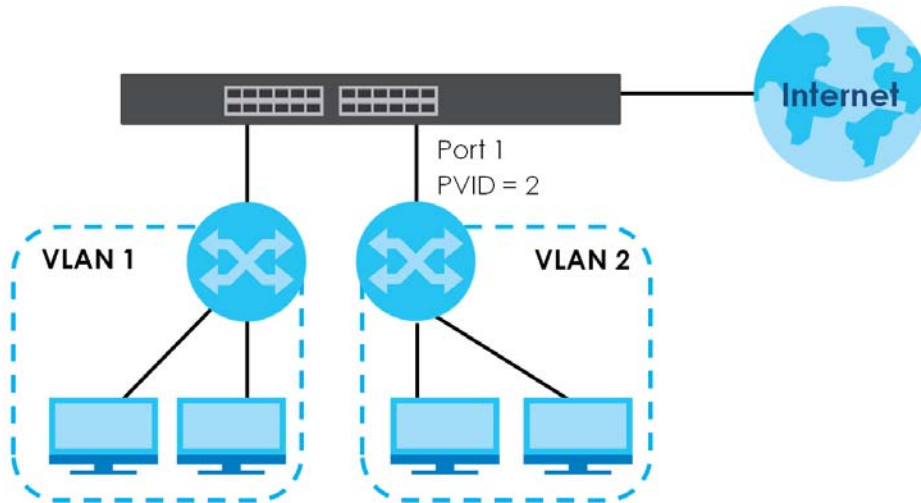

- 1 Go to the **SWITCHING > VLAN > VLAN Setup > VLAN Port Setup** screen.

Port	Ingress Check	PVID	Acceptable Frame Type	VLAN Trunking	Isolation
*	<input type="checkbox"/>		All	<input type="checkbox"/>	<input type="checkbox"/>
1	<input type="checkbox"/>	2	All	<input type="checkbox"/>	<input type="checkbox"/>
2	<input type="checkbox"/>	1	All	<input type="checkbox"/>	<input type="checkbox"/>
3	<input type="checkbox"/>	1	All	<input type="checkbox"/>	<input type="checkbox"/>
4	<input type="checkbox"/>	1	All	<input type="checkbox"/>	<input type="checkbox"/>
5	<input type="checkbox"/>	1	All	<input type="checkbox"/>	<input type="checkbox"/>
6	<input type="checkbox"/>	1	All	<input type="checkbox"/>	<input type="checkbox"/>
7	<input type="checkbox"/>	1	All	<input type="checkbox"/>	<input type="checkbox"/>

- 2 Enter 2 in the **PVID** field for port 1 and click **Apply** to save your changes back to the run-time memory. Settings in the run-time memory are lost when the Switch's power is turned off.

5.1.3 Configure Switch Management IP Address

If the Switch fails to obtain an IP address from a DHCP server, the Switch will use 192.168.1.1 as the management IP address. You can configure another IP address in a different subnet for management purposes. The following figure shows an example.

Figure 74 Initial Setup Example: Management IP Address

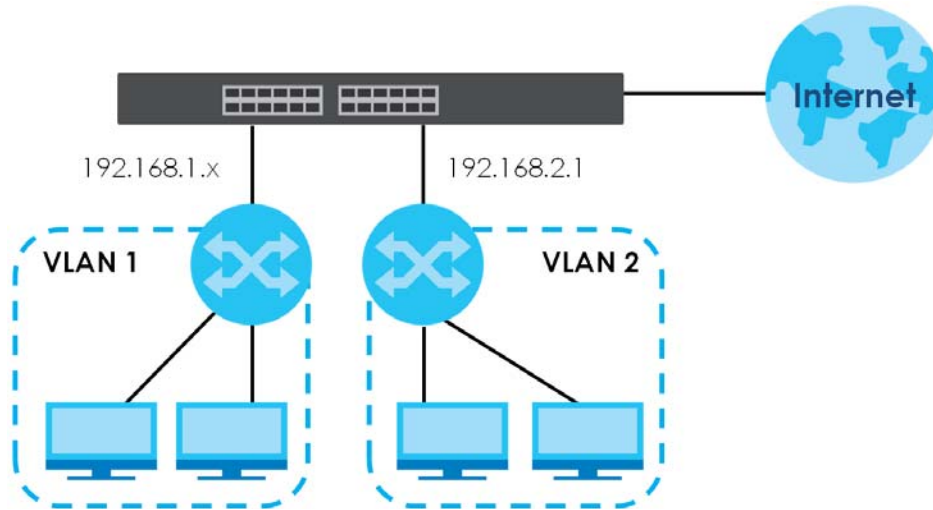

- 1 Connect your computer to any Ethernet port on the Switch. Make sure your computer is in the same subnet as the Switch.
- 2 Open your web browser and enter "setup.zyxel" or "192.168.1.1" (the default IP address) in the address bar to access the Web Configurator. See [Section 4.2 on page 58](#) for more information.

Note: You can always use the domain name "setup.zyxel" to access the Web Configurator whether the Switch is using a DHCP-assigned IP or static IP address. This requires your PC to be directly connected to the Switch.

- 3 Go to the **SYSTEM > IP Setup > IP Setup** screen. Click **Add/Edit**.

The screenshot shows the IP Setup configuration page. The 'IP Setup' tab is selected. The 'IP Setup' section contains input fields for Default Gateway (0.0.0.0), Domain Name Server 1, and Domain Name Server 2. Below this is an 'IP Interface' section with a table listing the current interface configuration. The 'Add/Edit' button is highlighted with a red box.

	Index	IP Address	IP Subnet Mask	VID	Type
<input type="checkbox"/>	1	172.21.40.2	255.255.252.0	1	DHCP

The following screen appears.

The screenshot shows a configuration window with two main sections. The top section is for DHCP Client, with an unselected radio button. Below it, 'Option-60' is checked with a green box, and 'Class-ID' is set to 'Zyxel Corporation'. The bottom section is for Static IP Address, with a selected radio button. It includes three input fields: 'IP Address' with '192.168.2.1', 'IP Subnet Mask' with '255.255.255.0', and 'VID' with '2'. At the bottom, there are three buttons: 'Apply' (highlighted with a red circle), 'Clear', and 'Cancel'.

- 4 For the **VLAN2** network, enter 192.168.2.1 as the IP address and 255.255.255.0 as the subnet mask.
- 5 In the **VID** field, enter the ID of the VLAN group to which you want this management IP address to belong. In this example, enter VLAN ID 2. This is the same as the VLAN ID you configure in the **Static VLAN** screen.
- 6 Click **Apply** to save your changes back to the run-time memory. Settings in the run-time memory are lost when the Switch's power is turned off.

CHAPTER 6

Tutorials

6.1 Overview

This chapter provides some examples of using the Web Configurator to set up and use the Switch. The tutorials include:

- [How to Use DHCPv4 Snooping on the Switch](#)
- [How to Use DHCPv4 Relay on the Switch](#)
- [How to Use Auto Configuration through a DHCP Server on the Switch](#)

6.2 How to Use DHCPv4 Snooping on the Switch

You only want DHCP server **A** connected to port 5 to assign IP addresses to all devices in VLAN network (**V**). Create a VLAN containing ports 4, 5 and 6. Connect a computer **M** to the Switch for management.

Figure 75 Tutorial: DHCP Snooping Tutorial Overview

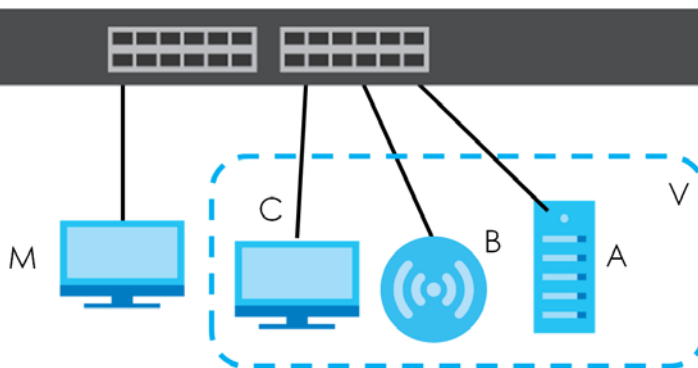

The settings in this tutorial are as the following.

Table 32 Tutorial: Settings in this Tutorial

HOST	PORT CONNECTED	VLAN	PVID	DHCP SNOOPING PORT TRUSTED
DHCP Server (A)	4	1 and 100	100	Yes
DHCP Client (B)	5	1 and 100	100	No
DHCP Client (C)	6	1 and 100	100	No

- 1 Access the Switch through <http://192.168.1.1> by default. Log into the Switch by entering the user name (default: **admin**) and password (default: **1234**).

- 2 Go to **SWITCHING > VLAN > VLAN Setup > Static VLAN**. Click **Add/Edit**.

Static VLAN | VLAN Port Setup | GVRP

+ Add/Edit Delete

<input type="checkbox"/>	VID	Active	Name
<input type="checkbox"/>	1	ON	1

- 3 The following screen appears. Enable the switch button to set this VLAN to **ACTIVE**. Create a VLAN with ID of 100. Add ports 4, 5 and 6 in the VLAN by selecting **Fixed** in the **Control** field as shown.

De-select **Tx Tagging** because you do not want outgoing traffic to contain this VLAN tag.

Click **Apply**.

Active ON

Name

VLAN Group ID

Port	Control	Tagging
*	Normal	<input checked="" type="checkbox"/> Tx Tagging
1	<input checked="" type="radio"/> Normal <input type="radio"/> Fixed <input type="radio"/> Forbidden	<input checked="" type="checkbox"/> Tx Tagging
2	<input checked="" type="radio"/> Normal <input type="radio"/> Fixed <input type="radio"/> Forbidden	<input checked="" type="checkbox"/> Tx Tagging
3	<input checked="" type="radio"/> Normal <input type="radio"/> Fixed <input type="radio"/> Forbidden	<input checked="" type="checkbox"/> Tx Tagging
4	<input type="radio"/> Normal <input checked="" type="radio"/> Fixed <input type="radio"/> Forbidden	<input type="checkbox"/> Tx Tagging
5	<input type="radio"/> Normal <input checked="" type="radio"/> Fixed <input type="radio"/> Forbidden	<input type="checkbox"/> Tx Tagging
6	<input type="radio"/> Normal <input checked="" type="radio"/> Fixed <input type="radio"/> Forbidden	<input type="checkbox"/> Tx Tagging
7	<input checked="" type="radio"/> Normal <input type="radio"/> Fixed <input type="radio"/> Forbidden	<input checked="" type="checkbox"/> Tx Tagging
8	<input checked="" type="radio"/> Normal <input type="radio"/> Fixed <input type="radio"/> Forbidden	<input checked="" type="checkbox"/> Tx Tagging
9	<input checked="" type="radio"/> Normal <input type="radio"/> Fixed <input type="radio"/> Forbidden	<input checked="" type="checkbox"/> Tx Tagging

Apply Clear Cancel

- 4 Go to **SWITCHING > VLAN > VLAN Setup > VLAN Port Setup**, and set the PVID of the ports 4, 5 and 6 to 100. This tags untagged incoming frames on ports 4, 5 and 6 with the tag 100. Click **Apply**.

Port	Ingress Check	PVID	Acceptable Frame Type	VLAN Trunking	Isolation
*	<input type="checkbox"/>		All	<input type="checkbox"/>	<input type="checkbox"/>
1	<input type="checkbox"/>	1	All	<input type="checkbox"/>	<input type="checkbox"/>
2	<input type="checkbox"/>	1	All	<input type="checkbox"/>	<input type="checkbox"/>
3	<input type="checkbox"/>	1	All	<input type="checkbox"/>	<input type="checkbox"/>
4	<input type="checkbox"/>	100	All	<input type="checkbox"/>	<input type="checkbox"/>
5	<input type="checkbox"/>	100	All	<input type="checkbox"/>	<input type="checkbox"/>
6	<input type="checkbox"/>	100	All	<input type="checkbox"/>	<input type="checkbox"/>
7	<input type="checkbox"/>	1	All	<input type="checkbox"/>	<input type="checkbox"/>

- 5 Go to **SECURITY > DHCP Snooping > DHCP Snp. Setup**, activate and specify VLAN 100 as the DHCP VLAN as shown. Click **Apply**.
 IP requests from VLANs you enable on the **SECURITY > DHCP Snooping > DHCP Snp. VLAN Setup** screen will be broadcast to the DHCP VLAN you set on this screen, which is VLAN100 in this example.

DHCP Snp. Status	DHCP Snp. Setup	DHCP Snp. Port Setup
DHCP Snooping Setup		
Active	<input checked="" type="radio"/> ON	
DHCP Vlan	<input type="radio"/> Disable <input checked="" type="radio"/> 100	
Database		
Agent URL	<input type="text"/>	
Timeout Interval	<input type="text" value="300"/>	seconds
Write Delay Interval	<input type="text" value="300"/>	seconds
Renew DHCP Snooping URL	<input type="text"/>	<input type="button" value="Renew"/>
<input type="button" value="Apply"/> <input type="button" value="Cancel"/>		

- 6 Go to **SECURITY > DHCP Snooping > DHCP Snp. Port Setup**. Select **Trusted** in the **Server Trusted state** field for port 4 because the DHCP server is connected to port 4. Keep ports 5 and 6 **Untrusted** because they are connected to DHCP clients. Click **Apply**.

Port	Server Trusted State	Rate (pps)
*	Untrusted	
1	Untrusted	0
2	Untrusted	0
3	Untrusted	0
4	Trusted	0
5	Untrusted	0
6	Untrusted	0
7	Untrusted	0

- 7 Go to **SECURITY > DHCP Snooping > DHCP Snp. VLAN Setup**, show VLAN 100 by entering 100 in the **VLAN Search by VID** field and click **Search**.

Select **Yes** in the **Enabled** field of the VLAN 100 entry shown in the search result. Click **Apply**.

This enables DHCP snooping on VLAN100 (and other VLANs you enabled on this screen).

If you want the Switch to add more information in the DHCP request packets, such as source VLAN ID or system name, you can select an **Option82 Profile** in the entry. The Switch will add DHCP option 82 information to DHCP requests that the Switch relays to a DHCP server for the specified VLAN.

VLAN Search by VID: 100 Search

The Number of VLAN: 2

VID	Enabled	Option 82 Profile
1	No	
100	Yes	

- 8 Connect your DHCP server to port 4 and a DHCP client (an AP, for example) to either port 5 or 6. The AP should be able to get an IP address from the DHCP server. If you put the DHCP server on port 5 or 6, the computer will NOT be able to get an IP address.
- 9 Click **Save** at the top right of the Web Configurator to save the configuration permanently.

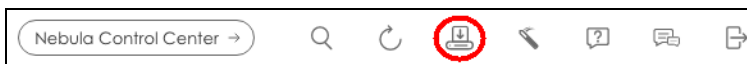

- 10 To check if DHCP snooping works, go to **SECURITY > IPv4 Source Guard > IP Source Guard**, you should see an IP assignment with the type **DHCP-Snooping** as shown.

IP Source Guard		Static Binding				
Index	IP Address	VLAN	MAC Address	Port	Lease	Type
1	192.168.2.178	100	88:88:88:88:88:8b	5	0d23h59m55s	DHCP-Snooping

You can also use telnet. Use the command “show dhcp snooping binding” to see the DHCP snooping binding table as shown next.

```
sysname# show dhcp snooping binding
      MacAddress           IpAddress           Lease           Type  VLAN  Port
-----
88:88:88:88:88:8b      192.168.2.178      0d23h59m20s     dhcp-snooping    100    5
Total number of bindings: 1
```

6.3 How to Use DHCPv4 Relay on the Switch

This tutorial describes how to configure your Switch to forward DHCP client requests to a specific DHCP server. The DHCP server can then assign a specific IP address based on the information in the DHCP requests.

6.3.1 DHCP Relay Tutorial Introduction

In this example, you have configured your DHCP server (192.168.2.3) and want to have it assign a specific IP address (say 172.16.1.18) to DHCP client **A** based on the system name, VLAN ID and port number in the DHCP request. Client **A** connects to the Switch’s port 2 in VLAN 102.

Figure 76 Tutorial: DHCP Relay Scenario

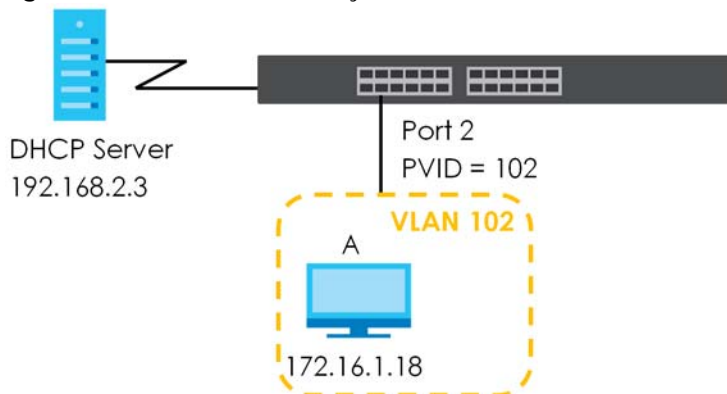

6.3.2 Create a VLAN

Follow the steps below to configure port 2 as a member of VLAN 102.

- 1 Access the Web Configurator through the Switch’s management port.
- 2 Go to **SYSTEM > Switch Setup** and set the **VLAN Type** to **802.1Q**. Click **Apply** to save the settings to the run-time memory.

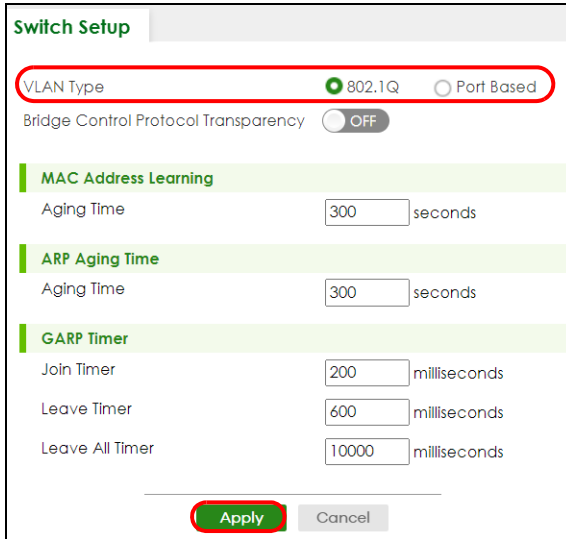

Switch Setup

VLAN Type 802.1Q Port Based

Bridge Control Protocol Transparency OFF

MAC Address Learning

Aging Time seconds

ARP Aging Time

Aging Time seconds

GARP Timer

Join Timer milliseconds

Leave Timer milliseconds

Leave All Timer milliseconds

- 3 Go to **SWITCHING > VLAN > VLAN Setup > Static VLAN**. Click **Add/Edit**.

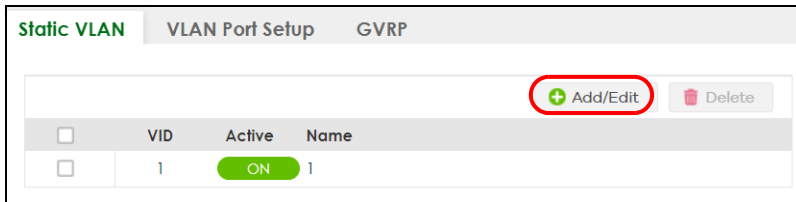

Static VLAN | VLAN Port Setup | GVRP

<input type="checkbox"/>	VID	Active	Name
<input type="checkbox"/>	1	<input checked="" type="button" value="ON"/>	1

- 4 The following screen appears. Enable the switch button to set this VLAN to **Active**. Enter a descriptive name (VLAN 102 for example) in the **Name** field and enter "102" in the **VLAN Group ID** field.

Active ON

Name

VLAN Group ID

Port	Control			Tagging
*	Normal			<input checked="" type="checkbox"/> Tx Tagging
1	<input checked="" type="radio"/> Normal	<input type="radio"/> Fixed	<input type="radio"/> Forbidden	<input checked="" type="checkbox"/> Tx Tagging
2	<input type="radio"/> Normal	<input checked="" type="radio"/> Fixed	<input type="radio"/> Forbidden	<input type="checkbox"/> Tx Tagging
3	<input checked="" type="radio"/> Normal	<input type="radio"/> Fixed	<input type="radio"/> Forbidden	<input checked="" type="checkbox"/> Tx Tagging
4	<input checked="" type="radio"/> Normal	<input type="radio"/> Fixed	<input type="radio"/> Forbidden	<input checked="" type="checkbox"/> Tx Tagging
5	<input checked="" type="radio"/> Normal	<input type="radio"/> Fixed	<input type="radio"/> Forbidden	<input checked="" type="checkbox"/> Tx Tagging
6	<input checked="" type="radio"/> Normal	<input type="radio"/> Fixed	<input type="radio"/> Forbidden	<input checked="" type="checkbox"/> Tx Tagging
7	<input checked="" type="radio"/> Normal	<input type="radio"/> Fixed	<input type="radio"/> Forbidden	<input checked="" type="checkbox"/> Tx Tagging
8	<input checked="" type="radio"/> Normal	<input type="radio"/> Fixed	<input type="radio"/> Forbidden	<input checked="" type="checkbox"/> Tx Tagging
9	<input checked="" type="radio"/> Normal	<input type="radio"/> Fixed	<input type="radio"/> Forbidden	<input checked="" type="checkbox"/> Tx Tagging

- 5 Set port 2 to be a permanent member of this VLAN by selecting **Fixed** in the **Control** field.
- 6 Clear the **Tx Tagging** check box to set the Switch to remove VLAN tags before sending.
- 7 Click **Apply** to save the settings to the run-time memory. Settings in the run-time memory are lost when the Switch's power is turned off.
- 8 Go to **VLAN > VLAN Setup > VLAN Port Setup**. Enter "102" in the **PVID** field for port 2 to add a tag to incoming untagged frames received on that port so that the frames are forwarded to the VLAN group that the tag defines.

Port	Ingress Check	PVID	Acceptable Frame Type	VLAN Trunking	Isolation
*	<input type="checkbox"/>		All	<input type="checkbox"/>	<input type="checkbox"/>
1	<input type="checkbox"/>	1	All	<input type="checkbox"/>	<input type="checkbox"/>
2	<input type="checkbox"/>	102	All	<input type="checkbox"/>	<input type="checkbox"/>
3	<input type="checkbox"/>	1	All	<input type="checkbox"/>	<input type="checkbox"/>
4	<input type="checkbox"/>	1	All	<input type="checkbox"/>	<input type="checkbox"/>
5	<input type="checkbox"/>	1	All	<input type="checkbox"/>	<input type="checkbox"/>
6	<input type="checkbox"/>	1	All	<input type="checkbox"/>	<input type="checkbox"/>
7	<input type="checkbox"/>	1	All	<input type="checkbox"/>	<input type="checkbox"/>

- 9 Click **Apply** to save your changes back to the run-time memory.
- 10 Click the **Save** link in the upper right of the Web Configurator to save your configuration permanently.

6.3.3 Configure DHCPv4 Relay

Follow the steps below to enable DHCP relay on the Switch and allow the Switch to add relay agent information (such as the VLAN ID) to DHCP requests.

- 1 Click **NETWORKING > DHCP > DHCPv4 Relay > DHCP Smart Relay**. Enable the **Active** switch button.

DHCP Relay Status DHCP Option 82 Profile **DHCP Smart Relay** DHCP Relay VLAN Setting

DHCP Smart Relay

Active

Remote DHCP Server 1

Remote DHCP Server 2

Remote DHCP Server 3

Option 82 Profile

Port

Index	Port	Profile Name
<input type="checkbox"/>		

- 2 Enter the DHCP server's IP address (192.168.2.3 in this example) in the **Remote DHCP Server 1** field.
- 3 Select **default1** or **default2** in the **Option 82 Profile** field.
- 4 Click **Apply** to save your changes back to the run-time memory.
- 5 Click the **Save** link in the upper right of the Web Configurator to save your configuration permanently.
- 6 The DHCP server can then assign a specific IP address based on the DHCP request.

6.3.4 Troubleshooting

Check client **A**'s IP address. If it did not receive the IP address 172.16.1.18, make sure:

- 1 Client **A** is connected to the Switch's port 2 in VLAN 102.
- 2 You configured the correct VLAN ID, port number and system name for DHCP relay on both the DHCP server and the Switch.
- 3 You clicked the **Save** link on the Switch to have your settings take effect.

6.4 How to Use Auto Configuration through a DHCP Server on the Switch

Follow the steps below to set up configurations on a DHCP server, TFTP server, and the Switch, so you can load an auto configuration file automatically from a TFTP server when you reboot the Switch.

Note that you can set up a DHCP server and TFTP server either on the same device or different devices. Also, make sure the Switch can communicate with the TFTP server.

Note: Steps order could vary according to different programs you use.

Note: You need to set up configurations on a DHCP server and TFTP server first to use auto configuration.

Setting up a DHCP Server

- 1 Set up a dynamic IP addresses pool so the DHCP server will assign an IP address to the Switch in that range.
- 2 Set up a TFTP server IP address, so the Switch will know where to load the auto configuration file.
- 3 Set up the filename of the auto configuration file, so the Switch will know which file to load when you reboot the Switch.
 - Enter the filename of an auto configuration file. The Switch will load this auto configuration file when rebooting with DHCP option 60 disabled.
 - If you want to load the auto configuration file with DHCP option 60 enabled and a Vendor Class Identifier assigned when you reboot the Switch, follow the instruction below. Otherwise, skip this step.
Enter the filename of an auto configuration file. Set up a Vendor Class Identifier. To have the Switch load this auto configuration file, two conditions listed above must be met. Please refer to the following steps to see how to set up a Vendor Class Identifier on the Switch.

Setting up a TFTP Server

- 1 Select a directory on the TFTP server.
- 2 Put the configuration files in that directory.

Setting Up the Switch

- 1 Open the Web Configurator. Go to the **MAINTENANCE > Configuration > Auto Configuration** screen.
- 2 Enable the switch button in the **Active** field to enable auto configuration. Select **DHCP** in the **Mode** field, and enter the VLAN ID where the DHCP server belongs to in the **DHCP VLAN ID** field. Click **Apply** to save your changes.

Auto Configuration

Mode None
State None
Filename

Active ON

Mode

DHCP VLAN ID

HTTPS URL

- 3 Go to the **SYSTEM > IP Setup > IP Setup** screen. Click the **Add/Edit** button in the **IP Interface** table to open the configuration screen.
- 4 Select **DHCP Client**.
- 5 If you want to load the auto configuration file with DHCP option 60 enabled and a Vendor Class Identifier assigned when you reboot the Switch, follow the instruction below. Otherwise, skip this step. In the **SYSTEM > IP Setup > IP Setup > Add/Edit** screen, select the check box in the **Option-60** field. Enter a Vendor Class Identifier in the **Class-ID** field, and specify the VLAN interface in the **VID** field. In this example, we use "Zyxel Corp" and **VID 1**. Click **Apply**.

DHCP Client

Option-60

Class-ID

Static IP Address

IP Address

IP Subnet Mask

VID

- 6 You need to save the current configuration in a configuration file, so the Switch will load the auto configuration file from the TFTP server automatically when rebooting. Go to the **MAINTENANCE > Configuration > Save Configuration** screen. Click the **Config 1**, **Config 2**, or **Custom Default** button.

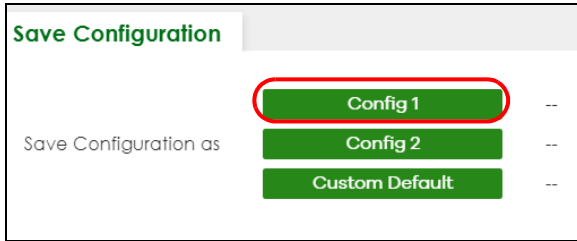

- 7 Click the same button in the **MAINTENANCE > Reboot System** screen to reboot the Switch, and load the auto configuration setting as configured before. For example, if you save the auto configuration setting to **Config 1**, you need to click the **Config 1** button in the **Reboot System** screen.

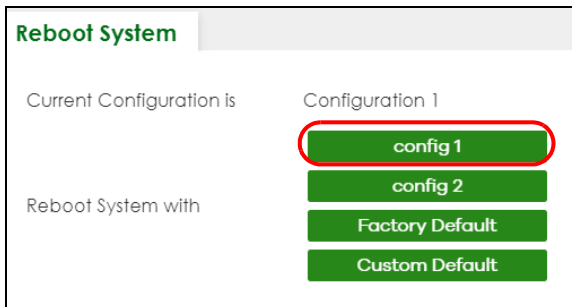

- 8 Go to the **MONITOR > System Log** screen to see if auto configuration was performed successfully.

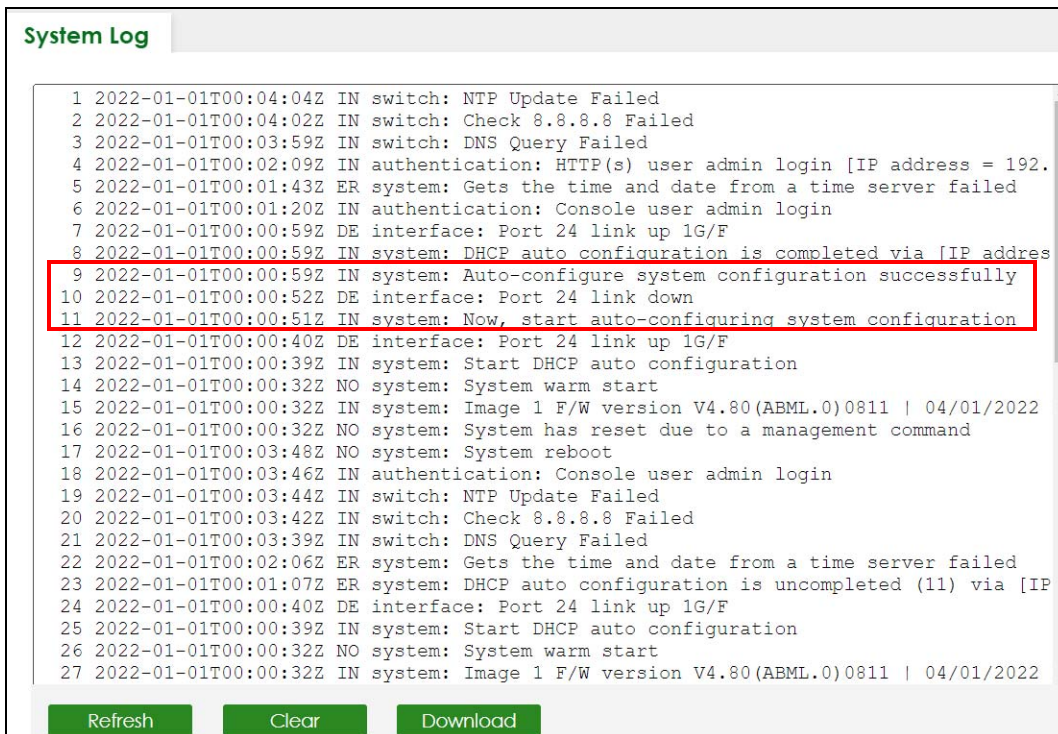

- 9 Check the screens to see if it is the configuration file you want to load. If it is not, go through the steps above to check your configurations. If it is, click **Save** at the top right corner of the Web Configurator to save the configuration permanently.

CHAPTER 7

DASHBOARD

This chapter gives a quick introduction on the **DASHBOARD** screen.

The **DASHBOARD** screen automatically appears after you log into the Web Configurator.

7.1 New User Interface

With ZyNOS 4.80 and later, the Web Configurator's user interface is restructured. In the new **DASHBOARD** screen, you can easily monitor the system status with the following tools (see [DASHBOARD](#) for more information):

- Visualized **Port Status** section with clickable port icons that provide information of that port, an ON/OFF switch button to enable/disable the port, and a **Power Cycle** button to turn the power off to the PoE port and then back on again (see [Port Status](#)).
- Visualized **Cloud Control Status** section that displays the NCC connection status using three connection-stage circles.
- Clickable hardware status monitoring sections that directly link to the **MONITOR > System Information** screen.
- Editable **Quick Link** section which provides shortcuts to configuration screens that you might frequently use (See [Quick Links to Use](#)).
- A **Search** tool on the upper right of the screen that you can use to search for the configuration screens you want to access (see [Web Configurator Layout](#)).

The left navigation panel is also restructured into task-based UI. You can display the sub-menu in the **MONITOR**, **SYSTEM**, **PORT**, **SWITCHING**, **NETWORKING**, **SECURITY**, or the **MAINTENANCE** section by clicking their icons. See [Web Configurator Layout](#) for more information.

Find the latest release note in: [Download Library](#) on www.zyxel.com.

7.2 DASHBOARD

This screen displays general device information, system status, system resource usage, and port status.

This guide uses XGS2220-54FP screens as an example. The screens may vary slightly for different models.

Click **DASHBOARD** in the navigation panel to open the following screen.

Figure 77 DASHBOARD (Standalone Mode, example PoE model)

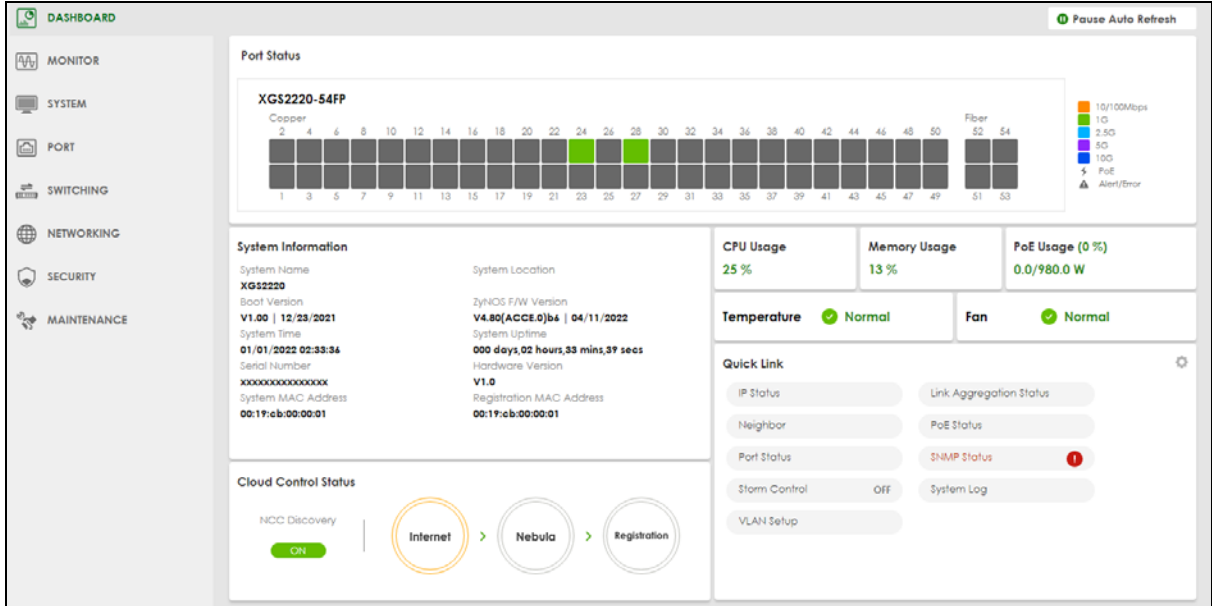
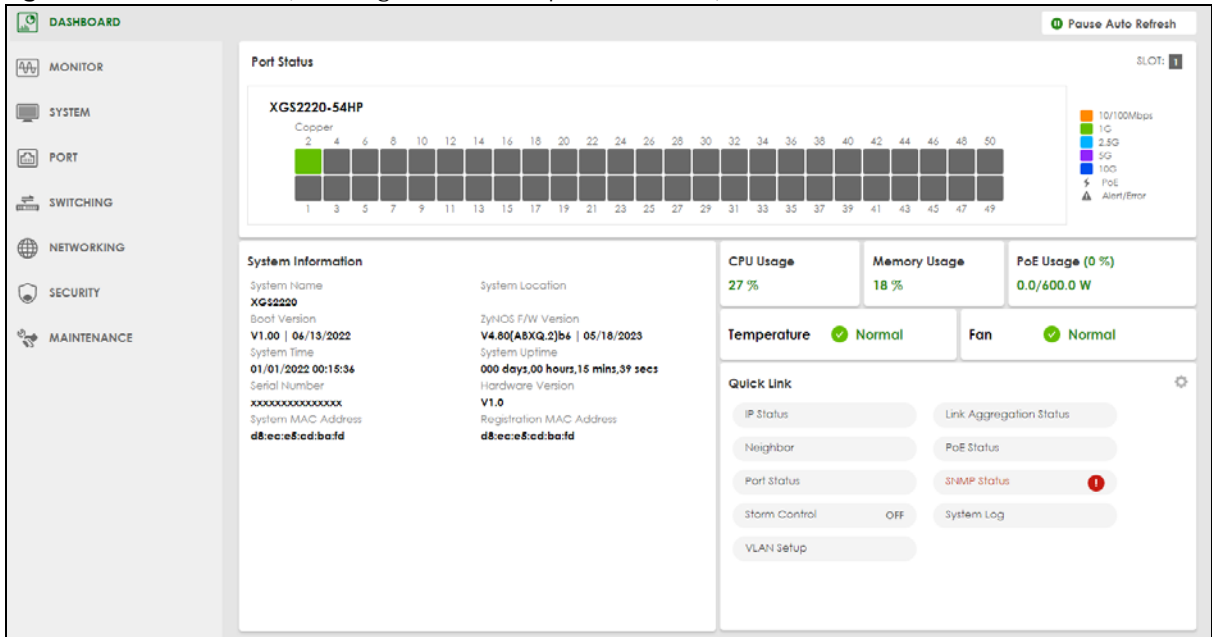

Figure 78 DASHBOARD (Stacking Mode, example PoE model)



The following table describes the labels in this screen.

Table 33 DASHBOARD

LABEL	DESCRIPTION
Pause Auto Refresh	The DASHBOARD screen automatically refreshes every 30 seconds. Click this to disable the auto refresh. Click Resume Auto Refresh to enable.
Port Status	This displays individual port type, status, and connection speed of the Switch. Click on a port to open the port's status panel. Use the status panel to enable/disable a port and view its basic information. For example, link speed and port utilization. In Stacking mode, this displays the port status of the slot (Switch) selected in the SLOT field. Note: The port status may vary for non-PoE and PoE models.
SLOT	This appears only in Stacking mode. Click the index to choose the slot number of a Switch in the stacking system.
System Information	
System Name	This field displays the name used to identify the Switch on any network.
System Location	This field displays the geographic location name you set for the Switch.
Boot Version	This field displays the version number and date of the boot module that is currently on the Switch.
ZyNOS F/W Version	This field displays the version number and date of the firmware the Switch is currently running.
System Time	This field displays the current date and time in the UAG. The format is mm/dd/yyyy hh:mm:ss.
System Uptime	This field displays how long the Switch has been running since it last restarted or was turned on.
Serial Number	This field displays the serial number of this Switch. The serial number is used for device tracking and control.
Hardware Version	This field displays the hardware version of the Switch.
System MAC Address	This field displays the MAC address of the Switch.
Registration MAC Address	This is the MAC address reserved for NCC registration. Use this MAC address to register the Switch on NCC.

Table 33 DASHBOARD (continued)

LABEL	DESCRIPTION
Cloud Control Status	<p>This field does not appear in Stacking mode.</p> <p>This field displays:</p> <ul style="list-style-type: none"> The Switch Internet connection status. The connection status between the Switch and NCC. The Switch registration status on NCC. <p>Mouse over the circles to display detailed information.</p> <p>To pass your Switch management to NCC, first make sure your Switch is connected to the Internet. Then go to NCC and register your Switch.</p> <p>Click Cloud Control Status or the switch button to go to the SYSTEM > Cloud Management screen. You can enable/disable NCC Discovery or view the NCC connection status in the Cloud Management screen.</p> <p>1. Internet</p> <p>Green – The Switch is connected to the Internet.</p> <p>Orange – The Switch is not connected to the Internet.</p> <p>2. Nebula</p> <p>Green – The Switch is connected to NCC.</p> <p>Orange – The Switch is not connected to NCC.</p> <p>3. Registration</p> <p>Green – The Switch is registered on NCC.</p> <p>Gray – The Switch is not registered on NCC.</p> <p>Note: All circles will gray out if you disable Nebula Discovery.</p> <p>Note: If a circle displays orange or gray, hover the mouse over the circle to check the diagnostic message.</p>
NCC Discovery	<p>This field does not appear in Stacking mode.</p> <p>This displays if NCC discovery is enabled on the Switch. The Switch will connect to NCC and change to the NCC management mode if it:</p> <ul style="list-style-type: none"> is connected to the Internet. has been registered on NCC.
CPU Usage	<p>This displays the current CPU usage percentage.</p> <p>Click to go to the MONITOR > System Information screen to check the detailed information.</p>
Memory Usage	<p>This displays the current RAM usage percentage.</p> <p>Click to go to the MONITOR > System Information screen to check the detailed information.</p>
PoE Usage	<p>For PoE models.</p> <p>This field displays the amount of power the Switch is currently supplying to the connected PoE-enabled devices and the total power the Switch can provide to the connected PDs. It also shows the percentage of PoE power usage.</p> <p>When PoE usage reaches 100%, the Switch will shut down PDs one-by-one according to the PD priority which you configured in PORT > PoE Setup > PoE Setup.</p>

Table 33 DASHBOARD (continued)

LABEL	DESCRIPTION
Temperature	The Switch has temperature sensors that are capable of detecting and reporting if the temperature rises above the threshold. This displays the Switch's current device temperature level. Click to go to the MONITOR > System Information screen to check the detailed information.
Fan	Each fan of the Switch has a sensor that is capable of detecting and reporting if the fan speed falls below the threshold. This displays the Switch's overall fan speed status. Click to go to the MONITOR > System Information screen to check the detailed information.
Quick Link	This section provides shortcut links to specific configuration screens. Click the edit button to choose the quick links to show.

7.2.1 Port Status

The **Port Status** section provides visualized port status for monitoring. Each port displays a status color determined by their link speed.

Figure 79 Port Status (example PoE model)

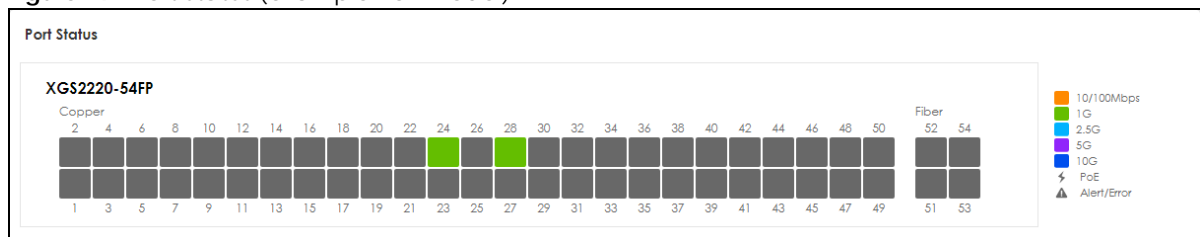

Click on a port to display a port's status pane.

Figure 80 Port details Pane (example PoE model)

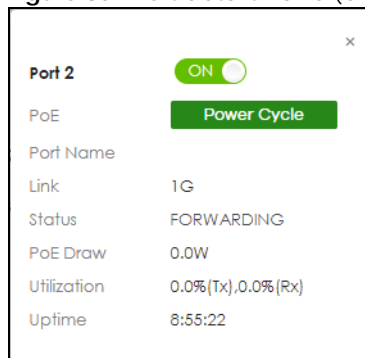

The port details pane includes the **Power Cycle** button for PoE models (turn the power off and then back on again), displays information such as link speed, status, PoE draw (for PoE models), port utilization, up time and has an ON/OFF switch button. Click the switch button to enable/disable the port.

7.2.2 Quick Links to Use

The quick links in the **Quick Link** section provide shortcuts to specific configuration screens. You can use the quick links to directly access the screens that you would frequently use. You can also decide which quick links to be put on the **DASHBOARD** screen using the **Edit** button.

Figure 81 Quick Links (example PoE model)

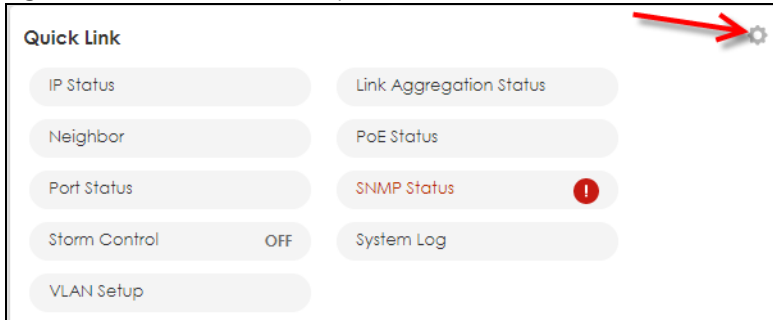

The setup panel displays after you click the **Edit** button.

Figure 82 Quick Link Selection (example PoE model)

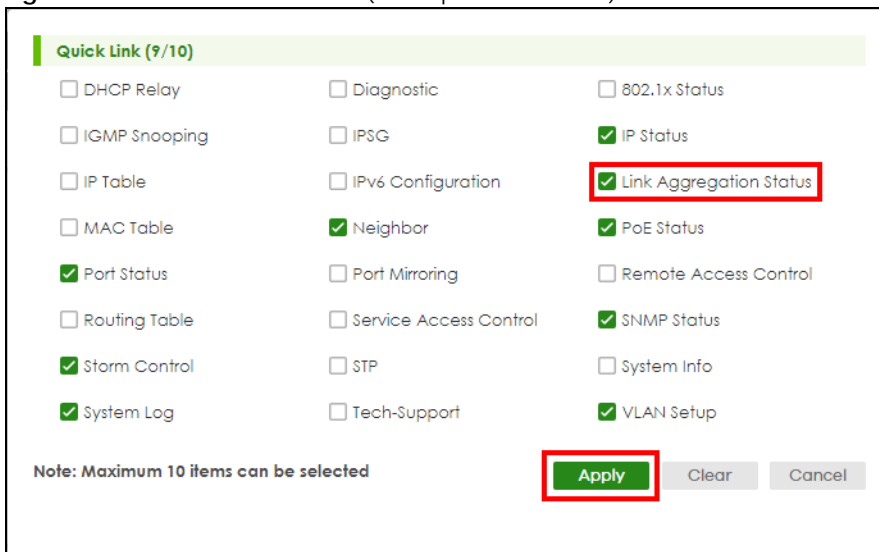

Select the quick links you want and click **Apply**. The selected quick links will be displayed in the **Quick Link** section on the **DASHBOARD** screen.

CHAPTER 8

MONITOR

The following chapters introduces the configurations of the links under the **MONITOR** navigation panel.

Quick links to chapters:

- [ARP Table](#)
- [IP Table](#)
- [IPv6 Neighbor Table](#)
- [MAC Table](#)
- [Neighbor](#)
- [Path MTU Table](#)
- [Port Status](#)
- [Routing Table](#)
- [System Information](#)
- [System Log](#)

CHAPTER 9

ARP Table

9.1 ARP Table Overview

This chapter introduces the ARP Table.

Address Resolution Protocol (ARP) is a protocol for mapping an Internet Protocol address (IP address) to a physical machine address, also known as a Media Access Control or MAC address, on the local area network.

An IP (version 4) address is 32 bits long. In an Ethernet LAN, MAC addresses are 48 bits long. The ARP Table maintains an association between each MAC address and its corresponding IP address.

9.1.1 What You Can Do

Use the **ARP Table** screen ([Section 9.2 on page 124](#)) to view IP-to-MAC address mappings.

9.1.2 What You Need to Know

When an incoming packet destined for a host device on a local area network arrives at the Switch, the Switch's ARP program looks in the ARP Table and if it finds the address, it sends it to the device.

If no entry is found for the IP address, ARP broadcasts the request to all the devices on the LAN. The Switch fills in its own MAC and IP address in the sender address fields, and puts the known IP address of the target in the target IP address field. In addition, the Switch puts all ones in the target MAC field (FF.FF.FF.FF.FF.FF is the Ethernet broadcast address). The replying device (which is either the IP address of the device being sought or the router that knows the way) replaces the broadcast address with the target's MAC address, swaps the sender and target pairs, and unicasts the answer directly back to the requesting machine. ARP updates the ARP Table for future reference and then sends the packet to the MAC address that replied.

9.2 Viewing the ARP Table

Use the ARP table to view IP-to-MAC address mappings and remove specific dynamic ARP entries.

Click **MONITOR > ARP Table** in the navigation panel to open the following screen.

Figure 83 MONITOR > ARP Table

ARP Table

Condition

All

IP Address

Port

Index	IP Address	MAC Address	VID	Port	Age(s)	Type

The following table describes the labels in this screen.

Table 34 MONITOR > ARP Table

LABEL	DESCRIPTION
Condition	Specify how you want the Switch to remove ARP entries when you click Flush . Select All to remove all of the dynamic entries from the ARP table. Select IP Address and enter an IP address to remove the dynamic entries learned with the specified IP address. Select Port and enter a port number to remove the dynamic entries learned on the specified port. You can enter multiple ports separated by (no space) comma (,) or hyphen (-) for a range. For example, enter "3-5" for ports 3, 4, and 5. Enter "3,5,7" for ports 3, 5, and 7.
Flush	Click Flush to remove the ARP entries according to the condition you specified.
Cancel	Click Cancel to return the fields to the factory defaults.
Index	This is the ARP table entry number.
IP Address	This is the IP address of a device connected to a Switch port with the corresponding MAC address below.
MAC Address	This is the MAC address of the device with the corresponding IP address above.
VID	This field displays the VLAN to which the device belongs.
Port	This field displays the port to which the device connects. CPU means this IP address is the Switch's management IP address. In stacking mode, the first number represents the slot and the second the port number.
Age(s)	This field displays how long (in seconds) an entry can still remain in the ARP table before it ages out and needs to be relearned. This shows 0 for a static entry.
Type	This shows whether the IP address is dynamic (learned by the Switch) or static (manually configured in SYSTEM > IP Setup > IP Setup or NETWORKING > ARP Setup > Static ARP).

CHAPTER 10

IP Table

This chapter introduces the **IP table** screen.

10.1 IP Table Overview

The **IP Table** screen shows how packets are forwarded or filtered across the Switch's ports. When a device (which may belong to a VLAN group) sends a packet which is forwarded to a port on the Switch, the IP address of the device is shown on the Switch's **IP Table**. The **IP Table** also shows whether the IP address is dynamic (learned by the Switch) or static (belonging to the Switch).

The Switch uses the **IP Table** to determine how to forward packets. See the following figure.

- 1 The Switch examines a received packet and learns the port from which this source IP address came.
- 2 The Switch checks to see if the packet's destination IP address matches a source IP address already learned in the **IP Table**.
 - If the Switch has already learned the port for this IP address, then it forwards the packet to that port.
 - If the Switch has not already learned the port for this IP address, then the packet is flooded to all ports. Too much port flooding leads to network congestion then the Switch sends an ARP to request the MAC address. The Switch then learns the port that replies with the MAC address.
 - If the Switch has already learned the port for this IP address, but the destination port is the same as the port it came in on, then it filters the packet.

Figure 84 IP Table Flowchart

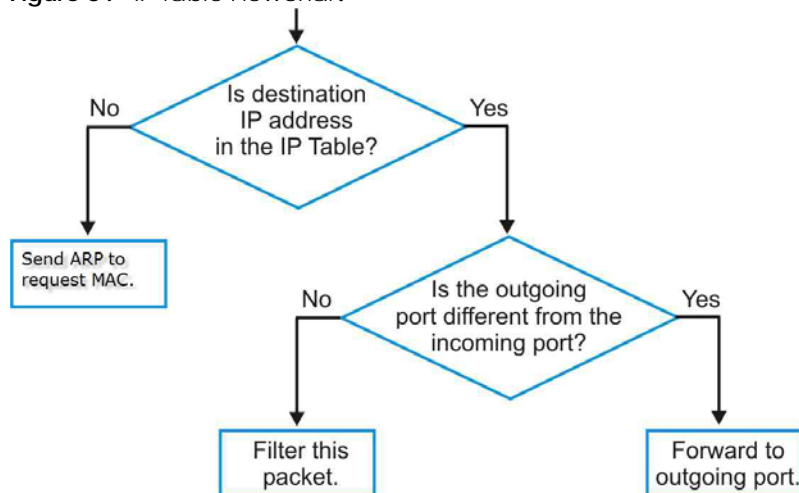

10.2 Viewing the IP Table

Click **MONITOR > IP Table** in the navigation panel to display the following screen.

Figure 85 MONITOR > IP Table

Index	IP Address	VID	Port	Type
1	192.168.2.1	1	22	Dynamic
2	192.168.2.115	1	CPU	Static
3	192.168.2.241	1	18	Dynamic
4	192.168.3.115	100	CPU	Static

Sorting by:

The following table describes the labels in this screen.

Table 35 MONITOR > IP Table

LABEL	DESCRIPTION
Index	This field displays the index number.
IP Address	This is the IP address of the device from which the incoming packets came.
VID	This is the VLAN group to which the packet belongs.
Port	This is the port from which the above IP address was learned. This field displays CPU to indicate the IP address belongs to the Switch. In stacking mode, the first number represents the slot and the second the port number.
Type	This shows whether the IP address is Dynamic (learned by the Switch) or Static (belonging to the Switch).
Sorting by	Click one of the following buttons to display and arrange the data according to that button type. The result is then displayed in the IP table.
IP	Click this button to display and arrange the data according to IP address.
VID	Click this button to display and arrange the data according to VLAN group.
Port	Click this button to display and arrange the data according to port number.

CHAPTER 11

IPv6 Neighbor Table

11.1 IPv6 Neighbor Table Overview

This chapter introduces the IPv6 neighbor table.

An IPv6 host is required to have a neighbor table. If there is an address to be resolved or verified, the Switch sends out a neighbor solicitation message. When the Switch receives a neighbor advertisement in response, it stores the neighbor's link-layer address in the neighbor table. You can also manually create a static IPv6 neighbor entry using the **SYSTEM > IPv6 > IPv6 Neighbor Setup** screen.

When the Switch needs to send a packet, it first consults other table to determine the next hop. Once the next hop IPv6 address is known, the Switch looks into the neighbor table to get the link-layer address and sends the packet when the neighbor is reachable. If the Switch cannot find an entry in the neighbor table or the state for the neighbor is not reachable, it starts the address resolution process. This helps reduce the number of IPv6 solicitation and advertisement messages.

11.2 Viewing the IPv6 Neighbor Table

Use this screen to view IPv6 neighbor information on the Switch. Click **MONITOR > IPv6 Neighbor Table** in the navigation panel to display the screen as shown.

Figure 86 MONITOR > IPv6 Neighbor Table

Index	Address	MAC	Status	Type	Interface

Sorting by: **Address** **MAC** **Interface**

The following table describes the labels in this screen.

Table 36 MONITOR > IPv6 Neighbor Table

LABEL	DESCRIPTION
Index	This field displays the index number of each entry in the table.
Address	This field displays the IPv6 address of the Switch or a neighboring device.
MAC	This field displays the MAC address of the IPv6 interface on which the IPv6 address is configured or the MAC address of the neighboring device.

Table 36 MONITOR > IPv6 Neighbor Table (continued)

LABEL	DESCRIPTION
Status	<p>This field displays whether the neighbor IPv6 interface is reachable. In IPv6, "reachable" means an IPv6 packet can be correctly forwarded to a neighbor node (host or router) and the neighbor can successfully receive and handle the packet. The available options in this field are:</p> <ul style="list-style-type: none"> • reachable (R): The interface of the neighboring device is reachable. (The Switch has received a response to the initial request.) • stale (S): The last reachable time has expired and the Switch is waiting for a response to another initial request. The field displays this also when the Switch receives an unrequested response from the neighbor's interface. • delay (D): The neighboring interface is no longer known to be reachable, and traffic has been sent to the neighbor recently. The Switch delays sending request packets for a short to give upper-layer protocols a chance to determine reachability. • probe (P): The Switch is sending request packets and waiting for the neighbor's response. • invalid (IV): The neighbor address is with an invalid IPv6 address. • unknown (?): The status of the neighboring interface cannot be determined for some reason. • incomplete (I): Address resolution is in progress and the link-layer address of the neighbor has not yet been determined. The interface of the neighboring device did not give a complete response.
Type	<p>This field displays the type of an address mapping to a neighbor interface. The available options in this field are:</p> <ul style="list-style-type: none"> • other (O): none of the following type. • local (L): A Switch interface is using the address. • dynamic (D): The IP address to MAC address can be successfully resolved using IPv6 Neighbor Discovery protocol. Is it similar as IPv4 ARP (Address Resolution protocol). • static (S): The interface address is statically configured.
Interface	<p>This field displays the ID number of the IPv6 interface on which the IPv6 address is created or through which the neighboring device can be reached.</p>
Sorting by	<p>Click one of the following buttons to display and arrange the data according to that button type. The result is then displayed in the summary table above.</p>
Address	<p>Click this button to display and arrange the data according to IPv6 address.</p>
MAC	<p>Click this button to display and arrange the data according to MAC address.</p>
Interface	<p>Click this button to display and arrange the data according to IPv6 interface.</p>

CHAPTER 12

MAC Table

12.1 MAC Table Overview

This chapter introduces the **MAC Table** screen.

The **MAC Table** screen (a MAC table is also known as a filtering database) shows how frames are forwarded or filtered across the Switch's ports. It shows what device MAC address, belonging to what VLAN group (if any) is forwarded to which ports and whether the MAC address is dynamic (learned by the Switch) or static (manually entered in the **SWITCHING > Static MAC Forwarding** screen).

12.1.1 What You Can Do

Use the **MAC Table** screen ([Section 12.2 on page 131](#)) to check whether the MAC address is dynamic or static.

12.1.2 What You Need to Know

The Switch uses the **MAC Table** to determine how to forward frames. See the following figure.

- 1 The Switch examines a received frame and learns the port on which this source MAC address came.
- 2 The Switch checks to see if the frame's destination MAC address matches a source MAC address already learned in the **MAC Table**.
 - If the Switch has already learned the port for this MAC address, then it forwards the frame to that port.
 - If the Switch has not already learned the port for this MAC address, then the frame is flooded to all ports. Too much port flooding leads to network congestion, then the Switch sends an ARP to request the MAC address. The Switch then learns the port that replies with the MAC address.
 - If the Switch has already learned the port for this MAC address, but the destination port is the same as the port it came in on, then it filters the frame.

Figure 87 MAC Table Flowchart

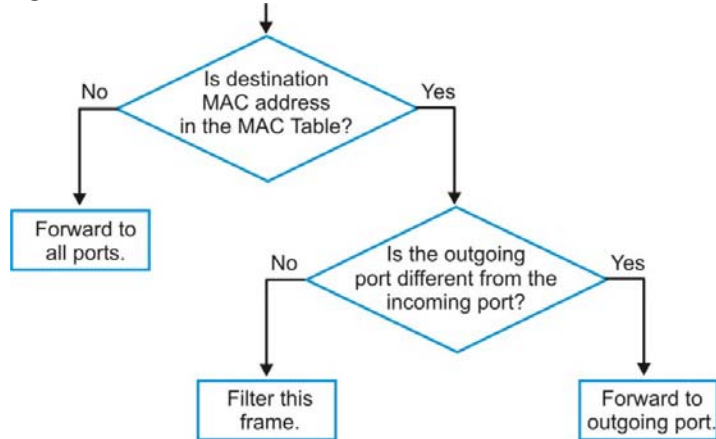

12.2 Viewing the MAC Table

Use this screen to search specific MAC addresses. You can also directly add dynamic MAC addresses into the static MAC forwarding table or MAC filtering table from the MAC table using this screen.

Click **MONITOR > MAC Table** in the navigation panel to display the following screen.

Figure 88 MONITOR > MAC Table

The screenshot shows the "MAC Table" configuration interface. It includes a "Condition" section with radio buttons for "All" (selected), "Static", "MAC", "VID", "Port", and "Trunk", each with an associated input field. The "Sort by" dropdown is set to "MAC". The "Type Transfer" section has radio buttons for "Dynamic to MAC forwarding" (selected) and "Dynamic to MAC filtering". At the bottom, there are "Search", "Transfer", and "Cancel" buttons. Below the buttons is a table with the following headers:

Index	MAC Address	VID	Port	Type

The following table describes the labels in this screen.

Table 37 MONITOR > MAC Table

LABEL	DESCRIPTION
Condition	<p>Select one of the below search conditions and click Search to only display the data which matches the criteria you specified.</p> <p>Select All to display any entry in the MAC table of the Switch.</p> <p>Select Static to display the MAC entries manually configured on the Switch.</p> <p>Select MAC and enter a MAC address in the field provided to display a specified MAC entry.</p> <p>Select VID and enter a VLAN ID in the field provided to display the MAC entries belonging to the specified VLAN.</p> <p>Select Port and enter a port number in the field provided to display the MAC addresses which are forwarded on the specified port.</p> <p>Select Trunk and type the ID of a trunk group to display all MAC addresses learned from the ports in the trunk group.</p>
Sort by	<p>Define how the Switch displays and arranges the data in the summary table below.</p> <p>Select MAC to display and arrange the data according to MAC address.</p> <p>Select VID to display and arrange the data according to VLAN group.</p> <p>Select PORT to display and arrange the data according to port number.</p>
Type Transfer	<p>Select Dynamic to MAC forwarding and click the Transfer button to change all dynamically learned MAC address entries in the summary table below into static entries. They also display in the SWITCHING > Static MAC Forwarding screen.</p> <p>Select Dynamic to MAC filtering and click the Transfer button to change all dynamically learned MAC address entries in the summary table below into MAC filtering entries. These entries will then display only in the SWITCHING > Static MAC Filtering screen and the default filtering action is Discard source.</p>
Search	Click this to search data in the MAC table according to your input criteria.
Transfer	Click this to perform the MAC address transferring you selected in the Type Transfer field.
Cancel	Click Cancel to change the fields back to their last saved values.
Index	This is the incoming frame index number.
MAC Address	This is the MAC address of the device from which this incoming frame came.
VID	This is the VLAN group to which this frame belongs.
Port	This is the port from which the above MAC address was learned. In Stacking mode, the first number represents the slot and the second the port number.
Type	This shows whether the MAC address is Dynamic (learned by the Switch) or Static (manually entered in the SWITCHING > Static MAC Forwarding screen).

CHAPTER 13

Neighbor

13.1 Neighbor Overview

The **Neighbor** screen allows you to view a summary and manage the Switch's neighboring devices. It uses Layer Link Discovery Protocol (LLDP) to discover all neighbor devices connected to the Switch including non-Zyxel devices. You can use this screen to perform tasks on the neighboring devices like login, power cycle (turn the power off and then back on again), and reset to factory default settings.

This screen shows the neighboring device first recognized on an Ethernet port of the Switch. Device information is displayed in gray when the neighboring device is offline.

13.1.1 What You Can Do

Use the **Neighbor** screen ([Section 13.2 on page 133](#)) to view a summary and manage the Switch's neighbor devices.

Use the **Neighbor Details** screen ([Section 13.2.1 on page 135](#)) to view more detailed information on the Switch's neighbor devices.

13.2 Neighbor

Click **MONITOR > Neighbor** to see the following screen.

Figure 89 MONITOR > Neighbor > Neighbor (Standalone Mode, example PoE model)

Port	Port Name	PD Health	Link	PoE Draw(W)	System Name	IPv4	IPv6	Action
1		--	Down	0.0	--			Reset Restore
2		--	1G/F	0.0	12A3_84	0.0.0.0	--	Reset Restore
3		--	Down	0.0	--			Reset Restore
4		--	1G/F	0.0	--	--	--	Reset Restore
5		--	Down	0.0	--			Reset Restore
6		--	1G/F	0.0	--	--	--	Reset Restore
7		--	Down	0.0	--			Reset Restore
8		--	Down	0.0	--			Reset Restore
9		--	Down	0.0	--			Reset Restore

Figure 90 MONITOR > Neighbor > Neighbor (Stacking Mode, example PoE model)

Port	Port Name	PD Health	Link	PoE Draw(W)	System Name	IPv4	IPv6	Action
1/1		--	Down	0.0	--			Reset Restore
1/2		--	1G/F	0.0	XMG1915	172.21.56.39	--	Reset Restore
1/3		--	Down	0.0	--			Reset Restore
1/4		--	Down	0.0	--			Reset Restore
1/5		--	Down	0.0	--			Reset Restore
1/6		--	Down	0.0	--			Reset Restore
1/7		--	Down	0.0	--			Reset Restore
1/8		--	Down	0.0	--			Reset Restore
1/9		--	Down	0.0	--			Reset Restore
1/10		--	Down	0.0	--			Reset Restore

The following table describes the fields in the above screen.

Table 38 MONITOR > Neighbor > Neighbor

LABEL	DESCRIPTION
SLOT	This field appears only in Stacking mode. Click the drop-down list to choose the slot number of the Switch in a stack.
Port	This shows the port of the Switch, on which the neighboring device is discovered. In Stacking mode, the first number represents the slot ID and the second is the port number. Please note that the default stacking ports (the last four ports of your Switch) cannot be configured. They are reserved for stacking only.
Port Name	This shows the port description of the Switch.
PD Health	For PoE models. This shows the status of auto PD recovery on this port. <ul style="list-style-type: none"> Red: The Switch failed to get information from the PD connected to the port using LLDP, or the connected PD did not respond to the Switch's ping requests. Yellow: The Switch is restarting the connected PD by turning the power off and turning it on again. Green: The Switch successfully discovered the connected PD using LLDP or ping. --: Auto PD Recovery is not enabled on the Switch and the port, or the Switch does not supply power to the connected PD. <p>Note: The status will NOT be updated instantaneously after enabling or disabling the Active switch in the Port > Auto PD Recovery screen. It will wait until the configured Resume Polling Interval (sec) has lapsed.</p>
Link	This shows the speed (either 10M for 10 Mbps, 100M for 100 Mbps, 1G for 1 Gbps, 2.5G for 2.5 Gbps, 5G for 5 Gbps, or 10G for 10 Gbps) and the duplex (F for full duplex or H for half). This field displays Down if the port is not connected to any device.
PoE Draw (W)	For PoE models. This shows the consumption that the neighboring device connected to this port draws from the Switch. This allows you to plan and use within the power budget of the Switch.
System Name	This shows the system name of the neighbor device.
IPv4	This shows the IPv4 address of the neighbor device. The IPv4 address is a hyper link that you can click to log into and manage the neighbor device through its Web Configurator.

Table 38 MONITOR > Neighbor > Neighbor (continued)

LABEL	DESCRIPTION
IPv6	This shows the IPv6 address of the neighbor device. The IPv6 address is a hyper link that you can click to log into and manage the neighbor device through its Web Configurator.
Action	<p>For PoE models.</p> <p>Click the Reset button to turn OFF the power of the neighbor device and turn it back ON again. A count down button (from 5 to 0) starts.</p> <p>Note: The Switch must support power sourcing (PSE) or the network device is a powered device (PD).</p> <p>Click the Restore button to restore the neighboring device to its factory default settings. A warning message "Are you sure you want to load factory default?" appears prompting you to confirm the action. After confirming the action a count down button (from 5 to 0) starts.</p> <p>Note:</p> <ul style="list-style-type: none"> • The Switch must support power sourcing (PSE) or the network device is a powered device (PD). • If multiple neighbor devices use the same port, the Reset button is not available. • You can only reset Zyxel powered devices that support the ZON utility.

13.2.1 Neighbor Details

Use this screen to view detailed information about the neighboring devices. Device information is displayed in gray when the neighboring device is currently offline.

Up to 10 neighboring device records per Ethernet port can be retained in this screen even when the devices are offline. When the maximum number of neighboring device records per Ethernet port is reached, new device records automatically overwrite existing offline device records, starting with the oldest existing offline device record first.

Click **MONITOR > Neighbor > Neighbor Details** to see the following screen.

Figure 91 MONITOR > Neighbor > Neighbor Details (Standalone Mode, example PoE model)

Neighbor Neighbor Details

Search Ports...

+ Port 1

- Port 2

Desc.: --	PD Health: --	Link Speed: 1G/F	PoE Draw: 0.0
-----------	---------------	------------------	---------------

Remote

System Name: 12A3_84	Port Bridge: 39	Model: XGS3700-48	MAC: E4-18-68-F7-8A-0D	Firmware: V4.30(AAGE.2)_20200930 09/30/2020	<input type="button" value="Restore"/>
Location: HQ2_R102	Desc.: --	IPv4: 0.0.0.0	IPv6: --		

+ Port 3

- Port 4

Desc.: --	PD Health: --	Link Speed: 1G/F	PoE Draw: 0.0
-----------	---------------	------------------	---------------

Remote

System Name: --	Port Bridge: dc:4a:3e:40:ec:5f	Model: --	MAC: dc:4a:3e:40:ec:5f	Firmware: --	<input type="button" value="Restore"/>
Location: --	Desc.: --	IPv4: --	IPv6: --		

+ Port 5

Figure 92 MONITOR > Neighbor > Neighbor Details (Stacking Mode, example PoE model)

Neighbor Neighbor Details

Search Ports...

SLOT 1

+ Port 1/1

- Port 1/2

Desc.: --	PD Health: --	Link Speed: 1G/F	PoE Draw: 0.0
-----------	---------------	------------------	---------------

Remote

System Name: XMG1915	Port Bridge: 16	Model: XMG1915-18EP	MAC: 00-19-CB-00-00-01	Firmware: V4.80(ACGQ.0)b3 05/04/2023	<input type="button" value="Restore"/>
Location: --	Desc.: --	IPv4: 172.21.56.39	IPv6: --		
System Name: XMG1915	Port Bridge: 8	Model: XMG1915-18EP	MAC: 00-19-CB-00-00-01	Firmware: V4.80(ACGQ.0)b3 05/04/2023	<input type="button" value="Restore"/>
Location: --	Desc.: --	IPv4: 172.21.56.39	IPv6: --		

+ Port 1/3

+ Port 1/4

+ Port 1/5

+ Port 1/6

+ Port 1/7

+ Port 1/8

+ Port 1/9

The following table describes the fields in the above screen.

Table 39 MONITOR > Neighbor > Neighbor Details

LABEL	DESCRIPTION
Search Ports...	<p>Enter the port number to search and display the ports you specified. The result will display in the below list.</p> <p>You can enter multiple ports separated by comma (",") or hyphen ("-") for a range. For example, enter "3-5" for ports 3, 4, and 5. Enter "3,5,7" for ports 3, 5, and 7.</p> <p>In Stacking mode, the first number represents the slot and the second the port number. Enter "1/1-1/24,2/23" for ports 1 to 24 for the Switch in slot 1 and port 23 for the Switch in slot 2, for example.</p>
SLOT	This field appears only in Stacking mode. Click the drop-down list to choose the slot number of the Switch in a stack.
Port	This shows the port of the Switch, on which the neighboring device is discovered.
Desc.	This shows the port description of the Switch.
PD Health	<p>For PoE models.</p> <p>This shows the status of auto PD recovery on this port.</p> <ul style="list-style-type: none"> • Red: The Switch failed to get information from the PD connected to the port using LLDP, or the connected PD did not respond to the Switch's ping requests. • Yellow: The Switch is restarting the connected PD by turning the power off and turning it on again. • Green: The Switch successfully discovered the connected PD using LLDP or ping. • -: Auto PD Recovery is not enabled on the Switch and the port, or the Switch does not supply power to the connected PD.
Link Speed	This shows the speed (either 10M for 10 Mbps, 100M for 100 Mbps, 1G for 1 Gbps, 2.5G for 2.5 Gbps, 5G for 5 Gbps, or 10G for 10 Gbps) and the duplex (F for full duplex or H for half). This field displays Down if the port is not connected to any device.
PoE Draw (W)	<p>For PoE models.</p> <p>This shows the consumption that the neighboring device connected to this port draws from the Switch. This allows you to plan and use within the power budget of the Switch.</p>
Reset	<p>Click this button to turn OFF the power of the neighbor device and turn it back ON again. A count down button (from 5 to 0) starts.</p> <p>Note: The Switch must support power sourcing (PSE) or the network device is a powered device (PD).</p>
Remote	
System Name	This shows the system name of the neighbor device.
Port Bridge	This shows the neighboring device's MAC address or the port number connected to the Switch.
Model	This shows the model name of the neighbor device. This field will show "-" for devices that do not support the ZON utility.
MAC	This shows the MAC address of the neighbor device.
Firmware	This shows the firmware version of the neighbor device. This field will show "-" for devices that do not support the ZON utility.
Location	This shows the geographic location of the neighbor device. This field will show "-" for devices that do not support the ZON utility.
Desc.	This shows the description of the neighbor device's port which is connected to the Switch.
IPv4	This shows the IPv4 address of the neighbor device. The IPv4 address is a hyper link that you can click to log into and manage the neighbor device through its Web Configurator.

Table 39 MONITOR > Neighbor > Neighbor Details (continued)

LABEL	DESCRIPTION
IPv6	This shows the IPv6 address of the neighbor device. The IPv6 address is a hyper link that you can click to log into and manage the neighbor device through its Web Configurator.
Restore	<p>Click this button to restore the neighbor device to its factory default settings. A warning message "Are you sure you want to load factory default?" appears prompting you to confirm the action. After confirming the action a count down button (from 5 to 0) starts.</p> <p>Note:</p> <ul style="list-style-type: none"> • The Switch must support power sourcing (PSE) or the network device is a powered device (PD). • If multiple neighbor devices use the same port, the Reset button is not available. • You can only reset Zyxel powered devices that support the ZON utility.
Flush	Click the Flush button on the port tab to remove information about neighbors learned on a specific ports.
Flush All	Click the Flush All button to remove information about neighbors learned on all ports.

CHAPTER 14

Path MTU Table

14.1 Path MTU Overview

This chapter introduces the IPv6 Path MTU table.

The largest size (in bytes) of a packet that can be transferred over a data link is called the Maximum Transmission Unit (MTU). The Switch uses Path MTU Discovery to discover Path MTU (PMTU), that is, the minimum link MTU of all the links in a path to the destination. If the Switch receives an ICMPv6 Packet Too Big error message after sending a packet, it fragments the next packet according to the suggested MTU in the error message.

14.2 Viewing the Path MTU Table

Use this screen to view IPv6 path MTU information on the Switch. Click **MONITOR > Path MTU Table** in the navigation panel to display the screen as shown.

Figure 93 MONITOR > Path MTU Table

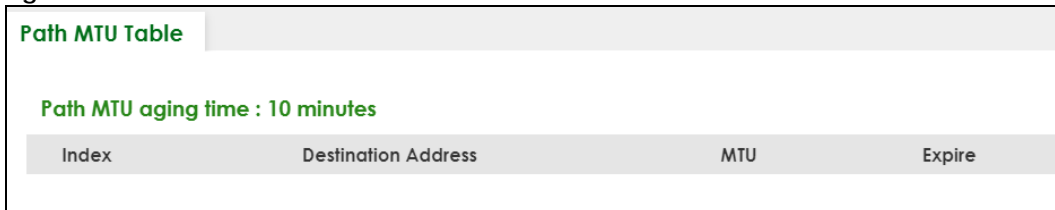

Index	Destination Address	MTU	Expire
-------	---------------------	-----	--------

The following table describes the labels in this screen.

Table 40 MONITOR > Path MTU Table

LABEL	DESCRIPTION
Path MTU aging time	This field displays how long an entry remains in the Path MTU table before it ages out and needs to be relearned.
Index	This field displays the index number of each entry in the table.
Destination Address	This field displays the destination IPv6 address of each path or entry.
MTU	This field displays the maximum transmission unit of the links in the path.
Expire	This field displays how long (in minutes) an entry can still remain in the Path MTU table before it ages out and needs to be relearned.

CHAPTER 15

Port Status

This chapter introduces the **Port Status** screens.

15.0.1 What You Can Do

Use the **Port Status** screen (Section 15.1 on page 140) to view the port status of the Switch.

Use the **DDMI** screen (Section 15.2 on page 144) to view the DDMI (Digital Diagnostics Monitoring Interface) status of the SFP transceivers on the Switch.

Use the **Port Utilization** screen (Section 15.3 on page 147) to view the current data rate and utilization percentage of each port on the Switch.

15.1 Port Status

This screen displays a port statistical summary with links to each port showing statistical details. To view the port statistics, click **MONITOR > Port Status** to display the **Port Status** screen as shown next. You can also click the **Port Status** link in the **Quick Link** section of the **DASHBOARD** screen to see the following screen.

Figure 94 MONITOR > Port Status > Port Status (Standalone Mode)

Port Status											
Port	Name	Link	State	PD	LACP	TxPkts	RxPkts	Errors	Tx kB/s	Rx kB/s	Up Time
1		Down	STOP	Off	Disabled	0	0	0	0.0	0.0	0:00:00
2		1G/F	FORWARDING	Off	Disabled	200558	339071	0	0.194	2.800	1:45:03
3		Down	STOP	Off	Disabled	0	0	0	0.0	0.0	0:00:00
4		Down	STOP	Off	Disabled	0	0	0	0.0	0.0	0:00:00
5		Down	STOP	Off	Disabled	0	0	0	0.0	0.0	0:00:00
6		1G/F	FORWARDING	Off	Disabled	334799	197102	0	0.383	1.220	1:44:53
7		Down	STOP	Off	Disabled	0	0	0	0.0	0.0	0:00:00
8		Down	STOP	Off	Disabled	0	0	0	0.0	0.0	0:00:00
9		Down	STOP	Off	Disabled	0	0	0	0.0	0.0	0:00:00
10		Down	STOP	Off	Disabled	0	0	0	0.0	0.0	0:00:00

Clear the counter: All Ports Port

Figure 95 MONITOR > Port Status > Port Status (Stacking Mode)

Port Status											
DDMI Port Utilization											
SLOT 1 ▾											
Port	Name	Link	State	PD	LACP	TxPkts	RxPkts	Errors	Tx kB/s	Rx kB/s	Up Time
1/1		Down	STOP	Off	Disabled	0	0	0	0.0	0.0	0:00:00
1/2		1G/F	FORWARDING	Off	Disabled	4338	19375	0	0.82	1.145	0:40:34
1/3		Down	STOP	Off	Disabled	0	0	0	0.0	0.0	0:00:00
1/4		Down	STOP	Off	Disabled	0	0	0	0.0	0.0	0:00:00
1/5		Down	STOP	Off	Disabled	0	0	0	0.0	0.0	0:00:00
1/6		Down	STOP	Off	Disabled	0	0	0	0.0	0.0	0:00:00
1/7		Down	STOP	Off	Disabled	0	0	0	0.0	0.0	0:00:00
1/8		Down	STOP	Off	Disabled	0	0	0	0.0	0.0	0:00:00
1/9		Down	STOP	Off	Disabled	0	0	0	0.0	0.0	0:00:00
1/10		Down	STOP	Off	Disabled	0	0	0	0.0	0.0	0:00:00
1/11		Down	STOP	Off	Disabled	0	0	0	0.0	0.0	0:00:00

Clear the counter: All Ports Port

The following table describes the labels in this screen.

Table 41 MONITOR > Port Status > Port Status

LABEL	DESCRIPTION
SLOT	This field appears only in Stacking mode. Click the drop-down list to choose the slot number of the Switch in a stack.
Port	This identifies the Ethernet port. In Stacking mode, the first number represents the slot ID and the second is the port number. Please note that the default stacking ports (the last two ports of your Switch) cannot be configured. They are reserved for stacking only. Click a port number to display the Port Details screen.
Name	This is the name you assigned to this port in the PORT > Port Setup screen.
Link	This field displays the speed (either 100M for 100 Mbps, 1G for 1 Gbps, 2.5G for 2.5 Gbps, 5G for 5 Gbps, or 10G for 10 Gbps) and the duplex (F for full duplex or H for half). It also shows the cable type (Copper or Fiber) for the combo ports. This field displays Down if the port is not connected to any device.
State	If STP (Spanning Tree Protocol) is enabled, this field displays the STP state of the port. If STP is disabled, this field displays FORWARDING if the link is up, otherwise, it displays STOP . When LACP (Link Aggregation Control Protocol) and STP are in blocking state, it displays BLOCKING .
PD	For PoE models only. This field displays whether or not a powered device (PD) is allowed to receive power from the Switch on this port.
LACP	This field displays whether LACP (Link Aggregation Control Protocol) has been enabled on the port.
TxPkts	This field shows the number of transmitted frames on this port.
RxPkts	This field shows the number of received frames on this port.
Errors	This field shows the number of received errors on this port.
Tx kB/s	This field shows the number of kilobytes per second transmitted on this port.
Rx kB/s	This field shows the number of kilobytes per second received on this port.

Table 41 MONITOR > Port Status > Port Status (continued)

LABEL	DESCRIPTION
Up Time	This field shows the total amount of time in hours, minutes and seconds the port has been up.
Clear the counter	Select Port , enter a port number and then click Clear Counter to erase the recorded statistical information for that port, or select ALL Ports to clear statistics for all ports. In Stacking mode, selecting ALL Ports clears statistics for all ports on this slot.

15.1.1 Port Details

Click an index in the **Port** column in the **MONITOR > Port Status > Port Status** screen to display individual port statistics. Use this screen to check status and detailed performance data about an individual port on the Switch.

Figure 96 MONITOR > Port Status > Port Status > Port Details

Port Status		DDMI		Port Utilization	
Port Status > Port Details					
Port Info			TX Packet		
Port NO.	2	Unicast		218648	
Name		Multicast		1113	
Link	1G/F	Broadcast		127	
State	FORWARDING	Pause		0	
LACP	Disabled	RX Packet			
TxPkts	219888	Unicast		297357	
RxPkts	383699	Multicast		57130	
Errors	0	Broadcast		29212	
Tx kB/s	1.330	Pause		0	
Tx Utilization%	0.0	TX Collision			
Rx kB/s	0.548	Single		0	
Rx Utilization%	0.0	Multiple		0	
Up Time	2:11:10	Excessive		0	
		Late		0	
Error Packet			Distribution		
RX CRC	0	64		173139	
Length	0	65 to 127		84669	
Runt	0	128 to 255		151095	
		256 to 511		25133	
		512 to 1023		11039	
		1024 to 1518		158512	
		Giant		0	

The following table describes the labels in this screen.

Table 42 MONITOR > Port Status > Port Status > Port Details

LABEL	DESCRIPTION
Port Info	
Port NO.	This field displays the port number you are viewing. In Stacking mode, the first number represents the slot and the second the port number.

Table 42 MONITOR > Port Status > Port Status > Port Details (continued)

LABEL	DESCRIPTION
Name	This field displays the name of the port.
Link	This field displays the speed (either 100M for 100Mbps, 1G for 1 Gbps, 2.5G for 2.5 Gbps, 5G for 5 Gbps, or 10G for 10 Gbps) and the duplex (F for full duplex or H for half). It also shows the cable type (Copper or Fiber) for the combo ports. This field displays Down if the port is not connected to any device.
State	If STP (Spanning Tree Protocol) is enabled, this field displays the STP state of the port. If STP is disabled, this field displays FORWARDING if the link is up, otherwise, it displays STOP . When LACP (Link Aggregation Control Protocol), STP, and dot1x are in blocking state, it displays BLOCKING .
LACP	This field shows if LACP is enabled on this port or not.
TxPkts	This field shows the number of transmitted frames on this port.
RxPkts	This field shows the number of received frames on this port.
Errors	This field shows the number of received errors on this port.
Tx kB/s	This field shows the number of kilobytes per second transmitted on this port.
Tx Utilization%	This field shows the percentage of actual transmitted frames on this port as a percentage of the Link speed.
Rx kB/s	This field shows the number of kilobytes per second received on this port.
Rx Utilization%	This field shows the percentage of actual received frames on this port as a percentage of the Link speed.
Up Time	This field shows the total amount of time the connection has been up.
TX Packet	
The following fields display detailed information about packets transmitted.	
Unicast	This field shows the number of good unicast packets transmitted.
Multicast	This field shows the number of good Multicast packets transmitted.
Broadcast	This field shows the number of good broadcast packets transmitted.
Pause	This field shows the number of 802.3x pause packets transmitted.
RX Packet	
The following fields display detailed information about packets received.	
Unicast	This field shows the number of good unicast packets received.
Multicast	This field shows the number of good Multicast packets received.
Broadcast	This field shows the number of good broadcast packets received.
Pause	This field shows the number of 802.3x pause packets received.
TX Collision	
The following fields display information on collisions while transmitting.	
Single	This is a count of successfully transmitted packets for which transmission is inhibited by exactly one collision.
Multiple	This is a count of successfully transmitted packets for which transmission was inhibited by more than one collision.
Excessive	This is a count of packets for which transmission failed due to excessive collisions. Excessive collision is defined as the number of maximum collisions before the retransmission count is reset.
Late	This is the number of times a late collision is detected, that is, after 512 bits of the packets have already been transmitted.

Table 42 MONITOR > Port Status > Port Status > Port Details (continued)

LABEL	DESCRIPTION
Error Packet	The following fields display detailed information about packets received that were in error.
RX CRC	This field shows the number of packets received with CRC (Cyclic Redundant Check) errors.
Length	This field shows the number of packets received with a length that was out of range.
Runt	This field shows the number of packets received that were too short (shorter than 64 octets), including the ones with CRC errors.
Distribution	
64	This field shows the number of packets (including bad packets) received that were 64 octets in length.
65 to 127	This field shows the number of packets (including bad packets) received that were between 65 and 127 octets in length.
128 to 255	This field shows the number of packets (including bad packets) received that were between 128 and 255 octets in length.
256 to 511	This field shows the number of packets (including bad packets) received that were between 256 and 511 octets in length.
512 to 1023	This field shows the number of packets (including bad packets) received that were between 512 and 1023 octets in length.
1024 to 1518	This field shows the number of packets (including bad packets) received that were between 1024 and 1518 octets in length.
Giant	This field shows the number of packets (including bad packets) received that were between 1519 octets and the maximum frame size. The maximum frame size varies depending on your switch model.

15.2 DDMI

The optical SFP transceiver's support for the Digital Diagnostics Monitoring Interface (DDMI) function lets you monitor the transceiver's parameters to perform component monitoring, fault isolation and failure prediction tasks. This allows proactive, preventative network maintenance to help ensure service continuity.

Use this screen to view the DDMI status of the Switch's SFP transceivers. Click **MONITOR > Port Status > DDMI** to see the following screen. Alternatively, click **DASHBOARD** from any Web Configurator screen and then the **Port Status** link in the **Quick Link** section of the **DASHBOARD** screen to display the **Port Status** screen and then click the **DDMI** link tab.

Figure 97 MONITOR > Port Status > DDMI (Standalone Mode)





Port	Vendor	Part Number	Serial Number	Revision	Date Code	Transceiver	Action
6	FINISAR	FTLX8571D3BCL	AMB0PVY	A	2012-54-19	10GBASE-SR	 Reset
28	FINISAR	FTLX8571D3BCL	AM51JQM	A	2012-02-06	10GBASE-SR	 Reset

Figure 98 MONITOR > Port Status > DDMI (Stacking Mode)

Port	Vendor	Part Number	Serial Number	Revision	Date Code	Transceiver	Action
1/6	FINISAR	FTLX8571D3BCL	AMB0PVY	A	2012-54-19	10GBASE-SR	 Reset
1/10	FINISAR	FTLX8571D3BCL	AM51JQM	A	2012-02-06	10GBASE-SR	 Reset

The following table describes the labels in this screen.

Table 43 MONITOR > Port Status > DDMI

LABEL	DESCRIPTION
SLOT	This field appears only in Stacking mode. Click the drop-down list to choose the slot number of the Switch in a stack.
Port	This identifies the SFP port. In Stacking mode, the first number represents the slot ID and the second is the port number. Please note that the default stacking ports (the last four ports of your Switch) cannot be configured. They are reserved for stacking only. Click a port number to display the DDMI Details screen.
Vendor	This displays the vendor name of the optical transceiver.
Part Number	This displays the part number of the optical transceiver.
Serial Number	This displays the serial number of the optical transceiver.
Revision	This displays the revision number of the optical transceiver.
Date Code	This displays the date when the optical transceiver was manufactured.
Transceiver	This displays the type of optical transceiver installed in the SFP slot.
Action	Click Reset when your SFP port encounters connection errors. For example, it can receive but cannot transmit data. This Fiber Module Rescue function allows you to restart a fiber SFP transceiver that is in error state without having to remove and reinsert the transceiver. The Switch stops then re-supplies power on the specified SFP ports to restart it. After restarting an SFP port, go to MONITOR > Port Status > Port Status to check the SFP port status. You can also check the port LED on the Switch panel to see if the connection has recovered. Note: Make sure an optical transceiver is correctly inserted into the SFP port.

15.2.1 DDMI Details

Use this screen to view the real-time SFP (Small Form Factor Pluggable) transceiver information and operating parameters on the SFP port. The parameters include, for example, transmitting and receiving power, and module temperature.

Click an index in the **Port** column in the **DDMI** screen to view current transceivers' status.

Figure 99 MONITOR > Port Status > DDMI > DDMI Details

Port Status	DDMI	Port Utilization			
Transceiver Information					
Port No	16				
Connector Type	SFP				
Vendor	ZyXEL				
Part Number	SFP-1000T				
Serial Number	S111111111111				
Revision	1.0				
Date Code	2017-12-20				
Transceiver	1000BASE-T				
Calibration	Internal				
DDMI Information					
Type	Current	High Alarm Threshold	High Warn Threshold	Low Warn Threshold	Low Alarm Threshold
Temperature(C)	-	-	-	-	-
Voltage(V)	-	-	-	-	-
TX Bias(mA)	-	-	-	-	-
TX Power(dbm)	-	-	-	-	-
RX Power(dbm)	-	-	-	-	-

The following table describes the labels in this screen.

Table 44 MONITOR > Port Status > DDMI > DDMI Details

LABEL	DESCRIPTION
Transceiver Information	
Port No	This identifies the SFP port. In Stacking mode, the first number represents the slot and the second the port number.
Connector Type	This displays the connector type of the optical transceiver.
Vendor	This displays the vendor name of the optical transceiver.
Part Number	This displays the part number of the optical transceiver.
Serial Number	This displays the serial number of the optical transceiver.
Revision	This displays the revision number of the optical transceiver.
Date Code	This displays the date when the optical transceiver was manufactured.
Transceiver	This displays details about the type of transceiver installed in the SFP slot.
Calibration	This field is available only when an SFP transceiver is inserted into the SFP slot. Internal displays if the measurement values are calibrated by the transceiver. External displays if the measurement values are raw data which the Switch calibrates.
DDMI Information	
Type	This displays the DDMI parameter.
Temperature (C/F)	This displays the temperature inside the SFP transceiver in degrees Celsius or Fahrenheit.
Voltage (V)	This displays the level of voltage being supplied to the SFP transceiver.
TX Bias (mA)	This displays the milliamps (mA) being supplied to the SFP transceiver's Laser Diode Transmitter.

Table 44 MONITOR > Port Status > DDMI > DDMI Details (continued)

LABEL	DESCRIPTION
TX Power (dbm)	This displays the amount of power the SFP transceiver is transmitting.
RX Power (dbm)	This displays the amount of power the SFP transceiver is receiving from the fiber cable.
Current	This displays the current status for each monitored DDMI parameter.
High Alarm Threshold	This displays the high value alarm threshold for each monitored DDMI parameter. An alarm signal is reported to the Switch if the monitored DDMI parameter reaches this value.
High Warn Threshold	This displays the high value warning threshold for each monitored DDMI parameter. A warning signal is reported to the Switch if the monitored DDMI parameter reaches this value.
Low Warn Threshold	This displays the low value warning threshold for each monitored DDMI parameter. A warning signal is reported to the Switch if the monitored DDMI parameter reaches this value.
Low Alarm Threshold	This displays the low value alarm threshold for each monitored DDMI parameter. An alarm signal is reported to the Switch if the monitored DDMI parameter reaches this value.

15.3 Port Utilization

This screen displays the percentage of actual transmitted or received frames on a port as a percentage of the **Link** speed. To view port utilization, click **MONITOR > Port Status > Port Utilization** to see the following screen. Alternatively, click **DASHBOARD** from any Web Configurator screen and then the **Port Status** link in the **Quick Link** section of the **DASHBOARD** screen to display the **Port Status** screen and then click the **Port Utilization** link tab.

Figure 100 MONITOR > Port Status > Port Utilization (Standalone Mode)

Port	Link	Tx kB/s	Tx utilization%	Rx kB/s	Rx utilization%
1	Down	0.0	0.0	0.0	0.0
2	Down	0.0	0.0	0.0	0.0
3	Down	0.0	0.0	0.0	0.0
4	1G/F	0.824	0.0	0.347	0.0
5	Down	0.0	0.0	0.0	0.0
6	Down	0.0	0.0	0.0	0.0
7	Down	0.0	0.0	0.0	0.0

Figure 101 MONITOR > Port Status > Port Utilization (Stacking Mode)

Port Status	DDMI	Port Utilization			
SLOT 1 ▾					
Port	Link	Tx kB/s	Tx utilization%	Rx kB/s	Rx utilization%
1/1	Down	0.0	0.0	0.0	0.0
1/2	Down	0.0	0.0	0.0	0.0
1/3	Down	0.0	0.0	0.0	0.0
1/4	1G/F	1.15	0.0	0.109	0.0
1/5	Down	0.0	0.0	0.0	0.0
1/6	Down	0.0	0.0	0.0	0.0
1/7	Down	0.0	0.0	0.0	0.0

The following table describes the labels in this screen.

Table 45 MONITOR > Port Status > Port Utilization

LABEL	DESCRIPTION
SLOT	This field appears only in Stacking mode. Click the drop-down list to choose the slot number of the Switch in a stack.
Port	This identifies the Ethernet port. In Stacking mode, the first number represents the slot ID and the second is the port number.
Link	This field displays the speed (either 100M for 100Mbps, 1G for 1 Gbps, 2.5G for 2.5 Gbps, 5G for 5 Gbps, or 10G for 10 Gbps) and the duplex (F for full duplex or H for half). It also shows the cable type (Copper or Fiber) for the combo ports. This field displays Down if the port is not connected to any device.
Tx kB/s	This field shows the transmission speed of data sent on this port in kilobytes per second.
Tx Utilization%	This field shows the percentage of actual transmitted frames on this port as a percentage of the Link speed.
Rx kB/s	This field shows the transmission speed of data received on this port in kilobytes per second.
Rx Utilization%	This field shows the percentage of actual received frames on this port as a percentage of the Link speed.

CHAPTER 16

Routing Table

16.1 Routing Table Overview

This chapter introduces the IPv4/IPv6 routing tables.

The IPv4/IPv6 routing tables record routing information of the best path to destinations where packets were forwarded. Use this table to check information like routing destination, gateway, interface IP addresses, hop count, and routing methods.

16.1.1 What You Can Do

Use the **IPv4 Routing Table** screen ([Section 16.2 on page 149](#)) to view the Switch's IPv4 routing table information.

Use the **IPv6 Routing Table** screen ([Section 16.3 on page 150](#)) to view the Switch's IPv6 routing table information.

16.2 IPv4 Routing Table

Use this screen to view IPv4 routing table information. Click **MONITOR > Routing Table > IPv4 Routing Table** in the navigation panel to display the screen as shown.

Figure 102 MONITOR > Routing Table > IPv4 Routing Table

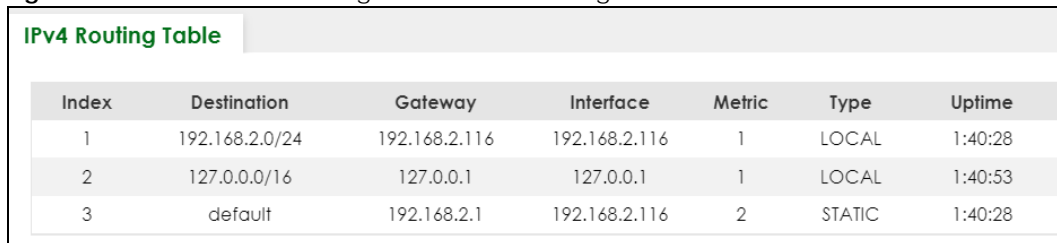

Index	Destination	Gateway	Interface	Metric	Type	Uptime
1	192.168.2.0/24	192.168.2.116	192.168.2.116	1	LOCAL	1:40:28
2	127.0.0.0/16	127.0.0.1	127.0.0.1	1	LOCAL	1:40:53
3	default	192.168.2.1	192.168.2.116	2	STATIC	1:40:28

The following table describes the labels in this screen.

Table 46 MONITOR > Routing Table > IPv4 Routing Table

LABEL	DESCRIPTION
Index	This field displays the index number.
Destination	This field displays the destination IP routing domain.
Gateway	This field displays the IP address of the gateway device.
Interface	This field displays the IP address of the IPv4 Interface.

Table 46 MONITOR > Routing Table > IPv4 Routing Table (continued)

LABEL	DESCRIPTION
Metric	This field displays the cost of the route.
Type	This field displays the method used to learn the route. STATIC – added as a static entry. LOCAL – added as a local interface entry.
Uptime	This field displays how long the route has been running since the Switch learned the route and added an entry in the routing table.

16.3 IPv6 Routing Table

Use this screen to view IPv6 routing table information. Click **MONITOR > Routing Table > IPv6 Routing Table** in the navigation panel to display the screen as shown.

Figure 103 MONITOR > Routing Table > IPv6 Routing Table

IPv6 Routing Table					
Index	Route Destination/ Prefix Length	Next Hop	Interface	Metric	Type

The following table describes the labels in this screen.

Table 47 MONITOR > Routing Table > IPv6 Routing Table

LABEL	DESCRIPTION
Index	This field displays the index number.
Route Destination/ Prefix Length	This field displays the IPv6 subnet prefix and prefix length of the final destination.
Next Hop	This field displays the IPv6 address of the gateway that helps forward the packet to the destination.
Interface	This field displays the descriptive name of the IPv6 interface that is used to forward the packets to the destination.
Metric	This field displays the cost of the route.
Type	This field displays the method used to learn the route. STATIC – added as a static entry. Connect – added as a local interface entry.

CHAPTER 17

System Information

17.0.1 What You Can Do

Use the **System Information** screen (Section 17.1 on page 151) to view general system information and hardware status of the Switch.

Use the **Hardware Monitor** screen (Section 17.2 on page 153) to monitor and check the hardware status of the Switch in Stacking mode.

17.1 System Information

In the navigation panel, click **MONITOR > System Information** to display the screen as shown. Use this screen to view general system information.

Figure 104 MONITOR > System Information (Standalone Mode)

System Information					
System Information					
System Name	XGS2220				
Product Model	XGS2220-54FP				
ZyNOS F/W Version	V4.80(ACCE.0)b6 04/11/2022				
Ethernet Address	00:19:cb:00:00:01				
CPU Utilization Current (%)	32.14				
Memory Utilization					
Name	Total (byte)	Used (byte)	Utilization (%)		
common	71230976	9806032	13		
Hardware Monitor					
Temperature Unit: <input checked="" type="radio"/> C <input type="radio"/> F					
Temperature (C)	Status	Current	MAX	MIN	Threshold
MAC	Normal	43.0	43.0	27.0	78.0
BOARD	Normal	47.0	47.0	27.0	110.0
PHY	Normal	45.0	46.0	24.0	88.0
FAN Speed (RPM)	Status	Current	MAX	MIN	Threshold
FAN1	Normal	2622	2638	2553	500
FAN2	Normal	5953	6033	5561	500
FAN3	Normal	6006	6060	5561	500
Voltage (V)	Status	Current	MAX	MIN	Threshold
3.3V	Normal	3.308	3.308	3.308	+6%/-6%
12V	Normal	11.906	11.968	11.906	+10%/-10%

Figure 105 MONITOR > System Information (Stacking Mode)

System Information					
System Information					
System Name	XGS2220				
Product Model	XGS2220-54HP				
ZyNOS F/W Version	V4.80[ABXQ.2]b6 05/18/2023				
Ethernet Address	d8:ec:e5:cd:ba:fd				
CPU Utilization Current (%)	28.13				
Memory Utilization					
Name	Total (byte)	Used (byte)	Utilization (%)		
common	77884928	14498784	18		
Hardware Monitor					
Slot	Name	Voltage	Temperature	Fan	Power Supply
1	XGS2220-54HP	Error	Normal	Normal	Normal

The following table describes the labels in this screen.

Table 48 MONITOR > System Information

LABEL	DESCRIPTION
System Information	
System Name	This displays the descriptive name of the Switch for identification purposes.
Product Model	This displays the product model of the Switch. Use this information when searching for firmware upgrade or looking for other support information in the website.
ZyNOS F/W Version	This displays the version number of the Switch 's current firmware including the date created.
Ethernet Address	This refers to the Ethernet MAC (Media Access Control) address of the Switch.
CPU Utilization Current (%)	This displays the current percentage of CPU utilization.
Memory Utilization	
Memory utilization shows how much DRAM memory is available and in use. It also displays the current percentage of memory utilization.	
Name	This displays the name of the memory pool.
Total (byte)	This displays the total number of bytes in this memory pool.
Used (byte)	This displays the number of bytes being used in this memory pool.
Utilization (%)	This displays the percentage (%) of memory being used in this memory pool.
Hardware Monitor	
Temperature Unit	The Switch has temperature sensors that are capable of detecting and reporting if the temperature rises above the threshold. You may choose the temperature unit (Centigrade or Fahrenheit) in this field.
Temperature (C/F)	MAC , BOARD , and PHY refer to the location of the temperature sensor on the Switch printed circuit board.
Status	This field displays Normal for temperatures below the threshold and Error for those above.
Current	This shows the current temperature at this sensor.
MAX	This field displays the maximum temperature measured at this sensor.
MIN	This field displays the minimum temperature measured at this sensor.

Table 48 MONITOR > System Information (continued)

LABEL	DESCRIPTION
Threshold	This field displays the upper temperature limit at this sensor.
Fan Speed (RPM)	A properly functioning fan is an essential component (along with a sufficiently ventilated, cool operating environment) in order for the device to stay within the temperature threshold. Each fan has a sensor that is capable of detecting and reporting if the fan speed falls below the threshold shown.
Status	Normal indicates that this fan is functioning above the minimum speed. Error indicates that this fan is functioning below the minimum speed.
Current	This field displays this fan's current speed in Revolutions Per Minute (RPM).
MAX	This field displays this fan's maximum speed measured in Revolutions Per Minute (RPM).
MIN	This field displays this fan's minimum speed measured in Revolutions Per Minute (RPM). "<41" is displayed for speeds too small to measure (under 2000 RPM).
Threshold	This field displays the minimum speed at which a normal fan should work.
Voltage(V)	The power supply for each voltage has a sensor that is capable of detecting and reporting if the voltage falls out of the tolerance range.
Status	Normal indicates that the voltage is within an acceptable operating range at this point; otherwise Error is displayed.
Current	This is the current voltage reading.
MAX	This field displays the maximum voltage measured at this point.
MIN	This field displays the minimum voltage measured at this point.
Threshold	This field displays the percentage tolerance of the voltage with which the Switch still works.
Hardware Monitor (Stacking Mode)	
Slot	This number identifies the Switch in the stack. Click the number to see more detailed information on the Switch.
Name	This is the system name of the Switch in the stack.
Voltage	This shows if the power supply voltage sensor is within normal tolerance range.
Temperature	This shows if the temperature sensors on the Switch printed circuit board are within normal tolerance range.
Fan	This shows if the fan sensors are within normal tolerance range.
Power Supply	This shows if the Switch is properly operating from the connected power source.

17.2 Hardware Monitor (Stacking Mode)

This screen only appears when the Switch is in Stacking mode.

In the **MONITOR > System Information** screen, click an index of a **Slot** under **Hardware Monitor** to display the screen as shown. Use this screen to view hardware information of a specific slot (Switch) in your stacking system.

Figure 106 MONITOR > System Information > Hardware Monitor (Stacking Mode)

System Information						
System Information > Hardware Monitor						
SLOT 1						
						Temperature Unit: <input checked="" type="radio"/> C <input type="radio"/> F
Temperature (C)	Status	Current	MAX	MIN	Threshold	
1/MAC	Normal	45.0	46.0	45.0	87.0	
1/BOARD	Normal	37.0	38.0	37.0	110.0	
1/PHY	Normal	36.0	37.0	-1.0	91.0	
FAN Speed (RPM)	Status	Current	MAX	MIN	Threshold	
1/FAN1	Normal	2632	2643	2622	500	
1/FAN2	Normal	2627	2643	2622	500	
Voltage (V)	Status	Current	MAX	MIN	Threshold	
1/3.3V	Normal	3.308	3.308	3.308	+6%/-6%	
1/12V	Normal	12.031	12.031	12.031	+10%/-10%	

The following table describes the labels in this screen.

Table 49 MONITOR > System Information > Hardware Monitor (Stacking Mode)

LABEL	DESCRIPTION
	This displays the slot ID of the Switch in the stacking system.
Temperature Unit	The Switch has temperature sensors that are capable of detecting and reporting if the temperature rises above the threshold. You may choose the temperature unit: C (Centigrade) or F (Fahrenheit) in this field.
Temperature (C/F)	CPU/MAC, BOARD, and PHY refer to the location of the temperature sensors on the Switch printed circuit board. The first number represents the slot ID.
Status	This field displays Normal for temperatures below the threshold and Error for those above.
Current	This shows the current temperature at this sensor.
MAX	This field displays the maximum temperature measured at this sensor.
MIN	This field displays the minimum temperature measured at this sensor.
Threshold	This field displays the upper temperature limit at this sensor.
Fan Speed (RPM)	A properly functioning fan is an essential component (along with a sufficiently ventilated, cool operating environment) in order for the device to stay within the temperature threshold. Each fan has a sensor that is capable of detecting and reporting if the fan speed falls below the threshold shown. The first number represents the slot ID.
Status	Normal indicates that this fan is functioning above the minimum speed. Error indicates that this fan is functioning below the minimum speed.
Current	This field displays this fan's current speed in Revolutions Per Minute (RPM).
MAX	This field displays this fan's maximum speed measured in Revolutions Per Minute (RPM).
MIN	This field displays this fan's minimum speed measured in Revolutions Per Minute (RPM). "<41" is displayed for speeds too small to measure (under 2000 RPM).
Threshold	This field displays the minimum speed at which a normal fan should work.
Voltage (V)	The power supply for each voltage has a sensor that is capable of detecting and reporting if the voltage falls out of the tolerance range. The first number represents the slot ID.
Status	Normal indicates that the voltage is within an acceptable operating range at this point; otherwise Error is displayed.
Current	This is the current voltage reading.

Table 49 MONITOR > System Information > Hardware Monitor (Stacking Mode) (continued)

LABEL	DESCRIPTION
MAX	This field displays the maximum voltage measured at this point.
MIN	This field displays the minimum voltage measured at this point.
Threshold	This field displays the percentage tolerance of the voltage with which the Switch still works.

CHAPTER 18

System Log

18.1 System Log Overview

A log message stores the system history information for viewing.

18.2 System Log

Click **MONITOR > System Log** in the navigation panel to open this screen. Use this screen to check current system logs.

Note: When a log reaches the maximum number of log messages, new log messages automatically overwrite existing log messages, starting with the oldest existing log message first.

Figure 107 MONITOR > System Log

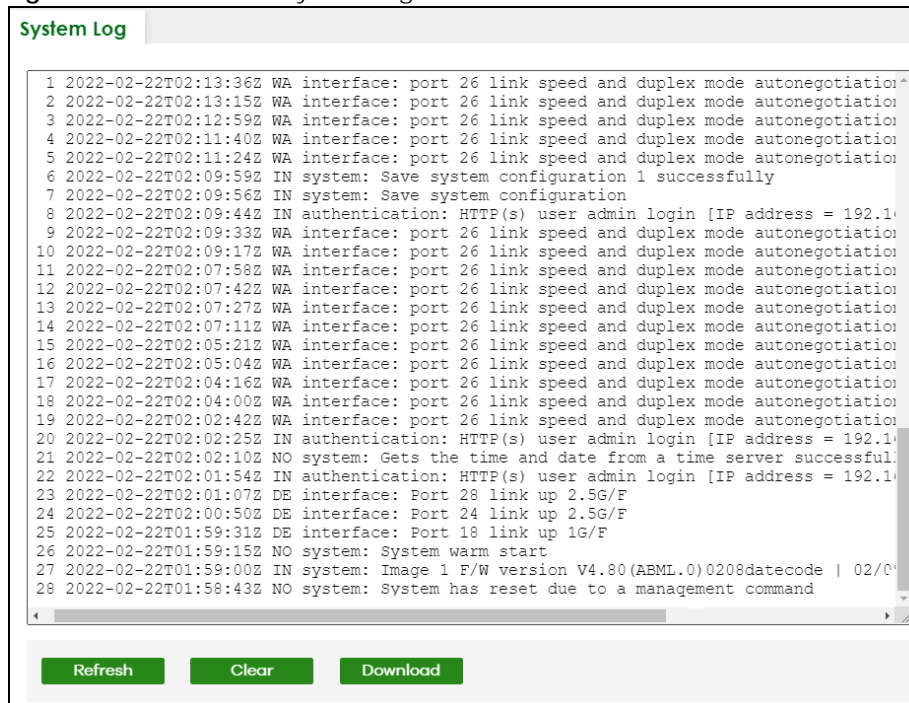

The summary table shows the time the log message was recorded and the reason the log message was generated. Click **Refresh** to update this screen. Click **Clear** to clear the whole log, regardless of what is currently displayed on the screen. Click **Download** to save the log to your computer.

CHAPTER 19

SYSTEM

The following chapters introduces the configurations of the links under the **SYSTEM** navigation panel.

Quick links to chapters:

- [Cloud Management](#)
- [General Setup](#)
- [Hardware Monitor Setup](#)
- [Interface Setup](#)
- [IP Setup](#)
- [IPv6](#)
- [Logins](#)
- [SNMP](#)
- [Stacking](#)
- [Switch Setup](#)
- [Syslog Setup](#)
- [Time Range](#)

CHAPTER 20

Cloud Management

20.1 Cloud Management Overview

The Zyxel Nebula Control Center (NCC) is a cloud-based network management system that allows you to remotely manage and monitor Zyxel Nebula APs, Ethernet switches and security gateways.

The Switch is managed and provisioned automatically by the NCC (Nebula Control Center) when:

- It is connected to the Internet.
- The **Nebula Control Center (NCC) Discovery** feature is enabled.
- It has been registered in the NCC.

20.2 Nebula Center Control Discovery

Click **SYSTEM > Cloud Management** to display this screen.

Figure 108 SYSTEM > Cloud Management

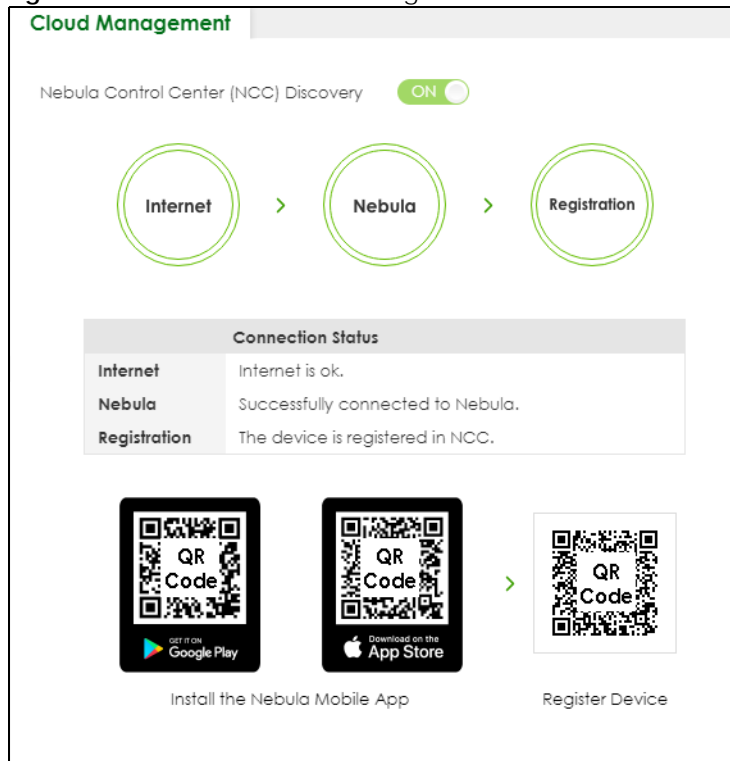

The following table describes the labels in this screen.

Table 50 SYSTEM > Cloud Management

LABEL	DESCRIPTION
Nebula Control Center (NCC) Discovery	<p>Enable the switch button to turn on Nebula Control Center (NCC) discovery on the Switch.</p> <p>This field displays:</p> <ul style="list-style-type: none"> • The Switch Internet connection status. • The connection status between the Switch and NCC. • The Switch registration status on NCC. <p>To pass your Switch management to NCC, first make sure your Switch is connected to the Internet. Then go to NCC and register your Switch.</p> <p>1. Internet</p> <p>Green – The Switch is connected to the Internet.</p> <p>Orange – The Switch is not connected to the Internet.</p> <p>2. Nebula</p> <p>Green – The Switch is connected to NCC.</p> <p>Orange – The Switch is not connected to NCC.</p> <p>3. Registration</p> <p>Green – The Switch is registered on NCC.</p> <p>Gray – The Switch is not registered on NCC.</p> <p>Note: All circles will gray out if you disable Nebula Discovery.</p>
Connection Status	<p>This table displays the NCC connection status information.</p> <p>Use status logs in the Internet, Nebula, and Registration fields for connection troubleshooting.</p>

Cloud Management Mode

Enable the switch button to turn on NCC discovery on the Switch. If the Switch has Internet access and has been registered on the NCC, it will automatically go into cloud management mode. Follow the steps to register your Switch on NCC:

1 Download the Nebula Mobile App

First, download the app from the Google Play store for Android devices or the App Store for iOS devices and create an organization and site.

You can scan an app store QR code to open the app installation page on the app store.

2 Scan the Device QR code

The **Register Device** QR code in this screen contains the Switch's serial number and the registration MAC address for handy NCC registration of the Switch using the Nebula Mobile app.

Follow the wizard in the Nebula Mobile app to scan the QR code to register the Switch on NCC and add the Switch into a site.

If **Nebula Control Center (NCC) Discovery** is disabled, the Switch will NOT discover the NCC and remain in Standalone mode.

CHAPTER 21

General Setup

21.1 General Setup

Use this screen to configure general settings such as the system name and time. Click **SYSTEM > General Setup** in the navigation panel to display the screen as shown.

Figure 109 SYSTEM > General Setup

Note: The input string of any field in this screen should not contain [?], [|], ['], ["], or [,].

The following table describes the labels in this screen.

Table 51 SYSTEM > General Setup

LABEL	DESCRIPTION
System Name	Choose a descriptive name for identification purposes. This name consists of up to 64 printable ASCII characters; spaces are allowed.
Location	Enter the geographic location of your Switch. You can use up to 128 printable ASCII characters; spaces are allowed.
Contact Person's Name	Enter the name of the person in charge of this Switch. You can use up to 32 printable ASCII characters; spaces are allowed.

Table 51 SYSTEM > General Setup (continued)

LABEL	DESCRIPTION
Use Time Server when Bootup	<p>Enter the time service protocol that your time server uses. Not all time servers support all protocols, so you may have to use trial and error to find a protocol that works. The main differences between them are the time format.</p> <p>When you select the Daytime (RFC-867) format, the Switch displays the day, month, year and time with no time zone adjustment. When you use this format it is recommended that you use a Daytime timeserver within your geographical time zone.</p> <p>Time (RFC-868) format displays a 4-byte integer giving the total number of seconds since 1970/1/1 at 00:00:00.</p> <p>NTP (RFC-1305) is similar to Time (RFC-868).</p> <p>None is the default value. Enter the time manually. Each time you turn on the Switch, the time and date will be reset to 2022-01-01 00:00:00.</p>
Time Server IP Address	Enter the IP address or domain name of your timeserver. The Switch searches for the timeserver for up to 60 seconds.
Time Server Sync Interval	Enter the period in minutes between each time server synchronization. The Switch checks the time server after every synchronization interval.
Current Time	This field displays the time you open this menu (or refresh the menu).
New Time (hh:mm:ss)	Enter the new time in hour, minute and second format. The new time then appears in the Current Time field after you click Apply .
Current Date	This field displays the date you open this menu.
New Date (yyyy-mm-dd)	Enter the new date in year, month and day format. The new date then appears in the Current Date field after you click Apply .
Time Zone	Select the time difference between UTC (Universal Time Coordinated, formerly known as GMT, Greenwich Mean Time) and your time zone from the drop-down list box.
Daylight Saving Time	<p>Daylight saving is a period from late spring to early fall when many countries set their clocks ahead of normal local time by one hour to give more daytime light in the evening.</p> <p>Enable the switch button if you use Daylight Saving Time.</p>
Start Date	<p>Configure the day and time when Daylight Saving Time starts if you selected Daylight Saving Time. The time is displayed in the 24 hour format. Here are a couple of examples:</p> <p>Daylight Saving Time starts in most parts of the United States on the second Sunday of March. Each time zone in the United States starts using Daylight Saving Time at 2 A.M. local time. So in the United States you would select Second, Sunday, March and 2:00.</p> <p>Daylight Saving Time starts in the European Union on the last Sunday of March. All of the time zones in the European Union start using Daylight Saving Time at the same moment (1 A.M. GMT or UTC). So in the European Union you would select Last, Sunday, March and the last field depends on your time zone. In Germany for instance, you would select 2:00 because Germany's time zone is one hour ahead of GMT or UTC (GMT+1).</p>
End Date	<p>Configure the day and time when Daylight Saving Time ends if you selected Daylight Saving Time. The time field uses the 24 hour format. Here are a couple of examples:</p> <p>Daylight Saving Time ends in the United States on the first Sunday of November. Each time zone in the United States stops using Daylight Saving Time at 2 A.M. local time. So in the United States you would select First, Sunday, November and 2:00.</p> <p>Daylight Saving Time ends in the European Union on the last Sunday of October. All of the time zones in the European Union stop using Daylight Saving Time at the same moment (1 A.M. GMT or UTC). So in the European Union you would select Last, Sunday, October and the last field depends on your time zone. In Germany for instance, you would select 2:00 because Germany's time zone is one hour ahead of GMT or UTC (GMT+1).</p>

Table 51 SYSTEM > General Setup (continued)

LABEL	DESCRIPTION
Apply	Click Apply to save your changes to the Switch's run-time memory. The Switch loses these changes if it is turned off or loses power, so use the Save link on the top navigation panel to save your changes to the non-volatile memory when you are done configuring.
Cancel	Click Cancel to begin configuring this screen afresh.

21.2 Hardware Monitor Setup

This section introduces **Fan Control** for the temperature of the SFP transceiver inserted in the Switch.

When the SFP transceiver temperature exceeds the temperature threshold (see your transceiver documentation), the Switch automatically turns on the fans with maximum fan speed to cool down the system.

The fans do not automatically turn off after the SFP transceiver temperature returns below threshold. To turn off the fans, you have to temporarily disable **SFP Detect** or reboot the Switch.

Click **SYSTEM > Hardware Monitor Setup** to display the screen as shown below.

Note: The **SFP Detect** feature only functions if at least one of your SFP transceiver(s) support DDMI (Digital Diagnostic Monitoring Interface). See the transceiver documentation.

Figure 110 SYSTEM > Hardware Monitor Setup

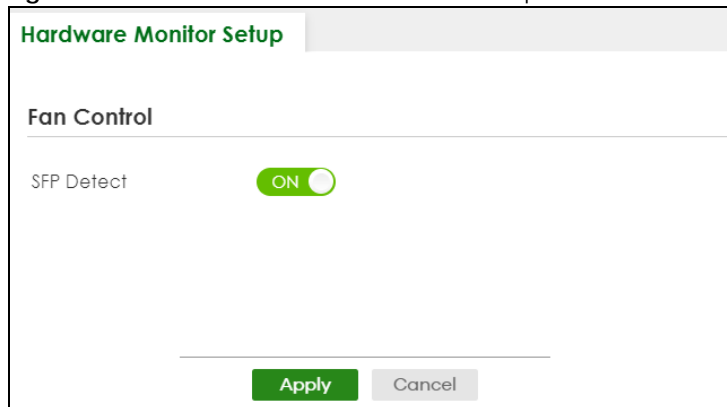

The following table describes the labels in this screen.

Table 52 SYSTEM > Hardware Monitor Setup

LABEL	DESCRIPTION
Fan Control	
SFP Detect	Enable the switch button to enable SFP Detect on the Switch.
Apply	Click Apply to save your changes to the Switch's run-time memory. The Switch loses these changes if it is turned off or loses power, so use the Save link on the top navigation panel to save your changes to the non-volatile memory when you are done configuring.
Cancel	Click Cancel to begin configuring this screen afresh.

You will see SFP warning icons next to the **FANs** in the **MONITOR > System Information** screen when **SFP Detect** has triggered the fans.

Figure 111 Hardware Monitor: SFP Module Temperature Warning

Hardware Monitor					
					Temperature Unit: <input checked="" type="radio"/> C <input type="radio"/> F
Temperature (C)	Status	Current	MAX	MIN	Threshold
MAC	Normal	39.0	39.0	32.0	76.0
BOARD	Normal	35.0	36.0	30.0	113.0
PHY	Normal	39.0	40.0	33.0	99.0
Fan Speed (RPM)	Status	Current	MAX	MIN	Threshold
FAN1	Normal	11663	11663	6199	500
FAN2	Normal	11180	11180	6087	500
FAN3	Normal	11663	11663	6345	500

CHAPTER 22

Interface Setup

22.1 Interface Setup Overview

This chapter shows you how to create virtual interfaces for interface-based configurations. An IPv6 address is configured on a per-interface basis. The interface can be a physical interface (for example, an Ethernet port) or a virtual interface (for example, a VLAN).

22.2 Interface Setup

Use this screen to view and set IPv6 interfaces on which you can configure an IPv6 address to access and manage the Switch.

The interfaces you create here will only take effect after you configure them in the **SYSTEM > IPv6** screens.

Click **SYSTEM > Interface Setup** in the navigation panel to display the configuration screen.

Figure 112 SYSTEM > Interface Setup

<input type="checkbox"/>	Index	Interface Type	Interface ID	Interface
<input checked="" type="checkbox"/>	1	VLAN	1	VLAN1

The following table describes the labels in this screen.

Table 53 SYSTEM > Interface Setup

LABEL	DESCRIPTION
Index	This field displays the index number of an entry.
Interface Type	This field displays the type of interface.
Interface ID	This field displays the identification number of the interface.
Interface	This field displays the interface's descriptive name which is generated automatically by the Switch. The name is from a combination of the interface type and ID number.
	Select an entry's check box to select a specific entry. Otherwise, select the check box in the table heading row to select all entries.
Add/Edit	Click Add/Edit to add a new interface or edit a selected one.
Delete	Click Delete to remove the selected interfaces.

22.2.1 Add/Edit Interfaces

Click **Add/Edit**, or select an entry and click **Add/Edit** in the **SYSTEM > Interface Setup** screen to display the configuration screen.

Figure 113 SYSTEM > Interface Setup > Add/Edit

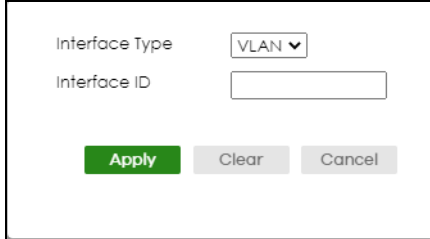

The following table describes the labels in this screen.

Table 54 SYSTEM > Interface Setup > Add/Edit

LABEL	DESCRIPTION
Interface Type	Select the type of IPv6 interface for which you want to configure. The Switch supports the VLAN interface type for IPv6 at the time of writing.
Interface ID	Specify a unique identification number (from 1 to 4094) for the interface. To have IPv6 function properly, you should configure a static VLAN with the same ID number in the SWITCHING > VLAN screens.
Apply	Click Apply to save your changes to the Switch's run-time memory. The Switch loses these changes if it is turned off or loses power, so use the Save link on the top navigation panel to save your changes to the non-volatile memory when you are done configuring.
Clear	Click Clear to clear the fields to the factory defaults.
Cancel	Click Cancel to not save the configuration you make and return to the last screen.

CHAPTER 23

IP Setup

23.1 IP Setup Overview

This chapter shows you how to configure IP settings and set up IP interfaces on the Switch using the **IP Setup** screens.

23.1.1 What You Can Do

- Use the **IP Status** screen ([Section 23.2 on page 167](#)) to view the current IP interfaces and DNS server settings on the Switch.
- Use the **IP Setup** screen ([Section 23.3 on page 169](#)) to configure the default gateway device, the default domain name server and add IP domains.
- Use the **Network Proxy Configuration** screen ([Section 23.4 on page 171](#)) to configure network proxy configurations.

23.1.2 IP Interfaces

The Switch needs an IP address for it to be managed over the network. When the Switch (in Standalone mode) fails to obtain an IP address from a DHCP server, the default static IP address 192.168.1.1 will be automatically added and used as the Switch's management IP address. The subnet mask specifies the network number portion of an IP address. The factory default subnet mask is 255.255.255.0.

On the Switch, an IP address is not bound to any physical ports. Since each IP address on the Switch must be in a separate subnet, the configured IP address is also known as IP interface (or routing domain). In addition, this allows routing between subnets based on the IP address without additional routers.

You can configure multiple routing domains on the same VLAN as long as the IP address ranges for the domains do not overlap. To change the IP address of the Switch in a routing domain, simply add a new routing domain entry with a different IP address in the same subnet.

You can configure up to 128 IP domains which are used to access and manage the Switch from the ports belonging to the pre-defined VLANs.

Note: You must configure a VLAN first. Each VLAN can have multiple management IP addresses, and you can log into the Switch through different management IP addresses simultaneously.

23.2 IP Status

Click **SYSTEM > IP Setup > IP Status** to display the screen as shown.

Figure 114 SYSTEM > IP Setup > IP Status

IP Status																								
IP Status		IP Setup		Network Proxy Configuration																				
Domain Name Server																								
<table border="1"> <thead> <tr> <th>Domain Name Server</th> <th>Source</th> </tr> </thead> <tbody> <tr> <td>172.21.10.1</td> <td>DHCPv4</td> </tr> </tbody> </table>							Domain Name Server	Source	172.21.10.1	DHCPv4														
Domain Name Server	Source																							
172.21.10.1	DHCPv4																							
IP Interface																								
<table border="1"> <thead> <tr> <th>Index</th> <th>IP Address</th> <th>IP Subnet Mask</th> <th>VID</th> <th>Type</th> <th>Action</th> </tr> </thead> <tbody> <tr> <td>1</td> <td>192.168.2.115</td> <td>255.255.255.0</td> <td>100</td> <td>Static</td> <td></td> </tr> <tr> <td>2</td> <td>172.21.40.22</td> <td>255.255.252.0</td> <td>1</td> <td>DHCP</td> <td> <input type="button" value="Renew"/> <input type="button" value="Release"/> </td> </tr> </tbody> </table>							Index	IP Address	IP Subnet Mask	VID	Type	Action	1	192.168.2.115	255.255.255.0	100	Static		2	172.21.40.22	255.255.252.0	1	DHCP	<input type="button" value="Renew"/> <input type="button" value="Release"/>
Index	IP Address	IP Subnet Mask	VID	Type	Action																			
1	192.168.2.115	255.255.255.0	100	Static																				
2	172.21.40.22	255.255.252.0	1	DHCP	<input type="button" value="Renew"/> <input type="button" value="Release"/>																			

The following table describes the labels in this screen.

Table 55 SYSTEM > IP Setup > IP Status

LABEL	DESCRIPTION
Domain Name Server	
Domain Name Server	This field displays the IP address of the DNS server.
Source	This field displays whether the DNS server address is configured manually (Static) or obtained automatically using DHCPv4 .
IP Interface	
Index	This field displays the index number of an entry.
IP Address	This field displays the IP address of the Switch in the IP domain.
IP Subnet Mask	This field displays the subnet mask of the Switch in the IP domain.
VID	This field displays the VLAN identification number of the IP domain on the Switch.
Type	This shows whether this IP address is dynamically assigned from a DHCP server (DHCP) or manually assigned (Static).
Renew	Click this to renew the dynamic IP address.
Release	Click this to release the dynamic IP address.

23.2.1 IP Status Details

Use this screen to view IP status details. Click a number in the **Index** column in the **SYSTEM > IP Setup > IP Status** screen to display the screen as shown next.

Figure 115 SYSTEM > IP Setup > IP Status > IP Status Details: Static

IP Status		IP Setup	Network Proxy Configuration
IP Status > IP Status Details			
IP Status Details			
Type	Static		
VID	100		
IP Address	192.168.2.115		
IP Subnet Mask	255.255.255.0		

The following table describes the labels in this screen.

Table 56 SYSTEM > IP Setup > IP Status > IP Status Details: Static

LABEL	DESCRIPTION
Type	This shows the IP address is manually assigned (Static).
VID	This is the VLAN identification number to which an IP routing domain belongs.
IP Address	This is the IP address of your Switch in dotted decimal notation for example 192.168.1.1.
IP Subnet Mask	This is the IP subnet mask of your Switch in dotted decimal notation for example 255.255.255.0.

Figure 116 SYSTEM > IP Setup > IP Status > IP Status Details: DHCP

IP Status		IP Setup	Network Proxy Configuration
IP Status > IP Status Details			
IP Status Details			
Type	DHCP		
VID	1		
IP Address	192.168.1.100		
IP Subnet Mask	255.255.255.0		
Lease Time	172800 seconds		
Renew Time	86400 seconds		
Rebind Time	138240 seconds		
Lease Time Start	2022-01-01 03:57:48		
Lease Time End	2022-01-03 03:57:48		
Default Gateway	192.168.1.250		
Primary DNS Server	192.168.1.254		
Secondary DNS Server	0.0.0.0		

The following table describes the labels in this screen.

Table 57 SYSTEM > IP Setup > IP Status > IP Status Details: DHCP

LABEL	DESCRIPTION
Type	This shows the IP address is dynamically assigned from a DHCP server (DHCP).
VID	This is the VLAN identification number to which an IP routing domain belongs.
IP Address	This is the IP address of your Switch in dotted decimal notation for example 192.168.1.1.
IP Subnet Mask	This is the IP subnet mask of your Switch in dotted decimal notation for example 255.255.255.0.
Lease Time	This displays the length of time in seconds that this interface can use the current dynamic IP address from the DHCP server.

Table 57 SYSTEM > IP Setup > IP Status > IP Status Details: DHCP (continued)

LABEL	DESCRIPTION
Renew Time	This displays the length of time from the lease start that the Switch will request to renew its current dynamic IP address from the DHCP server.
Rebind Time	This displays the length of time from the lease start that the Switch will request to get any dynamic IP address from the DHCP server.
Lease Time Start	This displays the date and time that the current dynamic IP address assignment from the DHCP server began. You should configure date and time in SYSTEM > General Setup .
Lease Time End	This displays the date and time that the current dynamic IP address assignment from the DHCP server will end. You should configure date and time in SYSTEM > General Setup .
Default Gateway	This displays the IP address of the default gateway assigned by the DHCP server. 0.0.0.0 means no gateway is assigned.
Primary / Secondary DNS Server	This displays the IP address of the primary and secondary DNS servers assigned by the DHCP server. 0.0.0.0 means no DNS server is assigned.

23.3 IP Setup

Use this screen to configure the default gateway device, the default domain name server and add IP domains. Click **SYSTEM > IP Setup > IP Setup** in the navigation panel to display the screen as shown.

Note: The Switch allows you to set a static IP interface in the same subnet that already has a DHCP-assigned IP interface on the Switch. The Switch will use the static IP you set and the DHCP-assigned IP will be set to 0.0.0.0.

Figure 117 SYSTEM > IP Setup > IP Setup

The following table describes the labels in this screen.

Table 58 SYSTEM > IP Setup > IP Setup

LABEL	DESCRIPTION
IP Setup	
Default Gateway	Type the IP address of the default outgoing gateway in dotted decimal notation, for example 192.168.1.254.
Domain Name Server 1/2	Enter a domain name server IPv4 address in order to be able to use a domain name instead of an IP address.

Table 58 SYSTEM > IP Setup > IP Setup (continued)

LABEL	DESCRIPTION
Apply	Click Apply to save your changes to the Switch's run-time memory. The Switch loses these changes if it is turned off or loses power, so use the Save link on the top navigation panel to save your changes to the non-volatile memory when you are done configuring.
Cancel	Click Cancel to reset the fields to your previous configuration.
IP Interface	
Use this section to view and configure IP routing domains on the Switch.	
Index	This field displays the index number of an entry.
IP Address	This field displays the IP address of the Switch in the IP domain.
IP Subnet Mask	This field displays the subnet mask of the Switch in the IP domain.
VID	This field displays the VLAN identification number of the IP domain on the Switch.
Type	This field displays the type of IP address status. Static or DHCP .
	Select an entry's check box to select a specific entry. Otherwise, select the check box in the table heading row to select all entries.
Add/Edit	Click Add/Edit to add a new IP interface or edit a selected one.
Delete	Click Delete to remove the selected IP interfaces.

23.3.1 Add/Edit IP Interfaces

Use this screen to add or edit IP interfaces. Click **Add/Edit**, or select an entry and click **Add/Edit** in the **SYSTEM > IP Setup > IP Setup** screen to display this screen.

Figure 118 SYSTEM > IP Setup > IP Setup > Add/Edit

The screenshot shows the configuration interface for an IP interface. It features two radio buttons: "DHCP Client" (selected) and "Static IP Address" (unselected). Under "DHCP Client", there is a checked checkbox for "Option-60" and a text input field for "Class-ID" containing "Zyxel Corporation". Under "Static IP Address", there are three empty text input fields for "IP Address", "IP Subnet Mask", and "VID". At the bottom, there are three buttons: "Apply" (green), "Clear" (grey), and "Cancel" (grey).

The following table describes the labels in this screen.

Table 59 SYSTEM > IP Setup > IP Setup > Add/Edit

LABEL	DESCRIPTION
DHCP Client	Select this option if you have a DHCP server that can assign the Switch an IP address, subnet mask, a default gateway IP address and a domain name server IP address automatically.
Option-60	DHCP Option 60 is used by the Switch for identification to the DHCP server using the VCI (Vendor Class Identifier) on the DHCP server. The Switch adds it in the initial DHCP discovery message that a DHCP client broadcasts in search of an IP address. The DHCP server can assign different IP addresses or options to clients with the specific VCI or reject the request from clients without the specific VCI. Select this and enter the device identity you want the Switch to add in the DHCP discovery frames that go to the DHCP server. This allows the Switch to identify itself to the DHCP server.
Class-ID	Enter a string of up to 32 printable ASCII characters to identify this Switch to the DHCP server. For example, Zyxel-TW. The string should not contain [?], [], ['], ["], or [.].
Static IP Address	Select this option if you do not have a DHCP server or if you wish to assign static IP address information to the Switch. You need to fill in the following fields when you select this option.
IP Address	Enter the IP address of your Switch in dotted decimal notation, for example, 192.168.1.1. This is the IP address of the Switch in an IP routing domain.
IP Subnet Mask	Enter the IP subnet mask of an IP routing domain in dotted decimal notation, for example, 255.255.255.0.
VID	Enter the VLAN identification number to which an IP routing domain belongs.
Apply	Click Apply to save your changes to the Switch's run-time memory. The Switch loses these changes if it is turned off or loses power, so use the Save link on the top navigation panel to save your changes to the non-volatile memory when you are done configuring.
Clear	Click Clear to clear the fields to the factory defaults.
Cancel	Click Cancel to not save the configuration you make and return to the last screen.

23.4 Network Proxy Configuration

The proxy server of an organization may prohibit communication between the Switch and NCC (Nebula Control Center) (See [Section 20.1 on page 158](#)). Use this screen to enable communication between the Switch and NCC through the proxy server.

Figure 119 Network Proxy Configuration Application

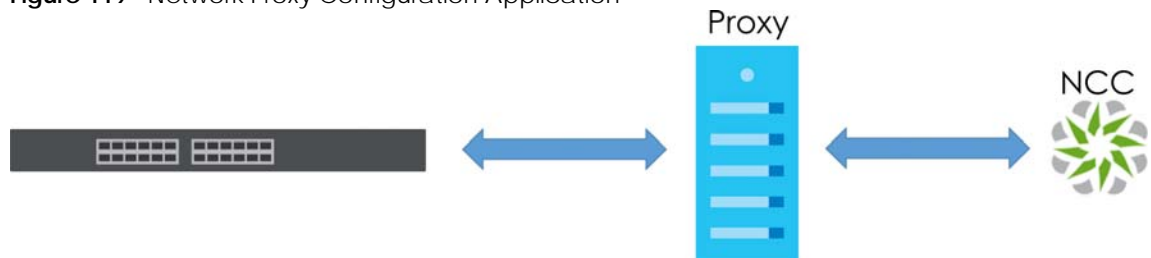

As of this writing, this setting only allows communication between the Switch and the NCC.

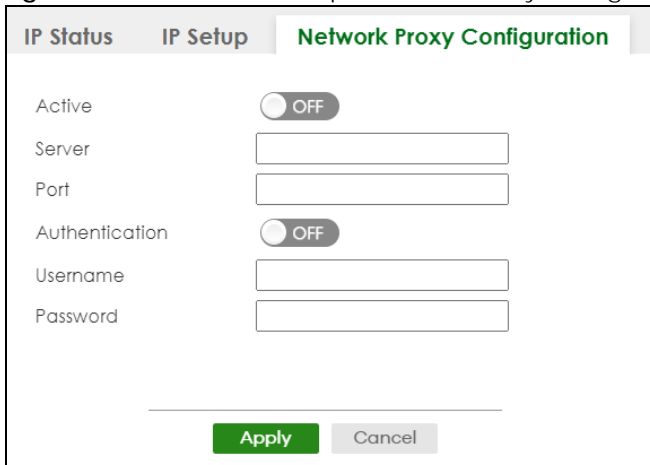
Figure 120 SYSTEM > IP Setup > Network Proxy Configuration

The following table describes the labels in this screen.

Table 60 SYSTEM > IP Setup > Network Proxy Configuration

LABEL	DESCRIPTION
Active	Enable the switch button to enable communication between the Switch and NCC through a proxy server.
Server	Enter the IP address (dotted decimal notation) or host name of the proxy server. When entering the host name, up to 128 alphanumeric characters are allowed for the Server except [?], [], ['], or ["].
Port	Enter the port number of the proxy server (1 – 65535).
Authentication	Enable the switch button to enable proxy server authentication using a Username and Password .
Username	Enter a login user name from the proxy server administrator. Up to 32 alphanumeric characters are allowed for the Username except [?], [], ['], or ["].
Password	Enter a login password from the proxy server administrator. Up to 32 alphanumeric characters are allowed for the Password except [?], [], ['], or ["].
Apply	Click Apply to save your changes to the Switch's run-time memory. The Switch loses these changes if it is turned off or loses power, so use the Save link on the top navigation panel to save your changes to the non-volatile memory when you are done configuring.
Cancel	Click Cancel to reset the fields to your previous configuration.

CHAPTER 24

IPv6

24.1 IPv6 Overview

This chapter introduces the **IPv6** screens.

24.1.1 What You Can Do

- Use the **IPv6 Status** screen ([Section 24.2 on page 173](#)) to view the IPv6 table and DNS server information.
- Use the **IPv6 Global Setup** screen ([Section 24.3 on page 176](#)) to configure the global IPv6 settings.
- Use the **IPv6 Interface Setup** screen ([Section 24.4 on page 177](#)) to view and configure IPv6 interfaces.
- Use the **IPv6 Link-Local Address Setup** screen ([Section 24.5 on page 178](#)) to view and configure IPv6 link-local addresses.
- Use the **IPv6 Global Address Setup** screen ([Section 24.6 on page 180](#)) to view and configure IPv6 global addresses.
- Use the **IPv6 Neighbor Discovery Setup** screen ([Section 24.7 on page 181](#)) to view and configure neighbor discovery settings on each interface.
- Use the **IPv6 Router Discovery Setup** screen ([Section 24.8 on page 183](#)) to view and configure router discovery settings on each interface.
- Use the **IPv6 Prefix Setup** screen ([Section 24.9 on page 184](#)) to configure the Switch's IPv6 prefix list for each interface.
- Use the **IPv6 Neighbor Setup** screen ([Section 24.10 on page 186](#)) to configure static IPv6 neighbor entries in the Switch's IPv6 neighbor table.
- Use the **DHCPv6 Client Setup** screen ([Section 24.11 on page 187](#)) to configure the Switch's DHCP settings when it is acting as a DHCPv6 client.

24.2 IPv6 Status

Click **SYSTEM > IPv6 > IPv6 Status** in the navigation panel to display the IPv6 status screen as shown next.

Figure 121 SYSTEM > IPv6 > IPv6 Status

Domain Name Server		
Domain Name Server	Source	
IPv6 Table		
Index	Interface	Active
1	VLAN1	ON

The following table describes the labels in this screen.

Table 61 SYSTEM > IPv6 > IPv6 Status

LABEL	DESCRIPTION
Domain Name Server	
Domain Name Server	This field displays the IP address of the DNS server.
Source	This field displays whether the DNS server address is configured manually (Static) or obtained automatically using DHCPv6 .
IPv6 Table	
Index	This field displays the index number of an IPv6 interface. Click on an index number to view more interface details.
Interface	This is the name of the IPv6 interface you created.
Active	This field displays whether the IPv6 interface is activated or not.

24.2.1 IPv6 Interface Status Details

Use this screen to view a specific IPv6 interface status and detailed information. Click an interface index number in the **SYSTEM > IPv6 > IPv6 Status** screen. The following screen opens.

Figure 122 SYSTEM > IPv6 > IPv6 Status > IPv6 Interface Details

IPv6 Status

[IPv6 Status](#) > IPv6 Interface Details

Interface: VLAN1

Static IPv6 Active ON | **DHCPv6 Client Active** ON

MTU Size	1500	Identity Association	
ICMPv6 Rate Limit Bucket Size	100	IA Type	IA-NA
ICMPv6 Rate Limit Error Interval	1000	IAID	11
ND DAD Active	ON	T1	0
Number of DAD Attempts	1	T2	0
NS-interval (millisecond)	1000	State	
ND Reachable Time (millisecond)	30000	SID	
Link-Local Address	fe80::666:ffff:bbbb:bbbb/64 [preferred]	Address	
Global Unicast Address	ff02::2	Preferred Lifetime	0
Joined Group Address	ff01::1	Valid Lifetime	0
	ff02::1		
	ff02::1:ffaa:bb19		
		DNS	
		Domain List	
		Restart DHCPv6 Client	Restart

The following table describes the labels in this screen.

Table 62 SYSTEM > IPv6 > IPv6 Status > IPv6 Interface Details

LABEL	DESCRIPTION
Static IPv6 Active	This field displays whether the IPv6 interface is activated or not.
MTU Size	This field displays the Maximum Transmission Unit (MTU) size for IPv6 packets on this interface.
ICMPv6 Rate Limit Bucket Size	This field displays the maximum number of ICMPv6 error messages which are allowed to transmit in a given time interval. If the bucket is full, subsequent error messages are suppressed.
ICMPv6 Rate Limit Error Interval	This field displays the time period (in milliseconds) during which ICMPv6 error messages of up to the bucket size can be transmitted. 0 means no limit.
ND DAD Active	This field displays whether Neighbor Discovery (ND) Duplicate Address Detection (DAD) is enabled on the interface.
Number of DAD Attempts	This field displays the number of consecutive neighbor solicitations the Switch sends for this interface.
NS-Interval (millisecond)	This field displays the time interval (in milliseconds) at which neighbor solicitations are re-sent for this interface.
ND Reachable Time (millisecond)	This field displays how long (in milliseconds) a neighbor is considered reachable for this interface.
Link-Local Address	This field displays the Switch's link-local IP address and prefix generated by the interface. It also shows whether the IP address is preferred, which means it is a valid address and can be used as a sender or receiver address.

Table 62 SYSTEM > IPv6 > IPv6 Status > IPv6 Interface Details (continued)

LABEL	DESCRIPTION
Global Unicast Address	This field displays the Switch's global unicast address to identify this interface.
Joined Group Address	This field displays the IPv6 multicast addresses of groups the Switch's interface joins.
DHCPv6 Client Active	
This field displays whether the Switch acts as a DHCPv6 client to get an IPv6 address from a DHCPv6 server.	
Identity Association	
An Identity Association (IA) is a collection of addresses assigned to a DHCP client, through which the server and client can manage a set of related IP addresses. Each IA must be associated with exactly one interface.	
IA Type	The IA type is the type of address in the IA. Each IA holds one type of address. IA_NA means an identity association for non-temporary addresses and IA_TA is an identity association for temporary addresses.
IAID	Each IA consists of a unique IAID and associated IP information.
T1	This field displays the DHCPv6 T1 timer. After T1, the Switch sends the DHCPv6 server a Renew message. An IA_NA option contains the T1 and T2 fields, but an IA_TA option does not. The DHCPv6 server uses T1 and T2 to control the time at which the client contacts with the server to extend the lifetimes on any addresses in the IA_NA before the lifetimes expire.
T2	This field displays the DHCPv6 T2 timer. If the time T2 is reached and the server does not respond, the Switch sends a Rebind message to any available server.
State	This field displays the state of the TA. It shows Active when the Switch obtains addresses from a DHCPv6 server and the TA is created. Renew when the TA's address lifetime expires and the Switch sends out a Renew message. Rebind when the Switch does not receive a response from the original DHCPv6 server and sends out a Rebind message to another DHCPv6 server.
SID	This field displays the DHCPv6 server's unique ID.
Address	This field displays the Switch's global address which is assigned by the DHCPv6 server.
Preferred Lifetime	This field displays how long (in seconds) that the global address remains preferred.
Valid Lifetime	This field displays how long (in seconds) that the global address is valid.
DNS	This field displays the DNS server address assigned by the DHCPv6 server.
Domain List	This field displays the address record when the Switch queries the DNS server to resolve domain names.
Restart DHCPv6 Client	Click Restart to send a new DHCP request to the DHCPv6 server and update the IPv6 address and DNS information for this interface.

24.3 IPv6 Global Setup

Use this screen to configure the global IPv6 settings. Click **SYSTEM > IPv6 > IPv6 Global Setup** to display the screen as shown next.

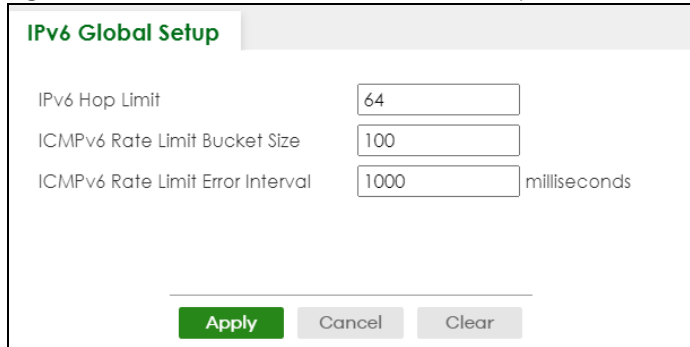
Figure 123 SYSTEM > IPv6 > IPv6 Global Setup

IPv6 Global Setup

IPv6 Hop Limit

ICMPv6 Rate Limit Bucket Size

ICMPv6 Rate Limit Error Interval milliseconds

Apply

The following table describes the labels in this screen.

Table 63 SYSTEM > IPv6 > IPv6 Global Setup

LABEL	DESCRIPTION
IPv6 Hop Limit	Specify the maximum number of hops (from 1 to 255) in router advertisements. This is the maximum number of hops on which an IPv6 packet is allowed to transmit before it is discarded by an IPv6 router, which is similar to the TTL field in IPv4.
ICMPv6 Rate Limit Bucket Size	Specify the maximum number of ICMPv6 error messages (from 1 to 200) which are allowed to transmit in a given time interval. If the bucket is full, subsequent error messages are suppressed.
ICMPv6 Rate Limit Error Interval	Specify the time period (from 0 to 2147483647 milliseconds) during which ICMPv6 error messages of up to the bucket size can be transmitted. 0 means no limit.
Apply	Click Apply to save your changes to the Switch's run-time memory. The Switch loses these changes if it is turned off or loses power, so use the Save link on the top navigation panel to save your changes to the non-volatile memory when you are done configuring.
Cancel	Click Cancel to begin configuring this screen afresh.
Clear	Click Clear to reset the fields to the factory defaults.

24.4 IPv6 Interface Setup

Use this screen to view and configure an IPv6 interface you create in the **SYSTEM > Interface Setup** screen. Click **SYSTEM > IPv6 > IPv6 Interface Setup** to display the screen as shown next.

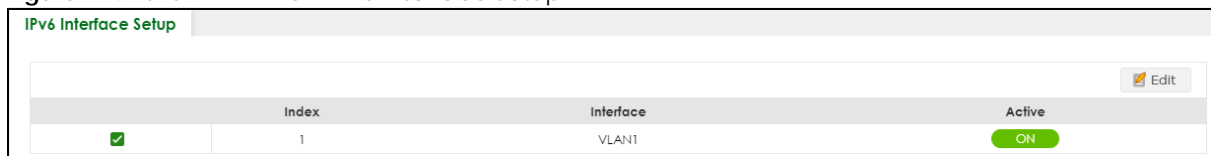
Figure 124 SYSTEM > IPv6 > IPv6 Interface Setup

IPv6 Interface Setup

Index	Interface	Active
<input checked="" type="checkbox"/>	1	VLAN1 <input type="button" value="ON"/>

The following table describes the labels in this screen.

Table 64 SYSTEM > IPv6 > IPv6 Interface Setup

LABEL	DESCRIPTION
Index	This is the interface index number.
Interface	This is the name of the IPv6 interface you created.
Active	This field displays whether the IPv6 interface is activated or not.

Table 64 SYSTEM > IPv6 > IPv6 Interface Setup (continued)

LABEL	DESCRIPTION
	Select an entry's check box to select a specific entry.
Edit	Click Edit to edit the selected interface.

24.4.1 Edit an IPv6 Interface

Use this screen to turn on or off an IPv6 interface you create in the **SYSTEM > Interface Setup** screen. Select an entry and click **Edit** in the **SYSTEM > IPv6 > IPv6 Interface Setup** screen to display the screen as shown next.

Figure 125 SYSTEM > IPv6 > IPv6 Interface Setup > Edit

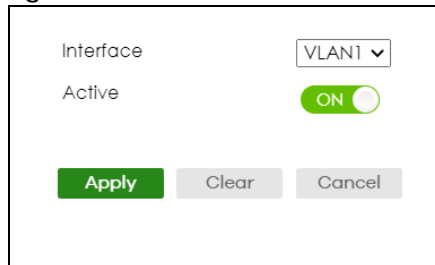

The screenshot shows a configuration panel for an IPv6 interface. At the top, there is a dropdown menu labeled 'Interface' with 'VLAN1' selected. Below it is a toggle switch labeled 'Active' which is currently turned 'ON'. At the bottom of the panel, there are three buttons: a green 'Apply' button, a grey 'Clear' button, and a grey 'Cancel' button.

The following table describes the labels in this screen.

Table 65 SYSTEM > IPv6 > IPv6 Interface Setup > Edit

LABEL	DESCRIPTION
Interface	Select the IPv6 interface you want to configure.
Active	Enable the switch button to enable the interface.
Apply	Click Apply to save your changes to the Switch's run-time memory. The Switch loses these changes if it is turned off or loses power, so use the Save link on the top navigation panel to save your changes to the non-volatile memory when you are done configuring.
Clear	Click Clear to clear the fields to the factory defaults.
Cancel	Click Cancel to not save the configuration you make and return to the last screen.

24.5 IPv6 Link-Local Address Setup

A link-local address uniquely identifies a device on the local network (the LAN). It is similar to a "private IP address" in IPv4. You can have the same link-local address on multiple interfaces on a device. A link-local unicast address has a predefined prefix of fe80::/10.

Use this screen to view and configure the interface's link-local address and default gateway. Click **SYSTEM > IPv6 > IPv6 Addressing > IPv6 Link-Local Address Setup** to display the screen as shown next.

Note: You should first create an IPv6 interface in the **SYSTEM > Interface Setup** screen.

Figure 126 SYSTEM > IPv6 > IPv6 Addressing > IPv6 Link-Local Address Setup

Index	Interface	IPv6 Link-Local Address	IPv6 Default Gateway
<input checked="" type="checkbox"/>	1	VLAN1	

The following table describes the labels in this screen.

Table 66 SYSTEM > IPv6 > IPv6 Addressing > IPv6 Link-Local Address Setup

LABEL	DESCRIPTION
Index	This is the interface index number.
Interface	This is the name of the IPv6 interface you created.
IPv6 Link-Local Address	This is the static IPv6 link-local address for the interface.
IPv6 Default Gateway	This is the default gateway IPv6 address for the interface.
	Select an entry's check box to select a specific entry.
Edit	Click Edit to edit the selected entry.

24.5.1 Edit an IPv6 Link-Local Address

Use this screen to configure the link-local address and default gateway of an IPv6 interface you create in the **SYSTEM > Interface Setup** screen. Select an entry and click **Edit** in the **SYSTEM > IPv6 > IPv6 Addressing > IPv6 Link-Local Address Setup** screen to display this screen.

Figure 127 SYSTEM > IPv6 > IPv6 Addressing > IPv6 Link-Local Address Setup > Edit

The following table describes the labels in this screen.

Table 67 SYSTEM > IPv6 > IPv6 Addressing > IPv6 Link-Local Address Setup > Edit

LABEL	DESCRIPTION
Interface	Select the IPv6 interface you want to configure.
Link-Local Address	Manually configure a static IPv6 link-local address for the interface.
Default Gateway	Set the default gateway IPv6 address for the interface. When an interface cannot find a routing information for a frame's destination, it forwards the packet to the default gateway.
Apply	Click Apply to save your changes to the Switch's run-time memory. The Switch loses these changes if it is turned off or loses power, so use the Save link on the top navigation panel to save your changes to the non-volatile memory when you are done configuring.
Clear	Click Clear to clear the fields to the factory defaults.
Cancel	Click Cancel to not save the configuration you make and return to the last screen.

24.6 IPv6 Global Address Setup

Use this screen to view and configure the interface's IPv6 global address. Click **SYSTEM > IPv6 Addressing > IPv6 Global Address Setup** to display the screen as shown next.

Figure 128 SYSTEM > IPv6 > IPv6 Addressing > IPv6 Global Address Setup

The following table describes the labels in this screen.

Table 68 SYSTEM > IPv6 > IPv6 Addressing > IPv6 Global Address Setup

LABEL	DESCRIPTION
IPv6 Domain Name Server	
Domain Name Server 1/2	Enter a domain name server IPv6 address in order to be able to use a domain name instead of an IP address.
Apply	Click Apply to save your changes to the Switch's run-time memory. The Switch loses these changes if it is turned off or loses power, so use the Save link on the top navigation panel to save your changes to the non-volatile memory when you are done configuring.
Cancel	Click this to reset the Domain Name Server values in this screen to their last-saved values.
IPv6 Global Address Setup	
Index	This is the interface index number.
Interface	This is the name of the IPv6 interface you created.
IPv6 Global Address/Prefix Length	This field displays the IPv6 global address and prefix length for the interface.
EUI-64	This shows whether the interface ID of the global address is generated using the EUI-64 format.
	Select an entry's check box to select a specific entry. Otherwise, select the check box in the table heading row to select all entries.
Add/Edit	Click Add/Edit to add a new entry or edit a selected one.
Delete	Click Delete to remove the selected entries.

24.6.1 Add/Edit an IPv6 Global Address

Use this screen to configure the interface's IPv6 global address. Click **Add/Edit**, or select an entry and click **Add/Edit** in the **SYSTEM > IPv6 Addressing > IPv6 Global Address Setup** screen to display this screen.

Figure 129 SYSTEM > IPv6 > IPv6 Addressing > IPv6 Global Address Setup > Add/Edit

Interface: VLAN1

IPv6 Global Address: EUI-64

Prefix Length:

Buttons: Apply, Clear, Cancel

The following table describes the labels in this screen.

Table 69 SYSTEM > IPv6 > IPv6 Addressing > IPv6 Global Address Setup > Add/Edit

LABEL	DESCRIPTION
Interface	Select the IPv6 interface you want to configure.
IPv6 Global Address	Manually configure a static IPv6 global address for the interface.
Prefix Length	Specify an IPv6 prefix length that specifies how many most significant bits (start from the left) in the address compose the network address.
EUI-64	Select this option to have the interface ID be generated automatically using the EUI-64 format.
Apply	Click Apply to save your changes to the Switch's run-time memory. The Switch loses these changes if it is turned off or loses power, so use the Save link on the top navigation panel to save your changes to the non-volatile memory when you are done configuring.
Clear	Click Clear to clear the fields to the factory defaults.
Cancel	Click Cancel to not save the configuration you make and return to the last screen.

24.7 IPv6 Neighbor Discovery Setup

Use this screen to configure neighbor discovery settings for each interface. Click **SYSTEM > IPv6 > IPv6 Neighbor Discovery > IPv6 Neighbor Discovery Setup** to display the screen as shown next.

Figure 130 SYSTEM > IPv6 > IPv6 Neighbor Discovery > IPv6 Neighbor Discovery Setup

IPv6 Neighbor Discovery Setup | IPv6 Router Discovery Setup | IPv6 Prefix Setup

Buttons: Edit

	Index	Interface	DAD Attempts	NS Interval	Reachable Time
<input type="checkbox"/>	1	VLAN1	1	1000	30000
<input type="checkbox"/>	2	VLAN5	1	1000	30000

The following table describes the labels in this screen.

Table 70 SYSTEM > IPv6 > IPv6 Neighbor Discovery > IPv6 Neighbor Discovery Setup

LABEL	DESCRIPTION
Index	This is the interface index number.
Interface	This is the name of the IPv6 interface you created.
DAD Attempts	This field displays the number of consecutive neighbor solicitations the Switch sends for this interface.

Table 70 SYSTEM > IPv6 > IPv6 Neighbor Discovery > IPv6 Neighbor Discovery Setup (continued)

LABEL	DESCRIPTION
NS Interval	This field displays the time interval (in milliseconds) at which neighbor solicitations are re-sent for this interface.
Reachable Time	This field displays how long (in milliseconds) a neighbor is considered reachable for this interface.
	Select an entry's check box to select a specific entry.
Edit	Click Edit to edit the selected entry.

24.7.1 Edit an IPv6 Neighbor Discovery

Use this screen to configure neighbor discovery settings for each interface. Select an entry and click **Edit** in the **SYSTEM > IPv6 > IPv6 Neighbor Discovery > IPv6 Neighbor Discovery Setup** screen to display this screen.

Figure 131 SYSTEM > IPv6 > IPv6 Neighbor Discovery > IPv6 Neighbor Discovery Setup > Edit

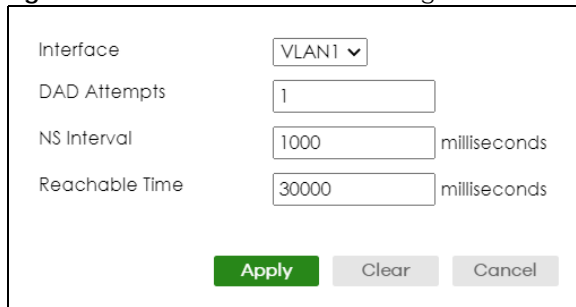

The following table describes the labels in this screen.

Table 71 SYSTEM > IPv6 > IPv6 Neighbor Discovery > IPv6 Neighbor Discovery Setup > Edit

LABEL	DESCRIPTION
Interface	Select the IPv6 interface you want to configure.
DAD Attempts	The Switch uses Duplicate Address Detection (DAD) with neighbor solicitation and advertisement messages to check whether an IPv6 address is already in use before assigning it to an interface. Specify the number of consecutive neighbor solicitations (from 0 to 600) the Switch sends for this interface. Enter 0 to turn off DAD.
NS Interval	Specify the time interval (from 1000 to 3600000 milliseconds) at which neighbor solicitations are re-sent for this interface.
Reachable Time	Specify how long (from 1000 to 3600000 milliseconds) a neighbor is considered reachable for this interface.
Apply	Click Apply to save your changes to the Switch's run-time memory. The Switch loses these changes if it is turned off or loses power, so use the Save link on the top navigation panel to save your changes to the non-volatile memory when you are done configuring.
Clear	Click Clear to clear the fields to the factory defaults.
Cancel	Click Cancel to not save the configuration you make and return to the last screen.

24.8 IPv6 Router Discovery Setup

Use this screen to configure router discovery settings for each interface. Click **SYSTEM > IPv6 > IPv6 Neighbor Discovery > IPv6 Router Discovery Setup** to display the screen as shown next.

Figure 132 SYSTEM > IPv6 > IPv6 Neighbor Discovery > IPv6 Router Discovery Setup

	Index	Interface	Flags	Minimum Interval	Maximum Interval	Lifetime	Suppress
<input type="checkbox"/>	1	VLAN1	M	200	600	1800	OFF
<input type="checkbox"/>	2	VLAN5		200	600	1800	OFF

The following table describes the labels in this screen.

Table 72 SYSTEM > IPv6 > IPv6 Neighbor Discovery > IPv6 Router Discovery Setup

LABEL	DESCRIPTION
Index	This is the interface index number.
Interface	This is the name of the IPv6 interface you created.
Flags	This field displays whether IPv6 hosts use DHCPv6 to obtain IPv6 stateful addresses (M) and/or additional configuration settings (O).
Minimum Interval	This field displays the minimum time interval at which the Switch sends router advertisements for this interface.
Maximum Interval	This field displays the maximum time interval at which the Switch sends router advertisements for this interface.
Lifetime	This field displays how long the router in router advertisements can be used as a default router for this interface.
Suppress	This field displays whether the Switch sends router advertisements and responses to router solicitations on this interface (ON) or not (OFF).
	Select an entry's check box to select a specific entry.
Edit	Click Edit to edit the selected entry.

24.8.1 Edit IPv6 Router Discovery

Use this screen to configure router discovery settings for each interface. Select an entry and click **Edit** in the **SYSTEM > IPv6 > IPv6 Neighbor Discovery > IPv6 Router Discovery Setup** screen to display the screen as shown next.

Figure 133 SYSTEM > IPv6 > IPv6 Neighbor Discovery > IPv6 Router Discovery Setup > Edit

Interface: VLAN1

Flags: Managed Config Flag, Other Config Flag

Minimum Interval: 200 seconds

Maximum Interval: 600 seconds

Lifetime: 1800 seconds

Suppress: ON

Buttons: Apply, Clear, Cancel

The following table describes the labels in this screen.

Table 73 SYSTEM > IPv6 > IPv6 Neighbor Discovery > IPv6 Router Discovery Setup > Edit

LABEL	DESCRIPTION
Interface	Select the IPv6 interface you want to configure.
Flags	Select the Managed Config Flag option to have the Switch set the “managed address configuration” flag (the M flag) to 1 in IPv6 router advertisements, which means IPv6 hosts use DHCPv6 to obtain IPv6 stateful addresses. De-select the option to set the flag to 0 and the host will not use DHCPv6 to obtain IPv6 stateful addresses. Select the Other Config Flag option to have the Switch set the “Other stateful configuration” flag (the O flag) to 1 in IPv6 router advertisements, which means IPv6 hosts use DHCPv6 to obtain additional configuration settings, such as DNS information. De-select the option to set the flag to 0 and the host will not use DHCPv6 to obtain additional configuration settings.
Minimum Interval	Specify the minimum time interval (from 3 to 1350 seconds) at which the Switch sends router advertisements for this interface. Note: The minimum time interval cannot be greater than three-quarters of the maximum time interval.
Maximum Interval	Specify the maximum time interval (from 4 to 1800 seconds) at which the Switch sends router advertisements for this interface.
Lifetime	Specify how long (from 0 to 9000 seconds) the router in router advertisements can be used as a default router for this interface.
Suppress	Enable the switch button to set the Switch to not send router advertisements and responses to router solicitations on this interface.
Apply	Click Apply to save your changes to the Switch’s run-time memory. The Switch loses these changes if it is turned off or loses power, so use the Save link on the top navigation panel to save your changes to the non-volatile memory when you are done configuring.
Clear	Click Clear to clear the fields to the factory defaults.
Cancel	Click Cancel to not save the configuration you make and return to the last screen.

24.9 IPv6 Prefix Setup

Use this screen to configure the Switch’s IPv6 prefix list for each interface. Click **SYSTEM > IPv6 > IPv6 Neighbor Discovery > IPv6 Prefix Setup** to display the screen as shown next.

Figure 134 SYSTEM > IPv6 > IPv6 Neighbor Discovery > IPv6 Prefix Setup

The following table describes the labels in this screen.

Table 74 SYSTEM > IPv6 > IPv6 Neighbor Discovery > IPv6 Prefix Setup

LABEL	DESCRIPTION
Index	This is the interface index number.
Interface	This is the name of the IPv6 interface you created.
Prefix	This field displays the IPv6 prefix and prefix length that the Switch includes in router advertisements for this interface.
Valid Lifetime	This field displays the IPv6 prefix valid lifetime.
Preferred Lifetime	This field displays the preferred lifetime of an IPv6 address generated from the prefix.
	Select an entry's check box to select a specific entry. Otherwise, select the check box in the table heading row to select all entries.
Add/Edit	Click Add/Edit to add a new entry or edit a selected one.
Delete	Click Delete to remove the selected entries.

24.9.1 Add/Edit IPv6 Prefix

Use this screen to configure the Switch's IPv6 prefix list for each interface. Click **Add/Edit**, or select an entry and click **Add/Edit** in the **SYSTEM > IPv6 > IPv6 Neighbor Discovery > IPv6 Prefix Setup** screen to display this screen.

Figure 135 SYSTEM > IPv6 > IPv6 Neighbor Discovery > IPv6 Prefix Setup > Add/Edit

The following table describes the labels in this screen.

Table 75 SYSTEM > IPv6 > IPv6 Neighbor Discovery > IPv6 Prefix Setup > Add/Edit

LABEL	DESCRIPTION
Interface	Select the IPv6 interface you want to configure.
Prefix	Set the IPv6 prefix that the Switch includes in router advertisements for this interface.

Table 75 SYSTEM > IPv6 > IPv6 Neighbor Discovery > IPv6 Prefix Setup > Add/Edit (continued)

LABEL	DESCRIPTION
Prefix Length	Set the prefix length that the Switch includes in router advertisements for this interface.
Valid Lifetime	Specify how long (from 0 to 4294967295 seconds) the prefix is valid for on-link determination.
Preferred Lifetime	Specify how long (from 0 to 4294967295 seconds) that addresses generated from the prefix remain preferred. The preferred lifetime cannot exceed the valid lifetime.
Flags	Select No-Autoconfig Flag to not allow IPv6 hosts to use this prefix. Select No-Onlink Flag to not allow the specified prefix to be used for on-link determination. Select No-Advertise Flag to set the Switch to not include the specified IPv6 prefix, prefix length in router advertisements for this interface.
Apply	Click Apply to save your changes to the Switch's run-time memory. The Switch loses these changes if it is turned off or loses power, so use the Save link on the top navigation panel to save your changes to the non-volatile memory when you are done configuring.
Clear	Click Clear to clear the fields to the factory defaults.
Cancel	Click Cancel to not save the configuration you make and return to the last screen.

24.10 IPv6 Neighbor Setup

Use this screen to view and configure static IPv6 neighbor entries in the Switch's IPv6 neighbor table to store the neighbor information permanently. Click **SYSTEM > IPv6 > IPv6 Neighbor Setup** to display the screen as shown next.

Figure 136 SYSTEM > IPv6 > IPv6 Neighbor Setup

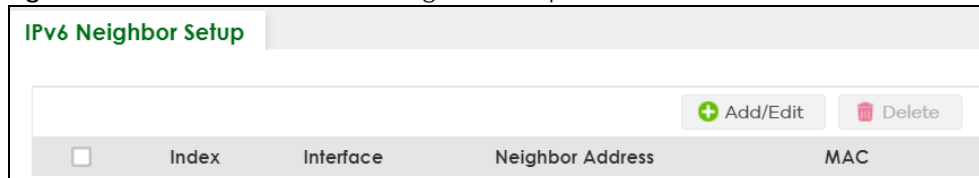

The following table describes the labels in this screen.

Table 76 SYSTEM > IPv6 > IPv6 Neighbor Setup

LABEL	DESCRIPTION
Index	This is the interface index number.
Interface	This is the name of the IPv6 interface you created.
Neighbor Address	This field displays the IPv6 address of the neighboring device which can be reached through the interface.
MAC	This field displays the MAC address of the neighboring device which can be reached through the interface.
	Select an entry's check box to select a specific entry. Otherwise, select the check box in the table heading row to select all entries.
Add/Edit	Click Add/Edit to add a new entry or edit a selected one.
Delete	Click Delete to remove the selected entries.

24.10.1 Add/Edit IPv6 Neighbor

Use this screen to create a static IPv6 neighbor entry. Click **Add/Edit**, or select an entry and click **Add/Edit** in the **SYSTEM > IPv6 > IPv6 Neighbor Setup** screen to display this screen.

Figure 137 SYSTEM > IPv6 > IPv6 Neighbor Setup > Add/Edit

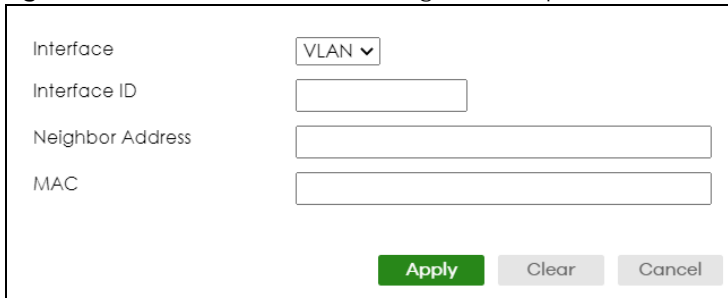

The following table describes the labels in this screen.

Table 77 SYSTEM > IPv6 > IPv6 Neighbor Setup > Add/Edit

LABEL	DESCRIPTION
Interface	Select the type of IPv6 interface for which you want to configure. The Switch supports the VLAN interface type for IPv6 at the time of writing.
Interface ID	Specify a unique identification number (from 1 to 4094) for the interface. A static IPv6 neighbor entry displays in the MONITOR > IPv6 Neighbor Table screen only when the interface ID is also created in the SYSTEM > Interface Setup screen. To have IPv6 function properly, you should configure a static VLAN with the same ID number in the SWITCHING > VLAN screens.
Neighbor Address	Specify the IPv6 address of the neighboring device which can be reached through the interface.
MAC	Specify the MAC address of the neighboring device which can be reached through the interface.
Apply	Click Apply to save your changes to the Switch's run-time memory. The Switch loses these changes if it is turned off or loses power, so use the Save link on the top navigation panel to save your changes to the non-volatile memory when you are done configuring.
Clear	Click Clear to clear the fields to the factory defaults.
Cancel	Click Cancel to not save the configuration you make and return to the last screen.

24.11 DHCPv6 Client Setup

Use this screen to configure the Switch's DHCP settings when it is acting as a DHCPv6 client. Click **SYSTEM > IPv6 > DHCPv6 Client Setup** to display the screen as shown next.

Figure 138 SYSTEM > IPv6 > DHCPv6 Client Setup

	Index	Interface	IA-NA	Rapid-Commit	DNS	Domain-List	Information Refresh Minimum
<input type="checkbox"/>	1	VLAN1	ON	OFF	OFF	OFF	86400
<input type="checkbox"/>	2	VLAN5	OFF	OFF	OFF	OFF	86400

The following table describes the labels in this screen.

Table 78 SYSTEM > IPv6 > DHCPv6 Client Setup

LABEL	DESCRIPTION
Index	This is the interface index number.
Interface	This is the name of the IPv6 interface you created.
IA-NA	This field displays whether the Switch obtains a non-temporary IP address from the DHCPv6 server.
Rapid-Commit	This field displays whether the Switch obtains information from the DHCPv6 server by a rapid two-message exchange.
DNS	This field displays whether the Switch obtains DNS server IPv6 addresses from the DHCPv6 server.
Domain-List	This field displays whether the Switch obtains a list of domain names from the DHCP server.
Information Refresh Minimum	This field displays the time interval (in seconds) at which the Switch exchanges other configuration information with a DHCPv6 server again.
	Select an entry's check box to select a specific entry.
Edit	Click Edit to edit the selected entry.

24.11.1 Edit DHCPv6 Client

Use this screen to configure the Switch's DHCP settings when it is acting as a DHCPv6 client. Select an entry and click **Edit** in the **SYSTEM > IPv6 > DHCPv6 Client Setup** screen to display this screen.

Figure 139 SYSTEM > IPv6 > DHCPv6 Client Setup > Edit

The following table describes the labels in this screen.

Table 79 SYSTEM > IPv6 > DHCPv6 Client Setup > Edit

LABEL	DESCRIPTION
Interface	Select the IPv6 interface you want to configure.
IA Type	<p>Select IA-NA to set the Switch to get a non-temporary IP address from the DHCPv6 server for this interface.</p> <p>Optionally, you can also select Rapid-Commit to have the Switch send its DHCPv6 Solicit message with a Rapid Commit option to obtain information from the DHCPv6 server by a rapid two-message exchange. The Switch discards any Reply messages that do not include a Rapid Commit option. The DHCPv6 server should also support the Rapid Commit option to have it work well.</p>
Options	Select DNS to have the Switch obtain DNS server IPv6 addresses and/or select Domain-List to have the Switch obtain a list of domain names from the DHCP server.
Information Refresh Minimum	Specify the time interval (from 600 to 4294967295 seconds) at which the Switch exchanges other configuration information with a DHCPv6 server again.
Apply	Click Apply to save your changes to the Switch's run-time memory. The Switch loses these changes if it is turned off or loses power, so use the Save link on the top navigation panel to save your changes to the non-volatile memory when you are done configuring.
Clear	Click Clear to clear the fields to the factory defaults.
Cancel	Click Cancel to not save the configuration you make and return to the last screen.

CHAPTER 25

Logins

25.1 Set Up Login Accounts

Up to five people (one administrator and four non-administrators) may access the Switch through Web Configurator at any one time.

- An administrator is someone who can both view and configure Switch changes. The user name for the Administrator is always **admin**. The default administrator password is **1234**.

Note: It is highly recommended that you change the default administrator password (**1234**).

- A non-administrator (user name is something other than **admin**) is someone who can view and/or configure Switch settings. The configuration right varies depending on the user's privilege level.

Click **SYSTEM > Logins** to view the screen as shown.

Figure 140 SYSTEM > Logins

Logins

Administrator

Old Password

New Password

Retype to confirm

 Please record your new password whenever you change it. The system will lock you out if you have forgotten your password.

Edit Logins

Login	User Name	Password	Retype to confirm	Privilege
1	<input type="text"/>	<input type="text"/>	<input type="text"/>	<input type="text"/>
2	<input type="text"/>	<input type="text"/>	<input type="text"/>	<input type="text"/>
3	<input type="text"/>	<input type="text"/>	<input type="text"/>	<input type="text"/>
4	<input type="text"/>	<input type="text"/>	<input type="text"/>	<input type="text"/>

Note: The input string in any field of this screen should not contain [?], [|], ['], ["] or [,]. In the **Password** fields, [space] is also not allowed.

The following table describes the labels in this screen.

Table 80 SYSTEM > Logins

LABEL	DESCRIPTION
Administrator	This is the default administrator account with the "admin" user name. You cannot change the default administrator user name.
Old Password	Type the existing system password (1234 is the default password when shipped).
New Password	Enter your new system password. You can enter up to 32 printable ASCII characters.
Retype to confirm	Retype your new system password for confirmation. You can enter up to 32 printable ASCII characters.
Edit Logins	You may configure passwords for up to four users. These users can have read-only or read/write access. Note: You can give users higher privileges through the Web Configurator or the CLI. For more information on assigning privileges through the CLI see the Ethernet Switch CLI Reference Guide.
Login	This is the index of an user account.
User Name	Set a user name (up to 32 printable ASCII characters except [?], [], ['], ["], or [.]).
Password	Enter your new system password.
Retype to confirm	Retype your new system password for confirmation.
Privilege	Type the privilege level for this user. At the time of writing, users may have a privilege level of 0, 3, 13, or 14 representing different configuration rights as shown below. <ul style="list-style-type: none"> • 0 – Display basic system information. • 3 – Display configuration or status. • 13 – Configure features except for login accounts, SNMP user accounts, the authentication method sequence and authorization settings, multiple logins, administrator and enable passwords, and configuration information display. • 14 – Configure login accounts, SNMP user accounts, the authentication method sequence and authorization settings, multiple logins, and administrator and enable passwords, and display configuration information. <p>Users can run command lines if the session's privilege level is greater than or equal to the command's privilege level. The session privilege initially comes from the privilege of the login account. For example, if the user has a privilege of 5, he or she can run commands that requires privilege level of 5 or less but not more.</p>
Apply	Click Apply to save your changes to the Switch's run-time memory. The Switch loses these changes if it is turned off or loses power, so use the Save link on the top navigation panel to save your changes to the non-volatile memory when you are done configuring.
Cancel	Click Cancel to begin configuring this screen afresh.

CHAPTER 26

SNMP

26.1 SNMP Overview

This chapter introduces the SNMP screens and shows you how to setup SNMP settings for management.

26.1.1 What You Can Do

- Use the **SNMP** screen ([Section 26.2 on page 192](#)) to configure general SNMP settings.
- Use the **SNMP User** screen ([Section 26.3 on page 194](#)) to create SNMP users for authentication with managers using SNMP v3 and associate them to SNMP groups.
- Use the **SNMP Trap Group** screen ([Section 26.4 on page 196](#)) to specify the types of SNMP traps that should be sent to each SNMP manager.
- Use the **SNMP Trap Port** screen ([Section 26.5 on page 197](#)) to enable/disable sending SNMP traps on a port.

26.2 Configure SNMP

Use this screen to configure your SNMP settings.

Click **SYSTEM** > **SNMP** to view the screen as shown.

Figure 141 SYSTEM > SNMP

SNMP SNMP User SNMP Trap Group SNMP Trap Port

General Setting

Version: v2c ▾

Get Community: public

Set Community: public

Trap Community: public

Trap Destination

Index	Version	IP	Port	Username
1	v2c ▾	0.0.0.0	162	
2	v2c ▾	0.0.0.0	162	
3	v2c ▾	0.0.0.0	162	
4	v2c ▾	0.0.0.0	162	

Apply Cancel

Note: The string of any field in this screen should not contain [?], [|], ['], ["] or [,].

The following table describes the labels in this screen.

Table 81 SYSTEM > SNMP

LABEL	DESCRIPTION
General Setting	
Use this section to specify the SNMP version and community (password) values.	
Version	Select the SNMP version for the Switch. The SNMP version on the Switch must match the version on the SNMP manager. Choose SNMP version 2c (v2c), SNMP version 3 (v3) or both (v3v2c). SNMP version 2c is backwards compatible with SNMP version 1.
Get Community	Enter the Get Community string, which is the password for the incoming Get- and GetNext-requests from the management station. The Get Community string is only used by SNMP managers using SNMP version 2c or lower.
Set Community	Enter the Set Community string, which is the password for incoming Set- requests from the management station. The Set Community string is only used by SNMP managers using SNMP version 2c or lower.
Trap Community	Enter the Trap Community string, which is the password sent with each trap to the SNMP manager. The Trap Community string is only used by SNMP managers using SNMP version 2c or lower.
Trap Destination	
Use this section to configure where to send SNMP traps from the Switch.	
Index	This is the index of a trap destination.
Version	Specify the version of the SNMP trap messages.
IP	Enter the IP addresses of up to four managers to send your SNMP traps to.

Table 81 SYSTEM > SNMP (continued)

LABEL	DESCRIPTION
Port	Enter the port number upon which the manager listens for SNMP traps.
Username	Enter the user name to be sent to the SNMP manager along with the SNMP v3 trap. This user name must match an existing account on the Switch (configured in the SYSTEM > SNMP > SNMP User screen).
Apply	Click Apply to save your changes to the Switch's run-time memory. The Switch loses these changes if it is turned off or loses power, so use the Save link on the top navigation panel to save your changes to the non-volatile memory when you are done configuring.
Cancel	Click Cancel to begin configuring this screen afresh.

26.3 Configure SNMP User

Use this screen to create SNMP users for authentication with managers using SNMP v3 and associate them to SNMP groups. An SNMP user is an SNMP manager. Click **SYSTEM > SNMP > SNMP User** to view the screen as shown.

Figure 142 SYSTEM > SNMP > SNMP User

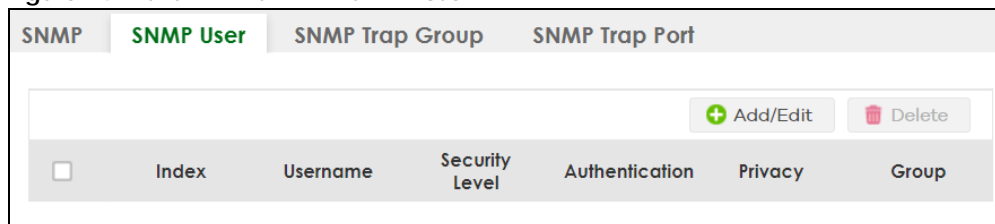

The following table describes the labels in this screen.

Table 82 SYSTEM > SNMP > SNMP User

LABEL	DESCRIPTION
Index	This is a read-only number identifying a login account on the Switch.
Username	This field displays the user name of a login account on the Switch.
Security Level	This field displays whether you want to implement authentication and/or encryption for SNMP communication with this user.
Authentication	This field displays the authentication algorithm used for SNMP communication with this user.
Privacy	This field displays the encryption method used for SNMP communication with this user.
Group	This field displays the SNMP group to which this user belongs.
	Select an entry's check box to select a specific entry. Otherwise, select the check box in the table heading row to select all entries.
Add/Edit	Click Add/Edit to add a new entry or edit a selected one.
Delete	Click Delete to remove the selected entries.

26.3.1 Add/Edit SNMP User

Use this screen to create SNMP users for authentication with managers using SNMP v3 and associate them to SNMP groups. An SNMP user is an SNMP manager. Click **Add/Edit**, or select an entry and click **Add/Edit** in the **SYSTEM > SNMP > SNMP User** screen to view the screen.

Note: Use the user name and password of the login accounts you specify in this screen to create accounts on the SNMP v3 manager.

Figure 143 SYSTEM > SNMP > SNMP User > Add/Edit

The screenshot shows a configuration form for adding or editing an SNMP user. The fields are as follows:

- Username:** A text input field.
- Security Level:** A dropdown menu currently set to "no auth".
- Authentication:** A dropdown menu currently set to "MD5".
- Privacy:** A dropdown menu currently set to "DES".
- Group:** A dropdown menu currently set to "admin".
- Password:** Two text input fields, one for Authentication and one for Privacy.
- Buttons:** "Apply" (green), "Clear" (grey), and "Cancel" (grey).

The following table describes the labels in this screen.

Table 83 SYSTEM > SNMP > SNMP User > Add/Edit

LABEL	DESCRIPTION
Username	Specify the user name (up to 32 printable ASCII characters) of a login account on the Switch. The string should not contain [?], [], ['], ["] or [,].
Security Level	Select whether you want to implement authentication and/or encryption for SNMP communication from this user. Choose: <ul style="list-style-type: none"> no auth – to use the user name as the password string to send to the SNMP manager. This is equivalent to the Get, Set and Trap Community in SNMP v2c. This is the lowest security level. auth – to implement an authentication algorithm for SNMP messages sent by this user. priv – to implement authentication and encryption for SNMP messages sent by this user. This is the highest security level. <p>Note: The settings on the SNMP manager must be set at the same security level or higher than the security level settings on the Switch.</p>
Authentication	Select an authentication algorithm. MD5 (Message Digest 5) and SHA (Secure Hash Algorithm) are hash algorithms used to authenticate SNMP data. SHA authentication is generally considered stronger than MD5, but is slower.
Password	Enter the password of up to 32 printable ASCII characters (except [?], [], ['], ["], [space], or [,]) for SNMP user authentication.
Privacy	Specify the encryption method for SNMP communication from this user. You can choose one of the following: <ul style="list-style-type: none"> DES – Data Encryption Standard is a widely used (but breakable) method of data encryption. It applies a 56-bit key to each 64-bit block of data. AES – Advanced Encryption Standard is another method for data encryption that also uses a secret key. AES applies a 128-bit key to 128-bit blocks of data.
Password	Enter the password of up to 32 printable ASCII characters (except [?], [], ['], ["], [space], or [,]) for encrypting SNMP packets.
Group	SNMP v3 adopts the concept of View-based Access Control Model (VACM) group. SNMP managers in one group are assigned common access rights to MIBs. Specify in which SNMP group this user is. <p>admin – Members of this group can perform all types of system configuration, including the management of administrator accounts.</p> <p>read-write – Members of this group have read and write rights, meaning that the user can create and edit the MIBs on the Switch, except the user account and AAA configuration.</p> <p>read-only – Members of this group have read rights only, meaning the user can collect information from the Switch.</p>

Table 83 SYSTEM > SNMP > SNMP User > Add/Edit (continued)

LABEL	DESCRIPTION
Apply	Click Apply to save your changes to the Switch's run-time memory. The Switch loses these changes if it is turned off or loses power, so use the Save link on the top navigation panel to save your changes to the non-volatile memory when you are done configuring.
Clear	Click Clear to clear the fields to the factory defaults.
Cancel	Click Cancel to not save the configuration you make and return to the last screen.

26.4 SNMP Trap Group

Use this screen to specify the types of SNMP traps that should be sent to each SNMP manager. Click **SYSTEM > SNMP > SNMP Trap Group** to view the screen as shown.

Figure 144 SYSTEM > SNMP > SNMP Trap Group

The screenshot shows the 'SNMP Trap Group' configuration page. At the top, there are navigation tabs: 'SNMP', 'SNMP User', 'SNMP Trap Group' (which is highlighted in green), and 'SNMP Trap Port'. Below the tabs is a 'Trap Destination IP' dropdown menu. The main content area is divided into several sections, each with a category heading and a list of traps. The categories are:

- System**: coldstart, warmstart, fanspeed, temperature, voltage, reset, timesync, loopguard, errdisable, poe, loginrecord, custom-ca.
- Interface**: linkup, linkdown, lldp, transceiver-ddm, storm-control, zuld, flex-link.
- AAA**: authentication, authorization, accounting.
- IP**: ping, traceroute.
- Switch**: stp, mactable, rmon, classifier.

At the bottom right of the screen, there are two buttons: 'Apply' (highlighted in green) and 'Cancel'.

The following table describes the labels in this screen.

Table 84 SYSTEM > SNMP > SNMP Trap Group

LABEL	DESCRIPTION
Trap Destination IP	Select one of your configured trap destination IP addresses. These are the IP addresses of the SNMP managers. You must first configure a trap destination IP address in the SYSTEM > SNMP > SNMP screen. Use the rest of the screen to select which traps the Switch sends to that SNMP manager.
	Select the individual SNMP traps that the Switch is to send to the SNMP station. The traps are grouped by category. Selecting a category in the heading row automatically selects all of the SNMP traps under that category. Clear the check boxes for individual traps that you do not want the Switch to send to the SNMP station. Clearing a category's check box automatically clears all of the category's trap check boxes (the Switch only sends traps from selected categories).
Apply	Click Apply to save your changes to the Switch's run-time memory. The Switch loses these changes if it is turned off or loses power, so use the Save link on the top navigation panel to save your changes to the non-volatile memory when you are done configuring.
Cancel	Click Cancel to begin configuring this screen afresh.

26.5 Enable or Disable Sending of SNMP Traps on a Port

Click **SYSTEM > SNMP > SNMP Trap Port** to view the screen as shown. Use this screen to set whether a trap received on the ports would be sent to the SNMP manager.

Figure 145 SYSTEM > SNMP > SNMP Trap Port (Standalone Mode)

Options:

Port	Active
*	<input type="checkbox"/>
1	<input checked="" type="checkbox"/>
2	<input checked="" type="checkbox"/>
3	<input checked="" type="checkbox"/>
4	<input checked="" type="checkbox"/>
5	<input checked="" type="checkbox"/>
6	<input checked="" type="checkbox"/>
7	<input checked="" type="checkbox"/>

Apply Cancel

Figure 146 SYSTEM > SNMP > SNMP Trap Port (Stacking Mode)

Options:

SLOT 1

Port	Active
1/*	<input type="checkbox"/>
1/1	<input checked="" type="checkbox"/>
1/2	<input checked="" type="checkbox"/>
1/3	<input checked="" type="checkbox"/>
1/4	<input checked="" type="checkbox"/>
1/5	<input checked="" type="checkbox"/>
1/6	<input checked="" type="checkbox"/>
1/7	<input checked="" type="checkbox"/>

Apply Cancel

The following table describes the labels in this screen.

Table 85 SYSTEM > SNMP > SNMP Trap Port

LABEL	DESCRIPTION
Options	Select the trap type you want to configure here.
SLOT	This field appears only in Stacking mode. Click the drop-down list to choose the slot number of the Switch in a stack.
Port	This field displays the port number. In Stacking mode, the first number represents the slot ID and the second is the port number. Please note that the default stacking ports (the last four ports of your Switch) cannot be configured. They are reserved for stacking only.
*	Settings in this row apply to all ports. Use this row only if you want to make some of the settings the same for all ports. Use this row first to set the common settings and then make adjustments on a port-by-port basis. Changes in this row are copied to all the ports as soon as you make them.
1/*	Settings in this row apply to all ports for the Switch represented by the slot ID (in Stacking mode). Use this row only if you want to make some of the settings the same for all ports. Use this row first to set the common settings and then make adjustments on a port-by-port basis. Note: Changes in this row are copied to all the ports as soon as you make them.
Active	Select this check box to enable the trap type of SNMP traps on this port. The Switch sends the related traps received on this port to the SNMP manager. Clear this check box to disable the sending of SNMP traps on this port.
Apply	Click Apply to save your changes to the Switch's run-time memory. The Switch loses these changes if it is turned off or loses power, so use the Save link on the top navigation panel to save your changes to the non-volatile memory when you are done configuring.
Cancel	Click Cancel to begin configuring this screen afresh.

26.6 Technical Reference

This section provides technical background information on the topics discussed in this chapter.

26.6.1 About SNMP

Simple Network Management Protocol (SNMP) is an application layer protocol used to manage and monitor TCP/IP-based devices. SNMP is used to exchange management information between the network management system (NMS) and a network element (NE). A manager station can manage and monitor the Switch through the network through SNMP version 1 (SNMPv1), SNMP version 2c or SNMP version 3. The next figure illustrates an SNMP management operation. SNMP is only available if TCP/IP is configured.

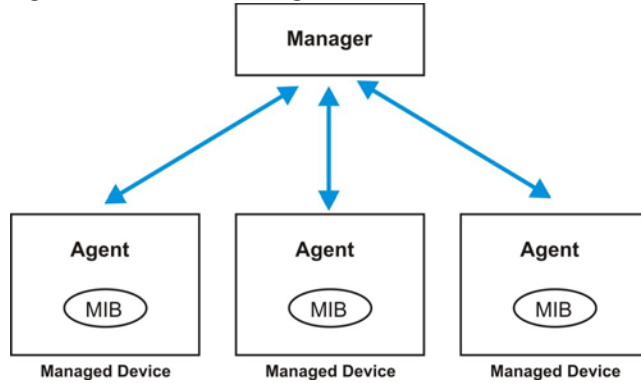
Figure 147 SNMP Management Model

An SNMP managed network consists of two main components: agents and a manager.

An agent is a management software module that resides in a managed Switch (the Switch). An agent translates the local management information from the managed Switch into a form compatible with SNMP. The manager is the console through which network administrators perform network management functions. It executes applications that control and monitor managed devices.

The managed devices contain object variables or managed objects that define each piece of information to be collected about a Switch. Examples of variables include number of packets received, node port status, and so on. A Management Information Base (MIB) is a collection of managed objects. SNMP allows a manager and agents to communicate for the purpose of accessing these objects.

SNMP itself is a simple request or response protocol based on the manager or agent model. The manager issues a request and the agent returns responses using the following protocol operations:

Table 86 SNMP Commands

LABEL	DESCRIPTION
Get	Allows the manager to retrieve an object variable from the agent.
GetNext	Allows the manager to retrieve the next object variable from a table or list within an agent. In SNMPv1, when a manager wants to retrieve all elements of a table from an agent, it initiates a Get operation, followed by a series of GetNext operations.
Set	Allows the manager to set values for object variables within an agent.
Trap	Used by the agent to inform the manager of some events.

SNMP v3 and Security

SNMP v3 enhances security for SNMP management. SNMP managers can be required to authenticate with agents before conducting SNMP management sessions.

Security can be further enhanced by encrypting the SNMP messages sent from the managers. Encryption protects the contents of the SNMP messages. When the contents of the SNMP messages are encrypted, only the intended recipients can read them.

Supported MIBs

A MIB is a collection of managed objects that is organized according to hierarchy. The objects define the attributes of the managed device, which includes the names, status, access rights, and data types. Each object can be addressed through an object identifier (OID).

MIBs let administrators collect statistics and monitor status and performance. The Switch uses standard public (RFC-defined) MIBs for standard functionality, and private MIBs that support additional Switch functionality. Private MIBs contain Switch specific managed objects.

To view a list of standard MIBs supported by your Switch, see the product datasheet at www.zyxel.com (**Support > Download Library > Datasheet**).

To get the private MIBs supported by your Switch, download (and unzip) the correct model MIB from www.zyxel.com (**Support > Download Library > MIB File**).

SNMP Traps

The Switch sends traps to an SNMP manager when an event occurs. The following tables outline the SNMP traps by category.

Table 87 SNMP System Traps

OPTION	OBJECT LABEL	OBJECT ID	DESCRIPTION
coldstart	coldStart	1.3.6.1.6.3.1.1.5.1	This trap is sent when the Switch is turned on.
warmstart	warmStart	1.3.6.1.6.3.1.1.5.2	This trap is sent when the Switch restarts.

Table 87 SNMP System Traps (continued)

OPTION	OBJECT LABEL	OBJECT ID	DESCRIPTION
stacking	zyStackingChannelUp	1.3.6.1.4.1.890.1.15 .3.97.4.1	This trap is sent when stacking channel changes from down to up.
	zyStackingChannelDown	1.3.6.1.4.1.890.1.15 .3.97.4.2	This trap is sent when stacking channel changes from up to down.
	zyStackingSlotAttach	1.3.6.1.4.1.890.1.15 .3.97.4.3	This trap is sent when a Switch is attached successfully into the stacking system.
	zyStackingSlotDetach	1.3.6.1.4.1.890.1.15 .3.97.4.4	This trap is sent when a Switch is detached from a stacking system.
	zyStackingNewMaster	1.3.6.1.4.1.890.1.15 .3.97.4.5	This trap is sent when a Switch is selected as the new master in stacking system.
	zyStackingUpgradeFirmwareFail	1.3.6.1.4.1.890.1.15 .3.97.4.6	This trap is sent when upgrade firmware fails on a stacked Switch.
	zyStackingNewBackup	1.3.6.1.4.1.890.1.15 .3.97.4.7	This trap is sent when a Switch is selected as the new backup in stacking system.
	zyStackingBackupTakeover	1.3.6.1.4.1.890.1.15 .3.97.4.8	This trap is sent when a master Switch is lost and replaced by a backup to become the new master.
	zyStackingNewMasterFromTakeover	1.3.6.1.4.1.890.1.15 .3.97.4.9	This trap is sent when a new master Switch takes over from a former master.
	zyStackingSyncConfFail	1.3.6.1.4.1.890.1.15 .3.97.4.10	This trap is sent when a configuration sync fails.
	zyStackingSysRestoreConfFail	1.3.6.1.4.1.890.1.15 .3.97.4.11	This trap is sent when a backup Switch becomes the master and configuration restore fails.
	zyStackingSlotInitFail	1.3.6.1.4.1.890.1.15 .3.97.4.12	This trap is sent when a newly attached Switch initialization fails.
	zyStackingSlotChangeIndex	1.3.6.1.4.1.890.1.15 .3.97.4.13	This trap is sent when a stacking slot index changes.
	zyStackingPriorityChange	1.3.6.1.4.1.890.1.15 .3.97.4.14	This trap is sent when the stacking priority changes. Stacking priority determines which is master.
zyStackingTopologyChange	1.3.6.1.4.1.890.1.15 .3.97.4.15	This trap is sent when a stacking topology (ring or chain) changes.	

Table 88 SNMP Interface Traps

OPTION	OBJECT LABEL	OBJECT ID	DESCRIPTION
linkup	linkUp	1.3.6.1.6.3.1.1.5.4	This trap is sent when the Ethernet link is up.
linkdown	linkDown	1.3.6.1.6.3.1.1.5.3	This trap is sent when the Ethernet link is down.
lldp	lldpRemTablesChange	1.0.8802.1.1.2.0.0.1	The trap is sent when entries in the remote database have any updates. Link Layer Discovery Protocol (LLDP), defined as IEEE 802.1ab, enables LAN devices that support LLDP to exchange their configured settings. This helps eliminate configuration mismatch issues.

Table 90 SNMP IP Traps

OPTION	OBJECT LABEL	OBJECT ID	DESCRIPTION
ping	pingProbeFailed	1.3.6.1.2.1.80.0.1	This trap is sent when a single ping probe fails.
	pingTestFailed	1.3.6.1.2.1.80.0.2	This trap is sent when a ping test (consisting of a series of ping probes) fails.
	pingTestCompleted	1.3.6.1.2.1.80.0.3	This trap is sent when a ping test is completed.
traceroute	traceRouteTestFailed	1.3.6.1.2.1.81.0.2	This trap is sent when a traceroute test fails.
	traceRouteTestCompleted	1.3.6.1.2.1.81.0.3	This trap is sent when a traceroute test is completed.

Table 91 SNMP Switch Traps

OPTION	OBJECT LABEL	OBJECT ID	DESCRIPTION
rmon	RmonRisingAlarm	1.3.6.1.2.1.16.0.1	This trap is sent when a variable goes over the RMON "rising" threshold.
	RmonFallingAlarm	1.3.6.1.2.1.16.0.2	This trap is sent when the variable falls below the RMON "falling" threshold.

CHAPTER 27

Stacking

27.1 Stacking Overview

This chapter introduces switch stacking and discusses how to configure stacking mode on the Switch to form a switch system.

27.1.1 What You Can Do

- Use the **Stacking Status** screen (Section 27.2 on page 204) to view the stacking system status and topology for the Switch.
- Use the **Stacking Setup** screen (Section 27.3 on page 207) to configure the stacking system.
- Use the **Stacking Port Setup** screen (Section 27.4 on page 209) to select the media type, SFP+ transceiver or Direct Attach Copper (DAC) that is attached to the 10 Gigabit interface.

27.1.2 What you need to know

Stacking is directly connecting Switches to form a larger system that behaves as a single Switch or a virtual chassis with increased port density.

Figure 148 Switch Stacking Concept

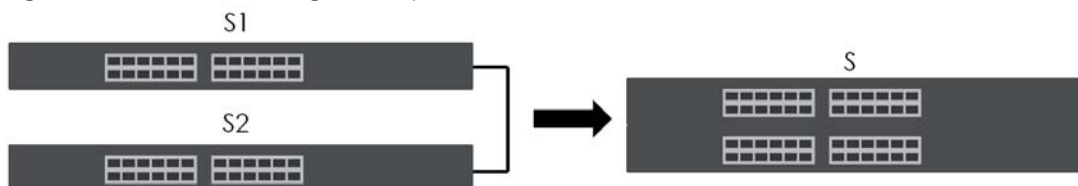

The last four combo ports of your Switch are dedicated for Switch stacking. At the time of writing, the Switch can only connect to another Switch of the same model and firmware version.

Note: Up to four Switches per stack are allowed.

You can manage each Switch in the stack from a master Switch using its Web Configurator or console. Each Switch supports up to two stacking channels. Use the master Switch to assign a 'slot ID' for each 'linecard' non-master Switch. 'Slot' refers to a Switch in the 'virtual chassis' stack.

Table 92 Stacking Channels and Ports

	STACKING CHANNEL	STACKING PORTS
XGS2220-30 / XGS2220-30HP / XGS2220-30F	1	27, 28
	2	29, 30

Table 92 Stacking Channels and Ports (continued)

	STACKING CHANNEL	STACKING PORTS
XGS2220-54 / XGS2220-54HP / XGS2220-54FP	1	51, 52
	2	53, 54

In stacking mode, the stacking channel is using link-aggregation. The default algorithm type is src-dst-mac, and is not configurable.

You can build a Switch stack using a ring or chain topology. In a ring topology, the last Switch is connected to the first.

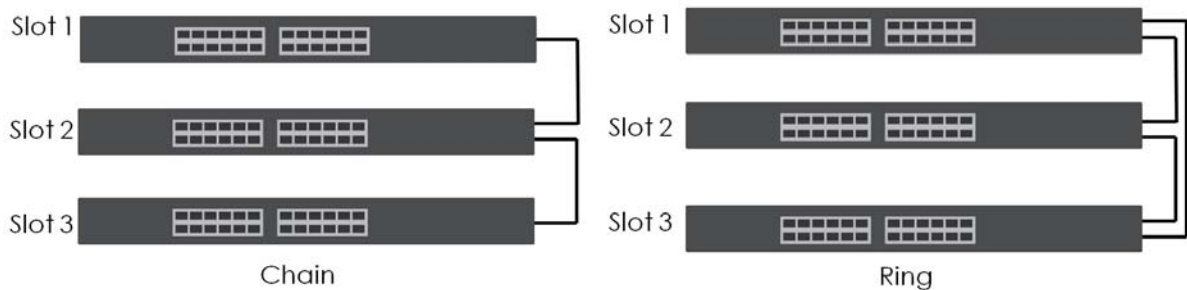
Figure 149 Stacking Topology

Use the master Switch to assign a 'slot ID' for each 'linecard' non-master Switch. 'Slot' refers to a Switch in the 'virtual chassis' stack.

The advantages of stacking are:

- High port density – for example, two 24-port Switches can become one 48-port logical Switch
- Centralized management – log into a single IP address of the master switch to control all Switches in the stacking system using the Web Configurator, CLI, SNMP or FTP
- Redundancy – Data redundancy allows traffic to be forwarded even if one Switch in the stack fails. Management redundancy lets you still manage the stack even if one Switch in the stack fails
- Modularity and hot-swappable – you can add, remove, or replace Switches to increase or decrease the stack with minimum disruption to ongoing network traffic.

27.2 Stacking Status

Click **SYSTEM > Stacking > Stacking Status** to display the screen as shown next.

Figure 150 SYSTEM > Stacking > Stacking Status

Stacking Status		Stacking Setup		Stacking Port Setup	
Stacking Status					
Slot	Name	Status	MAC Address	Role	Stacking Up Time
1	XS3800-28	active	bc:99:11:9b:b8:bc	master	0:05:32
Stacking Topology : Chain					
Slot	Stacking Channel 1			Stacking Channel 2	
No.	Neighbor	Speed	Neighbor	Speed	
*1	-	-	-	-	-

The following table describes the labels in this screen.

Table 93 SYSTEM > Stacking > Stacking Status

LABEL	DESCRIPTION
Slot	'Slot' refers to a Switch in the 'virtual chassis' stack. This field displays the slot ID of the stacked Switch. You can click the ID number to go to the Stacking Status Details screen.
Name	This field displays the model name of the stacked Switch.
Status	This field displays whether the stacked Switch is active or inactive in a stack system. Init means the slot ID is being initialized by the master Switch. active* means the Switch is in the stack, but some items failed to initiate. See the system logs for details. If the Switch is not a master, disconnect and reconnect the stacking port and wait. Restart the Switch if it still displays active* . If the Switch is a master, restart it or choose another master.
MAC address	This field displays the MAC address of the stacked Switch.
Role	This field displays whether the Switch is a master, backup or linecard. There's only one master and one backup Switch in the stacking mode; all others are linecard Switches.
Stacking Up Time	This field displays the time that the active Switch has been running in a stack. The master Switch records the time when a Switch in Stacking mode joins the stacking system. Time count will restart when master Switch changes.
Stacking Topology: Ring/Chain	
Slot	
No.	This field displays the slot ID number of the stacked Switch.
Stacking Channel1	
Neighbor	This field displays the neighbor Switch that is connected using slot channel 1 of the Switch.
Speed	This field displays the Ethernet speed of stacking channel 1 of the Switch.
Stacking Channel2	
Neighbor	This field displays the neighbor Switch that is connected to slot channel 2 of the Switch.
Speed	This field displays the Ethernet speed of stacking channel 2 of the Switch.

27.2.1 Stacking Slot Details

Click a slot number in **SYSTEM > Stacking > Stacking Status** to display the **Stacking Status Details** screen as shown next.

Figure 151 SYSTEM > Stacking > Stacking Status > Stacking Status Details

Stacking Status	Stacking Setup	Stacking Port Setup
Stacking Status > Stacking Status Details		
Stacking Status Details		
Slot	1	
Stacking	active	
Role	master	
Force Master Mode	inactive	
Priority	32	
Slot ID After Reboot	auto	
Stacking Status	active	
Master Capable	auto	
Stacking MAC Address	bc:99:11:9b:b8:c4	
Stacking Channel 1	down	
Stacking Channel 2	down	
System Up Time	0:10:12	
Stacking Up Time	0:09:35	
ZyNOS Version *Running / Flash	V4.80[ABML.2]b1 04/18/2023	

The following table describes the labels in this screen.

Table 94 SYSTEM > Stacking > Stacking Status > Stacking Status Details

LABEL	DESCRIPTION
Slot	This field displays the slot ID of the Switch.
Stacking	This field displays whether the Switch is active in the stacking system.
Role	This field displays whether the stacked Switch is a master, backup or linecard Switch.
Force Master Mode	This field displays whether the Force Master Mode is enabled or disabled on this Switch. The Force Master Mode forces this Switch to become a master Switch. This Switch will have the highest priority over all other Switch in the stack. If two Switches are set as masters, they will have the same priority level, but the Switch that has the longest active run-time will be selected as the master Switch automatically.
Priority	This field displays the priority level of the Switch. A higher number represents higher priority.
Slot ID After Reboot	This field displays the slot ID of the Switch after a reboot. You can save the slot ID of the Switch after a reboot by clicking Freeze in the SYSTEM > Stacking > Stacking Setup screen.
Stacking Status	This field displays whether the stacked Switch is active or inactive in a stack system. Init means the slot ID is being initialized by the master Switch. active* means the Switch is in the stack, but some items failed to initiate. See the system logs for details. If the Switch is not a master, disconnect and reconnect the stacking port and wait. Restart the Switch if it still displays active* . If the Switch is a master, restart it or choose another master.
Master Capable	This field displays whether the Switch has capacity to become a master Switch. Auto means the stack system master election process will determine if the Switch can be assigned as a master Switch.
Stacking MAC Address	This field displays the stacking Switch MAC address.
Stacking Channel 1	This field displays the status of the port stacking channel 1 of the Switch. It will display up for active or down for inactive.
Stacking Channel 2	This field displays the status of the port stacking channel 2 of the Switch. It will display up for active or down for inactive.
System Up Time	This field displays how long the Switch has been running since it last restarted or was turned on.

Table 94 SYSTEM > Stacking > Stacking Status > Stacking Status Details (continued)

LABEL	DESCRIPTION
Stacking Up Time	This field displays the time that the active Switch has been running in a stack. The master Switch records the time when a Switch in Stacking mode joins the stacking system. Time count will restart when master Switch changes.
ZyNOS Version *Running / Flash	This field displays the ZyNOS firmware that is currently running on the Switch.

27.3 Stacking Setup

A supported Switch can change between stacking and standalone mode by enabling the **Active** switch (**ON/OFF**) in the **SYSTEM > Stacking > Stacking Setup** screen.

Note: When you change modes, all configurations (except user accounts), including **Running Config**, **Config1**, **Config2** and **Custom Default** configuration, will be erased. Only user accounts will be kept after mode changing if saved to a configuration file. The Switch will reboot with the Stacking/Standalone factory default settings on the current configuration file. You should back up current configurations if you want to reload them. Note that a configuration file of a mode (Standalone or Stacking) can only be applied under the same mode.

Note: When the Switch changes from Standalone mode to Stacking mode, it will use the static IP address 192.168.1.1 by default; when the Switch changes from Stacking mode back to Standalone mode, it will use a DHCP-assigned IP address obtained from the DHCP server. (if the Switch cannot obtain an IP address from the DHCP server, it will use the default IP 192.168.1.1 until it can get a DHCP-assigned IP)

Stacking will automatically choose a master Switch in a stack but you can overwrite that by actively forcing a Switch to become a master Switch. In the **SYSTEM > Stacking > Stacking Setup** screen, click the switch on to enable **Force Master Mode** to choose the master Switch. This master Switch will have the highest priority over all other stacked Switches even when they have the same priority value.

If two or more Switches have **Force Master Mode** enabled, they have the same **System Priority**. Then the Switch with the longest up-time is selected. Uptime is measured in increments of 10 minutes. The Switch with the higher number of increments is selected. If they have the same uptime, then the Switch with the lowest MAC address will be the master.

This is the master election priority in a stack system:

- 1 Active **Force Master Mode**
- 2 Highest **System Priority**
- 3 Longest **System Up Time**
- 4 Lowest MAC Address

Note: Master election occurs when a stacking port link status changes (up or down). The link

status changes when (for example):

- a stacking port cable is disconnected
- a Switch in the stack reboots (as happens after you change stacking mode to standalone)
- you add a Switch to the stack or
- a Switch in the stack shuts down.

Use the following procedure to create a stack:

- 1 Select a Switch to be the master. Change its mode to Stacking mode. You will see a message asking you to confirm the change. Click **YES** to confirm. The Switch will reboot automatically using the current configuration file (with factory default settings) and the default IP interface settings in Stacking mode.

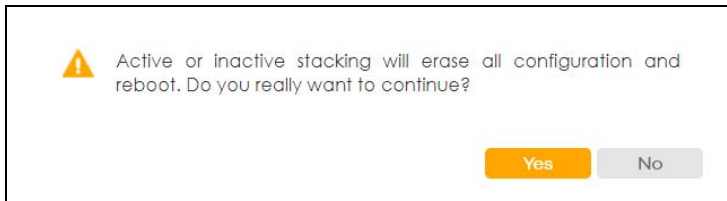

- 2 After reboot completes, the master LED will turn on.
- 3 Configure the Switch stacking priority to a high value, such as 63.
- 4 Change a second Switch to stacking mode and wait for it to finish rebooting automatically. This master LED will also turn on.
- 5 Connect the two Switches using the stacking ports for the Switch defined.
- 6 The second Switch master LED will then turn off, and its **Sys** LED will blink while it is initializing. Please wait until it stops blinking, indicating that it has joined the stack.
- 7 Repeat steps 4 to 6 to connect other Switches to the stack.

When the Switch is in Stacking mode, the Web Configurator will change port and VLAN port settings to support the stacking mode.

Click **SYSTEM > Stacking > Stacking Setup** to see the following screen.

Figure 152 SYSTEM > Stacking > Stacking Setup

The following table describes the labels in this screen.

Table 95 SYSTEM > Stacking > Stacking Setup

LABEL	DESCRIPTION
Active	Enable the ON/OFF switch to put the Switch in Stacking mode. This will erase the Running Configuration , Config1 and Config2 . The master Switch's login will remain unchanged. If you want to reload a previous configuration, please back one up first.
Apply	Click Apply to activate Stacking mode/go back to Standalone mode.
Cancel	Click Cancel to note save your changes.
Force Master Mode	Enable the ON/OFF switch to force this Switch to become a master Switch.
System Priority	Enter a number (from 1 to 63) to assign a priority for the stacking Switch. The higher the number, the higher the priority.
Apply	Click Apply to save changes made to the Force Master Mode and System Priority fields.
Cancel	Click Cancel to clear the Active Force Master Mode and System Priority fields.
Slot ID	
Slot ID Freeze	Click the Freeze button to have the Switch retain its slot ID after reboot.
Slot	This field displays the slot or port channel of the stacked Switch.
MAC	This field displays the MAC address of the stacked Switch.
Type	This field displays the model name of the Switch.
Slot ID after reboot	Choose Auto to have a new slot ID assigned after reboot. If you want to keep the original slot ID after reboot, you can click Freeze or select an ID in the Slot ID after reboot list box.
Apply	Click Apply to save the Slot ID after reboot field.
Cancel	Click Cancel to clear the Slot ID after reboot field.

27.4 Stacking Port Setup

Click **SYSTEM > Stacking > Stacking Port Setup** to display the screen as shown next.

Figure 153 SYSTEM > Stacking > Stacking Port Setup

Port	Media Type
*	SFP+
25	SFP+
26	SFP+
27	SFP+
28	SFP+

The following table describes the labels in this screen.

Table 96 SYSTEM > Stacking > Stacking Port Setup

LABEL	DESCRIPTION
Port	This is the port index number. These are the default stacking ports (the last four ports of your Switch). They are reserved for stacking only.
*	<p>Settings in this row apply to all ports.</p> <p>Use this row only if you want to make some settings the same for all ports. Use this row first to set the comment settings and then make adjustments on a port-by-port basis.</p> <p>Note: Changes in this row are copied to all the ports as soon as you make them.</p>
Media Type	<p>You can insert either an SFP+ transceiver or an SFP+ Direct Attach Copper (DAC) cable into the 10 Gigabit interface of the Switch.</p> <p>Select the media type (SFP+ or DAC10G) of the SFP+ module that is attached to the 10 Gigabit interface.</p>

CHAPTER 28

Switch Setup

28.1 Switch Setup Overview

Use this screen to do the Switch's basic setup configuration, for example, VLAN (Virtual Local Area Network) type, enabling switching protocols, and MAC learning aging time setup.

28.1.1 Introduction to VLANs

A VLAN (Virtual Local Area Network) allows a physical network to be partitioned into multiple logical networks. Devices on a logical network belong to one group. A device can belong to more than one group. With VLAN, a device cannot directly talk to or hear from devices that are not in the same groups; the traffic must first go through a router.

In MTU (Multi-Tenant Unit) applications, VLAN is vital in providing isolation and security among the subscribers. When properly configured, VLAN prevents one subscriber from accessing the network resources of another on the same LAN, thus a user will NOT see the printers and hard disks of another user in the same building.

VLAN also increases network performance by limiting broadcasts to a smaller and more manageable logical broadcast domain. In traditional switched environments, all broadcast packets go to each and every individual port. With VLAN, all broadcasts are confined to a specific broadcast domain.

Note: VLAN is unidirectional; it only governs outgoing traffic.

28.2 Switch Setup

Click **SYSTEM** > **Switch Setup** in the navigation panel to display the screen as shown. The VLAN setup screens change depending on whether you choose **802.1Q** or **Port Based** in the **VLAN Type** field in this screen.

Figure 154 SYSTEM > Switch Setup (Standalone Mode)

Switch Setup

VLAN Type 802.1Q Port Based

Bridge Control Protocol Transparency OFF

MAC Address Learning

Aging Time seconds

ARP Aging Time

Aging Time seconds

GARP Timer

Join Timer milliseconds

Leave Timer milliseconds

Leave All Timer milliseconds

Figure 155 Basic Setting > Switch Setup (Stacking Mode)

Switch Setup

Bridge Control Protocol Transparency OFF

MAC Address Learning

Aging Time seconds

ARP Aging Time

Aging Time seconds

GARP Timer

Join Timer milliseconds

Leave Timer milliseconds

Leave All Timer milliseconds

The following table describes the labels in this screen.

Table 97 SYSTEM > Switch Setup

LABEL	DESCRIPTION
VLAN Type (Standalone mode only)	Choose 802.1Q or Port Based . The SWITCHING > VLAN link and its sub-links only appears in the navigation panel when you choose 802.1Q VLAN type in this screen. The Switch does not have port-based VLAN available in stacking mode (Active is enabled in SYSTEM > Stacking > Stacking Setup), so this field does not display in stacking mode.
Bridge Control Protocol Transparency	Enable the ON/OFF switch to allow the Switch to handle bridging control protocols (STP, for example). You also need to define how to treat a BPDU in the PORT > Port Setup screen.
MAC Address Learning	
MAC address learning reduces outgoing traffic broadcasts. For MAC address learning to occur on a port, the port must be active.	
Aging Time	Enter a time from 10 to 1000000 seconds. This is how long all dynamically learned MAC addresses remain in the MAC address table before they age out (and must be relearned).
ARP Aging Time	
Aging Time	Enter a time from 60 to 1000000 seconds. This is how long dynamically learned ARP entries remain in the ARP table before they age out (and must be relearned). The setting here applies to ARP entries which are newly added in the ARP table after you click Apply .
GARP Timer: Switches join VLANs by making a declaration. A declaration is made by issuing a Join message using GARP. Declarations are withdrawn by issuing a Leave message. A Leave All message terminates all registrations. GARP timers set declaration timeout values. See the chapter on VLAN setup for more background information.	
Join Timer	Join Timer sets the duration of the Join Period timer for GVRP in milliseconds. Each port has a Join Period timer. The allowed Join Time range is between 100 and 65535 milliseconds; the default is 200 milliseconds. See the chapter on VLAN setup for more background information.
Leave Timer	Leave Timer sets the duration of the Leave Period timer for GVRP in milliseconds. Each port has a single Leave Period timer. Leave Time must be two times larger than Join Timer ; the default is 600 milliseconds.
Leave All Timer	Leave All Timer sets the duration of the Leave All Period timer for GVRP in milliseconds. Each port has a single Leave All Period timer. Leave All Timer must be larger than Leave Timer .
Apply	Click Apply to save your changes to the Switch's run-time memory. The Switch loses these changes if it is turned off or loses power, so use the Save link on the top navigation panel to save your changes to the non-volatile memory when you are done configuring.
Cancel	Click Cancel to begin configuring this screen afresh.

CHAPTER 29

Syslog Setup

29.1 Syslog Overview

This chapter explains the **Syslog** screens.

The syslog protocol allows devices to send event notification messages across an IP network to syslog servers that collect the event messages. A syslog-enabled device can generate a syslog message and send it to a syslog server.

Syslog is defined in RFC 3164. The RFC defines the packet format, content and system log related information of syslog messages. Each syslog message has a facility and severity level. The syslog facility identifies a file in the syslog server. Refer to the documentation of your syslog program for details. The following table describes the syslog severity levels.

Table 98 Syslog Severity Levels

CODE	SEVERITY
0	Emergency: The system is unusable.
1	Alert: Action must be taken immediately.
2	Critical: The system condition is critical.
3	Error: There is an error condition on the system.
4	Warning: There is a warning condition on the system.
5	Notice: There is a normal but significant condition on the system.
6	Informational: The syslog contains an informational message.
7	Debug: The message is intended for debug-level purposes.

29.1.1 What You Can Do

Use the **Syslog Setup** screen ([Section 29.2 on page 214](#)) to configure the device's system logging settings and configure a list of external syslog servers.

29.2 Syslog Setup

The syslog feature sends logs to an external syslog server. Use this screen to configure the device's system logging settings and configure a list of external syslog servers.

Click **SYSTEM > Syslog Setup** in the navigation panel to display this screen.

Figure 156 SYSTEM > Syslog Setup

Syslog Setup

Active OFF

Logging Type	Active	Facility
System	<input type="checkbox"/>	local use 0 ▼
Interface	<input type="checkbox"/>	local use 0 ▼
Switch	<input type="checkbox"/>	local use 0 ▼
AAA	<input type="checkbox"/>	local use 0 ▼
IP	<input type="checkbox"/>	local use 0 ▼

Apply **Cancel**

Syslog Server Setup

<input type="checkbox"/>	Index	Active	IP Address	UDP Port	Log Level
<input type="button" value="+ Add/Edit"/> <input type="button" value="Delete"/>					

The following table describes the labels in this screen.

Table 99 SYSTEM > Syslog Setup

LABEL	DESCRIPTION
Syslog Setup	
Active	Enable the switch button to turn on syslog (system logging) and then configure the syslog setting.
Logging Type	This column displays the names of the categories of logs that the device can generate.
Active	Select this option to set the device to generate logs for the corresponding category.
Facility	The log facility allows you to send logs to different files in the syslog server. Refer to the documentation of your syslog program for more details.
Apply	Click Apply to save your changes to the Switch's run-time memory. The Switch loses these changes if it is turned off or loses power, so use the Save link on the top navigation panel to save your changes to the non-volatile memory when you are done configuring.
Cancel	Click Cancel to begin configuring this screen afresh.
Syslog Server Setup	
Index	This is the index number of a syslog server entry.
Active	This field displays if the device is activated to send logs to the syslog server.
IP Address	This field displays the IP address of the syslog server.
UDP Port	This field displays the port of the syslog server.
Log Level	This field displays the severity level of the logs that the device is to send to this syslog server.
	Select an entry's check box to select a specific entry. Otherwise, select the check box in the table heading row to select all entries.
Add/Edit	Click Add/Edit to add a new entry or edit a selected one.
Delete	Click Delete to remove the selected entries.

29.2.1 Add/Edit a Syslog Server

Use this screen to configure an external syslog server.

Click **Add/Edit**, or select an entry and click **Add/Edit** in the **SYSTEM > Syslog Setup** screen to display this screen.

Figure 157 SYSTEM > Syslog Setup > Add/Edit

The following table describes the labels in this screen.

Table 100 SYSTEM > Syslog Setup > Add/Edit

LABEL	DESCRIPTION
Active	Enable the switch button to have the device send logs to this syslog server. Clear the check box if you want to create a syslog server entry but not have the device send logs to it (you can edit the entry later).
Server Address	Enter the IPv4 or IPv6 address of the syslog server.
UDP Port	The default syslog server port is 514. If your syslog server uses a different port, configure the one it uses here.
Log Level	Select the severity levels of the logs that you want the device to send to this syslog server. The lower the number, the more critical the logs are.
Apply	Click Apply to save your changes to the Switch's run-time memory. The Switch loses these changes if it is turned off or loses power, so use the Save link on the top navigation panel to save your changes to the non-volatile memory when you are done configuring.
Clear	Click Clear to clear the fields to the factory defaults.
Cancel	Click Cancel to not save the configuration you make and return to the last screen.

CHAPTER 30

Time Range

30.1 Time Range Overview

You can set a time range for time-oriented features such as Classifier ACL (Access Control List) rule which categorizes data packets into different network traffic flow. The advantage of the time range feature is that it allows you to schedule the active time of configurations.

The time range can be configured in two ways – Absolute and Periodic. Absolute is a fixed time range with a start and end time. Periodic is recurrence of a time range and does not have an end time.

30.1.1 What You Can Do

Use the **Time Range** screen ([Section 30.2 on page 217](#)) to view or define a schedule on the Switch.

30.2 Configuring Time Range

Click **SYSTEM > Time Range** in the navigation panel to display the screen as shown.

Figure 158 SYSTEM > Time Range

<input type="checkbox"/>	Index	Name	Type	Range
<input type="checkbox"/>	1	schedule_4-14	Absolute	start 2022/04/14 06:05 end 2022/05/24 00:00
<input type="checkbox"/>	2	schedule_Repeat	Periodic	Monday 00:00 to Friday 17:00

The following table describes the labels in this screen.

Table 101 SYSTEM > Time Range

LABEL	DESCRIPTION
	Select an entry's check box to select a specific entry. Otherwise, select the check box in the table heading row to select all entries.
Index	This field displays the index number of the rule.
Name	This field displays the descriptive name for this rule. This is for identification purpose only. You can enter up to 32 printable ASCII characters except [?], [], ['], ["] or [,].

Table 101 SYSTEM > Time Range (continued)

LABEL	DESCRIPTION
Type	This displays the schedule type of the time range rule. Absolute An one-time schedule. One-time schedules begin on a specific start date and time and end on a specific stop date and time. One-time schedules are useful for long holidays and vacation periods. Periodic A recurring schedule. Recurring schedules begin at a specific start time and end at a specific stop time on selected days of the week (Sunday, Monday, Tuesday, Wednesday, Thursday, Friday, and Saturday). Recurring schedules are useful for defining the workday and off-work hours.
Range	This field displays the time periods to which this schedule applies.
Add/Edit	Click Add/Edit to add a new schedule rule or edit a selected one.
Delete	Click Delete to remove the selected rules.

30.2.1 Add/Edit Time Range

This screen allows you to create a new time range or edit an existing one.

To access this screen, click the **Add/Edit** button or select an entry from the list and click the **Add/Edit** button.

Figure 159 SYSTEM > Time Range > Add/Edit

The screenshot shows the 'Add/Edit' screen for Time Range. It includes a 'Name' input field, a 'Type' section with 'Absolute' selected, and 'Start' and 'End' date and time pickers. Below, the 'Periodic' section is unselected, but it shows a day of the week picker (Monday) and time pickers. At the bottom right are 'Apply', 'Clear', and 'Cancel' buttons.

The following table describes the labels in this screen.

Table 102 SYSTEM > Time Range > Add/Edit

LABEL	DESCRIPTION
Name	Enter a descriptive name for this rule for identifying purposes. The string should not contain [?], [], ['], ["] or [,].
Type	Select Absolute to create a one-time schedule. One-time schedules begin on a specific start date and time and end on a specific stop date and time. One-time schedules are useful for long holidays and vacation periods. Alternatively, select Periodic to create a recurring schedule. Recurring schedules begin at a specific start time and end at a specific stop time on selected days of the week (Sunday, Monday, Tuesday, Wednesday, Thursday, Friday, and Saturday). Recurring schedules are useful for defining the workday and off-work hours.

Table 102 SYSTEM > Time Range > Add/Edit (continued)

LABEL	DESCRIPTION
Absolute	This section is available only when you set Type to Absolute .
Start	Specify the year, month, day, hour and minute when the schedule begins.
End	Specify the year, month, day, hour and minute when the schedule ends.
Periodic	<p>This section is available only when you set Type to Periodic.</p> <p>Select the first option if you want to define a recurring schedule for a consecutive time period. You then select the day of the week, hour and minute when the schedule begins and ends respectively.</p> <p>Select the second option if you want to define a recurring schedule for multiple non-consecutive time periods. You need to select each day of the week the recurring schedule is effective. You also need to specify the hour and minute when the schedule begins and ends each day. The schedule begins and ends in the same day.</p>
Apply	Click Apply to save your changes to the Switch's run-time memory. The Switch loses these changes if it is turned off or loses power, so use the Save link on the top navigation panel to save your changes to the non-volatile memory when you are done configuring.
Clear	Click Clear to clear the fields to the factory defaults.
Cancel	Click Cancel to not save the configuration you make and return to the last screen.

CHAPTER 31

PORT

The following chapters introduces the configurations of the links under the **PORT** navigation panel.

Quick links to chapters:

- [Auto PD Recovery](#) (for PoE models only)
- [Flex Link](#)
- [Green Ethernet](#)
- [Link Aggregation](#)
- [Link Layer Discovery Protocol \(LLDP\)](#)
- [OAM](#)
- [PoE Setup](#) (for PoE models only)
- [Port Setup](#)
- [ZULD](#)

CHAPTER 32

Auto PD Recovery

32.1 Auto PD Recovery (for PoE models only) Overview

Things can go wrong with any network devices. A PD (for example, IP camera) may slow down or freeze and need to be restarted if it is overworked or a bug causes a memory leak. When a connected PD ceases to respond, Automatic PD Recovery allows the Switch to restart the PD by turning it off and on without the need for on-site troubleshooting.

32.1.1 What You Can Do

Use the **Auto PD Recovery** screen ([Section 32.2 on page 221](#)) to enable and configure automatic PD recovery on the Switch.

32.2 Auto PD Recovery

This screen lets you turn on automatic PD recovery on the Switch and its Ethernet ports. You can configure whether the Switch uses LLDP or ping to check the current status of a connected PD.

The ping is sent through the Switch's default management IP address to the designated port. To ping the PD, the port must share the same VLAN as the Switch's management VLAN.

Figure 160 Auto PD Recovery Application



The PD may stop responding to the Switch's detection over ping or LLDP during firmware upgrade. Disable the Auto PD Recovery function to prevent damage to the PD caused by a power cutoff during firmware upgrade.

Note: The following screens are available for the PoE models only.

To open this screen, click **PORT > Auto PD Recovery**.

Figure 161 PORT > Auto PD Recovery (Standalone Mode)

Auto PD Recovery

Active

Port	Active	Mode	Neighbor Name	Neighbor IP	Polling Interval (sec)	Polling Count	Action	Resume Polling Interval (sec)	PD Reboot Count
*	<input type="checkbox"/>	LLDP			20	3	Reboot-Alarm	600	1
1	<input type="checkbox"/>	LLDP	12A3_84		20	3	Reboot-Alarm	600	1
2	<input type="checkbox"/>	LLDP	12A3_84		20	3	Reboot-Alarm	600	1
3	<input type="checkbox"/>	LLDP	12A3_84		20	3	Reboot-Alarm	600	1
4	<input type="checkbox"/>	LLDP	12A3_84		20	3	Reboot-Alarm	600	1
5	<input type="checkbox"/>	LLDP	12A3_84		20	3	Reboot-Alarm	600	1
6	<input type="checkbox"/>	LLDP	12A3_84		20	3	Reboot-Alarm	600	1
7	<input type="checkbox"/>	LLDP	12A3_84		20	3	Reboot-Alarm	600	1
8	<input type="checkbox"/>	LLDP	12A3_84		20	3	Reboot-Alarm	600	1
9	<input type="checkbox"/>	LLDP	12A3_84		20	3	Reboot-Alarm	600	1

Apply Cancel

Figure 162 PORT > Auto PD Recovery (Stacking Mode)

Auto PD Recovery

Active

SLOT 1

Port	Active	Mode	Neighbor Name	Neighbor IP	Polling Interval (sec)	Polling Count	Action	Resume Polling Interval (sec)	PD Reboot Count
1/*	<input type="checkbox"/>	LLDP			20	3	Reboot-Alarm	600	1
1/1	<input type="checkbox"/>	LLDP			20	3	Reboot-Alarm	600	1
1/2	<input type="checkbox"/>	LLDP			20	3	Reboot-Alarm	600	1
1/3	<input type="checkbox"/>	LLDP			20	3	Reboot-Alarm	600	1
1/4	<input type="checkbox"/>	LLDP			20	3	Reboot-Alarm	600	1
1/5	<input type="checkbox"/>	LLDP			20	3	Reboot-Alarm	600	1
1/6	<input type="checkbox"/>	LLDP			20	3	Reboot-Alarm	600	1
1/7	<input type="checkbox"/>	LLDP			20	3	Reboot-Alarm	600	1
1/8	<input type="checkbox"/>	LLDP			20	3	Reboot-Alarm	600	1

Apply Cancel

The following table describes the labels in this screen.

Table 103 PORT > Auto PD Recovery

LABEL	DESCRIPTION
Active	Select this option to enable Auto PD Recovery on the Switch.
Slot	This field appears only in Stacking mode. Click the drop-down list to choose the slot number of the Switch in a stack.
Port	This field displays the port number. In stacking mode, the first number represents the slot ID and the second is the port number. Please note that the default stacking ports (the last two ports of your Switch) cannot be configured. They are reserved for stacking only.
*	Settings in this row apply to all ports. Use this row only if you want to make some settings the same for all ports. Use this row first to set the common settings and then make adjustments on a port-by-port basis. Changes in this row are copied to all the ports as soon as you make them.
Active	Select Active to enable Auto PD Recovery on the ports.

Table 103 PORT > Auto PD Recovery (continued)

LABEL	DESCRIPTION
Mode	Select LLDP to have the Switch passively monitor current status of the connected PD by reading LLDP packets from the PD on the port. The Switch also sends out LLDP packets to the PD to update the Switch Neighbor table on the PD. Select Ping to have the Switch ping the IP address of the connected PD to test whether the PD is reachable or not.
Neighbor Name	If Mode is set to LLDP , the system name of the connected PD displays automatically.
Neighbor IP	If Mode is set to Ping and the PD supports LLDP, the connected PD's IPv4 or IPv6 address to which the Switch sends ping requests will display automatically. If not, enter the IP address manually.
Test	Click Test to have the Switch test the connection by sending a ping request to the IP address.
Polling Interval (sec)	Specify the number of seconds the Switch waits for a response before sending another ping request. For example, the Switch will try to detect the PD status by performing ping requests every 20 seconds.
Polling Count	Specify how many times the Switch is to resend a ping request before considering the PD unreachable. For example, If there is no ping reply from the PD after the Polling Interval (sec) has elapsed, Polling Count starts from 1. After Polling Count reaches 3, the PD Health status LED will turn to red in the MONITOR > Neighbor screen. The Switch will then perform your choice in the Action field.
Action	Set the action to take when the connected PD has stopped responding. Select Reboot-Alarm to have the Switch turn OFF the power of the connected PD (the connecting port is detected as link-down) and turn it back ON again to restart the PD after sending an SNMP trap and generating a log message. When restarting, the PD entry disappears from the Switch's LLDP table and the PD Health status LED will turn to yellow in the MONITOR > Neighbor screen. Select Alarm to have the Switch send an SNMP trap and generate a log message.
Resume Polling Interval (sec)	Specify the number of seconds the Switch waits before monitoring the PD status again after it restarts the PD on the port.
PD Reboot Count	Specify how many times the Switch attempts to restart the PD on the port. The PD Reboot Count will reset <ul style="list-style-type: none"> • as soon as a ping is successful, • or when any modification to the Auto PD Recovery screen is applied, • or after restarting the Switch.
Resume Power Interval (sec)	Specify the number of seconds the Switch waits before supplying power to the connected PD again after it restarts the PD on the port.
Apply	Click Apply to save your changes to the Switch's run-time memory. The Switch loses these changes if it is turned off or loses power, so use the Save link on the top navigation panel to save your changes to the non-volatile memory when you are done configuring.
Cancel	Click this to reset the values in this screen to their last-saved values.

32.2.1 Activate the Automatic PD Recovery

Follow the steps below to activate the automatic PD recovery.

- 1 In the **PORT > Auto PD Recovery** screen, activate the feature.

Figure 163 Auto PD Recovery (Ping Mode)

Auto PD Recovery

Active

Port	Active	Mode	Neighbor Name	Neighbor IP	Test	Polling Interval (sec)	Polling Count	Action	Resume Polling Interval (sec)	PD Reboot Count
*	<input type="checkbox"/>	LLDP			Test			Reboot-Alarm		
1	<input checked="" type="checkbox"/>	Ping		10.214.45.49	Test	20	3	Reboot-Alarm	600	1
2	<input type="checkbox"/>	LLDP	12A3_84		Test	20	3	Reboot-Alarm	600	1
3	<input checked="" type="checkbox"/>	Ping		10.214.45.55	Test	20	3	Reboot-Alarm	600	1
4	<input type="checkbox"/>	LLDP			Test	20	3	Reboot-Alarm	600	1
5	<input type="checkbox"/>	LLDP			Test	20	3	Reboot-Alarm	600	1
6	<input type="checkbox"/>	LLDP			Test	20	3	Reboot-Alarm	600	1
7	<input type="checkbox"/>	LLDP			Test	20	3	Reboot-Alarm	600	1

Apply Cancel

Figure 164 Auto PD Recovery (LLDP Mode)

Auto PD Recovery

Active

Port	Active	Mode	Neighbor Name	Neighbor IP	Test	Polling Interval (sec)	Polling Count	Action	Resume Polling Interval (sec)	PD Reboot Count
*	<input type="checkbox"/>	LLDP			Test			Reboot-Alarm		
1	<input type="checkbox"/>	LLDP		10.214.45.49	Test	20	3	Reboot-Alarm	600	1
2	<input checked="" type="checkbox"/>	LLDP	12A3_84		Test	20	3	Reboot-Alarm	600	1
3	<input type="checkbox"/>	LLDP		10.214.45.55	Test	20	3	Reboot-Alarm	600	1
4	<input checked="" type="checkbox"/>	LLDP	12A4		Test	20	3	Reboot-Alarm	600	1
5	<input type="checkbox"/>	LLDP			Test	20	3	Reboot-Alarm	600	1
6	<input type="checkbox"/>	LLDP			Test	20	3	Reboot-Alarm	600	1
7	<input type="checkbox"/>	LLDP			Test	20	3	Reboot-Alarm	600	1

Apply Cancel

- 2 Select the desired ports in the **Active** column.
- 3 Select the **Mode**.

When you select **Ping**, the connected PD's IPv4 or IPv6 address to which the Switch sends ping requests will display automatically if the PD supports LLDP. If not, enter the IP address of the PDs in the **Neighbor IP** field.

The default setting for **Polling Interval (sec)** (20 secs) and **Polling Count** (3 times) will cause the Switch to ping the PD status every 20 seconds. If there is no ping reply from the PD, **Polling Count** starts to count from 1. Once **Polling Count** reaches 3, the Switch will cause a **Reboot-Alarm** on the PD as selected in **Action**.

When you select **LLDP**, the Switch monitors the PD status by checking incoming LLDP packets every 30 seconds from the PD (default value of transmit interval for LLDP feature).

Likewise, the Switch sends out LLDP packets to the PD every 30 seconds to update the **MONITOR > Neighbor** screen.

Once the LLDP table's counter reaches the default 120 seconds, the Switch will cause a **Reboot-Alarm** on the PD as selected in **Action**.

- 4 After sending an SNMP trap and generating a log message, the connected PD will restart (the connecting port is detected as link-down).

When restarting, the PD entry disappears from the Switch's LLDP table and the **PD Health** status LED will turn to yellow in the **MONITOR > Neighbor** screen.

After the PD is powered on, the Switch resumes detection of the PD status by performing ping requests or checking the LLDP table based on your value for **Resume Polling Interval**.

When the **PD Reboot Count** value is reached, the Switch will no longer perform the PD recovery process. The **PD Health** status LED will turn to red in the **MONITOR > Neighbor** screen.

- 5 Click **Apply** to save your changes back to the run-time memory.
- 6 Click the **Save** link in the upper right corner of the Web Configurator to save your configuration permanently.

Note: In the event of a PD performing firmware upgrade, the PD may stop responding to ping or fail to provide LLDP packets for an extended period of time. When the Switch resets power to the PD before firmware upgrade is finished, it may permanently damage the PD or require a hard reset to recover it. **It is strongly advised to disable the Switch's Auto PD Recovery function before upgrading the PD's firmware. This will prevent damage caused by a power cutoff.**

CHAPTER 33

Flex Link

This chapter introduces how to set up a backup link for a primary link using Flex Links.

33.1 Flex Link Overview

A flex link pair consists of a primary link and a backup link on a layer-2 interface. A primary link runs on a **Primary Port**; a backup link runs on a **Backup Port**. The ports have two states: FORWARDING and BLOCKING. When one link is up and running (port state: FORWARDING), the other link is in down or in standby mode (port state: BLOCKING). Only one port is forwarding traffic (FORWARDING) at a time.

When the primary link goes down, the backup link automatically goes up and is able to forward traffic.

Preemption

Enable **Preemption** to have the Switch automatically return the primary port to FORWARDING state after the connection from the primary port resumes, and the backup port return to BLOCKING. The Switch will wait for the specified **Preemption Delay Time** before changing the primary port state to FORWARDING and backup port state to BLOCKING. See [Table 106 on page 229](#) for more information.

33.1.1 What You Can Do

- Use the **Flex Link Status** screen ([Section 33.2 on page 226](#)) to view the flex link status on the Switch.
- Use the **Flex Link Setup** screen ([Section 33.3 on page 227](#)) to configure flex links for back up links on the Switch.

33.2 Flex Link Status

Click **PORT > Flex Link > Flex Link Status** to display this screen.

Figure 165 PORT > Flex Link > Flex Link Status

Flex Link Status		Flex Link Setup	
Index	Primary Port	Backup Port	State
1	1	2	Primary Down / Backup Down
2	24	26	Primary Down / Backup Up

The following table describes the labels in this screen.

Table 104 PORT > Flex Link > Flex Link Status

LABEL	DESCRIPTION
Index	This displays the index number of a flex link pair.
Primary Port	This displays the port number of the primary link. In Stacking mode, the first number represents the slot ID and the second is the port number.
Backup Port	This displays the port number of the backup link. In Stacking mode, the first number represents the slot ID and the second is the port number.
State	This displays the link status of the Primary port and Backup port. Down – The link is down. Up – The link is up and the port state is FORWARDING. Standby – The link is up and the port state is BLOCKING. Note: Only one port can be up in a flex link pair.

33.3 Flex Link Setup

Click **PORT > Flex Link > Flex Link Setup** to display this screen.

Note: The Flex Link (**PORT > Flex Link**), STP (**SWITCHING > Spanning Tree Protocol**), Loop Guard (**SWITCHING > Loop Guard**) and Link Aggregation (**PORT > Link Aggregation**) features cannot be configured together on the same port. When one of the above functions is enabled, the Switch will not let you enable the others.

Note: You can configure up to five pairs of flex links.

Figure 166 PORT > Flex Link > Flex Link Setup

<input type="checkbox"/>	Index	Primary Port	Backup Port	Preemption	Preemption Delay Time
<input type="checkbox"/>	1	1	2	Yes	30
<input type="checkbox"/>	2	24	26	No	30

The following table describes the labels in this screen.

Table 105 PORT > Flex Link > Flex Link Setup

LABEL	DESCRIPTION
Index	This displays the index number of an entry.
Primary Port	This displays the port number of the primary link. In Stacking mode, the first number represents the slot ID and the second is the port number.
Backup Port	This displays the port number of the backup link. In Stacking mode, the first number represents the slot ID and the second is the port number.

Table 105 PORT > Flex Link > Flex Link Setup (continued)

LABEL	DESCRIPTION
Preemption	This displays if Preemption is enabled on the flex link pair. If Preemption is enabled, when the primary port comes back up, the backup port will go into BLOCKING state and the primary port will go into FORWARDING state after the Preemption Delay Time interval.
Preemption Delay Time	This displays the preemption delay time configured for this flex link pair.
	Select an entry's check box to select a specific entry. Otherwise, select the check box in the table heading row to select all entries.
Add/Edit	Click Add/Edit to add a new entry or edit a selected one.
Delete	Click Delete to remove the selected entry.

33.3.1 Add/Edit Flex Link

To access this screen, click the **Add/Edit** button or select an entry from the list and click the **Add/Edit** button.

Note: A port can only be in one flex link pair. If a port has already been set as a flex link pair's primary/backup port, the port can not be used by other flex links. Check the **PORT > Flex Link > Flex Link Setup** screen to see what ports are already in other flex link pairs.

Figure 167 PORT > Flex Link > Flex Link Setup > Add/Edit (Standalone Mode)

Primary Port

Backup Port

Preemption

Preemption Delay Time

Apply Clear Cancel

Figure 168 PORT > Flex Link > Flex Link Setup > Add/Edit (Stacking Mode)

Primary Port /

Backup Port /

Preemption

Preemption Delay Time

Apply Clear Cancel

The following table describes the labels in this screen.

Table 106 PORT > Flex Link > Flex Link Setup > Add/Edit

LABEL	DESCRIPTION
Primary Port	<p>Enter a port number to be the primary port.</p> <p>In Stacking mode, the first field is the slot ID and the second field is the port number.</p> <p>Please note that the default stacking ports (the last four ports of your Switch) cannot be configured. They are reserved for stacking only.</p>
Backup Port	<p>Enter a port number to be the backup port.</p> <p>In Stacking mode, the first field is the slot ID and the second field is the port number.</p> <p>Please note that the default stacking ports (the last four ports of your Switch) cannot be configured. They are reserved for stacking only.</p>
Preemption	<p>Select this to enable the Preemption mode on the flex link pair.</p> <p>If Preemption is disabled, if the primary port is down, then comes back up, it will remain in the BLOCKING state even after the Preemption Delay Time.</p>
Preemption Delay Time	<p>Enter the delay time (in seconds) which you want the primary port to wait before changing back to FORWARDING state (when available). The range is 1 – 300 seconds.</p>
Apply	<p>Click Apply to save your changes to the Switch's run-time memory. The Switch loses these changes if it is turned off or loses power, so use the Save link on the top navigation panel to save your changes to the non-volatile memory when you are done configuring.</p>
Clear	<p>Click Clear to clear the fields to the factory defaults.</p>
Cancel	<p>Click Cancel to not save the configuration you make and return to the last screen.</p>

CHAPTER 34

Green Ethernet

This chapter shows you how to configure the Switch to reduce the power consumed by switch ports.

34.1 Green Ethernet Overview

Green Ethernet reduces switch port power consumption in the following ways.

IEEE 802.3az Energy Efficient Ethernet (EEE)

If EEE is enabled, both sides of a link support EEE and there is no traffic, the port enters Low Power Idle (LPI) mode. LPI mode turns off some functions of the physical layer (becomes quiet) to save power. Periodically the port transmits a REFRESH signal to allow the link partner to keep the link alive. When there is traffic to be sent, a WAKE signal is sent to the link partner to return the link to active mode.

Auto Power Down

Auto Power Down turns off almost all functions of the port's physical layer functions when the link is down, so the port only uses power to check for a link up pulse from the link partner. After the link up pulse is detected, the port wakes up from **Auto Power Down** and operates normally.

Short Reach

Traditional Ethernet transmits all data with enough power to reach the maximum cable length. Shorter cables lose less power, so **Short Reach** saves power by adjusting the transmit power of each port according to the length of cable attached to that port.

34.2 Configuring Green Ethernet

Click **PORT > Green Ethernet** in the navigation panel to display the screen as shown.

Note: This feature is only available on copper ports. Check boxes of SFP ports are grayed out and cannot be selected.

Note: EEE, Auto Power Down and Short Reach are NOT supported on an uplink port.

Figure 169 PORT > Green Ethernet (Standalone Mode)

Green Ethernet

EEE OFF

Auto Power Down OFF

Short Reach OFF

Port	EEE	Auto Power Down	Short Reach
*	<input type="checkbox"/>	<input type="checkbox"/>	<input type="checkbox"/>
1	<input type="checkbox"/>	<input type="checkbox"/>	<input type="checkbox"/>
2	<input type="checkbox"/>	<input type="checkbox"/>	<input type="checkbox"/>
3	<input type="checkbox"/>	<input type="checkbox"/>	<input type="checkbox"/>
4	<input type="checkbox"/>	<input type="checkbox"/>	<input type="checkbox"/>
5	<input type="checkbox"/>	<input type="checkbox"/>	<input type="checkbox"/>
6	<input type="checkbox"/>	<input type="checkbox"/>	<input type="checkbox"/>
7	<input type="checkbox"/>	<input type="checkbox"/>	<input type="checkbox"/>
18	<input type="checkbox"/>	<input type="checkbox"/>	<input type="checkbox"/>
19	<input type="checkbox"/>	<input type="checkbox"/>	<input type="checkbox"/>

Figure 170 PORT > Green Ethernet (Stacking Mode)

Green Ethernet

EEE OFF

Auto Power Down OFF

Short Reach OFF

SLOT 1 ▾

Port	EEE	Auto Power Down	Short Reach
1/*	<input type="checkbox"/>	<input type="checkbox"/>	<input type="checkbox"/>
1/1	<input type="checkbox"/>	<input type="checkbox"/>	<input type="checkbox"/>
1/2	<input type="checkbox"/>	<input type="checkbox"/>	<input type="checkbox"/>
1/3	<input type="checkbox"/>	<input type="checkbox"/>	<input type="checkbox"/>
1/4	<input type="checkbox"/>	<input type="checkbox"/>	<input type="checkbox"/>
1/5	<input type="checkbox"/>	<input type="checkbox"/>	<input type="checkbox"/>
1/6	<input type="checkbox"/>	<input type="checkbox"/>	<input type="checkbox"/>
1/21	<input type="checkbox"/>	<input type="checkbox"/>	<input type="checkbox"/>
1/22	<input type="checkbox"/>	<input type="checkbox"/>	<input type="checkbox"/>
1/23	<input type="checkbox"/>	<input type="checkbox"/>	<input type="checkbox"/>
1/24	<input type="checkbox"/>	<input type="checkbox"/>	<input type="checkbox"/>

Apply Cancel

The following table describes the labels in this screen.

Table 107 PORT > Green Ethernet

LABEL	DESCRIPTION
EEE	Enable the switch button to activate Energy Efficient Ethernet globally.
Auto Power Down	Enable the switch button to activate Auto Power Down globally.
Short Reach	Enable the switch button to activate Short Reach globally.
SLOT	This field appears only in Stacking mode. Click the drop-down list to choose the slot number of the Switch in a stack.
Port	This field displays the port number. In Stacking mode, the first number represents the slot ID and the second is the port number. Please note that the default stacking ports (the last four ports of your Switch) cannot be configured. They are reserved for stacking only.
*	Use this row to make the setting the same for all ports. Use this row first and then make adjustments to each port if necessary. Changes in this row are copied to all the ports as soon as you make them.
EEE	Select this to activate Energy Efficient Ethernet on this port.
Auto Power Down	Select this to activate Auto Power Down on this port.
Short Reach	Select this to activate Short Reach on this port.

Table 107 PORT > Green Ethernet (continued)

LABEL	DESCRIPTION
Apply	Click Apply to save your changes to the Switch's run-time memory. The Switch loses these changes if it is turned off or loses power, so use the Save link on the top navigation panel to save your changes to the non-volatile memory when you are done configuring.
Cancel	Click Cancel to begin configuring this screen afresh.

CHAPTER 35

Link Aggregation

35.1 Link Aggregation Overview

This chapter shows you how to logically aggregate physical links to form one logical, higher-bandwidth link.

Link aggregation (trunking) is the grouping of physical ports into one logical higher-capacity link. You may want to trunk ports if for example, it is cheaper to use multiple lower-speed links than to under-utilize a high-speed, but more costly, single-port link. However, the more ports you aggregate then the fewer available ports you have. A trunk group is one logical link containing multiple ports.

The beginning port of each trunk group must be physically connected to form a trunk group.

35.1.1 What You Can Do

- Use the **Link Aggregation Status** screen ([Section 35.2 on page 236](#)) to view ports you have configured to be in the trunk group, ports that are currently transmitting data as one logical link in the trunk group and so on.
- Use the **Link Aggregation Setting** screen ([Section 35.3 on page 237](#)) to configure static link aggregation.
- Use the **Link Aggregation Control Protocol** screen ([Section 35.4 on page 240](#)) to enable Link Aggregation Control Protocol (LACP).

35.1.2 What You Need to Know

The Switch supports both static and dynamic link aggregation.

Note: In a properly planned network, it is recommended to implement static link aggregation only. This ensures increased network stability and control over the trunk groups on your Switch.

See [Section 35.5.1 on page 243](#) for a static port trunking example.

Dynamic Link Aggregation

The Switch adheres to the IEEE 802.3ad standard for static and dynamic (LACP) port trunking.

The IEEE 802.3ad standard describes the Link Aggregation Control Protocol (LACP) for dynamically creating and managing trunk groups.

When you enable LACP link aggregation on a port, the port can automatically negotiate with the ports at the remote end of a link to establish trunk groups. LACP also allows port redundancy, that is, if an

operational port fails, then one of the “standby” ports become operational without user intervention. Please note that:

- You must connect all ports point-to-point to the same Ethernet switch and configure the ports for LACP trunking.
- LACP only works on full-duplex links.
- All ports in the same trunk group must have the same media type, speed, duplex mode and flow control settings.

Configure trunk groups or LACP before you connect the Ethernet switch to avoid causing network topology loops.

Link Aggregation ID

LACP aggregation ID consists of the following information¹:

Table 108 Link Aggregation ID: Local Switch

SYSTEM PRIORITY	MAC ADDRESS	KEY	PORT PRIORITY	PORT NUMBER
0000	00-00-00-00-00-00	0000	00	0000

Table 109 Link Aggregation ID: Peer Switch

SYSTEM PRIORITY	MAC ADDRESS	KEY	PORT PRIORITY	PORT NUMBER
0000	00-00-00-00-00-00	0000	00	0000

Traffic Distribution Criteria

The Switch supports both unicast and non-unicast traffic (broadcast and multicast) network load sharing over link aggregation. Load sharing works by statically splitting the traffic based on source or destination IP/MAC address, and then distributing the load across multiple paths. In link aggregation, this allows the trunk group (ports) to transmit data as one logical link to a single or group of hosts on the network.

Unicast and non-unicast traffic network load sharing over link aggregation (trunking) is enabled by default.

Algorithm Types Limitation

The maximum number of link aggregation algorithm types (**Criteria**) that can link up at the same time depends on your Switch model. See [Table 111 on page 236](#) for the list of **Criteria** that your Switch currently supports.

The following table shows the maximum number of link aggregation algorithm types that can link up at the same time.

Table 110 Link Aggregation Algorithm Types Limitation

MODEL	LINK AGGREGATION ALGORITHM TYPES (MAXIMUM)
XGS2220 Series	2

1. Port Priority and Port Number are 0 as it is the aggregator ID for the trunk group, not the individual port.

For example, if your Switch has two link aggregation algorithm types that are currently online. The third link aggregation algorithm type can only go online when one of the online link aggregation algorithm type goes offline.

In stacking mode, the stacking channel is using link-aggregation. The default algorithm type is src-dst-mac, and is not configurable. Therefore, you have only one other algorithm type that can link up at the same time.

By default, the stacking ports are trunk ports. For example, for a 54-port Switch, the stacking ports 51 and 52, 53 and 54 are two trunk groups.

35.2 Link Aggregation Status

Click **PORT > Link Aggregation > Link Aggregation Status** in the navigation panel to display the screen as shown. See [Section 35.1 on page 234](#) for more information.

Figure 171 PORT > Link Aggregation > Link Aggregation Status

Link Aggregation Status					
Group ID	Enabled Ports	Synchronized Ports	Aggregator ID	Criteria	Status
T1	-	-	-	src-dst-mac	-
T2	-	-	-	src-dst-mac	-
T3	-	-	-	src-dst-mac	-
T4	-	-	-	src-dst-mac	-
T5	-	-	-	src-dst-mac	-
T6	-	-	-	src-dst-mac	-
T7	-	-	-	src-dst-mac	-

The following table describes the labels in this screen.

Table 111 PORT > Link Aggregation > Link Aggregation Status

LABEL	DESCRIPTION
Group ID	This field displays the group ID to identify a trunk group, that is, one logical link containing multiple ports.
Enabled Ports	These are the ports you have configured in the Link Aggregation Setting screen to be in the trunk group. The port numbers displays only when this trunk group is activated and there is a port belonging to this group.
Synchronized Ports	These are the ports that are currently transmitting data as one logical link in this trunk group.
Aggregator ID	Link Aggregator ID consists of the following: system priority, MAC address, key, port priority and port number. The ID displays only when there is a port belonging to this trunk group and LACP is also enabled for this group.

Table 111 PORT > Link Aggregation > Link Aggregation Status (continued)

LABEL	DESCRIPTION
Criteria	<p>This shows the outgoing traffic distribution algorithm types used in this trunk group. Sending of packets are from the same source and/or to the same destination over the same link within the trunk.</p> <p>src-mac means the Switch distributes traffic based on the packet's source MAC address.</p> <p>dst-mac means the Switch distributes traffic based on the packet's destination MAC address.</p> <p>src-dst-mac means the Switch distributes traffic based on a combination of the packet's source and destination MAC addresses.</p> <p>src-ip means the Switch distributes traffic based on the packet's source IP address.</p> <p>dst-ip means the Switch distributes traffic based on the packet's destination IP address.</p> <p>src-dst-ip means the Switch distributes traffic based on a combination of the packet's source and destination IP addresses.</p> <p>Note: To find the number of link aggregation algorithm types that can link up at the same time, see Algorithm Types Limitation on page 235.</p>
Status	<p>This field displays how these ports were added to the trunk group. It displays:</p> <ul style="list-style-type: none"> • Static – if the ports are configured as static members of a trunk group. • LACP – if the ports are configured to join a trunk group through LACP.

35.3 Link Aggregation Setting

Click **PORT > Link Aggregation > Link Aggregation Setting** to display the screen shown next. See [Section 35.1 on page 234](#) for more information on link aggregation.

Figure 172 PORT > Link Aggregation > Link Aggregation Setting (Standalone Mode)

Link Aggregation Status **Link Aggregation Setting** Link Aggregation

Group ID	Active	Criteria
T1	<input checked="" type="checkbox"/>	src-dst-mac ▼
T2	<input type="checkbox"/>	src-dst-mac ▼
T3	<input type="checkbox"/>	src-dst-mac ▼
T4	<input type="checkbox"/>	src-dst-mac ▼
T5	<input type="checkbox"/>	src-dst-mac ▼
T6	<input type="checkbox"/>	src-dst-mac ▼
T7	<input type="checkbox"/>	src-dst-mac ▼

Port	Group
1	T1 ▼
2	None ▼
3	None ▼
4	None ▼
5	None ▼
6	None ▼
7	None ▼

Figure 173 PORT > Link Aggregation > Link Aggregation Setting (Stacking Mode)

Group ID	Active	Criteria
T1	<input type="checkbox"/>	src-dst-mac ▼
T2	<input type="checkbox"/>	src-dst-mac ▼
T3	<input type="checkbox"/>	src-dst-mac ▼
T4	<input type="checkbox"/>	src-dst-mac ▼
T5	<input type="checkbox"/>	src-dst-mac ▼
T6	<input type="checkbox"/>	src-dst-mac ▼
T7	<input type="checkbox"/>	src-dst-mac ▼

SLOT 1 ▼

Port	Group
1/1	None ▼
1/2	None ▼
1/3	None ▼
1/4	None ▼
1/5	None ▼
1/6	None ▼
1/7	None ▼

Apply Cancel

The following table describes the labels in this screen.

Table 112 PORT > Link Aggregation > Link Aggregation Setting

LABEL	DESCRIPTION
	This is the only screen you need to configure to enable static link aggregation.
Group ID	The field identifies the link aggregation group, that is, one logical link containing multiple ports.
Active	Select this to activate a trunk group.

Table 112 PORT > Link Aggregation > Link Aggregation Setting (continued)

LABEL	DESCRIPTION
Criteria	<p>Select the outgoing traffic distribution type. Packets from the same source and/or to the same destination are sent over the same link within the trunk. By default, the Switch uses the src-dst-mac distribution type. If the Switch is behind a router, the packet's destination or source MAC address will be changed. In this case, set the Switch to distribute traffic based on its IP address to make sure port trunking can work properly.</p> <p>Select src-mac to distribute traffic based on the packet's source MAC address.</p> <p>Select dst-mac to distribute traffic based on the packet's destination MAC address.</p> <p>Select src-dst-mac to distribute traffic based on a combination of the packet's source and destination MAC addresses.</p> <p>Select src-ip to distribute traffic based on the packet's source IP address.</p> <p>Select dst-ip to distribute traffic based on the packet's destination IP address.</p> <p>Select src-dst-ip to distribute traffic based on a combination of the packet's source and destination IP addresses.</p>
SLOT	This field appears only in Stacking mode. Click the drop-down list to choose the slot number of the Switch in a stack.
Port	This field displays the port number. In Stacking mode, the first number represents the slot ID and the second is the port number. Please note that the default stacking ports (the last four ports of your Switch) cannot be configured. They are reserved for stacking only.
Group	<p>Select the trunk group to which a port belongs.</p> <p>Note: When you enable the port security feature on the Switch and configure port security settings for a port, you cannot include the port in an active trunk group.</p>
Apply	Click Apply to save your changes to the Switch's run-time memory. The Switch loses these changes if it is turned off or loses power, so use the Save link on the top navigation panel to save your changes to the non-volatile memory when you are done configuring.
Cancel	Click Cancel to begin configuring this screen afresh.

35.4 Link Aggregation Control Protocol

Click **PORT > Link Aggregation > Link Aggregation Control Protocol** to display the screen shown next. See [Dynamic Link Aggregation on page 234](#) for more information on dynamic link aggregation.

Note: Do NOT configure this screen unless you want to enable dynamic link aggregation.

Figure 174 PORT > Link Aggregation > Link Aggregation Control Protocol (Standalone Mode)

Status **Link Aggregation Setting** **Link Aggregation Control Protocol**

Active ON

System Priority

Group ID	LACP Active
T1	<input type="checkbox"/>
T2	<input type="checkbox"/>
T3	<input type="checkbox"/>
T4	<input type="checkbox"/>
T5	<input type="checkbox"/>
T6	<input type="checkbox"/>
T7	<input type="checkbox"/>

Port	LACP Timeout
*	<input type="text" value="30"/> seconds
1	<input type="text" value="30"/> seconds
2	<input type="text" value="30"/> seconds
3	<input type="text" value="30"/> seconds
4	<input type="text" value="30"/> seconds
5	<input type="text" value="30"/> seconds
6	<input type="text" value="30"/> seconds
7	<input type="text" value="30"/> seconds

Figure 175 PORT > Link Aggregation > Link Aggregation Control Protocol (Stacking Mode)

The following table describes the labels in this screen.

Table 113 PORT > Link Aggregation > Link Aggregation Control Protocol

LABEL	DESCRIPTION
Active	Enable the switch button to enable Link Aggregation Control Protocol (LACP).
System Priority	LACP system priority is a number between 1 and 65535. The switch with the lowest system priority (and lowest port number if system priority is the same) becomes the LACP "server". The LACP "server" controls the operation of LACP setup. Enter a number to set the priority of an active port using Link Aggregation Control Protocol (LACP). The smaller the number, the higher the priority level.
Use this section to enable LACP on trunks.	
Group ID	The field identifies the link aggregation group, that is, one logical link containing multiple ports.
LACP Active	Select this option to enable LACP for a trunk.
Use this section to configure LACP timeout on ports.	

Table 113 PORT > Link Aggregation > Link Aggregation Control Protocol (continued)

LABEL	DESCRIPTION
SLOT	This field appears only in Stacking mode. Click the drop-down list to choose the slot number of the Switch in a stack.
Port	This field displays the port number. In Stacking mode, the first number represents the slot ID and the second is the port number. Please note that the default stacking ports (the last four ports of your Switch) cannot be configured. They are reserved for stacking only.
*	Settings in this row apply to all ports. Use this row only if you want to make some settings the same for all ports. Use this row first to set the common settings and then make adjustments on a port-by-port basis. Note: Changes in this row are copied to all the ports as soon as you make them.
LACP Timeout	Timeout is the time interval between the individual port exchanges of LACP packets in order to check that the peer port in the trunk group is still up. If a port does not respond after three tries, then it is deemed to be "down" and is removed from the trunk. Set a short timeout (1 second) for busy trunked links to ensure that disabled ports are removed from the trunk group as soon as possible. Select either 1 second or 30 seconds.
Apply	Click Apply to save your changes to the Switch's run-time memory. The Switch loses these changes if it is turned off or loses power, so use the Save link on the top navigation panel to save your changes to the non-volatile memory when you are done configuring.
Cancel	Click Cancel to begin configuring this screen afresh.

35.5 Technical Reference

This section provides technical background information on the topics discussed in this chapter.

35.5.1 Static Trunking Example

This example shows you how to create a static port trunk group for ports 2 – 5.

- 1 Make your physical connections** – make sure that the ports that you want to belong to the trunk group are connected to the same destination. The following figure shows ports 2 – 5 on switch **A** connected to switch **B**.

Figure 176 Trunking Example – Physical Connections



- 2 Configure static trunking** – Click **PORT > Link Aggregation > Link Aggregation Setting**. In this screen activate trunk group **T1**, select the traffic distribution algorithm used by this group and select the ports that should belong to this group as shown in the figure below. Click **Apply** when you are done.

Figure 177 Trunking Example – Configuration Screen

The screenshot displays the 'Link Aggregation Setting' configuration screen. It features two main tables and two buttons at the bottom.

Link Aggregation Status Table:

Group ID	Active	Criteria
T1	<input checked="" type="checkbox"/>	src-dst-mac ▾
T2	<input type="checkbox"/>	src-dst-mac ▾
T3	<input type="checkbox"/>	src-dst-mac ▾
T4	<input type="checkbox"/>	src-dst-mac ▾
T5	<input type="checkbox"/>	src-dst-mac ▾
T6	<input type="checkbox"/>	src-dst-mac ▾
T7	<input type="checkbox"/>	src-dst-mac ▾

Port Assignment Table:

Port	Group
1	None ▾
2	T1 ▾
3	T1 ▾
4	T1 ▾
5	T1 ▾
6	None ▾
7	None ▾

At the bottom of the screen, there are two buttons: 'Apply' and 'Cancel'.

Your trunk group 1 (T1) configuration is now complete.

CHAPTER 36

Link Layer Discovery Protocol (LLDP)

36.1 LLDP Overview

The LLDP (Link Layer Discovery Protocol) is a layer 2 protocol. It allows a network device to advertise its identity and capabilities on the local network. It also allows the device to maintain and store information from adjacent devices which are directly connected to the network device. This helps an administrator discover network changes and perform necessary network reconfiguration and management. The device information is encapsulated in the LLDPDUs (LLDP data units) in the form of TLV (Type, Length, Value). Device information carried in the received LLDPDUs is stored in the standard MIB.

The Switch supports these basic management TLVs.

- End of LLDPDU (mandatory)
- Chassis ID (mandatory)
- Port ID (mandatory)
- Time to Live (mandatory)
- Port Description (optional)
- System Name (optional)
- System Description (optional)
- System Capabilities (optional)
- Management Address (optional)

The Switch also supports the IEEE 802.1 and IEEE 802.3 organizationally-specific TLVs.

IEEE 802.1 specific TLVs:

- Port VLAN ID TLV (optional)
- Port and Protocol VLAN ID TLV (optional)

IEEE 802.3 specific TLVs:

- MAC/PHY Configuration/Status TLV (optional)
- Power via MDI TLV (optional, For PoE models only)
- Link Aggregation TLV (optional)
- Maximum Frame Size TLV (optional)

The optional TLVs are inserted between the Time To Live TLV and the End of LLDPDU TLV.

The next figure demonstrates that the network devices Switches and Routers (S and R) transmit and receive device information through LLDPDU and the network manager can query the information using Simple Network Management Protocol (SNMP).

Figure 178 LLDP Overview

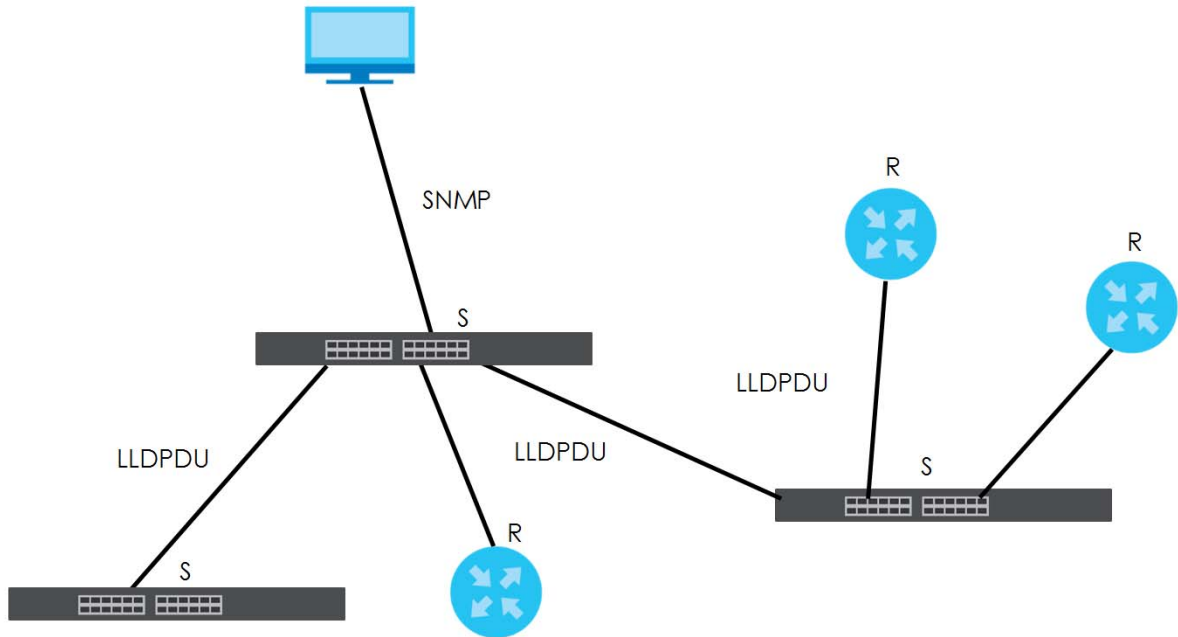

36.2 LLDP-MED Overview

LLDP-MED (Link Layer Discovery Protocol for Media Endpoint Devices) is an extension to the standard LLDP developed by the Telecommunications Industry Association (TIA) TR-41.4 subcommittee which defines the enhanced discovery capabilities, such as VoIP applications, to enable network administrators manage their network topology application more efficiently. Unlike the traditional LLDP, which has some limitations when handling multiple application devices, the LLDP-MED offers display of accurate physical topology, interoperability of devices, and easy trouble shooting for mis-configured IP addresses. There are three classes of endpoint devices that the LLDP-MED supports:

Class I: IP Communications Controllers or other communication related servers

Class II: Voice Gateways, Conference Bridges or Media Servers

Class III: IP-Phones, PC-based Softphones, End user Communication Appliances supporting IP Media

The following figure shows that with the LLDP-MED, network connectivity devices (NCD) like Switches and Routers will transmit LLDP TLV to endpoint device (ED) like IP Phone first (1), to get its device type and capabilities information, then it will receive that information in LLDP-MED TLV back from endpoint devices (2), after that the network connectivity devices will transmit LLDP-MED TLV (3) to provision the endpoint device to such that the endpoint device's network policy and location identification information is updated. Since LLDPDU updates status and configuration information periodically, network managers may check the result of provision through remote status. The remote status is updated by receiving LLDP-MED TLVs from endpoint devices.

Figure 179 LLDP-MED Overview

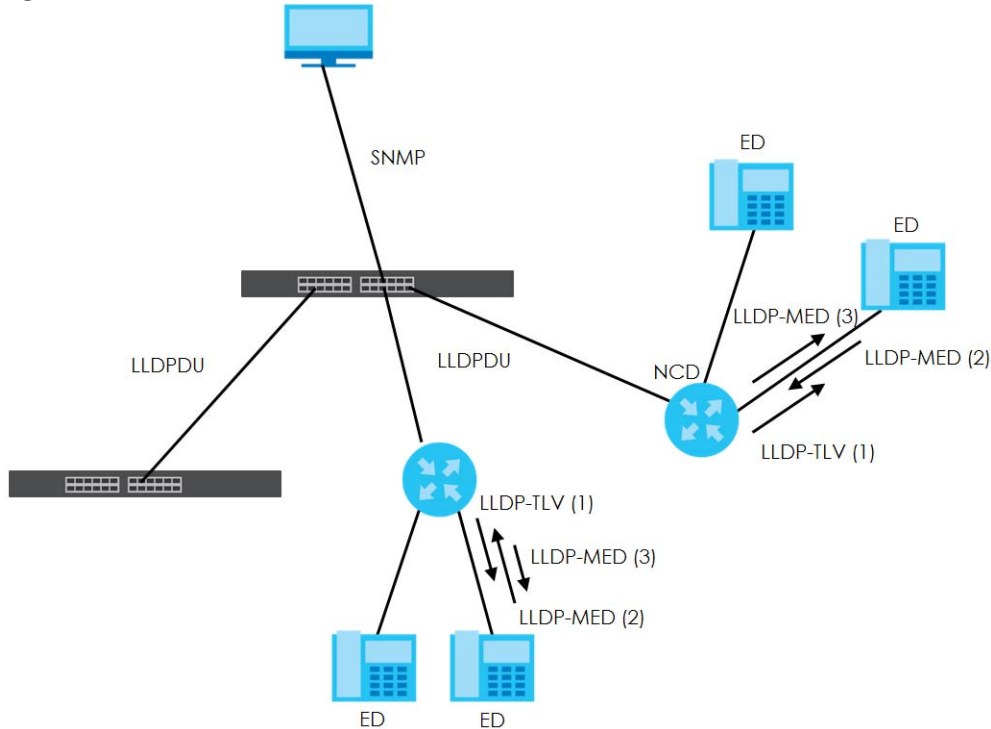

36.2.1 What You Can Do – LLDP

- Use the **LLDP Local Status** screen ([Section 36.3 on page 247](#)) to view the Switch's LLDP information.
- Use the **LLDP Remote Status** screen ([Section 36.4 on page 252](#)) to view LLDP information from the neighboring devices.
- Use the **LLDP Setup** screen ([Section 36.5 on page 258](#)) to configure LLDP on the Switch.
- Use the **Basic TLV Setting** screen ([Section 36.6 on page 261](#)) to configure basic TLV settings on each port.
- Use the **Org-specific TLV Setting** screen ([Section 36.7 on page 263](#)) to configure organization-specific TLV settings on each port.

36.2.2 What You Can Do – LLDP MED

- Use the **LLDP-MED Setup** screen ([Section 36.8 on page 264](#)) to configure LLDP-MED (Link Layer Discovery Protocol for Media Endpoint Devices) parameters.
- Use the **LLDP-MED Network Policy** screen ([Section 36.9 on page 266](#)) to configure LLDP-MED (Link Layer Discovery Protocol for Media Endpoint Devices) network policy parameters.
- Use the **LLDP-MED Location** screen ([Section 36.10 on page 268](#)) to configure LLDP-MED (Link Layer Discovery Protocol for Media Endpoint Devices) location parameters.

36.3 LLDP Local Status

This screen displays a summary of LLDP status on this Switch. Click **PORT > LLDP > LLDP > LLDP Local Status** to display the screen as shown next.

Figure 180 PORT > LLDP > LLDP > LLDP Local Status (Standalone Mode)

LLDP Local Status | LLDP Remote Status | LLDP Setup | Basic TLV Setting | Org-specific TLV Setting

Basic TLV

Chassis ID TLV		System Name TLV	
Chassis ID Subtype	mac-address	System Name	XGS2220
Chassis ID	00:19:cb:00:00:01	System Description TLV	
System Capabilities TLV		System Description	
System Capabilities Supported	Bridge	V4.80(ACCE.0)b6 04/11/2022	
System Capabilities Enabled	Bridge	Management Address TLV	
		Management Address Subtype	ipv4 / all-802
		Interface Number Subtype	unknown
		Interface Number	0
		Object Identifier	0

LLDP Port Information

Local Port	Port ID Subtype	Port ID	Port Description
1	local-assigned	1	
2	local-assigned	2	
3	local-assigned	3	
4	local-assigned	4	
5	local-assigned	5	
6	local-assigned	6	
7	local-assigned	7	
8	local-assigned	8	

Figure 181 PORT > LLDP > LLDP > LLDP Local Status (Stacking Mode)

LLDP Local Status | LLDP Remote Status | LLDP Setup | Basic TLV Setting | Org-specific TLV Setting

Basic TLV

Chassis ID TLV		System Name TLV	
Chassis ID Subtype	mac-address	System Name	XGS2220
Chassis ID	d8:ec:e5:cd:ba:fd	System Description TLV	
System Capabilities TLV		System Description	
System Capabilities Supported	Bridge	V4.80(ABXQ.2)b6 05/18/2023	
System Capabilities Enabled	Bridge	Management Address TLV	
		Management Address Subtype	ipv4 / all-802
		Interface Number Subtype	unknown
		Interface Number	0
		Object Identifier	0

LLDP Port Information

SLOT 1 ▾

Local Port	Port ID Subtype	Port ID	Port Description
1/1	local-assigned	1/1	
1/2	local-assigned	1/2	
1/3	local-assigned	1/3	
1/4	local-assigned	1/4	
1/5	local-assigned	1/5	
1/6	local-assigned	1/6	
1/7	local-assigned	1/7	
1/8	local-assigned	1/8	
1/9	local-assigned	1/9	
1/10	local-assigned	1/10	
1/11	local-assigned	1/11	

The following table describes the labels in this screen.

Table 114 PORT > LLDP > LLDP > LLDP Local Status

LABEL	DESCRIPTION
Basic TLV	
Chassis ID TLV	This displays the chassis ID of the local Switch, that is the Switch you are configuring. The chassis ID is identified by the chassis ID subtype. <ul style="list-style-type: none"> • Chassis ID Subtype – This displays how the chassis of the Switch is identified. • Chassis ID – This displays the chassis ID of the local Switch.
System Name TLV	System Name – This shows the host name of the Switch.
System Description TLV	System Description – This shows the firmware version of the Switch.
System Capabilities TLV	This shows the System Capabilities enabled and supported on the local Switch. <ul style="list-style-type: none"> • System Capabilities Supported – Bridge • System Capabilities Enabled – Bridge
Management Address TLV	The Management Address TLV identifies an address associated with the local LLDP agent that may be used to reach higher layer entities to assist discovery by network management. The TLV may also include the system interface number and an object identifier (OID) that are associated with this management address. <p>This field displays the Management Address settings on the specified ports.</p> <ul style="list-style-type: none"> • Management Address Subtype – ipv4 or all-802 • Interface Number Subtype – unknown • Interface Number – 0 (not supported) • Object Identifier – 0 (not supported)
LLDP Port Information	
This displays the local port information.	
SLOT	This field appears only in Stacking mode. Click the drop-down list to choose the slot number of the Switch in a stack.
Local Port	This displays the number of the Switch port which receives the LLDPDU from the remote device. Click a port number to view the detailed LLDP status on this port at LLDP Local Port Status Detail screen. <p>In Stacking mode, the first number represents the slot ID and the second is the port number. Please note that the default stacking ports (the last four ports of your Switch) cannot be configured. They are reserved for stacking only.</p>
Port ID Subtype	This indicates how the port ID field is identified.
Port ID	This is an alpha-numeric string that contains the specific identifier for the port from which this LLDPDU was transmitted.
Port Description	This shows the port description that the Switch will advertise from this port.

36.3.1 LLDP Local Port Status Details

This screen displays detailed LLDP status for each port on this Switch. Click **PORT > LLDP > LLDP > LLDP Local Status** and then, click a port number, for example 1 in the local port column to display the screen as shown next.

Figure 182 PORT > LLDP > LLDP > LLDP Local Status > LLDP Local Port Status Detail

LLDP Local Status		LLDP Remote Status		LLDP Setup		Basic TLV Setting	
LLDP Local Status > LLDP Local Port Status Detail							
Local Port: 1							
Basic TLV							
Port ID TLV				Port Description TLV			
Port ID Subtype	local-assigned			Port Description			
Port ID	1						
Dot1 TLV							
Port VLAN ID TLV				Port-Protocol VLAN ID TLV			
Port VLAN ID	1			Port-Protocol VLAN ID			
Dot3 TLV							
MAC PHY Configuration & Status TLV				Link Aggregation TLV			
AN Supported	Yes			Aggregation Capability	Yes		
AN Enabled	No			Aggregation Status	No		
AN Advertised Capability				Aggregated Port ID	0		
Oper MAU Type	36			Max Frame Size TLV			
				Max Frame Size	1518		
MED TLV							
Capabilities TLV				Network Policy TLV			
Network Policy	Yes			Voice			
Location	Yes			Voice-Signaling			
Extend Power via MDI PSE	No			Guest-Voice			
Extend Power via MDI PD	No			Guest-Voice-Signaling			
Inventory Management	No			Softphone-Voice			
				Video-Conferencing			
				Streaming-Video			
				Video-Signaling			
Device Type TLV				Location Identification TLV			
Device Type	Network Connectivity			Coordinate-base LCI			
				Civic LCI			
				ELIN			

The following table describes the labels in this screen.

Table 115 PORT > LLDP > LLDP Local Status > LLDP Local Port Status Details

LABEL	DESCRIPTION
Local Port	This displays the number of the Switch's port. In Stacking mode, the first number represents the slot ID and the second is the port number.
Basic TLV	
These are the Basic TLV flags	
Port ID TLV	The port ID TLV identifies the specific port that transmitted the LLDP frame. <ul style="list-style-type: none"> • Port ID Subtype – This shows how the port is identified. • Port ID – This is the ID of the port. In stacking mode, the first number represents the slot and the second the port number.
Port Description TLV	Port Description – This displays the local port description.
Dot1 TLV	
Port VLAN ID TLV	Port VLAN ID – This displays the VLAN ID sent by the IEEE 802.1 Port VLAN ID TLV.
Port-Protocol VLAN ID TLV	Port-Protocol VLAN ID – This displays the IEEE 802.1 Port Protocol VLAN ID TLVs, which indicates whether the VLAN is enabled and supported.
Dot3 TLV	
MAC PHY Configuration & Status TLV	The MAC/PHY Configuration/Status TLV advertises the bit-rate and duplex capability of the sending 802.3 node. It also advertises the current duplex and bit-rating of the sending node. Lastly, it advertises whether these setting were the result of auto-negotiation during link initiation or manual override. <ul style="list-style-type: none"> • AN Supported – Displays if the port supports or does not support auto-negotiation. • AN Enabled – The current auto-negotiation status of the port. • AN Advertised Capability – The auto-negotiation capabilities of the port. • Oper MAU Type – The current Medium Attachment Unit (MAU) type of the port.
Link Aggregation TLV	The Link Aggregation TLV indicates whether the link is capable of being aggregated, whether the link is currently in an aggregation, and if in an aggregation, the port identification of the aggregation. <ul style="list-style-type: none"> • Aggregation Capability – The current aggregation capability of the port. • Aggregation Status – The current aggregation status of the port. • Aggregation Port ID – The aggregation ID of the current port.
Max Frame Size TLV	This displays the maximum supported frame size in octets.
MED TLV	
LLDP Media Endpoint Discovery (MED) is an extension of LLDP that provides additional capabilities to support media endpoint devices. MED enables advertisement and discovery of network policies, device location discovery to allow creation of location databases, and information for troubleshooting.	
Capabilities TLV	This field displays which LLDP-MED TLV are capable to transmit on the Switch. <ul style="list-style-type: none"> • Network Policy • Location • Extend Power via MDI PSE • Extend Power via MDI PD • Inventory Management

Table 115 PORT > LLDP > LLDP > LLDP Local Status > LLDP Local Port Status Details (continued)

LABEL	DESCRIPTION
Network Policy TLV	This displays a network policy for the specified application. <ul style="list-style-type: none"> • Voice • Voice-Signaling • Guest-Voice • Guest-Voice-Signaling • Softphone-Voice • Video-Conferencing • Streaming-Video • Video-Signaling
Device Type TLV	Device Type – This is the LLDP-MED device class. The Zyxel Switch device type is: <ul style="list-style-type: none"> • Network Connectivity
Location Identification TLV	This shows the location information of a caller by its ELIN (Emergency Location Identifier Number) or the IETF Geopriv Civic Address based Location Configuration Information (Civic Address LCI). <ul style="list-style-type: none"> • Coordinate-based LCI – Latitude, longitude and altitude coordinates of the location Configuration Information (LCI) • Civic LCI – IETF Geopriv Civic Address based Location Configuration Information • ELIN – (Emergency Location Identifier Number)

36.4 LLDP Remote Status

This screen displays a summary of LLDP status for each LLDP connection to a neighboring Switch. Click **PORT > LLDP > LLDP > LLDP Remote Status** to display the screen as shown next.

Figure 183 PORT > LLDP > LLDP > LLDP Remote Status (Standalone Mode)

LLDP Local Status		LLDP Remote Status		LLDP Setup	Basic TLV Setting	Org-specific TLV Setting
Index	Local Port	Chassis ID	Port ID	Port Description	System Name	Management Address
1	18	c0:3f:c0:3f:c0:3f	c0:3f:c0:3f:c0:3f			
2	26	e4:e4:e4:e4:e4:e4	37		12A3_84	e4:e4:e4:e4:e4:e4

Figure 184 PORT > LLDP > LLDP > LLDP Remote Status (Stacking Mode)

LLDP Local Status		LLDP Remote Status		LLDP Setup	Basic TLV Setting	Org-specific TLV Setting
Index	Local Port	Chassis ID	Port ID	Port Description	System Name	Management Address
SLOT 1 ▾						
1	1/20	c0:3f:c0:3f:c0:3f	c0:3f:c0:3f:c0:3f			
2	1/24	d8:ec:d8:ec:d8:ec	1	UPLINK	WAX630S	

The following table describes the labels in this screen.

Table 116 PORT > LLDP > LLDP > LLDP Remote Status

LABEL	DESCRIPTION
SLOT	This field appears only in Stacking mode. Click the drop-down list to choose the slot number of the Switch in a stack.
Index	The index number shows the number of remote devices that are connected to the Switch. Click on an index number to view the detailed LLDP status for this remote device in the LLDP Remote Port Status Details screen.
Local Port	This is the number of the Switch's port that received LLDPDU from the remote device. In stacking mode, the first number represents the slot and the second the port number.
Chassis ID	This displays the chassis ID of the remote device associated with the transmitting LLDP agent. The chassis ID is identified by the chassis ID subtype. For example, the MAC address of the remote device.
Port ID	This is an alpha-numeric string that contains the specific identifier for the port from which this LLDPDU was transmitted. The port ID is identified by the port ID subtype.
Port Description	This displays a description for the port from which this LLDPDU was transmitted.
System Name	This displays the system name of the remote device.
Management Address	This displays the management address of the remote device. It could be the MAC address or IP address.

36.4.1 LLDP Remote Port Status Details

This screen displays detailed LLDP status of the remote device connected to the Switch. Click **PORT > LLDP > LLDP > LLDP Remote Status** and then click an index number, for example 1, in the **Index** column in the **LLDP Remote Status** screen to display the screen as shown next.

Figure 185 PORT > LLDP > LLDP > LLDP Remote Status > LLDP Remote Port Status Details (Basic TLV)

LLDP Local Status	LLDP Remote Status	LLDP Setup	Basic TLV Setting	Org-specific TLV Setting
LLDP Remote Status > LLDP Remote Port Status Details				
Local Port: 2				
Basic TLV				
Chassis ID TLV		Port ID TLV		
Chassis ID Subtype	mac-address	Port ID Subtype	local-assigned	
Chassis ID		Port ID	11	
Time To Live TLV		Port Description TLV		
Time To Live	120	Port Description		
System Name TLV		System Description TLV		
System Name	22A4_121	System Description V4.30(AAGF.2)_20200930 09/30/2020		
System Capabilities TLV		Management Address TLV		
System Capabilities Supported	bridge	Management Address Subtype	ALL_802	
System Capabilities Enabled	bridge	Management Address		
		Interface Number Subtype	unknown	
		Interface Number	0	
		Object Identifier		

The following table describes the labels in Basic TLV part of the screen.

Table 117 PORT > LLDP > LLDP Remote Status > LLDP Remote Port Status Details (Basic TLV)

LABEL	DESCRIPTION
Local Port	This displays the number of the Switch's port to which the remote device is connected. In Stacking mode, the first number represents the slot and the second the port number.
Basic TLV	
Chassis ID TLV	<ul style="list-style-type: none"> • Chassis ID Subtype – This displays how the chassis of the remote device is identified. • Chassis ID – This displays the chassis ID of the remote device. The chassis ID is identified by the chassis ID subtype.
Port ID TLV	<ul style="list-style-type: none"> • Port ID Subtype – This displays how the port of the remote device is identified. • Port ID – This displays the port ID of the remote device. The port ID is identified by the port ID subtype.
Time To Live TLV	Time To Live – This displays the time-to-live (TTL) multiplier of LLDP frames. The device information on the neighboring devices ages out and is discarded when its corresponding TTL expires. The TTL value is to multiply the TTL multiplier by the LLDP frames transmitting interval.
Port Description TLV	Port Description – This displays the remote port description.
System Name TLV	System Name – This displays the system name of the remote device.
System Description TLV	System Description – This displays the system description of the remote device.
System Capabilities TLV	<p>This displays whether the system capabilities are enabled and supported on the remote device.</p> <ul style="list-style-type: none"> • System Capabilities Supported • System Capabilities Enabled
Management Address TLV	<p>This displays the management address (IPv4 and IPv6) of the remote device.</p> <ul style="list-style-type: none"> • Management Address Subtype • Management Address • Interface Number Subtype • Interface Number • Object Identifier

Figure 186 PORT > LLDP > LLDP > LLDP Remote Status > LLDP Remote Port Status Details (Dot1 and Dot3 TLV)

Dot1 TLV	
Port VLAN ID TLV	
Port VLAN ID	2040
Vlan Name TLV	
	VLAN ID
	VLAN Name
Protocol Identity TLV	
Protocol ID	
Port-Protocol VLAN ID TLV	
	Port-Protocol VLAN ID
	Port-Protocol VLAN ID Supported
	Port-Protocol VLAN ID Enabled
Dot3 TLV	
MAC PHY Configuration & Status TLV	
AN Supported	Yes
AN Enabled	Yes
AN Advertised Capability	10baseT 10baseTFD 100baseTX 100baseTXFD 1000baseTFD
Oper MAU type	30
Max Frame Size TLV	
	Max Frame Size
Link Aggregation TLV	
	Aggregation Capability
	Aggregation Status
	Aggregated Port ID
Power Via MDI TLV	
	Port Class
	MDI Supported
	MDI Enabled
	Pair Controllable
	PSE Power Pairs
	Power Class

The following table describes the labels in the Dot1 and Dot3 parts of the screen.

Table 118 PORT > LLDP > LLDP > LLDP Remote Status > LLDP Remote Port Status Details (Dot1 and Dot3 TLV)

LABEL	DESCRIPTION
Dot1 TLV	
Port VLAN ID TLV	Port VLAN ID – This displays the VLAN ID of this port on the remote device.
Vlan Name TLV	This shows the VLAN ID and name for remote device port. <ul style="list-style-type: none"> • VLAN ID • VLAN Name
Protocol Identity TLV	Protocol ID – The Protocol Identity TLV allows the Switch to advertise the particular protocols that are accessible through its port.
Port-Protocol VLAN ID TLV	This displays the IEEE 802.1 Port Protocol VLAN ID TLV, which indicates whether the VLAN ID and whether it is enabled and supported on the port of remote Switch which sent the LLDPDU. <ul style="list-style-type: none"> • Port-Protocol VLAN ID • Port-Protocol VLAN ID Supported • Port-Protocol VLAN ID Enabled
Dot3 TLV	

Table 118 PORT > LLDP > LLDP > LLDP Remote Status > LLDP Remote Port Status Details (Dot1 and Dot3 TLV) (continued)

LABEL	DESCRIPTION
MAC PHY Configuration & Status TLV	<p>The MAC/PHY Configuration/Status TLV advertises the bit-rate and duplex capability of the sending 802.3 node. It also advertises the current duplex and bit-rating of the sending node. Lastly, it advertises whether these setting were the result of auto-negotiation during link initiation or manual override.</p> <ul style="list-style-type: none"> • AN Supported – Displays if the port supports or does not support auto-negotiation. • AN Enabled – The current auto-negotiation status of the port. • AN Advertised Capability – The auto-negotiation capabilities of the port. • Oper MAU Type – The current Medium Attachment Unit (MAU) type of the port.
Max Frame Size TLV	<p>Max Frame Size – This displays the maximum supported frame size in octets.</p>
Link Aggregation TLV	<p>The Link Aggregation TLV indicates whether the link is capable of being aggregated, whether the link is currently in an aggregation, and if in an aggregation, the port identification of the aggregation.</p> <ul style="list-style-type: none"> • Aggregation Capability – The current aggregation capability of the port. • Aggregation Status – The current aggregation status of the port. • Aggregated Port ID – The aggregation ID of the current port.
Power Via MDI TLV	<p>The Power Via MDI TLV allows network management to advertise and discover the MDI power support capabilities of the sending port on the remote device.</p> <ul style="list-style-type: none"> • Port Class • MDI Supported • MDI Enabled • Pair Controllable • PSE Power Pairs • Power Class

Figure 187 PORT > LLDP > LLDP > LLDP Remote Status > LLDP Remote Port Status Details (MED TLV)

MED TLV	
<p>Capabilities TLV</p> <ul style="list-style-type: none"> Network Policy Location Extend Power via MDI PSE Extend Power via MDI PD Inventory Management 	<p>Device Type TLV</p> <ul style="list-style-type: none"> Device Type
<p>Extended Power via MDI TLV</p> <ul style="list-style-type: none"> Power Type Power Source Power Priority Power Value 	<p>Location Identification TLV</p> <ul style="list-style-type: none"> Coordinate-base LCI Civic LCI ELIN
<p>Inventory TLV</p> <ul style="list-style-type: none"> Hardware Revision Software Revision Firmware Revision Model Name Manufacturer Serial Number Asset ID 	<p>Network Policy TLV</p> <ul style="list-style-type: none"> Voice Voice-Signaling Guest-Voice Guest-Voice-Signaling Softphone-Voice Video-Conferencing Streaming-Video Video-Signaling

The following table describes the labels in the MED TLV part of the screen.

Table 119 PORT > LLDP > LLDP > LLDP Remote Status > LLDP Remote Port Status Details (MED TLV)

LABEL	DESCRIPTION
MED TLV	LLDP Media Endpoint Discovery (MED) is an extension of LLDP that provides additional capabilities to support media endpoint devices. MED enables advertisement and discovery of network policies, device location discovery to allow creation of location databases, and information for troubleshooting.
Capabilities TLV	This displays the MED capabilities the remote port supports. <ul style="list-style-type: none"> • Network Policy • Location • Extend Power via MDI PSE • Extend Power via MDI PD • Inventory Management
Device Type TLV	LLDP-MED endpoint device classes: <ul style="list-style-type: none"> • Endpoint Class I • Endpoint Class II • Endpoint Class III • Network Connectivity

Table 119 PORT > LLDP > LLDP Remote Status > LLDP Remote Port Status Details (MED TLV)

LABEL	DESCRIPTION
Location Identification TLV	<p>This shows the location information of a caller by its:</p> <ul style="list-style-type: none"> • Coordinate-base LCI – Latitude and longitude coordinates of the Location Configuration Information (LCI) • Civic LCI – IETF Geopriv Civic Address based Location Configuration Information • ELIN – (Emergency Location Identifier Number)
Extended Power via MDI TLV	<p>Extended Power Via MDI Discovery enables detailed power information to be advertised by Media Endpoints, such as IP phones and Network Connectivity Devices such as the Switch.</p> <ul style="list-style-type: none"> • Power Type – Whether it is currently operating from primary power or is on backup power (backup power may indicate to the Endpoint Device that it should move to a power conservation mode). • Power Source – Whether or not the Endpoint is currently operating from an external power source. • Power Priority – The Endpoint Device's power priority (which the Network Connectivity Device may use to prioritize which devices will remain in service during power shortages). • Power Value – Power requirement, in fractions of Watts, in current configuration.
Network Policy TLV	<p>This displays a network policy for the specified application.</p> <ul style="list-style-type: none"> • Voice • Voice-Signaling • Guest-Voice • Guest-Voice-Signaling • Softphone-Voice • Video-Conferencing • Streaming-Video • Video-Signaling
Inventory TLV	<p>The majority of IP Phones lack support of management protocols such as SNMP, so LLDP-MED inventory TLVs are used to provide their inventory information to the Network Connectivity Devices such as the Switch. The Inventory TLV may contain the following information.</p> <ul style="list-style-type: none"> • Hardware Revision • Software Revision • Firmware Revision • Model Name • Manufacturer • Serial Number • Asset ID

36.5 LLDP Setup

Use this screen to configure global LLDP settings on the Switch. Click **PORT > LLDP > LLDP > LLDP Setup** to display the screen as shown next.

Figure 188 PORT > LLDP > LLDP > LLDP Setup (Standalone Mode)

LLDP Local Status
LLDP Remote Status
LLDP Setup
Basic TLV Setting

Active ON

Transmit Interval seconds

Transmit Hold times

Transmit Delay seconds

Reinitialize Delay seconds

Port	Admin Status	Notification
*	Tx-Rx <input type="button" value="v"/>	<input type="checkbox"/>
1	Tx-Rx <input type="button" value="v"/>	<input type="checkbox"/>
2	Tx-Rx <input type="button" value="v"/>	<input type="checkbox"/>
3	Tx-Rx <input type="button" value="v"/>	<input type="checkbox"/>
4	Tx-Rx <input type="button" value="v"/>	<input type="checkbox"/>
5	Tx-Rx <input type="button" value="v"/>	<input type="checkbox"/>
6	Tx-Rx <input type="button" value="v"/>	<input type="checkbox"/>
7	Tx-Rx <input type="button" value="v"/>	<input type="checkbox"/>

Figure 189 PORT > LLDP > LLDP > LLDP Setup (Stacking Mode)

LLDP Local Status LLDP Remote Status **LLDP Setup** Basic TLV Setting

Active ON

Transmit Interval seconds

Transmit Hold times

Transmit Delay seconds

Reinitialize Delay seconds

SLOT 1 ▾

Port	Admin Status	Notification
1/*	<input type="text" value="Tx-Rx"/> ▾	<input type="checkbox"/>
1/1	<input type="text" value="Tx-Rx"/> ▾	<input type="checkbox"/>
1/2	<input type="text" value="Tx-Rx"/> ▾	<input type="checkbox"/>
1/3	<input type="text" value="Tx-Rx"/> ▾	<input type="checkbox"/>
1/4	<input type="text" value="Tx-Rx"/> ▾	<input type="checkbox"/>
1/5	<input type="text" value="Tx-Rx"/> ▾	<input type="checkbox"/>
1/6	<input type="text" value="Tx-Rx"/> ▾	<input type="checkbox"/>
1/7	<input type="text" value="Tx-Rx"/> ▾	<input type="checkbox"/>

The following table describes the labels in this screen.

Table 120 PORT > LLDP > LLDP > LLDP Setup

LABEL	DESCRIPTION
Active	Select to enable LLDP on the Switch. It is enabled by default.
Transmit Interval	Enter how many seconds the Switch waits before sending LLDP packets.
Transmit Hold	Enter the time-to-live (TTL) multiplier of LLDP frames. The device information on the neighboring devices ages out and is discarded when its corresponding TTL expires. The TTL value is to multiply the TTL multiplier by the LLDP packets transmitting interval.
Transmit Delay	Enter the delay (in seconds) between successive LLDPDU transmissions initiated by value or status changes in the Switch MIB.
Reinitialize Delay	Enter the number of seconds for LLDP to wait before initializing on a port.
Apply	Click Apply to save your changes to the Switch's run-time memory. The Switch loses these changes if it is turned off or loses power, so use the Save link on the top navigation panel to save your changes to the non-volatile memory when you are done configuring.
Cancel	Click Cancel to begin configuring this screen afresh.
SLOT	This field appears only in Stacking mode. Click the drop-down list to choose the slot number of the Switch in a stack.
Port	This field displays the port number. In Stacking mode, the first number represents the slot ID and the second is the port number. Please note that the default stacking ports (the last four ports of your Switch) cannot be configured. They are reserved for stacking only.

Table 120 PORT > LLDP > LLDP > LLDP Setup (continued)

LABEL	DESCRIPTION
*	Use this row to make the setting the same for all ports. Use this row first and then make adjustments to each port if necessary. Changes in this row are copied to all the ports as soon as you make them.
Admin Status	Select whether LLDP transmission and/or reception is allowed on this port. <ul style="list-style-type: none"> • Disable – not allowed • Tx-Only – transmit only • Rx-Only – receive only • Tx-Rx – transmit and receive
Notification	Select whether LLDP notification is enabled on this port.
Apply	Click Apply to save your changes to the Switch's run-time memory. The Switch loses these changes if it is turned off or loses power, so use the Save link on the top navigation panel to save your changes to the non-volatile memory when you are done configuring.
Cancel	Click Cancel to begin configuring this screen afresh.

36.6 Basic TLV Setting

Use this screen to configure Basic TLV settings. Click **PORT > LLDP > LLDP > Basic TLV Setting** to display the screen as shown next.

Figure 190 PORT > LLDP > LLDP > Basic TLV Setting (Standalone Mode)

Port	Management Address	Port Description	System Capabilities	System Description	System Name
*	<input type="checkbox"/>	<input type="checkbox"/>	<input type="checkbox"/>	<input type="checkbox"/>	<input type="checkbox"/>
1	<input checked="" type="checkbox"/>	<input checked="" type="checkbox"/>	<input checked="" type="checkbox"/>	<input checked="" type="checkbox"/>	<input checked="" type="checkbox"/>
2	<input checked="" type="checkbox"/>	<input checked="" type="checkbox"/>	<input checked="" type="checkbox"/>	<input checked="" type="checkbox"/>	<input checked="" type="checkbox"/>
3	<input checked="" type="checkbox"/>	<input checked="" type="checkbox"/>	<input checked="" type="checkbox"/>	<input checked="" type="checkbox"/>	<input checked="" type="checkbox"/>
4	<input checked="" type="checkbox"/>	<input checked="" type="checkbox"/>	<input checked="" type="checkbox"/>	<input checked="" type="checkbox"/>	<input checked="" type="checkbox"/>
5	<input checked="" type="checkbox"/>	<input checked="" type="checkbox"/>	<input checked="" type="checkbox"/>	<input checked="" type="checkbox"/>	<input checked="" type="checkbox"/>
6	<input checked="" type="checkbox"/>	<input checked="" type="checkbox"/>	<input checked="" type="checkbox"/>	<input checked="" type="checkbox"/>	<input checked="" type="checkbox"/>
7	<input checked="" type="checkbox"/>	<input checked="" type="checkbox"/>	<input checked="" type="checkbox"/>	<input checked="" type="checkbox"/>	<input checked="" type="checkbox"/>

Figure 191 PORT > LLDP > LLDP > Basic TLV Setting (Stacking Mode)

Port	Management Address	Port Description	System Capabilities	System Description	System Name
1/*	<input type="checkbox"/>	<input type="checkbox"/>	<input type="checkbox"/>	<input type="checkbox"/>	<input type="checkbox"/>
1/1	<input checked="" type="checkbox"/>	<input checked="" type="checkbox"/>	<input checked="" type="checkbox"/>	<input checked="" type="checkbox"/>	<input checked="" type="checkbox"/>
1/2	<input checked="" type="checkbox"/>	<input checked="" type="checkbox"/>	<input checked="" type="checkbox"/>	<input checked="" type="checkbox"/>	<input checked="" type="checkbox"/>
1/3	<input checked="" type="checkbox"/>	<input checked="" type="checkbox"/>	<input checked="" type="checkbox"/>	<input checked="" type="checkbox"/>	<input checked="" type="checkbox"/>
1/4	<input checked="" type="checkbox"/>	<input checked="" type="checkbox"/>	<input checked="" type="checkbox"/>	<input checked="" type="checkbox"/>	<input checked="" type="checkbox"/>
1/5	<input checked="" type="checkbox"/>	<input checked="" type="checkbox"/>	<input checked="" type="checkbox"/>	<input checked="" type="checkbox"/>	<input checked="" type="checkbox"/>
1/6	<input checked="" type="checkbox"/>	<input checked="" type="checkbox"/>	<input checked="" type="checkbox"/>	<input checked="" type="checkbox"/>	<input checked="" type="checkbox"/>
1/7	<input checked="" type="checkbox"/>	<input checked="" type="checkbox"/>	<input checked="" type="checkbox"/>	<input checked="" type="checkbox"/>	<input checked="" type="checkbox"/>

The following table describes the labels in this screen.

Table 121 PORT > LLDP > LLDP > Basic TLV Setting

LABEL	DESCRIPTION
SLOT	This field appears only in Stacking mode. Click the drop-down list to choose the slot number of the Switch in a stack.
Port	This field displays the port number. In Stacking mode, the first number represents the slot ID and the second is the port number. Please note that the default stacking ports (the last four ports of your Switch) cannot be configured. They are reserved for stacking only.
*	Use this row to make the setting the same for all ports. Use this row first and then make adjustments to each port if necessary. Changes in this row are copied to all the ports as soon as you make them.
Management Address	Select the check boxes to enable or disable the sending of Management Address TLVs on the ports.
Port Description	Select the check boxes to enable or disable the sending of Port Description TLVs on the ports.
System Capabilities	Select the check boxes to enable or to disable the sending of System Capabilities TLVs on the ports.
System Description	Select the check boxes to enable or to disable the sending of System Description TLVs on the ports.
System Name	Select the check boxes to enable or to disable the sending of System Name TLVs on the ports.
Apply	Click Apply to save your changes to the Switch's run-time memory. The Switch loses these changes if it is turned off or loses power, so use the Save link on the top navigation panel to save your changes to the non-volatile memory when you are done configuring.
Cancel	Click Cancel to begin configuring this screen afresh.

36.7 Org-specific TLV Setting

Use this screen to configure organization-specific TLV settings. Click **PORT > LLDP > LLDP > Org-specific TLV Setting** to display the screen as shown next.

Figure 192 PORT > LLDP > LLDP > Org-specific TLV Setting (Standalone Mode)

LLDP Local Status		LLDP Remote Status		LLDP Setup		Basic TLV Setting		Org-specific TLV Setting	
Port	Dot1 TLV		Link Aggregation	Dot3 TLV		Max Frame Size			
	Port-Protocol VLAN ID	Port VLAN ID		MAC/PHY					
*	<input type="checkbox"/>	<input type="checkbox"/>	<input type="checkbox"/>	<input type="checkbox"/>	<input type="checkbox"/>	<input type="checkbox"/>	<input type="checkbox"/>	<input type="checkbox"/>	<input type="checkbox"/>
1	<input type="checkbox"/>	<input checked="" type="checkbox"/>	<input type="checkbox"/>	<input checked="" type="checkbox"/>	<input type="checkbox"/>	<input checked="" type="checkbox"/>	<input type="checkbox"/>	<input type="checkbox"/>	<input type="checkbox"/>
2	<input type="checkbox"/>	<input checked="" type="checkbox"/>	<input type="checkbox"/>	<input checked="" type="checkbox"/>	<input type="checkbox"/>	<input checked="" type="checkbox"/>	<input type="checkbox"/>	<input type="checkbox"/>	<input type="checkbox"/>
3	<input type="checkbox"/>	<input checked="" type="checkbox"/>	<input type="checkbox"/>	<input checked="" type="checkbox"/>	<input type="checkbox"/>	<input checked="" type="checkbox"/>	<input type="checkbox"/>	<input type="checkbox"/>	<input type="checkbox"/>
4	<input type="checkbox"/>	<input checked="" type="checkbox"/>	<input type="checkbox"/>	<input checked="" type="checkbox"/>	<input type="checkbox"/>	<input checked="" type="checkbox"/>	<input type="checkbox"/>	<input type="checkbox"/>	<input type="checkbox"/>
5	<input type="checkbox"/>	<input checked="" type="checkbox"/>	<input type="checkbox"/>	<input checked="" type="checkbox"/>	<input type="checkbox"/>	<input checked="" type="checkbox"/>	<input type="checkbox"/>	<input type="checkbox"/>	<input type="checkbox"/>
6	<input type="checkbox"/>	<input checked="" type="checkbox"/>	<input type="checkbox"/>	<input checked="" type="checkbox"/>	<input type="checkbox"/>	<input checked="" type="checkbox"/>	<input type="checkbox"/>	<input type="checkbox"/>	<input type="checkbox"/>
7	<input type="checkbox"/>	<input checked="" type="checkbox"/>	<input type="checkbox"/>	<input checked="" type="checkbox"/>	<input type="checkbox"/>	<input checked="" type="checkbox"/>	<input type="checkbox"/>	<input type="checkbox"/>	<input type="checkbox"/>

Figure 193 PORT > LLDP > LLDP > Org-specific TLV Setting (Stacking Mode)

LLDP Local Status		LLDP Remote Status		LLDP Setup		Basic TLV Setting		Org-specific TLV Setting	
SLOT 1 ▾									
Port	Dot1 TLV		Link Aggregation	Dot3 TLV		Max Frame Size			
	Port-Protocol VLAN ID	Port VLAN ID		MAC/PHY					
1/*	<input type="checkbox"/>	<input type="checkbox"/>	<input type="checkbox"/>	<input type="checkbox"/>	<input type="checkbox"/>	<input type="checkbox"/>	<input type="checkbox"/>	<input type="checkbox"/>	<input type="checkbox"/>
1/1	<input type="checkbox"/>	<input checked="" type="checkbox"/>	<input type="checkbox"/>	<input checked="" type="checkbox"/>	<input type="checkbox"/>	<input checked="" type="checkbox"/>	<input type="checkbox"/>	<input type="checkbox"/>	<input type="checkbox"/>
1/2	<input type="checkbox"/>	<input checked="" type="checkbox"/>	<input type="checkbox"/>	<input checked="" type="checkbox"/>	<input type="checkbox"/>	<input checked="" type="checkbox"/>	<input type="checkbox"/>	<input type="checkbox"/>	<input type="checkbox"/>
1/3	<input type="checkbox"/>	<input checked="" type="checkbox"/>	<input type="checkbox"/>	<input checked="" type="checkbox"/>	<input type="checkbox"/>	<input checked="" type="checkbox"/>	<input type="checkbox"/>	<input type="checkbox"/>	<input type="checkbox"/>
1/4	<input type="checkbox"/>	<input checked="" type="checkbox"/>	<input type="checkbox"/>	<input checked="" type="checkbox"/>	<input type="checkbox"/>	<input checked="" type="checkbox"/>	<input type="checkbox"/>	<input type="checkbox"/>	<input type="checkbox"/>
1/5	<input type="checkbox"/>	<input checked="" type="checkbox"/>	<input type="checkbox"/>	<input checked="" type="checkbox"/>	<input type="checkbox"/>	<input checked="" type="checkbox"/>	<input type="checkbox"/>	<input type="checkbox"/>	<input type="checkbox"/>
1/6	<input type="checkbox"/>	<input checked="" type="checkbox"/>	<input type="checkbox"/>	<input checked="" type="checkbox"/>	<input type="checkbox"/>	<input checked="" type="checkbox"/>	<input type="checkbox"/>	<input type="checkbox"/>	<input type="checkbox"/>
1/7	<input type="checkbox"/>	<input checked="" type="checkbox"/>	<input type="checkbox"/>	<input checked="" type="checkbox"/>	<input type="checkbox"/>	<input checked="" type="checkbox"/>	<input type="checkbox"/>	<input type="checkbox"/>	<input type="checkbox"/>

The following table describes the labels in this screen.

Table 122 PORT > LLDP > LLDP > Org-specific TLV Setting

LABEL	DESCRIPTION
SLOT	This field appears only in Stacking mode. Click the drop-down list to choose the slot number of the Switch in a stack.
Port	This field displays the port number. In Stacking mode, the first number represents the slot ID and the second is the port number. Please note that the default stacking ports (the last four ports of your Switch) cannot be configured. They are reserved for stacking only.
*	Use this row to make the setting the same for all ports. Use this row first and then make adjustments to each port if necessary. Changes in this row are copied to all the ports as soon as you make them.
Dot1 TLV	
Port-Protocol VLAN ID	Select the check boxes to enable or disable the sending of IEEE 802.1 Port and Protocol VLAN ID TLVs on the ports.
Port VLAN ID	Select the check boxes to enable or disable the sending of IEEE 802.1 Port VLAN ID TLVs on the ports. All check boxes in this column are enabled by default.
Dot3 TLV	
Link Aggregation	Select the check boxes to enable or disable the sending of IEEE 802.3 Link Aggregation TLVs on the ports.
MAC/PHY	Select the check boxes to enable or disable the sending of IEEE 802.3 MAC/PHY Configuration/Status TLVs on the ports. All check boxes in this column are enabled by default.
Max Frame Size	Select the check boxes to enable or disable the sending of IEEE 802.3 Max Frame Size TLVs on the ports.
Apply	Click Apply to save your changes to the Switch's run-time memory. The Switch loses these changes if it is turned off or loses power, so use the Save link on the top navigation panel to save your changes to the non-volatile memory when you are done configuring.
Cancel	Click Cancel to begin configuring this screen afresh.

36.8 LLDP-MED Setup

Click **PORT > LLDP > LLDP MED > LLDP-MED Setup** to display the screen as shown next.

Figure 194 PORT > LLDP > LLDP MED > LLDP-MED Setup (Standalone Mode)

LLDP-MED Setup			
LLDP-MED Network Policy		LLDP-MED Location	
Port	Notification	MED TLV Setting	
	Topology Change	Location	Network Policy
*	<input type="checkbox"/>	<input type="checkbox"/>	<input type="checkbox"/>
1	<input type="checkbox"/>	<input type="checkbox"/>	<input type="checkbox"/>
2	<input type="checkbox"/>	<input type="checkbox"/>	<input type="checkbox"/>
3	<input type="checkbox"/>	<input type="checkbox"/>	<input type="checkbox"/>
4	<input type="checkbox"/>	<input type="checkbox"/>	<input type="checkbox"/>
5	<input type="checkbox"/>	<input type="checkbox"/>	<input type="checkbox"/>
6	<input type="checkbox"/>	<input type="checkbox"/>	<input type="checkbox"/>
7	<input type="checkbox"/>	<input type="checkbox"/>	<input type="checkbox"/>

Figure 195 PORT > LLDP > LLDP MED > LLDP-MED Setup (Stacking Mode)

LLDP-MED Setup			
LLDP-MED Network Policy		LLDP-MED Location	
SLOT 1 ▾			
Port	Notification	MED TLV Setting	
	Topology Change	Location	Network Policy
1/*	<input type="checkbox"/>	<input type="checkbox"/>	<input type="checkbox"/>
1/1	<input type="checkbox"/>	<input type="checkbox"/>	<input type="checkbox"/>
1/2	<input type="checkbox"/>	<input type="checkbox"/>	<input type="checkbox"/>
1/3	<input type="checkbox"/>	<input type="checkbox"/>	<input type="checkbox"/>
1/4	<input type="checkbox"/>	<input type="checkbox"/>	<input type="checkbox"/>
1/5	<input type="checkbox"/>	<input type="checkbox"/>	<input type="checkbox"/>
1/6	<input type="checkbox"/>	<input type="checkbox"/>	<input type="checkbox"/>
1/7	<input type="checkbox"/>	<input type="checkbox"/>	<input type="checkbox"/>

The following table describes the labels in this screen.

Table 123 PORT > LLDP > LLDP MED > LLDP-MED Setup

LABEL	DESCRIPTION
SLOT	This field appears only in Stacking mode. Click the drop-down list to choose the slot number of the Switch in a stack.
Port	This field displays the port number. In stacking mode, the first number represents the slot ID and the second is the port number. Please note that the default stacking ports (the last four ports of your Switch) cannot be configured. They are reserved for stacking only.
*	Use this row to make the setting the same for all ports. Use this row first and then make adjustments to each port if necessary. Changes in this row are copied to all the ports as soon as you make them.

Table 123 PORT > LLDP > LLDP MED > LLDP-MED Setup (continued)

LABEL	DESCRIPTION
Notification	
Topology Change	Select to enable LLDP-MED topology change traps on this port.
MED TLV Setting	
Location	Select to enable transmitting LLDP-MED location TLV.
Network Policy	Select to enable transmitting LLDP-MED Network Policy TLV.
Apply	Click Apply to save the changes to the Switch's run-time memory. The Switch loses these changes if it is turned off or loses power, so use the Save link on the top navigation panel to save your changes to the non-volatile memory when you are done configuring.
Cancel	Click Cancel to begin configuring this screen afresh.

36.9 LLDP-MED Network Policy

Click **PORT > LLDP > LLDP MED > LLDP-MED Network Policy** to display the screen as shown next.

Figure 196 PORT > LLDP > LLDP MED > LLDP-MED Network Policy

<input type="checkbox"/>	Index	Port	Application Type	Tag	VLAN	DSCP	Priority
<input type="checkbox"/>	1	1	voice	tagged	1	10	0

The following table describes the labels in this screen.

Table 124 PORT > LLDP > LLDP MED > LLDP-MED Network Policy

LABEL	DESCRIPTION
Index	This field displays the of index number of the network policy. Click an index number to edit the rule.
Port	This field displays the port number of the network policy. In Stacking mode, the first number represents the slot and the second the port number.
Application Type	This field displays the application type of the network policy.
Tag	This field displays the Tag Status of the network policy.
VLAN	This field displays the VLAN ID of the network policy.
DSCP	This field displays the DSCP value of the network policy.
Priority	This field displays the priority value of the network policy.
	Select an entry's check box to select a specific entry. Otherwise, select the check box in the table heading row to select all entries.
Add/Edit	Click Add/Edit to add a new schedule rule or edit a selected one.
Delete	Select the rules that you want to remove, then click Delete .

36.9.1 Add/Edit LLDP-MED Network Policy

To access this screen, click the **Add/Edit** button or select an entry from the list and click the **Add/Edit** button.

Figure 197 PORT > LLDP > LLDP MED > LLDP-MED Network Policy > Add/Edit

The screenshot shows a configuration form with the following fields and values:

- Port: [Empty text box]
- Application Type: [voice] (dropdown menu)
- Tag: [tagged] (dropdown menu)
- VLAN: [Empty text box]
- DSCP: [Empty text box]
- Priority: [0] (dropdown menu)

At the bottom of the form are three buttons: **Apply** (green), **Clear** (grey), and **Cancel** (grey).

The following table describes the labels in this screen.

Table 125 PORT > LLDP > LLDP MED > LLDP-MED Network Policy > Add/Edit

LABEL	DESCRIPTION
Port	Enter the port number to set up the LLDP-MED network policy. You can enter multiple ports separated by (no space) comma (",") or hyphen ("-") for a range. For example, enter "3-5" for ports 3, 4, and 5. Enter "3,5,7" for ports 3, 5, and 7. In Stacking mode, the first number represents the slot and the second the port number. Enter "1/1-1/24,2/23" for ports 1 to 24 for the Switch in slot 1 and port 23 for the Switch in slot 2, for example.
Application Type	Select the type of application used in the network policy. <ul style="list-style-type: none"> • voice • voice-signaling • guest-voice • guest-voice-signaling • softphone-voice • video-conferencing • streaming-video • video-signaling
Tag	Select to tag or untag in the network policy. <ul style="list-style-type: none"> • tagged • untagged
VLAN	Enter the VLAN ID number. It should be from 1 to 4094. For priority tagged frames, enter "0".
DSCP	Enter the DSCP value of the network policy. The value is defined from 0 through 63 with the 0 representing use of the default DSCP value.
Priority	Enter the priority value for the network policy.
Apply	Click Apply to save your changes to the Switch's run-time memory. The Switch loses these changes if it is turned off or loses power, so use the Save link on the top navigation panel to save your changes to the non-volatile memory when you are done configuring.
Clear	Click Clear to clear the fields to the factory defaults.
Cancel	Click Cancel to not save the configuration you make and return to the last screen.

36.10 LLDP-MED Location

Click **PORT > LLDP > LLDP MED > LLDP-MED Location** to display the screen as shown next.

Figure 198 PORT > LLDP > LLDP MED > LLDP-MED Location

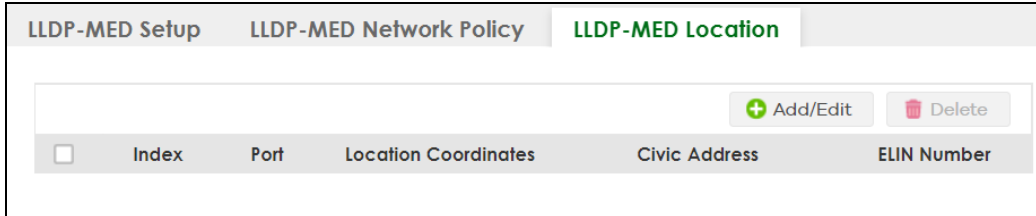

The following table describes the labels in this screen.

Table 126 PORT > LLDP > LLDP MED > LLDP-MED Location

LABEL	DESCRIPTION
Index	This lists the index number of the location configuration. Click an index number to view or edit the location.
Port	This lists the port number of the location configuration. In Stacking mode, the first number represents the slot and the second the port number.
Location Coordinates	This field displays the location configuration information based on geographical coordinates that includes longitude, latitude, altitude and datum.
Civic Address	This field displays the Civic Address for the remote device using information such as Country, State, County, City, Street, Number, ZIP code and additional information.
ELIN Number	This field shows the Emergency Location Identification Number (ELIN), which is used to identify endpoint devices when they issue emergency call services. The valid length is form 10 to 25 characters.
	Select an entry's check box to select a specific entry. Otherwise, select the check box in the table heading row to select all entries.
Add/Edit	Click Add/Edit to add a new location or edit a selected one.
Delete	Select the locations that you want to remove, then click Delete .

36.10.1 Add/Edit LLDP-MED Location

To access this screen, click the **Add/Edit** button or select an entry from the list and click the **Add/Edit** button.

Figure 199 PORT > LLDP > LLDP MED > LLDP-MED Location > Add/Edit (Standalone Mode)

Port	<input type="text"/>		
Location Coordinates			
Latitude	<input type="text"/>	north	▼
Longitude	<input type="text"/>	west	▼
Altitude	<input type="text"/>	meters	▼
Datum	WGS84 ▼		
Civic Address			
Country	<input type="text"/>	State	<input type="text"/>
County	<input type="text"/>	City	<input type="text"/>
Division	<input type="text"/>	Neighbor	<input type="text"/>
Street	<input type="text"/>	Leading-Street-Direction	<input type="text"/>
Street-Suffix	<input type="text"/>	Trailing-Street-Suffix	<input type="text"/>
House-Number	<input type="text"/>	House-Number-Suffix	<input type="text"/>
Landmark	<input type="text"/>	Additional-Location	<input type="text"/>
Name	<input type="text"/>	Zip-Code	<input type="text"/>
Building	<input type="text"/>	Unit	<input type="text"/>
Floor	<input type="text"/>	Room-Number	<input type="text"/>
Place-Type	<input type="text"/>	Postal-Community-Name	<input type="text"/>
Post-Office-Box	<input type="text"/>	Additional-Code	<input type="text"/>
ELIN			
ELIN Number	<input type="text"/>		
		Apply	Clear
			Cancel

Figure 200 PORT > LLDP > LLDP MED > LLDP-MED Location > Add/Edit (Stacking Mode)

The following table describes the labels in this screen.

Table 127 PORT > LLDP > LLDP MED > LLDP-MED Location > Add/Edit

LABEL	DESCRIPTION
Port	Enter the port number you want to set up the location within the LLDP-MED network. In Stacking mode, the first field is the slot ID and the second field is the port number.
Location Coordinates The LLDP-MED uses geographical coordinates and Civic Address to set the location information of the remote device. Geographical based coordinates includes latitude, longitude, altitude and datum. Civic Address includes Country, State, County, City, Street and other related information.	
Latitude	Enter the latitude information. The value should be from 0° to 90°. <ul style="list-style-type: none"> • north • south

Table 127 PORT > LLDP > LLDP MED > LLDP-MED Location > Add/Edit (continued)

LABEL	DESCRIPTION
Longitude	Enter the longitude information. The value should be from 0° to 180°. <ul style="list-style-type: none"> • west • east
Altitude	Enter the altitude information. The value should be from -2097151 to 2097151 in meters or in floors. <ul style="list-style-type: none"> • meters • floor
Datum	Select the appropriate geodetic datum used by GPS. <ul style="list-style-type: none"> • WGS84 • NAD83-NAVD88 • NAD83-MLLW
Civic Address	Enter the Civic Address by providing information such as Country, State, County, City, Street, Number, ZIP code and other additional information. Enter at least 2 fields in this configuration including the Country. The valid length of the Country field is 2 characters and all other fields are up to 32 characters. <ul style="list-style-type: none"> • Country • State • County • City • Division • Neighbor • Street • Leading-Street-Direction • Street-Suffix • Trailing-Street-Suffix • House-Number • House-Number-Suffix • Landmark • Additional-Location • Name • Zip-Code • Building • Unit • Floor • Room-Number • Place-Type • Postal-Community-Name • Post-Office-Box • Additional-Code
ELIN Number	Enter a numerical digit string, corresponding to the ELIN identifier which is used during emergency call setup to a traditional CAMA or ISDN trunk-based PSAP. The valid length is from 10 to 25 characters.
Apply	Click Apply to save your changes to the Switch's run-time memory. The Switch loses these changes if it is turned off or loses power, so use the Save link on the top navigation panel to save your changes to the non-volatile memory when you are done configuring.
Clear	Click Clear to clear the fields to the factory defaults.
Cancel	Click Cancel to not save the configuration you make and return to the last screen.

CHAPTER 37

OAM

37.1 OAM Overview

Link layer Ethernet OAM (Operations, Administration and Maintenance) as described in IEEE 802.3ah is a link monitoring protocol. It utilizes OAM Protocol Data Units or OAM PDUs to transmit link status information between directly connected Ethernet devices. Both devices must support IEEE 802.3ah. Because link layer Ethernet OAM operates at layer two of the OSI (Open Systems Interconnection Basic Reference) model, neither IP or SNMP are necessary to monitor or troubleshoot network connection problems.

The Switch supports the following IEEE 802.3ah features:

- Discovery – this identifies the devices on each end of the Ethernet link and their OAM configuration.
- Remote Loopback – this can initiate a loopback test between Ethernet devices.

37.1.1 What You Can Do

- Use the **OAM Status** screen ([Section 37.2 on page 272](#)) to view the configuration of ports on which Ethernet OAM is enabled.
- Use the **OAM Setup** screen ([Section 37.3 on page 278](#)) to enable Ethernet OAM on the Switch.
- Use the **OAM Remote Loopback** screen ([Section 37.4 on page 280](#)) to perform remote-loopback tests.

37.2 OAM Status

Use this screen to view the configuration of ports on which Ethernet OAM is enabled. Click **PORT > OAM > OAM Status** in the navigation panel.

Figure 201 PORT > OAM > OAM Status (Standalone Mode)

OAM Status					
OAM Setup		OAM Remote Loopback			
OAM is disabled					
Local			Remote		
Port	Mode	Mac Address	OUI	Mode	Config
1					
2					
3					
4					
5					
6					
7					

Figure 202 PORT > OAM > OAM Status (Stacking Mode)

OAM Status					
OAM Setup		OAM Remote Loopback			
OAM is disabled					
SLOT 1 ▾					
Local			Remote		
Port	Mode	Mac Address	OUI	Mode	Config
1/1					
1/2					
1/3					
1/4					
1/5					
1/6					
1/7					

The following table describes the fields in the above screen.

Table 128 PORT > OAM > OAM Status

LABEL	DESCRIPTION
SLOT	This field appears only in Stacking mode. Click the drop-down list to choose the slot number of the Switch in a stack.
Local	This section displays information about the ports on the Switch.
Port	This field displays the port number. In Stacking mode, the first number represents the slot ID and the second is the port number. Please note that the default stacking ports (the last four ports of your Switch) cannot be configured. They are reserved for stacking only.
Mode	This field displays the operational state of the port when OAM is enabled on the port. Active – Allows the port to issue and respond to Ethernet OAM commands. Passive – Allows the port to respond to Ethernet OAM commands.

Table 128 PORT > OAM > OAM Status (continued)

LABEL	DESCRIPTION
Remote	This section displays information about the remote device.
Mac Address	This field displays the MAC address of the remote device.
OUI	This field displays the OUI (first 3 bytes of the MAC address) of the remote device.
Mode	This field displays the operational state of the port when OAM is enabled on the port. Active – Allows the port to issue and respond to Ethernet OAM commands. Passive – Allows the port to respond to Ethernet OAM commands.
Config	This field displays the capabilities of the Switch and remote device.

37.2.1 OAM Details

Use this screen to view OAM configuration details and operational status of a specific port. Click a number in the **Port** column in the **PORT > OAM > OAM Status** screen to display the screen as shown next.

Figure 203 PORT > OAM > OAM Status > OAM Details

OAM Status	OAM Setup	OAM Remote Loopback
OAM Status > OAM Details		
Port No: 1		
Discovery		
Local Client Setup		Remote Client
Mode	Unidirectional	MAC address
Remote loopback	Link events	Vendor(out)
Variable retrieval	Max. OAMPDU size	Remote Client Setup
		Mode
		Unidirectional
		Remote loopback
		Link events
		Variable retrieval
		Max OAMPDU size
Local Client Operational Status		Remote Client Operational Status
Link status	Info. revision	
Info. revision		
Parser state		
Discovery state		
Statistics		
Information OAMPDU Tx		
Information OAMPDU Rx		
Event Notification OAMPDU Tx		
Event Notification OAMPDU Rx		
Loopback Control OAMPDU Tx		
Loopback Control OAMPDU Rx		
Variable Request OAMPDU Tx		
Variable Request OAMPDU Rx		
Variable Response OAMPDU Tx		
Variable Response OAMPDU Rx		
Unsupported OAMPDU Tx		
Unsupported OAMPDU Rx		

The following table describes the fields in the above screen.

Table 129 PORT > OAM > OAM Status > OAM Details

LABEL	DESCRIPTION
Port No	This field displays the port number. In Stacking mode, the first number represents the slot ID and the second is the port number.
Discovery This section displays OAM configuration details and operational status of the port on the Switch and/or the remote device.	
Local Client/Remote Client Setup	
Mode	This field displays the OAM mode. The device in active mode (typically the service provider's device) controls the device in passive mode (typically the subscriber's device). Active: The port initiates OAM discovery; sends information PDUs; and may send event notification PDUs, variable request/response PDUs, or loopback control PDUs. Passive: The port waits for the remote device to initiate OAM discovery; sends information PDUs; may send event notification PDUs; and may respond to variable request PDUs or loopback control PDUs. The Switch might not support some types of PDUs, as indicated in the fields below.
Unidirectional	This field indicates whether or not the port can send information PDUs to transmit fault information when the receive path is non-operational.
Remote loopback	This field indicates whether or not the port can use loopback control PDUs to put the remote device into loopback mode.
Link events	This field indicates whether or not the port can interpret link events, such as link fault and dying gasp. Link events are sent in event notification PDUs and indicate when the number of errors in a given interval (time, number of frames, number of symbols, or number of error frame seconds) exceeds a specified threshold. Organizations may create organization-specific link event TLVs as well.
Variable retrieval	This field indicates whether or not the port can respond to requests for more information, such as requests for Ethernet counters and statistics, about link events.
Max. OAMPDU size	This field displays the maximum size of PDU for receipt and delivery.
Local Client/Remote Client Operational status	
Link status	This field indicates that the link between the Switch port and a connected IEEE 802.3ah-enabled remote Ethernet device is up or down.
Info. revision	This field displays the current version of local state and configuration. This two-octet value starts at zero and increments every time the local state or configuration changes.
Parser state	This field indicates the current state of the parser. Forward: The port is forwarding packets normally. Loopback: The port is in loopback mode. Discard: The port is discarding non-OAM PDUs because it is trying to or has put the remote device into loopback mode.

Table 129 PORT > OAM > OAM Status > OAM Details (continued)

LABEL	DESCRIPTION
Discovery state	<p>This field indicates the state in the OAM discovery process. OAM-enabled devices use this process to detect each other and to exchange information about their OAM configuration and capabilities. OAM discovery is a handshake protocol.</p> <p>Fault: One of the devices is transmitting OAM PDUs with link fault information, or the interface is not operational.</p> <p>Active Send Local: The port is in active mode and is trying to see if the remote device supports OAM.</p> <p>Passive Wait: The port is in passive mode and is waiting for the remote device to begin OAM discovery.</p> <p>Send Local Remote: This state occurs in the following circumstances.</p> <ul style="list-style-type: none"> • The port has discovered the remote device but has not accepted or rejected the connection yet. • The port has discovered the remote device and rejected the connection. <p>Send Local Remote OK: The port has discovered the remote device and has accepted the connection. In addition, the remote device has not accepted or rejected the connection yet, or the remote device has rejected the connection.</p> <p>Send Any: The port and the remote device have accepted the connection. This is the operating state for OAM links that are fully operational.</p>
Remote Client	
MAC Address	This field displays the MAC address of the IEEE 802.3ah-enabled remote Ethernet device that is connected to the Switch.
Vendor(oui)	This field displays the Organizationally Unique Identifiers (OUI) representing the vendor of the IEEE 802.3ah-enabled remote Ethernet device that is connected to the Switch.
Statistics	
This section displays the number of OAM packets transferred on the port of the Switch.	
Information OAMPDU Tx	This field displays the number of OAM PDUs sent on the port.
Information OAMPDU Rx	This field displays the number of OAM PDUs received on the port.
Event Notification OAMPDU Tx	This field displays the number of unique or duplicate OAM event notification PDUs sent on the port.
Event Notification OAMPDU Rx	This field displays the number of unique or duplicate OAM event notification PDUs received on the port.
Loopback Control OAMPDU Tx	This field displays the number of loopback control OAM PDUs sent on the port.
Loopback Control OAMPDU Rx	This field displays the number of loopback control OAM PDUs received on the port.
Variable Request OAMPDU Tx	This field displays the number of OAM PDUs sent to request MIB objects on the remote device.
Variable Request OAMPDU Rx	This field displays the number of OAM PDUs received requesting MIB objects on the Switch.
Variable Response OAMPDU Tx	This field displays the number of OAM PDUs sent by the Switch in response to requests.
Variable Response OAMPDU Rx	This field displays the number of OAM PDUs sent by the remote device in response to requests.

Table 129 PORT > OAM > OAM Status > OAM Details (continued)

LABEL	DESCRIPTION
Unsupported OAMPDU Tx	This field displays the number of unsupported OAM PDUs sent on the port.
Unsupported OAMPDU Rx	This field displays the number of unsupported OAM PDUs received on the port.

37.3 OAM Setup

Use this screen to turn on Ethernet OAM on the Switch and ports and configure the related settings.

Click **PORT > OAM > OAM Setup** to display the configuration screen as shown.

Figure 204 PORT > OAM > OAM Setup (Standalone Mode)

Port	Active	Mode	Remote Loopback Supported	Remote Loopback Ignore-Rx
*	<input type="checkbox"/>	Active ▾	<input type="checkbox"/>	<input type="checkbox"/>
1	<input type="checkbox"/>	Active ▾	<input type="checkbox"/>	<input type="checkbox"/>
2	<input type="checkbox"/>	Active ▾	<input type="checkbox"/>	<input type="checkbox"/>
3	<input type="checkbox"/>	Active ▾	<input type="checkbox"/>	<input type="checkbox"/>
4	<input type="checkbox"/>	Active ▾	<input type="checkbox"/>	<input type="checkbox"/>
5	<input type="checkbox"/>	Active ▾	<input type="checkbox"/>	<input type="checkbox"/>
6	<input type="checkbox"/>	Active ▾	<input type="checkbox"/>	<input type="checkbox"/>
7	<input type="checkbox"/>	Active ▾	<input type="checkbox"/>	<input type="checkbox"/>

Figure 205 PORT > OAM > OAM Setup (Stacking Mode)

The following table describes the fields in the above screen.

Table 130 PORT > OAM > OAM Setup

LABEL	DESCRIPTION
Active	Enable the switch button to enable Ethernet OAM on the Switch.
SLOT	This field appears only in Stacking mode. Click the drop-down list to choose the slot number of the Switch in a stack.
Port	This field displays the port number. In Stacking mode, the first number represents the slot ID and the second is the port number. Please note that the default stacking ports (the last four ports of your Switch) cannot be configured. They are reserved for stacking only.
*	Settings in this row apply to all ports. Use this row only if you want to make some settings the same for all ports. Use this row first to set the common settings and then make adjustments on a port-by-port basis. Note: Changes in this row are copied to all the ports as soon as you make them.
Active	Select this check box to enable Ethernet OAM on this port. Clear this check box to disable Ethernet OAM on the port.
Mode	Specify the OAM mode on the port. Select Active to allow the port to issue and respond to Ethernet OAM commands. Select Passive to allow the port to respond to Ethernet OAM commands.
Remote Loopback Supported	Select this check box to enable the remote loopback feature on the port. Otherwise, clear the check box to disable it.
Remote Loopback Ignore-Rx	Select this check box to set the Switch to process loopback commands received on the port. Otherwise, clear the check box to have the Switch ignore loopback commands received on the port.

Table 130 PORT > OAM > OAM Setup (continued)

LABEL	DESCRIPTION
Apply	Click Apply to save your changes to the Switch's run-time memory. The Switch loses these changes if it is turned off or loses power, so use the Save link on the top navigation panel to save your changes to the non-volatile memory when you are done configuring.
Cancel	Click Cancel to begin configuring this screen afresh.

37.4 OAM Remote Loopback

Use this screen to perform a remote loopback test. Click **PORT > OAM > OAM Remote Loopback** to display the screen as shown.

Figure 206 PORT > OAM > OAM Remote Loopback (Standalone Mode)

The screenshot shows the 'OAM Remote Loopback' configuration page. At the top, there are three tabs: 'OAM Status', 'OAM Setup', and 'OAM Remote Loopback'. Below the tabs is a large text area with the text '- Info -'. Underneath the text area are two sections: 'Remote Loopback Test' and 'Remote Loopback Mode'. The 'Remote Loopback Test' section has three input fields: 'Port', 'Number of Packet', and 'Packet Size', followed by a 'Test' button. The 'Remote Loopback Mode' section has a 'Port' input field and 'Start' and 'Stop' buttons.

Figure 207 PORT > OAM > OAM Remote Loopback (Stacking Mode)

The following table describes the fields in the above screen.

Table 131 PORT > OAM > OAM Remote Loopback

LABEL	DESCRIPTION
Remote Loopback Test	
Port	Enter the number of the port from which the Switch performs a remote-loopback test. In Stacking mode, the first field is the slot ID and the second field is the port number.
Number of Packet	Define the allowable packet number of the loopback test frames.
Packet Size	Define the allowable packet size of the loopback test frames.
Test	Click Test to begin the test.
Remote Loopback Mode	
Port	Enter the number of the port from which the Switch sends loopback control PDUs to initiate or terminate a remote-loopback test. In Stacking mode, the first field is the slot ID and the second field is the port number.
Start	Click Start to initiate a remote-loopback test from the specified port by sending Enable Loopback Control PDUs to the remote device.
Stop	Click Stop to terminate a remote-loopback test from the specified port by sending Disable Loopback Control PDUs to the remote device.

CHAPTER 38

PoE Setup

38.1 PoE Status (for PoE models only)

Note: The following screens are available for the PoE models only.

The PoE models supports the IEEE 802.3bt High Power over Ethernet (PoE) standard.

A powered device (PD) is a device such as an access point or a switch, that supports PoE (Power over Ethernet) so that it can receive power from another device through an Ethernet port.

In the figure below, the IP camera and IP phone get their power directly from the Switch. Aside from minimizing the need for cables and wires, PoE removes the hassle of trying to find a nearby electric outlet to power up devices.

Figure 208 Powered Device Examples

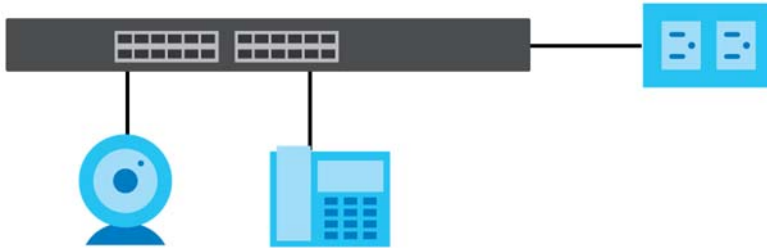

You can also set priorities so that the Switch is able to reserve and allocate power to certain PDs.

Note: The PoE (Power over Ethernet) devices that supply or receive power and their connected Ethernet cables must all be completely indoors.

Figure 209 PORT > PoE Setup > PoE Status (Standalone Mode)

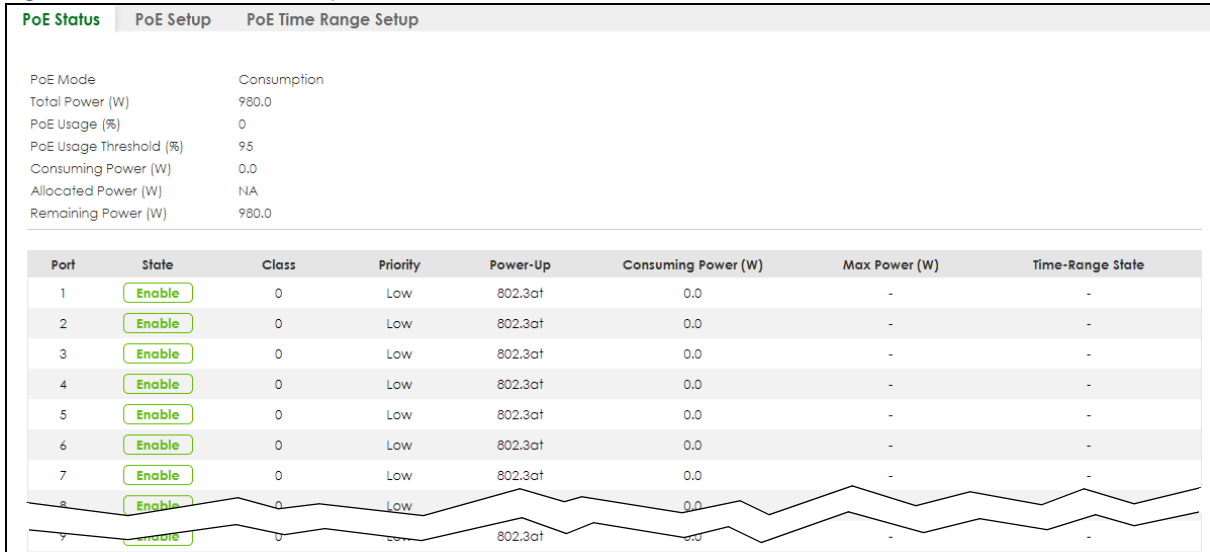
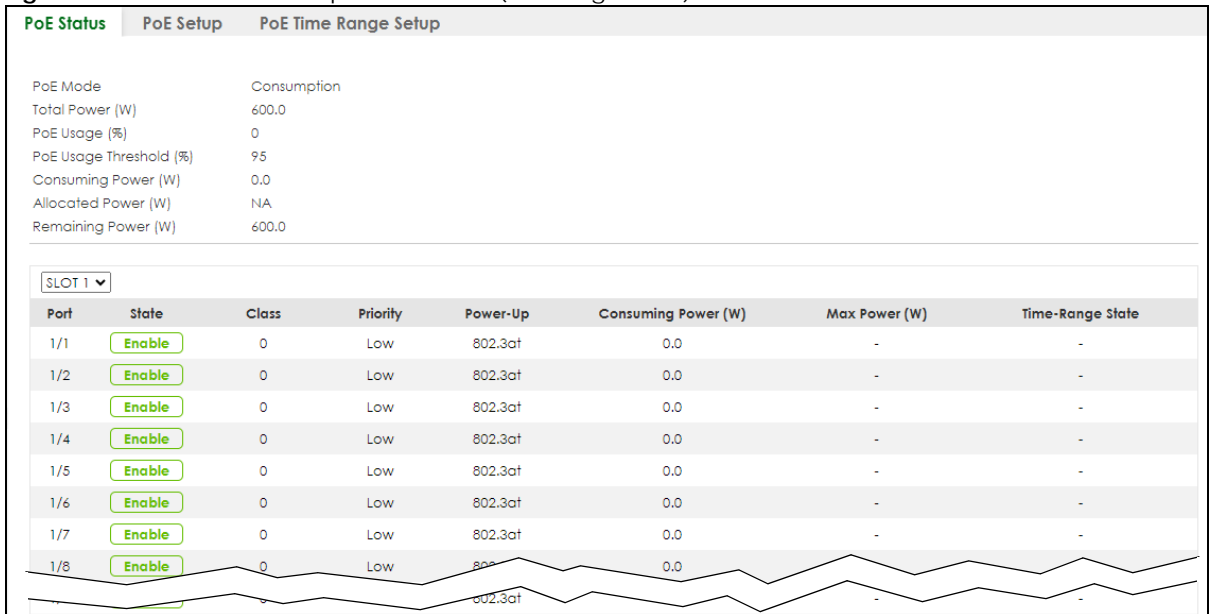

Figure 210 PORT > PoE Setup > PoE Status (Stacking Mode)



The following table describes the labels in this screen.

Table 132 PORT > PoE Setup > PoE Status

LABEL	DESCRIPTION
PoE Mode	This field displays the power management mode used by the Switch, whether it is in Classification or Consumption mode.
Total Power (W)	This field displays the total power the Switch can provide to the connected PoE-enabled devices on the PoE ports.
PoE Usage (%)	This field displays the amount of power currently being supplied to connected PoE devices (PDs) as a percentage of the total PoE power the Switch can supply. When PoE usage reaches 100%, the Switch will shut down PDs one-by-one according to the PD priority which you configured in PORT > PoE Setup > PoE Setup .
PoE Usage Threshold (%)	This field displays the percentage of PoE usage. The Switch will generate a trap and/or a log when the usage exceeds the specified threshold.

Table 132 PORT > PoE Setup > PoE Status (continued)

LABEL	DESCRIPTION
Consuming Power (W)	This field displays the amount of power the Switch is currently supplying to the connected PoE-enabled devices.
Allocated Power (W)	This field displays the total amount of power the Switch (in classification mode) has reserved for PoE after negotiating with the connected PoE devices. It shows NA when the Switch is in consumption mode. Consuming Power (W) can be less than or equal but not more than the Allocated Power (W) .
Remaining Power (W)	This field displays the amount of power the Switch can still provide for PoE.
SLOT	This field appears only in stacking mode. Click the drop-down list to choose the slot number of the Switch in a stack.
Port	The port number identifies the port you are configuring. In stacking mode, the first number represents the slot ID and the second one is the port number. Please note that the default stacking ports (the last two ports of your Switch) cannot be configured. They are reserved for stacking only.
State	This field shows which ports can receive power from the Switch. <ul style="list-style-type: none"> • Disable – The PD connected to this port cannot get power supply. • Enable – The PD connected to this port can receive power.
Class	This shows the power classification of the PD. Each PD has a specified maximum power that fall under one of the classes. The Class is a number from 0 to 6, where each value represents the range of power that the Switch provides to the PD. The power ranges in PoE standards are as follows. <ul style="list-style-type: none"> • Class 0 – default: 0.44 W to 15.4 W. • Class 1 – default: 0.44 W to 4 W. • Class 2 – default: 0.44 W to 7 W. • Class 3 – default: 0.44 W to 15.4 W. • Class 4 – default: 0.44 W to 30 W. • Class 5 – default: 0.45 W to 45 W. • Class 6 – default: 0.45 W to 60 W. <p>Note: You can extend or set a limit on the maximum power the connected PD can use on a port in PORT > PoE Setup > PoE Setup.</p>
Priority	When the total power requested by the PDs exceeds the total PoE power budget on the Switch, you can set the priority to allow the Switch to provide power to ports with higher priority first. <ul style="list-style-type: none"> • Critical has the highest priority. • High has the Switch assign power to the port after all critical priority ports are served. • Low has the Switch assign power to the port after all critical and high priority ports are served.
Power-Up	This field displays the PoE standard the Switch uses to provide power on this port.
Consuming Power (W)	This field displays the current amount of power consumed by the PD from the Switch on this port.
Max Power (W)	This field displays the maximum amount of power the PD could use from the Switch on this port. This field displays “–” if the maximum power is not specified in PORT > PoE Setup > PoE Setup .
Time-Range State	This field shows whether or not the port currently receives power from the Switch according to its schedule. <ul style="list-style-type: none"> • It shows “In” followed by the time range name if PoE is currently enabled on the port. • It shows “Out” if PoE is currently disabled on the port. • It shows “–” if no schedule is applied to the port. PoE is enabled by default.

38.2 PoE Setup

Use this screen to set the PoE power management mode, priority levels, power-up mode and the maximum amount of power for the connected PDs.

Click the **PoE Setup** tab in the **PORT > PoE Setup** screen. The following screen opens.

Figure 211 PORT > PoE Setup > PoE Setup (Standalone Mode)

PoE Status | **PoE Setup** | PoE Time Range Setup

PoE Mode: Classification Consumption

Continuous PoE: ON OFF

MIB Trap: ON OFF

PoE Usage Threshold (%):

Port	Active	Priority	Power-Up	Max Power (mW)	LLDP Power Via MDI
*	<input type="checkbox"/>	Critical	802.3af	<input type="text"/>	<input type="checkbox"/>
1	<input checked="" type="checkbox"/>	Low	802.3af	<input type="text"/>	<input checked="" type="checkbox"/>
2	<input checked="" type="checkbox"/>	Low	802.3af	<input type="text"/>	<input checked="" type="checkbox"/>
3	<input checked="" type="checkbox"/>	Low	802.3af	<input type="text"/>	<input checked="" type="checkbox"/>
4	<input checked="" type="checkbox"/>	Low	802.3af	<input type="text"/>	<input checked="" type="checkbox"/>
5	<input checked="" type="checkbox"/>	Low	802.3af	<input type="text"/>	<input checked="" type="checkbox"/>
6	<input checked="" type="checkbox"/>	Low	802.3af	<input type="text"/>	<input checked="" type="checkbox"/>
7	<input checked="" type="checkbox"/>	Low	802.3af	<input type="text"/>	<input checked="" type="checkbox"/>
8	<input checked="" type="checkbox"/>	Low	802.3af	<input type="text"/>	<input checked="" type="checkbox"/>
9	<input checked="" type="checkbox"/>	Low	802.3af	<input type="text"/>	<input checked="" type="checkbox"/>
10	<input checked="" type="checkbox"/>	Low	802.3af	<input type="text"/>	<input checked="" type="checkbox"/>
11	<input checked="" type="checkbox"/>	Low	802.3af	<input type="text"/>	<input checked="" type="checkbox"/>
12	<input checked="" type="checkbox"/>	Low	802.3af	<input type="text"/>	<input checked="" type="checkbox"/>
13	<input checked="" type="checkbox"/>	Low	802.3af	<input type="text"/>	<input checked="" type="checkbox"/>
14	<input checked="" type="checkbox"/>	Low	802.3af	<input type="text"/>	<input checked="" type="checkbox"/>
15	<input checked="" type="checkbox"/>	Low	802.3af	<input type="text"/>	<input checked="" type="checkbox"/>

Apply Cancel

Figure 212 PORT > PoE Setup > PoE Setup (Stacking Mode)

PoE Status | **PoE Setup** | PoE Time Range Setup

PoE Mode: Classification Consumption

Continuous PoE: ON OFF

MIB Trap: ON OFF

PoE Usage Threshold (%):

SLOT 1

Port	Active	Priority	Power-Up	Max Power (mW)	LLDP Power Via MDI
1/*	<input type="checkbox"/>	Critical	802.3af	<input type="text"/>	<input type="checkbox"/>
1/1	<input checked="" type="checkbox"/>	Low	802.3af	<input type="text"/>	<input checked="" type="checkbox"/>
1/2	<input checked="" type="checkbox"/>	Low	802.3af	<input type="text"/>	<input checked="" type="checkbox"/>
1/3	<input checked="" type="checkbox"/>	Low	802.3af	<input type="text"/>	<input checked="" type="checkbox"/>
1/4	<input checked="" type="checkbox"/>	Low	802.3af	<input type="text"/>	<input checked="" type="checkbox"/>
1/5	<input checked="" type="checkbox"/>	Low	802.3af	<input type="text"/>	<input checked="" type="checkbox"/>
1/6	<input checked="" type="checkbox"/>	Low	802.3af	<input type="text"/>	<input checked="" type="checkbox"/>
1/7	<input checked="" type="checkbox"/>	Low	802.3af	<input type="text"/>	<input checked="" type="checkbox"/>
1/8	<input checked="" type="checkbox"/>	Low	802.3af	<input type="text"/>	<input checked="" type="checkbox"/>

Apply Cancel

The following table describes the labels in this screen.

Table 133 PORT > PoE Setup > PoE Setup

LABEL	DESCRIPTION
PoE Mode	<p>Select the power management mode you want the Switch to use.</p> <ul style="list-style-type: none"> • Classification – Select this if you want the Switch to reserve the maximum power for each PD according to the PD's power class and priority level. If the total power supply runs out, PDs with lower priority do not get power to function. In this mode, the maximum power is reserved based on what you configure in Max Power or the standard power limit for each class. • Consumption – Select this if you want the Switch to supply the actual power that the PD needs. The Switch also allocates power based on a port's Max Power and the PD's power class and priority level. The Switch puts a limit on the maximum amount of power the PD can request and use. In this mode, the default maximum power that can be delivered to the PD is 30 W (IEEE 802.3at Class 4) or 22 W (IEEE 802.3af Classes 0 to 3).
Continuous PoE	<p>Select ON to guarantee continuous power supply to the connected PDs while the Switch is restarting after a warm reboot. The Switch will NOT perform a power cycle on the connected PDs. If you do a cold reboot, the Switch also restarts the connected PDs.</p>
MIB Trap	<p>The Switch sends traps (monitoring event notification) to an SNMP (Simple Network Management Protocol) manager when an event occurs. See Section 26.6.1 on page 198 for more information on SNMP, MIB (Management Information Base), and SNMP traps.</p> <p>Select ON to allow sending of MIB Trap when the following situations occur:</p> <ul style="list-style-type: none"> • Situation 1 – Trap sent whenever a PoE port status change occurs (PoE port delivers power or delivers no power to a PD (powered device)) • Situation 2 – Trap sent in cases where the total power usage exceeds the PoE usage threshold • Situation 3 – Trap sent if total usage power decreases below the PoE usage threshold (only if previous total power usage exceeded the PoE usage threshold and a trap was sent). <p>Note: If the MIB Trap is ON, you must also configure:</p> <ul style="list-style-type: none"> • SNMP trap destination (SYSTEM > SNMP > SNMP), SNMP trap group (SYSTEM > SNMP > SNMP Trap Group) and SNMP trap port (SYSTEM > SNMP > SNMP Trap Port) for Situation 1 • SNMP trap destination and SNMP trap group for Situation 2 and Situation 3. <p>See Section 26.2 on page 192 for more information on configuring SNMP.</p>
PoE Usage Threshold (%)	<p>Enter a number ranging from 1 to 99 to set the threshold. The Switch will generate a trap and/or log when the actual PoE usage is higher than the specified threshold.</p>
SLOT	<p>This field appears only in stacking mode. Click the drop-down list to choose the slot number of the Switch in a stack.</p>
Port	<p>The port number identifies the port you are configuring. In stacking mode, the first number represents the slot ID and the second one is the port number. Please note that the default stacking ports (the last two ports of your Switch) cannot be configured. They are reserved for stacking only.</p>
*	<p>Settings in this row apply to all ports.</p> <p>Use this row only if you want to make some settings the same for all ports. Use this row first to set the common settings and then make adjustments on a port-by-port basis.</p> <p>Changes in this row are copied to all the ports as soon as you make them.</p>
Active	<p>Select this to provide power to a PD connected to the port.</p> <p>If left unchecked, the PD connected to the port cannot receive power from the Switch.</p>

Table 133 PORT > PoE Setup > PoE Setup (continued)

LABEL	DESCRIPTION
Priority	<p>When the total power requested by the PDs exceeds the total PoE power budget on the Switch, you can set the PD priority to allow the Switch to provide power to ports with higher priority.</p> <p>Select Critical to give the highest PD priority on the port.</p> <p>Select High to set the Switch to assign the remaining power to the port after all critical priority ports are served.</p> <p>Select Low to set the Switch to assign the remaining power to the port after all critical and high priority ports are served.</p>
Power-Up	<p>Set how the Switch provides power to a connected PD at power-up.</p> <p>802.3af – the Switch follows the IEEE 802.3af Power over Ethernet standard to supply power to the connected PDs during power-up.</p> <p>Legacy – the Switch can provide power to the connected PDs that require high inrush currents at power-up. Inrush current is the maximum, instantaneous input current drawn by the PD when first turned on.</p> <p>Pre-802.3at – the Switch initially offers power on the port according to the IEEE 802.3af standard, and then switches to support the IEEE 802.3at standard within 75 milliseconds after a PD is connected to the port. Select this option if the Switch is performing 2-event Layer-1 classification (PoE+ hardware classification) or the connected PD is NOT performing Layer 2 power classification using Link Layer Discovery Protocol (LLDP).</p> <p>802.3at – the Switch supports the IEEE 802.3at High Power over Ethernet standard and can supply power of up to 30 W per Ethernet port. IEEE 802.3at is also known as PoE+ or PoE Plus. An IEEE 802.3at compatible device is referred to as Type 2. Power Class 4 (High Power) can only be used by Type 2 devices. If the connected PD requires a Class 4 current when it is turned on, it will be powered up in this mode.</p> <p>Force-802.3at – the Switch offers power of up to 33 W on the port without performing PoE hardware classification. Select this option if the connected PD does not comply with any PoE standard and requests power higher than a standard power limit.</p> <p>Pre-802.3bt – the Switch offers power on the port according to the IEEE 802.3bt standard. Select this option if the connected PD was developed before the IEEE 802.3bt standard is implemented but requires power between 33 W and 60 W. IEEE 802.3bt is also known as PoE++ or PoE Plus Plus.</p> <p>802.3bt – the Switch supports the IEEE 802.3bt standard and can supply power of up to 60 W per Ethernet port to the connected PDs at power-up.</p>
Max Power (mW)	<p>Specify the maximum amount of power the PD could use from the Switch on this port. If you leave this field blank, the Switch refers to the standard or default maximum power for each class.</p> <p>Note: The setting you enter here will NOT take effect when the power-up mode is set to 802.3bt.</p>
LLDP Power Via MDI	<p>Select this to have the Switch negotiate PoE power with the PD connected to the port by transmitting LLDP Power Via MDI TLV frames. This helps the Switch allocate less power to the PD on this port. The connected PD must be able to request PoE power through LLDP.</p> <p>The Power Via MDI TLV allows PoE devices to advertise and discover the MDI power support capabilities of the sending port on the remote device.</p> <ul style="list-style-type: none"> • Port Class • MDI Supported • MDI Enabled • Pair Controllable • PSE Power Pairs • Power Class

Table 133 PORT > PoE Setup > PoE Setup (continued)

LABEL	DESCRIPTION
Apply	Click Apply to save your changes to the Switch's run-time memory. The Switch loses these changes if it is turned off or loses power, so use the Save link on the top navigation panel to save your changes to the non-volatile memory when you are done configuring.
Cancel	Click Cancel to begin configuring this screen afresh.

38.3 PoE Time Range Setup

Use this screen to apply a schedule to the ports on the Switch. You must first configure a schedule in the **SYSTEM > Time Range** screen.

Figure 213 PORT > PoE Setup > PoE Time Range Setup (Standalone Mode)

Port	Time Range Profiles
1	-
2	-
3	-
4	-
5	-
6	-
7	-
8	-
9	-

Figure 214 PORT > PoE Setup > PoE Time Range Setup (Stacking Mode)

Port	Time Range Profiles
1/1	-
1/2	-
1/3	-
1/4	-
1/5	-
1/6	-
1/7	-
1/8	-

The following table describes the labels in this screen.

Table 134 PORT > PoE Setup > PoE Time Range Setup

LABEL	DESCRIPTION
SLOT	This field appears only in stacking mode. Click the drop-down list to choose the slot number of the Switch in a stack.
Port	The port number identifies the port you are configuring. In stacking mode, the first number represents the slot ID and the second one is the port number. Please note that the default stacking ports (the last two ports of your Switch) cannot be configured. They are reserved for stacking only.
Time Range Profiles	This field displays the name of the schedule which is applied to the port. PoE is enabled at the specified time or date.

Table 134 PORT > PoE Setup > PoE Time Range Setup (continued)

LABEL	DESCRIPTION
	Select an entry's check box to select a specific entry. Otherwise, select the check box in the table heading row to select all entries.
Add/Edit	Click Add/Edit to add a new rule or edit a selected one.
Delete	Check the rules that you want to remove and then click the Delete button.

38.3.1 Add/Edit PoE Time Range

To access this screen, click the **Add/Edit** button or select an entry from the list and click the **Add/Edit** button.

Figure 215 PORT > PoE Setup > PoE Time Range Setup > Add/Edit (Standalone Mode)

Figure 216 PORT > PoE Setup > PoE Time Range Setup > Add/Edit (Stacking Mode)

The following table describes the labels in this screen.

Table 135 PORT > PoE Setup > PoE Time Range Setup > Add/Edit

LABEL	DESCRIPTION
Port	The port number identifies the port you are configuring. In stacking mode, the first number represents the slot ID and the second one is the port number. Please note that the default stacking ports (the last two ports of your Switch) cannot be configured. They are reserved for stacking only.
Time Range	This field displays the name of the schedule that you have created using the SYSTEM > Time Range screen. Select a pre-defined schedule to control when the Switch enables PoE to provide power on the port. To select more than one schedule, press [SHIFT] and select the choices at the same time.
Apply	Click Apply to save your changes to the Switch's run-time memory. The Switch loses these changes if it is turned off or loses power, so use the Save link on the top navigation panel to save your changes to the non-volatile memory when you are done configuring.

Table 135 PORT > PoE Setup > PoE Time Range Setup > Add/Edit (continued)

LABEL	DESCRIPTION
Clear	Click Clear to clear the fields to the factory defaults.
Cancel	Click Cancel to not save the configuration you make and return to the last screen.

CHAPTER 39

Port Setup

39.1 Port Setup

Use this screen to configure Switch port settings. Click **PORT > Port Setup > Port Setup** in the navigation panel to display the configuration screen.

Figure 217 PORT > Port Setup (Standalone Mode)

Port	Active	Name	Speed / Duplex	Flow Control	802.1p Priority	BPDU Ctrl	Media Type
*	<input type="checkbox"/>		Auto	Disable	0	Peer	SFP+
1	<input checked="" type="checkbox"/>		Auto	Disable	0	Peer	SFP+
2	<input checked="" type="checkbox"/>		Auto	Disable	0	Peer	SFP+
3	<input checked="" type="checkbox"/>		Auto	Disable	0	Peer	SFP+
4	<input checked="" type="checkbox"/>		Auto	Disable	0	Peer	SFP+
5	<input checked="" type="checkbox"/>		Auto	Disable	0	Peer	SFP+
6	<input checked="" type="checkbox"/>		Auto	Disable	0	Peer	SFP+
7	<input checked="" type="checkbox"/>		Auto	Disable	0	Peer	SFP+

Figure 218 PORT > Port Setup (Stacking Mode)

Port	Active	Name	Speed / Duplex	Flow Control	802.1p Priority	BPDU Ctrl
1/*	<input type="checkbox"/>		Auto	Disable	0	Peer
1/1	<input checked="" type="checkbox"/>		Auto	Disable	0	Peer
1/2	<input checked="" type="checkbox"/>		Auto	Disable	0	Peer
1/3	<input checked="" type="checkbox"/>		Auto	Disable	0	Peer
1/4	<input checked="" type="checkbox"/>		Auto	Disable	0	Peer
1/5	<input checked="" type="checkbox"/>		Auto	Disable	0	Peer
1/6	<input checked="" type="checkbox"/>		Auto	Disable	0	Peer
1/7	<input checked="" type="checkbox"/>		Auto	Disable	0	Peer
1/8	<input checked="" type="checkbox"/>		Auto	Disable	0	Peer
1/9	<input checked="" type="checkbox"/>		Auto	Disable	0	Peer

The following table describes the labels in this screen.

Table 136 PORT > Port Setup > Port Setup

LABEL	DESCRIPTION
SLOT	This field appears only in Stacking mode. Click the drop-down list to choose the slot number of the Switch in a stack.
Port	This is the port index number. In Stacking mode, the first number represents the slot ID and the second one is the port number. Please note that the default stacking ports (the last four ports of your Switch) cannot be configured. They are reserved for stacking only.
*	<p>Settings in this row apply to all ports.</p> <p>Use this row only if you want to make some settings the same for all ports. Use this row first to set the common settings and then make adjustments on a port-by-port basis.</p> <p>Note: Changes in this row are copied to all the ports as soon as you make them.</p>
Active	Select this check box to enable a port. The factory default for all ports is enabled. A port must be enabled for data transmission to occur.
Name	<p>Type a descriptive name that identifies this port. You can enter up to 128 printable ASCII characters except [?], [], ['] or ["].</p> <p>Note: Due to space limitations, the port name may be truncated in some Web Configurator screens.</p>
Speed/Duplex	<p>Select the speed and the duplex mode of the Ethernet connection on this port.</p> <p>For an Ethernet port, the choices are Auto, 10-an (10M/auto-negotiation), 10M/Full Duplex, 100-an (100M/auto-negotiation), 100M/Full Duplex, 1G/Full Duplex, 2.5G/Full Duplex, 5G/Full Duplex, and 10G/Full Duplex (Gigabit connections only).</p> <p>For an SFP+ interface, the choices are Auto, Auto-1G, 1G/Full Duplex, and 10G/Full Duplex (Gigabit connections only).</p> <p>Selecting Auto-1G or Auto (auto-negotiation) allows one port to negotiate with a peer port automatically to obtain the connection speed and duplex mode that both ends support. When auto-negotiation is turned on, a port on the Switch negotiates with the peer automatically to determine the connection speed and duplex mode. If the peer port does not support auto-negotiation or turns off this feature, the Switch determines the connection speed by detecting the signal on the cable and using half duplex mode. When the Switch's auto-negotiation is turned off, a port uses the pre-configured speed and duplex mode when making a connection, thus requiring you to make sure that the settings of the peer port are the same in order to connect.</p>

Table 136 PORT > Port Setup > Port Setup (continued)

LABEL	DESCRIPTION
Flow Control	<p>A concentration of traffic on a port decreases port bandwidth and overflows buffer memory causing packet discards and frame losses. Flow Control is used to regulate transmission of signals to match the bandwidth of the receiving port.</p> <p>The Switch uses IEEE 802.3x flow control in full duplex mode and backpressure flow control in half duplex mode.</p> <p>IEEE 802.3x flow control is used in full duplex mode to send a pause signal to the sending port, causing it to temporarily stop sending signals when the receiving port memory buffers fill.</p> <p>Back Pressure flow control is typically used in half duplex mode to send a "collision" signal to the sending port (mimicking a state of packet collision) causing the sending port to temporarily stop sending signals and resend later.</p> <p>Select Tx Rx to allow the Switch port to send pause signal to the connected device, and for the connected device to send a pause signal to the Switch. The Switch will temporarily stop sending signals after receiving pause signal.</p> <p>Select Tx to allow the Switch port to send pause signal to the connected device.</p> <p>Select Rx to allow the connected device to send a pause signal to the Switch. The Switch will temporarily stop sending signals.</p> <p>Otherwise, select Disable.</p>
802.1p Priority	This priority value is added to incoming frames without a (802.1p) tag.
BPDU Ctrl	<p>Configure the way to treat BPDUs received on this port. You must activate Bridging Control Protocol Transparency in the SYSTEM > Switch Setup screen first.</p> <p>Select Peer to process any BPDU (Bridge Protocol Data Units) received on this port.</p> <p>Select Tunnel to forward BPDUs received on this port.</p> <p>Select Discard to drop any BPDU received on this port.</p> <p>Select Network to process a BPDU with no VLAN tag and forward a tagged BPDU.</p>
Media Type	<p>You can insert either an SFP+ transceiver or an SFP+ Direct Attach Copper (DAC) cable into the 10 Gigabit interface of the Switch.</p> <p>Select the media type (SFP+ or DAC10G) of the SFP+ module that is attached to the 10 Gigabit interface.</p>
Apply	Click Apply to save your changes to the Switch's run-time memory. The Switch loses these changes if it is turned off or loses power, so use the Save link on the top navigation panel to save your changes to the non-volatile memory when you are done configuring.
Cancel	Click Cancel to begin configuring this screen afresh.

CHAPTER 40

ZULD

40.1 ZULD Overview

A unidirectional link is a connection where the link is up on both ends, but only one end can receive packets. This may happen if OAM was initially enabled but then disabled, there are mis-configured transmitting or receiving lines or the hardware is malfunctioning. Zyxel Unidirectional Link Detection (**ZULD**) is a layer-2 protocol that can detect and disable these physical one-way links before they cause loops or communication malfunction.

In the figure below, S1–A is a bidirectional link as both ends can send packets to each other. S1–B is unidirectional as B cannot send packets to S1 (although the S1–B link is up). Similarly, S2–S1 is unidirectional as S1 cannot send packets to S2 (although the S1–S2 link is up).

Figure 219 ZULD Overview

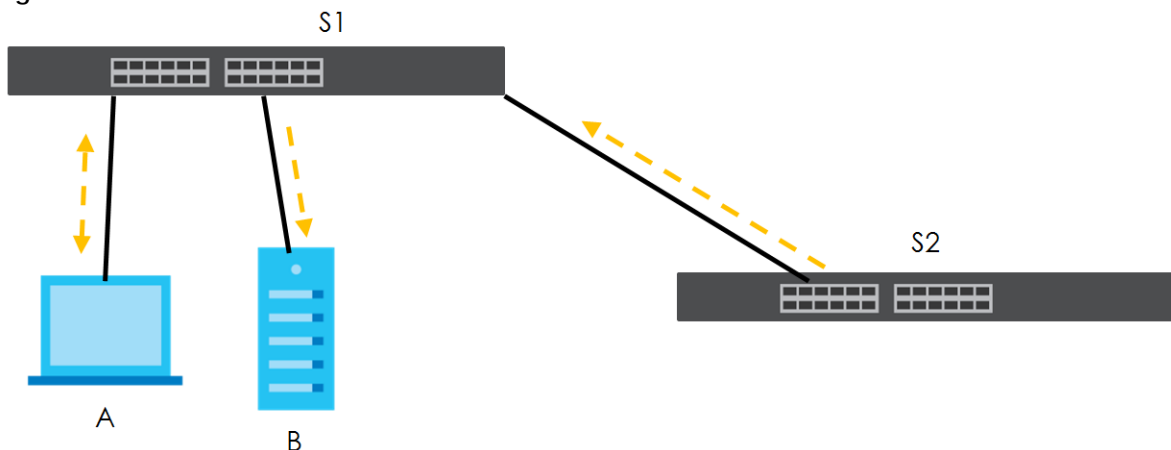

40.1.1 What You Can Do

- Use the **ZULD Status** screen ([Section 40.2 on page 295](#)) to see details on ZULD.
- Use the **ZULD Setup** screen ([Section 40.3 on page 297](#)) to enable ZULD on a port, configure a mode and set the probe time.

40.1.2 What You Need to Know

- ZULD must be enabled on the Switch and the ports in order to detect unidirectional links by monitoring OAMPDUs.
- Ports advertise their unidirectional link detection capability using OAMPDUs, so all connected devices must support **OAM** as well as **ZULD**. You need to enable OAM on the Switch by going to **PORT > OAM > OAM Setup** and enable the switch in the **Active** field. OAM must be enabled on other connected

- devices too. If OAM is not enabled initially, **ZULD** will not work.
- If OAM is enabled initially and later disabled on one end of a link, the link will be unidirectional as that end cannot send OAMPDUs.
 - OAM discovery, the sending of OAMPDUs to other ports, is initiated by an active port.
 - When **ZULD** detects a unidirectional link, it sends a syslog and SNMP trap and may shut down the affected port (**Aggressive Mode**).
 - If a port on the Switch is shut down by **ZULD**, and you want to recover it, then do one of the following:
 - Go to **PORT > Port Setup**. Clear **Active** and click **Apply**. Then select **Active** and click **Apply** again.
 - Go to **SECURITY > Errdisable > Errdisable Recovery** and set the interval for **ZULD**. After the interval expires, the closed ports will become active and start receiving packets again.
 - Use the command `port no inactive`.
 - Refer to the ZULD logs to see when a unidirectional link is detected and when it is recovered to a bidirectional link.

40.2 ZULD Status

Use this screen to see details of unidirectional and bidirectional links discovered by **ZULD**. To open this screen, click **PORT > ZULD > ZULD Status**.

Figure 220 PORT > ZULD > ZULD Status (Standalone Mode)

Port	Active	Mode	Probe Time	Link State	Remote Operation	Remote MAC Addr	Remote Port
1	OFF	Normal					
2	OFF	Normal					
3	OFF	Normal					
4	OFF	Normal					
5	OFF	Normal					
6	OFF	Normal					
7	OFF	Normal					

Figure 221 PORT > ZULD > ZULD Status (Stacking Mode)

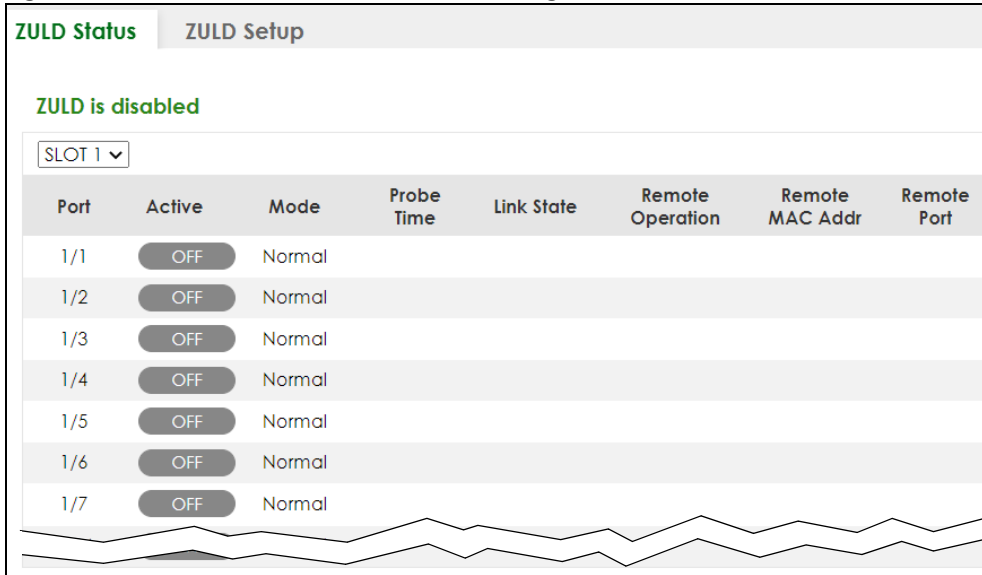

The following table describes the fields in the above screen.

Table 137 PORT > ZULD > ZULD Status

LABEL	DESCRIPTION
ZULD is...	This shows whether ZULD is enabled or disabled on the Switch.
SLOT	This field appears only in Stacking mode. Click the drop-down list to choose the slot number of the Switch in a stack.
Port	This field displays the port number. In Stacking mode, the first number represents the slot ID and the second is the port number. Please note that the default stacking ports (the last four ports of your Switch) cannot be configured. They are reserved for stacking only.
Active	This field displays whether ZULD is enabled on the port or not. ZULD must be enabled to detect an unidirectional link by monitoring OAMPDUs.
Mode	This field indicates what ZULD will do when a unidirectional link is detected. In Normal mode, ZULD only sends a syslog and trap when it detects a unidirectional link. In Aggressive mode, ZULD shuts down the port (puts it into an ErrDisable state) as well as sends a syslog and trap when it detects a unidirectional link.
Probe Time	Probe time is the length of time that ZULD waits before declaring that a link is unidirectional. When the probe time expires, and one port (either on the Switch or the connected device) still has not received an OAMPDU, then ZULD declares that the link is unidirectional.
Link State	This field shows the following link states: <ul style="list-style-type: none"> • Linkdown: This is an initialization state, where the port is not yet up. • Probe: This indicates that ZULD is discovering the connected device on this link. • Bidirectional: Traffic sent by the Switch is received by the connected device on this link, and traffic from the connected device on this link is received by the Switch. • Unidirectional: The state of the link between the port and its connected port cannot be determined either because no ZULD message was received, or one port is not capable of sending traffic. • Shutdown: The port has been shut down because its link with the connected device is unidirectional and ZULD is in Aggressive mode.
Remote Operation	This field displays whether ZULD is enabled or disabled on the connected device on this link. ZULD must be enabled on the connected device and on the port that is connecting to the Switch.

Table 137 PORT > ZULD > ZULD Status (continued)

LABEL	DESCRIPTION
Remote MAC Addr	This is the MAC address of the port on the connected device to which the port of the Switch is connected.
Remote Port	This is the port number of the port on the connected device to which the port of the Switch is connected.

40.3 ZULD Setup

Use this screen to enable ZULD on a port, configure a mode and set the probe time. To open this screen, click **PORT > ZULD > ZULD Setup**.

Figure 222 PORT > ZULD > ZULD Setup (Standalone Mode)

ZULD Status **ZULD Setup**

Active OFF

Port	Active	Mode	Probe Time
*	<input type="checkbox"/>	Normal ▼	<input type="text"/>
1	<input type="checkbox"/>	Normal ▼	5
2	<input type="checkbox"/>	Normal ▼	5
3	<input type="checkbox"/>	Normal ▼	5
4	<input type="checkbox"/>	Normal ▼	5
5	<input type="checkbox"/>	Normal ▼	5
6	<input type="checkbox"/>	Normal ▼	5
7	<input type="checkbox"/>	Normal ▼	5

Apply Cancel

Figure 223 PORT > ZULD > ZULD Setup (Stacking Mode)

Port	Active	Mode	Probe Time
1/*	<input type="checkbox"/>	Normal	
1/1	<input type="checkbox"/>	Normal	5
1/2	<input type="checkbox"/>	Normal	5
1/3	<input type="checkbox"/>	Normal	5
1/4	<input type="checkbox"/>	Normal	5
1/5	<input type="checkbox"/>	Normal	5
1/6	<input type="checkbox"/>	Normal	5
1/7	<input type="checkbox"/>	Normal	5

The following table describes the fields in the above screen.

Table 138 PORT > ZULD > ZULD Setup

LABEL	DESCRIPTION
Active	Enable the switch button to enable ZULD on the Switch.
SLOT	This field appears only in Stacking mode. Click the drop-down list to choose the slot number of the Switch in a stack.
Port	This field displays the port number. In Stacking mode, the first number represents the slot ID and the second is the port number. Please note that the default stacking ports (the last four ports of your Switch) cannot be configured. They are reserved for stacking only.
*	Settings in this row apply to all ports. Use this row only if you want to make some settings the same for all ports. Use this row first to set the common settings and then make adjustments on a port-by-port basis. Note: Changes in this row are copied to all the ports as soon as you make them.
Active	Select this to enable ZULD on the port. ZULD must be enabled to detect a unidirectional link by monitoring OAMPDUs.
Mode	Select Normal or Aggressive . In Normal mode, ZULD only sends a syslog and trap when it detects a unidirectional link. In Aggressive mode, ZULD shuts down the port (puts it into an ErrDisable state) as well as sends a syslog and trap when it detects a unidirectional link.
Probe Time	Type the length of time that ZULD waits before declaring that a link is unidirectional. When the probe time expires, and one port (either on the Switch or the connected device) still has not received an OAMPDU, then ZULD declares that the link is unidirectional. The allowed time range is from 5 – 65535 seconds.

Table 138 PORT > ZULD > ZULD Setup (continued)

LABEL	DESCRIPTION
Apply	Click Apply to save your changes to the Switch's run-time memory. The Switch loses these changes if it is turned off or loses power, so use the Save link on the top navigation panel to save your changes to the non-volatile memory when you are done configuring.
Cancel	Click this to reset the values in this screen to their last-saved values.

CHAPTER 41

SWITCHING

The following chapters introduces the configurations of the links under the **SWITCHING** navigation panel.

Quick links to chapters:

- [Layer 2 Protocol Tunneling](#)
- [Loop Guard](#)
- [MAC Pinning](#)
- [Mirroring](#)
- [Multicast](#)
- [Static Multicast Forwarding](#)
- [PPPoE](#)
- [Differentiated Services](#)
- [Queuing Method](#)
- [Priority Queue](#)
- [Bandwidth Control](#)
- [sFlow](#)
- [Spanning Tree Protocol](#)
- [Static MAC Filtering](#)
- [Static MAC Forwarding](#)
- [VLAN Isolation](#)
- [VLAN Mapping](#)
- [VLAN Stacking](#)

CHAPTER 42

Layer 2 Protocol Tunneling

42.1 Layer 2 Protocol Tunneling Overview

This chapter shows you how to configure layer 2 protocol tunneling on the Switch.

42.1.1 What You Can Do

Use the **Layer 2 Protocol Tunneling** screen ([Section 42.2 on page 302](#)) to enable layer 2 protocol tunneling on the Switch and specify a MAC address with which the Switch uses to encapsulate the layer 2 protocol packets by replacing the destination MAC address in the packets.

42.1.2 What You Need to Know

Layer 2 protocol tunneling (L2PT) is used on the service provider's edge devices.

L2PT allows edge switches (**1** and **2** in the following figure) to tunnel layer 2 STP (Spanning Tree Protocol), CDP (Cisco Discovery Protocol) and VTP (VLAN Trunking Protocol) packets between customer switches (**A**, **B** and **C** in the following figure) connected through the service provider's network. The edge switch encapsulates layer 2 protocol packets with a specific MAC address before sending them across the service provider's network to other edge switches.

Figure 224 Layer 2 Protocol Tunneling Network Scenario

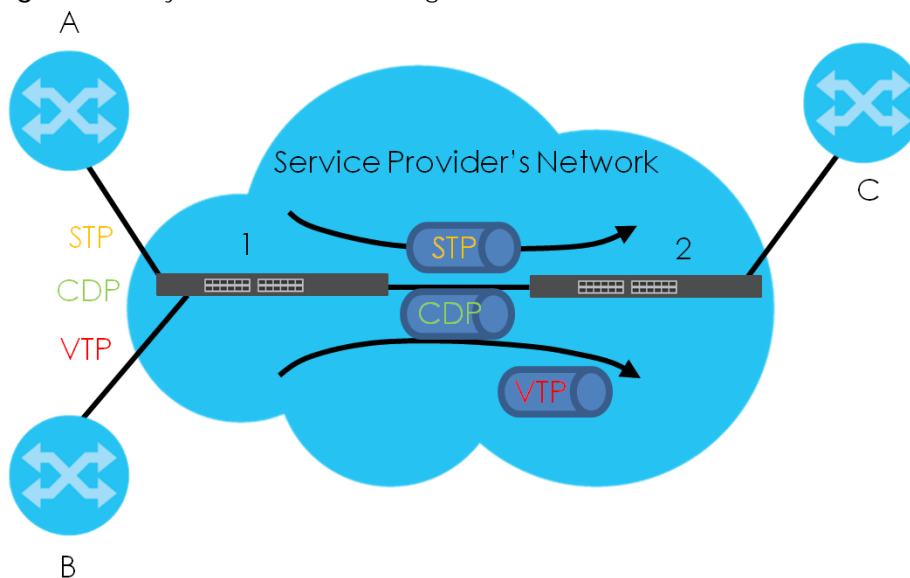

In the following example, if you enable L2PT for STP, you can have switches **A**, **B**, **C** and **D** in the same

spanning tree, even though switch **A** is not directly connected to switches **B**, **C** and **D**. Topology change information can be propagated throughout the service provider's network.

To emulate a point-to-point topology between two customer switches at different sites, such as **A** and **B**, you can enable protocol tunneling on edge switches **1** and **2** for PAgP (Port Aggregation Protocol), LACP or UDLD (Uni-Directional Link Detection).

Figure 225 L2PT Network Example

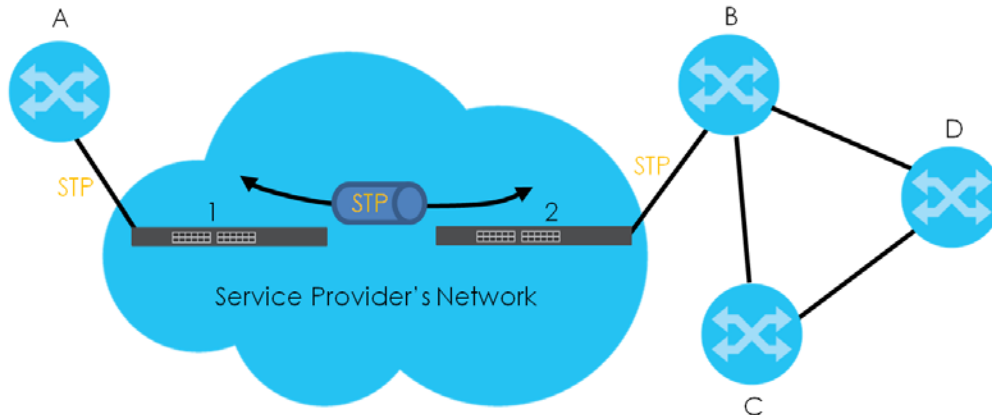

42.1.2.1 Layer 2 Protocol Tunneling Mode

Each port can have two layer 2 protocol tunneling modes, **Access** and **Tunnel**.

- The **Access** port is an ingress port on the service provider's edge device (1 or 2 in [Figure 225 on page 302](#)) and connected to a customer switch (**A** or **B**). Incoming layer 2 protocol packets received on an access port are encapsulated and forwarded to the tunnel ports.
- The **Tunnel** port is an egress port at the edge of the service provider's network and connected to another service provider's switch. Incoming encapsulated layer 2 protocol packets received on a tunnel port are decapsulated and sent to an access port.

42.2 Configuring Layer 2 Protocol Tunneling

Click **SWITCHING** > **Layer 2 Protocol Tunneling** in the navigation panel to display the screen as shown.

Figure 226 SWITCHING > Layer 2 Protocol Tunneling (Standalone Mode)

Layer 2 Protocol Tunneling

Active

Destination MAC Address

Port	CDP	STP	VTP	LLDP	PAGP	Point to Point		Mode
						LACP	UDLD	
*	<input type="checkbox"/>	<input type="checkbox"/>	<input type="checkbox"/>	<input type="checkbox"/>	<input type="checkbox"/>	<input type="checkbox"/>	<input type="checkbox"/>	Access ▾
1	<input type="checkbox"/>	<input type="checkbox"/>	<input type="checkbox"/>	<input type="checkbox"/>	<input type="checkbox"/>	<input type="checkbox"/>	<input type="checkbox"/>	Access ▾
2	<input type="checkbox"/>	<input type="checkbox"/>	<input type="checkbox"/>	<input type="checkbox"/>	<input type="checkbox"/>	<input type="checkbox"/>	<input type="checkbox"/>	Access ▾
3	<input type="checkbox"/>	<input type="checkbox"/>	<input type="checkbox"/>	<input type="checkbox"/>	<input type="checkbox"/>	<input type="checkbox"/>	<input type="checkbox"/>	Access ▾
4	<input type="checkbox"/>	<input type="checkbox"/>	<input type="checkbox"/>	<input type="checkbox"/>	<input type="checkbox"/>	<input type="checkbox"/>	<input type="checkbox"/>	Access ▾
5	<input type="checkbox"/>	<input type="checkbox"/>	<input type="checkbox"/>	<input type="checkbox"/>	<input type="checkbox"/>	<input type="checkbox"/>	<input type="checkbox"/>	Access ▾
6	<input type="checkbox"/>	<input type="checkbox"/>	<input type="checkbox"/>	<input type="checkbox"/>	<input type="checkbox"/>	<input type="checkbox"/>	<input type="checkbox"/>	Access ▾
7	<input type="checkbox"/>	<input type="checkbox"/>	<input type="checkbox"/>	<input type="checkbox"/>	<input type="checkbox"/>	<input type="checkbox"/>	<input type="checkbox"/>	Access ▾

Figure 227 SWITCHING > Layer 2 Protocol Tunneling (Stacking Mode)

Layer 2 Protocol Tunneling

Active

Destination MAC Address

SLOT 1 ▾

Port	CDP	STP	VTP	LLDP	PAGP	Point to Point		Mode
						LACP	UDLD	
1/*	<input type="checkbox"/>	<input type="checkbox"/>	<input type="checkbox"/>	<input type="checkbox"/>	<input type="checkbox"/>	<input type="checkbox"/>	<input type="checkbox"/>	Access ▾
1/1	<input type="checkbox"/>	<input type="checkbox"/>	<input type="checkbox"/>	<input type="checkbox"/>	<input type="checkbox"/>	<input type="checkbox"/>	<input type="checkbox"/>	Access ▾
1/2	<input type="checkbox"/>	<input type="checkbox"/>	<input type="checkbox"/>	<input type="checkbox"/>	<input type="checkbox"/>	<input type="checkbox"/>	<input type="checkbox"/>	Access ▾
1/3	<input type="checkbox"/>	<input type="checkbox"/>	<input type="checkbox"/>	<input type="checkbox"/>	<input type="checkbox"/>	<input type="checkbox"/>	<input type="checkbox"/>	Access ▾
1/4	<input type="checkbox"/>	<input type="checkbox"/>	<input type="checkbox"/>	<input type="checkbox"/>	<input type="checkbox"/>	<input type="checkbox"/>	<input type="checkbox"/>	Access ▾
1/5	<input type="checkbox"/>	<input type="checkbox"/>	<input type="checkbox"/>	<input type="checkbox"/>	<input type="checkbox"/>	<input type="checkbox"/>	<input type="checkbox"/>	Access ▾
1/6	<input type="checkbox"/>	<input type="checkbox"/>	<input type="checkbox"/>	<input type="checkbox"/>	<input type="checkbox"/>	<input type="checkbox"/>	<input type="checkbox"/>	Access ▾
1/7	<input type="checkbox"/>	<input type="checkbox"/>	<input type="checkbox"/>	<input type="checkbox"/>	<input type="checkbox"/>	<input type="checkbox"/>	<input type="checkbox"/>	Access ▾

The following table describes the labels in this screen.

Table 139 SWITCHING > Layer 2 Protocol Tunneling

LABEL	DESCRIPTION
Active	Enable the switch button to enable layer 2 protocol tunneling on the Switch.
Destination MAC Address	<p>Specify a MAC address with which the Switch uses to encapsulate the layer 2 protocol packets by replacing the destination MAC address in the packets.</p> <p>Note: The MAC address can be either a unicast MAC address or multicast MAC address. If you use a unicast MAC address, make sure the MAC address does not exist in the address table of a switch on the service provider's network.</p> <p>Note: All the edge switches in the service provider's network should be set to use the same MAC address for encapsulation.</p>
SLOT	This field appears only in Stacking mode. Click the drop-down list to choose the slot number of the Switch in a stack.
Port	This field displays the port number. In Stacking mode, the first number represents the slot ID and the second is the port number. Please note that the default stacking ports (the last four ports of your Switch) cannot be configured. They are reserved for stacking only.
*	<p>Use this row to make the setting the same for all ports. Use this row first and then make adjustments on a port-by-port basis.</p> <p>Note: Changes in this row are copied to all the ports as soon as you make them.</p>
CDP	Select this option to have the Switch tunnel CDP (Cisco Discovery Protocol) packets so that other Cisco devices can be discovered through the service provider's network.
STP	Select this option to have the Switch tunnel STP (Spanning Tree Protocol) packets so that STP can run properly across the service provider's network and spanning trees can be set up based on bridge information from all (local and remote) networks.
VTP	Select this option to have the Switch tunnel VTP (VLAN Trunking Protocol) packets so that all customer switches can use consistent VLAN configuration through the service provider's network.
LLDP	Select this option to have the Switch tunnel LLDP (Link Layer Discovery Protocol) packets so that all network devices can advertise its identity and capabilities through the service provider's network.
Point to Point	<p>The Switch supports PAGP (Port Aggregation Protocol), LACP (Link Aggregation Control Protocol) and UDLD (UniDirectional Link Detection) tunneling for a point-to-point topology.</p> <p>Both PAGP and UDLD are Cisco's proprietary data link layer protocols. PAGP is similar to LACP and used to set up a logical aggregation of Ethernet ports automatically. UDLD is to determine the link's physical status and detect a unidirectional link.</p>
PAGP	Select this option to have the Switch send PAGP packets to a peer to automatically negotiate and build a logical port aggregation.
LACP	Select this option to have the Switch send LACP packets to a peer to dynamically create and manage trunk groups.
UDLD	Select this option to have the Switch send UDLD packets to a peer's port it connected to monitor the physical status of a link.

Table 139 SWITCHING > Layer 2 Protocol Tunneling (continued)

LABEL	DESCRIPTION
Mode	<p>Select Access to have the Switch encapsulate the incoming layer 2 protocol packets and forward them to the tunnel ports. Select Access for ingress ports at the edge of the service provider's network.</p> <p>Note: You can enable L2PT services for STP, LACP, VTP, CDP, UDLD, PAgP, and LLDP on the access ports only.</p> <p>Select Tunnel for egress ports at the edge of the service provider's network. The Switch decapsulates the encapsulated layer 2 protocol packets received on a tunnel port by changing the destination MAC address to the original one, and then forward them to an access port. If the services is not enabled on an access port, the protocol packets are dropped.</p>
Apply	Click Apply to save your changes to the Switch's run-time memory. The Switch loses these changes if it is turned off or loses power, so use the Save link on the top navigation panel to save your changes to the non-volatile memory when you are done configuring.
Cancel	Click Cancel to begin configuring this screen afresh.

CHAPTER 43

Loop Guard

43.1 Loop Guard Overview

This chapter shows you how to configure the Switch to guard against loops on the edge of your network.

Loop guard allows you to configure the Switch to shut down a port if it detects that packets sent out on that port loop back to the Switch. While you can use Spanning Tree Protocol (STP) to prevent loops in the core of your network, STP cannot prevent loops that occur on the edge of your network.

Figure 228 Loop Guard vs. STP

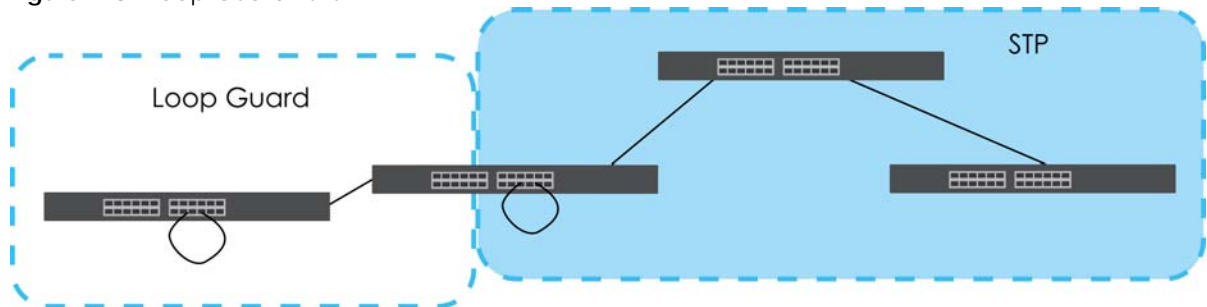

Refer to [Section 43.1.2 on page 306](#) for more information.

43.1.1 What You Can Do

Use the **Loop Guard** screen ([Section 43.2 on page 308](#)) to enable loop guard on the Switch and in specific ports.

43.1.2 What You Need to Know

Loop guard is designed to handle loop problems on the edge of your network. This can occur when a port is connected to a Switch that is in a loop state. Loop state occurs as a result of human error. It happens when two ports on a switch are connected with the same cable. When a switch in loop state sends out broadcast messages the messages loop back to the switch and are re-broadcast again and again causing a broadcast storm.

If a switch (not in loop state) connects to a switch in loop state, then it will be affected by the switch in loop state in the following way:

- The switch (not in loop state) will receive broadcast messages sent out from the switch in loop state.
- The switch (not in loop state) will receive its own broadcast messages that it sends out as they loop back. It will then re-broadcast those messages again.

The following figure shows port **N** on switch **A** connected to switch **B**. Switch **B** has two ports, **x** and **y**, mistakenly connected to each other. It forms a loop. When broadcast or multicast packets leave port **N** and reach switch **B**, they are sent back to port **N** on **A** as they are rebroadcast from **B**.

Figure 229 Switch in Loop State

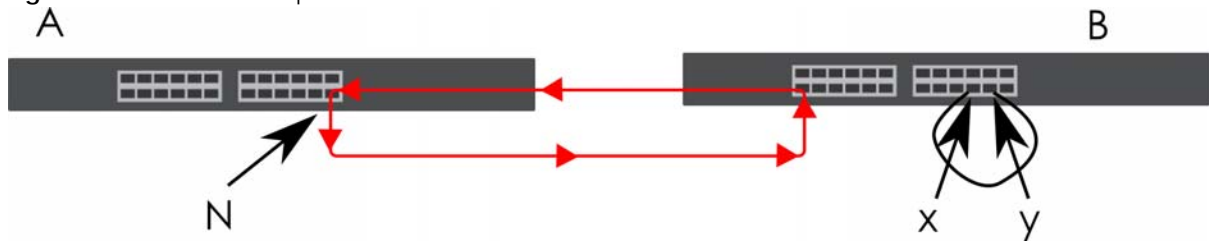

The loop guard feature checks to see if a loop guard enabled port is connected to a Switch in loop state. This is accomplished by periodically sending a probe packet and seeing if the packet returns on the same port. If this is the case, the Switch will shut down the port connected to the switch in loop state.

Loop guard can be enabled on both Ethernet ports. The following figure shows a loop guard enabled port **N** on switch **A** sending a probe packet **P** to switch **B**. Since switch **B** is in loop state, the probe packet **P** returns to port **N** on **A**. The Switch then shuts down port **N** to ensure that the rest of the network is not affected by the switch in loop state.

Figure 230 Loop Guard – Probe Packet

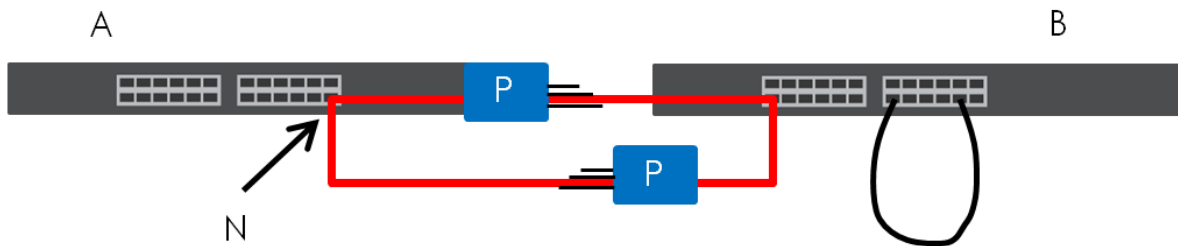

The Switch also shuts down port **N** if the probe packet returns to switch **A** on any other port. In other words loop guard also protects against standard network loops.

The following figure illustrates three switches forming a loop. A sample path of the loop guard probe packet is also shown. In this example, the probe packet is sent from port **N** and returns on another port. As long as loop guard is enabled on port **N**. The Switch will shut down port **N** if it detects that the probe packet has returned to the Switch.

Figure 231 Loop Guard – Network Loop

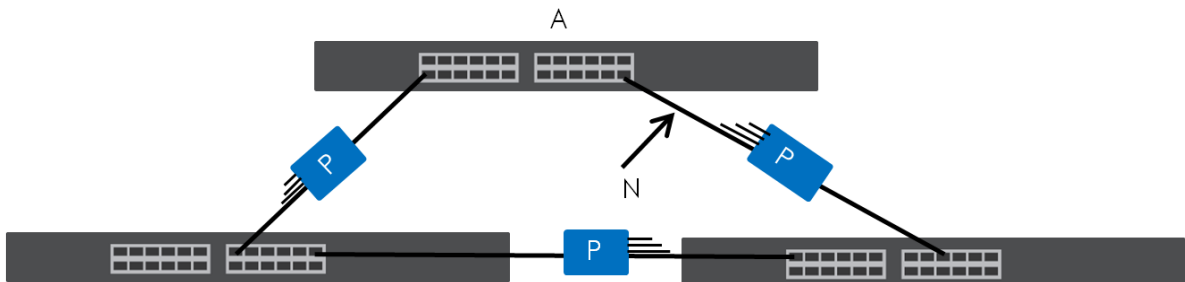

Note: After resolving the loop problem on your network you can re-activate the disabled port through the Web Configurator or through commands (See the CLI Reference Guide).

43.2 Loop Guard Setup

Click **SWITCHING** > **Loop Guard** in the navigation panel to display the screen as shown.

Note: The loop guard feature cannot be enabled on the ports that have Spanning Tree Protocol (RSTP, MRSTP or MSTP) enabled.

Figure 232 SWITCHING > Loop Guard (Standalone Mode)

Loop Guard

Active OFF

Port	Active
*	<input type="checkbox"/>
1	<input type="checkbox"/>
2	<input type="checkbox"/>
3	<input type="checkbox"/>
4	<input type="checkbox"/>
5	<input type="checkbox"/>
6	<input type="checkbox"/>
7	<input type="checkbox"/>

Apply Cancel

Figure 233 SWITCHING > Loop Guard (Stacking Mode)

Loop Guard

Active OFF

SLOT 1 ▾

Port	Active
1/*	<input type="checkbox"/>
1/1	<input type="checkbox"/>
1/2	<input type="checkbox"/>
1/3	<input type="checkbox"/>
1/4	<input type="checkbox"/>
1/5	<input type="checkbox"/>
1/6	<input type="checkbox"/>
1/7	<input type="checkbox"/>

Apply Cancel

The following table describes the labels in this screen.

Table 140 SWITCHING > Loop Guard

LABEL	DESCRIPTION
Active	<p>Enable the switch button to activate loop guard function on the Switch.</p> <p>The Switch generates syslog, internal log messages as well as SNMP traps when it shuts down a port through the loop guard feature.</p>
SLOT	<p>This field appears only in Stacking mode. Click the drop-down list to choose the slot number of the Switch in a stack.</p>
Port	<p>This field displays the port number. In Stacking mode, the first number represents the slot ID and the second is the port number. Please note that the default stacking ports (the last four ports of your Switch) cannot be configured. They are reserved for stacking only.</p>
*	<p>Settings in this row apply to all ports.</p> <p>Use this row only if you want to make some settings the same for all ports. Use this row first to set the common settings and then make adjustments on a port-by-port basis.</p> <p>Note: Changes in this row are copied to all the ports as soon as you make them.</p>
Active	<p>Select this check box to enable the loop guard feature on this port. The Switch sends broadcast and multicast probe packets from this port to check if the switch it is connected to is in loop state. If the switch that this port is connected is in loop state the Switch will shut down this port.</p> <p>Clear this check box to disable the loop guard feature.</p>
Apply	<p>Click Apply to save your changes to the Switch's run-time memory. The Switch loses these changes if it is turned off or loses power, so use the Save link on the top navigation panel to save your changes to the non-volatile memory when you are done configuring.</p>
Cancel	<p>Click Cancel to begin configuring this screen afresh.</p>

CHAPTER 44

MAC Pinning

This chapter shows you how to configure MAC pinning on the Switch.

44.1 MAC Pinning Overview

When the Switch obtains a connected device's MAC address, it adds an entry in the MAC address forwarding table and uses the table to determine how to forward frames. In addition to the source MAC address of a received frame, the Switch also learns the VLAN to which the device belongs and the port on which the frame is received. If the Switch learns the same MAC address and same VLAN ID on another port, it updates the MAC address table immediately.

MAC pinning allows you to set a port or multiple ports to have priority over other ports in MAC address learning. That means when a MAC address (and VLAN ID) is learned on a MAC-pinning-enabled port, the MAC address will not be learned on any other port until the aging time for the dynamically learned MAC address in the table expires.

This helps enhance security. For example, when an attacker (A) sends packets to all connected clients by spoofing the source MAC address of a server (B) connected to one of the Switch's ports, on which MAC pinning is enabled, the responses from clients will still be forwarded to the server according to the Switch's MAC forwarding table.

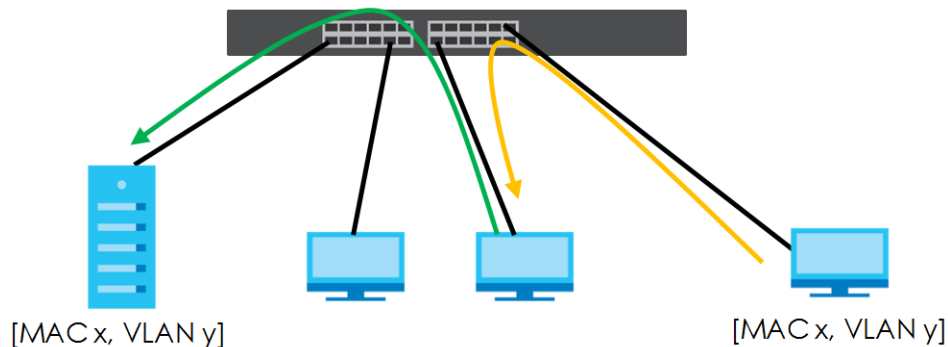

44.2 MAC Pinning Configuration

Use this screen to enable MAC pinning on the Switch and on specific ports. Click **SWITCHING > MAC Pinning** in the navigation panel to open the following screen.

Figure 234 SWITCHING > MAC Pinning (Standalone Mode)

MAC Pinning

Active OFF

Port	Active
*	<input type="checkbox"/>
1	<input type="checkbox"/>
2	<input type="checkbox"/>
3	<input type="checkbox"/>
4	<input type="checkbox"/>
5	<input type="checkbox"/>
6	<input type="checkbox"/>
7	<input type="checkbox"/>

Apply Cancel

Figure 235 SWITCHING > MAC Pinning (Stacking Mode)

MAC Pinning

Active OFF

SLOT 1

Port	Active
1/*	<input type="checkbox"/>
1/1	<input type="checkbox"/>
1/2	<input type="checkbox"/>
1/3	<input type="checkbox"/>
1/4	<input type="checkbox"/>
1/5	<input type="checkbox"/>
1/6	<input type="checkbox"/>
1/7	<input type="checkbox"/>

Apply Cancel

The following table describes the labels in this screen.

Table 141 SWITCHING > MAC Pinning

LABEL	DESCRIPTION
Active	Enable the switch button to turn on the MAC pinning function on the Switch.
SLOT	This field appears only in Stacking mode. Click the drop-down list to choose the slot number of the Switch in a stack.

Table 141 SWITCHING > MAC Pinning (continued)

LABEL	DESCRIPTION
Port	This field displays the port number. In Stacking mode, the first number represents the slot ID and the second is the port number. Please note that the default stacking ports (the last four ports of your Switch) cannot be configured. They are reserved for stacking only.
*	<p>Settings in this row apply to all ports.</p> <p>Use this row only if you want to make some settings the same for all ports. Use this row first to set the common settings and then make adjustments on a port-by-port basis.</p> <p>Note: Changes in this row are copied to all the ports as soon as you make them.</p>
Active	<p>Select this check box to enable MAC pinning on this port. The port then has priority over other ports in MAC address learning.</p> <p>Clear this check box to disable MAC pinning.</p>
Apply	Click Apply to save your changes to the Switch's run-time memory. The Switch loses these changes if it is turned off or loses power, so use the Save link on the top navigation panel to save your changes to the non-volatile memory when you are done configuring.
Cancel	Click Cancel to begin configuring this screen afresh.

CHAPTER 45

Mirroring

45.1 Mirroring Overview

This chapter discusses port mirroring setup screens.

Port mirroring allows you to copy a traffic flow to a monitor port (the port you copy the traffic to) in order that you can examine the traffic from the monitor port without interference.

45.2 Local Port Mirroring

Click **SWITCHING > Mirroring > Mirroring** in the navigation panel to display the **Mirroring** screen. Use this screen to select a monitor port and specify the traffic flow to be copied to the monitor port.

Figure 236 SWITCHING > Mirroring > Mirroring (Standalone Mode)

Mirroring

Active OFF

Monitor Port

Port	Mirrored	Direction
*	<input type="checkbox"/>	ingress ▼
1	<input type="checkbox"/>	ingress ▼
2	<input type="checkbox"/>	ingress ▼
3	<input type="checkbox"/>	ingress ▼
4	<input type="checkbox"/>	ingress ▼
5	<input type="checkbox"/>	ingress ▼
6	<input type="checkbox"/>	ingress ▼
7	<input type="checkbox"/>	ingress ▼

Apply Cancel

Figure 237 SWITCHING > Mirroring > Mirroring (Stacking Mode)

Mirroring

Active OFF

Monitor Port 1 /

SLOT 1

Port	Mirrored	Direction
1/*	<input type="checkbox"/>	ingress
1/1	<input type="checkbox"/>	ingress
1/2	<input type="checkbox"/>	ingress
1/3	<input type="checkbox"/>	ingress
1/4	<input type="checkbox"/>	ingress
1/5	<input type="checkbox"/>	ingress
1/6	<input type="checkbox"/>	ingress
1/7	<input type="checkbox"/>	ingress

Apply Cancel

The following table describes the labels in this screen.

Table 142 SWITCHING > Mirroring > Mirroring

LABEL	DESCRIPTION
Active	Enable the switch button to activate port mirroring on the Switch. Disable the switch to disable the feature.
Monitor Port	The monitor port is the port you copy the traffic to in order to examine it in more detail without interfering with the traffic flow on the original ports. Type the port number of the monitor port. In Stacking mode, the first box field is the slot ID and the second field is the port number.
SLOT	This field appears only in Stacking mode. Click the drop-down list to choose the slot number of the Switch in a stack.
Port	This field displays the port number. In Stacking mode, the first number represents the slot ID and the second is the port number. Please note that the default stacking ports (the last four ports of your Switch) cannot be configured. They are reserved for stacking only.
*	Settings in this row apply to all ports. Use this row only if you want to make some settings the same for all ports. Use this row first to set the common settings and then make adjustments on a port-by-port basis. Note: Changes in this row are copied to all the ports as soon as you make them.
Mirrored	Select this option to mirror the traffic on a port.
Direction	Specify the direction of the traffic to mirror by selecting from the drop-down list box. Choices are Egress (outgoing), Ingress (incoming) and Both .
Apply	Click Apply to save your changes to the Switch's run-time memory. The Switch loses these changes if it is turned off or loses power, so use the Save link on the top navigation panel to save your changes to the non-volatile memory when you are done configuring.
Cancel	Click Cancel to reset the fields.

CHAPTER 46

Multicast

46.1 Multicast Overview

This chapter shows you how to configure various multicast features.

Traditionally, IP packets are transmitted in one of either two ways – Unicast (one sender to one recipient) or Broadcast (one sender to everybody on the network). Multicast delivers IP packets to just a group of hosts on the network.

IGMP (Internet Group Management Protocol) is a network-layer protocol used to establish membership in a multicast group – it is not used to carry user data. Refer to RFC 1112, RFC 2236 and RFC 3376 for information on IGMP versions 1, 2 and 3 respectively.

The Multicast Listener Discovery (MLD) protocol (defined in RFC 2710) is derived from IPv4's Internet Group Management Protocol version 2 (IGMPv2). MLD uses ICMPv6 message types, rather than IGMP message types. MLDv1 is similar to IGMPv2 and MLDv2 is similar to IGMPv3. MLD allows an IPv6 switch or router to discover the presence of MLD listeners who wish to receive multicast packets and the IP addresses of multicast groups the hosts want to join on its network.

MLD snooping and MLD proxy are analogous to IGMP snooping and IGMP proxy in IPv4. MLD filtering controls which multicast groups a port can join.

- Use the **IPv4 Multicast Status** screen ([Section 46.2 on page 319](#)) to view IPv4 multicast group information.
- Use the **IGMP Snooping** screen ([Section 46.3 on page 320](#)) to enable IGMP snooping to forward group multicast traffic only to ports that are members of that group.
- Use the **IGMP Snooping VLAN** screen ([Section 46.4 on page 324](#)) to perform IGMP snooping on VLANs.
- Use the **IGMP Filtering Profile** ([Section 46.5 on page 326](#)) to specify a range of multicast groups that clients connected to the Switch are able to join.

46.1.1 What You Can Do – IPv6 Multicast

- Use the **IPv6 Multicast Status** screen ([Section 46.6 on page 328](#)) to view IPv6 multicast group information.
- Use the **MLD Snooping-proxy** screen ([Section 46.7 on page 329](#)) to enable the upstream port to report group changes to a connected multicast router and forward MLD messages to other upstream ports.
- Use the **MLD Snooping-proxy VLAN** screen ([Section 46.8 on page 329](#)) to enable and configure MLD snooping-proxy settings on the VLANs you specified.
- Use the **MLD Snooping-proxy Port Role Setting** screen ([Section 46.9 on page 332](#)) to assign MLD snooping-proxy port roles and configure Leave settings for each port.
- Use the **MLD Snooping-proxy Filtering** screen ([Section 46.10 on page 334](#)) to enable and configure MLD snooping-proxy filtering.

- Use the **MLD Snooping-proxy Filtering Profile** screen ([Section 46.11 on page 336](#)) to create/edit MLD snooping-proxy filtering profiles.

46.1.2 What You Can Do – MVR

- Use the **MVR** screen ([Section 46.12 on page 338](#)) to create multicast VLANs and select the receiver ports and a source port for each multicast VLAN.
- Use the **Group Setup** screen ([Section 46.12 on page 338](#)) to configure MVR IP multicast group addresses.

46.1.3 What You Need to Know

Read on for concepts on Multicasting that can help you configure the screens in this chapter.

IP Multicast Addresses

In IPv4, a multicast address allows a device to send packets to a specific group of hosts (multicast group) in a different subnetwork. A multicast IP address represents a traffic receiving group, not individual receiving devices. IP addresses in the Class D range (224.0.0.0 to 239.255.255.255) are used for IP multicasting. Certain IP multicast numbers are reserved by IANA for special purposes (see the IANA website for more information).

In IPv6, multicast addresses provide the same functionality as IPv4 broadcast addresses. Broadcasting is not supported in IPv6. A multicast address allows a host to send packets to all hosts in a multicast group. Multicast scope allows you to determine the size of the multicast group. A multicast address has a predefined prefix of ff00::/8.

IGMP Filtering

With the IGMP filtering feature, you can control which IGMP groups a subscriber on a port can join. This allows you to control the distribution of multicast services (such as content information distribution) based on service plans and types of subscription.

You can set the Switch to filter the multicast group join reports on a per-port basis by configuring an IGMP filtering profile and associating the profile to a port.

IGMP Snooping

A Switch can passively snoop on IGMP packets transferred between IP multicast routers or switches and IP multicast hosts to learn the IP multicast group membership. It checks IGMP packets passing through it, picks out the group registration information, and configures multicasting accordingly. IGMP snooping allows the Switch to learn multicast groups without you having to manually configure them.

The Switch forwards multicast traffic destined for multicast groups (that it has learned from IGMP snooping or that you have manually configured) to ports that are members of that group. IGMP snooping generates no additional network traffic, allowing you to significantly reduce multicast traffic passing through your Switch.

IGMP Snooping and VLANs

The Switch can perform IGMP snooping on up to 16 VLANs. You can configure the Switch to automatically learn multicast group membership of any VLANs. The Switch then performs IGMP snooping on the first 16 VLANs that send IGMP packets. This is referred to as auto mode. Alternatively, you can specify the VLANs that IGMP snooping should be performed on. This is referred to as fixed mode. In fixed mode the Switch does not learn multicast group membership of any VLANs other than those explicitly added as an IGMP snooping VLAN.

MLD Snooping-proxy

MLD snooping-proxy is a Zyxel-proprietary feature. IPv6 MLD proxy allows only one upstream interface on a switch, while MLD snooping-proxy supports more than one upstream port on a switch. The upstream port in MLD snooping-proxy can report group changes to a connected multicast router and forward MLD messages to other upstream ports. This helps especially when you want to have a network that uses STP to provide backup links between switches and also performs MLD snooping and proxy functions. MLD snooping-proxy, like MLD proxy, can minimize MLD control messages and allow better network performance.

In MLD snooping-proxy, if one upstream port is learned through snooping, all other upstream ports on the same device will be added to the same group. If one upstream port requests to leave a group, all other upstream ports on the same device will also be removed from the group.

In the following MLD snooping-proxy example, all connected upstream ports (1 – 7) are treated as one interface. The connection between ports 8 and 9 is blocked by STP to break the loop. If there is one query from a router (X) or MLD Done or Report message from any upstream port, it will be broadcast to all connected upstream ports.

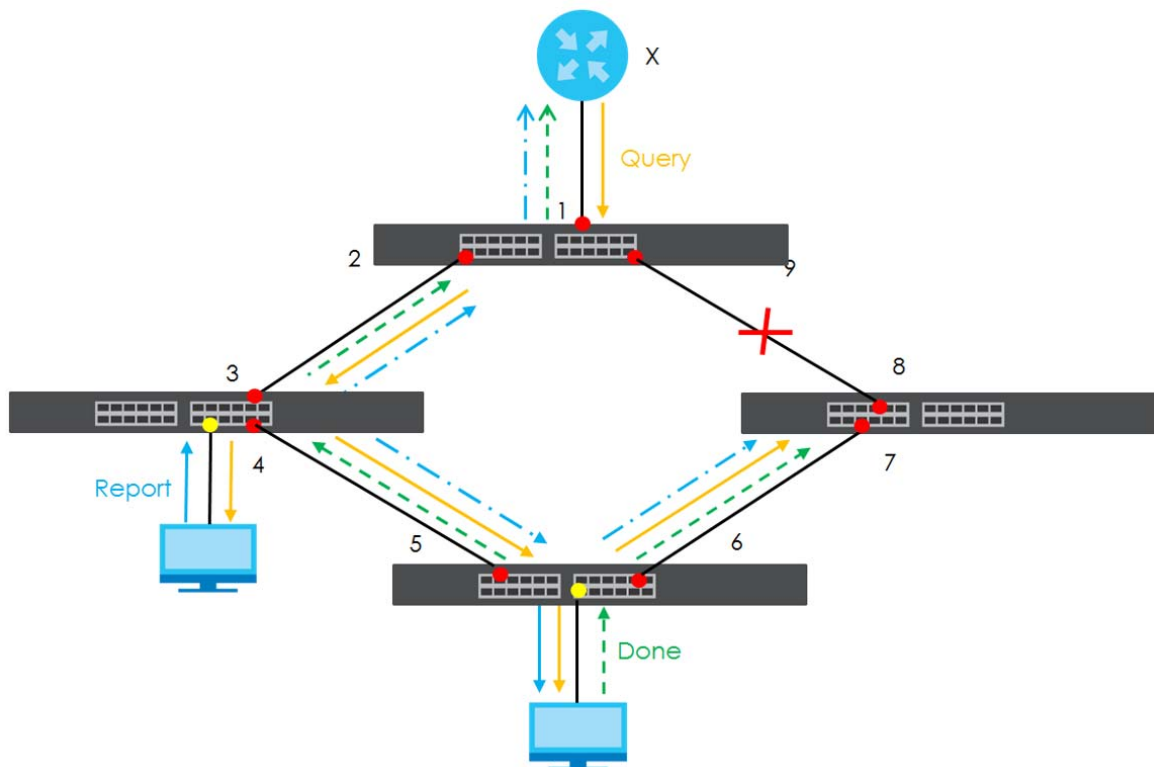

MLD Messages

A multicast router or switch periodically sends general queries to MLD hosts to update the multicast forwarding table. When an MLD host wants to join a multicast group, it sends an MLD Report message for that address.

An MLD Done message is similar to an IGMP Leave message. When an MLD host wants to leave a multicast group, it can send a Done message to the router or switch. If the leave mode is not set to **Immediate**, the router or switch sends a group-specific query to the port on which the Done message is received to determine if other devices connected to this port should remain in the group.

MVR Overview

Multicast VLAN Registration (MVR) is designed for applications (such as Media-on-Demand (MoD)) that use multicast traffic across an Ethernet ring-based service provider network.

MVR allows one single multicast VLAN to be shared among different subscriber VLANs on the network. While isolated in different subscriber VLANs, connected devices can subscribe to and unsubscribe from the multicast stream in the multicast VLAN. This improves bandwidth utilization with reduced multicast traffic in the subscriber VLANs and simplifies multicast group management.

MVR only responds to IGMP join and leave control messages from multicast groups that are configured under MVR. Join and leave reports from other multicast groups are managed by IGMP snooping.

The following figure shows a network example. The subscriber VLAN (1, 2 and 3) information is hidden from the streaming media server, **S**. In addition, the multicast VLAN information is only visible to the Switch and **S**.

Figure 238 MVR Network Example



Types of MVR Ports

In MVR, a source port is a port on the Switch that can send and receive multicast traffic in a multicast VLAN while a receiver port can only receive multicast traffic. Once configured, the Switch maintains a forwarding table that matches the multicast stream to the associated multicast group.

MVR Modes

You can set your Switch to operate in either dynamic or compatible mode.

In dynamic mode, the Switch sends IGMP leave and join reports to the other multicast devices (such as multicast routers or servers) in the multicast VLAN. This allows the multicast devices to update the multicast forwarding table to forward or not forward multicast traffic to the receiver ports.

In compatible mode, the Switch does not send any IGMP reports. In this case, you must manually configure the forwarding settings on the multicast devices in the multicast VLAN.

How MVR Works

The following figure shows a multicast television example where a subscriber device (such as a computer) in VLAN 1 receives multicast traffic from the streaming media server, **S**, through the Switch. Multiple subscriber devices can connect through a port configured as the receiver on the Switch.

When the subscriber selects a television channel, computer **A** sends an IGMP report to the Switch to join the appropriate multicast group. If the IGMP report matches one of the configured MVR multicast group addresses on the Switch, an entry is created in the forwarding table on the Switch. This maps the subscriber VLAN to the list of forwarding destinations for the specified multicast traffic.

When the subscriber changes the channel or turns off the computer, an IGMP leave message is sent to the Switch to leave the multicast group. The Switch sends a query to VLAN 1 on the receiver port (in this case, an uplink port on the Switch). If there is another subscriber device connected to this port in the same subscriber VLAN, the receiving port will still be on the list of forwarding destination for the multicast traffic. Otherwise, the Switch removes the receiver port from the forwarding table.

Figure 239 MVR Multicast Television Example

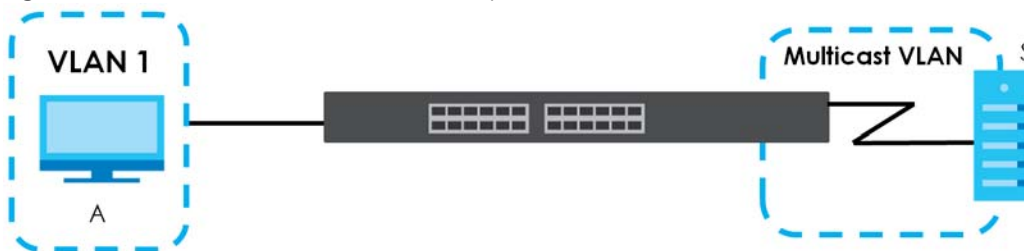

46.2 IPv4 Multicast Status

Click **SWITCHING > Multicast > IPv4 Multicast > IPv4 Multicast Status** to display the screen as shown. This screen shows the IPv4 multicast group information. See [Section 46.1 on page 315](#) for more information on multicasting.

Figure 240 SWITCHING > Multicast > IPv4 Multicast > IPv4 Multicast Status

IPv4 Multicast Status			
IGMP Snooping		IGMP Snooping VLAN	
Index	VID	Port	Multicast Group
1	1	18	224.0.0.251
2	1	18	224.0.0.252
3	1	18	239.255.255.250

The following table describes the labels in this screen.

Table 143 SWITCHING > Multicast > IPv4 Multicast > IPv4 Multicast Status

LABEL	DESCRIPTION
Index	This is the index number of the entry.
VID	This field displays the multicast VLAN ID.
Port	This field displays the port number that belongs to the multicast group. In Stacking mode, the first number represents the slot and the second is the port number.
Multicast Group	This field displays IP multicast group addresses.

46.3 IGMP Snooping

Click **SWITCHING > Multicast > IPv4 Multicast > IGMP Snooping** to display the screen as shown. See [Section 46.1 on page 315](#) for more information on multicasting.

Figure 241 SWITCHING > Multicast > IPv4 Multicast > IGMP Snooping (Standalone Mode)

IPv4 Multicast Status **IGMP Snooping** IGMP Snooping VLAN IGMP Filtering Profile

Active OFF

Querier

Querier Version v3

Report Proxy

Host Timeout 260 seconds

802.1p Priority No-Change

IGMP Filtering Active OFF

IGMP Snooping Smart Forward Active ON

Unknown Multicast Frame Flooding Drop Drop on VLAN

Unknown Multicast Frame to Querier Port Drop Forwarding Forwarding on VLAN

Reserved Multicast Group Flooding Drop

Port	Immediate Leave	Normal Leave	Fast Leave	Group Limited	Max Group Number	Throttling	IGMP Filtering Profile	IGMP Querier Mode
*	<input type="radio"/>	<input checked="" type="radio"/> 4000	<input type="radio"/> 200	<input type="checkbox"/>	0	Deny	Default	Auto
1	<input type="radio"/>	<input checked="" type="radio"/> 4000	<input type="radio"/> 200	<input type="checkbox"/>	0	Deny	Default	Auto
2	<input type="radio"/>	<input checked="" type="radio"/> 4000	<input type="radio"/> 200	<input type="checkbox"/>	0	Deny	Default	Auto
3	<input type="radio"/>	<input checked="" type="radio"/> 4000	<input type="radio"/> 200	<input type="checkbox"/>	0	Deny	Default	Auto
4	<input type="radio"/>	<input checked="" type="radio"/> 4000	<input type="radio"/> 200	<input type="checkbox"/>	0	Deny	Default	Auto
5	<input type="radio"/>	<input checked="" type="radio"/> 4000	<input type="radio"/> 200	<input type="checkbox"/>	0	Deny	Default	Auto
6	<input type="radio"/>	<input checked="" type="radio"/> 4000	<input type="radio"/> 200	<input type="checkbox"/>	0	Deny	Default	Auto
7	<input type="radio"/>	<input checked="" type="radio"/> 4000	<input type="radio"/> 200	<input type="checkbox"/>	0	Deny	Default	Auto

Apply Cancel

Figure 242 SWITCHING > Multicast > IPv4 Multicast > IGMP Snooping (Stacking Mode)

The screenshot displays the configuration interface for IGMP Snooping in Stacking Mode. It is divided into several sections:

- Global Settings:**
 - Active: OFF
 - Querier:
 - Querier Version: v3
 - Report Proxy:
 - Host Timeout: 260 seconds
 - 802.1p Priority: No-Change
 - IGMP Filtering Active: OFF
 - IGMP Snooping Smart Forward Active: ON
 - Unknown Multicast Frame: Flooding, Drop, Drop on VLAN
 - Unknown Multicast Frame to Querier Port: Drop, Forwarding, Forwarding on VLAN
 - Reserved Multicast Group: Flooding, Drop
- Port Configuration Table (Slot 1):**

Port	Immediate Leave	Normal Leave	Fast Leave	Group Limited	Max Group Number	Throttling	IGMP Filtering Profile	IGMP Querier Mode
1/*	<input type="radio"/>	<input checked="" type="radio"/> 4000	<input type="radio"/>	<input type="checkbox"/>	0	Deny	Default	Auto
1/1	<input type="radio"/>	<input checked="" type="radio"/> 4000	<input type="radio"/> 200	<input type="checkbox"/>	0	Deny	Default	Auto
1/2	<input type="radio"/>	<input checked="" type="radio"/> 4000	<input type="radio"/> 200	<input type="checkbox"/>	0	Deny	Default	Auto
1/3	<input type="radio"/>	<input checked="" type="radio"/> 4000	<input type="radio"/> 200	<input type="checkbox"/>	0	Deny	Default	Auto
1/4	<input type="radio"/>	<input checked="" type="radio"/> 4000	<input type="radio"/> 200	<input type="checkbox"/>	0	Deny	Default	Auto
1/5	<input type="radio"/>	<input checked="" type="radio"/> 4000	<input type="radio"/> 200	<input type="checkbox"/>	0	Deny	Default	Auto
1/6	<input type="radio"/>	<input checked="" type="radio"/> 4000	<input type="radio"/> 200	<input type="checkbox"/>	0	Deny	Default	Auto
1/7	<input type="radio"/>	<input checked="" type="radio"/> 4000	<input type="radio"/> 200	<input type="checkbox"/>	0	Deny	Default	Auto

The following table describes the labels in this screen.

Table 144 SWITCHING > Multicast > IPv4 Multicast > IGMP Snooping

LABEL	DESCRIPTION
Active	Enable the switch button to enable IGMP Snooping to forward group multicast traffic only to ports that are members of that group.
Querier	Select this to allow the Switch to send IGMP General Query messages to the VLANs with the multicast hosts attached.
Querier Version	IGMP snooping query works only when both host and Switch support the same IGMP version. Select v2 to allow the Switch to send IGMPv2 queries only. Select v3 to allow the Switch to send IGMPv3 queries only.

Table 144 SWITCHING > Multicast > IPv4 Multicast > IGMP Snooping (continued)

LABEL	DESCRIPTION
Report Proxy	<p>Select this to allow the Switch to act as the IGMP report proxy and leave proxy. It will report group changes to a connected multicast router.</p> <p>The Switch not only checks IGMP packets between multicast routers or switches and multicast hosts to learn the multicast group membership, but also replaces the source MAC address in an IGMP v1/v2 report with its own MAC address before forwarding to the multicast router or switch. When the Switch receives more than one IGMP v1/v2 join report that requests to join the same multicast group, it only sends a new join report with its MAC address. This helps reduce the number of multicast join reports passed to the multicast router or switch.</p> <p>The Switch sends a leave message with its MAC address to the multicast router or switch only when it receives the leave message from the last host in a multicast group.</p>
Host Timeout	Specify the time (from 1 to 16711450) in seconds that elapses before the Switch removes an IGMP group membership entry if it does not receive report messages from the port.
802.1p Priority	Select a priority level (0 – 7) to which the Switch changes the priority in outgoing IGMP control packets. Otherwise, select No-Change to not replace the priority.
IGMP Filtering Active	<p>Enable the switch button to enable IGMP filtering to control which IGMP groups a subscriber on a port can join.</p> <p>If you enable IGMP filtering, you must create and assign IGMP filtering profiles for the ports that you want to allow to join multicast groups.</p>
IGMP Snooping Smart Forward Active	Enable the switch button to enable sending of multicast frame to querier port and IGMP subscriber groups. Otherwise, the querier port forwards the frames only when it receives a join report and it belongs to the IGMP group.
Unknown Multicast Frame	<p>Specify the action to perform when the Switch receives an unknown multicast frame.</p> <ul style="list-style-type: none"> • Select Flooding to send the frames to all ports. • Select Drop to discard the frames. • Select Drop on VLAN and enter the VLAN ID numbers to discard the frames on the specified VLANs. Use a dash to specify consecutive VLANs and a comma (no spaces) to specify non-consecutive VLANs. For example, 51–53 includes 51, 52 and 53, but 51,53 does not include 52.
Unknown Multicast Frame to Querier Port	<p>Specify the action to perform when Unknown Multicast Frame is set to Drop.</p> <ul style="list-style-type: none"> • Select Drop to discard the frames. • Select Forwarding to send the frames to all querier ports. • Select Forwarding on VLAN and enter the VLAN ID numbers to send the frames to the ports which are used as an IGMP query port on the specified VLANs. Use a dash to specify consecutive VLANs and a comma (no spaces) to specify non-consecutive VLANs. For example, 51–53 includes 51, 52 and 53, but 51,53 does not include 52.
Reserved Multicast Group	<p>The IP address range of 224.0.0.0 to 224.0.0.255 are reserved for multicasting on the local network only. For example, 224.0.0.1 is for all hosts on a local network segment and 224.0.0.9 is used to send RIP routing information to all RIP v2 routers on the same network segment. A multicast router will not forward a packet with the destination IP address within this range to other networks. See the IANA web site for more information.</p> <p>The layer-2 multicast MAC addresses used by Cisco layer-2 protocols, 01:00:0C:CC:CC:CC and 01:00:0C:CC:CC:CD, are also included in this group.</p> <p>Specify the action to perform when the Switch receives a frame with a reserved multicast address.</p> <ul style="list-style-type: none"> • Select Flooding to send the frames to all ports. • Select Drop to discard the frames.
Use this section to configure IGMP Snooping on each port.	
SLOT	This field appears only in Stacking mode. Click the drop-down list to choose the slot number of the Switch in a stack.

Table 144 SWITCHING > Multicast > IPv4 Multicast > IGMP Snooping (continued)

LABEL	DESCRIPTION
Port	This field displays the port number. In Stacking mode, the first number represents the slot ID and the second is the port number. Please note that the default stacking ports (the last four ports of your Switch) cannot be configured. They are reserved for stacking only.
*	<p>Settings in this row apply to all ports.</p> <p>Use this row only if you want to make some settings the same for all ports. Use this row first to set the common settings and then make adjustments on a port-by-port basis.</p> <p>Changes in this row are copied to all the ports as soon as you make them.</p>
Immediate Leave	<p>Select this to set the Switch to remove this port from the multicast tree when an IGMP version 2 leave message is received on this port.</p> <p>Select this option if there is only one host connected to this port.</p>
Normal Leave	<p>Enter an IGMP normal leave timeout value (from 200 to 6348800) in milliseconds. Select this option to have the Switch use this timeout to update the forwarding table for the port.</p> <p>In normal leave mode, when the Switch receives an IGMP leave message from a host on a port, it forwards the message to the multicast router. The multicast router then sends out an IGMP Group-Specific Query (GSQ) message to determine whether other hosts connected to the port should remain in the specific multicast group. The Switch forwards the query message to all hosts connected to the port and waits for IGMP reports from hosts to update the forwarding table.</p> <p>This defines how many seconds the Switch waits for an IGMP report before removing an IGMP snooping membership entry when an IGMP leave message is received on this port from a host.</p>
Fast Leave	<p>Enter an IGMP fast leave timeout value (from 200 to 6348800) in milliseconds. Select this option to have the Switch use this timeout to update the forwarding table for the port.</p> <p>In fast leave mode, right after receiving an IGMP leave message from a host on a port, the Switch itself sends out an IGMP Group-Specific Query (GSQ) message to determine whether other hosts connected to the port should remain in the specific multicast group. This helps speed up the leave process.</p> <p>This defines how many seconds the Switch waits for an IGMP report before removing an IGMP snooping membership entry when an IGMP leave message is received on this port from a host.</p>
Group Limited	Select this option to limit the number of multicast groups this port is allowed to join.
Max Group Number	Enter the number of multicast groups this port is allowed to join. Once a port is registered in the specified number of multicast groups, any new IGMP join report frames is dropped on this port.
Throttling	<p>IGMP throttling controls how the Switch deals with the IGMP reports when the maximum number of the IGMP groups a port can join is reached.</p> <p>Select Deny to drop any new IGMP join report received on this port until an existing multicast forwarding table entry is aged out.</p> <p>Select Replace to replace an existing entry in the multicast forwarding table with the new IGMP reports received on this port.</p>
IGMP Filtering Profile	<p>Select the name of the IGMP filtering profile to use for this port. Otherwise, select Default to prohibit the port from joining any multicast group.</p> <p>You can create IGMP filtering profiles in the SWITCHING > Multicast > IPv4 Multicast > IGMP Filtering Profile screen.</p>

Table 144 SWITCHING > Multicast > IPv4 Multicast > IGMP Snooping (continued)

LABEL	DESCRIPTION
IGMP Querier Mode	<p>The Switch treats an IGMP query port as being connected to an IGMP multicast router (or server). The Switch forwards IGMP join or leave packets to an IGMP query port.</p> <p>Select Auto to have the Switch use the port as an IGMP query port if the port receives IGMP query packets.</p> <p>Select Fixed to have the Switch always use the port as an IGMP query port. Select this when you connect an IGMP multicast server to the port.</p> <p>Select Edge to stop the Switch from using the port as an IGMP query port. The Switch will not keep any record of an IGMP router being connected to this port. The Switch does not forward IGMP join or leave packets to this port.</p>
Apply	Click Apply to save your changes to the Switch's run-time memory. The Switch loses these changes if it is turned off or loses power, so use the Save link on the top navigation panel to save your changes to the non-volatile memory when you are done configuring.
Cancel	Click Cancel to begin configuring this screen afresh.

46.4 IGMP Snooping VLAN

Click **SWITCHING > Multicast > IPv4 Multicast > IGMP Snooping VLAN** to display the screen as shown. See [IGMP Snooping and VLANs on page 317](#) for more information on IGMP Snooping VLAN.

Note: You can perform IGMP snooping on up to 16 VLANs.

Figure 243 SWITCHING > Multicast > IPv4 Multicast > IGMP Snooping VLAN

IPv4 Multicast Status IGMP Snooping **IGMP Snooping VLAN** IGMP Filtering Profile

IGMP Snooping VLAN

Mode auto fixed

Apply Cancel

VLAN

+ Add/Edit Delete

<input type="checkbox"/>	Index	Name	VID
<input type="checkbox"/>	1	VLAN66	66

The following table describes the labels in this screen.

Table 145 SWITCHING > Multicast > IPv4 Multicast > IGMP Snooping VLAN

LABEL	DESCRIPTION
IGMP Snooping VLAN	
Mode	<p>Select auto to have the Switch learn multicast group membership information of any VLANs automatically.</p> <p>Select fixed to have the Switch only learn multicast group membership information of the VLANs that you specify below.</p> <p>In either auto or fixed mode, the Switch can learn up to 16 VLANs (including up to five VLANs you configured in the MVR screen). For example, if you have configured one multicast VLAN in the SWITCHING > Multicast > MVR screen, you can only specify up to 15 VLANs in this screen.</p> <p>The Switch drops any IGMP control messages which do not belong to these 16 VLANs.</p> <p>You must also enable IGMP snooping in the SWITCHING > Multicast > IPv4 Multicast > IGMP Snooping screen first.</p>
Apply	Click Apply to save your changes to the Switch's run-time memory. The Switch loses these changes if it is turned off or loses power, so use the Save link on the top navigation panel to save your changes to the non-volatile memory when you are done configuring.
Cancel	Click Cancel to begin configuring this screen afresh.
VLAN	
Use this section of the screen to add VLANs on which the Switch is to perform IGMP snooping.	
Index	This is the index number of the IGMP snooping VLAN entry in the table.
Name	This field displays the descriptive name for this VLAN group.
VID	This field displays the ID number of the VLAN group.
	Select an entry's check box to select a specific entry. Otherwise, select the check box in the table heading row to select all entries.
Add/Edit	Click Add/Edit to create a new entry or edit a selected one.
Delete	Click Delete to remove the selected entries.

46.4.1 Add/Edit IGMP Snooping VLANs

This screen allows you to add an IGMP snooping VLAN or edit an existing one.

To access this screen, click the **Add/Edit** button or select an entry from the list and click the **Add/Edit** button.

Figure 244 SWITCHING > Multicast > IPv4 Multicast > IGMP Snooping VLAN > Add/Edit

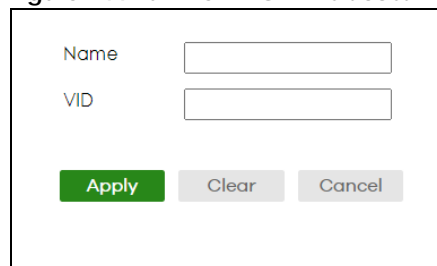

The screenshot shows a form with two input fields: "Name" and "VID". Below the fields are three buttons: "Apply" (green), "Clear" (grey), and "Cancel" (grey).

The following table describes the labels in this screen.

Table 146 SWITCHING > Multicast > IPv4 Multicast > IGMP Snooping VLAN > Add/Edit

LABEL	DESCRIPTION
Name	Enter the descriptive name of the VLAN for identification purposes. You can enter up to 32 printable ASCII characters except [?], [], ['], ["] or [.].
VID	Enter the ID of a static VLAN; the valid range is between 1 and 4094. Note: You cannot configure the same VLAN ID as in the SWITCHING > Multicast > MVR screen.
Apply	Click Apply to save your changes to the Switch's run-time memory. The Switch loses these changes if it is turned off or loses power, so use the Save link on the top navigation panel to save your changes to the non-volatile memory when you are done configuring.
Clear	Click Clear to clear the fields to the factory defaults.
Cancel	Click Cancel to not save the configuration you make and return to the last screen.

46.5 IGMP Filtering Profile

An IGMP filtering profile specifies a range of multicast groups that clients connected to the Switch are able to join. A profile contains a range of multicast IP addresses which you want clients to be able to join. Profiles are assigned to ports (in the **SWITCHING > Multicast > IPv4 Multicast > IGMP Snooping** screen). Clients connected to those ports are then able to join the multicast groups specified in the profile. Each port can be assigned a single profile. A profile can be assigned to multiple ports.

Click **SWITCHING > Multicast > IPv4 Multicast > IGMP Filtering Profile** link to display the screen as shown.

Figure 245 SWITCHING > Multicast > IPv4 Multicast > IGMP Filtering Profile

<input type="checkbox"/>	Profile Name	Start Address	End Address
<input type="checkbox"/>	Default	0.0.0.0	0.0.0.0
<input type="checkbox"/>	Profile 1	224.0.0.0	224.0.0.0
<input type="checkbox"/>		225.0.0.0	225.225.0.0

The following table describes the labels in this screen.

Table 147 SWITCHING > Multicast > IPv4 Multicast > IGMP Filtering Profile

LABEL	DESCRIPTION
Profile Name	This field displays the descriptive name of the profile.
Start Address	This field displays the start of the multicast address range.
End Address	This field displays the end of the multicast address range.
	Select an entry's check box to select a specific entry. Otherwise, select the check box in the table heading row to select all entries.
Add Profile	Click this to add a new IGMP filtering profile.

Table 147 SWITCHING > Multicast > IPv4 Multicast > IGMP Filtering Profile (continued)

LABEL	DESCRIPTION
Add Rule	Click Add Rule to add a new rule and specify the profile it belongs to in the Add Rule screen. You can also select a profile entry and click Add Rule to add an additional rule for the selected profile.
Delete	Select a profile and click Delete to remove the selected profile and the accompanying rules. Select a rule from a profile and click Delete to remove the selected rule.

46.5.1 Add IGMP Filtering Profile

To access this screen, click the **Add Profile** button in the **SWITCHING > Multicast > IPv4 Multicast > IGMP Filtering Profile** screen.

Figure 246 SWITCHING > Multicast > IPv4 Multicast > IGMP Filtering Profile > Add Profile

The following table describes the labels in this screen.

Table 148 SWITCHING > Multicast > IPv4 Multicast > IGMP Filtering Profile > Add Profile

LABEL	DESCRIPTION
Profile Name	Enter a descriptive name for the profile for identification purposes. You can enter up to 32 printable ASCII characters except [?], [], ['], ["] or [,].
Start Address	Enter the starting multicast IP address for a range of multicast IP addresses that you want to belong to the IGMP filter profile.
End Address	Enter the ending multicast IP address for a range of IP addresses that you want to belong to the IGMP filter profile. If you want to add a single multicast IP address, enter it in both the Start Address and End Address fields.
Apply	Click Apply to save your changes to the Switch's run-time memory. The Switch loses these changes if it is turned off or loses power, so use the Save link on the top navigation panel to save your changes to the non-volatile memory when you are done configuring.
Clear	Click Clear to clear the fields to the factory defaults.
Cancel	Click Cancel to not save the configuration you make and return to the last screen.

46.5.2 Add IGMP Filtering Rule

Click **Add Rule** in the **SWITCHING > Multicast > IPv4 Multicast > IGMP Filtering Profile** screen to access this screen.

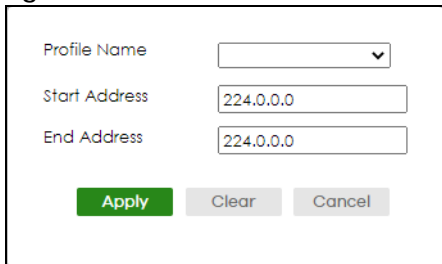
Figure 247 SWITCHING > Multicast > IPv4 Multicast > IGMP Filtering Profile > Add Rule

The following table describes the labels in this screen.

Table 149 SWITCHING > Multicast > IPv4 Multicast > IGMP Filtering Profile > Add Rule

LABEL	DESCRIPTION
Profile Name	Select a profile from the drop-down list to add a additional rule for the existing profile.
Start Address	Enter the starting multicast IP address for a range of multicast IP addresses that you want to belong to the IGMP filter profile.
End Address	Enter the ending multicast IP address for a range of IP addresses that you want to belong to the IGMP filter profile. If you want to add a single multicast IP address, enter it in both the Start Address and End Address fields.
Apply	Click Apply to save your changes to the Switch's run-time memory. The Switch loses these changes if it is turned off or loses power, so use the Save link on the top navigation panel to save your changes to the non-volatile memory when you are done configuring.
Clear	Click Clear to clear the fields to the factory defaults.
Cancel	Click Cancel to not save the configuration you make and return to the last screen.

46.6 IPv6 Multicast Status

Click **SWITCHING > Multicast > IPv6 Multicast > IPv6 Multicast Status** to display the screen as shown. This screen shows the IPv6 multicast group information. See [Section 46.1 on page 315](#) for more information on multicasting.

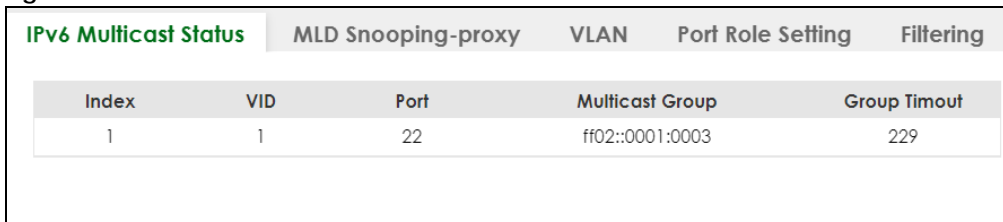
Figure 248 SWITCHING > Multicast > IPv6 Multicast > IPv6 Multicast Status

Index	VID	Port	Multicast Group	Group Timeout
1	1	22	ff02::0001:0003	229

The following table describes the fields in the above screen.

Table 150 SWITCHING > Multicast > IPv6 Multicast > IPv6 Multicast Status

LABEL	DESCRIPTION
Index	This is the index number of the entry.
VID	This field displays the multicast VLAN ID.
Port	This field displays the port number that belongs to the multicast group. In Stacking mode, the first number represents the slot and the second is the port number.

Table 150 SWITCHING > Multicast > IPv6 Multicast > IPv6 Multicast Status (continued)

LABEL	DESCRIPTION
Multicast Group	This field displays IP multicast group addresses.
Group Timeout	This field displays the time (in seconds) that elapses before the Switch removes a MLD group membership entry if it does not receive report messages from the port.

46.7 MLD Snooping-proxy

Click **SWITCHING > Multicast > IPv6 Multicast > MLD Snooping-proxy** to display the screen as shown. See [Section 46.1 on page 315](#) for more information on multicasting.

Figure 249 SWITCHING > Multicast > IPv6 Multicast > MLD Snooping-proxy

The following table describes the fields in the above screen.

Table 151 SWITCHING > Multicast > IPv6 Multicast > MLD Snooping-proxy

LABEL	DESCRIPTION
MLD Snooping-proxy	Use these settings to configure MLD snooping-proxy.
Active	Enable the switch button to enable MLD snooping-proxy on the Switch to minimize MLD control messages and allow better network performance.
802.1p Priority	Select a priority level (0 – 7) to which the Switch changes the priority in outgoing MLD messages.
Apply	Click Apply to save your changes to the Switch's run-time memory. The Switch loses these changes if it is turned off or loses power, so use the Save link on the top navigation panel to save your changes to the non-volatile memory when you are done configuring.
Cancel	Click Cancel to begin configuring this screen afresh.

46.8 MLD Snooping-proxy VLAN

Click **SWITCHING > Multicast > IPv6 Multicast > VLAN** screen to display the screen as shown. See [Section 46.1 on page 315](#) for more information on multicasting.

Figure 250 SWITCHING > Multicast > IPv6 Multicast > VLAN: MLD Snooping-proxy VLAN

Index	VID
<input type="checkbox"/> 1	1
<input type="checkbox"/> 2	100

The following table describes the fields in the above screen.

Table 152 SWITCHING > Multicast > IPv6 Multicast > VLAN: MLD Snooping-proxy VLAN

LABEL	DESCRIPTION
MLD Snooping-proxy VLAN	
Index	This is the index number of the MLD snooping-proxy VLAN entry in the table.
VID	This field displays the ID number of the VLAN group.
	Select an entry's check box to select a specific entry. Otherwise, select the check box in the table heading row to select all entries.
Add/Edit	Click Add/Edit to add a new entry or edit a selected one.
Delete	Click Delete to remove the selected entry.

46.8.1 Add/Edit MLD Snooping-proxy VLAN

The screen allows you to enable and configure MLD Snooping-proxy settings on a VLAN you specified.

Click **Add/Edit** in the **SWITCHING > Multicast > IPv6 Multicast > VLAN** screen to display this screen.

Figure 251 SWITCHING > Multicast > IPv6 Multicast > VLAN > Add/Edit

VID:

Upstream

Query Interval: milliseconds

Maximum Response Delay: milliseconds

Robustness Variable:

Last Member Query Interval: milliseconds

Downstream

Query Interval: milliseconds

Maximum Response Delay: milliseconds

Apply

The following table describes the fields in the above screen.

Table 153 SWITCHING > Multicast > IPv6 Multicast > VLAN > Add/Edit

LABEL	DESCRIPTION
VID	Enter the ID number of the VLAN on which you want to enable MLD snooping-proxy and configure related settings.
Upstream	
Query Interval	<p>Enter the amount of time (in milliseconds) between general query messages sent by the router connected to the upstream port. This value should be exactly the same as what is configured in the connected multicast router.</p> <p>This value is used to calculate the amount of time an MLD snooping membership entry (learned only on the upstream port) can remain in the forwarding table.</p> <p>When an MLD Report message is received, the Switch sets the timeout period of the entry to be $T = (QI \cdot RV) + MRD$, where $T = \text{Timeout}$, $QI = \text{Query Interval}$, $RV = \text{Robustness Variable}$, and $MRD = \text{Maximum Response Delay}$.</p>
Maximum Response Delay	<p>Enter the amount of time (in milliseconds) the router connected to the upstream port waits for a response to an MLD general query message. This value should be exactly the same as what is configured in the connected multicast router.</p> <p>This value is used to calculate the amount of time an MLD snooping membership entry (learned only on the upstream port) can remain in the forwarding table.</p> <p>When an MLD Report message is received, the Switch sets the timeout period of the entry to be $T = (QI \cdot RV) + MRD$, where $T = \text{Timeout}$, $QI = \text{Query Interval}$, $RV = \text{Robustness Variable}$, and $MRD = \text{Maximum Response Delay}$.</p> <p>When an MLD Done message is received, the Switch sets the entry's lifetime to be the product of Last Member Query Interval and Robustness Variable.</p>
Robustness Variable	<p>Enter the number of queries. A multicast address entry (learned only on an upstream port by snooping) is removed from the forwarding table when there is no response to the configured number of queries sent by the router connected to the upstream port. This value should be exactly the same as what's configured in the connected multicast router.</p> <p>This value is used to calculate the amount of time an MLD snooping membership entry (learned only on the upstream port) can remain in the forwarding table.</p>
Last Member Query Interval	<p>Enter the amount of time (in milliseconds) between the MLD group-specific queries sent by an upstream port when an MLD Done message is received. This value should be exactly the same as what's configured in the connected multicast router.</p> <p>This value is used to calculate the amount of time an MLD snooping membership entry (learned only on the upstream port) can remain in the forwarding table after a Done message is received.</p> <p>When an MLD Done message is received, the Switch sets the entry's lifetime to be the product of Last Member Query Interval and Robustness Variable.</p>
Downstream	
Query Interval	Enter the amount of time (in milliseconds) between general query messages sent by the downstream port.
Maximum Response Delay	Enter the maximum time (in milliseconds) that the Switch waits for a response to a general query message sent by the downstream port.
Apply	Click Apply to save your changes to the Switch's run-time memory. The Switch loses these changes if it is turned off or loses power, so use the Save link on the top navigation panel to save your changes to the non-volatile memory when you are done configuring.
Clear	Click Clear to clear the fields to the factory defaults.
Cancel	Click Cancel to not save the configuration you make and return to the last screen.

46.9 MLD Snooping-proxy Port Role Setting

Click **SWITCHING > Multicast > IPv6 Multicast > Port Role Setting** to display the screen as shown. See [Section 46.1 on page 315](#) for more information on multicasting.

Figure 252 SWITCHING > Multicast > IPv6 Multicast > Port Role Setting (Standalone Mode)

IPv6 Multicast Status
MLD Snooping-proxy
VLAN
Port Role Setting
Filtering

MLD Snooping-proxy Port Role Setting

MLD Snooping-proxy VLAN ID

Port	Port Role	Leave Mode	Leave Timeout	Fast Leave Timeout
*	<input type="text" value="None"/>	<input type="text" value="Immediate"/>	<input type="text" value=""/>	<input type="text" value=""/>
1	<input type="text" value="None"/>	<input type="text" value="Immediate"/>	<input type="text" value="4000"/>	<input type="text" value="200"/>
2	<input type="text" value="None"/>	<input type="text" value="Immediate"/>	<input type="text" value="4000"/>	<input type="text" value="200"/>
3	<input type="text" value="None"/>	<input type="text" value="Immediate"/>	<input type="text" value="4000"/>	<input type="text" value="200"/>
4	<input type="text" value="None"/>	<input type="text" value="Immediate"/>	<input type="text" value="4000"/>	<input type="text" value="200"/>
5	<input type="text" value="None"/>	<input type="text" value="Immediate"/>	<input type="text" value="4000"/>	<input type="text" value="200"/>
6	<input type="text" value="None"/>	<input type="text" value="Immediate"/>	<input type="text" value="4000"/>	<input type="text" value="200"/>
7	<input type="text" value="None"/>	<input type="text" value="Immediate"/>	<input type="text" value="4000"/>	<input type="text" value="200"/>

Figure 253 SWITCHING > Multicast > IPv6 Multicast > Port Role Setting (Stacking Mode)

IPv6 Multicast Status MLD Snooping-proxy VLAN **Port Role Setting** Filtering

MLD Snooping-proxy Port Role Setting

MLD Snooping-proxy VLAN ID

SLOT 1

Port	Port Role	Leave Mode	Leave Timeout	Fast Leave Timeout
1/*	None	Immediate	<input type="text"/>	<input type="text"/>
1/1	None	Immediate	4000	200
1/2	None	Immediate	4000	200
1/3	None	Immediate	4000	200
1/4	None	Immediate	4000	200
1/5	None	Immediate	4000	200
1/6	None	Immediate	4000	200
1/7	None	Immediate	4000	200

The following table describes the fields in the above screen.

Table 154 SWITCHING > Multicast > IPv6 Multicast > Port Role Setting

LABEL	DESCRIPTION
MLD Snooping-proxy Port Role Setting	
MLD Snooping-proxy VLAN ID	Select the VLAN ID for which you want to configure a port's MLD snooping-proxy settings.
SLOT	This field appears only in Stacking mode. Click the drop-down list to choose the slot number of the Switch in a stack.
Port	This field displays the port number. In Stacking mode, the first number represents the slot ID and the second is the port number. Please note that the default stacking ports (the last four ports of your Switch) cannot be configured. They are reserved for stacking only.
*	Settings in this row apply to all ports. Use this row only if you want to make some settings the same for all ports. Use this row first to set the common settings and then make adjustments on a port-by-port basis. Changes in this row are copied to all the ports as soon as you make them.
Port Role	A port on the Switch can be either a Downstream port or Upstream port in MLD. A downstream port connects to MLD hosts and acts as a multicast router to send MLD queries and listen to the MLD host's Report and Done messages. An upstream port connects to a multicast router and works as a host to send Report or Done messages when receiving queries from a multicast router. Otherwise, select None if the port is not joining a multicast group or does not belong to this VLAN.

Table 154 SWITCHING > Multicast > IPv6 Multicast > Port Role Setting (continued)

LABEL	DESCRIPTION
Leave Mode	<p>This is configurable only when you select Downstream in the previous Port Role field.</p> <p>Select the leave mode for the specified downstream ports in this VLAN.</p> <p>This specifies whether the Switch removes an MLD snooping membership entry (learned on a downstream port) immediately (Immediate) or wait for an MLD report before the leave timeout (Normal) or fast leave timeout (Fast) when an MLD leave message is received on this port from a host.</p>
Leave Timeout	<p>Enter the MLD snooping normal leave timeout (in milliseconds) the Switch uses to update the forwarding table for the specified downstream ports.</p> <p>This defines how many seconds the Switch waits for an MLD report before removing an MLD snooping membership entry (learned on a downstream port) when an MLD Done message is received on this port from a host.</p>
Fast Leave Timeout	<p>Enter the fast leave timeout (in milliseconds) for the specified downstream ports.</p> <p>This defines how many seconds the Switch waits for an MLD report before removing an MLD snooping membership entry (learned on a downstream port) when an MLD Done message is received on this port from a host.</p>
Apply	<p>Click Apply to save your changes to the Switch's run-time memory. The Switch loses these changes if it is turned off or loses power, so use the Save link on the top navigation panel to save your changes to the non-volatile memory when you are done configuring.</p>
Cancel	<p>Click Cancel to reset the fields to your previous configuration.</p>

46.10 MLD Snooping-proxy Filtering

Use this screen to configure the Switch's MLD filtering settings. Click the **SWITCHING > Multicast > IPv6 Multicast > Filtering** screen to display the screen as shown.

Figure 254 SWITCHING > Multicast > IPv6 Multicast > Filtering (Standalone Mode)

IPv6 Multicast Status MLD Snooping-proxy VLAN Port Role Setting **Filtering**

MLD Snooping-proxy Filtering

Active ON

Port	Group Limit	Max Group Number	MLD Snooping-proxy Filtering Profile
*	<input type="checkbox"/>	<input type="text"/>	Default
1	<input checked="" type="checkbox"/>	<input type="text" value="1"/>	Default
2	<input checked="" type="checkbox"/>	<input type="text" value="1"/>	Default
3	<input checked="" type="checkbox"/>	<input type="text" value="1"/>	Default
4	<input checked="" type="checkbox"/>	<input type="text" value="1"/>	Default
5	<input checked="" type="checkbox"/>	<input type="text" value="1"/>	Default
6	<input checked="" type="checkbox"/>	<input type="text" value="1"/>	Default
7	<input checked="" type="checkbox"/>	<input type="text" value="1"/>	Default

Figure 255 SWITCHING > Multicast > IPv6 Multicast > Filtering (Stacking Mode)

IPv6 Multicast Status MLD Snooping-proxy VLAN Port Role Setting **Filtering**

MLD Snooping-proxy Filtering

Active OFF

SLOT 1

Port	Group Limit	Max Group Number	MLD Snooping-proxy Filtering Profile
1/*	<input type="checkbox"/>	<input type="text"/>	Default
1/1	<input type="checkbox"/>	<input type="text" value="0"/>	Default
1/2	<input type="checkbox"/>	<input type="text" value="0"/>	Default
1/3	<input type="checkbox"/>	<input type="text" value="0"/>	Default
1/4	<input type="checkbox"/>	<input type="text" value="0"/>	Default
1/5	<input type="checkbox"/>	<input type="text" value="0"/>	Default
1/6	<input type="checkbox"/>	<input type="text" value="0"/>	Default
1/7	<input type="checkbox"/>	<input type="text" value="0"/>	Default

The following table describes the fields in the above screen.

Table 155 SWITCHING > Multicast > IPv6 Multicast > Filtering

LABEL	DESCRIPTION
MLD Snooping-proxy Filtering	
Active	Enable the switch button to enable MLD filtering on the Switch.
SLOT	This field appears only in Stacking mode. Click the drop-down list to choose the slot number of the Switch in a stack.
Port	This field displays the port number. In Stacking mode, the first number represents the slot ID and the second is the port number. Please note that the default stacking ports (the last four ports of your Switch) cannot be configured. They are reserved for stacking only.
*	Settings in this row apply to all ports. Use this row only if you want to make some settings the same for all ports. Use this row first to set the common settings and then make adjustments on a port-by-port basis. Changes in this row are copied to all the ports as soon as you make them.
Group Limit	Select this option to limit the number of multicast groups this port is allowed to join.
Max Group Number	Enter the number of multicast groups this port is allowed to join. Once a port is registered in the specified number of multicast groups, any new MLD Report message is dropped on this port.
MLD Snooping-proxy Filtering Profile	Select the name of the MLD filtering profile to use for this port. Otherwise, select Default to prohibit the port from joining any multicast group. You can create MLD filtering profiles in the SWITCHING > Multicast > IPv6 Multicast > Filtering Profile screen.
Apply	Click Apply to save your changes to the Switch's run-time memory. The Switch loses these changes if it is turned off or loses power, so use the Save link on the top navigation panel to save your changes to the non-volatile memory when you are done configuring.
Cancel	Click Cancel to reset the fields to your previous configuration.

46.11 MLD Snooping-proxy Filtering Profile

Use this screen to view and create MLD filtering profiles.

Click **SWITCHING > Multicast > IPv6 Multicast > Filtering Profile** to display the screen as shown.

Figure 256 SWITCHING > Multicast > IPv6 Multicast > Filtering Profile

Profile Name	Start Address	End Address
Default	0:0:0:0:0:0:0:0	0:0:0:0:0:0:0:0
profile1	ff02::1	ff02::1
profile1	ff02::2	ff02::2

The following table describes the fields in the above screen.

Table 156 SWITCHING > Multicast > IPv6 Multicast > Filtering Profile

LABEL	DESCRIPTION
MLD Snooping-proxy Filtering Profile	
Profile Name	This field displays the descriptive name of the profile.
Start Address	This field displays the start of the multicast IPv6 address range.
End Address	This field displays the end of the multicast IPv6 address range.
	Select an entry's check box to select a specific entry. Otherwise, select the check box in the table heading row to select all entries.
Add Profile	Click this to add a new MLD Snooping-proxy filtering profile.
Add Rule	Click Add Rule to add a new rule and specify the profile it belongs to in the Add Rule screen. You can also select a profile entry and click Add Rule to add an additional rule for the selected profile.
Delete	Select a profile and click Delete to remove the selected profile and the accompanying rules. Select a rule from a profile and click Delete to remove the selected rule.

46.11.1 Add MLD Snooping-proxy Filtering Profile

Use this screen to create an MLD filtering profile and set the range of the multicast addresses.

Click **Add Profile** in the **SWITCHING > Multicast > IPv6 Multicast > Filtering Profile** to display the screen as shown.

Figure 257 SWITCHING > Multicast > IPv6 Multicast > Filtering Profile > Add Profile

The screenshot shows a form with three text input fields labeled 'Profile Name', 'Start Address', and 'End Address'. Below the fields are three buttons: 'Apply' (green), 'Clear' (grey), and 'Cancel' (grey).

The following table describes the fields in the above screen.

Table 157 SWITCHING > Multicast > IPv6 Multicast > Filtering Profile > Add Profile

LABEL	DESCRIPTION
Profile Name	Enter a descriptive name (up to 32 printable ASCII characters except [?], [], ['], ["], [], [],) for the profile for identification purposes. To configure additional rules for a profile that you have already added, enter the profile name and specify a different IP multicast address range.
Start Address	Enter the starting multicast IPv6 address for a range of multicast IPv6 addresses that you want to belong to the MLD filtering profile.

Table 157 SWITCHING > Multicast > IPv6 Multicast > Filtering Profile > Add Profile (continued)

LABEL	DESCRIPTION
End Address	Enter the ending multicast IPv6 address for a range of IPv6 addresses that you want to belong to the MLD filtering profile. If you want to add a single multicast IPv6 address, enter it in both the Start Address and End Address fields.
Apply	Click Apply to save your changes to the Switch's run-time memory. The Switch loses these changes if it is turned off or loses power, so use the Save link on the top navigation panel to save your changes to the non-volatile memory when you are done configuring.
Clear	Click Clear to clear the fields to the factory defaults.
Cancel	Click Cancel to not save the configuration you make and return to the last screen.

46.11.2 Add MLD Snooping-proxy Filtering Rule

Use this screen to create a multicast addresses range rule of the MLD filtering profile.

Click **Add Rule** in the **SWITCHING > Multicast > IPv6 Multicast > Filtering Profile** to display this screen.

Figure 258 SWITCHING > Multicast > IPv6 Multicast > Filtering Profile > Add Rule

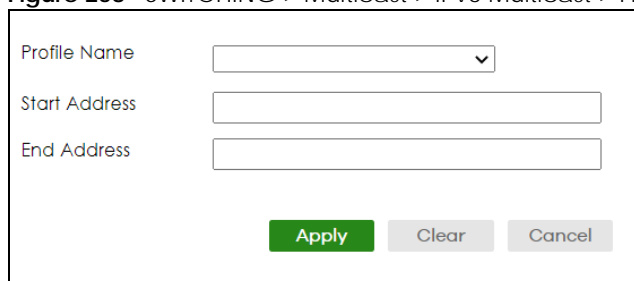

The following table describes the fields in the above screen.

Table 158 SWITCHING > Multicast > IPv6 Multicast > Filtering Profile > Add Rule

LABEL	DESCRIPTION
Profile Name	Select a profile from the drop-down list to add a additional rule for the existing profile.
Start Address	Enter the starting multicast IPv6 address for a range of multicast IPv6 addresses that you want to belong to the MLD filtering profile.
End Address	Enter the ending multicast IPv6 address for a range of IPv6 addresses that you want to belong to the MLD filtering profile. If you want to add a single multicast IPv6 address, enter it in both the Start Address and End Address fields.
Apply	Click Apply to save your changes to the Switch's run-time memory. The Switch loses these changes if it is turned off or loses power, so use the Save link on the top navigation panel to save your changes to the non-volatile memory when you are done configuring.
Clear	Click Clear to clear the fields to the factory defaults.
Cancel	Click Cancel to not save the configuration you make and return to the last screen.

46.12 MVR Configuration

Use this screen to view and create multicast VLANs.

Click **SWITCHING** > **Multicast** > **MVR** to display the screen as shown next.

Note: You can create up to five multicast VLANs and up to 256 multicast rules on the Switch.

Note: Your Switch automatically creates a static VLAN (with the same VID) when you create a multicast VLAN in this screen.

Figure 259 SWITCHING > Multicast > MVR

<input type="checkbox"/>	VLAN	Active	Name	Mode	Source Port	Receiver Port	802.1p Priority
<input type="checkbox"/>	5	ON	GroupExample	Dynamic			0

The following table describes the related labels in this screen.

Table 159 SWITCHING > Multicast > MVR

LABEL	DESCRIPTION
VLAN	This field displays the multicast VLAN ID.
Active	This field displays whether the multicast group is enabled or not.
Name	This field displays the descriptive name for this setting.
Mode	This field displays the MVR mode.
Source Port	This field displays the source port numbers.
Receiver Port	This field displays the receiver port numbers.
802.1p Priority	This field displays the priority level.
	Select an entry's check box to select a specific entry. Otherwise, select the check box in the table heading row to select all entries.
Add/Edit	Click Add/Edit to add a new multicast VLAN or edit a selected one.
Delete	Select the entries that you want to remove, then click Delete to delete multicast VLANs.

46.12.1 Add/Edit MVR

Use this screen to create or edit multicast VLANs and select the receiver ports and a source port for each multicast VLAN.

To access this screen, click **Add/Edit** or select an existing entry and click **Add/Edit** in the **SWITCHING** > **Multicast** > **MVR** screen.

Figure 260 SWITCHING > Multicast > MVR > Add/Edit (Standalone Mode)

Active OFF

Group Name

Multicast VLAN ID

802.1p Priority

Mode Dynamic Compatible

Port	Source Port	Receiver Port	None	Tagging
*		None		<input type="checkbox"/>
1	<input type="radio"/>	<input type="radio"/>	<input checked="" type="radio"/>	<input type="checkbox"/>
2	<input type="radio"/>	<input type="radio"/>	<input checked="" type="radio"/>	<input type="checkbox"/>
3	<input type="radio"/>	<input type="radio"/>	<input checked="" type="radio"/>	<input type="checkbox"/>
4	<input type="radio"/>	<input type="radio"/>	<input checked="" type="radio"/>	<input type="checkbox"/>
5	<input type="radio"/>	<input type="radio"/>	<input checked="" type="radio"/>	<input type="checkbox"/>
6	<input type="radio"/>	<input type="radio"/>	<input checked="" type="radio"/>	<input type="checkbox"/>
7	<input type="radio"/>	<input type="radio"/>	<input checked="" type="radio"/>	<input type="checkbox"/>

Figure 261 SWITCHING > Multicast > MVR > Add/Edit (Stacking Mode)

Active OFF

Group Name

Multicast VLAN ID

802.1p Priority

Mode Dynamic Compatible

SLOT 1

Port	Source Port	Receiver Port	None	Tagging
1/*		None		<input type="checkbox"/>
1/1	<input type="radio"/>	<input type="radio"/>	<input checked="" type="radio"/>	<input type="checkbox"/>
1/2	<input type="radio"/>	<input type="radio"/>	<input checked="" type="radio"/>	<input type="checkbox"/>
1/3	<input type="radio"/>	<input type="radio"/>	<input checked="" type="radio"/>	<input type="checkbox"/>
1/4	<input type="radio"/>	<input type="radio"/>	<input checked="" type="radio"/>	<input type="checkbox"/>
1/5	<input type="radio"/>	<input type="radio"/>	<input checked="" type="radio"/>	<input type="checkbox"/>
1/6	<input type="radio"/>	<input type="radio"/>	<input checked="" type="radio"/>	<input type="checkbox"/>
1/7	<input type="radio"/>	<input type="radio"/>	<input checked="" type="radio"/>	<input type="checkbox"/>

The following table describes the related labels in this screen.

Table 160 SWITCHING > Multicast > MVR > Add/Edit

LABEL	DESCRIPTION
Active	Enable the switch button to enable MVR to allow one single multicast VLAN to be shared among different subscriber VLANs on the network.
Group Name	Enter a descriptive name (up to 32 printable ASCII characters except [?], [], ['], ["], or [,]) for identification purposes.
Multicast VLAN ID	Enter the VLAN ID (1 to 4094) of the multicast VLAN.
802.1p Priority	Select a priority level (0 – 7) with which the Switch replaces the priority in outgoing IGMP or MLD control packets (belonging to this multicast VLAN).
Mode	Specify the MVR mode on the Switch. Choices are Dynamic and Compatible . Select Dynamic to send IGMP reports or MLD messages to all MVR source ports in the multicast VLAN. Select Compatible to set the Switch not to send IGMP reports or MLD messages.
Use this section to configure MVR settings on each port.	
SLOT	This field appears only in Stacking mode. Click the drop-down list to choose the slot number of the Switch in a stack.
Port	This field displays the port number. In Stacking mode, the first number represents the slot ID and the second is the port number. Please note that the default stacking ports (the last four ports of your Switch) cannot be configured. They are reserved for stacking only.
*	Settings in this row apply to all ports. Use this row only if you want to make some settings the same for all ports. Use this row first to set the common settings and then make adjustments on a port-by-port basis. Changes in this row are copied to all the ports as soon as you make them.
Source Port	Select this option to set this port as the MVR source port that sends and receives multicast traffic. All source ports must belong to a single multicast VLAN.
Receiver Port	Select this option to set this port as a receiver port that only receives multicast traffic.
None	Select this option to set the port not to participate in MVR. No MVR multicast traffic is sent or received on this port.
Tagging	Select this check box if you want the port to tag the VLAN ID in all outgoing frames transmitted.
Apply	Click Apply to save your changes to the Switch's run-time memory. The Switch loses these changes if it is turned off or loses power, so use the Save link on the top navigation panel to save your changes to the non-volatile memory when you are done configuring.
Clear	Click Clear to clear the fields to the factory defaults.
Cancel	Click Cancel to not save the configuration you make and return to the last screen.

46.13 MVR Group Setup

All source ports and receiver ports belonging to a multicast group can receive multicast data sent to this multicast group.

Use this screen to view and configure MVR IP multicast group settings. Click **SWITCHING > Multicast > MVR > Group Setup** to access this screen.

Note: A port can belong to more than one multicast VLAN. However, IP multicast group addresses in different multicast VLANs cannot overlap.

Figure 262 SWITCHING > Multicast > MVR > Group Setup

<input type="checkbox"/>	MVLAN	Group Name	Start Address	End Address
<input type="checkbox"/>	5			
<input type="checkbox"/>		Group1	224.0.0.0	224.0.0.0
<input type="checkbox"/>		Group2	ff02::1	ff02::1
<input type="checkbox"/>	6			
<input type="checkbox"/>		Group3	ff02::2	ff02::2

The following table describes the labels in this screen.

Table 161 SWITCHING > Multicast > MVR > Group Setup

LABEL	DESCRIPTION
MVLAN	This field displays the multicast VLAN ID.
Group Name	This field displays the descriptive name for this setting.
Start Address	This field displays the starting IP address of the multicast group.
End Address	This field displays the ending IP address of the multicast group.
	Select an entry's check box to select a specific entry. Otherwise, select the check box in the table heading row to select all entries.
Add/Edit	Click Add/Edit to add a new multicast group or edit a selected one.
Delete	Select the group entries that you want to remove, then click Delete to delete the selected multicast groups. If you delete a multicast VLAN, all multicast groups in this VLAN will also be removed.

46.13.1 Add/Edit MVR Group

Use this screen to configure MVR IP multicast group addresses. To access this screen, click the **Add/Edit** button or select an entry from the list and click the **Add/Edit** button.

Figure 263 SWITCHING > Multicast > MVR > Group Setup > Add/Edit

The following table describes the labels in this screen.

Table 162 SWITCHING > Multicast > MVR > Group Setup > Add/Edit

LABEL	DESCRIPTION
Multicast VLAN ID	Select a multicast VLAN ID (that you configured in the MVR screen) from the drop-down list box.
Group Name	Enter a descriptive name for identification purposes. You can enter up to 32 printable ASCII characters except [?], [], ['], ["] or [,].
Start Address	Enter the starting IP multicast address of the multicast group in dotted decimal notation.
End Address	Enter the ending IP multicast address of the multicast group in dotted decimal notation. Enter the same IP address as the Start Address field if you want to configure only one IP address for a multicast group.
Apply	Click Apply to save your changes to the Switch's run-time memory. The Switch loses these changes if it is turned off or loses power, so use the Save link on the top navigation panel to save your changes to the non-volatile memory when you are done configuring.
Clear	Click Clear to clear the fields to the factory defaults.
Cancel	Click Cancel to not save the configuration you make and return to the last screen.

46.13.2 MVR Configuration Example

The following figure shows a network example where ports 1, 2 and 3 on the Switch belong to VLAN 1. In addition, port 7 belongs to the multicast group with VID 200 to receive multicast traffic (the **News** and **Movie** channels) from the remote streaming media server, **S**. Computers A, B and C in VLAN 1 are able to receive the traffic.

Figure 264 MVR Configuration Example

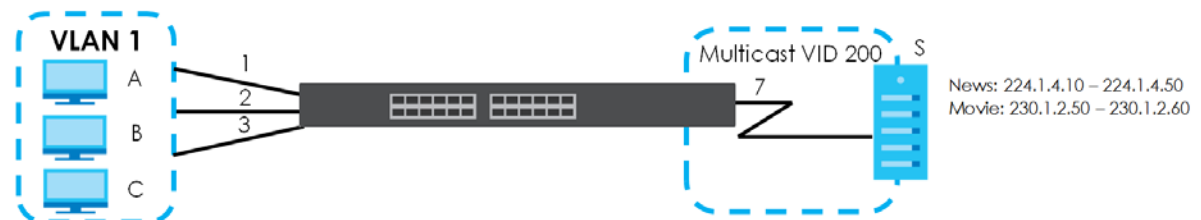

To configure the MVR settings on the Switch, click the **Add/Edit** button in the **SWITCHING > Multicast > MVR** screen. Create a multicast VLAN and set the receiver and source ports.

Figure 265 MVR Configuration Example

Active ON

Group Name

Multicast VLAN ID

802.1p Priority

Mode Dynamic Compatible

Port	Source Port	Receiver Port	None	Tagging
*		Receiver Port ▼		<input type="checkbox"/>
1	<input type="radio"/>	<input checked="" type="radio"/>	<input type="radio"/>	<input type="checkbox"/>
2	<input type="radio"/>	<input checked="" type="radio"/>	<input type="radio"/>	<input type="checkbox"/>
3	<input type="radio"/>	<input checked="" type="radio"/>	<input type="radio"/>	<input type="checkbox"/>
4	<input type="radio"/>	<input type="radio"/>	<input checked="" type="radio"/>	<input type="checkbox"/>
5	<input type="radio"/>	<input type="radio"/>	<input checked="" type="radio"/>	<input type="checkbox"/>
6	<input type="radio"/>	<input type="radio"/>	<input checked="" type="radio"/>	<input type="checkbox"/>
7	<input checked="" type="radio"/>	<input type="radio"/>	<input type="radio"/>	<input checked="" type="checkbox"/>
8	<input type="radio"/>	<input checked="" type="radio"/>	<input type="radio"/>	<input type="checkbox"/>

To set the Switch to forward the multicast group traffic to the subscribers, click **Add/Edit** in the **SWITCHING > Multicast > MVR > Group Setup** screen and configure multicast group settings. The following figure shows an example where two IPv4 multicast groups (**News** and **Movie**) are configured for the multicast VLAN 200.

Figure 266 MVR Group Configuration Example – Add

Multicast VLAN ID

Group Name

Start Address

End Address

Figure 267 MVR Group Configuration Example – View

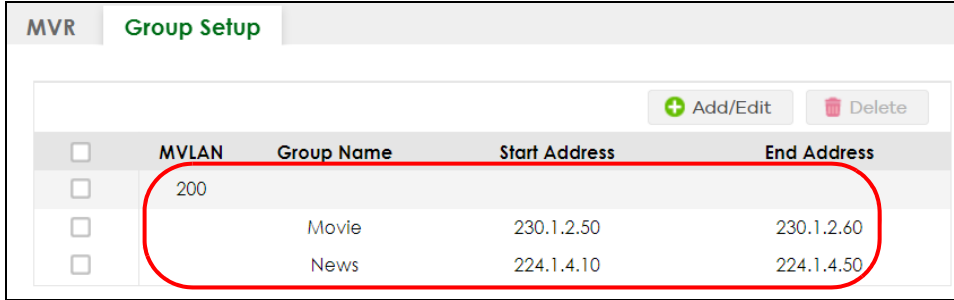

The screenshot shows a web interface for MVR Group Setup. At the top, there are tabs for 'MVR' and 'Group Setup'. Below the tabs, there are two buttons: '+ Add/Edit' and 'Delete'. A table below contains the configuration data. A red circle highlights the first three rows of the table, including the header row and the first two data rows.

<input type="checkbox"/>	MVLAN	Group Name	Start Address	End Address
<input type="checkbox"/>	200			
<input type="checkbox"/>		Movie	230.1.2.50	230.1.2.60
<input type="checkbox"/>		News	224.1.4.10	224.1.4.50

CHAPTER 47

Static Multicast Forwarding

47.1 Static Multicast Forwarding Overview

This chapter discusses how to configure static multicast forwarding rules based on multicast MAC addresses or multicast IPv4 addresses.

Use these screens to configure static multicast address forwarding by defining the ports and VLANs that multicast traffic can pass through the Switch. If a subscriber is on a different port or VLAN, then the subscriber will not get the multicast.

47.1.1 What You Can Do

Use the **Static Multicast Forwarding By MAC** screen ([Section 47.2 on page 347](#)) to configure rules to forward specific multicast frames, such as streaming or control frames, to specific ports.

Use the **Static Multicast Forwarding By IP** screen ([Section 47.3 on page 349](#)) to configure static multicast IPv4 addresses for ports to receive the multicast stream.

47.1.2 What You Need To Know

A multicast MAC address or multicast IP address is the MAC address or IP address of a multicast group, and not a receiving device.

A static multicast address is a multicast MAC address or multicast IPv4 address that has been manually entered in the multicast table. This identifies the destination of the multicast content. Multicast IPv4 addresses use the Class D IP addresses range 224.0.0.0 to 239.255.255.255. Multicast MAC addresses have a "1" as the last binary bit of the first octet pair (for example, 01:00:5e:00:00:0A). Static multicast addresses do not age out. See [IP Multicast Addresses on page 316](#) for more information on IP multicast addresses.

Note: Static (manual) multicast forwarding allows you (the administrator) to forward multicast frames to a member without the member having to join the group first.

If a multicast group has no members, then the Switch cannot forward to specific ports unless you configure static (manual) multicast entries. The Switch will either flood the multicast frames to all ports (default) or drop them. [Figure 268 on page 347](#) shows such unknown multicast frames flooded to all ports. With static multicast forwarding, you can forward these multicasts to ports within a VLAN group.

Figure 268 No Multicast Forwarding

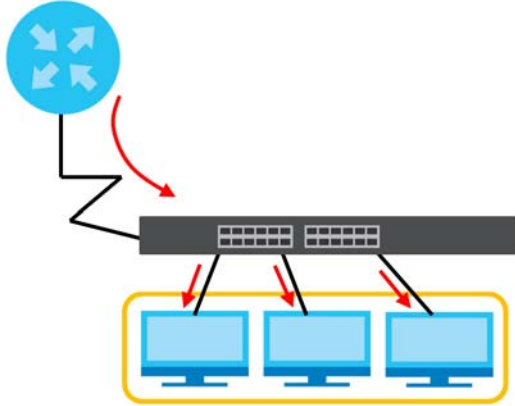

47.2 Static Multicast Forwarding By MAC

Use this screen to view and configure static multicast MAC addresses for ports to receive the multicast stream. Click **SWITCHING > Multicast > Static Multicast Forwarding By MAC** to display the screen as shown next.

Figure 269 SWITCHING > Multicast > Static Multicast Forwarding By MAC

Static Multicast Forwarding By MAC						
<input type="checkbox"/>	Index	Active	Name	MAC Address	VID	Port
+ Add/Edit Delete						

The following table describes the labels in this screen.

Table 163 SWITCHING > Multicast > Static Multicast Forwarding By MAC

LABEL	DESCRIPTION
Index	This is the index number of the static multicast MAC address rule.
Active	This field displays whether a static multicast MAC address forwarding rule is active or not. You may temporarily deactivate a rule without deleting it.
Name	This field displays the descriptive name for identification purposes for a static multicast MAC address-forwarding rule.
MAC Address	This field displays the multicast MAC address that identifies a multicast group.
VID	This field displays the ID number of a VLAN group to which frames containing the specified multicast MAC address will be forwarded.
Port	This field displays the ports within an identified VLAN group to which frames containing the specified multicast MAC address will be forwarded. In Stacking mode, the first number represents the slot ID and the second is the port number.
	Select an entry's check box to select a specific entry. Otherwise, select the check box in the table heading row to select all entries.
Add/Edit	Click Add/Edit to add a new rule or edit a selected one.
Delete	Click Delete to remove the selected rules.

47.2.1 Add/Edit Static Multicast Forwarding By MAC

Use this screen to add a static multicast MAC address rule for ports to receive the multicast stream.

Click **Add/Edit**, or select an entry and click **Add/Edit** in the **SWITCHING > Multicast > Static Multicast Forwarding By MAC** to display this screen.

Figure 270 SWITCHING > Multicast > Static Multicast Forwarding By MAC > Add/Edit

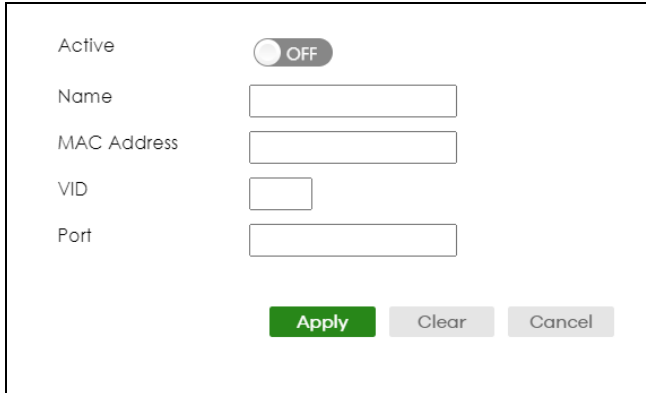

The following table describes the labels in this screen.

Table 164 SWITCHING > Multicast > Static Multicast Forwarding By MAC > Add/Edit

LABEL	DESCRIPTION
Active	Enable the switch button to activate your rule. You may temporarily deactivate a rule without deleting it by disabling the switch.
Name	Enter a descriptive name (up to 32 printable ASCII characters except [?], [], ['], ["] or [,]) for this static multicast MAC address forwarding rule. This is for identification only.
MAC Address	Enter a multicast MAC address which identifies the multicast group. The last binary bit of the first octet pair in a multicast MAC address must be 1. For example, the first octet pair 00000001 is 01 in hexadecimal, so 01:00:5e:00:00:0A and 01:00:5e:00:00:27 are valid multicast MAC addresses.
VID	You can forward frames with matching destination multicast MAC address to ports within a VLAN group. Enter the ID that identifies the VLAN group here. If you do NOT have a specific target VLAN, enter 1.
Port	Enter the ports where frames with destination MAC address that matched the entry above are forwarded. You can enter multiple ports separated by (no space) comma (,) or hyphen (-) for a range. For example, enter "3-5" for ports 3, 4, and 5. Enter "3,5,7" for ports 3, 5, and 7. In Stacking mode, the first number represents the slot ID and the second is the port number. Enter "1/1-1/24,2/23" for ports 1 to 24 for the Switch in slot 1 and port 23 for the Switch in slot 2, for example.
Apply	Click Apply to save your changes to the Switch's run-time memory. The Switch loses these changes if it is turned off or loses power, so use the Save link on the top navigation panel to save your changes to the non-volatile memory when you are done configuring.
Clear	Click Clear to clear the fields to the factory defaults.
Cancel	Click Cancel to not save the configuration you make and return to the last screen.

47.3 Configure a Static Multicast IPv4 Address

Use this screen to configure static multicast IPv4 addresses for ports to receive the multicast stream. Click **SWITCHING > Multicast > Static Multicast Forwarding By IP** to display the screen as shown next.

Figure 271 SWITCHING > Multicast > Static Multicast Forwarding By IP

The following table describes the labels in this screen.

Table 165 SWITCHING > Multicast > Static Multicast Forwarding By IP

LABEL	DESCRIPTION
Index	This is the index number of the static multicast IP address rule.
Name	This field displays the descriptive name for identification purposes for a static multicast IP address-forwarding rule.
IP Address	This field displays the multicast IP address that identifies a multicast group.
VID	This field displays the ID number of a VLAN group to which frames containing the specified multicast IP address will be forwarded.
Port	This field displays the ports within an identified VLAN group to which frames containing the specified multicast IP address will be forwarded.
	Select an entry's check box to select a specific entry. Otherwise, select the check box in the table heading row to select all entries.
Add/Edit	Click Add/Edit to add a new rule or edit a selected one.
Delete	Click Delete to remove the selected rules.

47.3.1 Add/Edit a Static Multicast Address By IP

Use this screen to configure ports and VLAN to receive the multicast stream with this multicast IPv4 address.

Click **Add/Edit**, or select an entry and click **Add/Edit** in the **SWITCHING > Multicast > Static Multicast Forwarding By IP** to display this screen.

Figure 272 SWITCHING > Multicast > Static Multicast Forwarding By IP > Add/Edit

The following table describes the labels in this screen.

Table 166 SWITCHING > Multicast > Static Multicast Forwarding By IP > Add/Edit

LABEL	DESCRIPTION
Name	Enter a descriptive name (up to 32 printable ASCII characters except [?], [], ['], ["] or [,]) for this static multicast IPv4 address forwarding rule. This is for identification only.
IP Address	Enter a multicast IPv4 address (224.0.0.0 – 239.255.255.255) which identifies the multicast group.
VID	You can forward frames with matching destination multicast IPv4 address to ports within a VLAN group. Enter the ID that identifies the VLAN group here. If you do NOT have a specific target VLAN, enter 1.
Port	Enter the ports where frames with destination multicast IPv4 address that matched the entry above are forwarded. You can enter multiple ports separated by (no space) comma (,) or hyphen (-). For example, enter "3-5" for ports 3, 4, and 5. Enter "3,5,7" for ports 3, 5, and 7.
Apply	Click Apply to save your changes to the Switch's run-time memory. The Switch loses these changes if it is turned off or loses power, so use the Save link on the top navigation panel to save your changes to the non-volatile memory when you are done configuring.
Clear	Click Clear to clear the fields to the factory defaults.
Cancel	Click Cancel to not save the configuration you make and return to the last screen.

CHAPTER 48

PPPoE

48.1 PPPoE Intermediate Agent Overview

This chapter describes how the Switch gives a PPPoE termination server additional information that the server can use to identify and authenticate a PPPoE client.

A PPPoE Intermediate Agent (PPPoE IA) is deployed between a PPPoE server and PPPoE clients. It helps the PPPoE server identify and authenticate clients by adding subscriber line specific information to PPPoE discovery packets from clients on a per-port or per-port-per-VLAN basis before forwarding them to the PPPoE server.

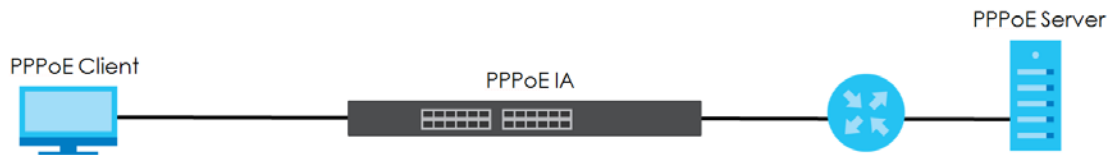

48.1.1 What You Can Do

- Use the **PPPoE Intermediate Agent** screen ([Section 48.2 on page 353](#)) to enable the PPPoE Intermediate Agent on the Switch.
- Use the **PPPoE IA Port** screen ([Section 48.3 on page 355](#)) to set the port state and configure PPPoE intermediate agent sub-options on a per-port basis.
- Use the **PPPoE IA Port VLAN** screen ([Section 48.4 on page 356](#)) to configure PPPoE IA settings that apply to a specific VLAN on a port.
- Use the **PPPoE IA VLAN** ([Section 48.5 on page 358](#)) to enable the PPPoE Intermediate Agent on a VLAN.

48.1.2 What You Need to Know

Read on for concepts on ARP that can help you configure the screen in this chapter.

48.1.2.1 PPPoE Intermediate Agent Tag Format

If the PPPoE Intermediate Agent is enabled, the Switch adds a vendor-specific tag to PADI (PPPoE Active Discovery Initialization) and PADR (PPPoE Active Discovery Request) packets from PPPoE clients.

This tag is defined in RFC 2516 and has the following format for this feature.

Table 167 PPPoE Intermediate Agent Vendor-specific Tag Format

Tag_Type (0x0105)	Tag_Len	Value	i1	i2
----------------------	---------	-------	----	----

The Tag_Type is 0x0105 for vendor-specific tags, as defined in RFC 2516. The Tag_Len indicates the length of Value, i1 and i2. The Value is the 32-bit number 0x00000DE9, which stands for the "ADSL Forum" IANA entry. i1 and i2 are PPPoE intermediate agent sub-options, which contain additional information about the PPPoE client.

48.1.2.2 Sub-Option Format

There are two types of sub-option: "Agent Circuit ID Sub-option" and "Agent Remote ID Sub-option". They have the following formats.

Table 168 PPPoE IA Circuit ID Sub-option Format: User-defined String

SubOpt	Length	Value
0x01 (1 byte)	N (1 byte)	String (63 bytes)

Table 169 PPPoE IA Remote ID Sub-option Format

SubOpt	Length	Value
0x02 (1 byte)	N (1 byte)	MAC Address or String (63 bytes)

The 1 in the first field identifies this as an Agent Circuit ID sub-option and 2 identifies this as an Agent Remote ID sub-option. The next field specifies the length of the field. The Switch takes the Circuit ID string you manually configure for a VLAN on a port as the highest priority and the Circuit ID string for a port as the second priority. In addition, the Switch puts the PPPoE client's MAC address into the Agent Remote ID Sub-option if you do not specify any user-defined string.

Flexible Circuit ID Syntax with Identifier String and Variables

If you do not configure a Circuit ID string for a VLAN on a specific port or for a specific port, the Switch adds the user-defined identifier string and variables into the Agent Circuit ID Sub-option. The variables can be the slot ID of the PPPoE client, the port number of the PPPoE client and/or the VLAN ID on the PPPoE packet.

The identifier-string, slot ID, port number and VLAN ID are separated from each other by a pound key (#), semi-colon (;), period (.), comma (,), forward slash (/) or space. An Agent Circuit ID Sub-option example is "Switch/07/0123" and indicates the PPPoE packets come from a PPPoE client which is connected to the Switch's port 7 and belong to VLAN 123.

Table 170 PPPoE IA Circuit ID Sub-option Format: Using Identifier String and Variables

SubOpt	Length	Value						
0x01 (1 byte)	N (1 byte)	Identifier String (53 bytes)	delimiter (1 byte)	Slot ID (1 byte)	delimiter (1 byte)	Port No (2 byte)	delimiter (1 byte)	VLAN ID (4 bytes)

WT-101 Default Circuit ID Syntax

If you do not configure a Circuit ID string for a specific VLAN on a port or for a specific port, and disable the flexible Circuit ID syntax in the **PPPoE > Intermediate Agent** screen, the Switch automatically generates a Circuit ID string according to the default Circuit ID syntax which is defined in the DSL Forum Working Text (WT)-101. The default access node identifier is the host name of the PPPoE intermediate agent and the eth indicates "Ethernet".

Table 171 PPPoE IA Circuit ID Sub-option Format: Defined in WT-101

SubOpt	Length	Value									
0x01 (1 byte)	N (1 byte)	Access Node Identifier (20 byte)	Space (1 byte)	eth (3 byte)	Space (1 byte)	Slot ID (1 byte)	/ (1 byte)	Port No (2 byte)	:	(1 byte)	VLAN ID (4 bytes)

48.1.2.3 Port State

Every port is either a trusted port or an untrusted port for the PPPoE intermediate agent. This setting is independent of the trusted or untrusted setting for DHCP snooping or ARP inspection. You can also specify the agent sub-options (circuit ID and remote ID) that the Switch adds to PADI and PADR packets from PPPoE clients.

Trusted ports are connected to PPPoE servers.

- If a PADO (PPPoE Active Discovery Offer), PADS (PPPoE Active Discovery Session-confirmation), or PADT (PPPoE Active Discovery Terminate) packet is sent from a PPPoE server and received on a trusted port, the Switch forwards it to all other ports.
- If a PADI or PADR packet is sent from a PPPoE client but received on a trusted port, the Switch forwards it to other trusted ports.

Note: The Switch will drop all PPPoE discovery packets if you enable the PPPoE intermediate agent and there are no trusted ports.

Untrusted ports are connected to subscribers.

- If a PADI, PADR, or PADT packet is sent from a PPPoE client and received on an untrusted port, the Switch adds a vendor-specific tag to the packet and then forwards it to the trusted ports.
- The Switch discards PADO and PADS packets which are sent from a PPPoE server but received on an untrusted port.

48.2 PPPoE Intermediate Agent

Use this screen to configure the Switch to give a PPPoE termination server additional subscriber information that the server can use to identify and authenticate a PPPoE client.

Click **SWITCHING > PPPoE Intermediate Agent** to display the screen as shown.

Figure 273 SWITCHING > PPPoE Intermediate Agent > PPPoE Intermediate Agent

The following table describes the labels in this screen.

Table 172 SWITCHING > PPPoE Intermediate Agent > PPPoE Intermediate Agent

LABEL	DESCRIPTION
PPPoE Intermediate Agent	
Active	Enable the switch button to enable the PPPoE intermediate agent globally on the Switch.
Access-Node-Identifier	Enter up to 20 ASCII printable characters (except [?], [], ['], ["], or [,]) to identify the PPPoE intermediate agent. Hyphens (-) and spaces are also allowed. The default is the Switch's host name.
Circuit-ID	
Use this section to configure the Circuit ID field in the PADI and PADR packets.	
The Circuit ID you configure for a specific port (in the SWITCHING > PPPoE Intermediate Agent > PPPoE IA Port screen) or for a specific VLAN on a port (in the SWITCHING > PPPoE Intermediate Agent > PPPoE IA Port VLAN screen) has priority over this. That means, if you also want to configure PPPoE IA Per-Port or Per-Port Per-VLAN setting, leave the fields here empty and configure circuit-id and remote-id in the Per-Port or Per-Port Per-VLAN screen.	
Active	Enable the switch button to have the Switch add the user-defined identifier string and variables (specified in the Option field) to PADI or PADR packets from PPPoE clients. If you leave this option unselected and do not configure any Circuit ID string (using CLI commands) on the Switch, the Switch will use the string specified in the Access-Node-Identifier field.
Identifier-String	Specify a string that the Switch adds in the Agent Circuit ID sub-option. You can enter up to 53 printable ASCII characters (except [?], [], ['], ["], or [,]). Spaces are allowed.
Option	Select the variables that you want the Switch to generate and add in the Agent Circuit ID sub-option. The variable options include sp , sv , pv and spv which indicate combinations of slot-port, slot-VLAN, port-VLAN and slot-port-VLAN respectively. The Switch enters a zero into the PADI and PADR packets for the slot value.
Delimiter	Select a delimiter to separate the identifier-string, slot ID, port number and/or VLAN ID from each other. You can use a pound key (#), semi-colon (:), period (.), comma (,), forward slash (/) or space.
Apply	Click Apply to save your changes to the Switch's run-time memory. The Switch loses these changes if it is turned off or loses power, so use the Save link on the top navigation panel to save your changes to the non-volatile memory when you are done configuring.
Cancel	Click Cancel to begin configuring this screen afresh.

48.3 PPPoE IA Port

Use this screen to specify whether individual ports are trusted or untrusted ports and have the Switch add extra information to PPPoE discovery packets from PPPoE clients on a per-port basis.

Note: The Switch will drop all PPPoE packets if you enable the PPPoE Intermediate Agent on the Switch and there are no trusted ports.

Click the **SWITCHING > PPPoE Intermediate Agent > PPPoE IA Port** screen to display the screen as shown.

Figure 274 SWITCHING > PPPoE Intermediate Agent > PPPoE IA Port (Standalone Mode)

Port	Server Trusted State	Circuit-ID	Remote-ID
*	Untrusted ▼		
1	Untrusted ▼		
2	Untrusted ▼		
3	Untrusted ▼		
4	Untrusted ▼		
5	Untrusted ▼		
6	Untrusted ▼		
7	Untrusted ▼		

Figure 275 SWITCHING > PPPoE Intermediate Agent > PPPoE IA Port (Stacking Mode)

SLOT 1 ▼

Port	Server Trusted State	Circuit-ID	Remote-ID
1/*	Untrusted ▼		
1/1	Untrusted ▼		
1/2	Untrusted ▼		
1/3	Untrusted ▼		
1/4	Untrusted ▼		
1/5	Untrusted ▼		
1/6	Untrusted ▼		
1/7	Untrusted ▼		

The following table describes the labels in this screen.

Table 173 SWITCHING > PPPoE Intermediate Agent > PPPoE IA Port

LABEL	DESCRIPTION
SLOT	This field appears only in Stacking mode. Click the drop-down list to choose the slot number of the Switch in a stack.
Port	This field displays the port number. In Stacking mode, the first number represents the slot ID and the second is the port number. Please note that the default stacking ports (the last four ports of your Switch) cannot be configured. They are reserved for stacking only.
*	Use this row to make the setting the same for all ports. Use this row first and then make adjustments on a port-by-port basis. Changes in this row are copied to all the ports as soon as you make them.
Server Trusted State	Select whether this port is a trusted port (Trusted) or an untrusted port (Untrusted). Trusted ports are uplink ports connected to PPPoE servers. If a PADO (PPPoE Active Discovery Offer), PADS (PPPoE Active Discovery Session-confirmation), or PADT (PPPoE Active Discovery Terminate) packet is sent from a PPPoE server and received on a trusted port, the Switch forwards it to all other ports. If a PADI or PADR packet is sent from a PPPoE client but received on a trusted port, the Switch forwards it to other trusted ports. Untrusted ports are downlink ports connected to subscribers. If a PADI, PADR, or PADT packet is sent from a PPPoE client and received on an untrusted port, the Switch adds a vendor-specific tag to the packet and then forwards it to the trusted ports. The Switch discards PADO and PADS packets which are sent from a PPPoE server but received on an untrusted port.
Circuit-ID	Enter a string of up to 63 ASCII characters (except [?], [], ['], ["], or [,]) that the Switch adds into the Agent Circuit ID sub-option for PPPoE discovery packets received on this port. Spaces are allowed. The Circuit ID you configure for a specific VLAN on a port (in the SWITCHING > PPPoE Intermediate Agent > PPPoE IA Port VLAN screen) has the highest priority.
Remote-ID	Enter a string of up to 63 ASCII characters (except [?], [], ['], ["], or [,]) that the Switch adds into the Agent Remote ID sub-option for PPPoE discovery packets received on this port. Spaces are allowed. If you do not specify a string here or in the Remote-ID field for a VLAN on a port, the Switch automatically uses the PPPoE client's MAC address. The Remote ID you configure for a specific VLAN on a port (in the SWITCHING > PPPoE Intermediate Agent > PPPoE IA Port VLAN screen) has the highest priority.
Apply	Click Apply to save your changes to the Switch's run-time memory. The Switch loses these changes if it is turned off or loses power, so use the Save link on the top navigation panel to save your changes to the non-volatile memory when you are done configuring.
Cancel	Click Cancel to begin configuring this screen afresh.

48.4 PPPoE IA Port VLAN

Use this screen to configure PPPoE IA settings that apply to a specific VLAN on a port.

Click **SWITCHING > PPPoE Intermediate Agent > PPPoE IA Port VLAN** to display the screen as shown.

Figure 276 SWITCHING > PPPoE Intermediate Agent > PPPoE IA Port VLAN (Standalone Mode)

Figure 277 SWITCHING > PPPoE Intermediate Agent > PPPoE IA Port VLAN (Stacking Mode)

The following table describes the labels in this screen.

Table 174 SWITCHING > PPPoE Intermediate Agent > PPPoE IA Port VLAN

LABEL	DESCRIPTION
Show Port	
Port	Enter a port number to show the PPPoE Intermediate Agent settings for the specified VLANs on the port. In Stacking mode, the first field is the slot ID and the second field is the port number.
Show VLAN	
	Use this section to specify the VLANs you want to configure in the section below.
Start VID	Enter the lowest VLAN ID you want to configure in the section below.
End VID	Enter the highest VLAN ID you want to configure in the section below.
Apply	Click Apply to display the specified range of VLANs in the section below.
Port:	This field displays the port number specified above.
Slot / Port	In Stacking mode, it displays the slot ID and port number specified above.
VID	This field displays the VLAN ID of each VLAN in the range specified above. If you configure the * VLAN, the settings are applied to all VLANs.

Table 174 SWITCHING > PPPoE Intermediate Agent > PPPoE IA Port VLAN (continued)

LABEL	DESCRIPTION
*	Use this row to make the setting the same for all VLANs. Use this row first and then make adjustments on a VLAN-by-VLAN basis. Changes in this row are copied to all the VLANs as soon as you make them.
Circuit-ID	Enter a string of up to 63 ASCII characters (except [?], [], ['], ["], or [,]) that the Switch adds into the Agent Circuit ID sub-option for this VLAN on the specified port. Spaces are allowed. The Circuit ID you configure here has the highest priority.
Remote-ID	Enter a string of up to 63 ASCII characters (except [?], [], ['], ["], or [,]) that the Switch adds into the Agent Remote ID sub-option for this VLAN on the specified port. Spaces are allowed. If you do not specify a string here or in the Remote-ID field for a specific port, the Switch automatically uses the PPPoE client's MAC address. The Remote ID you configure here has the highest priority.
Apply	Click Apply to save your changes to the Switch's run-time memory. The Switch loses these changes if it is turned off or loses power, so use the Save link on the top navigation panel to save your changes to the non-volatile memory when you are done configuring.
Cancel	Click Cancel to begin configuring this screen afresh.

48.5 PPPoE IA VLAN

Use this screen to set whether the PPPoE Intermediate Agent is enabled on a VLAN and whether the Switch appends the Circuit ID and/or Remote ID to PPPoE discovery packets from a specific VLAN.

Click **SWITCHING > PPPoE Intermediate Agent > PPPoE IA VLAN** to display the screen as shown.

Figure 278 SWITCHING > PPPoE Intermediate Agent > PPPoE IA VLAN

The following table describes the labels in this screen.

Table 175 SWITCHING > PPPoE Intermediate Agent > PPPoE IA VLAN

LABEL	DESCRIPTION
Show VLAN	Use this section to specify the VLANs you want to configure in the section below.
Start VID	Enter the lowest VLAN ID you want to configure in the section below.
End VID	Enter the highest VLAN ID you want to configure in the section below.

Table 175 SWITCHING > PPPoE Intermediate Agent > PPPoE IA VLAN (continued)

LABEL	DESCRIPTION
Apply	Click Apply to display the specified range of VLANs in the section below.
VID	This field displays the VLAN ID of each VLAN in the range specified above. If you configure the * VLAN, the settings are applied to all VLANs.
*	Use this row to make the setting the same for all VLANs. Use this row first and then make adjustments on a VLAN-by-VLAN basis. Changes in this row are copied to all the VLANs as soon as you make them.
Enabled	Select this option to turn on the PPPoE Intermediate Agent on a VLAN.
Circuit-ID	Select this option to make the Circuit ID settings for a specific VLAN take effect.
Remote-ID	Select this option to make the Remote ID settings for a specific VLAN take effect.
Apply	Click Apply to save your changes to the Switch's run-time memory. The Switch loses these changes if it is turned off or loses power, so use the Save link on the top navigation panel to save your changes to the non-volatile memory when you are done configuring.
Cancel	Click Cancel to begin configuring this screen afresh.

CHAPTER 49

Differentiated Services

49.1 DiffServ Overview

This chapter shows you how to configure Differentiated Services (DiffServ) on the Switch.

Quality of Service (QoS) is used to prioritize source-to-destination traffic flows. All packets in the flow are given the same priority. You can use CoS (class of service) to give different priorities to different packet types.

DiffServ is a class of service (CoS) model that marks packets so that they receive specific per-hop treatment at DiffServ-compliant network devices along the route based on the application types and traffic flow. Packets are marked with DiffServ Code Points (DSCPs) indicating the level of service desired. This allows the intermediary DiffServ-compliant network devices to handle the packets differently depending on the code points without the need to negotiate paths or remember state information for every flow. In addition, applications do not have to request a particular service or give advanced notice of where the traffic is going.

49.1.1 What You Can Do

- Use the **Diffserv** screen ([Section 49.1 on page 360](#)) to activate DiffServ to apply marking rules or IEEE 802.1p priority mapping on the Switch.
- Use the **DSCP Setting** screen ([Section 49.3.1 on page 363](#)) to change the DSCP-IEEE 802.1p mapping.

49.1.2 What You Need to Know

Read on for concepts on Differentiated Services that can help you configure the screens in this chapter.

DSCP and Per-Hop Behavior

DiffServ defines a new DS (Differentiated Services) field to replace the Type of Service (ToS) field in the IP header. The DS field contains a 6-bit DSCP field which can define up to 64 service levels and the remaining 2 bits are defined as currently unused (CU). The following figure illustrates the DS field.

Figure 279 DiffServ: Differentiated Service Field

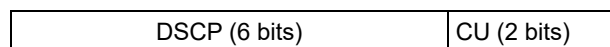

DSCP is backward compatible with the three precedence bits in the ToS octet so that non-DiffServ compliant, ToS-enabled network device will not conflict with the DSCP mapping.

The DSCP value determines the PHB (Per-Hop Behavior), that each packet gets as it is forwarded across the DiffServ network. Based on the marking rule different kinds of traffic can be marked for different

priorities of forwarding. Resources can then be allocated according to the DSCP values and the configured policies.

DiffServ Network Example

The following figure depicts a DiffServ network consisting of a group of directly connected DiffServ-compliant network devices. The boundary node (**A** in Figure 280) in a DiffServ network classifies (marks with a DSCP value) the incoming packets into different traffic flows (**Platinum, Gold, Silver, Bronze**) based on the configured marking rules. A network administrator can then apply various traffic policies to the traffic flows. An example traffic policy, is to give higher drop precedence to one traffic flow over others. In our example, packets in the **Bronze** traffic flow are more likely to be dropped when congestion occurs than the packets in the **Platinum** traffic flow as they move across the DiffServ network.

Figure 280 DiffServ Network

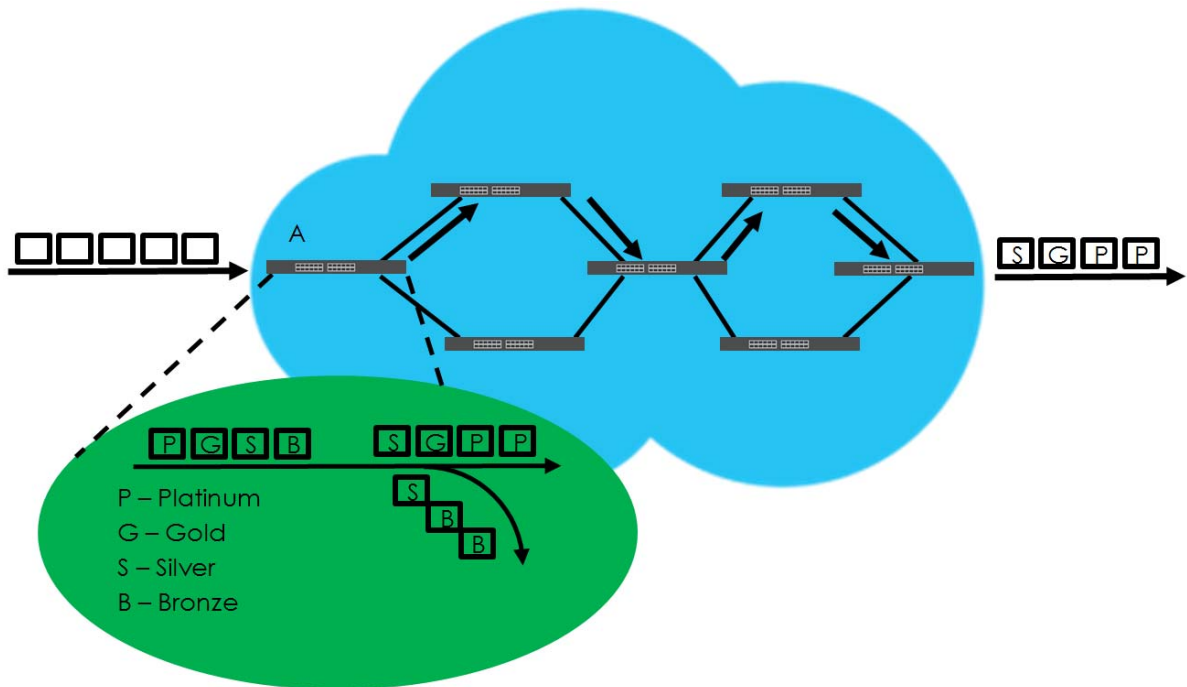

49.2 Activating DiffServ

Activate DiffServ to apply marking rules or IEEE 802.1p priority mapping on the selected ports.

Click **SWITCHING** > **QoS** > **Diffserv** to display the screen as shown.

Figure 281 SWITCHING > QoS > Diffserv (Standalone Mode)

Diffserv DSCP Setting

Active OFF

Port	Active
*	<input type="checkbox"/>
1	<input type="checkbox"/>
2	<input type="checkbox"/>
3	<input type="checkbox"/>
4	<input type="checkbox"/>
5	<input type="checkbox"/>
6	<input type="checkbox"/>
7	<input type="checkbox"/>

Apply Cancel

Figure 282 SWITCHING > QoS > Diffserv (Stacking Mode)

Diffserv DSCP Setting

Active OFF

SLOT 1 ▾

Port	Active
1/*	<input type="checkbox"/>
1/1	<input type="checkbox"/>
1/2	<input type="checkbox"/>
1/3	<input type="checkbox"/>
1/4	<input type="checkbox"/>
1/5	<input type="checkbox"/>
1/6	<input type="checkbox"/>
1/7	<input type="checkbox"/>

Apply Cancel

The following table describes the labels in this screen.

Table 176 SWITCHING > QoS > Diffserv

LABEL	DESCRIPTION
Active	Enable the switch button to enable Diffserv on the Switch.
Slot	This field appears only in Stacking mode. Click the drop-down list to choose the slot number of the Switch in a stack.

Table 176 SWITCHING > QoS > Diffserv (continued)

LABEL	DESCRIPTION
Port	This field displays the index number of a port on the Switch. In Stacking mode, the first number represents the slot and the second the port number. * means all ports (on the same Switch).
*	Settings in this row apply to all ports. Use this row only if you want to make some settings the same for all ports. Use this row first to set the common settings and then make adjustments on a port-by-port basis. Changes in this row are copied to all the ports as soon as you make them.
Active	Select Active to enable Diffserv on the port.
Apply	Click Apply to save your changes to the Switch's run-time memory. The Switch loses these changes if it is turned off or loses power, so use the Save link on the top navigation panel to save your changes to the non-volatile memory when you are done configuring.
Cancel	Click Cancel to begin configuring this screen afresh.

49.3 DSCP-to-IEEE 802.1p Priority Settings

You can configure the DSCP to IEEE 802.1p mapping to allow the Switch to prioritize all traffic based on the incoming DSCP value according to the DiffServ to IEEE 802.1p mapping table.

The following table shows the default DSCP-to-IEEE802.1p mapping.

Table 177 Default DSCP-IEEE 802.1p Mapping

DSCP VALUE	0 – 7	8 – 15	16 – 23	24 – 31	32 – 39	40 – 47	48 – 55	56 – 63
IEEE 802.1p	0	1	2	3	4	5	6	7

49.3.1 Configuring DSCP Settings

To change the DSCP-IEEE 802.1p mapping click **SWITCHING > QoS > Diffserv > DSCP Setting** to display the screen as shown next.

Figure 283 SWITCHING > QoS > Diffserv > DSCP Setting

The screenshot shows the 'DSCP Setting' configuration page. It features a grid of 64 entries for mapping DSCP values to IEEE 802.1p priority levels. Each entry consists of a label (0-63) and a dropdown menu. The dropdowns are currently set to values 0 through 7 in a repeating pattern. At the bottom of the grid, there are two buttons: a green 'Apply' button and a grey 'Cancel' button.

Label	Value
0	0
1	0
2	0
3	0
4	0
5	0
6	0
7	0
8	1
9	1
10	1
11	1
12	1
13	1
14	1
15	1
16	2
17	2
18	2
19	2
20	2
21	2
22	2
23	2
24	3
25	3
26	3
27	3
28	3
29	3
30	3
31	3
32	4
33	4
34	4
35	4
36	4
37	4
38	4
39	4
40	5
41	5
42	5
43	5
44	5
45	5
46	5
47	5
48	6
49	6
50	6
51	6
52	6
53	6
54	6
55	6
56	7
57	7
58	7
59	7
60	7
61	7
62	7
63	7

The following table describes the labels in this screen.

Table 178 SWITCHING > QoS > Diffserv > DSCP Setting

LABEL	DESCRIPTION
0 ... 63	This is the DSCP classification identification number. To set the IEEE 802.1p priority mapping, select the priority level from the drop-down list box.
Apply	Click Apply to save your changes to the Switch's run-time memory. The Switch loses these changes if it is turned off or loses power, so use the Save link on the top navigation panel to save your changes to the non-volatile memory when you are done configuring.
Cancel	Click Cancel to begin configuring this screen afresh.

CHAPTER 50

Queuing Method

50.1 Queuing Method Overview

This section introduces the queuing methods supported.

Queuing is used to help solve performance degradation when there is network congestion. Use the **Queuing Method** screen to configure queuing algorithms for outgoing traffic. See also **Priority Queue Assignment** in the **SWITCHING > QoS > Priority Queue** screen and **802.1p Priority** in the **PORT > Port Setup** screen for related information.

50.1.1 What You Can Do

Use the **Queuing Method** screen ([Section 50.2 on page 366](#)) to set priorities for the queues of the Switch. This distributes bandwidth across the different traffic queues.

50.1.2 What You Need to Know

Queuing algorithms allow switches to maintain separate queues for packets from each individual source or flow and prevent a source from monopolizing the bandwidth.

Strictly Priority Queuing

Strictly Priority Queuing (SPQ) services queues based on priority only. As traffic comes into the Switch, traffic on the highest priority queue, Q7 is transmitted first. When that queue empties, traffic on the next highest-priority queue, Q6 is transmitted until Q6 empties, and then traffic is transmitted on Q5 and so on. If higher priority queues never empty, then traffic on lower priority queues never gets sent. SPQ does not automatically adapt to changing network requirements.

Weighted Fair Queuing

Weighted Fair Queuing is used to guarantee each queue's minimum bandwidth based on its bandwidth weight (portion) (the number you configure in the Weight field) when there is traffic congestion. WFQ is activated only when a port has more traffic than it can handle. Queues with larger weights get more guaranteed bandwidth than queues with smaller weights. This queuing mechanism is highly efficient in that it divides any available bandwidth across the different traffic queues. By default, the weight for Q0 is 1, for Q1 is 2, for Q2 is 3, and so on.

Weighted Round Robin Scheduling (WRR)

Round Robin Scheduling services queues on a rotating basis and is activated only when a port has more traffic than it can handle. A queue is given an amount of bandwidth irrespective of the incoming traffic

on that port. This queue then moves to the back of the list. The next queue is given an equal amount of bandwidth, and then moves to the end of the list; and so on, depending on the number of queues being used. This works in a looping fashion until a queue is empty.

Weighted Round Robin Scheduling (WRR) uses the same algorithm as round robin scheduling, but services queues based on their priority and queue weight (the number you configure in the queue **Weight** field) rather than a fixed amount of bandwidth. WRR is activated only when a port has more traffic than it can handle. Queues with larger weights get more service than queues with smaller weights. This queuing mechanism is highly efficient in that it divides any available bandwidth across the different traffic queues and returns to queues that have not yet emptied.

50.2 Configuring Queuing

Use this screen to set priorities for the queues of the Switch. This distributes bandwidth across the different traffic queues.

Click **SWITCHING > QoS > Queuing Method** to display the screen as shown below.

Figure 284 SWITCHING > QoS > Queuing Method (Standalone Mode)

Port	Method	Weight								Hybrid-SPQ Lowest-Queue
		Q0	Q1	Q2	Q3	Q4	Q5	Q6	Q7	
*	SPQ ▼	<input type="text"/>	<input type="text"/>	<input type="text"/>	<input type="text"/>	<input type="text"/>	<input type="text"/>	<input type="text"/>	<input type="text"/>	None ▼
1	SPQ ▼	<input type="text" value="1"/>	<input type="text" value="2"/>	<input type="text" value="3"/>	<input type="text" value="4"/>	<input type="text" value="5"/>	<input type="text" value="6"/>	<input type="text" value="7"/>	<input type="text" value="8"/>	None ▼
2	SPQ ▼	<input type="text" value="1"/>	<input type="text" value="2"/>	<input type="text" value="3"/>	<input type="text" value="4"/>	<input type="text" value="5"/>	<input type="text" value="6"/>	<input type="text" value="7"/>	<input type="text" value="8"/>	None ▼
3	SPQ ▼	<input type="text" value="1"/>	<input type="text" value="2"/>	<input type="text" value="3"/>	<input type="text" value="4"/>	<input type="text" value="5"/>	<input type="text" value="6"/>	<input type="text" value="7"/>	<input type="text" value="8"/>	None ▼
4	SPQ ▼	<input type="text" value="1"/>	<input type="text" value="2"/>	<input type="text" value="3"/>	<input type="text" value="4"/>	<input type="text" value="5"/>	<input type="text" value="6"/>	<input type="text" value="7"/>	<input type="text" value="8"/>	None ▼
5	SPQ ▼	<input type="text" value="1"/>	<input type="text" value="2"/>	<input type="text" value="3"/>	<input type="text" value="4"/>	<input type="text" value="5"/>	<input type="text" value="6"/>	<input type="text" value="7"/>	<input type="text" value="8"/>	None ▼
6	SPQ ▼	<input type="text" value="1"/>	<input type="text" value="2"/>	<input type="text" value="3"/>	<input type="text" value="4"/>	<input type="text" value="5"/>	<input type="text" value="6"/>	<input type="text" value="7"/>	<input type="text" value="8"/>	None ▼
7	SPQ ▼	<input type="text" value="1"/>	<input type="text" value="2"/>	<input type="text" value="3"/>	<input type="text" value="4"/>	<input type="text" value="5"/>	<input type="text" value="6"/>	<input type="text" value="7"/>	<input type="text" value="8"/>	None ▼

Figure 285 SWITCHING > QoS > Queuing Method (Stacking Mode)

Port	Method	Weight								Hybrid-SPQ Lowest-Queue
		Q0	Q1	Q2	Q3	Q4	Q5	Q6	Q7	
1/*	SPQ ▼	<input type="text"/>	<input type="text"/>	<input type="text"/>	<input type="text"/>	<input type="text"/>	<input type="text"/>	<input type="text"/>	<input type="text"/>	None ▼
1/1	SPQ ▼	<input type="text" value="1"/>	<input type="text" value="2"/>	<input type="text" value="3"/>	<input type="text" value="4"/>	<input type="text" value="5"/>	<input type="text" value="6"/>	<input type="text" value="7"/>	<input type="text" value="8"/>	None ▼
1/2	SPQ ▼	<input type="text" value="1"/>	<input type="text" value="2"/>	<input type="text" value="3"/>	<input type="text" value="4"/>	<input type="text" value="5"/>	<input type="text" value="6"/>	<input type="text" value="7"/>	<input type="text" value="8"/>	None ▼
1/3	SPQ ▼	<input type="text" value="1"/>	<input type="text" value="2"/>	<input type="text" value="3"/>	<input type="text" value="4"/>	<input type="text" value="5"/>	<input type="text" value="6"/>	<input type="text" value="7"/>	<input type="text" value="8"/>	None ▼
1/4	SPQ ▼	<input type="text" value="1"/>	<input type="text" value="2"/>	<input type="text" value="3"/>	<input type="text" value="4"/>	<input type="text" value="5"/>	<input type="text" value="6"/>	<input type="text" value="7"/>	<input type="text" value="8"/>	None ▼
1/5	SPQ ▼	<input type="text" value="1"/>	<input type="text" value="2"/>	<input type="text" value="3"/>	<input type="text" value="4"/>	<input type="text" value="5"/>	<input type="text" value="6"/>	<input type="text" value="7"/>	<input type="text" value="8"/>	None ▼
1/6	SPQ ▼	<input type="text" value="1"/>	<input type="text" value="2"/>	<input type="text" value="3"/>	<input type="text" value="4"/>	<input type="text" value="5"/>	<input type="text" value="6"/>	<input type="text" value="7"/>	<input type="text" value="8"/>	None ▼
1/7	SPQ ▼	<input type="text" value="1"/>	<input type="text" value="2"/>	<input type="text" value="3"/>	<input type="text" value="4"/>	<input type="text" value="5"/>	<input type="text" value="6"/>	<input type="text" value="7"/>	<input type="text" value="8"/>	None ▼

The following table describes the labels in this screen.

Table 179 SWITCHING > QoS > Queuing Method

LABEL	DESCRIPTION
SLOT	This field appears only in Stacking mode. Click the drop-down list to choose the slot number of the Switch in a stack.
Port	This field displays the port number. In Stacking mode, the first number represents the slot ID and the second is the port number. Please note that the default stacking ports (the last four ports of your Switch) cannot be configured. They are reserved for stacking only.
*	<p>Settings in this row apply to all ports.</p> <p>Use this row only if you want to make some settings the same for all ports. Use this row first to set the common settings and then make adjustments on a port-by-port basis.</p> <p>Note: Changes in this row are copied to all the ports as soon as you make them.</p>
Method	<p>Select SPQ (Strictly Priority Queuing), WFQ (Weighted Fair Queuing) or WRR (Weighted Round Robin).</p> <p>Strictly Priority Queuing services queues based on priority only. When the highest priority queue empties, traffic on the next highest-priority queue begins. Q7 has the highest priority and Q0 the lowest.</p> <p>Weighted Fair Queuing is used to guarantee each queue's minimum bandwidth based on their bandwidth portion (weight) (the number you configure in the Weight field). Queues with larger weights get more guaranteed bandwidth than queues with smaller weights.</p> <p>Weighted Round Robin Scheduling services queues on a rotating basis based on their queue weight (the number you configure in the queue Weight field). Queues with larger weights get more service than queues with smaller weights.</p>
Weight	When you select WFQ or WRR , enter the queue weight here. Bandwidth is divided across the different traffic queues according to their weights.
Hybrid-SPQ Lowest- Queue	<p>This field is applicable only when you select WFQ or WRR.</p> <p>Select a queue (Q0 to Q7) to have the Switch use SPQ to service the subsequent queues after and including the specified queue for the port. For example, if you select Q5, the Switch services traffic on Q5, Q6 and Q7 using SPQ.</p> <p>Select None to always use WFQ or WRR for the port.</p>

Table 179 SWITCHING > QoS > Queuing Method (continued)

LABEL	DESCRIPTION
Apply	Click Apply to save your changes to the Switch's run-time memory. The Switch loses these changes if it is turned off or loses power, so use the Save link on the top navigation panel to save your changes to the non-volatile memory when you are done configuring.
Cancel	Click Cancel to begin configuring this screen afresh.

CHAPTER 51

Priority Queue

51.1 Priority Queue Overview

IEEE 802.1p defines up to eight separate traffic types by inserting a tag into a MAC-layer frame that contains bits to define class of service. Frames without an explicit priority tag are given the default priority of the ingress port. Use this screen to configure the priority level-to-physical queue mapping. The Switch has eight physical queues that you can map to the eight priority levels.

On the Switch, traffic assigned to higher index queues gets through faster while traffic in lower index queues is dropped if the network is congested.

51.1.1 What You Can Do

Use the **Priority Queue** screen ([Section 51.2 on page 369](#)) to configure the priority level-to-physical queue mapping.

51.2 Assign Priority Queue

Use this screen to assign priority level to each queue.

Click **SWITCHING** > **QoS** > **Priority Queue** to open this screen.

Figure 286 SWITCHING > QoS > Priority Queue

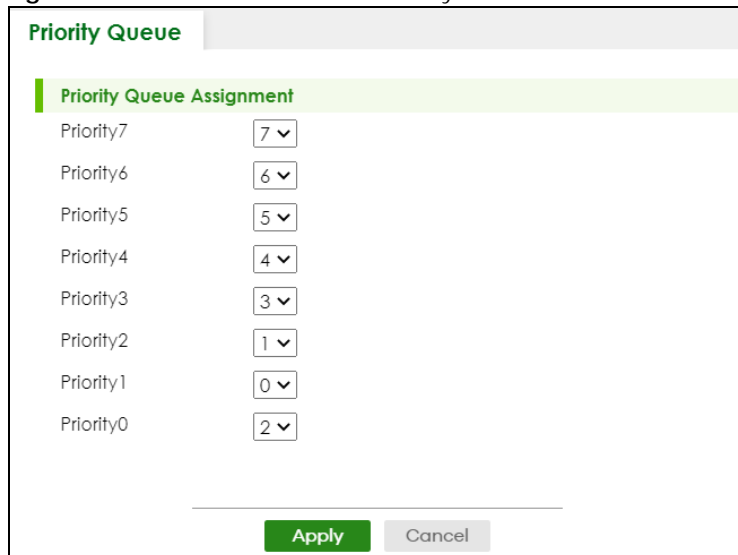

Priority	Queue Index
Priority7	7
Priority6	6
Priority5	5
Priority4	4
Priority3	3
Priority2	1
Priority1	0
Priority0	2

The following table describes the related labels in this screen.

Table 180 SWITCHING > QoS > Priority Queue

LABEL	DESCRIPTION
	Priority Queue Assignment The following descriptions are based on the traffic types defined in the IEEE 802.1d standard (which incorporates the 802.1p). To map a priority level to a physical queue, select a physical queue from the drop-down menu on the right.
Priority 7	Typically used for network control traffic such as router configuration messages.
Priority 6	Typically used for voice traffic that is especially sensitive to jitter (jitter is the variations in delay).
Priority 5	Typically used for video that consumes high bandwidth and is sensitive to jitter.
Priority 4	Typically used for controlled load, latency-sensitive traffic such as SNA (Systems Network Architecture) transactions.
Priority 3	Typically used for "excellent effort" or better than best effort and would include important business traffic that can tolerate some delay.
Priority 2	This is for "spare bandwidth".
Priority 1	This is typically used for non-critical "background" traffic such as bulk transfers that are allowed but that should not affect other applications and users.
Priority 0	Typically used for best-effort traffic.
Apply	Click Apply to save your changes to the Switch's run-time memory. The Switch loses these changes if it is turned off or loses power, so use the Save link on the top navigation panel to save your changes to the non-volatile memory when you are done configuring.
Cancel	Click Cancel to reset the fields.

CHAPTER 52

Bandwidth Control

52.1 Bandwidth Control Overview

This chapter shows you how you can cap the maximum bandwidth using the **Bandwidth Control** screen.

Bandwidth control means defining a maximum allowable bandwidth for incoming and/or out-going traffic flows on a port.

52.1.1 What You Can Do

Use the **Bandwidth Control** screen ([Section 52.2 on page 371](#)) to limit the bandwidth for traffic going through the Switch.

52.1.2 CIR and PIR

The Committed Information Rate (CIR) is the guaranteed bandwidth for the incoming traffic flow on a port. The Peak Information Rate (PIR) is the maximum bandwidth allowed for the incoming traffic flow on a port when there is no network congestion.

The CIR and PIR should be set for all ports that use the same uplink bandwidth. If the CIR is reached, packets are sent at the rate up to the PIR. When network congestion occurs, packets through the ingress port exceeding the CIR will be marked for drop.

52.2 Bandwidth Control Setup

Click **SWITCHING > QoS > Bandwidth Control** in the navigation panel to bring up the screen as shown next.

Note: The CIR should be less than the PIR.

Note: The sum of CIRs cannot be greater than or equal to the uplink bandwidth.

Figure 287 SWITCHING > QoS > Bandwidth Control (Standalone mode)

Bandwidth Control

Active ON

Port	Active	Ingress Rate	Active	Egress Rate
*	<input type="checkbox"/>	<input type="text"/> kbps	<input type="checkbox"/>	<input type="text"/> kbps
1	<input type="checkbox"/>	64 <input type="text"/> kbps	<input type="checkbox"/>	64 <input type="text"/> kbps
2	<input type="checkbox"/>	64 <input type="text"/> kbps	<input type="checkbox"/>	64 <input type="text"/> kbps
3	<input type="checkbox"/>	64 <input type="text"/> kbps	<input type="checkbox"/>	64 <input type="text"/> kbps
4	<input type="checkbox"/>	64 <input type="text"/> kbps	<input type="checkbox"/>	64 <input type="text"/> kbps
5	<input type="checkbox"/>	64 <input type="text"/> kbps	<input type="checkbox"/>	64 <input type="text"/> kbps
6	<input type="checkbox"/>	64 <input type="text"/> kbps	<input type="checkbox"/>	64 <input type="text"/> kbps
7	<input type="checkbox"/>	64 <input type="text"/> kbps	<input type="checkbox"/>	64 <input type="text"/> kbps
8	<input type="checkbox"/>	64 <input type="text"/> kbps	<input type="checkbox"/>	64 <input type="text"/> kbps
9	<input type="checkbox"/>	64 <input type="text"/> kbps	<input type="checkbox"/>	64 <input type="text"/> kbps

Figure 288 SWITCHING > QoS > Bandwidth Control (Stacking Mode)

Bandwidth Control

Active ON

SLOT 1 ▾

Port	Active	Ingress Rate	Active	Egress Rate
1/*	<input type="checkbox"/>	<input type="text"/> kbps	<input type="checkbox"/>	<input type="text"/> kbps
1/1	<input type="checkbox"/>	64 <input type="text"/> kbps	<input type="checkbox"/>	64 <input type="text"/> kbps
1/2	<input type="checkbox"/>	64 <input type="text"/> kbps	<input type="checkbox"/>	64 <input type="text"/> kbps
1/3	<input type="checkbox"/>	64 <input type="text"/> kbps	<input type="checkbox"/>	64 <input type="text"/> kbps
1/4	<input type="checkbox"/>	64 <input type="text"/> kbps	<input type="checkbox"/>	64 <input type="text"/> kbps
1/5	<input type="checkbox"/>	64 <input type="text"/> kbps	<input type="checkbox"/>	64 <input type="text"/> kbps
1/6	<input type="checkbox"/>	64 <input type="text"/> kbps	<input type="checkbox"/>	64 <input type="text"/> kbps
1/7	<input type="checkbox"/>	64 <input type="text"/> kbps	<input type="checkbox"/>	64 <input type="text"/> kbps
1/8	<input type="checkbox"/>	64 <input type="text"/> kbps	<input type="checkbox"/>	64 <input type="text"/> kbps

The following table describes the related labels in this screen.

Table 181 SWITCHING > QoS > Bandwidth Control

LABEL	DESCRIPTION
Active	Enable the switch button to enable bandwidth control on the Switch.
SLOT	This field appears only in Stacking mode. Click the drop-down list to choose the slot number of the Switch in a stack.
Port	This field displays the port number. In Stacking mode, the first number represents the slot ID and the second is the port number. Please note that the default stacking ports (the last four ports of your Switch) cannot be configured. They are reserved for stacking only.
*	<p>Settings in this row apply to all ports.</p> <p>Use this row only if you want to make some settings the same for all ports. Use this row first to set the common settings and then make adjustments on a port-by-port basis.</p> <p>Note: Changes in this row are copied to all the ports as soon as you make them.</p>
Active	Select this check box to activate ingress rate limits on this port.
Ingress Rate	<p>Specify the maximum bandwidth allowed in kilobits per second (Kbps) for the incoming traffic flow on a port.</p> <p>Note: Ingress rate bandwidth control applies to layer 2 traffic only.</p>
Active	Select this check box to activate egress rate limits on this port.
Egress Rate	Specify the maximum bandwidth allowed in kilobits per second (Kbps) for the out-going traffic flow on a port.
Apply	Click Apply to save your changes to the Switch's run-time memory. The Switch loses these changes if it is turned off or loses power, so use the Save link on the top navigation panel to save your changes to the non-volatile memory when you are done configuring.
Cancel	Click Cancel to reset the fields.

CHAPTER 53

sFlow

This chapter shows you how to configure sFlow to have the Switch monitor traffic in a network and send information to an sFlow collector for analysis.

53.1 sFlow Overview

sFlow (RFC 3176) is a standard technology for monitoring switched networks. An sFlow agent embedded on a switch or router gets sample data and packet statistics from traffic forwarded through its ports. The sFlow agent then creates sFlow data and sends it to an sFlow collector. The sFlow collector is a server that collects and analyzes sFlow datagram. An sFlow datagram includes packet header, input and output interface, sampling process parameters and forwarding information.

sFlow minimizes impact on CPU load of the Switch as it analyzes sample data only. sFlow can continuously monitor network traffic and create reports for network performance analysis and troubleshooting. For example, you can use it to know which IP address or which type of traffic caused network congestion.

Figure 289 sFlow Application



53.2 sFlow Port Configuration

Click **SWITCHING** > **sFlow** in the navigation panel to display the screen as shown.

Figure 290 SWITCHING > sFlow (Standalone Mode)

sFlow Collector

Active OFF

Port	Active	Sample-rate	Poll-interval	Collector Address
*	<input type="checkbox"/>	<input type="text"/>	<input type="text"/>	<input type="text"/>
1	<input type="checkbox"/>	32768	120	<input type="text"/>
2	<input type="checkbox"/>	32768	120	<input type="text"/>
3	<input type="checkbox"/>	32768	120	<input type="text"/>
4	<input type="checkbox"/>	32768	120	<input type="text"/>
5	<input type="checkbox"/>	32768	120	<input type="text"/>
6	<input type="checkbox"/>	32768	120	<input type="text"/>
7	<input type="checkbox"/>	32768	120	<input type="text"/>

Figure 291 SWITCHING > sFlow (Stacking Mode)

sFlow Collector

Active OFF

SLOT 1 ▾

Port	Active	Sample-rate	Poll-interval	Collector Address
1/*	<input type="checkbox"/>	<input type="text"/>	<input type="text"/>	<input type="text"/>
1/1	<input type="checkbox"/>	32768	120	<input type="text"/>
1/2	<input type="checkbox"/>	32768	120	<input type="text"/>
1/3	<input type="checkbox"/>	32768	120	<input type="text"/>
1/4	<input type="checkbox"/>	32768	120	<input type="text"/>
1/5	<input type="checkbox"/>	32768	120	<input type="text"/>
1/6	<input type="checkbox"/>	32768	120	<input type="text"/>
1/7	<input type="checkbox"/>	32768	120	<input type="text"/>

The following table describes the labels in this screen.

Table 182 SWITCHING > sFlow

LABEL	DESCRIPTION
Active	Enable the switch button to enable the sFlow agent on the Switch.
SLOT	This field appears only in Stacking mode. Click the drop-down list to choose the slot number of the Switch in a stack.
Port	This field displays the port number. In Stacking mode, the first number represents the slot ID and the second is the port number. Please note that the default stacking ports (the last four ports of your Switch) cannot be configured. They are reserved for stacking only.
*	Settings in this row apply to all ports. Use this row only if you want to make some settings the same for all ports. Use this row first to set the common settings and then make adjustments on a port-by-port basis. Note: Changes in this row are copied to all the ports as soon as you make them.
Active	Select this to allow the Switch to monitor traffic on this port and generate and send sFlow datagram to the specified collector.
Sample-rate	Enter a number (N) from 256 to 65535. The Switch captures every one out of N packets for this port and creates sFlow datagram.
Poll-interval	Specify a time interval (from 20 to 120 in seconds) the Switch waits before sending the sFlow datagram and packet counters for this port to the collector.
Collector Address	Enter the IP address of the sFlow collector. Note: You must have the sFlow collector already configured in the SWITCHING > sFlow > Collector screen. The sFlow collector does not need to be in the same subnet as the Switch, but it must be accessible from the Switch. Note: Configure UDP port 6343 (the default) on a NAT router to allow port forwarding if the collector is behind a NAT router. Configure a firewall rule for UDP port 6343 (the default) to allow incoming traffic if the collector is behind a firewall.
Apply	Click Apply to save your changes to the Switch's run-time memory. The Switch loses these changes if it is turned off or loses power, so use the Save link on the top navigation panel to save your changes to the non-volatile memory when you are done configuring.
Cancel	Click Cancel to begin configuring this screen afresh.

53.3 sFlow Collector Configuration

Click **SWITCHING > sFlow > Collector** to display the screen as shown. You may want to configure more than one collector if the traffic load to be monitored is more than one collector can manage.

Note: You can configure up to four sFlow collectors in this screen.

Figure 292 SWITCHING > sFlow > Collector

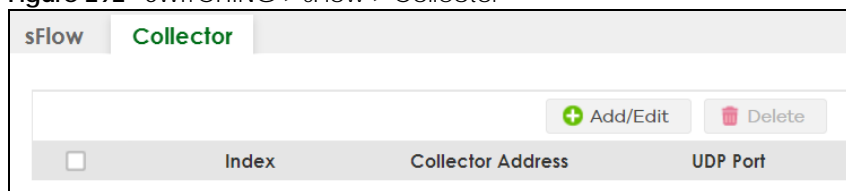

The following table describes the labels in this screen.

Table 183 SWITCHING > sFlow > Collector

LABEL	DESCRIPTION
Index	This field displays the index number of this entry.
Collector Address	This field displays IP address of the sFlow collector.
UDP Port	This field displays port number the Switch uses to send sFlow datagram to the collector.
	Select an entry's check box to select a specific entry. Otherwise, select the check box in the table heading row to select all entries.
Add/Edit	Click Add/Edit to add a new entry or edit a selected one.
Delete	Click Delete to remove the selected entries.

53.3.1 Add/Edit sFlow Collector

Click **Add/Edit**, or select an entry and click **Add/Edit** in the **SWITCHING > sFlow > Collector** screen to display this screen.

Figure 293 SWITCHING > sFlow > Collector > Add/Edit

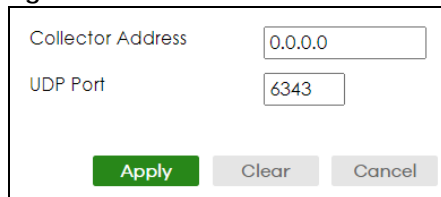

The following table describes the labels in this screen.

Table 184 SWITCHING > sFlow > Collector > Add/Edit

LABEL	DESCRIPTION
Collector Address	Enter the IP address of the sFlow collector.
UDP Port	Enter a UDP port number the Switch uses to send sFlow datagram to the collector. If you change the port here, make sure you change it on the collector, too. The default port is 6343.
Apply	Click Apply to save your changes to the Switch's run-time memory. The Switch loses these changes if it is turned off or loses power, so use the Save link on the top navigation panel to save your changes to the non-volatile memory when you are done configuring.
Clear	Click Clear to clear the fields to the factory defaults.
Cancel	Click Cancel to not save the configuration you make and return to the last screen.

CHAPTER 54

Spanning Tree Protocol

54.1 Spanning Tree Protocol Overview

The Switch supports Spanning Tree Protocol (STP), Rapid Spanning Tree Protocol (RSTP) and Multiple Spanning Tree Protocol (MSTP) as defined in the following standards.

- IEEE 802.1D Spanning Tree Protocol
- IEEE 802.1w Rapid Spanning Tree Protocol
- IEEE 802.1s Multiple Spanning Tree Protocol

The Switch also allows you to set up multiple STP configurations (or trees). Ports can then be assigned to the trees.

54.1.1 What You Can Do

- Use the **Spanning Tree Protocol Status** screen ([Section 54.2 on page 381](#)) to view the STP status in the different STP modes (RSTP, MRSTP or MSTP) you can configure on the Switch.
- Use the **Spanning Tree Setup** screen ([Section 54.3 on page 382](#)) to activate one of the STP modes on the Switch.
- Use the **Rapid Spanning Tree Protocol Status** screen ([Section 54.4 on page 385](#)) to view the RSTP status.
- Use the **Rapid Spanning Tree Protocol** screen ([Section 54.5 on page 387](#)) to configure RSTP settings.
- Use the **Multiple Rapid Spanning Tree Protocol Status** screen ([Section 54.6 on page 391](#)) to view the MRSTP status.
- Use the **Multiple Rapid Spanning Tree Protocol** screen ([Section 54.7 on page 393](#)) to configure MRSTP.
- Use the **Multiple Spanning Tree Protocol Status** screen ([Section 54.8 on page 397](#)) to view the MSTP status.
- Use the **Multiple Spanning Tree Protocol** screen ([Section 54.9 on page 401](#)) to configure MSTP.
- Use the **Multiple Spanning Tree Protocol Port Setup** screen ([Section 54.10 on page 405](#)) to configure MSTP ports.

54.1.2 What You Need to Know

Read on for concepts on STP that can help you configure the screens in this chapter.

(Rapid) Spanning Tree Protocol

(R)STP detects and breaks network loops and provides backup links between switches, bridges or routers. It allows a switch to interact with other (R)STP-compliant switches in your network to ensure that only one path exists between any two stations on the network.

The Switch uses IEEE 802.1w RSTP (Rapid Spanning Tree Protocol) that allows faster convergence of the

spanning tree than STP (while also being backwards compatible with STP-only aware bridges). In RSTP, topology change information is directly propagated throughout the network from the device that generates the topology change. In STP, a longer delay is required as the device that causes a topology change first notifies the root bridge that then notifies the network. Both RSTP and STP flush unwanted learned addresses from the filtering database. In RSTP, the port states are Discarding, Learning, and Forwarding.

Note: In this user's guide, "STP" refers to both STP and RSTP.

STP Terminology

The root bridge is the base of the spanning tree.

Path cost is the cost of transmitting a frame onto a LAN through that port. The recommended cost is assigned according to the speed of the link to which a port is attached. The slower the media, the higher the cost.

Table 185 STP Path Costs

	LINK SPEED	RECOMMENDED VALUE	RECOMMENDED RANGE	ALLOWED RANGE
Path Cost	4 Mbps	250	100 to 1000	1 to 65535
Path Cost	10 Mbps	100	50 to 600	1 to 65535
Path Cost	16 Mbps	62	40 to 400	1 to 65535
Path Cost	100 Mbps	19	10 to 60	1 to 65535
Path Cost	1 Gbps	4	3 to 10	1 to 65535
Path Cost	10 Gbps	2	1 to 5	1 to 65535

On each bridge, the root port is the port through which this bridge communicates with the root. It is the port on this switch with the lowest path cost to the root (the root path cost). If there is no root port, then this switch has been accepted as the root bridge of the spanning tree network.

For each LAN segment, a designated bridge is selected. This bridge has the lowest cost to the root among the bridges connected to the LAN.

How STP Works

After a bridge determines the lowest cost-spanning tree with STP, it enables the root port and the ports that are the designated ports for connected LANs, and disables all other ports that participate in STP. Network packets are therefore only forwarded between enabled ports, eliminating any possible network loops.

STP-aware switches exchange Bridge Protocol Data Units (BPDUs) periodically. When the bridged LAN topology changes, a new spanning tree is constructed.

Once a stable network topology has been established, all bridges listen for Hello BPDUs (Bridge Protocol Data Units) transmitted from the root bridge. If a bridge does not get a Hello BPDU after a predefined interval (Max Age), the bridge assumes that the link to the root bridge is down. This bridge then initiates negotiations with other bridges to reconfigure the network to re-establish a valid network topology.

STP Port States

STP assigns five port states to eliminate packet looping. A bridge port is not allowed to go directly from

blocking state to forwarding state so as to eliminate transient loops.

Table 186 STP Port States

PORT STATE	DESCRIPTION
Disabled	STP is disabled (default).
Blocking	Only configuration and management BPDUs are received and processed.
Listening	All BPDUs are received and processed. Note: The listening state does NOT exist in RSTP.
Learning	All BPDUs are received and processed. Information frames are submitted to the learning process but not forwarded.
Forwarding	All BPDUs are received and processed. All information frames are received and forwarded.

Multiple RSTP

MRSTP (Multiple RSTP) is Zyxel's proprietary feature that is compatible with RSTP and STP. With MRSTP, you can have more than one spanning tree on your Switch and assign ports to each tree. Each spanning tree operates independently with its own bridge information.

In the following example, there are two RSTP instances (**MRSTP 1** and **MRSTP2**) on switch **A**.

To set up MRSTP, activate MRSTP on the Switch and specify which ports belong to which spanning tree.

Note: Each port can belong to one STP tree only.

Figure 294 MRSTP Network Example

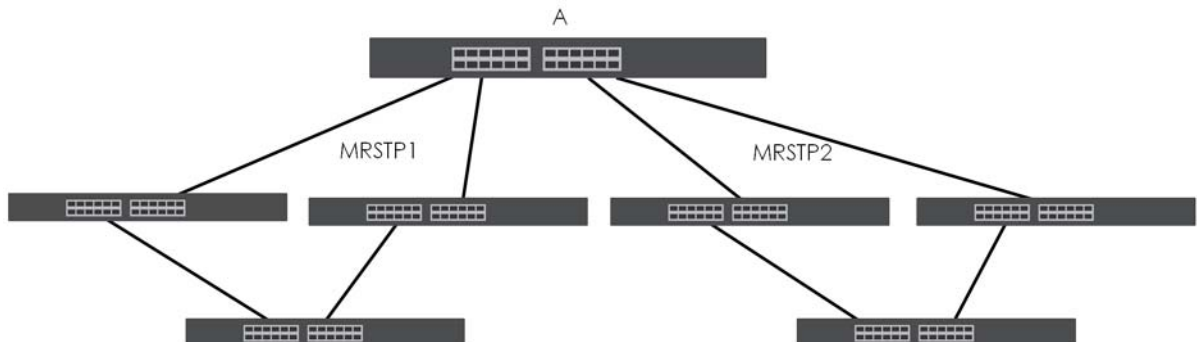

Multiple STP

Multiple Spanning Tree Protocol (IEEE 802.1s) is backward compatible with STP/RSTP and addresses the limitations of existing spanning tree protocols (STP and RSTP) in networks to include the following features:

- One Common and Internal Spanning Tree (CIST) that represents the entire network's connectivity.
- Grouping of multiple bridges (or switching devices) into regions that appear as one single bridge on the network.
- A VLAN can be mapped to a specific Multiple Spanning Tree Instance (MSTI). MSTI allows multiple VLANs to use the same spanning tree.
- Load-balancing is possible as traffic from different VLANs can use distinct paths in a region.

54.2 Spanning Tree Protocol Status

The Spanning Tree Protocol status screen changes depending on what standard you choose to implement on your network. Click **SWITCHING > Spanning Tree Protocol > Spanning Tree Protocol Status** to see the screen as shown.

Figure 295 SWITCHING > Spanning Tree Protocol > Spanning Tree Protocol Status (Standalone Mode)

Spanning Tree Protocol Status						
Spanning Tree Protocol: RSTP						
	Root Bridge		Our Bridge			
Bridge ID	0000-000000000000		0000-000000000000			
Hello Time (seconds)	0		0			
Max Age (seconds)	0		0			
Forwarding Delay (seconds)	0		0			
Cost to Bridge	0					
Port ID	0x0000					
Topology Changed Times	0					
Time Since Last Change	0:00:00					
Port	Port State	Port Role	Designated Bridge ID	Designated Port ID	Designated Cost	Root Guard State

Figure 296 SWITCHING > Spanning Tree Protocol > Spanning Tree Protocol Status (Stacking Mode)

Spanning Tree Protocol Status																				
Spanning Tree Protocol: RSTP																				
	Root Bridge		Our Bridge																	
Bridge ID	0000-000000000000		0000-000000000000																	
Hello Time (seconds)	0		0																	
Max Age (seconds)	0		0																	
Forwarding Delay (seconds)	0		0																	
Cost to Bridge	0		0																	
Port ID	0x0000																			
Topology Changed Times	0																			
Time Since Last Change	0:00:00																			
<div style="border: 1px solid black; padding: 2px; margin-bottom: 5px;"> SLOT 1 ▾ </div> <table border="1"> <thead> <tr> <th>Port</th> <th>Port State</th> <th>Port Role</th> <th>Designated Bridge ID</th> <th>Designated Port ID</th> <th>Designated Cost</th> <th>Root Guard State</th> </tr> </thead> <tbody> <tr> <td> </td> <td> </td> <td> </td> <td> </td> <td> </td> <td> </td> <td> </td> </tr> </tbody> </table>							Port	Port State	Port Role	Designated Bridge ID	Designated Port ID	Designated Cost	Root Guard State							
Port	Port State	Port Role	Designated Bridge ID	Designated Port ID	Designated Cost	Root Guard State														

This screen differs depending on which STP mode (RSTP, MRSTP or MSTP) you configure on the Switch. This screen is described in detail in the section ([Section 54.4 on page 385](#), [Section 54.6 on page 391](#), and [Section 54.8 on page 397](#)) that follows the configuration section for each STP mode. Use the **SWITCHING > Spanning Tree Protocol > Spanning Tree Setup** screen to activate one of the STP standards on the Switch.

54.3 Spanning Tree Setup

There are three **Auto path-cost Modes** (see [Table 190 on page 384](#)). Choose the **Auto Path-cost Mode** according to the device average link speeds in the STP network.

If most of your devices support high link speed, you should select **Long** or **User-defined** mode. The path cost of link speed slower than 10 Mbps can be set to 2000000, and the path cost of link speed faster than 10 Gbps can be set to 200. This way, the path costs can better reflect actual link speeds with a wider range (32 bits) of path cost values. If the link speeds within the system are averagely smaller than 1 Gbps, you should select **Short** mode since **Short** mode have path cost values more detailed defined for link speeds under 1 Gbps.

The path cost values are described in the following tables.

The Switch defines the following **Short** mode path costs.

Table 187 Auto Path Cost Mode: Short

LINK SPEED	AUTO PATH COST VALUE
Up to 4 Mbps	250
Up to 10 Mbps	100
Up to 16 Mbps	62
Up to 100 Mbps	19
Up to 1 Gbps	4
Up to 10 Gbps	2
More than 10 Gbps	1

The Switch defines the following **Long** mode path costs.

Table 188 Auto Path Cost Mode: Long

LINK SPEED	AUTO PATH COST VALUE
Up to 10 Mbps	2000000
Up to 100 Mbps	200000
Up to 1 Gbps	20000
Up to 2.5 Gbps	8000
Up to 5 Gbps	4000
Up to 10 Gbps	2000
More than 10 Gbps	200

If you do not configure the auto path cost values for **User-defined** mode, the Switch uses the following default values.

Table 189 Auto Path Cost Mode: User-defined

LINK SPEED	AUTO PATH COST VALUE
Up to 10 Mbps	2000000
Up to 100 Mbps	200000
Up to 1 Gbps	20000
Up to 2.5 Gbps	8000
Up to 5 Gbps	4000
More than 5 Gbps	2000

Use the this screen to activate one of the STP modes on the Switch. Click **SWITCHING > Spanning Tree Protocol > Spanning Tree Setup** to display the screen as shown.

Figure 297 SWITCHING > Spanning Tree Protocol > Spanning Tree Setup

The following table describes the labels in this screen.

Table 190 SWITCHING > Spanning Tree Protocol > Spanning Tree Setup

LABEL	DESCRIPTION
Spanning Tree Mode	You can activate one of the STP modes on the Switch. Select Rapid Spanning Tree (RSTP) , Multiple Rapid Spanning Tree (MRSTP) or Multiple Spanning Tree (MSTP) .
Auto Path-cost Mode	<p>Auto Path-cost Mode allows you to have the Switch automatically set the path cost for each port according to their link speed. The Switch uses the path costs to determine the best path to the root bridge in a spanning tree. There are three Auto Path-cost Modes that supports different path cost lengths:</p> <ul style="list-style-type: none"> • Short (16-bit) • Long (32-bit) • User-defined (32-bit). <p>The auto path cost values of each mode are described in Section 54.3 on page 382.</p> <p>Note: It is recommended to use the same Auto Path-cost Mode on all switches within the spanning tree network system.</p> <p>To use the auto path-cost feature, select the Auto Path-cost mode (Short, Long, User-defined), set a port's Path Cost (in the SWITCHING > Spanning Tree Protocol > RSTP, MRSTP, and MSTP screens) to "0". The Switch will automatically set the port's path cost to the auto path cost value defined by the Auto Path-cost Mode you select.</p>
Short	Select this mode if you want to use the 16-bit auto path cost values the Switch defines.
Long	Select this mode if you want to use the 32-bit auto path cost values the Switch defines.
User-defined	Select this mode to manually set the auto path costs for each link speed. Enter the path cost value for each link speed. The range is from 1 – 2000000. It is recommended to assign this value according to link speeds. The slower the speed, the higher the cost.

Table 190 SWITCHING > Spanning Tree Protocol > Spanning Tree Setup (continued)

LABEL	DESCRIPTION
Apply	Click Apply to save your changes to the Switch's run-time memory. The Switch loses these changes if it is turned off or loses power, so use the Save link on the top navigation panel to save your changes to the non-volatile memory when you are done configuring.
Cancel	Click Cancel to begin configuring this screen afresh.

54.4 Rapid Spanning Tree Protocol Status

The Spanning Tree Protocol status screen changes depending on what standard you choose to implement on your network. Click **SWITCHING > Spanning Tree Protocol > Spanning Tree Protocol Status** in the navigation panel to display the status screen as shown next. See [Section 54.1 on page 378](#) for more information on RSTP.

Note: This screen is only available after you activate RSTP on the Switch.

Figure 298 SWITCHING > Spanning Tree Protocol > Spanning Tree Protocol Status: RSTP (Standalone Mode)

Spanning Tree Protocol Status						
Spanning Tree Protocol: RSTP						
	Root Bridge		Our Bridge			
Bridge ID	6666-bc6666cbc666		6666-bc6666cbc666			
Hello Time (seconds)	2		2			
Max Age (seconds)	20		20			
Forwarding Delay (seconds)	15		15			
Cost to Bridge	0					
Port ID	0x0000					
Topology Changed Times	2					
Time Since Last Change	0:01:33					
Port	Port State	Port Role	Designated Bridge ID	Designated Port ID	Designated Cost	Root Guard State
1	DISCARDING	Disabled	0000-000000000000	0x0000	0	Forwarding
2	DISCARDING	Disabled	0000-000000000000	0x0000	0	Forwarding
3	DISCARDING	Disabled	0000-000000000000	0x0000	0	Forwarding
4	DISCARDING	Disabled	0000-000000000000	0x0000	0	Forwarding
5	DISCARDING	Disabled	0000-000000000000	0x0000	0	Forwarding
6	FORWARDING	Designated	6666-bc6666cbc666	0x8012	0	Forwarding
7	DISCARDING	Disabled	0000-000000000000	0x0000	0	Forwarding
8	FORWARDING	Designated	6666-bc6666cbc666	0x8016	0	Forwarding

Figure 299 SWITCHING > Spanning Tree Protocol > Spanning Tree Protocol Status: RSTP (Stacking Mode)

Spanning Tree Protocol Status						
Spanning Tree Protocol: RSTP						
	Root Bridge			Our Bridge		
Bridge ID	6666-bc6666cbc666			6666-bc6666cbc666		
Hello Time (seconds)	2			2		
Max Age (seconds)	20			20		
Forwarding Delay (seconds)	15			15		
Cost to Bridge	0					
Port ID	0x0000					
Topology Changed Times	2					
Time Since Last Change	0:01:33					
<input type="button" value="SLOT 1"/>						
Port	Port State	Port Role	Designated Bridge ID	Designated Port ID	Designated Cost	Root Guard State
1/1	DISCARDING	Disabled	0000-000000000000	0x0000	0	Forwarding
1/2	DISCARDING	Disabled	0000-000000000000	0x0000	0	Forwarding
1/3	DISCARDING	Disabled	0000-000000000000	0x0000	0	Forwarding
1/4	DISCARDING	Disabled	0000-000000000000	0x0000	0	Forwarding
1/5	DISCARDING	Disabled	0000-000000000000	0x0000	0	Forwarding
1/6	FORWARDING	Designated	6666-bc6666cbc666	0x8012	0	Forwarding
1/7	DISCARDING	Disabled	0000-000000000000	0x0000	0	Forwarding
1/8	FORWARDING	Designated	6666-bc6666cbc666	0x8016	0	Forwarding

The following table describes the labels in this screen.

Table 191 SWITCHING > Spanning Tree Protocol > Spanning Tree Protocol Status: RSTP

LABEL	DESCRIPTION
Bridge	Root Bridge refers to the base of the spanning tree (the root bridge). Our Bridge is this Switch. This Switch may also be the root bridge.
Bridge ID	This is the unique identifier for this bridge, consisting of bridge priority plus MAC address. This ID is the same for Root Bridge and Our Bridge if the Switch is the root switch.
Hello Time (seconds)	This is the time interval (in seconds) at which the root switch transmits a configuration message. The root bridge determines Hello Time , Max Age and Forwarding Delay .
Max Age (seconds)	This is the maximum time (in seconds) the Switch can wait without receiving a configuration message before attempting to reconfigure.
Forwarding Delay (seconds)	This is the time (in seconds) the root switch will wait before changing states (that is, listening to learning to forwarding). Note: The listening state does NOT exist in RSTP.
Cost to Bridge	This is the path cost from the root port on this Switch to the root switch.
Port ID	This is the priority and number of the port on the Switch through which this Switch must communicate with the root of the Spanning Tree.
Topology Changed Times	This is the number of times the spanning tree has been reconfigured.
Time Since Last Change	This is the time since the spanning tree was last reconfigured.

Table 191 SWITCHING > Spanning Tree Protocol > Spanning Tree Protocol Status: RSTP (continued)

LABEL	DESCRIPTION
SLOT	This field appears only in Stacking mode. Click the drop-down list to choose the slot number of the Switch in a stack.
Port	This field displays the number of the port on the Switch. In Stacking mode, the first number represents the slot ID and the second is the port number.
Port State	This field displays the port state in STP. <ul style="list-style-type: none"> • DISCARDING – The port does not forward or process received frames or learn MAC addresses, but still listens for BPDUs. • LEARNING – The port learns MAC addresses and processes BPDUs, but does NOT forward frames yet. • FORWARDING – The port is operating normally. It learns MAC addresses, processes BPDUs and forwards received frames.
Port Role	This field displays the role of the port in STP. <ul style="list-style-type: none"> • Root – A forwarding port on a non-root bridge, which has the lowest path cost and is the best port from the non-root bridge to the root bridge. A root bridge does NOT have a root port. • Designated – A forwarding port on the designated bridge for each connected LAN segment. A designated bridge has the lowest path cost to the root bridge among the bridges connected to the LAN segment. All the ports on a root bridge (root switch) are designated ports. • Alternate – A blocked port, which has a best alternate path to the root bridge. This path is different from using the root port. The port moves to the forwarding state when the designated port for the LAN segment fails. • Backup – A blocked port, which has a backup or redundant path to a LAN segment where a designated port is already connected when a switch has two links to the same LAN segment. • Disabled – Not strictly part of STP. The port can be disabled manually.
Designated Bridge ID	This field displays the identifier of the designated bridge to which this port belongs when the port is a designated port. Otherwise, it displays the identifier of the designated bridge for the LAN segment to which this port is connected.
Designated Port ID	This field displays the priority and number of the bridge port (on the designated bridge), through which the designated bridge transmits the stored configuration messages.
Designated Cost	This field displays the path cost to the LAN segment to which the port is connected when the port is a designated port. Otherwise, it displays the path cost to the root bridge from the designated port for the LAN segment to which this port is connected.
Root Guard State	This field displays the state of the port on which root guard is enabled. <ul style="list-style-type: none"> • Root-inconsistent – the Switch receives superior BPDUs on the port and blocks the port. • Forwarding – the Switch unblocks and allows the port to forward frames again.

54.5 Configure Rapid Spanning Tree Protocol

Use this screen to configure RSTP settings, see [Section 54.1 on page 378](#) for more information on RSTP. Click **SWITCHING > Spanning Tree Protocol > RSTP** in the navigation panel to display the screen as shown.

Figure 300 SWITCHING > Spanning Tree Protocol > RSTP (Standalone Mode)

Rapid Spanning Tree Protocol

Active OFF

Bridge Priority ▾

Hello Time seconds

MAX Age seconds

Forwarding Delay seconds

Port	Active	Edge	Root Guard	Priority	Path Cost
*	<input type="checkbox"/>	<input type="checkbox"/>	<input type="checkbox"/>	<input type="text"/>	<input type="text"/>
1	<input type="checkbox"/>	<input type="checkbox"/>	<input type="checkbox"/>	<input type="text" value="128"/>	<input type="text" value="2"/>
2	<input type="checkbox"/>	<input type="checkbox"/>	<input type="checkbox"/>	<input type="text" value="128"/>	<input type="text" value="2"/>
3	<input type="checkbox"/>	<input type="checkbox"/>	<input type="checkbox"/>	<input type="text" value="128"/>	<input type="text" value="2"/>
4	<input type="checkbox"/>	<input type="checkbox"/>	<input type="checkbox"/>	<input type="text" value="128"/>	<input type="text" value="2"/>
5	<input type="checkbox"/>	<input type="checkbox"/>	<input type="checkbox"/>	<input type="text" value="128"/>	<input type="text" value="2"/>
6	<input type="checkbox"/>	<input type="checkbox"/>	<input type="checkbox"/>	<input type="text" value="128"/>	<input type="text" value="2"/>
7	<input type="checkbox"/>	<input type="checkbox"/>	<input type="checkbox"/>	<input type="text" value="128"/>	<input type="text" value="2"/>

Figure 301 SWITCHING > Spanning Tree Protocol > RSTP (Stacking Mode)

Rapid Spanning Tree Protocol

Active OFF

Bridge Priority ▼

Hello Time seconds

MAX Age seconds

Forwarding Delay seconds

▼

Port	Active	Edge	Root Guard	Priority	Path Cost
1/*	<input type="checkbox"/>	<input type="checkbox"/>	<input type="checkbox"/>	<input type="text"/>	<input type="text"/>
1/1	<input type="checkbox"/>	<input type="checkbox"/>	<input type="checkbox"/>	<input type="text" value="128"/>	<input type="text" value="2"/>
1/2	<input type="checkbox"/>	<input type="checkbox"/>	<input type="checkbox"/>	<input type="text" value="128"/>	<input type="text" value="2"/>
1/3	<input type="checkbox"/>	<input type="checkbox"/>	<input type="checkbox"/>	<input type="text" value="128"/>	<input type="text" value="2"/>
1/4	<input type="checkbox"/>	<input type="checkbox"/>	<input type="checkbox"/>	<input type="text" value="128"/>	<input type="text" value="2"/>
1/5	<input type="checkbox"/>	<input type="checkbox"/>	<input type="checkbox"/>	<input type="text" value="128"/>	<input type="text" value="2"/>
1/6	<input type="checkbox"/>	<input type="checkbox"/>	<input type="checkbox"/>	<input type="text" value="128"/>	<input type="text" value="2"/>
1/7	<input type="checkbox"/>	<input type="checkbox"/>	<input type="checkbox"/>	<input type="text" value="128"/>	<input type="text" value="2"/>

The following table describes the labels in this screen.

Table 192 SWITCHING > Spanning Tree Protocol > RSTP

LABEL	DESCRIPTION
Active	<p>Enable the switch button to activate RSTP. Disable the switch to disable RSTP.</p> <p>Note: You must also activate Rapid Spanning Tree (RSTP) in the SWITCHING > Spanning Tree Protocol > Spanning Tree Setup screen to enable RSTP on the Switch.</p>
Bridge Priority	<p>Bridge priority is used in determining the root switch, root port and designated port. The Switch with the highest priority (lowest numeric value) becomes the STP root switch. If all Switches have the same priority, the Switch with the lowest MAC address will then become the root switch. Select a value from the drop-down list box.</p> <p>The lower the numeric value you assign, the higher the priority for this bridge.</p> <p>Bridge Priority determines the root bridge, which in turn determines Hello Time, Max Age and Forwarding Delay.</p>
Hello Time	<p>This is the time interval in seconds between BPDU (Bridge Protocol Data Units) configuration message generations by the root switch. The allowed range is 1 to 10 seconds.</p>

Table 192 SWITCHING > Spanning Tree Protocol > RSTP (continued)

LABEL	DESCRIPTION
Max Age	This is the maximum time (in seconds) the Switch can wait without receiving a BPDU before attempting to reconfigure. All Switch ports (except for designated ports) should receive BPDUs at regular intervals. Any port that ages out STP information (provided in the last BPDU) becomes the designated port for the attached LAN. If it is a root port, a new root port is selected from among the Switch ports attached to the network. The allowed range is 6 to 40 seconds.
Forwarding Delay	This is the maximum time (in seconds) the Switch will wait before changing states. This delay is required because every Switch must receive information about topology changes before it starts to forward frames. In addition, each port needs time to listen for conflicting information that would make it return to a blocking state; otherwise, temporary data loops might result. The allowed range is 4 to 30 seconds. As a general rule: $2 * (\text{Forward Delay} - 1) \geq \text{Max Age} \geq 2 * (\text{Hello Time} + 1)$
SLOT	This field appears only in Stacking mode. Click the drop-down list to choose the slot number of the Switch in a stack.
Port	This field displays the port number. In Stacking mode, the first number represents the slot ID and the second is the port number. Please note that the default stacking ports (the last four ports of your Switch) cannot be configured. They are reserved for stacking only.
*	Settings in this row apply to all ports. Use this row only if you want to make some settings the same for all ports. Use this row first to set the common settings and then make adjustments on a port-by-port basis. Note: Changes in this row are copied to all the ports as soon as you make them.
Active	Select this check box to activate RSTP on this port.
Edge	Select this check box to configure a port as an edge port when it is directly attached to a computer. An edge port changes its initial STP port state from blocking state to forwarding state immediately without going through listening and learning states right after the port is configured as an edge port or when its link status changes. Note: An edge port becomes a non-edge port as soon as it receives a Bridge Protocol Data Unit (BPDU).
Root Guard	Select this check box to enable root guard on this port in order to prevent the switches attached to the port from becoming the root bridge. With root guard enabled, a port is blocked when the Switch receives a superior BPDU on it. The Switch allows traffic to pass through this port again when the switch connected to the port stops to send superior BPDUs.
Priority	Configure the priority for each port here. Priority decides which port should be disabled when more than one port forms a loop in a switch. Ports with a higher priority numeric value are disabled first. The allowed range is between 0 and 255 and the default value is 128.
Path Cost	Path cost is the cost of transmitting a frame on to a LAN through that port. It is recommended to assign this value according to the speed of the bridge. The slower the media, the higher the cost. Note: Set the value to 0 to use the auto path cost you set in the SWITCHING > Spanning Tree Protocol > Spanning Tree Setup screen (see Auto Path-cost Mode).
Apply	Click Apply to save your changes to the Switch's run-time memory. The Switch loses these changes if it is turned off or loses power, so use the Save link on the top navigation panel to save your changes to the non-volatile memory when you are done configuring.
Cancel	Click Cancel to begin configuring this screen afresh.

54.6 Multiple Rapid Spanning Tree Protocol

Click **SWITCHING** > **Spanning Tree Protocol** > **Spanning Tree Protocol Status** in the navigation panel to display the status screen as shown next. See [Section 54.6 on page 391](#) for more information on MRSTP.

Note: This screen is only available after you activate MRSTP on the Switch.

Figure 302 SWITCHING > Spanning Tree Protocol > Spanning Tree Protocol Status: MRSTP (Standalone Mode)

Spanning Tree Protocol Status						
Spanning Tree Protocol: MRSTP						
Tree <input type="text" value="1"/>						
	Root Bridge		Our Bridge			
Bridge ID	6666-bc6666cbc666		6666-bc6666cbc666			
Hello Time (seconds)	2		2			
Max Age (seconds)	20		20			
Forwarding Delay (seconds)	15		15			
Cost to Bridge	0					
Port ID	0x0000					
Topology Changed Times	4					
Time Since Last Change	0:02:12					

Port	Port State	Port Role	Designated Bridge ID	Designated Port ID	Designated Cost	Root Guard State
1	DISCARDING	Disabled	0000-000000000000	0x0000	0	Forwarding
2	FORWARDING	Designated	6666-bc6666cbc666	0x8012	0	Forwarding
5	DISCARDING	Disabled	0000-000000000000	0x0000	0	Forwarding
6	FORWARDING	Designated	6666-bc6666cbc666	0x8016	0	Forwarding
7	DISCARDING	Disabled	0000-000000000000	0x0000	0	Forwarding

Figure 303 SWITCHING > Spanning Tree Protocol > Spanning Tree Protocol Status: MRSTP (Stacking Mode)

Spanning Tree Protocol Status						
Spanning Tree Protocol: MRSTP						
Tree 1 ▾						
	Root Bridge			Our Bridge		
Bridge ID	6666-bc6666cbc666			6666-bc6666cbc666		
Hello Time (seconds)	2			2		
Max Age (seconds)	20			20		
Forwarding Delay (seconds)	15			15		
Cost to Bridge	0					
Port ID	0x0000					
Topology Changed Times	4					
Time Since Last Change	0:02:12					
SLOT 1 ▾						
Port	Port State	Port Role	Designated Bridge ID	Designated Port ID	Designated Cost	Root Guard State
1/1	DISCARDING	Disabled	0000-000000000000	0x0000	0	Forwarding
1/2	FORWARDING	Designated	6666-bc6666cbc666	0x8012	0	Forwarding
1/5	DISCARDING	Disabled	0000-000000000000	0x0000	0	Forwarding
1/6	FORWARDING	Designated	6666-bc6666cbc666	0x8016	0	Forwarding
1/7	DISCARDING	Disabled	0000-000000000000	0x0000	0	Forwarding

The following table describes the labels in this screen.

Table 193 SWITCHING > Spanning Tree Protocol > Spanning Tree Protocol Status: MRSTP

LABEL	DESCRIPTION
Tree	Select which STP tree configuration you want to view.
Bridge	Root Bridge refers to the base of the spanning tree (the root bridge). Our Bridge is this switch. This Switch may also be the root bridge.
Bridge ID	This is the unique identifier for this bridge, consisting of bridge priority plus MAC address. This ID is the same for Root Bridge and Our Bridge if the Switch is the root switch.
Hello Time (seconds)	This is the time interval (in seconds) at which the root switch transmits a configuration message. The root bridge determines Hello Time , Max Age and Forwarding Delay .
Max Age (seconds)	This is the maximum time (in seconds) the Switch can wait without receiving a configuration message before attempting to reconfigure.
Forwarding Delay (seconds)	This is the time (in seconds) the root switch will wait before changing states (that is, listening to learning to forwarding). Note: The listening state does not exist in RSTP.
Cost to Bridge	This is the path cost from the root port on this Switch to the root switch.

Table 193 SWITCHING > Spanning Tree Protocol > Spanning Tree Protocol Status: MRSTP (continued)

LABEL	DESCRIPTION
Port ID	This is the priority and number of the port on the Switch through which this Switch must communicate with the root of the Spanning Tree.
Topology Changed Times	This is the number of times the spanning tree has been reconfigured.
Time Since Last Change	This is the time since the spanning tree was last reconfigured.
SLOT	This field appears only in Stacking mode. Click the drop-down list to choose the slot number of the Switch in a stack.
Port	This field displays the number of the port on the Switch. In Stacking mode, the first number represents the slot ID and the second is the port number.
Port State	This field displays the port state in STP. <ul style="list-style-type: none"> • DISCARDING – The port does not forward or process received frames or learn MAC addresses, but still listens for BPDUs. • LEARNING – The port learns MAC addresses and processes BPDUs, but does not forward frames yet. • FORWARDING – The port is operating normally. It learns MAC addresses, processes BPDUs and forwards received frames.
Port Role	This field displays the role of the port in STP. <ul style="list-style-type: none"> • Root – A forwarding port on a non-root bridge, which has the lowest path cost and is the best port from the non-root bridge to the root bridge. A root bridge does not have a root port. • Designated – A forwarding port on the designated bridge for each connected LAN segment. A designated bridge has the lowest path cost to the root bridge among the bridges connected to the LAN segment. All the ports on a root bridge (root switch) are designated ports. • Alternate – A blocked port, which has a best alternate path to the root bridge. This path is different from using the root port. The port moves to the forwarding state when the designated port for the LAN segment fails. • Backup – A blocked port, which has a backup or redundant path to a LAN segment where a designated port is already connected when a switch has two links to the same LAN segment. • Disabled – Not strictly part of STP. The port can be disabled manually.
Designated Bridge ID	This field displays the identifier of the designated bridge to which this port belongs when the port is a designated port. Otherwise, it displays the identifier of the designated bridge for the LAN segment to which this port is connected.
Designated Port ID	This field displays the priority and number of the bridge port (on the designated bridge), through which the designated bridge transmits the stored configuration messages.
Designated Cost	This field displays the path cost to the LAN segment to which the port is connected when the port is a designated port. Otherwise, it displays the path cost to the root bridge from the designated port for the LAN segment to which this port is connected.
Root Guard State	This field displays the state of the port on which root guard is enabled. <ul style="list-style-type: none"> • Root – inconsistent – the Switch receives superior BPDUs on the port and blocks the port. • Forwarding – the Switch unblocks and allows the port to forward frames again.

54.7 Configure Multiple Rapid Spanning Tree Protocol

To configure MRSTP, click **SWITCHING > Spanning Tree Protocol > MRSTP** in the navigation panel to display the screen as shown.

Figure 304 SWITCHING > Spanning Tree Protocol > MRSTP (Standalone Mode)

Multiple Rapid Spanning Tree Protocol

Tree	Active	Bridge Priority	Hello Time	MAX Age	Forwarding Delay
1	<input type="checkbox"/>	32768 ▾	2 seconds	20 seconds	15 seconds
2	<input type="checkbox"/>	32768 ▾	2 seconds	20 seconds	15 seconds
3	<input type="checkbox"/>	32768 ▾	2 seconds	20 seconds	15 seconds
4	<input type="checkbox"/>	32768 ▾	2 seconds	20 seconds	15 seconds

Port	Active	Edge	Root Guard	Priority	Path Cost	Tree
*	<input type="checkbox"/>	<input type="checkbox"/>	<input type="checkbox"/>			1 ▾
1	<input type="checkbox"/>	<input type="checkbox"/>	<input type="checkbox"/>	128	2	1 ▾
2	<input type="checkbox"/>	<input type="checkbox"/>	<input type="checkbox"/>	128	2	1 ▾
3	<input type="checkbox"/>	<input type="checkbox"/>	<input type="checkbox"/>	128	2	1 ▾
4	<input type="checkbox"/>	<input type="checkbox"/>	<input type="checkbox"/>	128	2	1 ▾
5	<input type="checkbox"/>	<input type="checkbox"/>	<input type="checkbox"/>	128	2	1 ▾
6	<input type="checkbox"/>	<input type="checkbox"/>	<input type="checkbox"/>	128	2	1 ▾
7	<input type="checkbox"/>	<input type="checkbox"/>	<input type="checkbox"/>	128	2	1 ▾

Figure 305 SWITCHING > Spanning Tree Protocol > MRSTP (Stacking Mode)

Multiple Rapid Spanning Tree Protocol

Tree	Active	Bridge Priority	Hello Time	MAX Age	Forwarding Delay
1	<input type="checkbox"/>	32768 ▾	2 seconds	20 seconds	15 seconds
2	<input type="checkbox"/>	32768 ▾	2 seconds	20 seconds	15 seconds
3	<input type="checkbox"/>	32768 ▾	2 seconds	20 seconds	15 seconds
4	<input type="checkbox"/>	32768 ▾	2 seconds	20 seconds	15 seconds

SLOT 1 ▾

Port	Active	Edge	Root Guard	Priority	Path Cost	Tree
1/*	<input type="checkbox"/>	<input type="checkbox"/>	<input type="checkbox"/>			1 ▾
1/1	<input type="checkbox"/>	<input type="checkbox"/>	<input type="checkbox"/>	128	2	1 ▾
1/2	<input type="checkbox"/>	<input type="checkbox"/>	<input type="checkbox"/>	128	2	1 ▾
1/3	<input type="checkbox"/>	<input type="checkbox"/>	<input type="checkbox"/>	128	2	1 ▾
1/4	<input type="checkbox"/>	<input type="checkbox"/>	<input type="checkbox"/>	128	2	1 ▾
1/5	<input type="checkbox"/>	<input type="checkbox"/>	<input type="checkbox"/>	128	2	1 ▾
1/6	<input type="checkbox"/>	<input type="checkbox"/>	<input type="checkbox"/>	128	2	1 ▾
1/7	<input type="checkbox"/>	<input type="checkbox"/>	<input type="checkbox"/>	128	2	1 ▾
1/8	<input type="checkbox"/>	<input type="checkbox"/>	<input type="checkbox"/>	128	2	1 ▾

The following table describes the labels in this screen.

Table 194 SWITCHING > Spanning Tree Protocol > MRSTP

LABEL	DESCRIPTION
Tree	This is the index number of the STP trees.
Active	Select this check box to activate an STP tree. Clear this check box to disable an STP tree. Note: You must also activate Multiple Rapid Spanning Tree (MRSTP) in the SWITCHING > Spanning Tree Protocol > Spanning Tree Setup screen to enable MRSTP on the Switch.
Bridge Priority	Bridge priority is used in determining the root switch, root port and designated port. The switch with the highest priority (lowest numeric value) becomes the STP root switch. If all switches have the same priority, the switch with the lowest MAC address will then become the root switch. Select a value from the drop-down list box. The lower the numeric value you assign, the higher the priority for this bridge. Bridge Priority determines the root bridge, which in turn determines Hello Time , Max Age and Forwarding Delay .
Hello Time	This is the time interval in seconds between BPDU (Bridge Protocol Data Units) configuration message generations by the root switch. The allowed range is 1 to 10 seconds.

Table 194 SWITCHING > Spanning Tree Protocol > MRSTP (continued)

LABEL	DESCRIPTION
Max Age	This is the maximum time (in seconds) the Switch can wait without receiving a BPDU before attempting to reconfigure. All Switch ports (except for designated ports) should receive BPDUs at regular intervals. Any port that ages out STP information (provided in the last BPDU) becomes the designated port for the attached LAN. If it is a root port, a new root port is selected from among the Switch ports attached to the network. The allowed range is 6 to 40 seconds.
Forwarding Delay	This is the maximum time (in seconds) the Switch will wait before changing states. This delay is required because every switch must receive information about topology changes before it starts to forward frames. In addition, each port needs time to listen for conflicting information that would make it return to a blocking state; otherwise, temporary data loops might result. The allowed range is 4 to 30 seconds. As a general rule: $2 * (\text{Forward Delay} - 1) \geq \text{Max Age} \geq 2 * (\text{Hello Time} + 1)$
SLOT	This field appears only in Stacking mode. Click the drop-down list to choose the slot number of the Switch in a stack.
Port	This field displays the port number. In Stacking mode, the first number represents the slot ID and the second is the port number. Please note that the default stacking ports (the last four ports of your Switch) cannot be configured. They are reserved for stacking only.
*	Settings in this row apply to all ports. Use this row only if you want to make some settings the same for all ports. Use this row first to set the common settings and then make adjustments on a port-by-port basis. Note: Changes in this row are copied to all the ports as soon as you make them.
Active	Select this check box to activate STP on this port.
Edge	Select this check box to configure a port as an edge port when it is directly attached to a computer. An edge port changes its initial STP port state from blocking state to forwarding state immediately without going through listening and learning states right after the port is configured as an edge port or when its link status changes. Note: An edge port becomes a non-edge port as soon as it receives a Bridge Protocol Data Unit (BPDU).
Root Guard	Select this check box to enable root guard on this port in order to prevent the switch(es) attached to the port from becoming the root bridge. With root guard enabled, a port is blocked when the Switch receives a superior BPDU on it. The Switch allows traffic to pass through this port again when the switch connected to the port stops to send superior BPDUs.
Priority	Configure the priority for each port here. Priority decides which port should be disabled when more than one port forms a loop in a switch. Ports with a higher priority numeric value are disabled first. The allowed range is between 0 and 255 and the default value is 128.
Path Cost	Path cost is the cost of transmitting a frame on to a LAN through that port. It is recommended to assign this value according to the speed of the bridge. The slower the media, the higher the cost. Note: Set the value to 0 to use the auto path cost you set in the SWITCHING > Spanning Tree Protocol > Spanning Tree Setup screen (see Auto Path-cost Mode).
Tree	Select which STP tree configuration this port should participate in.

Table 194 SWITCHING > Spanning Tree Protocol > MRSTP (continued)

LABEL	DESCRIPTION
Apply	Click Apply to save your changes to the Switch's run-time memory. The Switch loses these changes if it is turned off or loses power, so use the Save link on the top navigation panel to save your changes to the non-volatile memory when you are done configuring.
Cancel	Click Cancel to begin configuring this screen afresh.

54.8 Multiple Spanning Tree Protocol Status

Click **SWITCHING** > **Spanning Tree Protocol** > **Spanning Tree Protocol Status** in the navigation panel to display the status screen as shown next.

Note: This screen is only available after you activate MSTP on the Switch.

Figure 306 SWITCHING > Spanning Tree Protocol > Spanning Tree Protocol Status: MSTP (Standalone Mode)

Spanning Tree Protocol Status						
Spanning Tree Protocol: MSTP						
CST						
	Root Bridge		Our Bridge			
Bridge ID	6666-bc6666cbc666		6666-bc6666cbc666			
Hello Time (seconds)	2		2			
Max Age (seconds)	20		20			
Forwarding Delay (seconds)	15		15			
Cost to Bridge	0		0			
Port ID	0x0000		0x0000			
Configuration Name	bc6666cbc666					
Revision Number	0					
Configuration Digest	AC36177F50283CD4B83821D8AB26DE62					
Topology Changed Times	0					
Time Since Last Change	0:22:49					
Instance						
Instance	VLAN					
0	1-4094					
MSTI 1 <input type="button" value="v"/>						
	Regional Root		Our Bridge			
Bridge ID	0000-000000000000		8001-000000000000			
Internal Cost	0		0			
Port ID	0x0000		0x0000			
Port	Port State	Port Role	Designated Bridge ID	Designated Port ID	Designated Cost	Root Guard State

Figure 307 SWITCHING > Spanning Tree Protocol > Spanning Tree Protocol Status: MSTP (Stacking Mode)

Spanning Tree Protocol Status

Spanning Tree Protocol: MSTP

CST

	Root Bridge	Our Bridge
Bridge ID	6666-bc6666cbc666	6666-bc6666cbc666
Hello Time (seconds)	2	2
Max Age (seconds)	20	20
Forwarding Delay (seconds)	15	15
Cost to Bridge	0	0
Port ID	0x0000	0x0000
Configuration Name	bc6666cbc666	
Revision Number	0	
Configuration Digest	AC36177F50283CD4B83821D8AB26DE62	
Topology Changed Times	0	
Time Since Last Change	0:22:49	

Instance

Instance	VLAN
0	1-4094

MSTI 1 ▼

	Regional Root	Our Bridge
Bridge ID	0000-000000000000	8001-000000000000
Internal Cost	0	0
Port ID	0x0000	0x0000

SLOT 1 ▼

Port	Port State	Port Role	Designated Bridge ID	Designated Port ID	Designated Cost	Root Guard State

The following table describes the labels in this screen.

Table 195 SWITCHING > Spanning Tree Protocol > Spanning Tree Protocol Status: MSTP

LABEL	DESCRIPTION
CST	This section describes the Common Spanning Tree settings.
Bridge	Root Bridge refers to the base of the spanning tree (the root bridge). Our Bridge is this switch. This Switch may also be the root bridge.
Bridge ID	This is the unique identifier for this bridge, consisting of bridge priority plus MAC address. This ID is the same for Root Bridge and Our Bridge if the Switch is the root switch.

Table 195 SWITCHING > Spanning Tree Protocol > Spanning Tree Protocol Status: MSTP (continued)

LABEL	DESCRIPTION
Hello Time (seconds)	This is the time interval (in seconds) at which the root switch transmits a configuration message. The root bridge determines Hello Time , Max Age and Forwarding Delay .
Max Age (seconds)	This is the maximum time (in seconds) the Switch can wait without receiving a configuration message before attempting to reconfigure.
Forwarding Delay (seconds)	This is the time (in seconds) the root switch will wait before changing states (that is, listening to learning to forwarding).
Cost to Bridge	This is the path cost from the root port on this Switch to the root switch.
Port ID	This is the priority and number of the port on the Switch through which this Switch must communicate with the root of the Spanning Tree.
Configuration Name	This field displays the configuration name for this MST region.
Revision Number	This field displays the revision number for this MST region.
Configuration Digest	A configuration digest is generated from the VLAN-MSTI mapping information. This field displays the 16-octet signature that is included in an MSTP BPDU. This field displays the digest when MSTP is activated on the system.
Topology Changed Times	This is the number of times the spanning tree has been reconfigured.
Time Since Last Change	This is the time since the spanning tree was last reconfigured.
Instance	These fields display the MSTI to VLAN mapping. In other words, which VLANs run on each spanning tree instance.
Instance	This field displays the MSTI ID.
VLAN	This field displays which VLANs are mapped to an MSTI.
MSTI	
MSTI	Select the MST instance settings you want to view.
	Regional Root refers to the base of the MST instance. Our Bridge is this switch. This Switch may also be the root bridge.
Bridge ID	This is the unique identifier for this bridge, consisting of bridge priority plus MAC address. This ID is the same for Regional Root and Our Bridge if the Switch is the root switch.
Internal Cost	This is the path cost from the root port in this MST instance to the regional root switch.
Port ID	This is the priority and number of the port on the Switch through which this Switch must communicate with the root of the MST instance.
SLOT	This field appears only in Stacking mode. Click the drop-down list to choose the slot number of the Switch in a stack.
Port	This field displays the number of the port on the Switch. In Stacking mode, the first number represents the slot ID and the second is the port number.
Port State	This field displays the port state in STP. <ul style="list-style-type: none"> • DISCARDING – The port does not forward or process received frames or learn MAC addresses, but still listens for BPDUs. • LEARNING – The port learns MAC addresses and processes BPDUs, but does not forward frames yet. • FORWARDING – The port is operating normally. It learns MAC addresses, processes BPDUs and forwards received frames.

Table 195 SWITCHING > Spanning Tree Protocol > Spanning Tree Protocol Status: MSTP (continued)

LABEL	DESCRIPTION
Port Role	<p>This field displays the role of the port in STP.</p> <ul style="list-style-type: none"> • Root – A forwarding port on a non-root bridge, which has the lowest path cost and is the best port from the non-root bridge to the root bridge. A root bridge does not have a root port. • Designated – A forwarding port on the designated bridge for each connected LAN segment. A designated bridge has the lowest path cost to the root bridge among the bridges connected to the LAN segment. All the ports on a root bridge (root switch) are designated ports. • Alternate – A blocked port, which has a best alternate path to the root bridge. This path is different from using the root port. The port moves to the forwarding state when the designated port for the LAN segment fails. • Backup – A blocked port, which has a backup or redundant path to a LAN segment where a designated port is already connected when a switch has two links to the same LAN segment. • Disabled – Not strictly part of STP. The port can be disabled manually.
Designated Bridge ID	<p>This field displays the identifier of the designated bridge to which this port belongs when the port is a designated port. Otherwise, it displays the identifier of the designated bridge for the LAN segment to which this port is connected.</p>
Designated Port ID	<p>This field displays the priority and number of the bridge port (on the designated bridge), through which the designated bridge transmits the stored configuration messages.</p>
Designated Cost	<p>This field displays the path cost to the LAN segment to which the port is connected when the port is a designated port. Otherwise, it displays the path cost to the root bridge from the designated port for the LAN segment to which this port is connected.</p>
Root Guard State	<p>This field displays the state of the port on which root guard is enabled.</p> <ul style="list-style-type: none"> • Root-inconsistent – the Switch receives superior BPDUs on the port and blocks the port. • Forwarding – the Switch unblocks and allows the port to forward frames again.

54.9 Configure Multiple Spanning Tree Protocol

To configure MSTP, click **SWITCHING > Spanning Tree Protocol > MSTP** in the navigation panel to display the screen as shown.

Figure 308 SWITCHING > Spanning Tree Protocol > MSTP > Multiple Spanning Tree Protocol

Multiple Spanning Tree Protocol MSTP Port Setup

Bridge

Active ON

Hello Time seconds

MAX Age seconds

Forwarding Delay seconds

Maximum Hops

Configuration Name

Revision Number

Instance

<input type="checkbox"/>	Instance	VLAN	Active Port
<input type="checkbox"/>	0	1-4094	-

The following table describes the labels in this screen.

Table 196 SWITCHING > Spanning Tree Protocol > MSTP > Multiple Spanning Tree Protocol

LABEL	DESCRIPTION
Bridge	
Active	Enable the switch button to activate MSTP on the Switch. Disable the switch to disable MSTP on the Switch. Note: You must also activate Multiple Spanning Tree (MSTP) in the SWITCHING > Spanning Tree Protocol > Spanning Tree Setup screen to enable MSTP on the Switch.
Hello Time	This is the time interval in seconds between BPDU (Bridge Protocol Data Units) configuration message generations by the root switch. The allowed range is 1 to 10 seconds.
Max Age	This is the maximum time (in seconds) a switch can wait without receiving a BPDU before attempting to reconfigure. All switch ports (except for designated ports) should receive BPDUs at regular intervals. Any port that ages out STP information (provided in the last BPDU) becomes the designated port for the attached LAN. If it is a root port, a new root port is selected from among the Switch ports attached to the network. The allowed range is 6 to 40 seconds.
Forwarding Delay	This is the maximum time (in seconds) a switch will wait before changing states. This delay is required because every switch must receive information about topology changes before it starts to forward frames. In addition, each port needs time to listen for conflicting information that would make it return to a blocking state; otherwise, temporary data loops might result. The allowed range is 4 to 30 seconds. As a general rule: Note: $2 * (\text{Forward Delay} - 1) \geq \text{Max Age} \geq 2 * (\text{Hello Time} + 1)$
Maximum hops	Enter the number of hops (between 1 and 255) in an MSTP region before the BPDU is discarded and the port information is aged.
Configuration Name	Enter a descriptive name (up to 32 printable ASCII characters except [?], [], ['], ["], or [,]) of an MST region.

Table 196 SWITCHING > Spanning Tree Protocol > MSTP > Multiple Spanning Tree Protocol (continued)

LABEL	DESCRIPTION
Revision Number	Enter a number to identify a region's configuration. Devices must have the same revision number to belong to the same region.
Apply	Click Apply to save your changes to the Switch's run-time memory. The Switch loses these changes if it is turned off or loses power, so use the Save link on the top navigation panel to save your changes to the non-volatile memory when you are done configuring.
Cancel	Click Cancel to begin configuring this screen afresh.
Instance	
Use this section to configure MSTI (Multiple Spanning Tree Instance) settings.	
Instance	This field displays the ID of an MST instance.
VLAN	This field displays the VID (or VID ranges) to which the MST instance is mapped.
Active Port	This field display the ports configured to participate in the MST instance.
	Select an entry's check box to select a specific entry. Otherwise, select the check box in the table heading row to select all entries.
Add/Edit	Click Add/Edit to add a new instance or edit a selected one.
Delete	Click Delete to remove the selected instances.

54.9.1 Add/Edit Multiple Spanning Tree

Click **Add/Edit**, or select an entry and click **Add/Edit** in the **SWITCHING > Spanning Tree Protocol > MSTP > Multiple Spanning Tree Protocol** screen to display this screen.

Figure 309 SWITCHING > Spanning Tree Protocol > MSTP > Multiple Spanning Tree Protocol > Add/Edit (Standalone Mode)

Instance

Bridge Priority

VLAN List

Port	Active	Priority	Path Cost
*	<input type="checkbox"/>	<input type="text"/>	<input type="text"/>
1	<input type="checkbox"/>	<input type="text" value="128"/>	<input type="text" value="2"/>
2	<input type="checkbox"/>	<input type="text" value="128"/>	<input type="text" value="2"/>
3	<input type="checkbox"/>	<input type="text" value="128"/>	<input type="text" value="2"/>
4	<input type="checkbox"/>	<input type="text" value="128"/>	<input type="text" value="2"/>
5	<input type="checkbox"/>	<input type="text" value="128"/>	<input type="text" value="2"/>
6	<input type="checkbox"/>	<input type="text" value="128"/>	<input type="text" value="2"/>
7	<input type="checkbox"/>	<input type="text" value="128"/>	<input type="text" value="2"/>

Figure 310 SWITCHING > Spanning Tree Protocol > MSTP > Multiple Spanning Tree Protocol > Add/Edit (Stacking Mode)

Instance

Bridge Priority

VLAN List

Port	Active	Priority	Path Cost
1/*	<input type="checkbox"/>	<input type="text"/>	<input type="text"/>
1/1	<input type="checkbox"/>	<input type="text" value="128"/>	<input type="text" value="2"/>
1/2	<input type="checkbox"/>	<input type="text" value="128"/>	<input type="text" value="2"/>
1/3	<input type="checkbox"/>	<input type="text" value="128"/>	<input type="text" value="2"/>
1/4	<input type="checkbox"/>	<input type="text" value="128"/>	<input type="text" value="2"/>
1/5	<input type="checkbox"/>	<input type="text" value="128"/>	<input type="text" value="2"/>
1/6	<input type="checkbox"/>	<input type="text" value="128"/>	<input type="text" value="2"/>
1/7	<input type="checkbox"/>	<input type="text" value="128"/>	<input type="text" value="2"/>

The following table describes the labels in this screen.

Table 197 SWITCHING > Spanning Tree Protocol > MSTP > Multiple Spanning Tree Protocol > Add/Edit

LABEL	DESCRIPTION
Instance	Enter the number you want to use to identify this MST instance on the Switch. The Switch supports instance numbers 0 – 16.
Bridge Priority	Set the priority of the Switch for the specific spanning tree instance. The lower the number, the more likely the Switch will be chosen as the root bridge within the spanning tree instance. Enter priority values between 0 and 61440 in increments of 4096 (thus valid values are 4096, 8192, 12288, 16384, 20480, 24576, 28672, 32768, 36864, 40960, 45056, 49152, 53248, 57344 and 61440).
VLAN List	Enter the VLAN ID range. You can specify multiple VLAN ID range separated by (no space) comma (,) or hyphen ("-") for a range. For example, enter "1,3,5-7" for VLANs 1, 3, 5, 6, and 7.
SLOT	This field appears only in Stacking mode. Click the drop-down list to choose the slot number of the Switch in a stack.
Port	This field displays the port number. In Stacking mode, the first number represents the slot ID and the second is the port number. Please note that the default stacking ports (the last four ports of your Switch) cannot be configured. They are reserved for stacking only.
*	Settings in this row apply to all ports. Use this row only if you want to make some settings the same for all ports. Use this row first to set the common settings and then make adjustments on a port-by-port basis. Note: Changes in this row are copied to all the ports as soon as you make them.
Active	Select this check box to add this port to the MST instance.

Table 197 SWITCHING > Spanning Tree Protocol > MSTP > Multiple Spanning Tree Protocol > Add/Edit

LABEL	DESCRIPTION
Priority	Configure the priority for each port here. Priority decides which port should be disabled when more than one port forms a loop in the Switch. Ports with a higher priority numeric value are disabled first. The allowed range is between 0 and 255 and the default value is 128.
Path Cost	Path cost is the cost of transmitting a frame on to a LAN through that port. It is recommended to assign this value according to the speed of the bridge. The slower the media, the higher the cost. Note: Set the value to 0 to use the auto path cost you set in the SWITCHING > Spanning Tree Protocol > Spanning Tree Setup screen (see Auto Path-cost Mode).
Apply	Click Apply to save your changes to the Switch's run-time memory. The Switch loses these changes if it is turned off or loses power, so use the Save link on the top navigation panel to save your changes to the non-volatile memory when you are done configuring.
Clear	Click Clear to clear the fields to the factory defaults.
Cancel	Click Cancel to not save the configuration you make and return to the last screen.

54.10 Multiple Spanning Tree Protocol Port Setup

Click **SWITCHING > Spanning Tree Protocol > MSTP > MSTP Port Setup** to display the screen as shown next.

Figure 311 SWITCHING > Spanning Tree Protocol > MSTP > MSTP Port Setup (Standalone Mode)

Multiple Spanning Tree Protocol		MSTP Port Setup	
Port	Edge	Root Guard	
*	<input type="checkbox"/>	<input type="checkbox"/>	
1	<input type="checkbox"/>	<input type="checkbox"/>	
2	<input type="checkbox"/>	<input type="checkbox"/>	
3	<input type="checkbox"/>	<input type="checkbox"/>	
4	<input type="checkbox"/>	<input type="checkbox"/>	
5	<input type="checkbox"/>	<input type="checkbox"/>	
6	<input type="checkbox"/>	<input type="checkbox"/>	
7	<input type="checkbox"/>	<input type="checkbox"/>	

Figure 312 SWITCHING > Spanning Tree Protocol > MSTP > MSTP Port Setup (Stacking Mode)

Port	Edge	Root Guard
1/*	<input type="checkbox"/>	<input type="checkbox"/>
1/1	<input type="checkbox"/>	<input type="checkbox"/>
1/2	<input type="checkbox"/>	<input type="checkbox"/>
1/3	<input type="checkbox"/>	<input type="checkbox"/>
1/4	<input type="checkbox"/>	<input type="checkbox"/>
1/5	<input type="checkbox"/>	<input type="checkbox"/>
1/6	<input type="checkbox"/>	<input type="checkbox"/>
1/7	<input type="checkbox"/>	<input type="checkbox"/>

The following table describes the labels in this screen.

Table 198 SWITCHING > Spanning Tree Protocol > MSTP > MSTP Port Setup

LABEL	DESCRIPTION
SLOT	This field appears only in Stacking mode. Click the drop-down list to choose the slot number of the Switch in a stack.
Port	This field displays the port number. In Stacking mode, the first number represents the slot ID and the second is the port number. Please note that the default stacking ports (the last four ports of your Switch) cannot be configured. They are reserved for stacking only.
*	Settings in this row apply to all ports. Use this row only if you want to make some settings the same for all ports. Use this row first to set the common settings and then make adjustments on a port-by-port basis. Note: Changes in this row are copied to all the ports as soon as you make them.
Edge	Select this check box to configure a port as an edge port when it is directly attached to a computer. An edge port changes its initial STP port state from blocking state to forwarding state immediately without going through listening and learning states right after the port is configured as an edge port or when its link status changes. Note: An edge port becomes a non-edge port as soon as it receives a Bridge Protocol Data Unit (BPDU).
Root Guard	Select this check box to enable root guard on this port in order to prevent the switches attached to the port from becoming the root bridge. With root guard enabled, a port is blocked when the Switch receives a superior BPDU on it. The Switch allows traffic to pass through this port again when the switch connected to the port stops to send superior BPDUs.
Apply	Click Apply to save your changes to the Switch's run-time memory. The Switch loses these changes if it is turned off or loses power, so use the Save link on the top navigation panel to save your changes to the non-volatile memory when you are done configuring.
Cancel	Click Cancel to begin configuring this screen afresh.

54.11 Technical Reference

This section provides technical background information on the topics discussed in this chapter.

54.11.1 MSTP Network Example

The following figure shows a network example where two VLANs are configured on the two switches. If the switches are using STP or RSTP, the link for VLAN 2 will be blocked as STP and RSTP allow only one link in the network and block the redundant link.

Figure 313 STP/RSTP Network Example

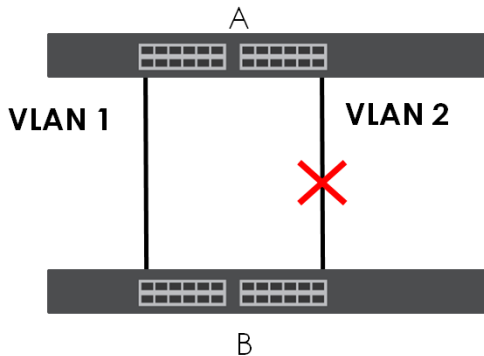

With MSTP, VLANs 1 and 2 are mapped to different spanning trees in the network. Therefore traffic from the two VLANs travel on different paths. The following figure shows the network example using MSTP.

Figure 314 MSTP Network Example

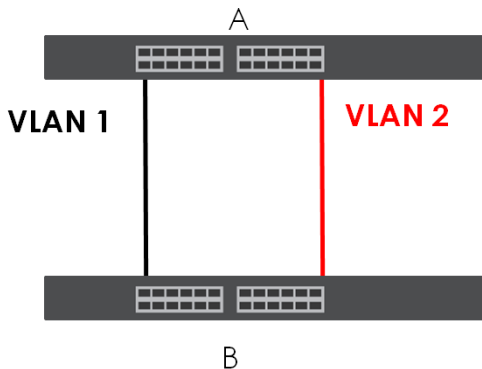

54.11.2 MST Region

An MST region is a logical grouping of multiple network devices that appears as a single device to the rest of the network. Each MSTP-enabled device can only belong to one MST region. When BPDUs enter an MST region, external path cost (of paths outside this region) is increased by one. Internal path cost (of paths within this region) is increased by one when BPDUs traverse the region.

Devices that belong to the same MST region are configured to have the same MSTP configuration identification settings. These include the following parameters:

- Name of the MST region
- Revision level as the unique number for the MST region

- VLAN-to-MST Instance mapping

54.11.3 MST Instance

An MST Instance (MSTI) is a spanning tree instance. VLANs can be configured to run on a specific MSTI. Each created MSTI is identified by a unique number (known as an MST ID) known internally to a region. Therefore an MSTI does not span across MST regions.

The following figure shows an example where there are two MST regions. Regions 1 and 2 have two spanning tree instances.

Figure 315 MSTIs in Different Regions

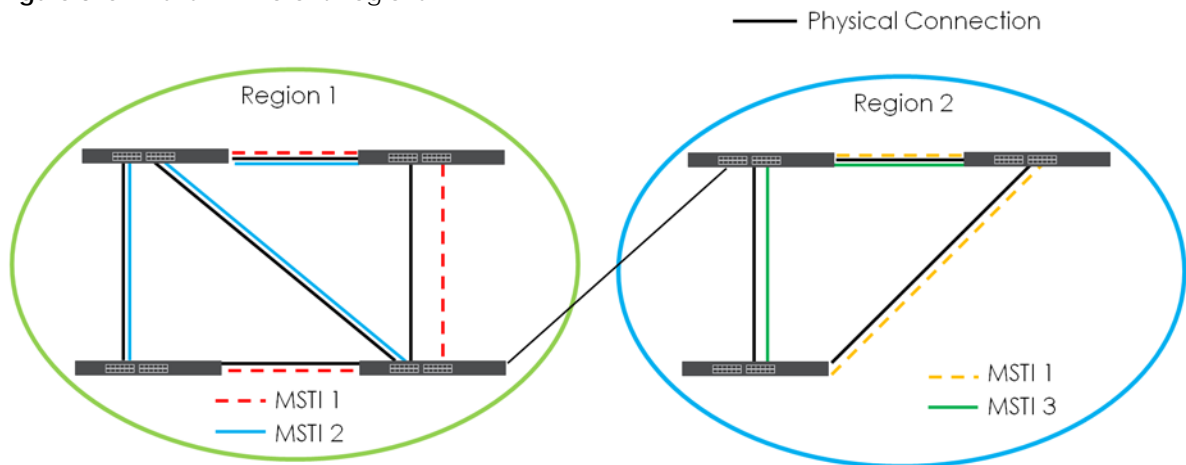

54.11.4 Common and Internal Spanning Tree (CIST)

A CIST represents the connectivity of the entire network and it is equivalent to a spanning tree in an STP/RSTP. The CIST is the default MST instance (MSTID 0). Any VLANs that are not members of an MST instance are members of the CIST. In an MSTP-enabled network, there is only one CIST that runs between MST regions and single spanning tree devices. A network may contain multiple MST regions and other network segments running RSTP.

Figure 316 MSTP and Legacy RSTP Network Example

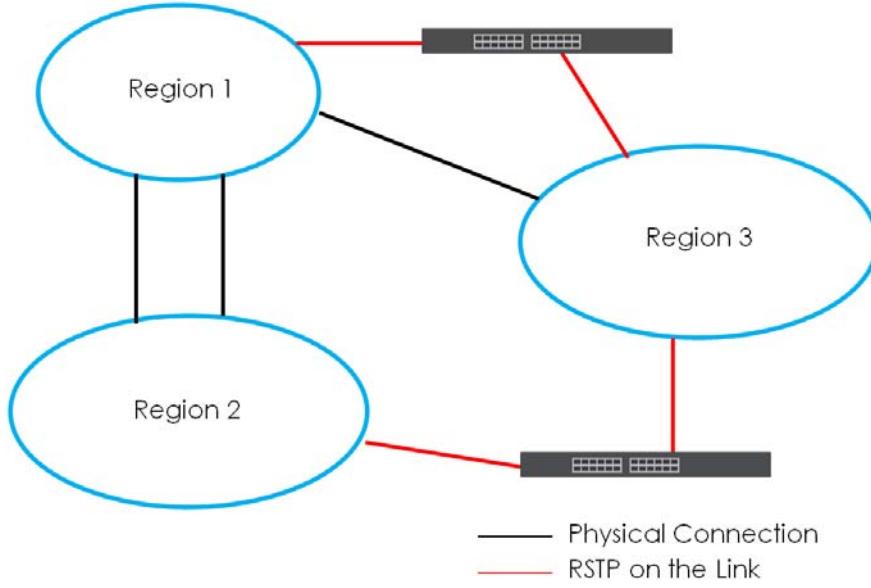

CHAPTER 55

Static MAC Filtering

55.1 Static MAC Filtering Overview

This chapter discusses MAC address port filtering.

Filtering means sifting traffic going through the Switch based on the source and/or destination MAC addresses and VLAN group (ID).

55.1.1 What You Can Do

Use the **Static MAC Filtering** screen ([Section 55.2 on page 410](#)) to create rules for traffic going through the Switch.

55.2 Configure a Static MAC Filtering Rule

Use this screen to view and configure rules for traffic going through the Switch. Click **SWITCHING > Static MAC Filtering** in the navigation panel to display the screen as shown next.

Figure 317 SWITCHING > Static MAC Filtering

The following table describes the related labels in this screen.

Table 199 SWITCHING > Static MAC Filtering

LABEL	DESCRIPTION
Index	This field displays the index number of the rule.
Active	This field displays whether the rule is activated or not.
Name	This field displays the descriptive name for this rule. This is for identification purpose only.
MAC Address	This field displays the source or destination MAC address with the VLAN identification number to which the MAC address belongs.
VID	This field displays the VLAN group identification number.
Action	This field displays Discard source , Discard destination , or Discard both depending on what you configured above.
	Select an entry's check box to select a specific entry. Otherwise, select the check box in the table heading row to select all entries.

Table 199 SWITCHING > Static MAC Filtering (continued)

LABEL	DESCRIPTION
Add/Edit	Click Add/Edit to add a new entry or edit a selected one.
Delete	Click Delete to remove the selected entries.

55.2.1 Add/Edit a Static MAC Filtering Rule

Use this screen to create or edit rules for traffic going through the Switch. Click **Add/Edit**, or select an entry and click **Add/Edit** in the **SWITCHING > Static MAC Filtering** screen to display this screen.

Figure 318 SWITCHING > Static MAC Filtering > Add/Edit

The following table describes the related labels in this screen.

Table 200 SWITCHING > Static MAC Filtering > Add/Edit

LABEL	DESCRIPTION
Active	Enable the switch button to activate your rule. You may temporarily deactivate a rule without deleting it by de-selecting this check box.
Name	Enter a descriptive name (up to 32 printable ASCII characters excluding [?], [], ['], ["] or [,]) for this rule. This is for identification only.
Action	Select Discard source to drop the frames from the source MAC address (specified in the MAC field). The Switch can still send frames to the MAC address. Select Discard destination to drop the frames to the destination MAC address (specified in the MAC address). The Switch can still receive frames originating from the MAC address. Select Discard source and Discard destination to block traffic to or from the MAC address specified in the MAC field.
MAC	Enter a MAC address in valid MAC address format, that is, six hexadecimal character pairs.
VID	Enter the VLAN group identification number.
Apply	Click Apply to save your changes to the Switch's run-time memory. The Switch loses these changes if it is turned off or loses power, so use the Save link on the top navigation panel to save your changes to the non-volatile memory when you are done configuring.
Clear	Click Clear to clear the fields to the factory defaults.
Cancel	Click Cancel to not save the configuration you make and return to the last screen.

CHAPTER 56

Static MAC Forwarding

56.1 Static MAC Forwarding Overview

This chapter discusses how to configure forwarding rules based on MAC addresses of devices on your network.

Use these screens to configure static MAC address forwarding.

56.1.1 What You Can Do

Use the **Static MAC Forwarding** screen ([Section 56.2 on page 412](#)) to assign static MAC addresses for a port.

56.2 Configure Static MAC Forwarding

A static MAC address is an address that has been manually entered in the MAC address table. Static MAC addresses do not age out. When you set up static MAC address rules, you are setting static MAC addresses for a port. This may reduce the need for broadcasting.

Click **SWITCHING > Static MAC Forwarding** in the navigation panel to display the configuration screen as shown.

Figure 319 SWITCHING > Static MAC Forwarding

<input type="checkbox"/>	Index	Active	Name	MAC Address	VID	Port
<input type="checkbox"/>	1	ON	Example	88:ac:88:ac:88:ac	1	17

The following table describes the labels in this screen.

Table 201 SWITCHING > Static MAC Forwarding

LABEL	DESCRIPTION
Index	This is the index number of a static MAC address rule.
Active	This field displays whether this static MAC address forwarding rule is active. You may temporarily deactivate a rule without deleting it.
Name	This field displays the descriptive name for identification purposes for this static MAC address-forwarding rule.

Table 201 SWITCHING > Static MAC Forwarding (continued)

LABEL	DESCRIPTION
MAC Address	This field displays the MAC address that will be forwarded and the VLAN identification number to which the MAC address belongs.
VID	This field displays the ID number of the VLAN group.
Port	This field displays the port where the MAC address shown in the next field will be forwarded. In Stacking mode, the first number represents the slot ID and the second is the port number.
	Select an entry's check box to select a specific entry. Otherwise, select the check box in the table heading row to select all entries.
Add/Edit	Click Add/Edit to add a new rule or edit a selected one.
Delete	Click Delete to remove the selected rules.

56.2.1 Add/Edit Static MAC Forwarding Rules

Click **Add/Edit**, or select an entry and click **Add/Edit** in the **SWITCHING > Static MAC Forwarding** screen to display this screen.

Figure 320 SWITCHING > Static MAC Forwarding > Add/Edit (Standalone Mode)

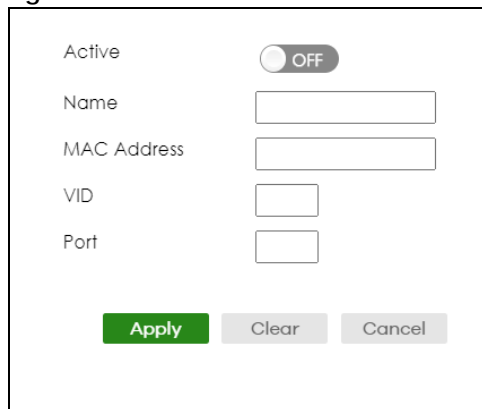

Active OFF

Name

MAC Address

VID

Port

Apply Clear Cancel

Figure 321 Switching > Static MAC Forwarding > Add/Edit (Stacking Mode)

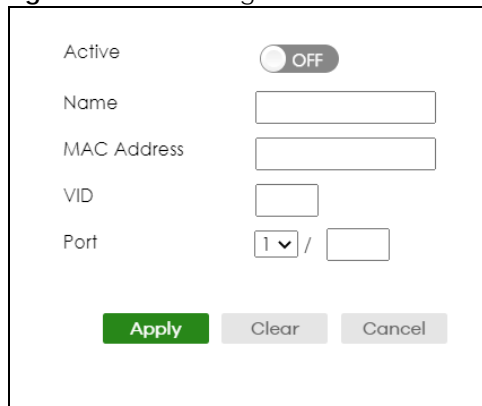

Active OFF

Name

MAC Address

VID

Port /

Apply Clear Cancel

The following table describes the labels in this screen.

Table 202 SWITCHING > Static MAC Forwarding > Add/Edit

LABEL	DESCRIPTION
Active	Enable the switch button to activate your rule. You may temporarily deactivate a rule without deleting it by disabling the switch.
Name	Enter a descriptive name for identification purposes for this static MAC address forwarding rule. You can enter up to 32 printable ASCII characters except [?], [], ['], ["] or [,].
MAC Address	Enter the MAC address in valid MAC address format, that is, six hexadecimal character pairs. Note: Static MAC addresses do NOT age out.
VID	Enter the VLAN identification number.
Port	Enter the port where the MAC address entered in the previous field will be automatically forwarded. In Stacking mode, the first box field is the slot ID and the second field is the port number.
Apply	Click Apply to save your changes to the Switch's run-time memory. The Switch loses these changes if it is turned off or loses power, so use the Save link on the top navigation panel to save your changes to the non-volatile memory when you are done configuring.
Clear	Click Clear to clear the fields to the factory defaults.
Cancel	Click Cancel to not save the configuration you make and return to the last screen.

CHAPTER 57

VLAN

57.1 VLAN Overview

This chapter shows you how to configure 802.1Q tagged and port-based VLANs.

The type of screen you see here depends on the **VLAN Type** you selected in the **SYSTEM > Switch Setup** screen which is only available in standalone mode. The Switch does not support port-based VLANs in Stacking mode.

57.1.1 What You Can Do

- Use the **VLAN Status** screen ([Section 57.3 on page 418](#)) to view and search all static VLAN groups.
- Use the **VLAN Status Details** screen ([Section 57.3.1 on page 419](#)) to view detailed port settings and status of the static VLAN group.
- Use the **Static VLAN Setup** screen ([Section 57.4 on page 421](#)) to configure a static VLAN for the Switch.
- Use the **VLAN Port Setup** screen ([Section 57.5 on page 423](#)) to configure the static VLAN (IEEE 802.1Q) settings on a port.
- Use the **GVRP** screen ([Section 57.6 on page 425](#)) to enable/disable GVRP on each port.
- Use the **Subnet Based VLAN Setup** screen ([Section 57.8 on page 428](#)) to set up VLANs that allow you to group traffic into logical VLANs based on the source IP subnet you specify.
- Use the **Protocol Based VLAN Setup** screen ([Section 57.9 on page 430](#)) to set up VLANs that allow you to group traffic into logical VLANs based on the protocol you specify.
- Use the **Voice VLAN Setup** screen ([Section 57.11 on page 433](#)) to set up VLANs that allow you to group voice traffic with defined priority and enable the Switch port to carry the voice traffic separately from data traffic to ensure the sound quality does NOT deteriorate.
- Use the **MAC Based VLAN Setup** screen ([Section 57.12 on page 435](#)) to set up VLANs that allow you to group untagged packets into logical VLANs based on the source MAC address of the packet. This eliminates the need to reconfigure the Switch when you change ports. The Switch will forward the packets based on the source MAC address you set up previously.
- Use the **Vendor ID Based VLAN Setup** screen ([Section 57.13 on page 437](#)) to set up VLANs that allow you to group untagged packets into logical VLANs based on the source MAC address of the packet. You can specify a mask for the MAC address to create a MAC address filter and enter a weight to set the VLAN rule's priority.

57.1.2 What You Need to Know

Read this section to know more about VLAN and how to configure the screens.

57.2 Introduction to IEEE 802.1Q Tagged VLANs

A tagged VLAN uses an explicit tag (VLAN ID) in the MAC header to identify the VLAN membership of a frame across bridges – they are not confined to the switch on which they were created. The VLANs can be created statically by hand or dynamically through GVRP. The VLAN ID associates a frame with a specific VLAN and provides the information that switches need to process the frame across the network. A tagged frame is 4 bytes longer than an untagged frame and contains 2 bytes of TPID (Tag Protocol Identifier, residing within the type or length field of the Ethernet frame) and 2 bytes of TCI (Tag Control Information, starts after the source address field of the Ethernet frame).

The CFI (Canonical Format Indicator) is a single-bit flag, always set to zero for Ethernet switches. If a frame received at an Ethernet port has a CFI set to 1, then that frame should not be forwarded as it is to an untagged port. The remaining twelve bits define the VLAN ID, giving a possible maximum number of 4096 VLANs. Note that user priority and VLAN ID are independent of each other. A frame with VID (VLAN Identifier) of null (0) is called a priority frame, meaning that only the priority level is significant and the default VID of the ingress port is given as the VID of the frame. Of the 4096 possible VIDs, a VID of 0 is used to identify priority frames and value 4095 (FFF) is reserved, so the maximum possible VLAN configurations are 4094.

TPID	User Priority	CFI	VLAN ID
16 Bits	3 Bits	1 Bit	12 Bits

Forwarding Tagged and Untagged Frames

Each port on the Switch is capable of passing tagged or untagged frames. To forward a frame from an 802.1Q VLAN-aware switch to an 802.1Q VLAN-unaware switch, the Switch first decides where to forward the frame and then strips off the VLAN tag. To forward a frame from an 802.1Q VLAN-unaware switch to an 802.1Q VLAN-aware switch, the Switch first decides where to forward the frame, and then inserts a VLAN tag reflecting the ingress port's default VID. The default PVID is VLAN 1 for all ports, but this can be changed.

A broadcast frame (or a multicast frame for a multicast group that is known by the system) is duplicated only on ports that are members of the VID (except the ingress port itself), thus confining the broadcast to a specific domain.

57.2.0.1 Automatic VLAN Registration

GARP and GVRP are the protocols used to automatically register VLAN membership across switches.

GARP

GARP (Generic Attribute Registration Protocol) allows network switches to register and de-register attribute values with other GARP participants within a bridged LAN. GARP is a protocol that provides a generic mechanism for protocols that serve a more specific application, for example, GVRP.

GARP Timers

Switches join VLANs by making a declaration. A declaration is made by issuing a Join message using GARP. Declarations are withdrawn by issuing a Leave message. A Leave All message terminates all registrations. GARP timers set declaration timeout values.

GVRP

GVRP (GARP VLAN Registration Protocol) is a registration protocol that defines a way for switches to register necessary VLAN members on ports across the network. Enable this function to permit VLAN groups beyond the local Switch.

Please refer to the following table for common IEEE 802.1Q VLAN terminology.

Table 203 IEEE 802.1Q VLAN Terminology

VLAN PARAMETER	TERM	DESCRIPTION
VLAN Type	Permanent VLAN	This is a static VLAN created manually.
	Dynamic VLAN	This is a VLAN configured by a GVRP registration or de-registration process.
VLAN Administrative Control	Registration Fixed	Fixed registration ports are permanent VLAN members.
	Registration Forbidden	Ports with registration forbidden are forbidden to join the specified VLAN.
	Normal Registration	Ports dynamically join a VLAN using GVRP.
VLAN Tag Control	Tagged	Ports belonging to the specified VLAN tag all outgoing frames transmitted.
	Untagged	Ports belonging to the specified VLAN do not tag all outgoing frames transmitted.
VLAN Port	Port VID	This is the VLAN ID assigned to untagged frames that this port received.
	Acceptable Frame Type	You may choose to accept both tagged and untagged incoming frames, just tagged incoming frames or just untagged incoming frames on a port.
	Ingress filtering	If set, the Switch discards incoming frames for VLANs that do not have this port as a member.

57.2.0.2 Port VLAN Trunking

Enable **VLAN Trunking** on a port to allow frames belonging to unknown VLAN groups to pass through that port. This is useful if you want to set up VLAN groups on end devices without having to configure the same VLAN groups on intermediary devices.

Refer to the following figure. Suppose you want to create VLAN groups 1 and 2 (V1 and V2) on devices A and B. Without **VLAN Trunking**, you must configure VLAN groups 1 and 2 on all intermediary switches C, D and E; otherwise they will drop frames with unknown VLAN group tags. However, with **VLAN Trunking** enabled on ports in each intermediary switch you only need to create VLAN groups in the end devices (A and B). C, D and E automatically allow frames with VLAN group tags 1 and 2 (VLAN groups that are unknown to those switches) to pass through their VLAN trunking ports.

Figure 322 Port VLAN Trunking

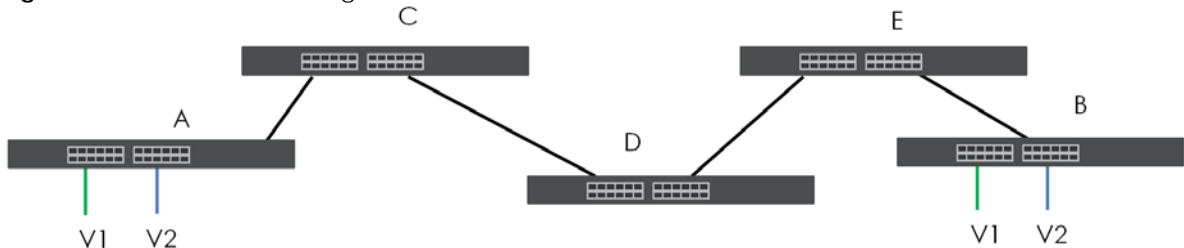

57.2.0.3 Select the VLAN Type

Select a VLAN type in the **SYSTEM > Switch Setup** screen.

Note: **VLAN Type** is not applicable in stacking mode.

Figure 323 SYSTEM > Switch Setup: Select VLAN Type (With Access L3 License)

The screenshot shows the 'Switch Setup' configuration page. At the top, the 'VLAN Type' is set to '802.1Q' (indicated by a green dot) and 'Port Based' is unselected. Below this, 'Bridge Control Protocol Transparency' is set to 'OFF'. The page is divided into sections: 'MAC Address Learning' with an 'Aging Time' of 300 seconds; 'ARP Aging Time' with an 'Aging Time' of 300 seconds; and 'GARP Timer' with 'Join Timer' at 200 milliseconds, 'Leave Timer' at 600 milliseconds, and 'Leave All Timer' at 10000 milliseconds. At the bottom, there are 'Apply' and 'Cancel' buttons.

802.1Q Static VLAN

Make sure **802.1Q** is selected in the **SYSTEM > Switch Setup** screen.

Use a static VLAN to decide whether an incoming frame on a port should be

- sent to a VLAN group as normal depending on its VLAN tag.
- sent to a group whether it has a VLAN tag or not.
- blocked from a VLAN group regardless of its VLAN tag.

You can also tag all outgoing frames (that were previously untagged) from a port with the specified VID.

57.3 VLAN Status

Use this screen to view and search all static VLAN groups. Click **SWITCHING > VLAN > VLAN Status** from the navigation panel to display the screen as shown next.

Figure 324 SWITCHING > VLAN > VLAN Status

Index	VID	Name	Tagged Port	Untagged Port	Elapsed Time	Status
1	1	1		1-54	7:59:18	Static
2	100	VLAN100			0:00:05	Static

The following table describes the labels in this screen.

Table 204 SWITCHING > VLAN > VLAN Status

LABEL	DESCRIPTION
VLAN Search by VID	Enter (an) existing VLAN ID numbers (use a comma (,) to separate individual VLANs or a hyphen (-) to indicate a range of VLANs. For example, "3,4" or "3-9") and click Search to display only the specified VLANs in the list below. Leave this field blank and click Search to display all VLANs configured on the Switch.
The Number of VLAN	This is the number of VLANs configured on the Switch.
The Number of Search Results	This is the number of VLANs that match the searching criteria and display in the list below. This field displays only when you use the Search button to look for certain VLANs.
Index	This is the VLAN index number. Click an index number to view more VLAN details.
VID	This is the VLAN identification number that was configured in the corresponding VLAN configuration screen.
Name	This fields shows the descriptive name of the VLAN.
Tagged Port	This field shows the tagged ports that are participating in the VLAN.
Untagged Port	This field shows the untagged ports that are participating in the VLAN.
Elapsed Time	This field shows how long it has been since a normal VLAN was registered or a static VLAN was set up.
Status	This field shows how this VLAN was added to the Switch. <ul style="list-style-type: none"> • Dynamic – using GVRP • Static – added as a permanent VLAN

57.3.1 VLAN Details

Use this screen to view detailed port settings and status of the static VLAN group. Click an index number in the **VLAN Status** screen to display VLAN details.

Figure 325 SWITCHING > VLAN > VLAN Status > VLAN Status Details (Standalone Mode)

VLAN Status > VLAN Status Details

VID: 100
Elapsed Time: 0:07:08
Status: Static

Port Number

		U:Untagged T:Tagged																										
		2	4	6	8	10	12	14	16	18	20	22	24	26	28	30	32	34	36	38	40	42	44	46	48	50	52	54
1	3	5	7	9	11	13	15	17	19	21	23	25	27	29	31	33	35	37	39	41	43	45	47	49	51	53		
-	-	-	-	-	-	-	-	-	-	-	-	-	-	-	-	-	-	-	-	-	-	-	-	-	-	-	-	
-	-	-	-	-	-	-	-	-	-	-	-	-	-	-	-	-	-	-	-	-	-	-	-	-	-	-	-	

Figure 326 SWITCHING > VLAN > VLAN Status > VLAN Status Details (Stacking Mode)

VLAN Status > VLAN Status Details

VID: 1
Elapsed Time: 4:03:57
Status: Static

Port Number

		U:Untagged T:Tagged																							
Slot	2	4	6	8	10	12	14	16	18	20	22	24	26	28	30	32	34	36	38	40	42	44	46	48	50
	1	3	5	7	9	11	13	15	17	19	21	23	25	27	29	31	33	35	37	39	41	43	45	47	49
1	U	U	U	U	U	U	U	U	U	U	U	U	U	U	U	U	U	U	U	U	U	U	U	U	U
	U	U	U	U	U	U	U	U	U	U	U	U	U	U	U	U	U	U	U	U	U	U	U	U	U

The following table describes the labels in this screen.

Table 205 SWITCHING > VLAN > VLAN Status > VLAN Status Details

LABEL	DESCRIPTION
VID	This is the VLAN identification number that was configured in the corresponding VLAN configuration screen.
Slot	'Slot' refers to a Switch in the 'virtual chassis' stack. This field displays the slot ID of the stacked Switch.
Elapsed Time	This field shows how long it has been since a normal VLAN was registered or a static VLAN was set up.
Status	This field shows how this VLAN was added to the Switch. <ul style="list-style-type: none"> • Dynamic: using GVRP • Static: added as a permanent entry
Port Number	This section displays the ports that are participating in a VLAN. A tagged port is marked as T , an untagged port is marked as U and ports not participating in a VLAN are marked as "- ".

57.4 Configure a Static VLAN

Use this screen to view and configure a static VLAN for the Switch. Click **SWITCHING > VLAN > VLAN Setup > Static VLAN** to display the screen as shown next.

Figure 327 SWITCHING > VLAN > VLAN Setup > Static VLAN

<input type="checkbox"/>	VID	Active	Name
<input type="checkbox"/>	1	ON	1
<input type="checkbox"/>	2	ON	2
<input type="checkbox"/>	3	ON	3
<input type="checkbox"/>	100	ON	VLAN100

The following table describes the related labels in this screen.

Table 206 SWITCHING > VLAN > VLAN Setup > Static VLAN

LABEL	DESCRIPTION
VID	This field displays the ID number of the VLAN group.
Active	This field indicates whether the VLAN settings are enabled or disabled.
Name	This field displays the descriptive name for this VLAN group.
	Select an entry's check box to select a specific entry. Otherwise, select the check box in the table heading row to select all entries.
Add/Edit	Click Add/Edit to add a new static VLAN or edit a selected one.
Delete	Click Delete to remove the selected static VLAN.

57.4.1 Add/Edit a Static VLAN

Use this screen to configure a static VLAN for the Switch. Click **Add/Edit**, or select an entry and click **Add/Edit** in the **SWITCHING > VLAN > VLAN Setup > Static VLAN** screen to display this screen.

Figure 328 SWITCHING > VLAN > VLAN Setup > Static VLAN > Add/Edit (Standalone Mode)

Active ON

Name

VLAN Group ID

Port	Control	Tagging
*	Normal	<input checked="" type="checkbox"/> Tx Tagging
1	<input checked="" type="radio"/> Normal <input type="radio"/> Fixed <input type="radio"/> Forbidden	<input checked="" type="checkbox"/> Tx Tagging
2	<input checked="" type="radio"/> Normal <input type="radio"/> Fixed <input type="radio"/> Forbidden	<input checked="" type="checkbox"/> Tx Tagging
3	<input checked="" type="radio"/> Normal <input type="radio"/> Fixed <input type="radio"/> Forbidden	<input checked="" type="checkbox"/> Tx Tagging
4	<input checked="" type="radio"/> Normal <input type="radio"/> Fixed <input type="radio"/> Forbidden	<input checked="" type="checkbox"/> Tx Tagging
5	<input checked="" type="radio"/> Normal <input type="radio"/> Fixed <input type="radio"/> Forbidden	<input checked="" type="checkbox"/> Tx Tagging
6	<input checked="" type="radio"/> Normal <input type="radio"/> Fixed <input type="radio"/> Forbidden	<input checked="" type="checkbox"/> Tx Tagging
7	<input checked="" type="radio"/> Normal <input type="radio"/> Fixed <input type="radio"/> Forbidden	<input checked="" type="checkbox"/> Tx Tagging
8	<input checked="" type="radio"/> Normal <input type="radio"/> Fixed <input type="radio"/> Forbidden	<input checked="" type="checkbox"/> Tx Tagging
9	<input checked="" type="radio"/> Normal <input type="radio"/> Fixed <input type="radio"/> Forbidden	<input checked="" type="checkbox"/> Tx Tagging
10	<input checked="" type="radio"/> Normal <input type="radio"/> Fixed <input type="radio"/> Forbidden	<input checked="" type="checkbox"/> Tx Tagging

Apply Clear Cancel

Figure 329 SWITCHING > VLAN > VLAN Setup > Static VLAN > Add/Edit (Static Mode)

Active ON

Name

VLAN Group ID

SLOT 1

Port	Control	Tagging
1/*	Normal	<input checked="" type="checkbox"/> Tx Tagging
1/1	<input checked="" type="radio"/> Normal <input type="radio"/> Fixed <input type="radio"/> Forbidden	<input checked="" type="checkbox"/> Tx Tagging
1/2	<input checked="" type="radio"/> Normal <input type="radio"/> Fixed <input type="radio"/> Forbidden	<input checked="" type="checkbox"/> Tx Tagging
1/3	<input checked="" type="radio"/> Normal <input type="radio"/> Fixed <input type="radio"/> Forbidden	<input checked="" type="checkbox"/> Tx Tagging
1/4	<input checked="" type="radio"/> Normal <input type="radio"/> Fixed <input type="radio"/> Forbidden	<input checked="" type="checkbox"/> Tx Tagging
1/5	<input checked="" type="radio"/> Normal <input type="radio"/> Fixed <input type="radio"/> Forbidden	<input checked="" type="checkbox"/> Tx Tagging
1/6	<input checked="" type="radio"/> Normal <input type="radio"/> Fixed <input type="radio"/> Forbidden	<input checked="" type="checkbox"/> Tx Tagging
1/7	<input checked="" type="radio"/> Normal <input type="radio"/> Fixed <input type="radio"/> Forbidden	<input checked="" type="checkbox"/> Tx Tagging
1/8	<input checked="" type="radio"/> Normal <input type="radio"/> Fixed <input type="radio"/> Forbidden	<input checked="" type="checkbox"/> Tx Tagging
1/50	<input checked="" type="radio"/> Normal <input type="radio"/> Fixed <input type="radio"/> Forbidden	<input checked="" type="checkbox"/> Tx Tagging

Apply Clear Cancel

The following table describes the related labels in this screen.

Table 207 SWITCHING > VLAN > VLAN Setup > Static VLAN > Add/Edit

LABEL	DESCRIPTION
Active	Enable the switch button to activate the VLAN settings.
Name	Enter a descriptive name for the VLAN group for identification purposes. This name consists of up to 64 printable ASCII characters. The string should not contain [?], [], ['], ["] or [,].
VLAN Group ID	Enter the VLAN ID for this static entry; the valid range is between 1 and 4094. Note: Do NOT add a VLAN ID that has been used in the SWITCHING > VLAN > Voice VLAN Setup .
SLOT	This field appears only in Stacking mode. Click the drop-down list to choose the slot number of the Switch in a stack.
Port	The port number identifies the port you are configuring. In Stacking mode, the first number represents the slot ID and the second one is the port number. Please note that the default stacking ports (the last four ports of your Switch) cannot be configured. They are reserved for stacking only.
*	Settings in this row apply to all ports. Use this row only if you want to make some settings the same for all ports. Use this row first to set the common settings and then make adjustments on a port-by-port basis. Note: Changes in this row are copied to all the ports as soon as you make them.
Control	Select Normal for the port to dynamically join this VLAN group using GVRP. This is the default selection. Select Fixed for the port to be a permanent member of this VLAN group. Select Forbidden if you want to prohibit the port from joining this VLAN group.
Tagging	Select Tx Tagging if you want the port to tag all outgoing frames transmitted with this VLAN Group ID.
Apply	Click Apply to save your changes to the Switch's run-time memory. The Switch loses these changes if it is turned off or loses power, so use the Save link on the top navigation panel to save your changes to the non-volatile memory when you are done configuring.
Clear	Click Clear to clear the fields to the factory defaults.
Cancel	Click Cancel to not save the configuration you make and return to the last screen.

57.5 VLAN Port Setup

Use this screen to configure the static VLAN (IEEE 802.1Q) settings on a port. Click **SWITCHING > VLAN > VLAN Setup > VLAN Port Setup** to display the screen as shown.

Figure 330 SWITCHING > VLAN > VLAN Setup > VLAN Port Setup (Standalone Mode)

Static VLAN		VLAN Port Setup		GVRP	
Port	Ingress Check	PVID	Acceptable Frame Type	VLAN Trunking	Isolation
*	<input type="checkbox"/>	<input type="text"/>	All <input type="text"/>	<input type="checkbox"/>	<input type="checkbox"/>
1	<input type="checkbox"/>	1 <input type="text"/>	All <input type="text"/>	<input type="checkbox"/>	<input type="checkbox"/>
2	<input type="checkbox"/>	1 <input type="text"/>	All <input type="text"/>	<input type="checkbox"/>	<input type="checkbox"/>
3	<input type="checkbox"/>	1 <input type="text"/>	All <input type="text"/>	<input type="checkbox"/>	<input type="checkbox"/>
4	<input type="checkbox"/>	1 <input type="text"/>	All <input type="text"/>	<input type="checkbox"/>	<input type="checkbox"/>
5	<input type="checkbox"/>	1 <input type="text"/>	All <input type="text"/>	<input type="checkbox"/>	<input type="checkbox"/>
6	<input type="checkbox"/>	1 <input type="text"/>	All <input type="text"/>	<input type="checkbox"/>	<input type="checkbox"/>
7	<input type="checkbox"/>	1 <input type="text"/>	All <input type="text"/>	<input type="checkbox"/>	<input type="checkbox"/>

Figure 331 SWITCHING > VLAN > VLAN Setup > VLAN Port Setup (Stacking Mode)

Static VLAN		VLAN Port Setup		GVRP	
SLOT 1 <input type="text"/>					
Port	Ingress Check	PVID	Acceptable Frame Type	VLAN Trunking	Isolation
1/*	<input type="checkbox"/>	<input type="text"/>	All <input type="text"/>	<input type="checkbox"/>	<input type="checkbox"/>
1/1	<input type="checkbox"/>	1 <input type="text"/>	All <input type="text"/>	<input type="checkbox"/>	<input type="checkbox"/>
1/2	<input type="checkbox"/>	1 <input type="text"/>	All <input type="text"/>	<input type="checkbox"/>	<input type="checkbox"/>
1/3	<input type="checkbox"/>	1 <input type="text"/>	All <input type="text"/>	<input type="checkbox"/>	<input type="checkbox"/>
1/4	<input type="checkbox"/>	1 <input type="text"/>	All <input type="text"/>	<input type="checkbox"/>	<input type="checkbox"/>
1/5	<input type="checkbox"/>	1 <input type="text"/>	All <input type="text"/>	<input type="checkbox"/>	<input type="checkbox"/>
1/6	<input type="checkbox"/>	1 <input type="text"/>	All <input type="text"/>	<input type="checkbox"/>	<input type="checkbox"/>
1/7	<input type="checkbox"/>	1 <input type="text"/>	All <input type="text"/>	<input type="checkbox"/>	<input type="checkbox"/>

The following table describes the labels in this screen.

Table 208 SWITCHING > VLAN > VLAN Setup > VLAN Port Setup

LABEL	DESCRIPTION
SLOT	This field appears only in stacking mode. Click the drop-down list to choose the slot number of the Switch in a stack.
Port	This field displays the port number of the Switch. In Stacking mode, the first number represents the slot ID and the second is the port number. Please note that the default stacking ports (the last four ports of your Switch) cannot be configured. They are reserved for stacking only.

Table 208 SWITCHING > VLAN > VLAN Setup > VLAN Port Setup (continued)

LABEL	DESCRIPTION
*	<p>Settings in this row apply to all ports.</p> <p>Use this row only if you want to make some settings the same for all ports. Use this row first to set the common settings and then make adjustments on a port-by-port basis.</p> <p>Note: Changes in this row are copied to all the ports as soon as you make them.</p>
Ingress Check	<p>If this check box is selected, the Switch discards incoming frames on a port for VLANs that do not include this port in its member set.</p> <p>Clear this check box to disable ingress filtering.</p>
PVID	<p>A PVID (Port VLAN ID) is a tag that adds to incoming untagged frames received on a port so that the frames are forwarded to the VLAN group that the tag defines.</p> <p>Enter a number between 1 and 4094 as the port VLAN ID.</p>
Acceptable Frame Type	<p>Specify the type of frames allowed on a port. Choices are All, Tag Only and Untag Only.</p> <p>Select All from the drop-down list box to accept all untagged or tagged frames on this port. This is the default setting.</p> <p>Select Tag Only to accept only tagged frames on this port. All untagged frames will be dropped.</p> <p>Select Untag Only to accept only untagged frames on this port. All tagged frames will be dropped.</p> <p>Note: When the Switch is in Stacking mode and the master Switch has VLAN1, all other ports will be configured to untagged port.</p>
VLAN Trunking	<p>Enable VLAN Trunking on ports connected to other switches or routers (but not ports directly connected to end users) to allow frames belonging to unknown VLAN groups to pass through the Switch.</p>
Isolation	<p>Select this to allow this port to communicate only with the CPU management port and the ports on which the isolation feature is NOT enabled.</p>
Apply	<p>Click Apply to save your changes to the Switch's run-time memory. The Switch loses these changes if it is turned off or loses power, so use the Save link on the top navigation panel to save your changes to the non-volatile memory when you are done configuring.</p>
Cancel	<p>Click Cancel to begin configuring this screen afresh.</p>

57.6 Configure GVRP

Use this screen to configure GVRP settings on a port. Click **SWITCHING > VLAN > VLAN Setup > GVRP** to display the screen as shown.

Figure 332 SWITCHING > VLAN > VLAN Setup > GVRP (Standalone Mode)

GVRP OFF

Port	GVRP
*	<input type="checkbox"/>
1	<input type="checkbox"/>
2	<input type="checkbox"/>
3	<input type="checkbox"/>
4	<input type="checkbox"/>
5	<input type="checkbox"/>
6	<input type="checkbox"/>
7	<input type="checkbox"/>

Apply Cancel

Figure 333 SWITCHING > VLAN > VLAN Setup > GVRP (Stacking Mode)

GVRP OFF

SLOT 1 ▾

Port	GVRP
1/*	<input type="checkbox"/>
1/1	<input type="checkbox"/>
1/2	<input type="checkbox"/>
1/3	<input type="checkbox"/>
1/4	<input type="checkbox"/>
1/5	<input type="checkbox"/>
1/6	<input type="checkbox"/>
1/7	<input type="checkbox"/>

Apply Cancel

The following table describes the labels in this screen.

Table 209 SWITCHING > VLAN > VLAN Setup > GVRP

LABEL	DESCRIPTION
GVRP	GVRP (GARP VLAN Registration Protocol) is a registration protocol that defines a way for switches to register necessary VLAN members on ports across the network. Enable the switch button to permit VLAN groups beyond the local Switch.
SLOT	This field appears only in Stacking mode. Click the drop-down list to choose the slot number of the Switch in a stack.
Port	This field displays the port number of the Switch. In Stacking mode, the first number represents the slot ID and the second is the port number. Please note that the default stacking ports (the last four ports of your Switch) cannot be configured. They are reserved for stacking only.
*	Settings in this row apply to all ports. Use this row only if you want to make some settings the same for all ports. Use this row first to set the common settings and then make adjustments on a port-by-port basis. Note: Changes in this row are copied to all the ports as soon as you make them.
GVRP	Select this check box to allow GVRP on this port.
Apply	Click Apply to save your changes to the Switch's run-time memory. The Switch loses these changes if it is turned off or loses power, so use the Save link on the top navigation panel to save your changes to the non-volatile memory when you are done configuring.
Cancel	Click Cancel to begin configuring this screen afresh.

57.7 Subnet Based VLAN

Subnet based VLANs allow you to group traffic into logical VLANs based on the source IP subnet you specify. When a frame is received on a port, the Switch checks if a tag is added already and the IP subnet it came from. The untagged packets from the same IP subnet are then placed in the same subnet based VLAN. One advantage of using subnet based VLANs is that priority can be assigned to traffic from the same IP subnet.

Note: Subnet based VLAN applies to un-tagged packets and is applicable only when you use IEEE 802.1Q tagged VLAN.

For example, an ISP (Internet Services Provider) may divide different types of services it provides to customers into different IP subnets. Traffic for voice services is designated for IP subnet 172.16.1.0/24, video for 192.168.1.0/24 and data for 10.1.1.0/24. The Switch can then be configured to group incoming traffic based on the source IP subnet of incoming frames.

You configure a subnet based VLAN with priority 6 and VID of 100 for traffic received from IP subnet 172.16.1.0/24 (voice services). You also have a subnet based VLAN with priority 5 and VID of 200 for traffic received from IP subnet 192.168.1.0/24 (video services). Lastly, you configure VLAN with priority 3 and VID of 300 for traffic received from IP subnet 10.1.1.0/24 (data services). All untagged incoming frames will be classified based on their source IP subnet and prioritized accordingly. That is video services receive the highest priority and data the lowest.

Figure 334 Subnet Based VLAN Application Example

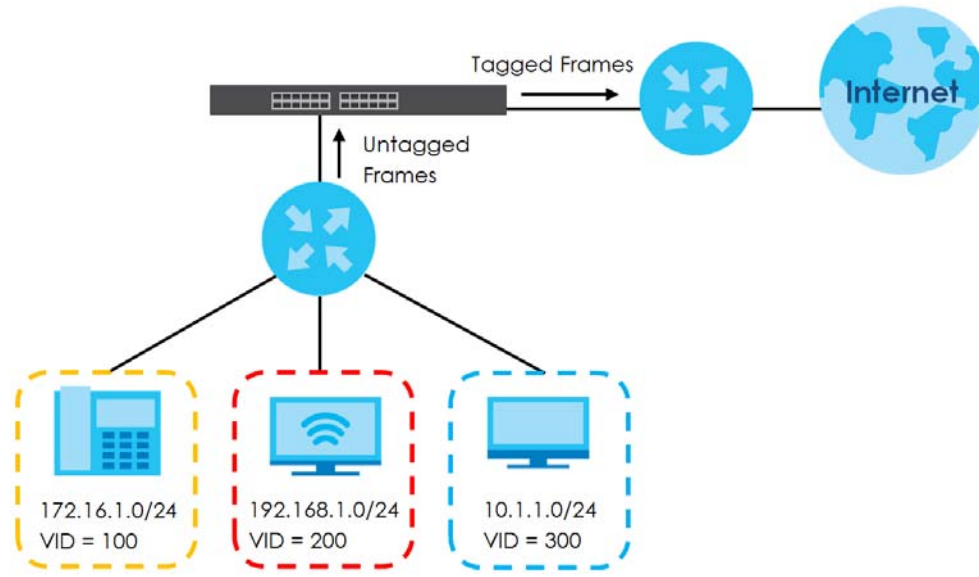

57.8 Configuring Subnet Based VLAN

Click the **SWITCHING > VLAN > Subnet Based VLAN Setup** link in the navigation panel to display the configuration screen as shown.

Figure 335 SWITCHING > VLAN > Subnet Based VLAN Setup

The screenshot shows the configuration screen for Subnet Based VLAN. The title is "Subnet Based VLAN". There are two toggle switches: "Active" and "DHCP-VLAN Override", both set to "ON". Below the switches are "Apply" and "Cancel" buttons. At the bottom, there is a table with columns: Index, Active, Name, IP, Mask-Bits, VID, and Priority. The table is currently empty.

The following table describes the labels in this screen.

Table 210 SWITCHING > VLAN > Subnet Based VLAN Setup

LABEL	DESCRIPTION
Active	Enable the switch button to activate this subnet based VLANs on the Switch.
DHCP-VLAN Override	When DHCP snooping is enabled DHCP clients can renew their IP address through the DHCP VLAN or through another DHCP server on the subnet based VLAN. Enable the switch button to force the DHCP clients in this IP subnet to obtain their IP addresses through the DHCP VLAN.
Apply	Click Apply to save your changes to the Switch's run-time memory. The Switch loses these changes if it is turned off or loses power, so use the Save link on the top navigation panel to save your changes to the non-volatile memory when you are done configuring.
Cancel	Click Cancel to begin configuring this screen afresh.
Index	This is the index number identifying this subnet based VLAN.
Active	This field shows whether the subnet based VLAN is active or not.

Table 210 SWITCHING > VLAN > Subnet Based VLAN Setup (continued)

LABEL	DESCRIPTION
Name	This field shows the name the subnet based VLAN.
IP	This field shows the IP address of the subnet for this subnet based VLAN.
Mask-Bits	This field shows the subnet mask in bit number format for this subnet based VLAN.
VID	This field shows the VLAN ID of the frames which belong to this subnet based VLAN.
Priority	This field shows the priority which is assigned to frames belonging to this subnet based VLAN.
	Select an entry's check box to select a specific entry. Otherwise, select the check box in the table heading row to select all entries.
Add/Edit	Click Add/Edit to add a new entry or edit a selected one.
Delete	Click Delete to remove the selected entry.

57.8.1 Add/Edit Subnet Based VLAN

Click **Add/Edit**, or select an entry and click **Add/Edit** in the **SWITCHING > VLAN > Subnet Based VLAN Setup** screen to display this screen.

Figure 336 SWITCHING > VLAN > Subnet Based VLAN Setup > Add/Edit

The following table describes the labels in this screen.

Table 211 SWITCHING > VLAN > Subnet Based VLAN Setup > Add/Edit

LABEL	DESCRIPTION
Active	Enable the switch button to activate the IP subnet VLAN you are creating or editing.
Name	Enter up to 32 alphanumeric characters to identify this subnet based VLAN. The string should not contain [?], [], ['], ["] or [,].
IP	Enter the IP address of the subnet for which you want to configure this subnet based VLAN.
Mask-Bits	Enter the bit number of the subnet mask. To find the bit number, convert the subnet mask to binary format and add all the 1's together. Take "255.255.255.0" for example. 255 converts to eight 1s in binary. There are three 255s, so add three eights together and you get the bit number (24).
VLAN	Enter the ID of a VLAN with which the untagged frames from the IP subnet specified in this subnet based VLAN are tagged. This must be an existing VLAN which you defined in the SWITCHING > VLAN > VLAN Setup > Static VLAN screen.
Priority	Select the priority level that the Switch assigns to frames belonging to this VLAN.
Apply	Click Apply to save your changes to the Switch's run-time memory. The Switch loses these changes if it is turned off or loses power, so use the Save link on the top navigation panel to save your changes to the non-volatile memory when you are done configuring.

Table 211 SWITCHING > VLAN > Subnet Based VLAN Setup > Add/Edit (continued)

LABEL	DESCRIPTION
Clear	Click Clear to clear the fields to the factory defaults.
Cancel	Click Cancel to not save the configuration you make and return to the last screen.

57.9 Protocol Based VLAN

Protocol based VLANs allow you to group traffic into logical VLANs based on the protocol you specify. When an upstream frame is received on a port (configured for a protocol based VLAN), the Switch checks if a tag is added already and its protocol. The untagged packets of the same protocol are then placed in the same protocol based VLAN. One advantage of using protocol based VLANs is that priority can be assigned to traffic of the same protocol.

Note: Protocol-based VLAN applies to un-tagged packets and is applicable only when you use IEEE 802.1Q tagged VLAN.

For example, port 1, 2, 3 and 4 belong to static VLAN 100, and port 4, 5, 6, 7 belong to static VLAN 120. You configure a protocol based VLAN A with priority 3 for ARP traffic received on port 1, 2 and 3. You also have a protocol based VLAN B with priority 2 for Apple Talk traffic received on port 6 and 7. All upstream ARP traffic from port 1, 2 and 3 will be grouped together, and all upstream Apple Talk traffic from port 6 and 7 will be in another group and have higher priority than ARP traffic, when they go through the uplink port to a backbone switch C.

Figure 337 Protocol Based VLAN Application Example

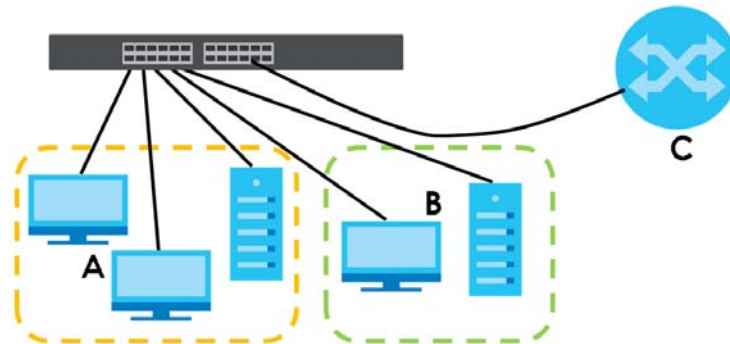

57.10 Configuring Protocol Based VLAN

Click the **SWITCHING > VLAN > Protocol Based VLAN Setup** link in the navigation panel to display the configuration screen as shown.

Figure 338 SWITCHING > VLAN > Protocol Based VLAN Setup

<input type="checkbox"/>	Index	Active	Port	Name	Ethernet-type	VID	Priority
--------------------------	-------	--------	------	------	---------------	-----	----------

The following table describes the labels in this screen.

Table 212 SWITCHING > VLAN > Protocol Based VLAN Setup

LABEL	DESCRIPTION
Index	This is the index number identifying this protocol based VLAN. Click any of these numbers to edit an existing protocol based VLAN.
Active	This field shows whether the protocol based VLAN is active or not.
Port	This field shows which port belongs to this protocol based VLAN. In Stacking mode, the first number represents the slot ID and the second is the port number.
Name	This field shows the name of the protocol based VLAN.
Ethernet-type	This field shows which Ethernet protocol is part of this protocol based VLAN.
VID	This field shows the VLAN ID of the port.
Priority	This field shows the priority which is assigned to frames belonging to this protocol based VLAN.
	Select an entry's check box to select a specific entry. Otherwise, select the check box in the table heading row to select all entries.
Add/Edit	Click Add/Edit to add a new entry or edit a selected one.
Delete	Click Delete to remove the selected entry.

57.10.1 Add/Edit a Protocol Based VLAN

Click **Add/Edit**, or select an entry and click **Add/Edit** in the **SWITCHING > VLAN > Protocol Based VLAN Setup** screen to display this configuration screen.

Figure 339 SWITCHING > VLAN > Protocol Based VLAN Setup > Add/Edit (Standalone Mode)

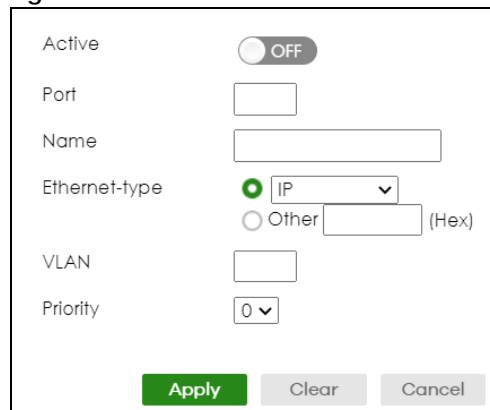

Active OFF

Port

Name

Ethernet-type IP
 Other (Hex)

VLAN

Priority

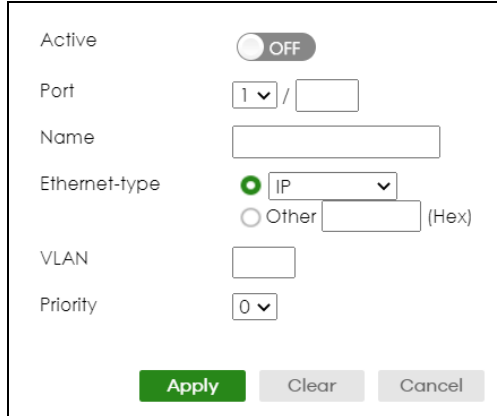
Figure 340 SWITCHING > VLAN > Protocol Based VLAN Setup > Add/Edit (Stacking Mode)

The following table describes the labels in this screen.

Table 213 SWITCHING > VLAN > Protocol Based VLAN Setup > Add/Edit

LABEL	DESCRIPTION
Active	Enable the switch button to activate this protocol based VLAN.
Port	Type a port number to be included in this protocol based VLAN. In Stacking mode, the first box field is the slot ID and the second field is the port number. This port must belong to a static VLAN in order to participate in a protocol based VLAN.
Name	Enter up to 32 alphanumeric characters to identify this protocol based VLAN. The string should not contain [?], [], ['], ["] or [,].
Ethernet-type	Use the drop down list box to select a predefined protocol to be included in this protocol based VLAN or select Other and type the protocol number in hexadecimal notation. For example the IP protocol in hexadecimal notation is 0800, and Novell IPX protocol is 8137. Note: Protocols in the hexadecimal number range of 0x0000 to 0x05ff are not allowed to be used for protocol based VLANs.
VLAN	Enter the ID of a VLAN to which the port belongs. This must be an existing VLAN which you defined in the SWITCHING > VLAN > VLAN Setup > Static VLAN screen.
Priority	Select the priority level that the Switch will assign to frames belonging to this VLAN.
Apply	Click Apply to save your changes to the Switch's run-time memory. The Switch loses these changes if it is turned off or loses power, so use the Save link on the top navigation panel to save your changes to the non-volatile memory when you are done configuring.
Clear	Click Clear to clear the fields to the factory defaults.
Cancel	Click Cancel to not save the configuration you make and return to the last screen.

57.10.1.1 Create an IP-based VLAN Example

This example shows you how to create an IP VLAN which includes ports 1, 4 and 8. Follow these steps using the screen below:

- 1 Activate this protocol based VLAN.
- 2 Type the port number you want to include in this protocol based VLAN. Type **1**.
- 3 Give this protocol-based VLAN a descriptive name. Type **IP-VLAN**.
- 4 Select the protocol. Leave the default value **IP**.

- 5 Type the VLAN ID of an existing VLAN. In our example we already created a static VLAN with an ID of 5. Type 5.
- 6 Leave the priority set to **0** and click **Apply**.

Figure 341 Protocol Based VLAN Configuration Example

To add more ports to this protocol based VLAN.

- 1 Click the index number of the protocol based VLAN entry. Click **1**.
- 2 Change the value in the **Port** field to the next port you want to add.
- 3 Click **Apply**.

57.11 Voice VLAN

Voice VLAN is a VLAN that is specifically allocated for voice traffic. It ensures that the sound quality of an IP phone is preserved from deteriorating when the data traffic on the Switch ports is high. It groups the voice traffic with defined priority into an assigned VLAN which enables the separation of voice and data traffic coming onto the Switch port.

The Switch can determine whether a received packet is

- an untagged voice packet when the incoming port is a fixed port for voice VLAN.
- a tagged voice packet when the incoming port and VLAN tag belongs to a voice VLAN.

It then checks the source packet's MAC address against an OUI list. If a match is found, the packet is considered as a voice packet.

You can set priority level to the Voice VLAN and add MAC address of IP phones from specific manufacturers by using its ID from the Organizationally Unique Identifiers (OUI).

Click **SWITCHING > VLAN > Voice VLAN Setup** to display the configuration screen as shown.

Figure 342 SWITCHING > VLAN > Voice VLAN Setup

The following table describes the fields in the above screen.

Table 214 SWITCHING > VLAN > Voice VLAN Setup

LABEL	DESCRIPTION
Voice VLAN Global Setup	
Voice VLAN	Click the second radio button if you want to enable the Voice VLAN feature. Enter a VLAN ID number in the box next to the radio button that is associated with the Voice VLAN. You also need to create a static VLAN with the same VID in the SWITCHING > VLAN > VLAN Setup > Static VLAN screen, and then connect the IP phone with the specified OUI MAC address to a port that joins the static VLAN. Click Disable radio button if you do not want to enable the Voice VLAN feature.
Priority	Select the priority level of the voice traffic from 0 to 7. Default setting is 5. The higher the numeric value you assign, the higher the priority for this voice traffic.
Apply	Click Apply to save your changes to the Switch's run-time memory. The Switch loses these changes if it is turned off or loses power, so use the Save link on the top navigation panel to save your changes to the non-volatile memory when you are done configuring.
Cancel	Click Cancel to begin configuring this section afresh.
Voice VLAN OUI Setup	
Index	This field displays the index number of the Voice VLAN.
OUI Address	This field displays the OUI address of the Voice VLAN.
OUI Mask	This field displays the OUI mask address of the Voice VLAN.
Description	This field displays the description of the Voice VLAN with OUI address.
	Select an entry's check box to select a specific entry. Otherwise, select the check box in the table heading row to select all entries.
Add/Edit	Click Add/Edit to add a new entry or edit a selected one.
Delete	Click Delete to remove the selected entry.

57.11.1 Add/Edit a Voice VLAN

Click **Add/Edit**, or select an entry and click **Add/Edit** in the **SWITCHING > VLAN > Voice VLAN Setup** screen to display the configuration screen.

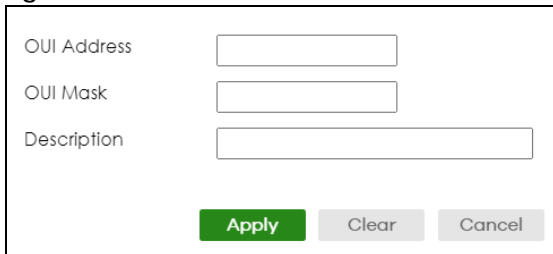
Figure 343 SWITCHING > VLAN > Voice VLAN Setup > Add/Edit

The following table describes the fields in the above screen.

Table 215 SWITCHING > VLAN > Voice VLAN Setup > Add/Edit

LABEL	DESCRIPTION
OUI Address	Enter the IP phone manufacturer's OUI MAC address. The first 3 bytes is the manufacturer identifier, the last 3 bytes is a unique station ID.
OUI Mask	Enter the mask for the specified IP phone manufacturer's OUI MAC address to determine which bits a packet's MAC address should match. Enter "f" for each bit of the specified MAC address that the traffic's MAC address should match. Enter "0" for the bits of the matched traffic's MAC address, which can be of any hexadecimal characters. For example, if you set the MAC address to 00:13:49:00:00:00 and the mask to ff:ff:ff:00:00:00, a packet with a MAC address of 00:13:49:12:34:56 matches this criteria.
Description	Enter a description up to 32 printable ASCII characters except [?], [], ['], or ["] for the Voice VLAN device. For example: Siemens.
Apply	Click Apply to save your changes to the Switch's run-time memory. The Switch loses these changes if it is turned off or loses power, so use the Save link on the top navigation panel to save your changes to the non-volatile memory when you are done configuring.
Clear	Click Clear to clear the fields to the factory defaults.
Cancel	Click Cancel to not save the configuration you make and return to the last screen.

57.12 MAC Based VLAN

The MAC-based VLAN feature assigns incoming untagged packets to a VLAN and classifies the traffic based on the source MAC address of the packet. When untagged packets arrive at the Switch, the source MAC address of the packet is looked up in a MAC to VLAN mapping table. If an entry is found, the corresponding VLAN ID is assigned to the packet. The assigned VLAN ID is verified against the VLAN table. If the VLAN is valid, ingress processing on the packet continues; otherwise, the packet is dropped.

This feature allows users to change ports without having to reconfigure the VLAN. You can assign priority to the MAC-based VLAN and define a MAC to VLAN mapping table by entering a specified source MAC address in the MAC-based VLAN setup screen. You can also delete a MAC-based VLAN entry in the same screen.

Click **SWITCHING > VLAN > MAC Based VLAN Setup** to see the following screen.

Figure 344 SWITCHING > VLAN > MAC Based VLAN Setup

The following table describes the fields in the above screen.

Table 216 SWITCHING > VLAN > MAC Based VLAN Setup

LABEL	DESCRIPTION
Index	This field displays the index number of the MAC-based VLAN entry.
Name	This field displays the name of the MAC-based VLAN entry.
MAC Address	This field displays the source MAC address that is bind to the MAC-based VLAN entry.
VID	This field displays the VLAN ID of the MAC-based VLAN entry.
Priority	This field displays the priority level which is assigned to frames belonging to this MAC-based VLAN entity.
	Select an entry's check box to select a specific entry. Otherwise, select the check box in the table heading row to select all entries.
Add/Edit	Click Add/Edit to add a new entry or edit a selected one.
Delete	Click Delete to remove the selected entry.

57.12.1 Add/Edit a MAC Based VLAN

Click **Add/Edit**, or select an entry and click **Add/Edit** in the **SWITCHING > VLAN > MAC Based VLAN Setup** screen to see this screen.

Figure 345 SWITCHING > VLAN > MAC Based VLAN Setup > Add/Edit

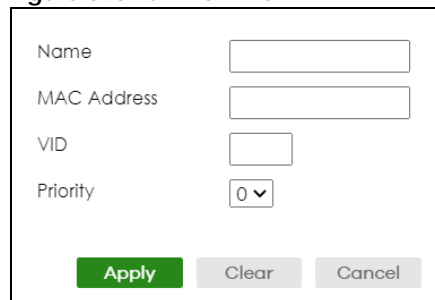

The following table describes the fields in the above screen.

Table 217 SWITCHING > VLAN > MAC Based VLAN Setup > Add/Edit

LABEL	DESCRIPTION
Name	Enter a name up to 32 alphanumeric characters except [?], [], ['], ["] or [,] for the MAC-based VLAN entry.
MAC Address	Enter a MAC address that is bind to the MAC-based VLAN entry. This is the source MAC address of the data packet that is looked up when untagged packets arrive at the Switch.
VID	Enter an ID (from 1 to 4094) for the VLAN that is associated with the MAC-based VLAN entry.
Priority	Enter a priority (0 to 7) that the Switch assigns to frames belonging to this VLAN. The higher the numeric value you assign, the higher the priority for this MAC-based VLAN entry.
Apply	Click Apply to save your changes to the Switch's run-time memory. The Switch loses these changes if it is turned off or loses power, so use the Save link on the top navigation panel to save your changes to the non-volatile memory when you are done configuring.
Clear	Click Clear to clear the fields to the factory defaults.
Cancel	Click Cancel to not save the configuration you make and return to the last screen.

57.13 Vendor ID Based VLAN

The Vendor ID based VLAN feature assigns incoming untagged packets to a VLAN and classifies the traffic based on the source MAC address of the packet. When untagged packets arrive at the switch, the source MAC address of the packet is looked up in a Vendor ID to VLAN mapping table. If an entry is found, the corresponding VLAN ID is assigned to the packet. The assigned VLAN ID is verified against the VLAN table. If the VLAN is valid, ingress processing on the packet continues; otherwise, the packet is dropped.

This feature allows users to change ports without having to reconfigure the VLAN. You can assign a 802.1p priority to the vendor ID based VLAN and define a vendor ID to VLAN mapping table by entering a specified source MAC address and mask in the vendor ID based VLAN setup screen. You can also delete a vendor ID based VLAN entry in the same screen.

For every vendor ID based VLAN rule you set, you can specify a weight number to define the rule's priority level. As rules are processed one after the other, stating a priority order will let you choose which rule has to be applied first and which second.

Click the **SWITCHING > VLAN > Vendor ID Based VLAN Setup** to see the following screen.

Figure 346 SWITCHING > VLAN > Vendor ID Based VLAN Setup

Index	Name	MAC Address	Mask	VLAN	Priority	Weight
<input type="checkbox"/>						

The following table describes the fields in the above screen.

Table 218 SWITCHING > VLAN > Vendor ID Based VLAN Setup

LABEL	DESCRIPTION
Index	This field displays the index number of the vendor ID based VLAN entry.
Name	This field displays the name of the vendor ID based VLAN entry.
MAC Address	This field displays the source MAC address that is bind to the vendor ID based VLAN entry.
Mask	This field displays the mask for the source MAC address that is bind to the vendor ID based VLAN entry.
VLAN	This field displays the VLAN ID of the vendor ID based VLAN entry.
Priority	This field displays the priority level which is assigned to frames belonging to this vendor ID based VLAN.
Weight	This field displays the weight of the vendor ID based VLAN entry.
	Select an entry's check box to select a specific entry. Otherwise, select the check box in the table heading row to select all entries.
Add/Edit	Click Add/Edit to add a new entry or edit a selected one.
Delete	Click Delete to remove the selected entry.

57.13.1 Add/Edit a Vendor ID Based VLAN

Click **Add/Edit**, or select an entry and click **Add/Edit** in the **SWITCHING > VLAN > Vendor ID Based VLAN Setup** to see this screen.

Figure 347 SWITCHING > VLAN > Vendor ID Based VLAN Setup > Add/Edit

Name	<input type="text"/>
MAC Address	<input type="text" value="5c:e2:8c:11:22:33"/>
Mask	<input type="text" value="ff:ff:00:00:00"/>
VID	<input type="text"/>
Priority	<input type="text" value="0"/> ▼
Weight	<input type="text" value="127"/>
<input type="button" value="Apply"/> <input type="button" value="Clear"/> <input type="button" value="Cancel"/>	

The following table describes the fields in the above screen.

Table 219 SWITCHING > VLAN > Vendor ID Based VLAN Setup > Add/Edit

LABEL	DESCRIPTION
Name	Enter a name up to 32 alphanumeric characters except [?], [], ['], or ["] for the vendor ID based VLAN entry.
MAC Address	Enter a MAC address that is bind to the vendor ID-based VLAN entry. This is the source MAC address of the data packet that is looked up when untagged packets arrive at the Switch.
Mask	Enter the mask for the specified source MAC address to determine which bits a packet's MAC address should match. Enter "f" for each bit of the specified MAC address that the traffic's MAC address should match. Enter "0" for the bits of the matched traffic's MAC address, which can be of any hexadecimal characters. For example, if you set the MAC address to 00:13:49:00:00:00 and the mask to ff:ff:ff:00:00:00, a packet with a MAC address of 00:13:49:12:34:56 matches this criteria.
VID	Enter an ID (from 1 to 4094) for the VLAN that is associated with the vendor ID based VLAN entry.
Priority	Select the priority level that the Switch assigns to frames belonging to this VLAN. The higher the numeric value you assign, the higher the priority for this vendor ID based VLAN entry.
Weight	Enter a number between 0 and 255 to specify the rule's weight. This is to decide the priority in which the rule is applied. The higher the number, the higher the rule's priority.
Apply	Click Apply to save your changes to the Switch's run-time memory. The Switch loses these changes if it is turned off or loses power, so use the Save link on the top navigation panel to save your changes to the non-volatile memory when you are done configuring.
Clear	Click Clear to clear the fields to the factory defaults.
Cancel	Click Cancel to not save the configuration you make and return to the last screen.

57.14 Port-Based VLAN Setup

Port-based VLANs are VLANs where the packet forwarding decision is based on the destination MAC address and its associated port.

Port-based VLANs require allowed outgoing ports to be defined for each port. Therefore, if you wish to allow two subscriber ports to talk to each other, for example, between conference rooms in a hotel, you must define the egress (an egress port is an outgoing port, that is, a port through which a data packet leaves) for both ports.

Port-based VLANs are specific only to the Switch on which they were created.

Note: When you activate port-based VLAN, the Switch uses a default VLAN ID of 1. You cannot change it.

Note: In screens (such as **SYSTEM > IP Setup** and **SWITCHING > Static MAC Filtering**) that require a VID, you must enter 1 as the VID.

The port-based VLAN setup screen is shown next. The **CPU** management port forms a VLAN with all Ethernet ports.

57.15 Configure a Port-Based VLAN

Select **Port Based** as the VLAN Type in the **SYSTEM > Switch Setup** screen and then click **SWITCHING > VLAN** from the navigation panel to display the next screen.

Select either **All Connected** or **Port Isolated** from the drop-down list depending on your VLAN and VLAN security requirements. If VLAN members need to communicate directly with each other, then select **All Connected**. Select **Port Isolated** if you want to restrict users from communicating directly. Click **Apply** to save your settings.

The following screen shows users on a port-based, all-connected VLAN configuration.

Figure 348 SWITCHING > VLAN > Port Based VLAN Setup (All Connected)

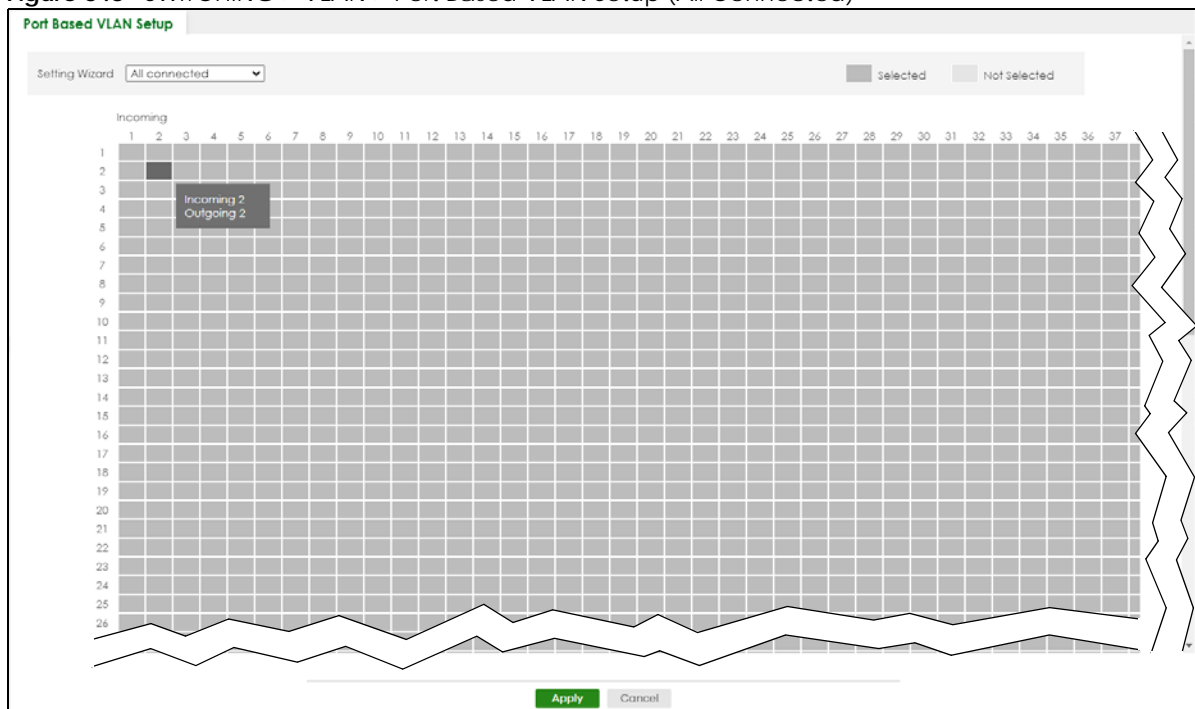

The following screen shows users on a port-based, port-isolated VLAN configuration.

Figure 349 SWITCHING > VLAN: Port Based VLAN Setup (Port Isolation)

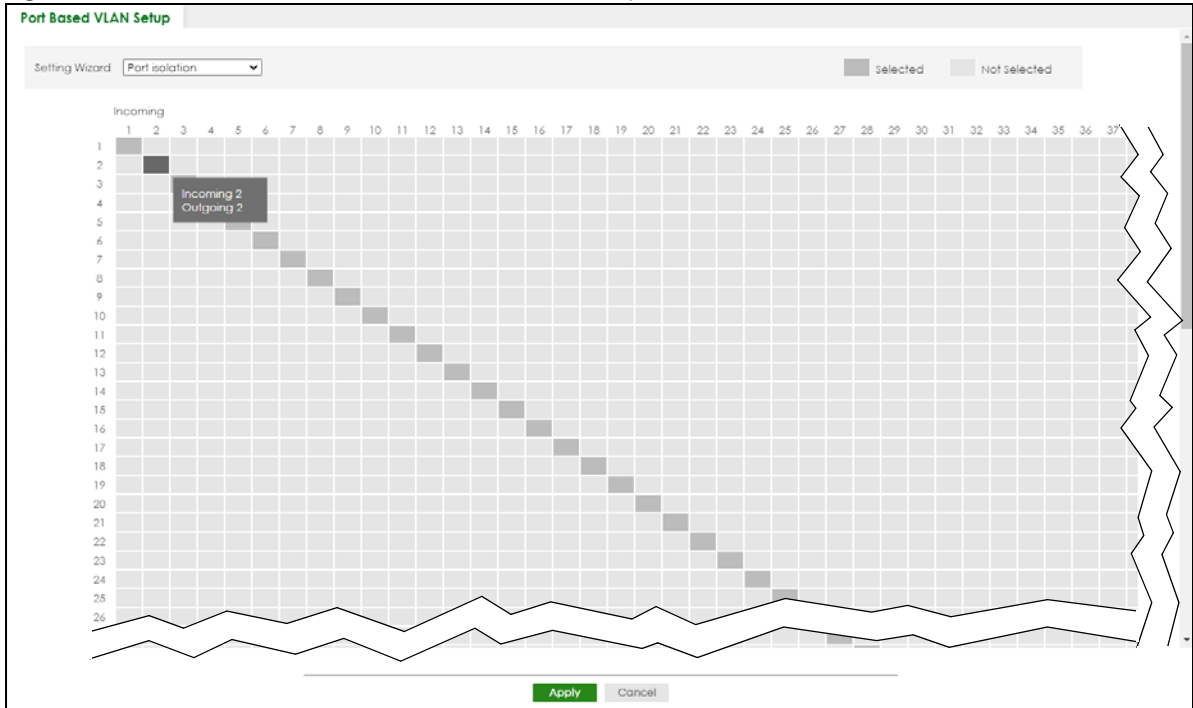

The following table describes the labels in this screen.

Table 220 SWITCHING > VLAN > Port Based VLAN Setup

LABEL	DESCRIPTION
Setting Wizard	<p>Choose Current configuration to display the Switch's current port-based VLAN configuration.</p> <p>Choose All connected or Port isolation wizard to quickly set up a port-based VLAN according to the below descriptions.</p> <p>All connected means all ports can communicate with each other, that is, there are no virtual LANs. All incoming and outgoing ports are selected. This option is the most flexible but also the least secure.</p> <p>Port isolation means that each port can only communicate with the CPU management port and cannot communicate with each other. All incoming ports are selected while only the CPU outgoing port is selected. This option is the most limiting but also the most secure.</p> <p>After selecting the setting wizard, you can customize the port settings. Click on the ports to add or delete incoming or outgoing ports. The configuration will be saved only after you click Apply at the bottom of the screen.</p>
Incoming	<p>These are the ingress ports; an ingress port is an incoming port, that is, a port through which a data packet enters. If you wish to allow two subscriber ports to talk to each other, you must define the ingress port for both ports. The numbers in the top row denote the incoming port for the corresponding port listed on the left (its outgoing port). CPU refers to the Switch management port. By default it forms a VLAN with all Ethernet ports. If it does not form a VLAN with a particular port then the Switch cannot be managed from that port.</p>
Outgoing	<p>These are the egress ports; an egress port is an outgoing port, that is, a port through which a data packet leaves. If you wish to allow two subscriber ports to talk to each other, you must define the egress port for both ports. CPU refers to the Switch management port. By default it forms a VLAN with all Ethernet ports. If it does not form a VLAN with a particular port then the Switch cannot be managed from that port.</p>

Table 220 SWITCHING > VLAN > Port Based VLAN Setup (continued)

LABEL	DESCRIPTION
Apply	Click Apply to save your changes to the Switch's run-time memory. The Switch loses these changes if it is turned off or loses power, so use the Save link on the top navigation panel to save your changes to the non-volatile memory when you are done configuring.
Cancel	Click Cancel to begin configuring this screen afresh.

CHAPTER 58

VLAN Isolation

This chapter shows you how to configure the Switch to prevent communications between ports in a VLAN.

58.1 VLAN Isolation Overview

VLAN Isolation allows you to do port isolation within a VLAN in a simple way. You specify which ports in a VLAN is not isolated by adding it to the promiscuous port list. The Switch automatically adds other ports in this VLAN to the isolated port list and blocks traffic between the isolated ports. A promiscuous port can communicate with any port in the same VLAN. An isolated port can communicate with the promiscuous ports only.

Note: You can have up to one VLAN Isolation rule for each VLAN.

Figure 350 VLAN Isolation Example

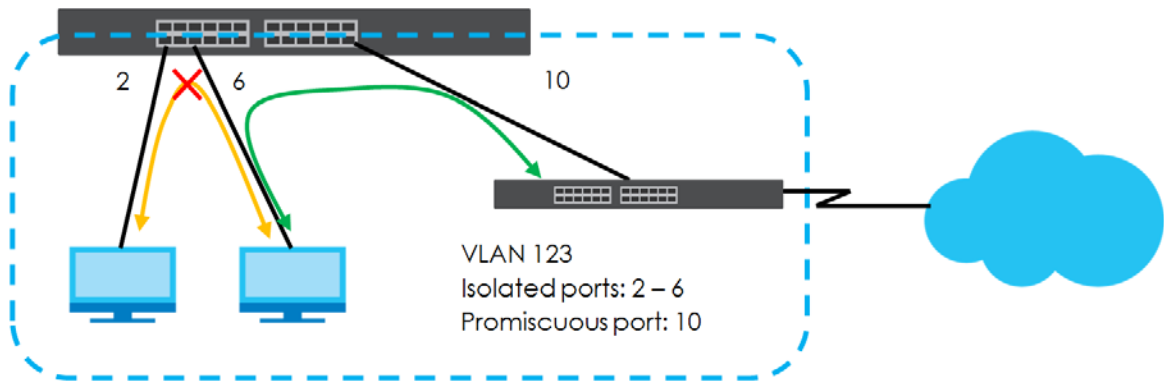

Note: Make sure you keep at least one port in the promiscuous port list for a VLAN with VLAN Isolation enabled. Otherwise, this VLAN is blocked from the whole network.

58.2 Configuring VLAN Isolation

Click **SWITCHING** > **VLAN Isolation** in the navigation panel to display the screen as shown.

Figure 351 SWITCHING > VLAN Isolation

The following table describes the labels in this screen.

Table 221 SWITCHING > VLAN Isolation

LABEL	DESCRIPTION
Index	This is the index number of the rule.
Active	This shows whether this rule is activated or not.
Name	This is the descriptive name for this rule.
VLAN ID	This is the VLAN to which this rule is applied.
Promiscuous Ports	This shows the ports that can communicate with any ports in the same VLAN.
	Select an entry's check box to select a specific entry. Otherwise, select the check box in the table heading row to select all entries.
Add/Edit	Click Add/Edit to add a new entry or edit a selected one.
Delete	Click Delete to remove the selected entries.

58.2.1 Add/Edit a VLAN Isolation Rule

Click **Add/Edit**, or select an entry and click **Add/Edit** in the **SWITCHING > VLAN Isolation** screen to display this screen.

Figure 352 SWITCHING > VLAN Isolation > Add/Edit

The following table describes the labels in this screen.

Table 222 SWITCHING > VLAN Isolation > Add/Edit

LABEL	DESCRIPTION
Active	Enable the switch button to enable VLAN Isolation in a VLAN.
Name	Enter a descriptive name (up to 32 printable ASCII characters except [?], [], ['], ["] or [,]) for identification purposes.
VLAN ID	Enter a VLAN ID from 1 to 4094. This is the VLAN to which this rule applies.
Promiscuous Ports	Enter the number of the ports that can communicate with any ports in the same VLAN. Other ports belonging to this VLAN will be added to the isolation list and can only send and receive traffic from the ports you specify here.

Table 222 SWITCHING > VLAN Isolation > Add/Edit (continued)

LABEL	DESCRIPTION
Apply	Click Apply to save your changes to the Switch's run-time memory. The Switch loses these changes if it is turned off or loses power, so use the Save link on the top navigation panel to save your changes to the non-volatile memory when you are done configuring.
Clear	Click Clear to clear the fields to the factory defaults.
Cancel	Click Cancel to not save the configuration you make and return to the last screen.

CHAPTER 59

VLAN Mapping

This chapter shows you how to configure VLAN mapping on the Switch.

59.1 VLAN Mapping Overview

With VLAN mapping enabled, the Switch can map the VLAN ID and priority level of packets received from a private network to those used in the service provider's network.

The Switch checks incoming traffic from the switch ports (non-management ports) against the VLAN mapping table first, the MAC learning table and then the VLAN table before forwarding them through the Gigabit uplink port. When VLAN mapping is enabled, the Switch discards the tagged packets that do not match an entry in the VLAN mapping table. If the incoming packets are untagged, the Switch adds a PVID based on the VLAN setting.

Note: You cannot enable VLAN mapping and VLAN stacking at the same time.

59.1.1 VLAN Mapping Example

In the following example figure, packets that carry VLAN ID 12 and are received on port 3 match a pre-configured VLAN mapping rule. The Switch translates the VLAN ID from 12 into 123 before forwarding the packets. Any packets carrying a VLAN tag other than 12 (such as 10) and received on port 3 will be dropped.

Figure 353 VLAN Mapping Example

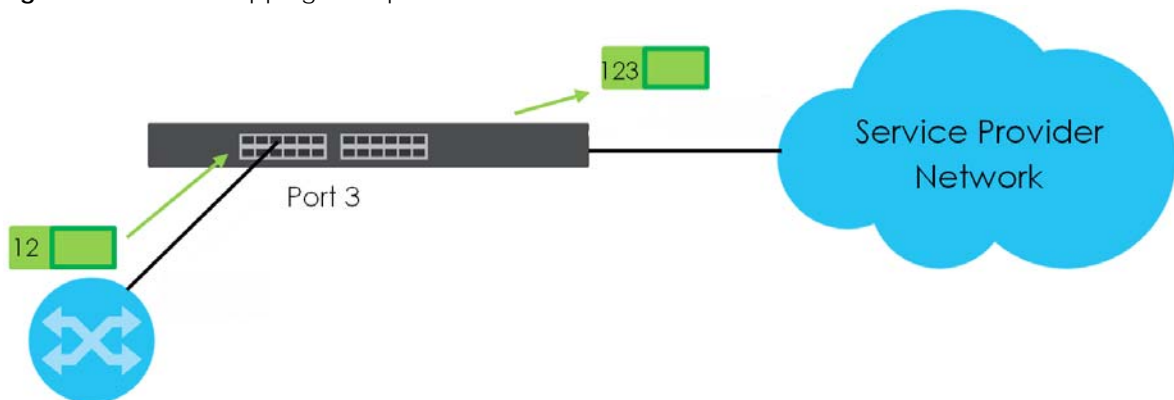

59.1.2 What You Can Do

- Use the **VLAN Mapping** screen ([Section 59.2 on page 446](#)) to enable VLAN mapping on the Switch and

ports.

- Use the **VLAN Mapping Setup** screen ([Section 59.3 on page 447](#)) to enable and edit the VLAN mapping rules.

59.2 Enable VLAN Mapping

Click **SWITCHING** > **VLAN Mapping** in the navigation panel to display the screen as shown.

Figure 354 SWITCHING > VLAN Mapping > VLAN Mapping (Standalone Mode)

VLAN Mapping Setup

Active OFF

Port	Active
*	<input type="checkbox"/>
1	<input type="checkbox"/>
2	<input type="checkbox"/>
3	<input type="checkbox"/>
4	<input type="checkbox"/>
5	<input type="checkbox"/>
6	<input type="checkbox"/>
7	<input type="checkbox"/>

Apply Cancel

Figure 355 SWITCHING > VLAN Mapping > VLAN Mapping (Stacking Mode)

The screenshot shows the 'VLAN Mapping Setup' interface. At the top, there is a toggle switch for 'Active' which is currently turned 'OFF'. Below this is a dropdown menu labeled 'SLOT 1'. The main part of the screen is a table with two columns: 'Port' and 'Active'. The 'Port' column lists '1/*', '1/1', '1/2', '1/3', '1/4', '1/5', '1/6', and '1/7'. The 'Active' column contains checkboxes, all of which are currently unchecked. At the bottom of the screen, there are two buttons: a green 'Apply' button and a grey 'Cancel' button.

The following table describes the labels in this screen.

Table 223 SWITCHING > VLAN Mapping > VLAN Mapping

LABEL	DESCRIPTION
Active	Enable the switch button to enable VLAN mapping on the Switch.
SLOT	This field appears only in Stacking mode. Click the drop-down list to choose the slot number of the Switch in a stack.
Port	This field displays the port number. In Stacking mode, the first number represents the slot ID and the second is the port number. Please note that the default stacking ports (the last four ports of your Switch) cannot be configured. They are reserved for stacking only.
*	Settings in this row apply to all ports. Use this row only if you want to make some settings the same for all ports. Use this row first to set the common settings and then make adjustments on a port-by-port basis. Note: Changes in this row are copied to all the ports as soon as you make them.
Active	Select this check box to enable the VLAN mapping feature on this port. Clear this check box to disable the VLAN mapping feature.
Apply	Click Apply to save your changes to the Switch's run-time memory. The Switch loses these changes if it is turned off or loses power, so use the Save link on the top navigation panel to save your changes to the non-volatile memory when you are done configuring.
Cancel	Click Cancel to begin configuring this screen afresh.

59.3 VLAN Mapping Setup

Click the **SWITCHING > VLAN Mapping > VLAN Mapping Setup** to display the screen as shown. Use this screen to view and configure the VLAN mapping rules.

Figure 356 SWITCHING > VLAN Mapping > VLAN Mapping Setup

<input type="checkbox"/>	Index	Active	Name	Port	VID	Translated VID	Priority
--------------------------	-------	--------	------	------	-----	----------------	----------

The following table describes the labels in this screen.

Table 224 SWITCHING > VLAN Mapping > VLAN Mapping Setup

LABEL	DESCRIPTION
Index	This is the number of the VLAN mapping entry in the table.
Active	This shows whether this entry is activated or not.
Name	This is the descriptive name for this rule.
Port	This is the port number to which this rule is applied. In Stacking mode, the first number represents the slot ID and the second is the port number.
VID	This is the customer VLAN ID in the incoming packets.
Translated VID	This is the VLAN ID that replaces the customer VLAN ID in the tagged packets.
Priority	This is the priority level that replaces the customer priority level in the tagged packets.
	Select an entry's check box to select a specific entry. Otherwise, select the check box in the table heading row to select all entries.
Add/Edit	Click Add/Edit to add a new entry or edit a selected one.
Delete	Click Delete to remove the selected entries.

59.3.1 Add/Edit VLAN Mapping

Click **Add/Edit**, or select an entry and click **Add/Edit** in the **SWITCHING > VLAN Mapping > VLAN Mapping Setup** to display this screen. Use this screen to enable and edit the VLAN mapping rules.

Figure 357 SWITCHING > VLAN Mapping > VLAN Mapping Setup > Add/Edit (Standalone Mode)

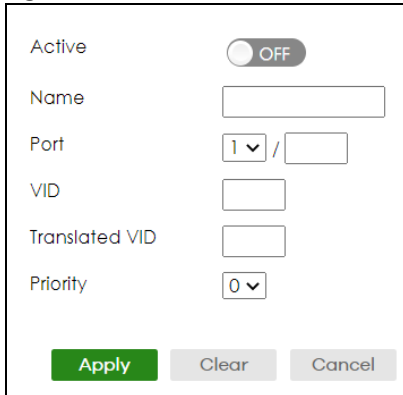
Figure 358 SWITCHING > VLAN Mapping > VLAN Mapping Setup > Add/Edit (Stacking Mode)

The following table describes the labels in this screen.

Table 225 SWITCHING > VLAN Mapping > VLAN Mapping Setup > Add/Edit

LABEL	DESCRIPTION
Active	Enable the switch button to activate this rule.
Name	Enter a descriptive name (up to 32 printable ASCII characters except [?], [], ['], ["] or [,]) for identification purposes.
Port	Type a port to be included in this rule. In Stacking mode, the first field is the slot ID and the second field is the port number.
VID	Enter a VLAN ID from 1 to 4094. This is the VLAN tag carried in the packets and will be translated into the VID you specified in the Translated VID field.
Translated VID	Enter a VLAN ID (from 1 to 4094) into which the customer VID carried in the packets will be translated.
Priority	Select a priority level (from 0 to 7). This is the priority level that replaces the customer priority level in the tagged packets or adds to the untagged packets.
Apply	Click Apply to save your changes to the Switch's run-time memory. The Switch loses these changes if it is turned off or loses power, so use the Save link on the top navigation panel to save your changes to the non-volatile memory when you are done configuring.
Clear	Click Clear to clear the fields to the factory defaults.
Cancel	Click Cancel to not save the configuration you make and return to the last screen.

CHAPTER 60

VLAN Stacking

This chapter shows you how to configure VLAN stacking on your Switch. See the chapter on VLANs for more background information on Virtual LANs (VLANs).

60.1 VLAN Stacking Overview

A service provider can use VLAN stacking to allow it to distinguish multiple customers VLANs, even those with the same (customer-assigned) VLAN ID, within its network.

Use VLAN stacking to add an outer VLAN tag to the inner IEEE 802.1Q tagged frames that enter the network. By tagging the tagged frames ("double-tagged" frames), the service provider can manage up to 4094 VLAN groups with each group containing up to 4094 customer VLANs. This allows a service provider to provide different service, based on specific VLANs, for many different customers.

A service provider's customers may require a range of VLANs to handle multiple applications. A service provider's customers can assign their own inner VLAN tags on ports for these applications. The service provider can assign an outer VLAN tag for each customer. Therefore, there is no VLAN tag overlap among customers, so traffic from different customers is kept separate.

60.1.1 VLAN Stacking Example

In the following example figure, both **A** and **B** are Service Provider's Network (SPN) customers with VPN tunnels between their head offices and branch offices respectively. Both have an identical VLAN tag for their VLAN group. The service provider can separate these two VLANs within its network by adding tag 37 to distinguish customer **A** and tag 48 to distinguish customer **B** at edge device **1** and then stripping those tags at edge device **2** as the data frames leave the network.

Figure 359 VLAN Stacking Example

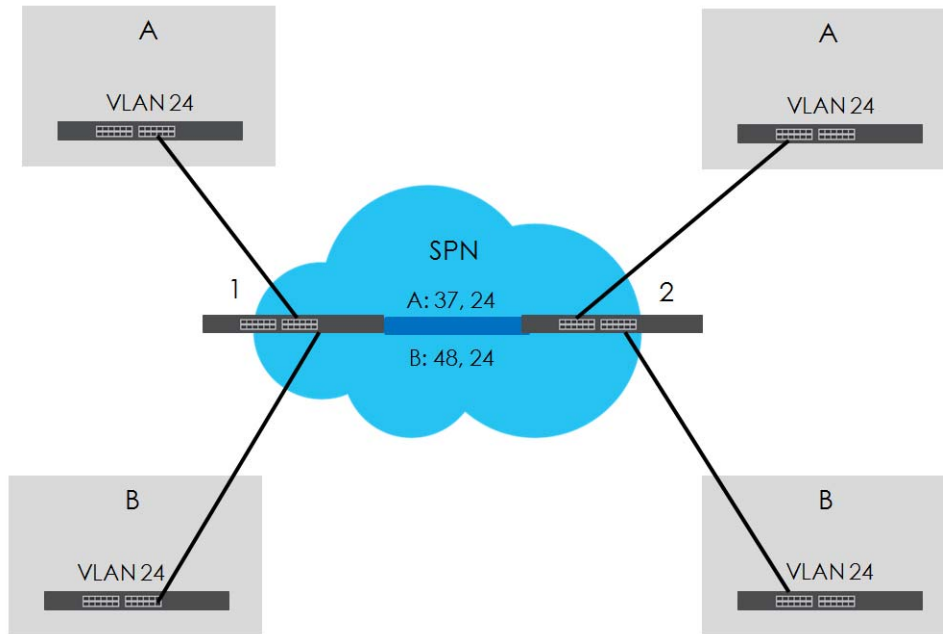

60.2 VLAN Stacking Port Roles

Each port can have three VLAN stacking “roles”, **Normal**, **Access**, and **Tunnel** (the latter is for Gigabit ports only).

- Select **Normal** for “regular” (non-VLAN stacking) IEEE 802.1Q frame switching.
- Select **Access** for ingress ports on the service provider's edge devices (1 and 2 in the VLAN stacking example figure). The incoming frame is treated as “untagged”, so a second VLAN tag (outer VLAN tag) can be added.

Note: Static VLAN Tx Tagging MUST be disabled on a port where you choose **Normal** or **Access**.

- Select **Tunnel** (available for Gigabit ports only) for egress ports at the edge of the service provider's network. All VLANs belonging to a customer can be aggregated into a single service provider's VLAN (using the outer VLAN tag defined by the Service Provider's (SP) VLAN ID (VID)).

Note: Static VLAN Tx Tagging MUST be enabled on a port where you choose **Tunnel**.

60.3 VLAN Tag Format

A VLAN tag (service provider VLAN stacking or customer IEEE 802.1Q) consists of the following three fields.

Table 226 VLAN Tag Format

Type	Priority	VID
------	----------	-----

Type is a standard Ethernet type code identifying the frame and indicates that whether the frame carries IEEE 802.1Q tag information. **SP TPID** (Service Provider Tag Protocol Identifier) is the service provider VLAN stacking tag type. Many vendors use 0x8100 or 0x9100.

TPID (Tag Protocol Identifier) is the customer IEEE 802.1Q tag.

- If the VLAN stacking port role is **Access** port, then the Switch adds the **SP TPID** tag to all incoming frames on the service provider's edge devices (1 and 2 in the VLAN stacking example figure).
- If the VLAN stacking port role is **Tunnel** port, then the Switch only adds the **SP TPID** tag to all incoming frames on the service provider's edge devices (1 and 2 in the VLAN stacking example figure) that have an **SP TPID** different to the one configured on the Switch. (If an incoming frame's **SP TPID** is the same as the one configured on the Switch, then the Switch will not add the tag.)

Priority refers to the IEEE 802.1p standard that allows the service provider to prioritize traffic based on the class of service (CoS) the customer has paid for.

- On the Switch, configure priority level of the inner IEEE 802.1Q tag in the **PORT > Port Setup** screen.
- "0" is the lowest priority level and "7" is the highest.

VID is the VLAN ID. **SPVID** is the VID for the second (service provider's) VLAN tag.

60.3.1 Frame Format

The frame format for an untagged Ethernet frame, a single-tagged 802.1Q frame (customer) and a "double-tagged" 802.1Q frame (service provider) is shown next.

Configure the fields as highlighted in the Switch **SWITCHING > VLAN Stacking** screens.

Table 227 Single and Double Tagged 802.1Q Frame Format

						DA	SA	Len/Etype	Data	FCS	Untagged Ethernet frame
			DA	SA	TPID	Priority	VID	Len/Etype	Data	FCS	IEEE 802.1Q customer tagged frame
DA	SA	SPTPID	Priority	VID	TPID	Priority	VID	Len/Etype	Data	FCS	Double-tagged frame

Table 228 802.1Q Frame

DA	Destination Address	Priority	802.1p Priority
SA	Source Address	Len/Etype	Length and type of Ethernet frame
(SP)TPID	(Service Provider) Tag Protocol IDentifier	Data	Frame data
VID	VLAN ID	FCS	Frame Check Sequence

60.4 Configuring VLAN Stacking

Click **SWITCHING > VLAN Stacking** to display the screen as shown.

Figure 360 SWITCHING > VLAN Stacking > VLAN Stacking (Standalone Mode)

VLAN Stacking Port-Based QinQ Selective QinQ

Active OFF

Port	Role	Tunnel TPID (Hex)
*	Normal ▼	<input type="text"/>
1	Normal ▼	<input type="text" value="8100"/>
2	Normal ▼	<input type="text" value="8100"/>
3	Normal ▼	<input type="text" value="8100"/>
4	Normal ▼	<input type="text" value="8100"/>
5	Normal ▼	<input type="text" value="8100"/>
6	Normal ▼	<input type="text" value="8100"/>
7	Normal ▼	<input type="text" value="8100"/>

Figure 361 SWITCHING > VLAN Stacking > VLAN Stacking (Stacking Mode)

VLAN Stacking Port-Based QinQ Selective QinQ

Active OFF

SLOT 1 ▼

Port	Role	Tunnel TPID (Hex)
1/*	Normal ▼	<input type="text"/>
1/1	Normal ▼	<input type="text" value="8100"/>
1/2	Normal ▼	<input type="text" value="8100"/>
1/3	Normal ▼	<input type="text" value="8100"/>
1/4	Normal ▼	<input type="text" value="8100"/>
1/5	Normal ▼	<input type="text" value="8100"/>
1/6	Normal ▼	<input type="text" value="8100"/>
1/7	Normal ▼	<input type="text" value="8100"/>

The following table describes the labels in this screen.

Table 229 SWITCHING > VLAN Stacking > VLAN Stacking

LABEL	DESCRIPTION
Active	Enable the switch button to enable VLAN stacking on the Switch.
SLOT	This field appears only in Stacking mode. Click the drop-down list to choose the slot number of the Switch in a stack.
Port	This field displays the port number. In Stacking mode, the first number represents the slot ID and the second is the port number. Please note that the default stacking ports (the last four ports of your Switch) cannot be configured. They are reserved for stacking only.
*	Settings in this row apply to all ports. Use this row only if you want to make some settings the same for all ports. Use this row first to set the common settings and then make adjustments on a port-by-port basis. Note: Changes in this row are copied to all the ports as soon as you make them.
Role	Select Normal to have the Switch ignore frames received (or transmitted) on this port with VLAN stacking tags. Anything you configure in SPVID and Priority of the Port-based QinQ or the Selective QinQ screen are ignored. Select Access to have the Switch add the SP TPID tag to all incoming frames received on this port. Select Access for ingress ports at the edge of the service provider's network. Select Tunnel (available for Gigabit ports only) for egress ports at the edge of the service provider's network. Select Tunnel to have the Switch add the Tunnel TPID (HEX) tag to all outgoing frames sent on this port. In order to support VLAN stacking on a port, the port must be able to allow frames of 1526 Bytes (1522 Bytes + 4 Bytes for the second tag) to pass through it.
Tunnel TPID (HEX)	TPID is a standard Ethernet type code identifying the frame and indicates whether the frame carries IEEE 802.1Q tag information. Enter a four-digit hexadecimal number from 0000 to FFFF that the Switch adds in the outer VLAN tag of the frames sent on the tunnel ports. The Switch also uses this to check if the received frames are double-tagged. The value of this field is 0x8100 as defined in IEEE 802.1Q. It is used to identify the customer tag of an incoming frame. If the Switch needs to communicate with other vendors' devices, they should use the same TPID. Note: You can define up to four different tunnel TPIDs (including 8100) in this screen at a time.
Apply	Click Apply to save your changes to the Switch's run-time memory. The Switch loses these changes if it is turned off or loses power, so use the Save link on the top navigation panel to save your changes to the non-volatile memory when you are done configuring.
Cancel	Click Cancel to begin configuring this screen afresh.

60.5 Port-Based Q-in-Q

Port-based Q-in-Q lets the Switch treat all frames received on the same port as the same VLAN flows and add the same outer VLAN tag to them, even if they have different customer VLAN IDs.

Click **SWITCHING > VLAN Stacking > Port-Based QinQ** to display the screen as shown.

Figure 362 SWITCHING > VLAN Stacking > Port-Based QinQ (Standalone Mode)

Port	SPVID	Priority
*	<input type="text"/>	0 ▾
1	1 <input type="text"/>	0 ▾
2	1 <input type="text"/>	0 ▾
3	1 <input type="text"/>	0 ▾
4	1 <input type="text"/>	0 ▾
5	1 <input type="text"/>	0 ▾
6	1 <input type="text"/>	0 ▾
7	1 <input type="text"/>	0 ▾

Figure 363 SWITCHING > VLAN Stacking > Port-Based QinQ (Stacking Mode)

SLOT 1 ▾

Port	SPVID	Priority
1/*	<input type="text"/>	0 ▾
1/1	1 <input type="text"/>	0 ▾
1/2	1 <input type="text"/>	0 ▾
1/3	1 <input type="text"/>	0 ▾
1/4	1 <input type="text"/>	0 ▾
1/5	1 <input type="text"/>	0 ▾
1/6	1 <input type="text"/>	0 ▾
1/7	1 <input type="text"/>	0 ▾

The following table describes the labels in this screen.

Table 230 SWITCHING > VLAN Stacking > Port-Based QinQ

LABEL	DESCRIPTION
SLOT	This field appears only in Stacking mode. Click the drop-down list to choose the slot number of the Switch in a stack.
Port	This field displays the port number. In Stacking mode, the first number represents the slot ID and the second is the port number. Please note that the default stacking ports (the last four ports of your Switch) cannot be configured. They are reserved for stacking only.

Table 230 SWITCHING > VLAN Stacking > Port-Based QinQ (continued)

LABEL	DESCRIPTION
*	Settings in this row apply to all ports. Use this row only if you want to make some settings the same for all ports. Use this row first to set the common settings and then make adjustments on a port-by-port basis. Note: Changes in this row are copied to all the ports as soon as you make them.
SPVID	SPVID is the service provider's VLAN ID (the outer VLAN tag). Enter the service provider ID (from 1 to 4094) for frames received on this port.
Priority	Select a priority level (from 0 to 7). This is the service provider's priority level that adds to the frames received on this port. "0" is the lowest priority level and "7" is the highest.
Apply	Click Apply to save your changes to the Switch's run-time memory. The Switch loses these changes if it is turned off or loses power, so use the Save link on the top navigation panel to save your changes to the non-volatile memory when you are done configuring.
Cancel	Click Cancel to begin configuring this screen afresh.

60.6 Selective Q-in-Q

Selective Q-in-Q is VLAN-based. It allows the Switch to add different outer VLAN tags to the incoming frames received on one port according to their inner VLAN tags.

Note: Selective Q-in-Q rules are only applied to single-tagged frames received on the access ports. If the incoming frames are untagged or single-tagged but received on a tunnel port or cannot match any selective Q-in-Q rules, the Switch applies the port-based Q-in-Q rules to them.

Click **SWITCHING > VLAN Stacking > Selective QinQ** to display the screen as shown.

Figure 364 SWITCHING > VLAN Stacking > Selective QinQ

The following table describes the labels in this screen.

Table 231 SWITCHING > VLAN Stacking > Selective QinQ

LABEL	DESCRIPTION
Index	This is the number of the selective VLAN stacking rule.
Active	This shows whether this rule is activated or not.
Name	This is the descriptive name for this rule.
Port	This is the port number to which this rule is applied. In Stacking mode, the first number represents the slot and the second the port number.
CVID	This is the customer VLAN ID in the incoming packets.
SPVID	This is the service provider's VLAN ID that adds to the packets from the subscribers.

Table 231 SWITCHING > VLAN Stacking > Selective QinQ (continued)

LABEL	DESCRIPTION
Priority	This is the service provider's priority level in the packets.
	Select an entry's check box to select a specific entry. Otherwise, select the check box in the table heading row to select all entries.
Add/Edit	Click Add/Edit to add a new entry or edit a selected one.
Delete	Click Delete to remove the selected entries.

60.6.1 Add/Edit Selective Q-in-Q

Click **Add/Edit**, or select an entry and click **Add/Edit** in the **SWITCHING > VLAN Stacking > Selective QinQ** screen to display this screen.

Figure 365 SWITCHING > VLAN Stacking > Selective QinQ > Add/Edit (Standalone Mode)

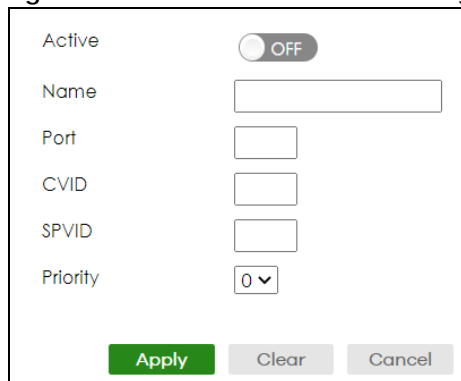
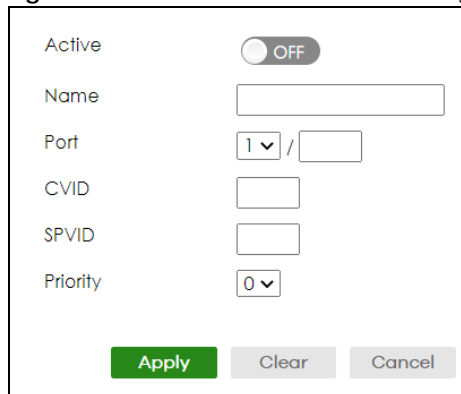

Figure 366 SWITCHING > VLAN Stacking > Selective QinQ > Add/Edit (Stacking Mode)



The following table describes the labels in this screen.

Table 232 SWITCHING > VLAN Stacking > Selective QinQ > Add/Edit

LABEL	DESCRIPTION
Active	Enable the switch button to activate this rule.
Name	Enter a descriptive name (up to 32 printable ASCII characters except [?], [], ['], ["] or [,]) for identification purposes.
Port	The port number identifies the port you are configuring. In Stacking mode, the first field is the slot ID and the second field is the port number.
CVID	Enter a customer VLAN ID (the inner VLAN tag) from 1 to 4094. This is the VLAN tag carried in the packets from the subscribers.

Table 232 SWITCHING > VLAN Stacking > Selective QinQ > Add/Edit (continued)

LABEL	DESCRIPTION
SPVID	SPVID is the service provider's VLAN ID (the outer VLAN tag). Enter the service provider ID (from 1 to 4094) for frames received on this port.
Priority	Select a priority level (from 0 to 7). This is the service provider's priority level that adds to the frames received on this port. "0" is the lowest priority level and "7" is the highest.
Apply	Click Apply to save your changes to the Switch's run-time memory. The Switch loses these changes if it is turned off or loses power, so use the Save link on the top navigation panel to save your changes to the non-volatile memory when you are done configuring.
Clear	Click Clear to clear the fields to the factory defaults.
Cancel	Click Cancel to not save the configuration you make and return to the last screen.

CHAPTER 61

NETWORKING

The following chapters introduces the configurations of the links under the **NETWORKING** navigation panel.

Quick links to chapters:

- [ARP Setup](#)
- [DHCP](#)
- [Static Route](#)

CHAPTER 62

ARP Setup

62.1 ARP Overview

Address Resolution Protocol (ARP) is a protocol for mapping an Internet Protocol address (IP address) to a physical machine address, also known as a Media Access Control or MAC address, on the local area network.

An IP (version 4) address is 32 bits long. In an Ethernet LAN, MAC addresses are 48 bits long. The ARP table maintains an association between each MAC address and its corresponding IP address.

62.1.1 What You Can Do

Use the **ARP Learning** screen ([Section 62.2 on page 462](#)) to configure ARP learning mode on a per-port basis.

Use the **Static ARP** screen ([Section 62.3 on page 464](#)) to create static ARP entries that will display in the **MONITOR > ARP Table** screen and will not age out.

62.1.2 What You Need to Know

Read on for concepts on ARP that can help you configure the screen in this chapter.

62.1.2.1 How ARP Works

When an incoming packet destined for a host device on a local area network arrives at the Switch, the Switch looks in the ARP Table and if it finds the address, it sends it to the device.

If no entry is found for the IP address, ARP broadcasts the request to all the devices on the LAN. The Switch fills in its own MAC and IP address in the sender address fields, and puts the known IP address of the target in the target IP address field. In addition, the Switch puts all ones in the target MAC field (FF.FF.FF.FF.FF.FF is the Ethernet broadcast address). The replying device (which is either the IP address of the device being sought or the router that knows the way) replaces the broadcast address with the target's MAC address, swaps the sender and target pairs, and unicasts the answer directly back to the requesting machine. ARP updates the ARP Table for future reference and then sends the packet to the MAC address that replied.

62.1.2.2 ARP Learning Mode

The Switch supports three ARP learning modes: ARP-Reply, Gratuitous-ARP, and ARP-Request.

ARP-Reply

The Switch in ARP-Reply learning mode updates the ARP table only with the ARP replies to the ARP requests sent by the Switch. This can help prevent ARP spoofing.

In the following example, the Switch does not have IP address and MAC address mapping information for hosts **A** and **B** in its ARP table, and host **A** wants to ping host **B**. Host **A** sends an ARP request to the Switch and then sends an ICMP request after getting the ARP reply from the Switch. The Switch finds no matched entry for host **B** in the ARP table and broadcasts the ARP request to all the devices on the LAN. When the Switch receives the ARP reply from host **B**, it updates its ARP table and also forwards host **A**'s ICMP request to host **B**. After the Switch gets the ICMP reply from host **B**, it sends out an ARP request to get host **A**'s MAC address and updates the ARP table with host **A**'s ARP reply. The Switch then can forward host **B**'s ICMP reply to host **A**.

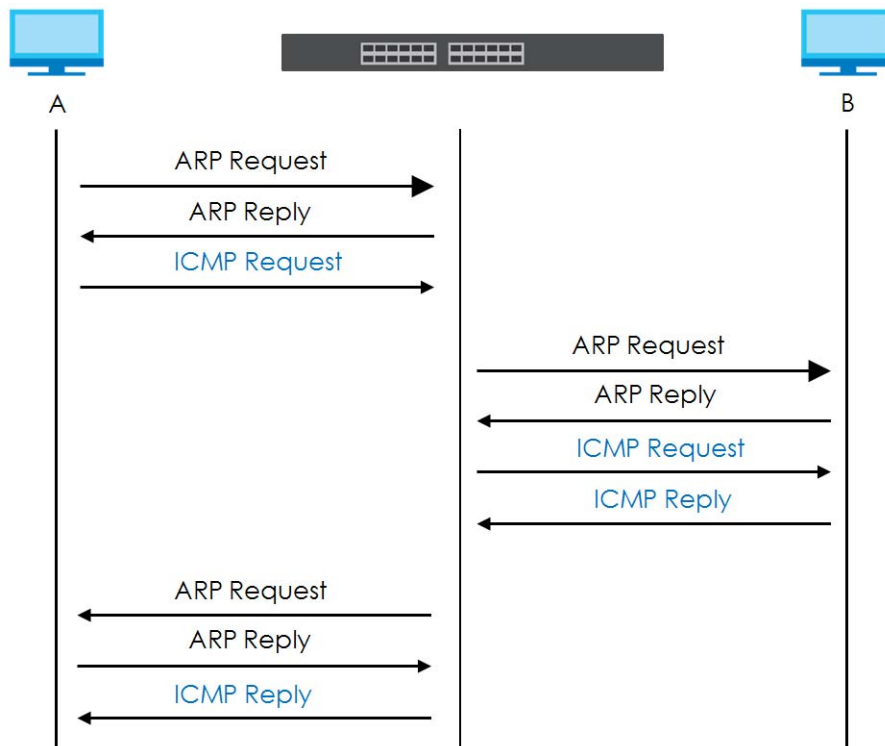

Gratuitous-ARP

A gratuitous ARP is an ARP request in which both the source and destination IP address fields are set to the IP address of the device that sends this request and the destination MAC address field is set to the broadcast address. There will be no reply to a gratuitous ARP request.

A device may send a gratuitous ARP packet to detect IP collisions. If a device restarts or its MAC address is changed, it can also use gratuitous ARP to inform other devices in the same network to update their ARP table with the new mapping information.

In Gratuitous-ARP learning mode, the Switch updates its ARP table with either an ARP reply or a gratuitous ARP request.

ARP-Request

When the Switch is in ARP-Request learning mode, it updates the ARP table with both ARP replies, gratuitous ARP requests and ARP requests.

Therefore in the following example, the Switch can learn host **A**'s MAC address from the ARP request sent by host **A**. The Switch then forwards host **B**'s ICMP reply to host **A** right after getting host **B**'s MAC address and ICMP reply.

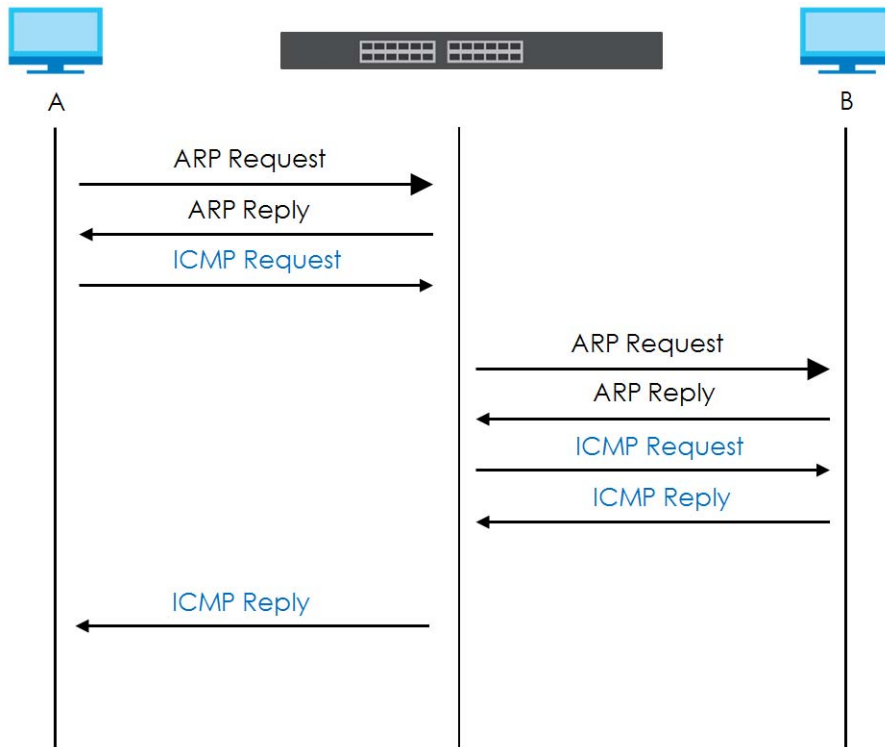

62.2 ARP Learning

Use this screen to configure each port's ARP learning mode. Click **NETWORKING > ARP Setup > ARP Learning** in the navigation panel to display the screen as shown next.

Figure 367 NETWORKING > ARP Setup > ARP Learning (Standalone Mode)

Port	ARP Learning Mode
*	ARP-Reply
1	ARP-Reply
2	ARP-Reply
3	ARP-Reply
4	ARP-Reply
5	ARP-Reply
6	ARP-Reply
7	ARP-Reply

Figure 368 NETWORKING > ARP Setup > ARP Learning (Stacking Mode)

Port	ARP Learning Mode
1/*	ARP-Reply
1/1	ARP-Reply
1/2	ARP-Reply
1/3	ARP-Reply
1/4	ARP-Reply
1/5	ARP-Reply
1/6	ARP-Reply
1/7	ARP-Reply

The following table describes the labels in this screen.

Table 233 NETWORKING > ARP Setup > ARP Learning

LABEL	DESCRIPTION
SLOT	This field appears only in Stacking mode. Click the drop-down list to choose the slot number of the Switch in a stack.
Port	This field displays the port number. In Stacking mode, the first number represents the slot ID and the second is the port number. Please note that the default stacking ports (the last four ports of your Switch) cannot be configured. They are reserved for stacking only.
*	Settings in this row apply to all ports. Use this row only if you want to make some settings the same for all ports. Use this row first to set the common settings and then make adjustments on a port-by-port basis. Changes in this row are copied to all the ports as soon as you make them.

Table 233 NETWORKING > ARP Setup > ARP Learning (continued)

LABEL	DESCRIPTION
ARP Learning Mode	Select the ARP learning mode the Switch uses on the port. Select ARP-Reply to have the Switch update the ARP table only with the ARP replies to the ARP requests sent by the Switch. Select Gratuitous-ARP to have the Switch update its ARP table with either an ARP reply or a gratuitous ARP request. Select ARP-Request to have the Switch update the ARP table with both ARP replies, gratuitous ARP requests and ARP requests.
Apply	Click Apply to save your changes to the Switch's run-time memory. The Switch loses these changes if it is turned off or loses power, so use the Save link on the top navigation panel to save your changes to the non-volatile memory when you are done configuring.
Cancel	Click Cancel to begin configuring this screen afresh.

62.3 Static ARP

Use this screen to view and configure static ARP entries that will display in the **MONITOR > ARP Table** screen and will not age out. Click **NETWORKING > ARP Setup > Static ARP** to display the screen as shown.

Figure 369 NETWORKING > ARP Setup > Static ARP



The following table describes the related labels in this screen.

Table 234 NETWORKING > ARP Setup > Static ARP

LABEL	DESCRIPTION
Index	This field displays the index number of an entry.
Active	This field displays whether the entry is activated.
Name	This field displays the descriptive name for this entry. This is for identification purposes only.
IP Address	This is the IP address of a device connected to a Switch port with the corresponding MAC address below.
MAC Address	This is the MAC address of the device with the corresponding IP address above.
VID	This field displays the VLAN to which the device belongs.
Port	This field displays the port to which the device connects.
	Select an entry's check box to select a specific entry. Otherwise, select the check box in the table heading row to select all entries.
Add/Edit	Click Add/Edit to add a new entry or edit a selected one.
Delete	Click Delete to remove the selected entries.

62.3.1 Add/Edit Static ARP

Use this screen to add/edit static ARP entries. Click **Add/Edit**, or select an entry and click **Add/Edit** in the **NETWORKING > ARP Setup > Static ARP** to display this screen.

Figure 370 NETWORKING > ARP Setup > Static ARP > Add/Edit (Standalone Mode)

Figure 371 NETWORKING > ARP Setup > Static ARP > Add/Edit (Stacking Mode)

The following table describes the related labels in this screen.

Table 235 NETWORKING > ARP Setup > Static ARP > Add/Edit

LABEL	DESCRIPTION
Active	Enable the switch button to activate your rule. You may temporarily deactivate a rule without deleting it by clearing this check box.
Name	Enter a descriptive name (up to 32 printable ASCII characters except [?], [], ['], ["] or [,]) for identification purposes.
IP Address	Enter the IP address of a device connected to a Switch port with the corresponding MAC address below.
MAC Address	Enter the MAC address of the device with the corresponding IP address above.
VID	Enter the ID number of VLAN to which the device belongs.
Port	Enter the number of port to which the device connects. In Stacking mode, the first field is the slot ID and the second field is the port number.
Apply	Click Apply to save your changes to the Switch's run-time memory. The Switch loses these changes if it is turned off or loses power, so use the Save link on the top navigation panel to save your changes to the non-volatile memory when you are done configuring.
Clear	Click Clear to clear the fields to the factory defaults.
Cancel	Click Cancel to not save the configuration you make and return to the last screen.

CHAPTER 63

DHCP

63.1 DHCP Overview

This chapter shows you how to configure the DHCP feature.

DHCP (Dynamic Host Configuration Protocol RFC 2131 and RFC 2132) allows individual computers to obtain TCP/IP configuration at start-up from a server. You can configure the Switch as a DHCP server or a DHCP relay agent. When configured as a server, the Switch provides the TCP/IP configuration for the clients. If you configure the Switch as a relay agent, then the Switch forwards DHCP requests to DHCP server on your network. If you do not configure the Switch as a DHCP server or relay agent then you must have a DHCP server in the broadcast domain of the client computers or else the client computers must be configured manually.

63.1.1 What You Can Do

- Use the **DHCPv4 Relay Status** screen ([Section 63.2 on page 467](#)) to display the relay mode and status.
- Use the **DHCPv4 Option 82 Profile** screen ([Section 63.3 on page 467](#)) to create DHCPv4 option 82 profiles.
- Use the **DHCPv4 Smart Relay** screen ([Section 63.4 on page 469](#)) to configure global DHCPv4 relay. You can also use this screen to apply different DHCP option 82 profile to certain ports on the Switch.
- Use the **DHCPv4 Relay VLAN Setting** screen ([Section 63.5 on page 473](#)) to configure your DHCPv4 settings based on the VLAN domain of the DHCPv4 clients. You can also use this screen to apply a different DHCP option 82 profile to certain ports in a VLAN.
- Use the **DHCPv6 Relay** screen ([Section 63.6 on page 475](#)) to enable and configure DHCPv6 relay.
- Use the **DHCP Server Guard** screen ([Section 63.7 on page 477](#)) to specify whether ports are trusted or untrusted ports for DHCP packets.

63.1.2 What You Need to Know

Read on for concepts on DHCP that can help you configure the screens in this chapter.

DHCP Modes

If there is already a DHCP server on your network, then you can configure the Switch as a DHCP relay agent. When the Switch receives a request from a computer on your network, it contacts the DHCP server for the necessary IP information, and then relays the assigned information back to the computer.

DHCPv4 Configuration Options

The DHCPv4 configuration on the Switch is divided into **Smart Relay** and **VLAN** screens. The screen you should use for configuration depends on the DHCP services you want to offer the DHCP clients on your network. Choose the configuration screen based on the following criteria:

- **Smart Relay** – The Switch forwards all DHCP requests to the same DHCP server.
- **VLAN** – The Switch is configured on a VLAN by VLAN basis. The Switch can be configured to relay DHCP requests to different DHCP servers for clients in different VLAN.

63.2 DHCPv4 Relay Status

Click **NETWORKING > DHCP > DHCPv4 Relay** in the navigation panel. The **DHCP Relay Status** screen displays.

Figure 372 NETWORKING > DHCP > DHCPv4 Relay > DHCP Relay Status

DHCP Relay Status		DHCP Option 82 Profile	DHCP Smart Relay	DHCP Relay VLAN Setting
Relay Mode	VLAN: 1			
VID	Current Source Address			
1	172.21.40.213			

The following table describes the labels in this screen.

Table 236 NETWORKING > DHCP > DHCPv4 Relay > DHCP Relay Status

LABEL	DESCRIPTION
Relay Mode	This field displays: None – if the Switch is not configured as a DHCP relay agent. Smart – if the Switch is configured as a DHCP relay agent only. VLAN – followed by a VLAN ID or multiple VLAN IDs if it is configured as a relay agent for specific VLANs.
VID	This field displays the ID number of the VLAN for which the Switch acts as a DHCP relay agent.
Current Source Address	This field displays the source IP address of the DHCP requests that the Switch forwards to a DHCP server.

63.3 DHCPv4 Option 82 Profile

Use this screen to view and configure DHCPv4 option 82 profiles. Click **NETWORKING > DHCP > DHCPv4 Relay > DHCP Option 82 Profile** link to display the screen as shown.

Figure 373 NETWORKING > DHCP > DHCPv4 Relay > DHCP Option 82 Profile

<input type="checkbox"/>	Profile Name	Enable	Circuit-ID	Field	Enable	Remote-ID	Field
<input checked="" type="checkbox"/>	default1	ON		slot-port, vlan	OFF		-
<input type="checkbox"/>	default2	ON		slot-port, vlan, hostname	OFF		-

The following table describes the labels in this screen.

Table 237 NETWORKING > DHCP > DHCPv4 Relay > DHCP Option 82 Profile

LABEL	DESCRIPTION
Profile Name	This field displays the descriptive name of the profile.
Circuit-ID	This section displays the Circuit ID sub-option including information that is specific to the relay agent (the Switch).
Enable	This field displays whether the Circuit ID sub-option is added to client DHCP requests.
Field	This field displays the information that is included in the Circuit ID sub-option.
Remote-ID	This section displays the Remote ID sub-option including information that identifies the relay agent (the Switch).
Enable	This field displays whether the Remote ID sub-option is added to client DHCP requests.
Field	This field displays the information that is included in the Remote ID sub-option.
	Select an entry's check box to select a specific entry. Otherwise, select the check box in the table heading row to select all entries.
Add/Edit	Click Add/Edit to add a new entry or edit a selected one.
Delete	Click Delete to remove the selected entries.

63.3.1 Add/Edit a DHCPv4 Option 82 Profile

Use this screen to create DHCPv4 option 82 profiles. Click **Add/Edit**, or select an entry and click **Add/Edit** in the **NETWORKING > DHCP > DHCPv4 Relay > DHCP Option 82 Profile** link to display this screen.

Figure 374 NETWORKING > DHCP > DHCPv4 Relay > DHCP Option 82 Profile > Add/Edit

Name:

Circuit-ID: Enable
 slot-port vlan hostname
string:

Remote-ID: Enable
 mac
string:

Note: The string of any field in this screen should not contain [?], [|], ['], ["] or [,].

The following table describes the labels in this screen.

Table 238 NETWORKING > DHCP > DHCPv4 Relay > DHCP Option 82 Profile > Add/Edit

LABEL	DESCRIPTION
Name	Enter a descriptive name for the profile for identification purposes. You can use up to 32 printable ASCII characters.
Circuit-ID	Use this section to configure the Circuit ID sub-option to include information that is specific to the relay agent (the Switch).
Enable	Select this option to have the Switch add the Circuit ID sub-option to client DHCP requests that it relays to a DHCP server.
slot-port	Select this option to have the Switch add the number of port that the DHCP client is connected to.
vlan	Select this option to have the Switch add the ID of VLAN which the port belongs to.
hostname	This is the system name you configure in the SYSTEM > General Setup screen. Select this option for the Switch to add the system name to the client DHCP requests that it relays to a DHCP server.
string	Enter a string of up to 64 printable ASCII characters that the Switch adds into the client DHCP requests.
Remote-ID	Use this section to configure the Remote ID sub-option to include information that identifies the relay agent (the Switch).
Enable	Select this option to have the Switch append the Remote ID sub-option to the option 82 field of DHCP requests.
mac	Select this option to have the Switch add its MAC address to the client DHCP requests that it relays to a DHCP server.
string	Enter a string of up to 64 printable ASCII characters for the remote ID information in this field.
Apply	Click Apply to save your changes to the Switch's run-time memory. The Switch loses these changes if it is turned off or loses power, so use the Save link on the top navigation panel to save your changes to the non-volatile memory when you are done configuring.
Clear	Click Clear to clear the fields to the factory defaults.
Cancel	Click Cancel to not save the configuration you make and return to the last screen.

63.4 Configuring DHCPv4 Smart Relay

Use this screen to configure global DHCPv4 relay. Click **NETWORKING > DHCP > DHCPv4 Relay > DHCP Smart Relay** to display the screen as shown.

Figure 375 NETWORKING > DHCP > DHCPv4 Relay > DHCP Smart Relay

The following table describes the labels in this screen.

Table 239 NETWORKING > DHCP > DHCPv4 Relay > DHCP Smart Relay

LABEL	DESCRIPTION
DHCP Smart Relay	
Active	Select this check box to enable DHCPv4 relay.
Remote DHCP Server 1 .. 3	Enter the IP address of a DHCPv4 server in dotted decimal notation.
Option 82 Profile	Select a pre-defined DHCPv4 option 82 profile that the Switch applies to all ports. The Switch adds the Circuit ID sub-option and/or Remote ID sub-option specified in the profile to DHCP requests that it relays to a DHCP server.
Apply	Click Apply to save your changes to the Switch's run-time memory. The Switch loses these changes if it is turned off or loses power, so use the Save link on the top navigation panel to save your changes to the non-volatile memory when you are done configuring.
Cancel	Click Cancel to begin configuring this screen afresh.
Port	
Use this section to apply a different DHCP option 82 profile to certain ports on the Switch.	
Index	This field displays a sequential number for each entry.
Port	This field displays the port(s) to which the Switch applies the settings. In Stacking mode, the first number represents the slot and the second the port number.
Profile Name	This field displays the DHCP option 82 profile that the Switch applies to the ports.
	Select an entry's check box to select a specific entry. Otherwise, select the check box in the table heading row to select all entries.
Add/Edit	Click Add/Edit to add a new entry or edit a selected one.
Delete	Click Delete to remove the selected entries.

63.4.1 Add/Edit DHCPv4 Global Relay Port

Use this screen to apply a different DHCP option 82 profile to certain ports on the Switch. To open this screen, Click **Add/Edit**, or select an entry and click **Add/Edit** in the **Port** section of the **NETWORKING > DHCP > DHCPv4 Relay > DHCP Smart Relay** screen.

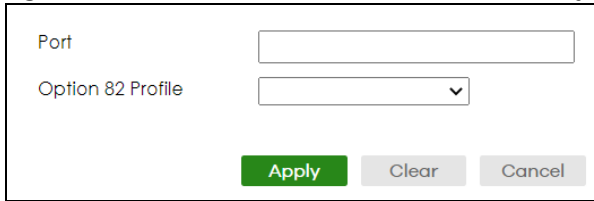
Figure 376 NETWORKING > DHCP > DHCPv4 Relay > DHCP Smart Relay > Add/Edit

The following table describes the labels in this screen.

Table 240 NETWORKING > DHCP > DHCPv4 Relay > DHCP Smart Relay > Add/Edit

LABEL	DESCRIPTION
Port	Enter the number of ports to which you want to apply the specified DHCP option 82 profile. You can enter multiple ports separated by (no space) comma (,) or hyphen (-) for a range. For example, enter "3-5" for ports 3, 4, and 5. Enter "3,5,7" for ports 3, 5, and 7. In Stacking mode, the first number represents the slot and the second the port number. Enter 1/1-1/24,2/28 for ports 1 to 24 for the Switch in slot 1 and port 28 for the Switch in slot 2, for example.
Option 82 Profile	Select a pre-defined DHCP option 82 profile that the Switch applies to the specified ports. The Switch adds the Circuit ID sub-option and/or Remote ID sub-option specified in the profile to DHCP requests that it relays to a DHCP server. The profile you select here has priority over the one you select in the NETWORKING > DHCP > DHCPv4 Relay > DHCPv4 Smart Relay screen.
Apply	Click Apply to save your changes to the Switch's run-time memory. The Switch loses these changes if it is turned off or loses power, so use the Save link on the top navigation panel to save your changes to the non-volatile memory when you are done configuring.
Clear	Click Clear to clear the fields to the factory defaults.
Cancel	Click Cancel to not save the configuration you make and return to the last screen.

63.4.2 DHCP Smart Relay Configuration Example

The follow figure shows a network example where the Switch is used to relay DHCP requests for the **VLAN1** and **VLAN2** domains. There is only one DHCP server that services the DHCP clients in both domains.

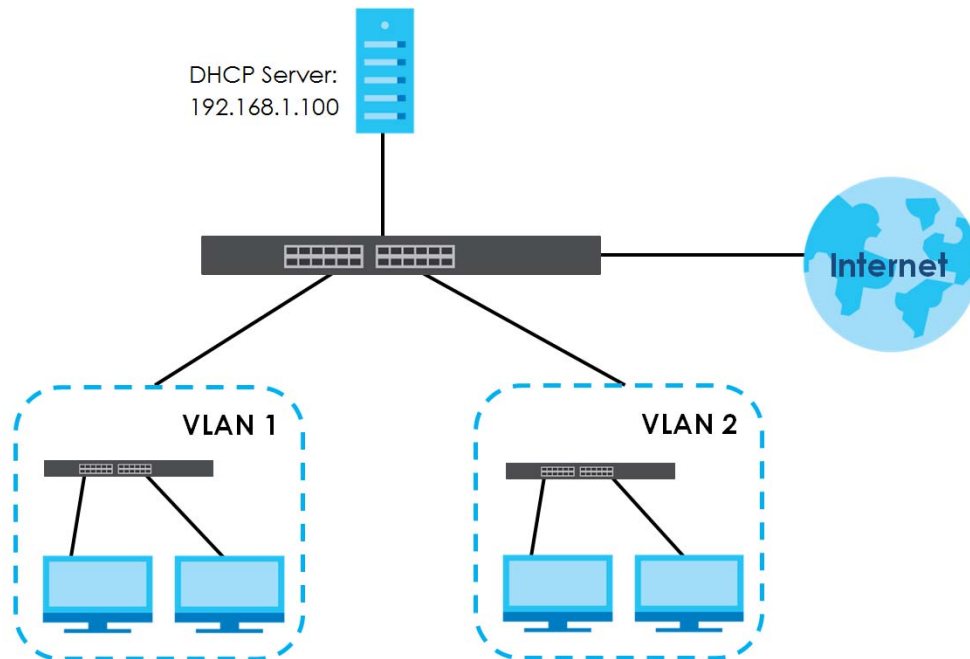
Figure 377 DHCP Smart Relay Network Example

Configure the **NETWORKING > DHCP > DHCPv4 Relay > DHCP Smart Relay** screen as shown. Make sure you select a DHCP option 82 profile (**default1** in this example) to set the Switch to send additional information (such as the VLAN ID) together with the DHCP requests to the DHCP server. This allows the DHCP server to assign the appropriate IP address according to the VLAN ID. Click **Apply** after you finish the configuration.

Figure 378 DHCP Relay Configuration Example

DHCP Status
DHCP Option 82 Profile
DHCP Smart Relay

DHCP Smart Relay

Active ON

Remote DHCP Server 1

Remote DHCP Server 2

Remote DHCP Server 3

Option 82 Profile

Apply
Cancel

Port

+ Add/Edit
 - Delete

	Index	Port	Profile Name
<input type="checkbox"/>			

63.5 DHCPv4 VLAN Setting

Use this screen to configure your DHCP settings based on the VLAN domain of the DHCP clients. Click **NETWORKING > DHCP > DHCPv4 Relay > DHCP Relay VLAN Setting** to display the screen as shown.

Figure 379 NETWORKING > DHCP > DHCPv4 Relay > DHCP Relay VLAN Setting

The following table describes the labels in this screen.

Table 241 NETWORKING > DHCP > DHCPv4 Relay > DHCP Relay VLAN Setting

LABEL	DESCRIPTION
DHCP Relay VLAN Setting	
VID	This field displays the ID number of the VLAN group to which this DHCP settings apply.
Remote DHCP Server	This displays the IP address of a DHCP server in dotted decimal notation.
Source Address	This field displays the source IP address you configured for DHCP requests from clients on this VLAN.
	Select an entry's check box to select a specific entry. Otherwise, select the check box in the table heading row to select all entries.
Add/Edit	Click Add/Edit to add a new entry or edit a selected one.
Delete	Click Delete to remove the selected entries.
Port	
Use this section to apply a different DHCP option 82 profile to certain ports in a VLAN.	
Index	This field displays a sequential number for each entry. Click an index number to change the settings.
VID	This field displays the VLAN to which the ports belongs.
Port	This field displays the ports to which the Switch applies the settings.
Profile Name	This field displays the DHCP option 82 profile that the Switch applies to the ports in this VLAN.
	Select an entry's check box to select a specific entry. Otherwise, select the check box in the table heading row to select all entries.
Add/Edit	Click Add/Edit to add a new entry or edit a selected one.
Delete	Click Delete to remove the selected entries.

63.5.1 Add/Edit DHCPv4 VLAN Setting

Use this screen to add/edit your DHCP settings based on the VLAN domain of the DHCP clients. Click the **Add/Edit** button in the **DHCP Relay VLAN Setting** section of the **NETWORKING > DHCP > DHCPv4 Relay > DHCP Relay VLAN Setting** screen to access this screen.

Note: You must set up a management IP address for each VLAN that you want to configure DHCP settings for on the Switch.

Figure 380 NETWORKING > DHCP > DHCPv4 Relay > DHCP Relay VLAN Setting > Add/Edit (DHCP Relay VLAN Setting)

The screenshot shows a configuration form with the following fields and values:

- VID:
- Remote DHCP Server 1:
- Remote DHCP Server 2:
- Remote DHCP Server 3:
- Source Address:
- Option 82 Profile:

Buttons at the bottom: **Apply** (green), **Clear** (grey), **Cancel** (grey).

The following table describes the labels in this screen.

Table 242 NETWORKING > DHCP > DHCPv4 Relay > DHCP Relay VLAN Setting > Add/Edit (DHCP Relay VLAN Setting)

LABEL	DESCRIPTION
VID	Enter the ID number of the VLAN to which these DHCP settings apply.
Remote DHCP Server 1 .. 3	Enter the IP address of a DHCP server in dotted decimal notation.
Source Address	Enter the source IP address that the Switch adds to DHCP requests from clients on this VLAN before forwarding them. If you leave this field set to 0.0.0.0 , the Switch automatically sets the source IP address of the DHCP requests to the IP address of the interface on which the packet is received. The source IP address helps DHCP clients obtain an appropriate IP address when you configure multiple routing domains on a VLAN.
Option 82 Profile	Select a pre-defined DHCP option 82 profile that the Switch applies to all ports in this VLAN. The Switch adds the Circuit ID sub-option and/or Remote ID sub-option specified in the profile to DHCP requests that it relays to a DHCP server.
Apply	Click Apply to save your changes to the Switch's run-time memory. The Switch loses these changes if it is turned off or loses power, so use the Save link on the top navigation panel to save your changes to the non-volatile memory when you are done configuring.
Clear	Click Clear to clear the fields to the factory defaults.
Cancel	Click Cancel to not save the configuration you make and return to the last screen.

63.5.2 Add/Edit DHCPv4 VLAN Port

Use this screen to apply a different DHCP option 82 profile to certain ports in a VLAN. Click the **Add/Edit** button in the **Port** section of the **NETWORKING > DHCP > DHCPv4 Relay > DHCP Relay VLAN Setting** screen to access this screen.

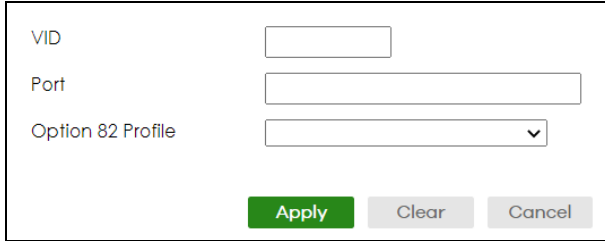
Figure 381 NETWORKING > DHCP > DHCPv4 Relay > DHCP Relay VLAN Setting > Add/Edit (Port)

The following table describes the labels in this screen.

Table 243 NETWORKING > DHCP > DHCPv4 Relay > DHCP Relay VLAN Setting > Add/Edit (Port)

LABEL	DESCRIPTION
VID	Enter the ID number of the VLAN you want to configure here.
Port	Enter the number of ports to which you want to apply the specified DHCP option 82 profile. You can enter multiple ports separated by (no space) comma (,) or hyphen (-) for a range. For example, enter "3-5" for ports 3, 4, and 5. Enter "3,5,7" for ports 3, 5, and 7. In Stacking mode, the first number represents the slot and the second the port number. Enter 1/1-1/24,2/28 for ports 1 to 24 for the Switch in slot 1 and port 28 for the Switch in slot 2, for example.
Option 82 Profile	Select a pre-defined DHCP option 82 profile that the Switch applies to the specified ports in this VLAN. The Switch adds the Circuit ID sub-option and/or Remote ID sub-option specified in the profile to DHCP requests that it relays to a DHCP server. The profile you select here has priority over the one you select in the NETWORKING > DHCP > DHCPv4 Relay > DHCP Relay VLAN Setting (the DHCP Relay VLAN Setting section) > Add/Edit screen.
Apply	Click Apply to save your changes to the Switch's run-time memory. The Switch loses these changes if it is turned off or loses power, so use the Save link on the top navigation panel to save your changes to the non-volatile memory when you are done configuring.
Clear	Click Clear to clear the fields to the factory defaults.
Cancel	Click Cancel to not save the configuration you make and return to the last screen.

63.6 DHCPv6 Relay

A DHCPv6 relay agent is on the same network as the DHCPv6 clients and helps forward messages between the DHCPv6 server (that is in another network) and the DHCPv6 clients.

The DHCPv6 relay agent can add the remote identification (remote-ID) option and the interface-ID option to the Relay-Forward DHCPv6 messages. The remote-ID option carries a user-defined string, such as the system name. The interface-ID option provides slot number, port information and the VLAN ID to the DHCPv6 server. The remote-ID option (if any) is stripped from the Relay-Reply messages before the relay agent sends the packets to the clients. The DHCPv6 server copies the interface-ID option from the Relay-Forward message into the Relay-Reply message and sends it to the relay agent. The interface-ID should not change even after the relay agent restarts.

Use this screen to view and configure DHCPv6 relay settings for a specific VLAN on the Switch. Click **NETWORKING > DHCP > DHCPv6 Relay** in the navigation panel to display the screen as shown.

Figure 382 NETWORKING > DHCP > DHCPv6 Relay

The following table describes the labels in this screen.

Table 244 NETWORKING > DHCP > DHCPv6 Relay

LABEL	DESCRIPTION
VID	This field displays the VLAN ID number.
Helper Address	This field displays the IPv6 address of the remote DHCPv6 server for this VLAN.
Interface ID	This field displays whether the interface-ID option is added to DHCPv6 requests from clients in this VLAN.
Remote ID	This field displays whether the remote-ID option is added to DHCPv6 requests from clients in this VLAN.
	Select an entry's check box to select a specific entry. Otherwise, select the check box in the table heading row to select all entries.
Add/Edit	Click Add/Edit to add a new entry or edit a selected one.
Delete	Click Delete to remove the selected entries.

63.6.1 Add/Edit DHCPv6 Relay

Use this screen to add/edit DHCPv6 relay settings for a specific VLAN on the Switch. Click **Add/Edit**, or select an entry and click **Add/Edit** in the **NETWORKING > DHCP > DHCPv6 Relay** screen to display this screen.

Figure 383 NETWORKING > DHCP > DHCPv6 Relay > Add/Edit

The following table describes the labels in this screen.

Table 245 NETWORKING > DHCP > DHCPv6 Relay > Add/Edit

LABEL	DESCRIPTION
VID	Enter the ID number of the VLAN to which the DHCPv6 server that will assign IP information belongs here.
Helper Address	<p>Enter the IPv6 address of the DHCPv6 server that will assign IP information here.</p> <p>An 128-bit IPv6 address is written as eight 16-bit hexadecimal blocks separated by colons (:). This is an example IPv6 address '2001:0db8:1a2b:0015:0000:0000:1a2f:0000'.</p> <p>IPv6 addresses can be abbreviated in two ways:</p> <ul style="list-style-type: none"> • Leading zeros in a block can be omitted. So '2001:0db8:1a2b:0015:0000:0000:1a2f:0000' can be written as '2001:db8:1a2b:15:0:0:1a2f:0'. • Any number of consecutive blocks of zeros can be replaced by a double colon. A double colon can only appear once in an IPv6 address. So '2001:0db8:0000:0000:1a2f:0000:0000:0015' can be written as '2001:0db8::1a2f:0000:0000:0015', '2001:0db8:0000:0000:1a2f::0015', '2001:db8::1a2f:0:0:15' or '2001:db8:0:0:1a2f::15'.
Interface ID	Enable the switch button to have the Switch add the interface-ID option in the DHCPv6 requests from the clients in the specified VLAN before the Switch forwards them to a DHCPv6 server.
Remote ID	Enter a string of up to 64 printable ASCII characters (except [?], [], ['], ["] or [,]) to be carried in the remote-ID option. The Switch adds the remote-ID option in the DHCPv6 requests from the clients in the specified VLAN before the Switch forwards them to a DHCPv6 server.
Apply	Click Apply to save your changes to the Switch's run-time memory. The Switch loses these changes if it is turned off or loses power, so use the Save link on the top navigation panel to save your changes to the non-volatile memory when you are done configuring.
Clear	Click Clear to clear the fields to the factory defaults.
Cancel	Click Cancel to not save the configuration you make and return to the last screen.

63.7 DHCP Server Guard

Use this screen to specify whether ports are trusted or untrusted ports for DHCP packets. Click **NETWORKING > DHCP > DHCP Server Guard** in the navigation panel to display the screen as shown.

Figure 384 NETWORKING > DHCP > DHCP Server Guard (Standalone Mode)

DHCP Server Guard

DHCP Server Guard

Active OFF

Port Setting

Port	Trusted State
*	Untrusted ▼
1	Untrusted ▼
2	Untrusted ▼
3	Untrusted ▼
4	Untrusted ▼
5	Untrusted ▼
6	Untrusted ▼
7	Untrusted ▼

Figure 385 NETWORKING > DHCP > DHCP Server Guard (Stacking Mode)

DHCP Server Guard

DHCP Server Guard

Active OFF

Port Setting

SLOT 1 ▼

Port	Trusted State
1/*	Untrusted ▼
1/1	Untrusted ▼
1/2	Untrusted ▼
1/3	Untrusted ▼
1/4	Untrusted ▼
1/5	Untrusted ▼
1/6	Untrusted ▼
1/7	Untrusted ▼

The following table describes the labels in this screen.

Table 246 NETWORKING > DHCP > DHCP Server Guard

LABEL	DESCRIPTION
DHCP Server Guard	
Active	Enable the switch button to enable DHCP Server Guard.
Port Setting	
SLOT	This field appears only in Stacking mode. Click the drop-down list to choose the slot number of the Switch in a stack.
Port	This field displays the port number. In Stacking mode, the first number represents the slot ID and the second is the port number. Please note that the default stacking ports (the last four ports of your Switch) cannot be configured. They are reserved for stacking only.
*	<p>Settings in this row apply to all ports.</p> <p>Use this row only if you want to make some settings the same for all ports. Use this row first to set the common settings and then make adjustments on a port-by-port basis.</p> <p>Note: Changes in this row are copied to all the ports as soon as you make them.</p>
Trusted State	<p>Select whether this port is a trusted port (Trusted) or an untrusted port (Untrusted). The Switch does not discard DHCP packets on trusted ports for any reason.</p> <p>The Switch discards DHCP packets from untrusted ports when the packet is a DHCP server packet (for example, OFFER, ACK, or NACK).</p>
Apply	Click Apply to save your changes to the Switch's run-time memory. The Switch loses these changes if it is turned off or loses power, so use the Save link on the top navigation panel to save your changes to the non-volatile memory when you are done configuring.
Cancel	Click Cancel to reset the fields to their last saved values.

CHAPTER 64

Static Route

64.1 Static Routing Overview

This chapter shows you how to configure static routes.

The Switch uses IP for communication with management computers, for example using HTTP, Telnet, SSH, or SNMP. Use IP static routes to have the Switch respond to remote management stations that are not reachable through the default gateway. The Switch can also use static routes to send data to a server or device that is not reachable through the default gateway, for example when sending SNMP traps or using ping to test IP connectivity.

The Switch usually uses the default gateway to route outbound traffic from computers on the LAN to the Internet. To have the Switch send data to devices not reachable through the default gateway, use static routes.

For example, the next figure shows a computer (**A**) connected to the Switch. The Switch routes most traffic from **A** to the Internet through the Switch's default gateway (**R1**). You create one static route to connect to services offered by your ISP behind router **R2**. You create another static route to communicate with a separate network behind a router **R3** connected to the Switch.

Figure 386 Example of Static Routing Topology

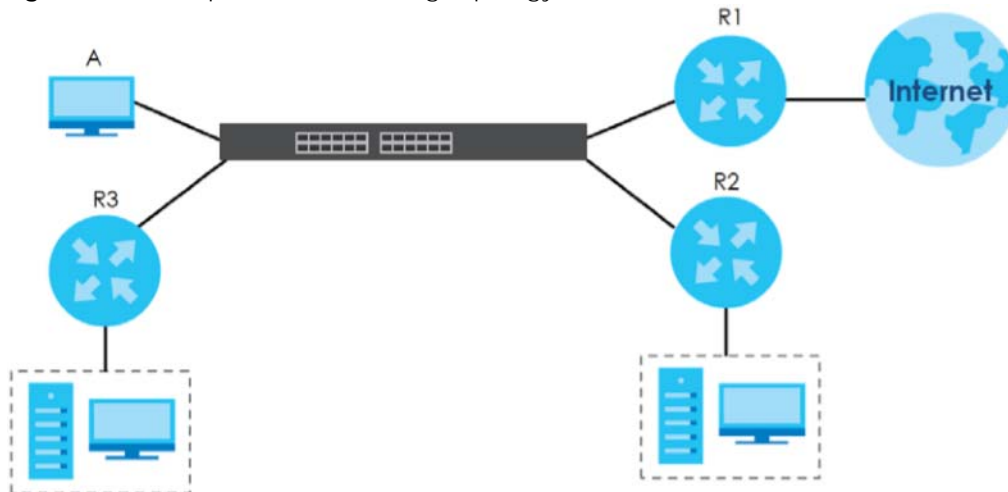

64.1.1 What You Can Do

Use the **IPv4 Static Route** screen ([Section 64.2 on page 481](#)) to configure and enable an IPv4 static route.

Use the **IPv6 Static Route** screen ([Section 64.3 on page 482](#)) to configure and enable an IPv6 static route.

64.2 IPv4 Static Route

Click **NETWORKING > Static Routing > IPv4 Static Route** to display the screen as shown.

Figure 387 NETWORKING > Static Routing > IPv4 Static Route

<input type="checkbox"/>	Index	Active	Name	Destination Address	Subnet Mask	Gateway Address	Metric
--------------------------	-------	--------	------	---------------------	-------------	-----------------	--------

The following table describes the related labels you use to create a static route.

Table 247 NETWORKING > Static Routing > IPv4 Static Route

LABEL	DESCRIPTION
Index	This field displays the index number of the route.
Active	This field displays whether the static route is activated or not.
Name	This field displays the descriptive name for this route. This is for identification purposes only.
Destination Address	This field displays the IP network address of the final destination.
Subnet Mask	This field displays the subnet mask for this destination.
Gateway Address	This field displays the IP address of the gateway. The gateway is an immediate neighbor of your Switch that will forward the packet to the destination.
Metric	This field displays the cost of transmission for routing purposes.
	Select an entry's check box to select a specific entry. Otherwise, select the check box in the table heading row to select all entries.
Add/Edit	Click Add/Edit to add a new entry or edit a selected one.
Delete	Click Delete to remove the selected entries.

64.2.1 Add/Edit IPv4 Static Route

Click **Add/Edit**, or select an entry and click **Add/Edit** in the **NETWORKING > Static Routing > IPv4 Static Route** screen to display this screen.

Figure 388 NETWORKING > Static Routing > IPv4 Static Route > Add/Edit

The following table describes the related labels you use to create a static route.

Table 248 NETWORKING > Static Routing > IPv4 Static Route > Add/Edit

LABEL	DESCRIPTION
Active	This field allows you to activate or deactivate this static route.
Name	Enter a descriptive name (up to 10 printable ASCII characters except [?], [] , ['], ["] or [,]) for identification purposes.
Destination IP Address	This parameter specifies the IP network address of the final destination.
IP Subnet Mask	Enter the subnet mask for this destination. Routing is always based on network number. If you need to specify a route to a single host, use a subnet mask of 255.255.255.255 in the subnet mask field to force the network number to be identical to the host ID.
Gateway IP Address	Enter the IP address of the gateway. The gateway is an immediate neighbor of your Switch that will forward the packet to the destination. The gateway must be a router on the same segment as your Switch.
Metric	The metric represents the "cost" of transmission for routing purposes. IP routing uses hop count as the measurement of cost, with a minimum of 1 for directly connected networks. Enter a number that approximates the cost for this link. The number need not be precise, but it must be between 1 and 15. In practice, 2 or 3 is usually a good number.
Apply	Click Apply to save your changes to the Switch's run-time memory. The Switch loses these changes if it is turned off or loses power, so use the Save link on the top navigation panel to save your changes to the non-volatile memory when you are done configuring.
Clear	Click Clear to clear the fields to the factory defaults.
Cancel	Click Cancel to not save the configuration you make and return to the last screen.

64.3 IPv6 Static Route

Click **NETWORKING > Static Routing > IPv6 Static Route** to display the screen as shown.

Figure 389 NETWORKING > Static Routing > IPv6 Static Route

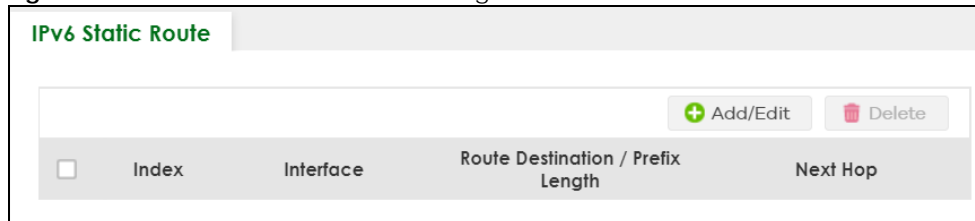

The following table describes the related labels you use to create a static route.

Table 249 NETWORKING > Static Routing > IPv6 Static Route

LABEL	DESCRIPTION
Index	This field displays the index number of the route.
Interface	This field displays the descriptive name of the interface that is used to forward the packets to the destination.
Route Destination / Prefix Length	This field displays the IPv6 subnet prefix and prefix length of the final destination.
Next Hop	This field displays the IPv6 address of the gateway that helps forward the packet to the destination.

Table 249 NETWORKING > Static Routing > IPv6 Static Route (continued)

LABEL	DESCRIPTION
	Select an entry's check box to select a specific entry. Otherwise, select the check box in the table heading row to select all entries.
Add/Edit	Click Add/Edit to add a new entry or edit a selected one.
Delete	Click Delete to remove the selected entries.

64.3.1 Add/Edit IPv6 Static Route

Click **Add/Edit**, or select an entry and click **Add/Edit** in the **NETWORKING > Static Routing > IPv6 Static Route** to display this screen.

Figure 390 NETWORKING > Static Routing > IPv6 Static Route > Add/Edit

The screenshot shows a configuration form with the following fields and controls:

- Interface Type: A dropdown menu currently showing 'VLAN'.
- Interface ID: A text input field.
- Route Destination: A text input field.
- Prefix Length: A text input field.
- Next Hop: A text input field.
- Buttons: 'Apply' (green), 'Clear' (grey), and 'Cancel' (grey).

The following table describes the related labels you use to create a static route.

Table 250 NETWORKING > Static Routing > IPv6 Static Route > Add/Edit

LABEL	DESCRIPTION
Interface Type	Select the type of the IPv6 interface through which the IPv6 packets are forwarded. The Switch supports only the VLAN interface type at the time of writing.
Interface ID	Enter the ID number of the IPv6 interface through which the IPv6 packets are forwarded.
Route Destination	Enter the IPv6 address of the final destination.
Prefix Length	Enter the prefix length number of up to 64 for this destination.
Next Hop	Enter the IPv6 address of the next-hop router.
Apply	Click Apply to save your changes to the Switch's run-time memory. The Switch loses these changes if it is turned off or loses power, so use the Save link on the top navigation panel to save your changes to the non-volatile memory when you are done configuring.
Clear	Click Clear to clear the fields to the factory defaults.
Cancel	Click Cancel to not save the configuration you make and return to the last screen.

CHAPTER 65

SECURITY

The following chapters introduces the configurations of the links under the **SECURITY** navigation panel.

Quick links to chapters:

- [AAA](#)
- [Access Control](#)
- [Classifier](#)
- [Policy Rule](#)
- [Anti-Arpscan](#)
- [BPDU Guard](#)
- [Storm Control](#)
- [Error-Disable](#)
- [IP Source Guard](#)
- [DHCP Snooping](#)
- [ARP Inspection](#)
- [IPv6 Source Guard](#)
- [Port Authentication](#)
- [Port Security](#)

CHAPTER 66

AAA

66.1 Authentication, Authorization and Accounting (AAA)

This chapter describes how to configure authentication, authorization and accounting settings on the Switch.

The external servers that perform authentication, authorization and accounting functions are known as AAA servers. The Switch supports RADIUS (Remote Authentication Dial-In User Service) and TACACS+ (Terminal Access Controller Access-Control System Plus) as the external authentication, authorization, and accounting server.

Figure 391 AAA Server

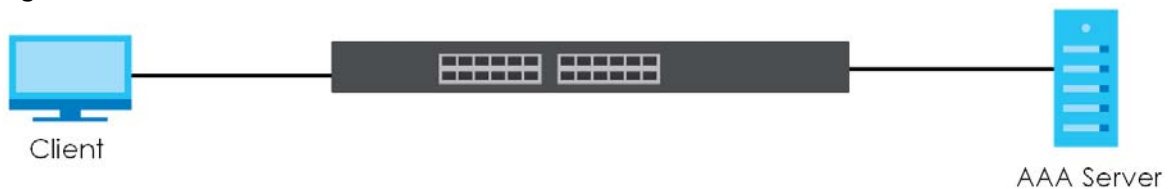

66.1.1 What You Can Do

- use the **RADIUS Server Setup** screen ([Section 66.2 on page 486](#)) to configure your RADIUS server settings.
- Use the **TACACS+ Server Setup** screen ([Section 66.3 on page 488](#)) to configure your TACACS+ authentication settings.
- Use the **AAA Setup** screen ([Section 66.4 on page 490](#)) to configure authentication, authorization and accounting settings, such as the methods used to authenticate users accessing the Switch and which database the Switch should use first.

66.1.2 What You Need to Know

Authentication is the process of determining who a user is and validating access to the Switch. The Switch can authenticate users who try to log in based on user accounts configured on the Switch itself. The Switch can also use an external authentication server to authenticate a large number of users.

Authorization is the process of determining what a user is allowed to do. Different user accounts may have higher or lower privilege levels associated with them. For example, user A may have the right to create new login accounts on the Switch but user B cannot. The Switch can authorize users based on user accounts configured on the Switch itself or it can use an external server to authorize a large number of users.

Accounting is the process of recording what a user is doing. The Switch can use an external server to

track when users log in, log out, execute commands and so on. Accounting can also record system related actions such as boot up and shut down times of the Switch.

Local User Accounts

By storing user profiles locally on the Switch, your Switch is able to authenticate and authorize users without interacting with a network AAA server. However, there is a limit on the number of users you may authenticate in this way.

RADIUS

RADIUS is a security protocol used to authenticate users by means of an external server instead of (or in addition to) an internal device user database that is limited to the memory capacity of the device. In essence, RADIUS authentication allows you to validate an unlimited number of users from a central location.

RADIUS and TACACS+

RADIUS and TACACS+ are security protocols used to authenticate users by means of an external server instead of (or in addition to) an internal device user database that is limited to the memory capacity of the device. In essence, RADIUS and TACACS+ authentication both allow you to validate an unlimited number of users from a central location.

The following table describes some key differences between RADIUS and TACACS+.

Table 251 RADIUS vs. TACACS+

	RADIUS	TACACS+
Transport Protocol	UDP (User Datagram Protocol)	TCP (Transmission Control Protocol)
Encryption	Encrypts the password sent for authentication.	All communication between the client (the Switch) and the TACACS server is encrypted.

66.2 RADIUS Server Setup

Use this screen to configure your RADIUS server settings. Click **SECURITY > AAA > RADIUS Server Setup** to view the screen as shown.

Figure 392 SECURITY > AAA > RADIUS Server Setup

RADIUS Server Setup

Authentication Server

Mode:
 Timeout: seconds

Delete	Index	IP Address	UDP Port	Shared Secret	Encrypted Shared Secret
<input type="checkbox"/>	1	<input type="text" value="0.0.0.0"/>	<input type="text" value="1812"/>	<input type="text"/>	<input type="text"/>
<input type="checkbox"/>	2	<input type="text" value="0.0.0.0"/>	<input type="text" value="1812"/>	<input type="text"/>	<input type="text"/>

Accounting Server

Timeout: seconds

Delete	Index	IP Address	UDP Port	Shared Secret	Encrypted Shared Secret
<input type="checkbox"/>	1	<input type="text" value="0.0.0.0"/>	<input type="text" value="1813"/>	<input type="text"/>	<input type="text"/>
<input type="checkbox"/>	2	<input type="text" value="0.0.0.0"/>	<input type="text" value="1813"/>	<input type="text"/>	<input type="text"/>

Attribute

NAS-IP-Address:

The following table describes the labels in this screen.

Table 252 SECURITY > AAA > RADIUS Server Setup

LABEL	DESCRIPTION
Authentication Server	
Use this section to configure your RADIUS authentication settings.	
Mode	This field is only valid if you configure multiple RADIUS servers. Select index-priority and the Switch tries to authenticate with the first configured RADIUS server, if the RADIUS server does not respond then the Switch tries to authenticate with the second RADIUS server. Select round-robin to alternate between the RADIUS servers that it sends authentication requests to.
Timeout	Specify the amount of time in seconds that the Switch waits for an authentication request response from the RADIUS server. If you are using two RADIUS servers then the timeout value is divided between the two RADIUS servers. For example, if you set the timeout value to 30 seconds, then the Switch waits for a response from the first RADIUS server for 15 seconds and then tries the second RADIUS server.
Delete	Check this box if you want to remove an existing RADIUS server entry from the Switch. This entry is deleted when you click Apply .
Index	This is a read-only number representing a RADIUS server entry.
IP Address	Enter the IPv4 address or IPv6 address of an external RADIUS server.
UDP Port	The default port of a RADIUS server for authentication is 1812 . You need not change this value unless your network administrator instructs you to do so.
Shared Secret	Specify a password (up to 32 alphanumeric characters except [?], [], ['], ["], [space], or [,]) as the key to be shared between the external RADIUS server and the Switch. This key is not sent over the network. This key must be the same on the external RADIUS server and the Switch.

Table 252 SECURITY > AAA > RADIUS Server Setup (continued)

LABEL	DESCRIPTION
Encrypted Shared Secret	This displays the encrypted shared secret in '**' format if you enabled Server Key Encryption in SECURITY > AAA > AAA Setup . Note: If you forget the key you set, simply reset the key in the Shared Secret field. If a key is encrypted, it will remain in the encrypted format even if you later disable Server Key Encryption in SECURITY > AAA > AAA Setup . Note: The shared secret displayed in this field does not present the actual length of the shared secret.
Accounting Server Use this section to configure your RADIUS accounting server settings.	
Timeout	Specify the amount of time in seconds that the Switch waits for an accounting request response from the RADIUS accounting server.
Delete	Check this box if you want to remove an existing RADIUS accounting server entry from the Switch. This entry is deleted when you click Apply .
Index	This is a read-only number representing a RADIUS accounting server entry.
IP Address	Enter the IPv4 address or IPv6 address of an external RADIUS accounting server.
UDP Port	The default port of a RADIUS accounting server for accounting is 1813 . You need not change this value unless your network administrator instructs you to do so.
Shared Secret	Specify a password (up to 32 alphanumeric characters except [?], [], ['], ["], [space], or [,]) as the key to be shared between the external RADIUS accounting server and the Switch. This key is not sent over the network. This key must be the same on the external RADIUS accounting server and the Switch.
Encrypted Shared Secret	This displays the encrypted shared secret in '**' format if you enabled Server Key Encryption in SECURITY > AAA > AAA Setup . Note: If you forget the key you set, simply reset the key in the Shared Secret field. If a key is encrypted, it will remain in the encrypted format even if you later disable Server Key Encryption in SECURITY > AAA > AAA Setup . Note: The shared secret displayed in this field does not present the actual length of the shared secret.
Attribute Use this section to define the RADIUS server attribute for its account.	
NAS-IP-Address	Enter the IP address of the NAS (Network Access Server).
Apply	Click Apply to save your changes to the Switch's run-time memory. The Switch loses these changes if it is turned off or loses power, so use the Save link on the top navigation panel to save your changes to the non-volatile memory when you are done configuring.
Cancel	Click Cancel to begin configuring this screen afresh.

66.3 TACACS+ Server Setup

Use this screen to configure your TACACS+ server settings. Click **SECURITY > AAA > TACACS+ Server Setup** to view the screen as shown.

Figure 393 SECURITY > AAA > TACACS+ Server Setup

TACACS+ Server Setup

Authentication Server

Mode index-priority ▼

Timeout 30 seconds

Delete	Index	IP Address	TCP Port	Shared Secret	Encrypted Shared Secret
<input type="checkbox"/>	1	<input style="width: 100%;" type="text" value="0.0.0.0"/>	<input style="width: 50%;" type="text" value="49"/>	<input style="width: 100%;" type="text"/>	<input style="width: 100%;" type="text"/>
<input type="checkbox"/>	2	<input style="width: 100%;" type="text" value="0.0.0.0"/>	<input style="width: 50%;" type="text" value="49"/>	<input style="width: 100%;" type="text"/>	<input style="width: 100%;" type="text"/>

Accounting Server

Timeout 30 seconds

Delete	Index	IP Address	TCP Port	Shared Secret	Encrypted Shared Secret
<input type="checkbox"/>	1	<input style="width: 100%;" type="text" value="0.0.0.0"/>	<input style="width: 50%;" type="text" value="49"/>	<input style="width: 100%;" type="text"/>	<input style="width: 100%;" type="text"/>
<input type="checkbox"/>	2	<input style="width: 100%;" type="text" value="0.0.0.0"/>	<input style="width: 50%;" type="text" value="49"/>	<input style="width: 100%;" type="text"/>	<input style="width: 100%;" type="text"/>

Apply
Cancel

The following table describes the labels in this screen.

Table 253 SECURITY > AAA > TACACS+ Server Setup

LABEL	DESCRIPTION
Authentication Server	Use this section to configure your TACACS+ authentication settings.
Mode	This field is only valid if you configure multiple TACACS+ servers. Select index-priority and the Switch tries to authenticate with the first configured TACACS+ server, if the TACACS+ server does not respond then the Switch tries to authenticate with the second TACACS+ server. Select round-robin to alternate between the TACACS+ servers that it sends authentication requests to.
Timeout	Specify the amount of time in seconds that the Switch waits for an authentication request response from the TACACS+ server. If you are using index-priority for your authentication and you are using two TACACS+ servers then the timeout value is divided between the two TACACS+ servers. For example, if you set the timeout value to 30 seconds, then the Switch waits for a response from the first TACACS+ server for 15 seconds and then tries the second TACACS+ server.
Delete	Check this box if you want to remove an existing TACACS+ server entry from the Switch. This entry is deleted when you click Apply .
Index	This is a read-only number representing a TACACS+ server entry.
IP Address	Enter the IP address of an external TACACS+ server in dotted decimal notation.
TCP Port	The default port of a TACACS+ server for authentication is 49 . You need not change this value unless your network administrator instructs you to do so.

Table 253 SECURITY > AAA > TACACS+ Server Setup (continued)

LABEL	DESCRIPTION
Shared Secret	Specify a password (up to 32 alphanumeric characters except [?], [], ['], ["], [space], or [,]) as the key to be shared between the external TACACS+ server and the Switch. This key is not sent over the network. This key must be the same on the external TACACS+ server and the Switch.
Encrypted Shared Secret	<p>This displays the encrypted shared secret in "*" format if you enabled Server Key Encryption in SECURITY > AAA > AAA Setup.</p> <p>Note: If you forget the key you set, simply reset the key in the Shared Secret field. If a key is encrypted, it will remain in the encrypted format even if you later disable Server Key Encryption in SECURITY > AAA > AAA Setup.</p> <p>Note: The shared secret displayed in this field does not present the actual length of the shared secret.</p>
<p>Accounting Server</p> <p>Use this section to configure your TACACS+ accounting settings.</p>	
Timeout	Specify the amount of time in seconds that the Switch waits for an accounting request response from the TACACS+ server.
Delete	Check this box if you want to remove an existing TACACS+ accounting server entry from the Switch. This entry is deleted when you click Apply .
Index	This is a read-only number representing a TACACS+ accounting server entry.
IP Address	Enter the IP address of an external TACACS+ accounting server in dotted decimal notation.
TCP Port	The default port of a TACACS+ accounting server is 49 . You need not change this value unless your network administrator instructs you to do so.
Shared Secret	Specify a password (up to 32 alphanumeric characters except [?], [], ['], ["], [space], or [,]) as the key to be shared between the external TACACS+ accounting server and the Switch. This key is not sent over the network. This key must be the same on the external TACACS+ accounting server and the Switch.
Encrypted Shared Secret	<p>This displays the encrypted shared secret in "*" format if you enabled Server Key Encryption in SECURITY > AAA > AAA Setup.</p> <p>Note: If you forget the key you set, simply reset the key in the Shared Secret field. If a key is encrypted, it will remain in the encrypted format even if you later disable Server Key Encryption in SECURITY > AAA > AAA Setup.</p> <p>Note: The shared secret displayed in this field does not present the actual length of the shared secret.</p>
Apply	Click Apply to save your changes to the Switch's run-time memory. The Switch loses these changes if it is turned off or loses power, so use the Save link on the top navigation panel to save your changes to the non-volatile memory when you are done configuring.
Cancel	Click Cancel to begin configuring this screen afresh.

66.4 AAA Setup

Use this screen to configure authentication, authorization and accounting settings on the Switch. Click **SECURITY > AAA > AAA Setup** to view the screen as shown.

Figure 394 SECURITY > AAA > AAA Setup

AAA Setup

Server Key Encryption

Active OFF

Authentication

Type	Method 1	Method 2	Method 3
Privilege Enable	local	-	-
Login	local	-	-

Authorization

Type	Active	Console	Method
Exec	<input type="radio"/> OFF	<input type="checkbox"/>	radius
Dot1x	<input type="radio"/> OFF	-	radius

Accounting

Update Period minutes

Type	Active	Broadcast	Mode	Method	Privilege
System	<input type="radio"/> OFF	<input type="checkbox"/>	-	radius	-
Exec	<input type="radio"/> OFF	<input type="checkbox"/>	start-stop	radius	-
Dot1x	<input type="radio"/> OFF	<input type="checkbox"/>	start-stop	radius	-
Commands	<input type="radio"/> OFF	<input type="checkbox"/>	stop-only	tacacs+	0

The following table describes the labels in this screen.

Table 254 SECURITY > AAA > AAA Setup

LABEL	DESCRIPTION
Server Key Encryption	Use this section to configure server key encryption settings.
Active	<p>Enable the switch button to enable server key (shared secret) encryption for RADIUS server and TACACS+ server for security enhancement.</p> <p>The shared secret will be stored on the Switch in an encrypted format and displayed as '*' in the SECURITY > AAA > RADIUS Server Setup and SECURITY > AAA > TACACS+ Server Setup screens.</p>

Table 254 SECURITY > AAA > AAA Setup (continued)

LABEL	DESCRIPTION
<p>Authentication</p> <p>Use this section to specify the methods used to authenticate users accessing the Switch.</p>	
<p>Privilege Enable</p>	<p>These fields specify which database the Switch should use (first, second and third) to authenticate access privilege level for administrator accounts (users for Switch management).</p> <p>Configure the access privilege of accounts through commands (see the Ethernet Switch CLI Reference Guide) for local authentication. The TACACS+ and RADIUS are external servers. Before you specify the priority, make sure you have set up the corresponding database correctly first.</p> <p>You can specify up to three methods for the Switch to authenticate the access privilege level of administrators. The Switch checks the methods in the order you configure them (first Method 1, then Method 2 and finally Method 3). You must configure the settings in the Method 1 field. If you want the Switch to check other sources for access privilege level specify them in Method 2 and Method 3 fields.</p> <p>Select local to have the Switch check the access privilege configured for local authentication.</p> <p>Select radius or tacacs+ to have the Switch check the access privilege through the external servers.</p>
<p>Login</p>	<p>These fields specify which database the Switch should use (first, second and third) to authenticate administrator accounts (users for Switch management).</p> <p>Configure the local user accounts in the SYSTEM > Logins screen. The TACACS+ and RADIUS are external servers. Before you specify the priority, make sure you have set up the corresponding database correctly first.</p> <p>You can specify up to three methods for the Switch to authenticate administrator accounts. The Switch checks the methods in the order you configure them (first Method 1, then Method 2 and finally Method 3). You must configure the settings in the Method 1 field. If you want the Switch to check other sources for administrator accounts, specify them in Method 2 and Method 3 fields.</p> <p>Select local to have the Switch check the administrator accounts configured in the SYSTEM > Logins screen.</p> <p>Select radius to have the Switch check the administrator accounts configured through the RADIUS Server.</p> <p>Select tacacs+ to have the Switch check the administrator accounts configured through the TACACS+ Server.</p>
<p>Authorization</p> <p>Use this section to configure authorization settings on the Switch.</p>	
<p>Type</p>	<p>Set whether the Switch provides the following services to a user.</p> <ul style="list-style-type: none"> • Exec: Allow an administrator which logs into the Switch through Telnet or SSH to have a different access privilege level assigned through the external server. • Dot1x: Allow an IEEE 802.1x client to have different bandwidth limit or VLAN ID assigned through the external server.
<p>Active</p>	<p>Enable the switch button to activate authorization for a specified event type.</p>
<p>Console</p>	<p>Select this to allow an administrator which logs in the Switch through the console port to have different access privilege level assigned through the external server.</p>
<p>Method</p>	<p>Select whether you want to use radius or tacacs+ for authorization of specific types of events.</p> <p>RADIUS is the only method for IEEE 802.1x authorization.</p>
<p>Accounting</p> <p>Use this section to configure accounting settings on the Switch.</p>	

Table 254 SECURITY > AAA > AAA Setup (continued)

LABEL	DESCRIPTION
Update Period	This is the amount of time in minutes before the Switch sends an update to the accounting server. This is only valid if you select the start-stop option for the Exec or Dot1x entries.
Type	The Switch supports the following types of events to be sent to the accounting servers: <ul style="list-style-type: none"> • System – Configure the Switch to send information when the following system events occur: system boots up, system shuts down, system accounting is enabled, system accounting is disabled. • Exec – Configure the Switch to send information when an administrator logs in and logs out through the console port, telnet or SSH. • Dot1x – Configure the Switch to send information when an IEEE 802.1x client begins a session (authenticates through the Switch), ends a session as well as interim updates of a session. • Commands – Configure the Switch to send information when commands of specified privilege level and higher are executed on the Switch.
Active	Enable the switch button to activate accounting for a specified event type.
Broadcast	Select this to have the Switch send accounting information to all configured accounting servers at the same time. If you do not select this and you have two accounting servers set up, then the Switch sends information to the first accounting server and if it does not get a response from the accounting server then it tries the second accounting server.
Mode	The Switch supports two modes of recording login events. Select: <ul style="list-style-type: none"> • start-stop – to have the Switch send information to the accounting server when a user begins a session, during a user's session (if it lasts past the Update Period), and when a user ends a session. • stop-only – to have the Switch send information to the accounting server only when a user ends a session.
Method	Select whether you want to use radius or tacacs+ for accounting of specific types of events. tacacs+ is the only method for recording Commands type of event.
Privilege	This field is only configurable for Commands type of event. Select the threshold command privilege level for which the Switch should send accounting information. The Switch will send accounting information when commands at the level you specify and higher are executed on the Switch.
Apply	Click Apply to save your changes to the Switch's run-time memory. The Switch loses these changes if it is turned off or loses power, so use the Save link on the top navigation panel to save your changes to the non-volatile memory when you are done configuring.
Cancel	Click Cancel to begin configuring this screen afresh.

66.5 Technical Reference

This section provides technical background information on the topics discussed in this chapter.

66.5.1 Vendor Specific Attribute

RFC 2865 standard specifies a method for sending vendor-specific information between a RADIUS server and a network access device (for example, the Switch). A company can create Vendor Specific Attributes (VSAs) to expand the functionality of a RADIUS server.

The Switch supports VSAs that allow you to perform the following actions based on user authentication:

- Limit bandwidth on incoming or outgoing traffic for the port the user connects to.
- Assign account privilege levels (See the CLI Reference Guide for more information on account privilege levels) for the authenticated user.

The VSAs are composed of the following:

- **Vendor-ID:** An identification number assigned to the company by the IANA (Internet Assigned Numbers Authority). Zyxel's vendor ID is 890.
- **Vendor-Type:** A vendor specified attribute, identifying the setting you want to modify.
- **Vendor-data:** A value you want to assign to the setting.

Note: Refer to the documentation that comes with your RADIUS server on how to configure VSAs for users authenticating through the RADIUS server.

The following table describes the VSAs supported on the Switch. Note that these attributes only work when you enable authorization (see [Section 66.4 on page 490](#)).

Table 255 Supported VSAs

FUNCTION	ATTRIBUTE
Ingress Bandwidth Assignment	Vendor-Id = 890 Vendor-Type = 1 Vendor-data = ingress rate (Kbps in decimal format)
Egress Bandwidth Assignment	Vendor-Id = 890 Vendor-Type = 2 Vendor-data = egress rate (Kbps in decimal format)
Privilege Assignment	Vendor-ID = 890 Vendor-Type = 3 Vendor-Data = " shell:priv-lvl=N " or Vendor-ID = 9 (CISCO) Vendor-Type = 1 (CISCO-AVPAIR) Vendor-Data = " shell:priv-lvl=N " where N is a privilege level (from 0 to 14). Note: If you set the privilege level of a login account differently on the RADIUS servers and the Switch, the user is assigned a privilege level from the database (RADIUS or local) the Switch uses first for user authentication.

66.5.1.1 Tunnel Protocol Attribute

You can configure tunnel protocol attributes on the RADIUS server (refer to your RADIUS server documentation) to assign a port on the Switch to a VLAN based on IEEE 802.1x authentication. The port VLAN settings are fixed and untagged. This will also set the port's VID. The following table describes the values you need to configure. Note that these attributes only work when you enable authorization (see [Section 66.4 on page 490](#)).

Table 256 Supported Tunnel Protocol Attribute

FUNCTION	ATTRIBUTE
VLAN Assignment	Tunnel-Type = VLAN(13) Tunnel-Medium-Type = 802(6) Tunnel-Private-Group-ID = VLAN ID Note: You must also create a VLAN with the specified VID on the Switch. Note: The bolded values in this table are fixed values as defined in RFC 3580.

66.5.2 Supported RADIUS Attributes

Remote Authentication Dial-In User Service (RADIUS) attributes are data used to define specific authentication elements in a user profile, which is stored on the RADIUS server. This section lists the RADIUS attributes supported by the Switch.

Refer to RFC 2865 for more information about RADIUS attributes used for authentication.

Refer to RFC 2866 and RFC 2869 for RADIUS attributes used for accounting.

This section lists the attributes used by authentication functions on the Switch. In cases where the attribute has a specific format associated with it, the format is specified.

66.5.3 Attributes Used for Authentication

The following sections list the attributes sent from the Switch to the RADIUS server when performing authentication.

66.5.3.1 Attributes Used for Authenticating Privilege Access

User-Name

- The format of the User-Name attribute is **\$enab#\$**, where # is the privilege level (1 – 14).

User-Password

NAS-Identifier

NAS-IP-Address

66.5.3.2 Attributes Used to Login Users

User-Name

User-Password

NAS-Identifier

NAS-IP-Address

66.5.3.3 Attributes Used by the IEEE 802.1x Authentication

User-Name
 NAS-Identifier
 NAS-IP-Address
 NAS-Port
 NAS-Port-Type
 – This value is set to **Ethernet(15)** on the Switch.
 Calling-Station-Id
 Frame-MTU
 EAP-Message
 State
 Message-Authenticator

66.5.4 Attributes Used for Accounting

The following sections list the attributes sent from the Switch to the RADIUS server when performing authentication.

66.5.4.1 Attributes Used for Accounting System Events

NAS-IP-Address
 NAS-Identifier
 Acct-Status-Type
 Acct-Session-ID
 – The format of Acct-Session-Id is **date+time+8-digit sequential number**, for example, 2007041917210300000001. (date: 2007/04/19, time: 17:21:03, serial number: 00000001)
 Acct-Delay-Time

66.5.4.2 Attributes Used for Accounting Exec Events

The attributes are listed in the following table along with the time that they are sent (the difference between Console and Telnet/SSH Exec events is that the Telnet/SSH events utilize the Calling-Station-Id attribute):

Table 257 RADIUS Attributes – Exec Events through Console

ATTRIBUTE	START	INTERIM-UPDATE	STOP
User-Name	✓	✓	✓
NAS-Identifier	✓	✓	✓
NAS-IP-Address	✓	✓	✓
Service-Type	✓	✓	✓
Acct-Status-Type	✓	✓	✓
Acct-Delay-Time	✓	✓	✓
Acct-Session-Id	✓	✓	✓
Acct-Authentic	✓	✓	✓

Table 257 RADIUS Attributes – Exec Events through Console (continued)

ATTRIBUTE	START	INTERIM-UPDATE	STOP
Acct-Session-Time		✓	✓
Acct-Terminate-Cause			✓

Table 258 RADIUS Attributes – Exec Events through Telnet/SSH

ATTRIBUTE	START	INTERIM-UPDATE	STOP
User-Name	✓	✓	✓
NAS-Identifier	✓	✓	✓
NAS-IP-Address	✓	✓	✓
Service-Type	✓	✓	✓
Calling-Station-Id	✓	✓	✓
Acct-Status-Type	✓	✓	✓
Acct-Delay-Time	✓	✓	✓
Acct-Session-Id	✓	✓	✓
Acct-Authentic	✓	✓	✓
Acct-Session-Time		✓	✓
Acct-Terminate-Cause			✓

66.5.4.3 Attributes Used for Accounting IEEE 802.1x Events

The attributes are listed in the following table along with the time of the session they are sent:

Table 259 RADIUS Attributes – Exec Events through Console

ATTRIBUTE	START	INTERIM-UPDATE	STOP
User-Name	✓	✓	✓
NAS-IP-Address	✓	✓	✓
NAS-Port	✓	✓	✓
Class	✓	✓	✓
Called-Station-Id	✓	✓	✓
Calling-Station-Id	✓	✓	✓
NAS-Identifier	✓	✓	✓
NAS-Port-Type	✓	✓	✓
Acct-Status-Type	✓	✓	✓
Acct-Delay-Time	✓	✓	✓
Acct-Session-Id	✓	✓	✓
Acct-Authentic	✓	✓	✓
Acct-Input-Octets		✓	✓
Acct-Output-Octets		✓	✓
Acct-Session-Time		✓	✓
Acct-Input-Packets		✓	✓

Table 259 RADIUS Attributes – Exec Events through Console (continued)

ATTRIBUTE	START	INTERIM-UPDATE	STOP
Acct-Output-Packets		✓	✓
Acct-Terminate-Cause			✓
Acct-Input-Gigawords		✓	✓
Acct-Output-Gigawords		✓	✓

CHAPTER 67

Access Control

67.1 Access Control Overview

This chapter describes how to control access to the Switch.

A console port and FTP are allowed one session each, Telnet and SSH share nine sessions, up to five web sessions (five different user names and passwords) and/or limitless SNMP access control sessions are allowed.

Table 260 Access Control Overview

Console Port	SSH	Telnet	FTP	Web	SNMP
One session	Share up to 9 sessions		One session	Up to 5 accounts	No limit

A console port access control session and Telnet access control session cannot coexist when multi-login is disabled. See the CLI Reference Guide for more information on disabling multi-login.

67.1.1 What You Can Do

- Use the **Service Access Control** screen ([Section 67.2 on page 499](#)) to decide what services you may use to access the Switch.
- Use the **Remote Management** screen ([Section 67.3 on page 500](#)) to specify a group of one or more “trusted computers” from which an administrator may use a service to manage the Switch.
- Use the **Account Security** screen ([Section 67.4 on page 501](#)) to encrypt all passwords configured in the Switch. You can also display the authentication, authorization, external authentication server information (RADIUS or TACACS+), system and SNMP user account information in the configuration file saved.

67.2 Service Access Control

Service Access Control allows you to decide what services you may use to access the Switch. You may also change the default service port and configure “trusted computers” for each service in the **SECURITY > Access Control > Remote Management** screen (see [Section 67.3 on page 500](#) for more information). Click **SECURITY > Access Control > Service Access Control** to display the following screen.

Figure 395 SECURITY > Access Control > Service Access Control

Services	Active	Service Port	Timeout	Login Timeout
Console			5 Minutes	
Telnet	<input checked="" type="checkbox"/>	23	5 Minutes	150 Seconds
SSH	<input checked="" type="checkbox"/>	22		
FTP	<input checked="" type="checkbox"/>	21	5 Minutes	
HTTP	<input checked="" type="checkbox"/>	80	5 Minutes	
HTTPS	<input checked="" type="checkbox"/>	443		
ICMP	<input checked="" type="checkbox"/>			
SNMP	<input type="checkbox"/>			

The following table describes the fields in this screen.

Table 261 SECURITY > Access Control > Service Access Control

LABEL	DESCRIPTION
Services	Services you may use to access the Switch are listed here.
Active	Enable the switch button for the corresponding services that you want to allow to access the Switch.
Service Port	For Telnet, SSH, FTP, HTTP or HTTPS services, you may change the default service port by typing the new port number in the Service Port field. If you change the default port number then you will have to let people (who wish to use the service) know the new port number for that service.
Timeout	Enter how many minutes (from 1 to 255) a management session can be left idle before the session times out. After it times out you have to log in with your password again. Very long idle timeouts may have security risks.
Login Timeout	The Telnet or SSH server do not allow multiple user logins at the same time. Enter how many seconds (from 30 to 300 seconds) a login session times out. After it times out you have to start the login session again. Very long login session timeouts may have security risks. For example, if User A attempts to connect to the Switch (through SSH), but during the login stage, do not enter the user name and/or password, User B cannot connect to the Switch (through SSH) before the Login Timeout for User A expires (default 150 seconds).
Apply	Click Apply to save your changes to the Switch's run-time memory. The Switch loses these changes if it is turned off or loses power, so use the Save link on the top navigation panel to save your changes to the non-volatile memory when you are done configuring.
Cancel	Click Cancel to begin configuring this screen afresh.

67.3 Remote Management

Use this screen to specify a group of one or more "trusted computers" from which an administrator may use a service to manage the Switch.

Click **SECURITY > Access Control > Remote Management** to view the screen as shown next.

Figure 396 SECURITY > Access Control > Remote Management

Remote Management

Secured Client Setup

Entry	Active	Start Address	End Address	Telnet	FTP	HTTP	ICMP	SNMP	SSH	HTTPS
1	<input checked="" type="checkbox"/>	0.0.0.0	0.0.0.0	<input checked="" type="checkbox"/>	<input checked="" type="checkbox"/>	<input checked="" type="checkbox"/>	<input checked="" type="checkbox"/>	<input checked="" type="checkbox"/>	<input checked="" type="checkbox"/>	<input checked="" type="checkbox"/>
2	<input type="checkbox"/>	0.0.0.0	0.0.0.0	<input type="checkbox"/>	<input type="checkbox"/>	<input type="checkbox"/>	<input type="checkbox"/>	<input type="checkbox"/>	<input type="checkbox"/>	<input type="checkbox"/>
3	<input type="checkbox"/>	0.0.0.0	0.0.0.0	<input type="checkbox"/>	<input type="checkbox"/>	<input type="checkbox"/>	<input type="checkbox"/>	<input type="checkbox"/>	<input type="checkbox"/>	<input type="checkbox"/>
4	<input type="checkbox"/>	0.0.0.0	0.0.0.0	<input type="checkbox"/>	<input type="checkbox"/>	<input type="checkbox"/>	<input type="checkbox"/>	<input type="checkbox"/>	<input type="checkbox"/>	<input type="checkbox"/>
5	<input type="checkbox"/>	0.0.0.0	0.0.0.0	<input type="checkbox"/>	<input type="checkbox"/>	<input type="checkbox"/>	<input type="checkbox"/>	<input type="checkbox"/>	<input type="checkbox"/>	<input type="checkbox"/>
6	<input type="checkbox"/>	0.0.0.0	0.0.0.0	<input type="checkbox"/>	<input type="checkbox"/>	<input type="checkbox"/>	<input type="checkbox"/>	<input type="checkbox"/>	<input type="checkbox"/>	<input type="checkbox"/>
7	<input type="checkbox"/>	0.0.0.0	0.0.0.0	<input type="checkbox"/>	<input type="checkbox"/>	<input type="checkbox"/>	<input type="checkbox"/>	<input type="checkbox"/>	<input type="checkbox"/>	<input type="checkbox"/>

Apply **Cancel**

The following table describes the labels in this screen.

Table 262 SECURITY > Access Control > Remote Management

LABEL	DESCRIPTION
Entry	This is the client set index number. A "client set" is a group of one or more "trusted computers" from which an administrator may use a service to manage the Switch.
Active	Enable the switch button to activate this secured client set. Clear the check box if you wish to temporarily disable the set without deleting it.
Start Address	Configure the IP address range of trusted computers from which you can manage this Switch.
End Address	The Switch checks if the client IP address of a computer requesting a service or protocol matches the range set here. The Switch immediately disconnects the session if it does not match.
Telnet / FTP / HTTP / ICMP / SNMP / SSH / HTTPS	Select services that may be used for managing the Switch from the specified trusted computers.
Apply	Click Apply to save your changes to the Switch's run-time memory. The Switch loses these changes if it is turned off or loses power, so use the Save link on the top navigation panel to save your changes to the non-volatile memory when you are done configuring.
Cancel	Click Cancel to begin configuring this screen afresh.

67.4 Account Security

Use this screen to encrypt all passwords configured in the Switch. This setting will affect how the password is shown (as plain text or encrypted text) in the configuration file saved in **MAINTENANCE > Configuration > Save Configuration**.

Note: Make sure to enable **Password Encryption** to avoid displaying passwords as plain text in the configuration file.

Note: Be careful who can access configuration files with plain text passwords!

Password Encryption encrypts all passwords in the configuration file. However, if you want to show some passwords as plain text in the configuration file, select them as below:

- **Authentication** information configured for **Authentication** in the **SECURITY > AAA > AAA Setup** screen (**Method 1/2/3** setting in the **Privilege Enable** and **Login** fields).
- **Authorization** information configured for **Authorization** in the **SECURITY > AAA > AAA Setup** screen (**Active/Console/Method** setting in the **Exec** and **Dot1x** fields).
- **Server** information configured for **Authentication Server** in the **SECURITY > AAA > RADIUS Server Setup** screen, and for **Authentication Server** in the **SECURITY > AAA > TACACS+ Server Setup** screen (**Mode/Timeout** fields).
- **System** account information configured in the Switch (admin, user login name, and password).
- **SNMP** user account information configured in the **SYSTEM > SNMP > SNMP User** screen (password for SNMP user authentication in the **Authentication** field, and the password for the encryption method for SNMP communication in the **Privacy** field).

Note: The passwords will appear as encrypted text when **Password Encryption** is **Active**.

Click **SECURITY > Access Control > Account Security** to view the screen as shown next.

Figure 397 SECURITY > Access Control > Account Security

Account Security

Account Security

Password Encryption OFF

Apply Cancel

Display

AAA

Authentication Authorization Server

User

System SNMP

Apply Cancel

The following table describes the labels in this screen.

Table 263 SECURITY > Access Control > Account Security

LABEL	DESCRIPTION
Account Security	
Password Encryption	Select this check box to encrypt all passwords configured on the Switch. This displays the password as encrypted text, in a saved configuration file. Otherwise, the passwords configured on the Switch are displayed in plain text.
Apply	Click Apply to save your changes for Account Security to the Switch's run-time memory. The Switch loses these changes if it is turned off or loses power, so use the Save link on the top navigation panel to save your changes to the non-volatile memory when you are done configuring.
Cancel	Click Cancel to begin configuring Account Security afresh.
Display	
AAA	Select which specific information to display in plain text, in the saved configuration file. <ul style="list-style-type: none"> • Authentication • Authorization • Server
User	Select which user account information to display in plain text, in the saved configuration file. <ul style="list-style-type: none"> • System • SNMP
Apply	Click Apply to save your changes for Display to the Switch's run-time memory. The Switch loses these changes if it is turned off or loses power, so use the Save link on the top navigation panel to save your changes to the non-volatile memory when you are done configuring.
Cancel	Click Cancel to begin configuring Display afresh.

67.5 Technical Reference

This section provides technical background information on the topics discussed in this chapter.

67.5.1 SSH Overview

Unlike Telnet or FTP, which transmit data in clear text, SSH (Secure Shell) is a secure communication protocol that combines authentication and data encryption to provide secure encrypted communication between two hosts over an unsecured network.

Figure 398 SSH Communication Example



67.5.1.1 How SSH Works

The following table summarizes how a secure connection is established between two remote hosts.

Figure 399 How SSH Works

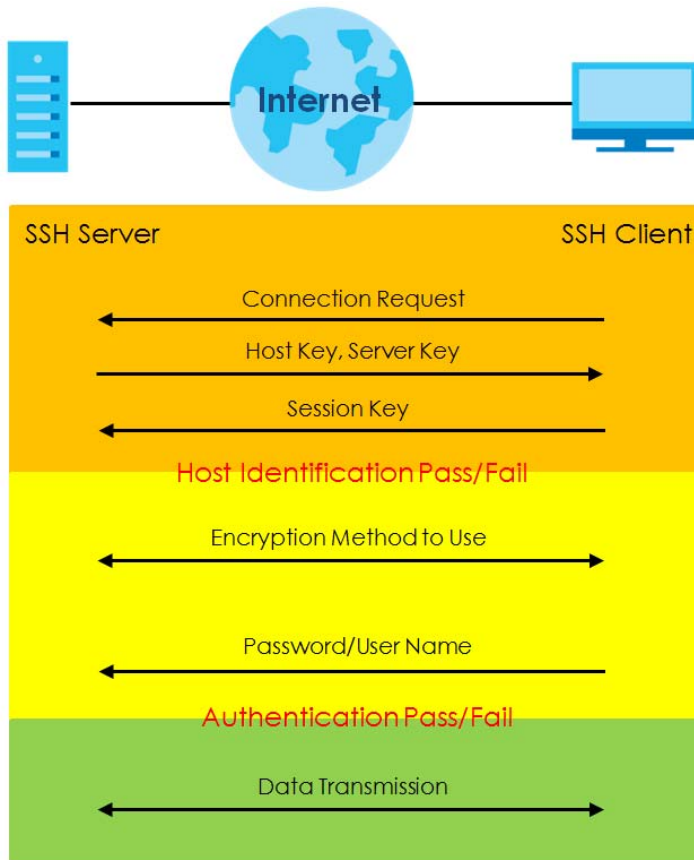

1 Host Identification

The SSH client sends a connection request to the SSH server. The server identifies itself with a host key. The client encrypts a randomly generated session key with the host key and server key and sends the result back to the server.

The client automatically saves any new server public keys. In subsequent connections, the server public key is checked against the saved version on the client computer.

2 Encryption Method

Once the identification is verified, both the client and server must agree on the type of encryption method to use.

3 Authentication and Data Transmission

After the identification is verified and data encryption activated, a secure tunnel is established between the client and the server. The client then sends its authentication information (user name and password) to the server to log in to the server.

67.5.1.2 SSH Implementation on the Switch

Your Switch supports SSH version 2 using RSA authentication and three encryption methods (DES, 3DES and Blowfish). The SSH server is implemented on the Switch for remote management and file transfer on port 22. Only one SSH connection is allowed at a time.

67.5.1.3 Requirements for Using SSH

You must install an SSH client program on a client computer (Windows or Linux operating system) that is used to connect to the Switch over SSH.

67.5.2 Introduction to HTTPS

HTTPS (HyperText Transfer Protocol over Secure Socket Layer, or HTTP over SSL) is a web protocol that encrypts and decrypts web pages. Secure Socket Layer (SSL) is an application-level protocol that enables secure transactions of data by ensuring confidentiality (an unauthorized party cannot read the transferred data), authentication (one party can identify the other party) and data integrity (you know if data has been changed).

It relies upon certificates, public keys, and private keys.

HTTPS on the Switch is used so that you may securely access the Switch using the Web Configurator. The SSL protocol specifies that the SSL server (the Switch) must always authenticate itself to the SSL client (the computer which requests the HTTPS connection with the Switch), whereas the SSL client only should authenticate itself when the SSL server requires it to do so. Authenticating client certificates is optional and if selected means the SSL-client must send the Switch a certificate. You must apply for a certificate for the browser from a Certificate Authority (CA) that is a trusted CA on the Switch.

Please refer to the following figure.

- 1 HTTPS connection requests from an SSL-aware web browser go to port 443 (by default) on the Switch's WS (web server).
- 2 HTTP connection requests from a web browser go to port 80 (by default) on the Switch's WS (web server).

Figure 400 HTTPS Implementation

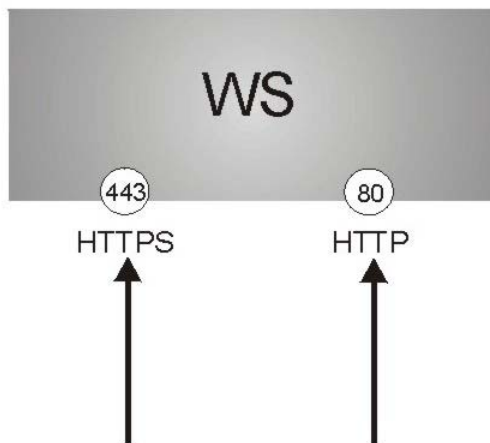

Note: If you disable HTTP in the Service Access Control screen, then the Switch blocks all HTTP connection attempts.

67.5.2.1 HTTPS Example

If you have not changed the default HTTPS port on the Switch, then in your browser enter "https://Switch IP Address/" as the web site address where "Switch IP Address" is the IP address or domain name of the Switch you wish to access.

Mozilla Firefox Warning Messages

When you attempt to access the Switch HTTPS server, a **Your connection is not secure** screen may display. If that is the case, click **I Understand the Risks** and then the **Add Exception...** button.

Figure 401 Security Alert (Mozilla Firefox)

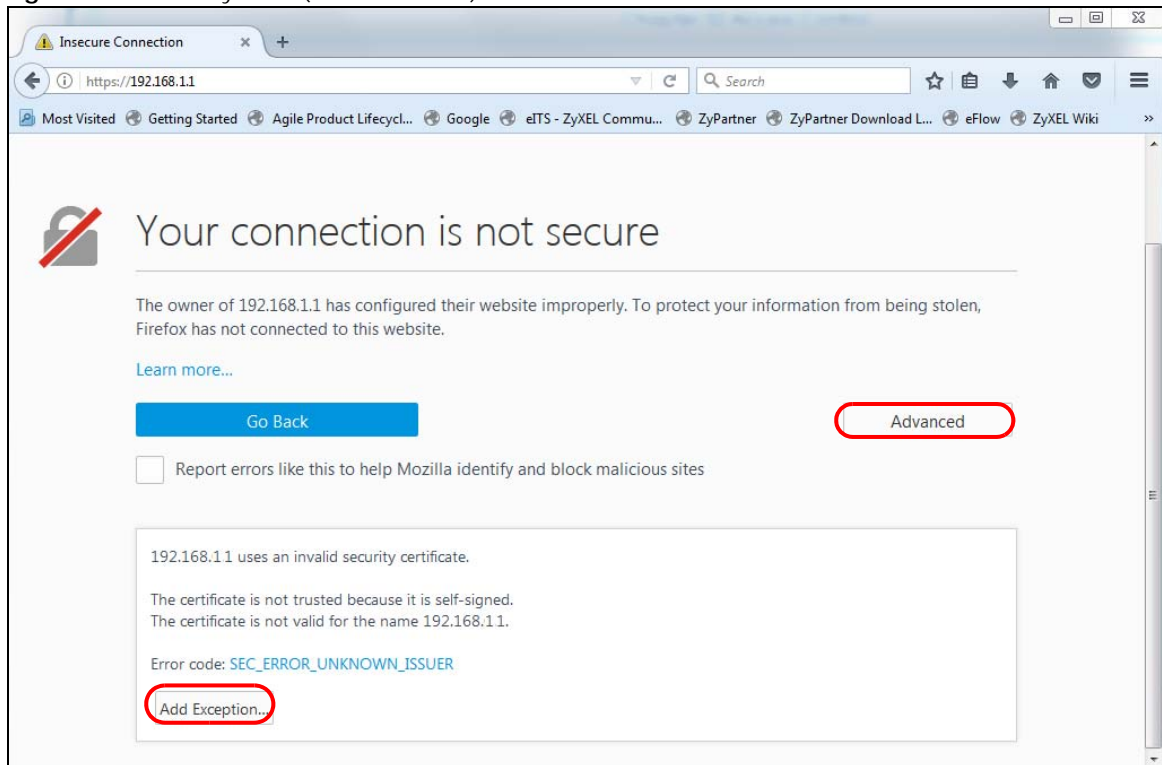

Confirm the HTTPS server URL matches. Click **Confirm Security Exception** to proceed to the Web Configurator login screen.

Figure 402 Security Alert (Mozilla Firefox)

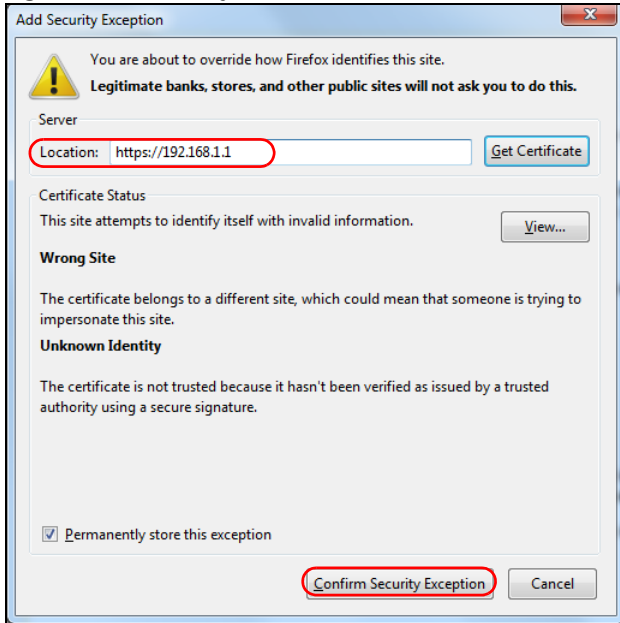

67.5.3 Google Chrome Warning Messages

When you attempt to access the Switch HTTPS server, a **Your connection is not private** screen may display. If that is the case, click **Advanced** and then **Proceed to x.x.x.x (unsafe)** to proceed to the Web Configurator login screen.

Figure 403 Security Alert (Google Chrome 99.0.4844.82)

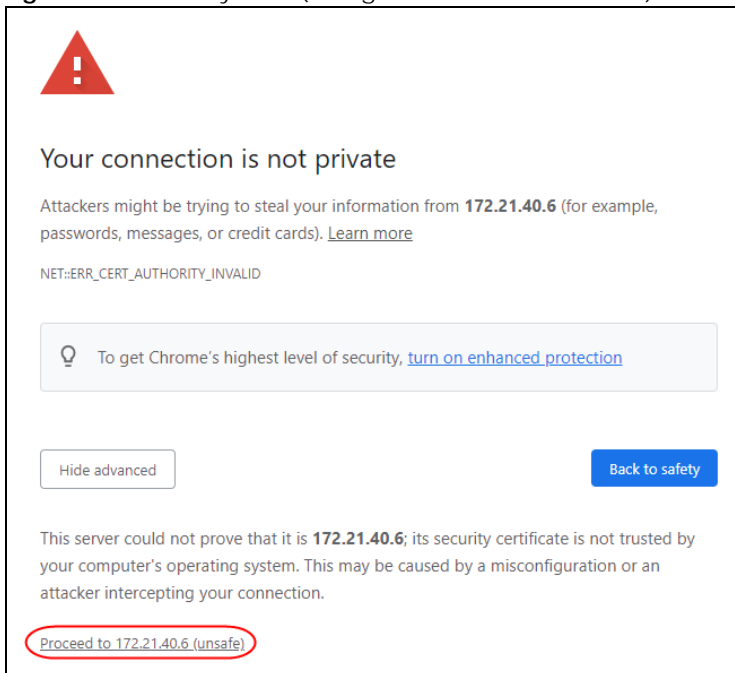

67.5.3.1 Main Settings

After you accept the certificate and enter the login user name and password, the Switch main screen appears. The lock displayed in the bottom right of the browser status bar or next to the website address denotes a secure connection.

Figure 404 Example: Lock Denoting a Secure Connection

The screenshot shows a web browser window displaying the ZyXEL XGS2220 management interface. The address bar shows the URL `172.21.40.2/rpSys.html` with a lock icon on the left, indicating a secure connection. The browser's address bar also shows a search icon, a refresh icon, and a print icon. The page header includes the ZyXEL logo, the model number `XGS2220`, and the firmware version `Standard Networked AV`. A search bar labeled "Nebula Control Center" is also present.

The main content area is divided into several sections:

- DASHBOARD**: A sidebar menu with options for DASHBOARD, MONITOR, SYSTEM, PORT, SWITCHING, NETWORKING, SECURITY, and MAINTENANCE.
- Port Status**: A section titled "XGS2220-54FP" showing a grid of port status indicators. The grid is divided into "Copper" (ports 1-50) and "Fiber" (ports 51-54). Ports 2 and 4 are highlighted in green, indicating they are active.
- System Information**: A section displaying system details:

System Name	XGS2220	System Location	
Boot Version	V1.00 12/23/2021	ZyNOS F/W Version	V4.80(ACCE.0)b6 04/11/2022
System Time		System Uptime	
- Performance Metrics**: A section showing system health:

CPU Usage	29 %	Memory Usage	13 %	Power Usage	0.1 %
Temperature	Normal	Fan			

CHAPTER 68

Classifier

68.1 Classifier Overview

This chapter introduces and shows you how to configure the packet classifier on the Switch. It also discusses Quality of Service (QoS) and classifier concepts as employed by the Switch.

68.1.1 What You Can Do

- Use the **Classifier Status** screen ([Section 68.2 on page 510](#)) to view the classifiers configured on the Switch and how many times the traffic matches the rules.
- Use the **Classifier Setup** screen ([Section 68.3 on page 510](#)) to define the classifiers and view a summary of the classifier configuration. After you define the classifier, you can specify actions (or policy) to act upon the traffic that matches the rules.
- Use the **Classifier Global Setting** screen ([Section 68.4 on page 515](#)) to configure the match order and enable logging on the Switch.

68.1.2 What You Need to Know

Quality of Service (QoS) refers to both a network's ability to deliver data with minimum delay, and the networking methods used to control the use of bandwidth. Without QoS, all traffic data is equally likely to be dropped when the network is congested. This can cause a reduction in network performance and make the network inadequate for time-critical application such as video-on-demand.

A classifier groups traffic into data flows according to specific criteria such as the source address, destination address, source port number, destination port number or incoming port number. For example, you can configure a classifier to select traffic from the same protocol port (such as Telnet) to form a flow.

Configure QoS on the Switch to group and prioritize application traffic and fine-tune network performance. Setting up QoS involves two separate steps:

- 1 Configure classifiers to sort traffic into different flows.
- 2 Configure policy rules to define actions to be performed on a classified traffic flow (refer to [Chapter 69 on page 518](#) to configure policy rules).

You can also configure policy routing to forward a classified traffic flow to a different gateway for cost savings and load sharing.

68.2 Classifier Status

Use this screen to view the classifiers configured on the Switch and how many times the traffic matches the rules.

Click **SECURITY > ACL > Classifier > Classifier Status** to display the configuration screen as shown.

Figure 405 SECURITY > ACL > Classifier > Classifier Status

The following table describes the labels in this screen.

Table 264 SECURITY > ACL > Classifier > Classifier Status

LABEL	DESCRIPTION
Index	This field displays the index number of the rule.
Active	This field displays whether the rule is activated or not.
Weight	This field displays the rule's weight. This is to indicate a rule's priority when the match order is set to manual in the SECURITY > ACL > Classifier > Classifier Global Setting screen. The higher the number, the higher the rule's priority.
Name	This field displays the descriptive name for this rule. This is for identification purpose only.
Match Count	This field displays the number of times a rule is applied. It displays '-' if the rule does not have count enabled.
Rule	This field displays a summary of the classifier rule's settings.
Clear the Classifier	
Any	Select Any , then click Clear to clear the matched count for all classifiers.
Classifier	Select Classifier , enter a classifier rule name and then click Clear to erase the recorded statistical information for that classifier, or select Any to clear statistics for all classifiers.
Clear	Click Clear to erase the recorded statistical information for the classifier.

68.3 Classifier Setup

Use this screen to view and configure the classifiers. After you define the classifier, you can specify actions (or policy) to act upon the traffic that matches the rules.

Click **SECURITY > ACL > Classifier Setup** to display the configuration screen as shown.

Figure 406 SECURITY > ACL > Classifier > Classifier Setup

Classifier Status	Classifier Setup	Classifier Global Setting
		<input type="button" value="+ Add/Edit"/> <input type="button" value="Delete"/>
<input type="checkbox"/>	Index	Active
	Weight	Name
		Rule

The following table describes the labels in this screen.

Table 265 SECURITY > ACL > Classifier > Classifier Setup

LABEL	DESCRIPTION
Index	This field displays the index number of the rule.
Active	This field displays Yes when the rule is activated and No when it is deactivated.
Weight	The field displays the priority of the rule when the match order is in manual mode. A higher weight means a higher priority.
Name	This field displays the descriptive name for this rule. This is for identification purpose only.
Rule	This field displays a summary of the classifier rule's settings.
	Select an entry's check box to select a specific entry. Otherwise, select the check box in the table heading row to select all entries.
Add/Edit	Click Add/Edit to add a new entry or edit a selected one.
Delete	Click Delete to remove the selected entries.

The following table shows some other common Ethernet types and the corresponding protocol number.

Table 266 Common Ethernet Types and Protocol Numbers

ETHERNET TYPE	PROTOCOL NUMBER
IP ETHII	0800
X.75 Internet	0801
NBS Internet	0802
ECMA Internet	0803
Chaosnet	0804
X.25 Level 3	0805
XNS Compat	0807
Banyan Systems	0BAD
BBN Simnet	5208
IBM SNA	80D5
AppleTalk AARP	80F3

In the Internet Protocol there is a field, called "Protocol", to identify the next level protocol. The following table shows some common protocol types and the corresponding protocol number. Refer to <http://www.iana.org/assignments/protocol-numbers> for a complete list.

Table 267 Common IP Protocol Types and Protocol Numbers

PROTOCOL TYPE	PROTOCOL NUMBER
ICMP	1
TCP	6
UDP	17

Table 267 Common IP Protocol Types and Protocol Numbers

PROTOCOL TYPE	PROTOCOL NUMBER
EGP	8
L2TP	115

68.3.1 Add/Edit a Classifier

Use this screen to define the classifiers. After you define the classifier, you can specify actions (or policy) to act upon the traffic that matches the rules.

Click **Add/Edit**, or select an entry and click **Add/Edit** in the **SECURITY > ACL > Classifier Setup** screen to display this screen.

Figure 407 SECURITY > ACL > Classifier > Classifier Setup > Add/Edit

The screenshot shows the 'Add/Edit Classifier' configuration screen. The interface is organized into several sections, each with a green header bar:

- General:**
 - Active: ON
 - Name:
 - Weight:
 - Log:
 - Count:
 - Time Range:
- Ingress Port:**
 - Port: Any
 - Trunk: Any
- Layer 2:**
 - VLAN: Any
 - Priority: Any
 - Ethernet Type: All Others (Hex)
 - Source MAC Address: Any MAC/Mask /
 - Destination MAC Address: Any MAC/Mask /
- Layer 3:**
 - IPv4 DSCP: Any
 - IPv6 DSCP: Any
 - Precedence: Any
 - ToS: Any
 - IP Protocol: All Establish Only Others (Dec)
 - IPv6 Next Header: All Establish Only Others (Dec)
 - Source IP Address/Prefix: /
 - Destination IP Address/Prefix: /
- Layer 4:**
 - Source Socket Number: Any to
 - Destination Socket Number: Any to

At the bottom right, there are three buttons: **Apply** (green), **Clear** (grey), and **Cancel** (grey).

The following table describes the labels in this screen.

Table 268 SECURITY > ACL > Classifier > Classifier Setup > Add/Edit

LABEL	DESCRIPTION
Active	Enable the switch button to enable this rule.
Name	Enter a descriptive name for this rule for identifying purposes. You can enter up to 32 printable ASCII characters except [?], [], ['], ["] or [,].
Weight	Enter a number between 0 and 65535 to specify the rule's weight. When the match order is in manual mode in the Classifier Global Setting screen, a higher weight means a higher priority.
Log	Select this option to have the Switch create a log message when the rule is applied and record the number of matched packets in a particular time interval. Note: Make sure you also enable logging in the Classifier Global Setting screen.
Count	Select this option to have the Switch count how many times the rule is applied.
Time Range	Select the name of the pre-configured schedule that you want to apply to the rule. The rule will be active only at the scheduled date and/or time. If you select None , the rule will be active all the time.
Ingress Port	
Port	Type the port number to which the rule should be applied. You may choose one port only or all ports (Any). You can enter multiple ports separated by (no space) comma (,) or hyphen (-) for a range. For example, enter "3-5" for ports 3, 4, and 5. Enter "3,5,7" for ports 3, 5, and 7. In Stacking mode, the first number represents the slot and the second the port number. Enter 1/1-1/24,2/23 for ports 1 to 24 for the Switch in slot 1 and port 23 for the Switch in slot 2, for example.
Trunk	Select Any to apply the rule to all trunk groups. Alternatively, to specify multiple trunks, enter the trunk group ID to apply the rule to multiple trunks. You can enter multiple trunks with (t) or (T) then the trunk group ID separated by (no space) comma (,) or hyphen (-). For example, enter "t3-t5" for trunks 3, 4, and 5. Enter "T3,T5,T7" for trunks 3, 5, and 7.
Layer 2	
Specify the fields below to configure a layer 2 classifier.	
VLAN	Select Any to classify traffic from any VLAN or select the second option and specify the source VLAN ID in the field provided.
Priority	Select Any to classify traffic from any priority level or select the second option and specify a priority level in the field provided.
Ethernet Type	Select an Ethernet type or select Other and enter the Ethernet type number in hexadecimal value.
Source MAC Address	Select Any to apply the rule to all MAC addresses. To specify a source, select MAC/Mask to enter the source MAC address of the packet in valid MAC address format (six hexadecimal character pairs) and type the mask for the specified MAC address to determine which bits a packet's MAC address should match. Enter "f" for each bit of the specified MAC address that the traffic's MAC address should match. Enter "0" for the bits of the matched traffic's MAC address, which can be of any hexadecimal characters. For example, if you set the MAC address to 00:13:49:00:00:00 and the mask to ff:ff:ff:00:00:00, a packet with a MAC address of 00:13:49:12:34:56 matches this criteria. If you leave the Mask field blank, the Switch automatically sets the mask to ff:ff:ff:ff:ff:ff.

Table 268 SECURITY > ACL > Classifier > Classifier Setup > Add/Edit (continued)

LABEL	DESCRIPTION
Destination MAC Address	<p>Select Any to apply the rule to all MAC addresses.</p> <p>To specify a destination, select MAC/Mask to enter the destination MAC address of the packet in valid MAC address format (six hexadecimal character pairs) and type the mask for the specified MAC address to determine which bits a packet's MAC address should match.</p> <p>Enter "f" for each bit of the specified MAC address that the traffic's MAC address should match. Enter "0" for the bits of the matched traffic's MAC address, which can be of any hexadecimal characters. For example, if you set the MAC address to 00:13:49:00:00:00 and the mask to ff:ff:ff:00:00:00, a packet with a MAC address of 00:13:49:12:34:56 matches this criteria. If you leave the Mask field blank, the Switch automatically sets the mask to ff:ff:ff:ff:ff:ff.</p>
<p>Layer 3</p> <p>Specify the fields below to configure a layer 3 classifier.</p>	
IPv4/IPv6 DSCP	Select Any to classify traffic from any DSCP or select the second option and specify a DSCP (DiffServ Code Point) number between 0 and 63 in the field provided.
Precedence	Select Any to classify traffic from any precedence or select the second option and specify an IP Precedence (the first 3 bits of the 8-bit ToS field) value between 0 and 7 in the field provided.
ToS	Select Any to classify traffic from any ToS or select the second option and specify Type of Service (the last 5 bits of the 8-bit ToS field) value between 0 and 255 in the field provided.
IP Protocol	<p>Select an IPv4 protocol type or select Other and enter the protocol number in decimal value.</p> <p>You may select Establish Only for TCP protocol type. This means that the Switch will pick out the packets that are sent to establish TCP connections.</p>
IPv6 Next Header	<p>Select an IPv6 protocol type or select Other and enter an 8-bit next header in the IPv6 packet. The Next Header field is similar to the IPv4 Protocol field. The IPv6 protocol number ranges from 1 to 255.</p> <p>You may select Establish Only for TCP protocol type. This means that the Switch will identify packets that initiate or acknowledge (establish) TCP connections.</p>
Source IP Address/ Address Prefix	<p>Enter a source IP address in dotted decimal notation.</p> <p>Specify the address prefix by entering the number of ones in the subnet mask.</p> <p>A subnet mask can be represented in a 32-bit notation. For example, the subnet mask "255.255.255.0" can be represented as "11111111.11111111.11111111.00000000", and counting up the number of ones in this case results in 24.</p>
Destination IP Address/ Address Prefix	<p>Enter a destination IP address in dotted decimal notation.</p> <p>Specify the address prefix by entering the number of ones in the subnet mask.</p>
<p>Layer 4</p> <p>Specify the fields below to configure a layer 4 classifier.</p>	
Source Socket Number	<p>Select Any to apply the rule to all TCP/UDP protocol port numbers or select the second option and enter a TCP/UDP protocol port number.</p> <p>Note: You must select either UDP or TCP in the IP Protocol field before you configure the socket numbers.</p>
Destination Socket Number	<p>Select Any to apply the rule to all TCP/UDP protocol port numbers or select the second option and enter a TCP/UDP protocol port number.</p> <p>Note: You must select either UDP or TCP in the IP Protocol field before you configure the socket numbers.</p>
Apply	Click Apply to save your changes to the Switch's run-time memory. The Switch loses these changes if it is turned off or loses power, so use the Save link on the top navigation panel to save your changes to the non-volatile memory when you are done configuring.

Table 268 SECURITY > ACL > Classifier > Classifier Setup > Add/Edit (continued)

LABEL	DESCRIPTION
Clear	Click Clear to clear the fields to the factory defaults.
Cancel	Click Cancel to not save the configuration you make and return to the last screen.

68.4 Classifier Global Setting

Use this screen to configure the match order and enable logging on the Switch. Click **SECURITY > ACL > Classifier > Classifier Global Setting** to display the configuration screen as shown.

Figure 408 SECURITY > ACL > Classifier > Classifier Global Setting

The following table describes the labels in this screen.

Table 269 SECURITY > ACL > Classifier > Classifier Global Setting

LABEL	DESCRIPTION
Match Order	<p>Use this field to set the match order for the classifier rules.</p> <p>A traffic flow can only be classified to one classifier. When a traffic flow matches more than one classifier rule, the Switch classifies the traffic based on the Match Order.</p> <p>Select manual to have classifier rules applied according to the weight of each rule you configured in SECURITY > ACL > Classifier > Classifier Setup. If they have the same weight, the Switch will classify the traffic to the classifier with a higher name priority (see Classifier Name Priority).</p> <p>Alternatively, select auto to have classifier rules applied according to the layer of the item configured in the rule. Layer-4 items have the highest priority, and layer-2 items has the lowest priority. For example, you configure a layer-2 item (VLAN ID) in classifier A and configure a layer-3 item (source IP address) in classifier B. When an incoming packet matches both classifier rules, classifier B has priority over classifier A. If both classifiers have the same priority, the Switch will apply the classifier with a higher name priority.</p> <p>Classifier Name Priority</p> <p>The longer the classifier name, the higher the classifier priority. If two classifier names are the same length, the bigger the character, the higher the classifier priority. The lowercase letters (such as a and b) have higher priority than the capitals (such as A and B) in the classifier name. For example, the classifier with the name of class 2, class a or class B takes priority over the classifier with the name of class 1 or class A.</p>
Logging	
Active	Enable the switch button to allow the Switch to create a log when packets match a classifier rule during a defined time interval.

Table 269 SECURITY > ACL > Classifier > Classifier Global Setting (continued)

LABEL	DESCRIPTION
Interval	Set the length of the time period (in seconds) to count matched packets for a classifier rule. Enter an integer from 0 – 65535. 0 means that no logging is done.
Apply	Click Apply to save your changes to the Switch's run-time memory. The Switch loses these changes if it is turned off or loses power, so use the Save link on the top navigation panel to save your changes to the non-volatile memory when you are done configuring.
Cancel	Click Cancel to begin configuring this screen afresh.

68.5 Classifier Example

The following screen shows an example where you configure a classifier that identifies all traffic from MAC address 00:50:ba:ad:4f:81 on port 2.

Figure 409 Classifier: Example

Active	<input checked="" type="checkbox"/> ON	
Name	example	
Weight	32767	
Log	<input type="checkbox"/>	
Count	<input type="checkbox"/>	
Time Range	None	
Packet Format	All	
Ingress Port		
Port	<input type="radio"/> Any	<input checked="" type="radio"/> 2
Trunk	<input checked="" type="radio"/> Any	<input type="radio"/>
Layer 2		
VLAN	<input checked="" type="radio"/> Any	<input type="radio"/>
Inner VLAN	<input checked="" type="radio"/> Any	<input type="radio"/>
Priority	<input checked="" type="radio"/> Any	<input type="radio"/> 0
Inner Priority	<input checked="" type="radio"/> Any	<input type="radio"/> 0
EtherType	<input checked="" type="radio"/> All	<input type="radio"/> Others (Hex)
Source MAC Address	<input type="radio"/> Any	<input checked="" type="radio"/> MAC/Mask 00:50:ba:ad:4f:81 /
Destination MAC Address	<input checked="" type="radio"/> Any	<input type="radio"/> MAC/Mask /
Layer 3		
IP Packet Length	<input checked="" type="radio"/> Any	<input type="radio"/> to bytes
IPv4 DSCP	<input checked="" type="radio"/> Any	<input type="radio"/>
IPv6 DSCP	<input checked="" type="radio"/> Any	<input type="radio"/>
Precedence	<input checked="" type="radio"/> Any	<input type="radio"/>
ToS	<input checked="" type="radio"/> Any	<input type="radio"/>
IP Protocol	<input checked="" type="radio"/> All <input type="checkbox"/> Establish Only	<input type="radio"/> Others (Dec)
IPv6 Next Header	<input checked="" type="radio"/> All <input type="checkbox"/> Establish Only	<input type="radio"/> Others (Dec)
Source IP Address/Prefix	/	
Destination IP Address/Prefix	/	
Layer 4		
Source Socket Number	<input checked="" type="radio"/> Any	<input type="radio"/> to
Destination Socket Number	<input checked="" type="radio"/> Any	<input type="radio"/> to
<input checked="" type="button"/> Apply <input type="button"/> Clear <input type="button"/> Cancel		

After you have configured a classifier, you can configure a policy (in the **SECURITY > ACL > Policy Rule** screen) to define actions on the classified traffic flow.

CHAPTER 69

Policy Rule

69.1 Policy Rules Overview

This chapter shows you how to configure policy rules.

A classifier distinguishes traffic into flows based on the configured criteria (refer to [Chapter 68 on page 509](#) for more information). A policy rule ensures that a traffic flow gets the requested treatment in the network.

69.1.1 What You Can Do

Use the **Policy Rule** screen ([Section 69.2 on page 519](#)) to enable the policy and display the active classifiers you configure in the **Classifier** screen.

69.1.2 DiffServ

DiffServ (Differentiated Services) is a class of service (CoS) model that marks packets so that they receive specific per-hop treatment at DiffServ-compliant network devices along the route based on the application types and traffic flow. Packets are marked with DiffServ Code Points (DSCPs) indicating the level of service desired. This allows the intermediary DiffServ-compliant network devices to handle the packets differently depending on the code points without the need to negotiate paths or remember state information for every flow. In addition, applications do not have to request a particular service or give advanced notice of where the traffic is going.

69.1.3 DSCP and Per-Hop Behavior

DiffServ defines a new DS (Differentiated Services) field to replace the Type of Service (TOS) field in the IP header. The DS field contains a 2-bit unused field and a 6-bit DSCP field which can define up to 64 service levels. The following figure illustrates the DS field.

DSCP is backward compatible with the three precedence bits in the ToS octet so that non-DiffServ compliant, ToS-enabled network device will not conflict with the DSCP mapping.

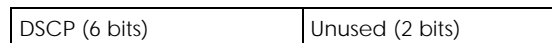

The DSCP value determines the forwarding behavior, the PHB (Per-Hop Behavior), that each packet gets across the DiffServ network. Based on the marking rule, different kinds of traffic can be marked for different kinds of forwarding. Resources can then be allocated according to the DSCP values and the configured policies.

69.2 Policy Rules

Click **SECURITY > ACL > Policy Rule** in the navigation panel to display the screen as shown.

Figure 410 SECURITY > ACL > Policy Rule

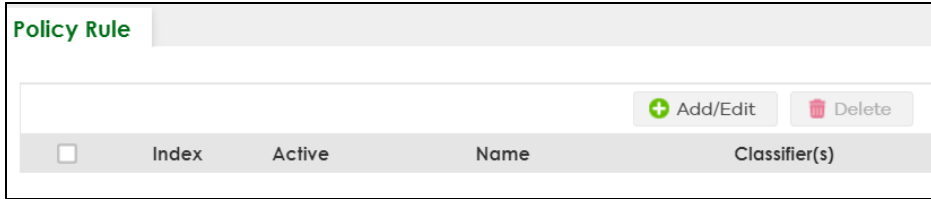

The following table describes the labels in this screen.

Table 270 SECURITY > ACL > Policy Rule

LABEL	DESCRIPTION
Index	This field displays the policy index number.
Active	This field displays whether policy is activated or not.
Name	This field displays the name you have assigned to this policy.
Classifier(s)	This field displays the names of the classifier to which this policy applies.
	Select an entry's check box to select a specific entry. Otherwise, select the check box in the table heading row to select all entries.
Add/Edit	Click Add/Edit to add a new entry or edit a selected one.
Delete	Click Delete to remove the selected entries.

69.2.1 Add/Edit a Policy Rule

You must first configure a classifier in the **SECURITY > ACL > Classifier > Classifier Setup** screen.

Click **Add/Edit**, or select an entry and click **Add/Edit** in the **SECURITY > ACL > Policy Rule** screen to display this screen.

Figure 411 SECURITY > ACL > Policy Rule > Add/Edit

Source & Destination

Active ON

Name

Classifier(s)

General Parameters

Vlan ID

Egress Port

Priority

DSCP

TOS

Metering Parameters

Bandwidth Kbps

Out of Profile DSCP

Action

Forwarding No change
 Discard the packet

Priority No change
 Set the packet's 802.1p priority
 Replace the 802.1p priority field with the inner 802.1p priority value

Diffserv No change
 Set the packet's TOS field
 Set the Diffserv Codepoint field in the frame

Outgoing Send the packet to the mirror port
 Send the packet to the egress port
 Set the packet's VlanID

Metering ON

Out of profile action

Drop the packet
 Change the DSCP value

The following table describes the labels in this screen.

Table 271 SECURITY > ACL > Policy Rule > Add/Edit

LABEL	DESCRIPTION
Source & Destination	
Active	Enable the switch button to enable the policy.
Name	Enter a descriptive name for identification purposes. You can enter up to 32 printable ASCII characters except [?], [], ['], ["] or [,].
Classifier(s)	This field displays the active classifiers you configure in the SECURITY > ACL > Classifier > Classifier Setup screen. Select the classifiers to which this policy rule applies. To select more than one classifier, press [SHIFT] and select the choices at the same time.

Table 271 SECURITY > ACL > Policy Rule > Add/Edit (continued)

LABEL	DESCRIPTION
General Parameters	
Set the fields below for this policy. You only have to set the fields that is related to the actions you configure in the Action field.	
Vlan ID	Specify a VLAN ID.
Egress Port	Enter the number of an outgoing port. In stacking mode, the first number represents the slot and the second the port number.
Priority	Specify a priority level.
DSCP	Specify a DSCP (DiffServ Code Point) number between 0 and 63.
TOS	Specify the Type Of Service (TOS) priority level.
Metering Parameters	
You can configure the desired bandwidth available to a traffic flow. Traffic that exceeds the maximum bandwidth allocated (in cases where the network is congested) is called out-of-profile traffic.	
Bandwidth	Specify the bandwidth in kilobit per second (Kbps). Enter a number between 1 and 1000000.
Out of Profile DSCP	Specify a new DSCP number (between 0 and 63) if you want to replace or remark the DSCP number for out-of-profile traffic.
Action	
Specify the actions the Switch takes on the associated classified traffic flow.	
Note: You can specify only one action (option) for each category (Forwarding, Priority, Queue, Diffserv, Outgoing, Metering) in a policy rule.	
Note: The Switch only applies one policy rule for each traffic flow.	
Say you have a traffic flow that matches several classifiers, and you specify a different policy rule for each. The Switch only classifies the traffic flow to the classifier with the highest Match Order . The Switch then applies the policy rule with which the classifier is associated. You can set the classifier Match Order rule (manual or auto) in the ACL > Classifier > Classifier Global settings screen (see Section 68.4 on page 515 for more information).	
Let's say you set two classifiers (Class 1 and Class 2) and both identify all traffic from MAC address 11:22:33:44:55:66 on port 3.	
If Policy 1 applies to Class 1 and the action is to drop the packets, Policy 2 applies to Class 2 and the action is to forward the packets to the egress port, the Switch will forward the packets.	
If Policy 1 applies to Class 1 and the action is to drop the packets, Policy 2 applies to Class 2 and the action is to enable bandwidth limitation, the Switch will discard the packets immediately.	
If Policy 1 applies to Class 1 and the action is to forward the packets to the egress port, Policy 2 applies to Class 2 and the action is to enable bandwidth limitation, the Switch will forward the packets.	
Forwarding	Select No change to forward the packets. Select Discard the packet to drop the packets.
Priority	Select No change to keep the priority setting of the frames. Select Set the packet's 802.1p priority to replace the packet's 802.1p priority field with the value you set in the Priority field and put the packets in the designated queue. Select Replace the 802.1p priority field with the inner 802.1p priority value to replace the packet's 802.1p priority field with the existing customer priority level carried in the frames and put the packets in the designated queue.

Table 271 SECURITY > ACL > Policy Rule > Add/Edit (continued)

LABEL	DESCRIPTION
Diffserv	<p>Select No change to keep the TOS and/or DSCP fields in the packets.</p> <p>Select Set the packet's TOS field to set the TOS field with the value you configure in the TOS field.</p> <p>Select Set the Diffserv Codepoint field in the frame to set the DSCP field with the value you configure in the DSCP field.</p>
Outgoing	<p>Select Send the packet to the mirror port to send the packet to the mirror port.</p> <p>Select Send the packet to the egress port to send the packet to the egress port.</p> <p>Select Set the packet's VLAN ID to set the packet's VLAN ID.</p>
Metering	<p>Enable the switch button to activate bandwidth limitation on the traffic flows then set the actions to be taken on out-of-profile packets.</p>
Out of profile action	<p>Select the actions to be performed for out-of-profile traffic.</p> <p>Select Drop the packet to discard the out-of-profile traffic.</p> <p>Select Change the DSCP value to replace the DSCP field with the value specified in the Out of profile DSCP field.</p>
Apply	<p>Click Apply to save your changes to the Switch's run-time memory. The Switch loses these changes if it is turned off or loses power, so use the Save link on the top navigation panel to save your changes to the non-volatile memory when you are done configuring.</p>
Clear	<p>Click Clear to clear the fields to the factory defaults.</p>
Cancel	<p>Click Cancel to not save the configuration you make and return to the last screen.</p>

69.3 Policy Example

The figure below shows an example **SECURITY > ACL > Policy Rule** screen where you configure a policy to limit bandwidth and discard out-of-profile traffic on a traffic flow classified using the **Example** classifier (refer to [Section 68.5 on page 516](#)).

Figure 412 Policy Example

Source & Destination

Active ON

Name

Classifier(s)

General Parameters

Egress Port

Priority ▼

DSCP

TOS ▼

Metering Parameters

Bandwidth Kbps

Out of Profile DSCP

Action

Forwarding No change
 Discard the packet
 Do not drop the matching frame previously marked for dropping

Priority No change
 Set the packet's 802.1p priority
 Replace the 802.1p priority field with the IP TOS value
 Replace the 802.1p priority field with the inner 802.1p priority value

Diffserv No change
 Set the packet's TOS field
 Replace the IP TOS field with the 802.1p priority value
 Set the Diffserv Codepoint field in the frame

Outgoing Send the packet to the mirror port
 Send the packet to the egress port

Metering ON

Out of profile action

Drop the packet
 Change the DSCP value
 Set Out-Drop Precedence
 Do not drop the matching frame previously marked for dropping

CHAPTER 70

Anti-Arpscan

70.1 Anti-Arpscan Overview

Address Resolution Protocol (ARP), RFC 826, is a protocol used to convert a network-layer IP address to a link-layer MAC address. ARP scan is used to scan the network of a certain interface for alive hosts. It shows the IP address and MAC addresses of all hosts found. Hackers could use ARP scan to find targets in your network. **Anti-arpscan** is used to detect unusual ARP scan activity and block suspicious hosts or ports.

Unusual ARP scan activity is determined by port and host thresholds that you set. A port threshold is determined by the number of packets received per second on the port. If the received packet rate is over the threshold, then the port is put into an **Err-Disable** state. You can recover the normal state of the port manually if this happens and after you identify the cause of the problem.

A host threshold is determined by the number of ARP-request packets received per second. There is a global threshold rate for all hosts. If the rate of a host is over the threshold, then that host is blocked by using a MAC address filter. A blocked host is released automatically after the MAC aging time expires.

Note: A port-based threshold must be larger than the host-based threshold or the host-based threshold will not work.

70.1.1 What You Can Do

- Use the **Anti-Arpscan Status** screen ([Section 70.2 on page 525](#)) to see what ports are trusted and are forwarding traffic or are disabled.
- Use the **Anti-Arpscan Host Status** screen ([Section 70.3 on page 526](#)) to view blocked hosts and clear selected ones.
- Use this **Anti-Arpscan Setup** screen ([Section 70.4 on page 527](#)) to enable anti-arpscan, set port and host thresholds as well as configure ports to be trusted or untrusted.
- Use the **Anti-Arpscan Trust Host** screen ([Section 70.5 on page 529](#)) to create or remove trusted hosts identified by IP address and subnet mask. **Anti-arpscan** is not performed on trusted hosts.

70.1.2 What You Need to Know

- You should set an uplink port as a trusted port before enabling **Anti-arpscan** so as to prevent the port from being shutdown due to receiving too many ARP messages.
- When a port is configured as a trusted port, **Anti-arpscan** is not performed on the port. Both host and port thresholds are ignored for trusted ports. If the received ARP packet rate on a port or the received ARP-requests from a host exceed the thresholds, the trusted port will not be closed.
- If a port on the Switch is closed by **Anti-arpscan**, and you want to recover it, then do one of the following:

- Go to **PORT > Port Setup**. Clear **Active** and click **Apply**. Then select **Active** and click **Apply** again.
- Go to **SECURITY > Errdisable > Errdisable Recovery** and set the interval for **anti-arpscan**. After the interval expires, the closed ports will become active and start receiving packets again.
- Use the command `port no inactive`.
- Refer to the port logs to see when a port was closed.

70.2 Anti-Arpscan Status

Use this screen to see what ports are trusted and are forwarding traffic or are disabled. To open this screen, click **SECURITY > Anti-Arpscan > Anti-Arpscan Status**.

Figure 413 SECURITY > Anti-Arpscan > Anti-Arpscan Status (Standalone Mode)

Anti-Arpscan Status			Anti-Arpscan Host Status	Anti-Arpscan Setup
Anti-Arpscan is Disabled				
Port	Trusted	State		
1	OFF	Forwarding		
2	OFF	Forwarding		
3	OFF	Forwarding		
4	OFF	Forwarding		
5	OFF	Forwarding		
6	OFF	Forwarding		
7	OFF	Forwarding		

Figure 414 SECURITY > Anti-Arpscan > Anti-Arpscan Status (Stacking Mode)

Anti-Arpscan Status			Anti-Arpscan Host Status	Anti-Arpscan Setup
Anti-Arpscan is Disabled				
SLOT 1 ▾				
Port	Trusted	State		
1/1	OFF	Forwarding		
1/2	OFF	Forwarding		
1/3	OFF	Forwarding		
1/4	OFF	Forwarding		
1/5	OFF	Forwarding		
1/6	OFF	Forwarding		
1/7	OFF	Forwarding		

The following table describes the fields in this screen.

Table 272 SECURITY > Anti-Arpscan > Anti-Arpscan Status

LABEL	DESCRIPTION
Anti-Arpscan is....	This shows whether Anti-arpscan is enabled or disabled on the Switch.
SLOT	This field appears only in Stacking mode. Click the drop-down list to choose the slot number of the Switch in a stack.
Port	This field displays the port number of the Switch. In Stacking mode, the first number represents the slot ID and the second is the port number. Please note that the default stacking ports (the last four ports of your Switch) cannot be configured. They are reserved for stacking only.
Trusted	This field displays whether the port is trusted or untrusted. Anti-arpscan is not performed on a trusted port.
State	This field displays whether the port can forward traffic normally (Forwarding) or is disabled (Err-Disable).

70.3 Anti-Arpscan Host Status

Use this screen to view blocked hosts and unblock ones connected to certain ports. To open this screen, click **SECURITY > Anti-Arpscan > Anti-Arpscan Host Status**.

Figure 415 SECURITY > Anti-Arpscan > Anti-Arpscan Host Status

The following table describes the fields in the above screen.

Table 273 SECURITY > Anti-Arpscan > Anti-Arpscan Host Status

LABEL	DESCRIPTION
Clear Filtered host	A filtered host is a blocked IP address.
Port List	Enter a port number or a series of port numbers separated by commas and spaces, and then click Clear to unblock all hosts connected to these ports.
Filtered host	This table lists information on blocked hosts.
Index	This displays the index number of an IP address (a host) that has been blocked.
Host IP	This displays the IP address of the blocked host.
MAC Address	This displays the MAC address of the blocked host.
VLAN	This displays the VLAN ID that shows which VLAN the blocked host is in.

Table 273 SECURITY > Anti-Arpscan > Anti-Arpscan Host Status (continued)

LABEL	DESCRIPTION
Port	This displays the port number to which the blocked host is connected.
State	This shows Err-Disable if the ARP-request rate from this host is over the threshold. Forwarding hosts are not displayed.

70.4 Anti-Arpscan Setup

Use this screen to enable **Anti-Arpscan**, set port and host thresholds as well as configure ports to be trusted or untrusted. To open this screen, click **SECURITY > Anti-Arpscan > Anti-Arpscan Setup**.

Figure 416 SECURITY > Anti-Arpscan > Anti-Arpscan Setup (Standalone Mode)

Anti-Arpscan Status Anti-Arpscan Host Status **Anti-Arpscan Setup**

Active OFF

Port Threshold pps

Host Threshold pps

Port	Trusted State
*	Untrusted ▼
1	Untrusted ▼
2	Untrusted ▼
3	Untrusted ▼
4	Untrusted ▼
5	Untrusted ▼
6	Untrusted ▼
7	Untrusted ▼

Figure 417 SECURITY > Anti-Arpscan > Anti-Arpscan Setup (Stacking Mode)

Anti-Arpscan Status Anti-Arpscan Host Status **Anti-Arpscan Setup**

Active OFF

Port Threshold pps

Host Threshold pps

SLOT 1 ▾

Port	Trusted State
1/*	Untrusted ▾
1/1	Untrusted ▾
1/2	Untrusted ▾
1/3	Untrusted ▾
1/4	Untrusted ▾
1/5	Untrusted ▾
1/6	Untrusted ▾
1/7	Untrusted ▾

Apply Cancel

The following table describes the fields in the above screen.

Table 274 SECURITY > Anti-Arpscan > Anti-Arpscan Setup

LABEL	DESCRIPTION
Active	Enable the switch button to enable Anti-arpscan on the Switch.
Port Threshold	<p>A port threshold is determined by the number of packets received per second on the port. If the received packet rate is over the threshold, then the port is put into an Err-Disable state. Type the maximum number of packets per second allowed on the port before it is blocked.</p> <p>Note: The allowed range is 2 to 255 packets received per second.</p>
Host Threshold	<p>A host threshold is determined by the number of ARP-request packets received per second. This is the global threshold rate for all hosts. If the rate of a host is over the threshold, then that host is blocked by using a MAC address filter. A blocked host is released automatically after the MAC aging time expires.</p> <p>Type the maximum number of ARP-request packets allowed by a host before it is blocked.</p> <p>Note: The allowed range is 2 to 100 ARP-request packets per second.</p> <p>Note: The port-based threshold must be larger than the host-based threshold or the host-based threshold will not be applied.</p>
SLOT	This field appears only in Stacking mode. Click the drop-down list to choose the slot number of the Switch in a stack.
Port	This field displays the port number. In Stacking mode, the first number represents the slot ID and the second is the port number. Please note that the default stacking ports (the last four ports of your Switch) cannot be configured. They are reserved for stacking only.

Table 274 SECURITY > Anti-Arpscan > Anti-Arpscan Setup (continued)

LABEL	DESCRIPTION
*	Settings in this row apply to all ports. Use this row only if you want to make some settings the same for all ports. Use this row first to set the common settings and then make adjustments on a port-by-port basis. Note: Changes in this row are copied to all the ports as soon as you make them.
Trusted State	Select Untrusted or Trusted for the associated port. Anti-arpscan is not performed on trusted hosts.
Apply	Click Apply to save your changes to the Switch's run-time memory. The Switch loses these changes if it is turned off or loses power, so use the Save link on the top navigation panel to save your changes to the non-volatile memory when you are done configuring.
Cancel	Click this to reset the values in this screen to their last-saved values.

70.5 Anti-Arpscan Trust Host

Use this screen to create or remove trusted hosts identified by IP address and subnet mask. **Anti-arpscan** is not performed on trusted hosts. To open this screen, click **SECURITY > Anti-Arpscan > Anti-Arpscan Trust Host**.

Figure 418 SECURITY > Anti-Arpscan > Anti-Arpscan Trust Host

<input type="checkbox"/>	Index	Name	Host IP	Mask
--------------------------	-------	------	---------	------

The following table describes the fields in the above screen.

Table 275 SECURITY > Anti-Arpscan > Anti-Arpscan Trust Host

LABEL	DESCRIPTION
Index	This field displays a sequential number for each trusted host.
Name	This field displays the name of the trusted host.
Host IP	This field displays the IP address of the trusted host.
Mask	This field displays the subnet mask of the trusted host.
	Select an entry's check box to select a specific entry. Otherwise, select the check box in the table heading row to select all entries.
Add/Edit	Click Add/Edit to add a new entry or edit a selected one.
Delete	Click Delete to remove the selected entries.

70.5.1 Add/Edit Anti-Arpscan Trust Hosts

Use this screen to add/edit trusted hosts identified by IP address and subnet mask. Click **Add/Edit**, or select an entry and click **Add/Edit** in the **SECURITY > Anti-Arpscan > Anti-Arpscan Trust Host** screen to view this screen.

Figure 419 SECURITY > Anti-Arpscan > Anti-Arpscan Trust Host > Add/Edit

The screenshot shows a configuration form with three text input fields labeled 'Name', 'Host IP', and 'Mask'. Below these fields are three buttons: 'Apply' (green), 'Clear' (grey), and 'Cancel' (grey).

The following table describes the fields in the above screen.

Table 276 SECURITY > Anti-Arpscan > Anti-Arpscan Trust Host > Add/Edit

LABEL	DESCRIPTION
Name	Type a descriptive name of up to 32 printable ASCII (except [?], [], ['], ["] or [,]) characters to identify this host.
Host IP	Type the IP address of the host.
Mask	A trusted host may consist of a subnet of IP addresses. Type a subnet mask to create a single host or a subnet of hosts.
Apply	Click Apply to save your changes to the Switch's run-time memory. The Switch loses these changes if it is turned off or loses power, so use the Save link on the top navigation panel to save your changes to the non-volatile memory when you are done configuring.
Clear	Click Clear to clear the fields to the factory defaults.
Cancel	Click Cancel to not save the configuration you make and return to the last screen.

CHAPTER 71

BPDU Guard

71.1 BPDU Guard Overview

A BPDU (Bridge Protocol Data Units) is a data frame that contains information about STP. STP-aware switches exchange BPDUs periodically.

The BPDU guard feature allows you to prevent any new STP-aware switch from connecting to an existing network and causing STP topology changes in the network. If there is any BPDU detected on the ports on which BPDU guard is enabled, the Switch disables the ports automatically. You can then enable the ports manually in the **PORT > Port Setup** screen, or use the **SECURITY > Errdisable > Errdisable Recovery** screen (see [Section 73.5 on page 544](#)) to have the ports become active after a certain time interval.

71.2 BPDU Guard Status

Use this screen to view whether BPDU guard is enabled on the Switch and the port status. Click **SECURITY > BPDU Guard > BPDU Guard Status** to view the following screen.

Figure 420 SECURITY > BPDU Guard > BPDU Guard Status (Standalone Mode)

Port	Active	Status
1	OFF	Forwarding
2	OFF	Forwarding
3	OFF	Forwarding
4	OFF	Forwarding
5	OFF	Forwarding
6	OFF	Forwarding
7	OFF	Forwarding

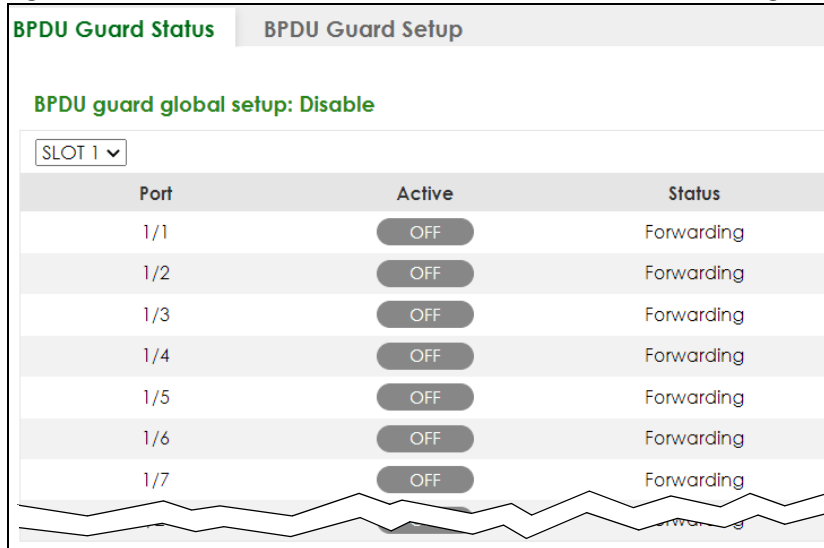
Figure 421 SECURITY > BPDU Guard > BPDU Guard Status (Stacking Mode)

The following table describes the fields in the above screen.

Table 277 SECURITY > BPDU Guard > BPDU Guard Status

LABEL	DESCRIPTION
BPDU guard global setup	This field displays whether BPDU guard is activated on the Switch.
SLOT	This field appears only in Stacking mode. Click the drop-down list to choose the slot number of the Switch in a stack.
Port	This field displays the port number. In Stacking mode, the first number represents the slot ID and the second is the port number. Please note that the default stacking ports (the last four ports of your Switch) cannot be configured. They are reserved for stacking only.
Active	This shows whether BPDU guard is activated on the port.
Status	This shows whether the port is shut down (Err-disable) or able to transmit packets (Forwarding).

71.3 BPDU Guard Setup

Use this screen to turn on the BPDU guard feature on the Switch and ports.

Click **SECURITY > BPDU Guard > BPDU Guard Setup** to display the configuration screen as shown.

Figure 422 SECURITY > BPDU Guard > BPDU Guard Setup (Standalone Mode)

The screenshot shows the 'BPDU Guard Setup' page in Standalone Mode. At the top, there are two tabs: 'BPDU Guard Status' and 'BPDU Guard Setup'. Below the tabs, there is an 'Active' label and a toggle switch currently set to 'OFF'. A table with two columns, 'Port' and 'Active', lists ports from 1 to 7, with a '*' above port 1. Each port has a checkbox in the 'Active' column, all of which are currently unchecked. At the bottom of the page, there are 'Apply' and 'Cancel' buttons.

Port	Active
*	<input type="checkbox"/>
1	<input type="checkbox"/>
2	<input type="checkbox"/>
3	<input type="checkbox"/>
4	<input type="checkbox"/>
5	<input type="checkbox"/>
6	<input type="checkbox"/>
7	<input type="checkbox"/>

Figure 423 SECURITY > BPDU Guard > BPDU Guard Setup (Stacking Mode)

The screenshot shows the 'BPDU Guard Setup' page in Stacking Mode. At the top, there are two tabs: 'BPDU Guard Status' and 'BPDU Guard Setup'. Below the tabs, there is an 'Active' label and a toggle switch currently set to 'OFF'. A dropdown menu is set to 'SLOT 1'. Below the dropdown is a table with two columns, 'Port' and 'Active', listing ports from 1/* to 1/7. Each port has a checkbox in the 'Active' column, all of which are currently unchecked. At the bottom of the page, there are 'Apply' and 'Cancel' buttons.

Port	Active
1/*	<input type="checkbox"/>
1/1	<input type="checkbox"/>
1/2	<input type="checkbox"/>
1/3	<input type="checkbox"/>
1/4	<input type="checkbox"/>
1/5	<input type="checkbox"/>
1/6	<input type="checkbox"/>
1/7	<input type="checkbox"/>

The following table describes the fields in the above screen.

Table 278 SECURITY > BPDU Guard > BPDU Guard Setup

LABEL	DESCRIPTION
Active	Enable the switch button to enable BPDU guard on the Switch.
SLOT	This field appears only in Stacking mode. Click the drop-down list to choose the slot number of the Switch in a stack.

Table 278 SECURITY > BPDU Guard > BPDU Guard Setup (continued)

LABEL	DESCRIPTION
Port	This field displays the port number. In Stacking mode, the first number represents the slot ID and the second is the port number. Please note that the default stacking ports (the last four ports of your Switch) cannot be configured. They are reserved for stacking only.
*	<p>Settings in this row apply to all ports.</p> <p>Use this row only if you want to make some settings the same for all ports. Use this row first to set the common settings and then make adjustments on a port-by-port basis.</p> <p>Note: Changes in this row are copied to all the ports as soon as you make them.</p>
Active	<p>Select this check box to enable the BPDU guard feature on this port. The Switch shuts down this port if there is any BPDU received on the port.</p> <p>Clear this check box to disable the BPDU guard feature.</p>
Apply	Click Apply to save your changes to the Switch's run-time memory. The Switch loses these changes if it is turned off or loses power, so use the Save link on the top navigation panel to save your changes to the non-volatile memory when you are done configuring.
Cancel	Click Cancel to begin configuring this screen afresh.

CHAPTER 72

Storm Control

72.1 Storm Control Overview

This chapter introduces and shows you how to configure the storm control feature.

Storm control limits the number of broadcast, multicast and destination lookup failure (DLF) packets the Switch receives per second on the ports. When the maximum number of allowable broadcast, multicast and/or DLF packets is reached per second, the subsequent packets are discarded. Enable this feature to reduce broadcast, multicast and/or DLF packets in your network. You can specify limits for each packet type on each port.

72.1.1 What You Can Do

Use the **Storm Control** screen ([Section 72.2 on page 535](#)) to limit the number of broadcast, multicast and destination lookup failure (DLF) packets the Switch receives per second on the ports.

72.2 Storm Control Setup

Click **SECURITY > Storm Control** in the navigation panel to display the screen as shown next.

Figure 424 SECURITY > Storm Control (Standalone Mode)

Storm Control

Active OFF

Port	Broadcast (pkt/s)	Multicast (pkt/s)	DLF (pkt/s)
*	<input type="checkbox"/> <input type="text"/>	<input type="checkbox"/> <input type="text"/>	<input type="checkbox"/> <input type="text"/>
1	<input type="checkbox"/> 0	<input type="checkbox"/> 0	<input type="checkbox"/> 0
2	<input type="checkbox"/> 0	<input type="checkbox"/> 0	<input type="checkbox"/> 0
3	<input type="checkbox"/> 0	<input type="checkbox"/> 0	<input type="checkbox"/> 0
4	<input type="checkbox"/> 0	<input type="checkbox"/> 0	<input type="checkbox"/> 0
5	<input type="checkbox"/> 0	<input type="checkbox"/> 0	<input type="checkbox"/> 0
6	<input type="checkbox"/> 0	<input type="checkbox"/> 0	<input type="checkbox"/> 0
7	<input type="checkbox"/> 0	<input type="checkbox"/> 0	<input type="checkbox"/> 0

Figure 425 SECURITY > Storm Control (Stacking Mode)

Storm Control

Active OFF

SLOT 1 ▾

Port	Broadcast (pkt/s)	Multicast (pkt/s)	DLF (pkt/s)
1/*	<input type="checkbox"/> <input type="text"/>	<input type="checkbox"/> <input type="text"/>	<input type="checkbox"/> <input type="text"/>
1/1	<input type="checkbox"/> 0	<input type="checkbox"/> 0	<input type="checkbox"/> 0
1/2	<input type="checkbox"/> 0	<input type="checkbox"/> 0	<input type="checkbox"/> 0
1/3	<input type="checkbox"/> 0	<input type="checkbox"/> 0	<input type="checkbox"/> 0
1/4	<input type="checkbox"/> 0	<input type="checkbox"/> 0	<input type="checkbox"/> 0
1/5	<input type="checkbox"/> 0	<input type="checkbox"/> 0	<input type="checkbox"/> 0
1/6	<input type="checkbox"/> 0	<input type="checkbox"/> 0	<input type="checkbox"/> 0
1/7	<input type="checkbox"/> 0	<input type="checkbox"/> 0	<input type="checkbox"/> 0

The following table describes the labels in this screen.

Table 279 SECURITY > Storm Control

LABEL	DESCRIPTION
Active	Enable the switch button to enable traffic storm control on the Switch. Disable the switch button to disable this feature.
SLOT	This field appears only in Stacking mode. Click the drop-down list to choose the slot number of the Switch in a stack.
Port	This field displays the port number. In Stacking mode, the first number represents the slot ID and the second is the port number. Please note that the default stacking ports (the last four ports of your Switch) cannot be configured. They are reserved for stacking only.
*	<p>Settings in this row apply to all ports.</p> <p>Use this row only if you want to make some settings the same for all ports. Use this row first to set the common settings and then make adjustments on a port-by-port basis.</p> <p>Note: Changes in this row are copied to all the ports as soon as you make them.</p>
Broadcast (pkt/s)	<p>Select this option to enable and specify how many broadcast packets the Switch accepts per second on the port.</p> <p>The Switch will generate a trap and/or log when the actual rate is higher than the specified threshold.</p>
Multicast (pkt/s)	<p>Select this option to enable and specify how many multicast packets the Switch accepts per second on the port.</p> <p>The Switch will generate a trap and/or log when the actual rate is higher than the specified threshold.</p>
DLF (pkt/s)	Select this option and specify how many destination lookup failure (DLF) packets the port receives per second.
Apply	Click Apply to save your changes to the Switch's run-time memory. The Switch loses these changes if it is turned off or loses power, so use the Save link on the top navigation panel to save your changes to the non-volatile memory when you are done configuring.
Cancel	Click Cancel to reset the fields.

CHAPTER 73

Error-Disable

73.1 Error-Disable Overview

This chapter shows you how to configure the rate limit for control packets on a port, and set the Switch to take an action (such as to shut down a port or stop sending packets) on a port when the Switch detects a pre-configured error. It also shows you how to configure the Switch to automatically undo the action after the error is gone.

73.1.1 CPU Protection Overview

Switches exchange protocol control packets in a network to get the latest networking information. If a switch receives large numbers of control packets, such as ARP, BPDU or IGMP packets, which are to be processed by the CPU, the CPU may become overloaded and be unable to handle regular tasks properly.

The CPU protection feature allows you to limit the rate of ARP, BPDU and IGMP packets to be delivered to the CPU on a port. This enhances the CPU efficiency and protects against potential DoS attacks or errors from other networks. You then can choose to drop control packets that exceed the specified rate limit or disable a port on which the packets are received.

73.1.2 Error-Disable Recovery Overview

Some features, such as loop guard or CPU protection, allow the Switch to shut down a port or discard specific packets on a port when an error is detected on the port. For example, if the Switch detects that packets sent out the ports loop back to the Switch, the Switch can shut down the ports automatically. After that, you need to enable the ports or allow the packets on a port manually through the Web Configurator or the commands. With error-disable recovery, you can set the disabled ports to become active or start receiving the packets again after the time interval you specify.

73.1.3 What You Can Do

- Use the **Errdisable Status** screen ([Section 73.2 on page 539](#)) to view whether the Switch detected that control packets exceeded the rate limit configured for a port or a port is disabled according to the feature requirements and what action you configure, and related information.
- Use the **CPU Protection** screen ([Section 73.3 on page 541](#)) to limit the maximum number of control packets (ARP, BPDU and/or IGMP) that the Switch can receive or transmit on a port.
- Use the **Errdisable Detect** screen ([Section 73.4 on page 543](#)) to have the Switch detect whether the control packets exceed the rate limit configured for a port and configure the action to take once the limit is exceeded.
- Use the **Errdisable Recovery** screen ([Section 73.5 on page 544](#)) to set the Switch to automatically undo an action after the error is gone.

73.2 Error-Disable Status

Use this screen to view whether the Switch detected that control packets exceeded the rate limit configured for a port or a port is disabled according to the feature requirements and what action you configure, and related information. Click **SECURITY > Errdisable > Errdisable Status** to display the screen as shown.

Figure 426 SECURITY > Errdisable > Errdisable Status (Standalone Mode)

Errdisable Status
CPU Protection
Errdisable Detect
Errdisable Recovery

Inactive-reason mode reset

Port:

Cause: ARP Reset

Errdisable Status

Port	Cause	Active	Mode	Rate	Status	Recovery Time Left (secs)	Total Dropped
1	Loop Guard	OFF	inactive-port	-	Forwarding	-	-
	ARP	OFF	inactive-port	0	Forwarding	-	-
	BPDU	OFF	inactive-port	0	Forwarding	-	-
	IGMP	OFF	inactive-port	0	Forwarding	-	-
	Anti-arpscan	OFF	inactive-port	-	Forwarding	-	-
	BPDU Guard	OFF	inactive-port	-	Forwarding	-	-
2	ZULD	OFF	inactive-port	-	Forwarding	-	-
	Loop Guard	OFF	inactive-port	-	Forwarding	-	-
	ARP	OFF	inactive-port	0	Forwarding	-	-
	BPDU	OFF	inactive-port	0	Forwarding	-	-
	IGMP	OFF	inactive-port	0	Forwarding	-	-
	Anti-arpscan	OFF	inactive-port	-	Forwarding	-	-
3	BPDU Guard	OFF	inactive-port	-	Forwarding	-	-
	ZULD	OFF	inactive-port	-	Forwarding	-	-
	Loop Guard	OFF	inactive-port	-	Forwarding	-	-
	ARP	OFF	inactive-port	0	Forwarding	-	-
	BPDU	OFF	inactive-port	0	Forwarding	-	-
	IGMP	OFF	inactive-port	0	Forwarding	-	-
	Anti-arpscan	OFF	inactive-port	-	Forwarding	-	-

Figure 427 SECURITY > Errdisable > Errdisable Status (Stacking Mode)

The following table describes the labels in this screen.

Table 280 SECURITY > Errdisable > Errdisable Status

LABEL	DESCRIPTION
Inactive-reason mode reset	
Port	Enter the number of the ports (separated by a comma) on which you want to reset inactive-reason status. In Stacking mode, the first number represents the slot and the second the port number. Enter 1/1-1/24,2/23 for ports 1 to 24 for the Switch in slot 1 and port 23 for the Switch in slot 2, for example.
Cause	Select the cause of inactive-reason mode you want to reset here.
Reset	Click to reset the specified ports to handle ARP, BPDU or IGMP packets instead of ignoring them, if the ports is in inactive-reason mode.
Errdisable Status	

Table 280 SECURITY > Errdisable > Errdisable Status (continued)

LABEL	DESCRIPTION
SLOT	This field appears only in Stacking mode. Click the drop-down list to choose the slot number of the Switch in a stack.
Port	This field displays the port number. In Stacking mode, the first number represents the slot ID and the second is the port number. Please note that the default stacking ports (the last four ports of your Switch) cannot be configured. They are reserved for stacking only.
Cause	This displays the type of the control packet received on the port or the feature enabled on the port and causing the Switch to take the specified action.
Active	This field displays whether the control packets (ARP, BPDU, and/or IGMP) on the port is being detected or not. It also shows whether loop guard, anti-arp scanning, BPDU guard or ZULD is enabled on the port.
Mode	This field shows the action that the Switch takes for the cause. <ul style="list-style-type: none"> • inactive-port – The Switch disables the port. • inactive-reason – The Switch drops all the specified control packets (such as BPDU) on the port. • rate-limitation – The Switch drops the additional control packets the ports has to handle in every one second.
Rate	This field displays how many control packets this port can receive or transmit per second. It can be adjusted in CPU Protection . 0 means no rate limit.
Status	This field displays the errdisable status. <ul style="list-style-type: none"> • Forwarding: The Switch is forwarding packets. Rate-limitation mode is always in Forwarding status. • Err-disable: The Switch disables the port on which the control packets are received (inactive-port) or drops specified control packets on the port (inactive-reason).
Recovery Time Left (secs)	This field displays the time (seconds) left before the ports becomes active of Errdisable Recovery.
Total Dropped	This field displays the total packet number dropped by this port where the packet rate exceeds the rate of mode rate-limitation.

73.3 CPU Protection Setup

Use this screen to limit the maximum number of control packets (ARP, BPDU and/or IGMP) that the Switch can receive or transmit on a port. Click **SECURITY > Errdisable > CPU Protection** to display the screen as shown.

Note: After you configure this screen, make sure you also enable error detection for the specific control packets in the **SECURITY > Errdisable > Errdisable Detect** screen.

Figure 428 SECURITY > Errdisable > CPU Protection (Standalone Mode)

Port	Rate Limit (pkt/s)
*	<input type="text"/>
1	0 <input type="text"/>
2	0 <input type="text"/>
3	0 <input type="text"/>
4	0 <input type="text"/>
5	0 <input type="text"/>
6	0 <input type="text"/>
7	0 <input type="text"/>
8	0 <input type="text"/>

Figure 429 SECURITY > Errdisable > CPU Protection (Stacking Mode)

Port	Rate Limit (pkt/s)
1/*	<input type="text"/>
1/1	0 <input type="text"/>
1/2	0 <input type="text"/>
1/3	0 <input type="text"/>
1/4	0 <input type="text"/>
1/5	0 <input type="text"/>
1/6	0 <input type="text"/>
1/7	0 <input type="text"/>

The following table describes the labels in this screen.

Table 281 SECURITY > Errdisable > CPU Protection

LABEL	DESCRIPTION
Reason	Select the type of control packet you want to configure here.
SLOT	This field appears only in Stacking mode. Click the drop-down list to choose the slot number of the Switch in a stack.

Table 281 SECURITY > Errdisable > CPU Protection (continued)

LABEL	DESCRIPTION
Port	This field displays the port number. In Stacking mode, the first number represents the slot ID and the second is the port number. Please note that the default stacking ports (the last four ports of your Switch) cannot be configured. They are reserved for stacking only.
*	Use this row to make the setting the same for all ports. Use this row first and then make adjustments to each port if necessary. Changes in this row are copied to all the ports as soon as you make them.
Rate Limit (pkt/s)	Enter a number from 0 to 256 to specify how many control packets this port can receive or transmit per second. 0 means no rate limit. You can configure the action that the Switch takes when the limit is exceeded.
Apply	Click Apply to save your changes to the Switch's run-time memory. The Switch loses these changes if it is turned off or loses power, so use the Save link on the top navigation panel to save your changes to the non-volatile memory when you are done configuring.
Cancel	Click Cancel to begin configuring this screen afresh.

73.4 Error-Disable Detect Setup

Use this screen to have the Switch detect whether the control packets exceed the rate limit configured for a port and configure the action to take once the limit is exceeded. Click **SECURITY > Errdisable > Errdisable Detect** to display the screen as shown.

Figure 430 SECURITY > Errdisable > Errdisable Detect

Cause	Active	Mode
*	<input type="checkbox"/>	inactive-port ▼
ARP	<input type="checkbox"/>	inactive-port ▼
BPDU	<input type="checkbox"/>	inactive-port ▼
IGMP	<input type="checkbox"/>	inactive-port ▼

The following table describes the labels in this screen.

Table 282 SECURITY > Errdisable > Errdisable Detect

LABEL	DESCRIPTION
Cause	This field displays the types of control packet that may cause CPU overload.
*	Use this row to make the setting the same for all entries. Use this row first and then make adjustments to each entry if necessary. Changes in this row are copied to all the entries as soon as you make them.
Active	Select this option to have the Switch detect if the configured rate limit for a specific control packet is exceeded and take the action selected below.

Table 282 SECURITY > Errdisable > Errdisable Detect (continued)

LABEL	DESCRIPTION
Mode	Select the action that the Switch takes when the number of control packets exceed the rate limit on a port, set in the SECURITY > Errdisable > CPU Protection screen. <ul style="list-style-type: none"> inactive-port – The Switch disables the port on which the control packets are received. inactive-reason – The Switch drops all the specified control packets (such as BPDU) on the port. rate-limitation – The Switch drops the additional control packets the ports has to handle in every one second.
Apply	Click Apply to save your changes to the Switch's run-time memory. The Switch loses these changes if it is turned off or loses power, so use the Save link on the top navigation panel to save your changes to the non-volatile memory when you are done configuring.
Cancel	Click Cancel to begin configuring this screen afresh.

73.5 Error-Disable Recovery Setup

Use this screen to configure the Switch to automatically undo an action after the error is gone. Click **SECURITY > Errdisable > Errdisable Recovery** to display the screen as shown.

Figure 431 SECURITY > Errdisable > Errdisable Recovery

Reason	Time Status	Interval
*	<input type="checkbox"/>	<input type="text"/>
loopguard	<input type="checkbox"/>	300
ARP	<input type="checkbox"/>	300
BPDU	<input type="checkbox"/>	300
IGMP	<input type="checkbox"/>	300
anti-arp scan	<input type="checkbox"/>	300
bpduguard	<input type="checkbox"/>	300
zuld	<input type="checkbox"/>	300

The following table describes the labels in this screen.

Table 283 SECURITY > Errdisable > Errdisable Recovery

LABEL	DESCRIPTION
Active	Enable the switch button to turn on the error-disable recovery function on the Switch.
Reason	This field displays the supported features that allow the Switch to shut down a port or discard packets on a port according to the feature requirements and what action you configure.
*	Use this row to make the setting the same for all entries. Use this row first and then make adjustments to each entry if necessary. Changes in this row are copied to all the entries as soon as you make them.

Table 283 SECURITY > Errdisable > Errdisable Recovery (continued)

LABEL	DESCRIPTION
Time Status	Select this check box to allow the Switch to wait for the specified time interval to activate a port or allow specific packets on a port, after the error was gone. Clear the check box to turn off this rule.
Interval	Enter the number of seconds (from 30 to 2592000) for the time interval.
Apply	Click Apply to save your changes to the Switch's run-time memory. The Switch loses these changes if it is turned off or loses power, so use the Save link on the top navigation panel to save your changes to the non-volatile memory when you are done configuring.
Cancel	Click Cancel to begin configuring this screen afresh.

CHAPTER 74

IP Source Guard

74.1 IP Source Guard Overview

IP source guard consists of the following features:

- DHCP snooping. Use this to filter unauthorized DHCP server packets on the network and to build a binding table dynamically.
- ARP inspection. Use this to filter unauthorized ARP packets on the network.
- Static IP bindings. Use this to create static bindings in the binding table.

The Switch builds the binding table by snooping DHCP packets (dynamic bindings) and from information provided manually by administrators (static bindings).

Binding Table

IP source guard uses a binding table to distinguish between authorized and unauthorized ARP packets in your network. A binding contains these key attributes:

- MAC address
- VLAN ID
- IP address
- Port number

The Switch builds the binding table by snooping DHCP packets (dynamic bindings) and from information provided manually by administrators (static bindings).

DHCP Snooping

The Switch only allows an authorized DHCP server on a trusted port to assign IP addresses. Unauthorized DHCP servers will not be able to assign IP addresses to network clients. When the Switch receives a DHCP server packet from an authorized DHCP server, it inspects the packet and records the DHCP information in a binding table. The binding records are used in ARP inspection to filter unauthorized ARP packets. See [Section 75.1 on page 551](#) for more DHCP snooping information.

ARP Inspection

When the Switch receives an ARP packet, it looks up the appropriate MAC address, VLAN ID, IP address, and port number in the binding table. If there is a binding, the Switch forwards the packet. Otherwise, the Switch discards the packet.

If you want to use dynamic bindings to filter unauthorized ARP packets (typical implementation), you have to enable DHCP snooping before you enable ARP inspection.

The following figure demonstrates a scenario with DHCP snooping and ARP inspection enabled. In this scenario, we connect an authorized DHCP server (**A**) and the client devices on the ARP trusted ports (**T**). A client device (**B**) is assigned the IP address 192.168.1.56 by the authorized DHCP server (**A**). A malicious host (**C**) on an untrusted port (**UT**) puts a wrong MAC address with the IP address 192.168.1.56 in an ARP reply packet pretending to be client device (**B**) (192.168.1.56). The Switch snoops DHCP packets sent from the authorized DHCP server (**A**) and creates bindings in the binding table. When the Switch receives ARP packets from an untrusted port (**UT**), it compares the IP and MAC addresses with the existing bindings. Since the IP and MAC binding is different from the existing bindings, the Switch blocks the unauthorized ARP packets sent from the malicious host (**C**). The malicious host (**C**) therefore cannot disguise as client device (**B**) to build connections with other client devices on your network.

Figure 432 IP Source Guard Example Application

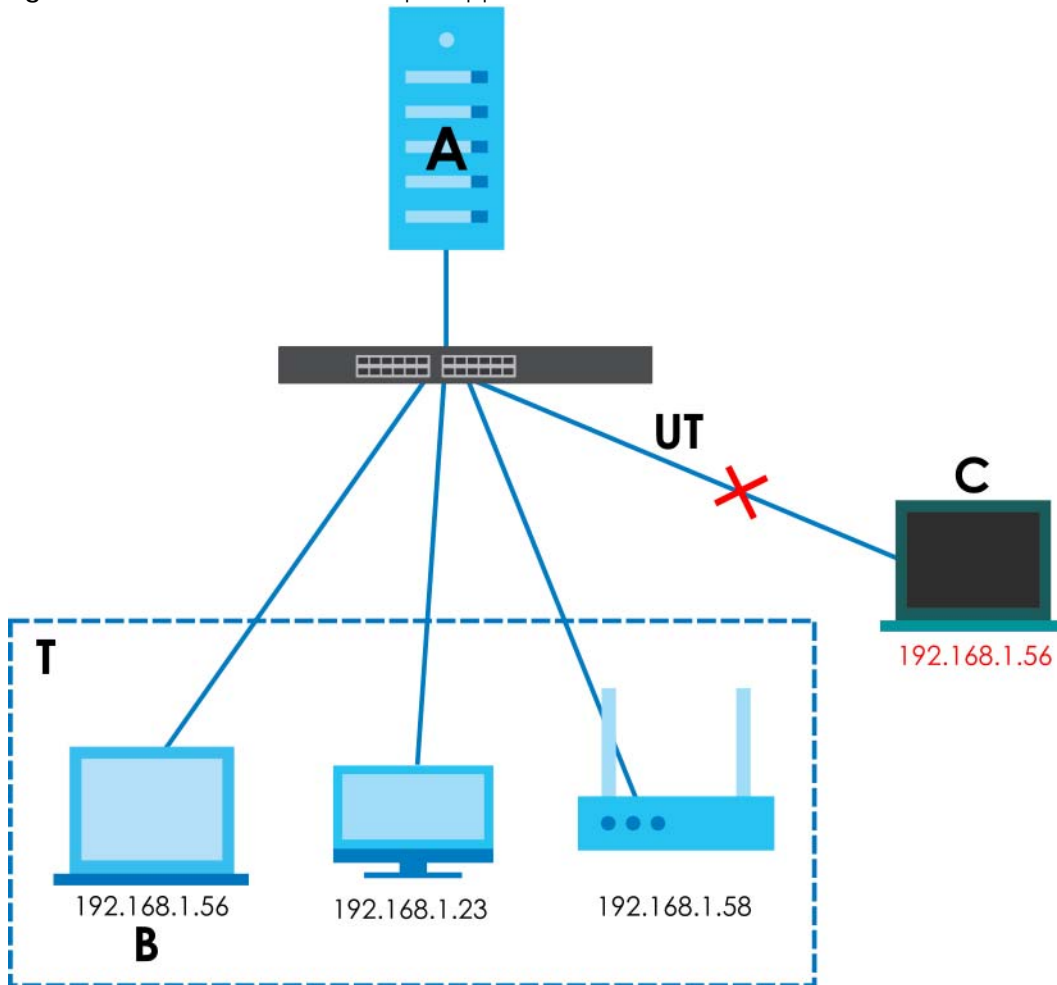

74.1.1 What You Can Do

- Use the **IPv4 Source Guard** screen (Section 74.2 on page 548) to look at the current bindings for DHCP snooping and ARP inspection.
- Use the **IPv4 Source Guard Static Binding** screen (Section 74.3 on page 548) to manage static bindings for DHCP snooping and ARP inspection.

74.2 IPv4 Source Guard

Use this screen to look at the current bindings for DHCP snooping and ARP inspection. Bindings are used by ARP inspection to distinguish between authorized and unauthorized ARP packets in the network. The Switch learns the bindings by snooping DHCP packets (dynamic bindings) and from information provided manually by administrators (static bindings). To open this screen, click **SECURITY > IPv4 Source Guard > IP Source Guard**.

Figure 433 SECURITY > IPv4 Source Guard > IP Source Guard

IP Source Guard		Static Binding				
Index	IP Address	VID	MAC Address	Port	Lease	Type

The following table describes the labels in this screen.

Table 284 SECURITY > IPv4 Source Guard > IP Source Guard

LABEL	DESCRIPTION
Index	This field displays a sequential number for each binding.
IP Address	This field displays the IP address assigned to the MAC address in the binding.
VID	This field displays the source VLAN ID in the binding.
MAC Address	This field displays the source MAC address in the binding.
Port	This field displays the port number in the binding. If this field is blank, the binding applies to all ports. In Stacking mode, the first number represents the slot ID and the second is the port number.
Lease	This field displays how many days, hours, minutes, and seconds the binding is valid; for example, 2d3h4m5s means the binding is still valid for 2 days, 3 hours, 4 minutes, and 5 seconds. This field displays infinity if the binding is always valid (for example, a static binding).
Type	This field displays how the Switch learned the binding. static : This binding was learned from information provided manually by an administrator. dhcp-snooping : This binding was learned by snooping DHCP packets.

74.3 IPv4 Source Guard Static Binding

Use this screen to manage static bindings for DHCP snooping and ARP inspection. Static bindings are uniquely identified by the MAC address and VLAN ID. Each MAC address and VLAN ID can only be in one static binding. If you try to create a static binding with the same MAC address and VLAN ID as an existing static binding, the new static binding replaces the original one. To open this screen, click **SECURITY > IPv4 Source Guard > IP Source Guard > Static Binding**.

Figure 434 SECURITY > IPv4 Source Guard > IP Source Guard > Static Binding

The following table describes the labels in this screen.

Table 285 SECURITY > IPv4 Source Guard > IP Source Guard > Static Binding

LABEL	DESCRIPTION
ARP Freeze	<p>ARP Freeze allows you to automatically create static bindings from the current ARP entries (either dynamically learned or static ARP entries) until the Switch's binding table is full.</p> <p>Note: The ARP learning mode should be set to ARP-Request in the NETWORKING > ARP Setup > ARP Learning screen before you use the ARP Freeze feature.</p>
Condition	<p>All – Select this and click ARP Freeze to have the Switch automatically add all the current ARP entries to the static bindings table.</p> <p>Port List – Select this and enter the number of the ports (separated by a comma).</p> <p>You can enter multiple ports separated by (no space) comma (,) or hyphen (-) for a range. For example, enter "3-5" for ports 3, 4, and 5. Enter "3,5,7" for ports 3, 5, and 7.</p> <p>In Stacking mode, the first number represents the slot ID and the second is the port number. Enter "1/1-1/24,2/23" for ports 1 to 24 for the Switch in slot 1 and port 23 for the Switch in slot 2, for example.</p> <p>ARP entries learned on the specified ports are added to the static bindings table after you click ARP Freeze.</p> <p>VLAN List – Select this and enter the ID number of the VLANs (separated by a comma). ARP entries for the specified VLANs are added to the static bindings table after you click ARP Freeze.</p>
Static Binding	
Index	This field displays a sequential number for each binding.
IP Address	This field displays the IP address assigned to the MAC address in the binding.
VID	This field displays the source VLAN ID in the binding.
MAC Address	This field displays the source MAC address in the binding.
Port	This field displays the port number. In Stacking mode, the first number represents the slot ID and the second is the port number.
Lease	This field displays how long the binding is valid.
Type	<p>This field displays how the Switch learned the binding.</p> <p>Static: This binding was learned from information provided manually by an administrator.</p>
	Select an entry's check box to select a specific entry. Otherwise, select the check box in the table heading row to select all entries.
Add/Edit	Click Add/Edit to add a new entry or edit a selected one.
Delete	Click Delete to remove the selected entries.

74.3.1 Add/Edit IPv4 Source Guard Static Binding

Use this screen to manage static bindings for DHCP snooping and ARP inspection. Static bindings are uniquely identified by the MAC address and VLAN ID. Each MAC address and VLAN ID can only be in one static binding. If you try to create a static binding with the same MAC address and VLAN ID as an existing static binding, the new static binding replaces the original one. Click **Add/Edit**, or select an entry and click **Add/Edit** in the **SECURITY > IPv4 Source Guard > IP Source Guard > Static Binding** screen to display this screen.

Figure 435 SECURITY > IPv4 Source Guard > IP Source Guard > Static Binding > Add/Edit (Standalone Mode)

Figure 436 SECURITY > IPv4 Source Guard > IP Source Guard > Static Binding > Add/Edit (Stacking Mode)

The following table describes the labels in this screen.

Table 286 SECURITY > IPv4 Source Guard > IP Source Guard > Static Binding > Add/Edit

LABEL	DESCRIPTION
IP Address	Enter the IP address assigned to the MAC address in the binding.
VLAN	Enter the source VLAN ID in the binding.
MAC Address	Enter the source MAC address in the binding. If this binding applies to all MAC addresses, select Any .
Port	Specify the ports in the binding. If this binding has one port, select the first radio button and enter the port number in the field to the right. In Stacking mode, the first field is the slot ID and the second field is the port number. If this binding applies to all ports, select Any .
Apply	Click Apply to save your changes to the Switch's run-time memory. The Switch loses these changes if it is turned off or loses power, so use the Save link on the top navigation panel to save your changes to the non-volatile memory when you are done configuring.
Clear	Click Clear to clear the fields to the factory defaults.
Cancel	Click Cancel to not save the configuration you make and return to the last screen.

CHAPTER 75

DHCP Snooping

75.1 DHCP Snooping Overview

DHCP snooping filters unauthorized DHCP server packets. The Switch allows only the authorized DHCP server on a trusted port to assign IP addresses. Clients on your network will only receive DHCP packets from the authorized DHCP server.

The Switch also builds a DHCP snooping binding table dynamically by snooping DHCP packets (dynamic bindings). A DHCP snooping binding table contains the IP binding information the Switch learns from DHCP packets in your network. A binding contains these key attributes:

- MAC address
- VLAN ID
- IP address
- Port number

The following settings demonstrates DHCP snooping on the Switch.

- An authorized DHCP server (A) on a snooped VLAN from the trusted port (T)
- An unauthorized DHCP server (B) on a snooped VLAN from an untrusted port (UT)
- DHCP clients (C) on the untrusted ports (UT).

With DHCP snooping, the Switch blocks all DHCP server packets (DHCP OFFER/ACK) coming from the untrusted ports (UT). The Switch only forwards the DHCP server packets from the trusted port (T). This assures that DHCP clients on your network only receive IP addresses assigned by the authorized DHCP server (A).

Figure 437 DHCP Snooping Example Application

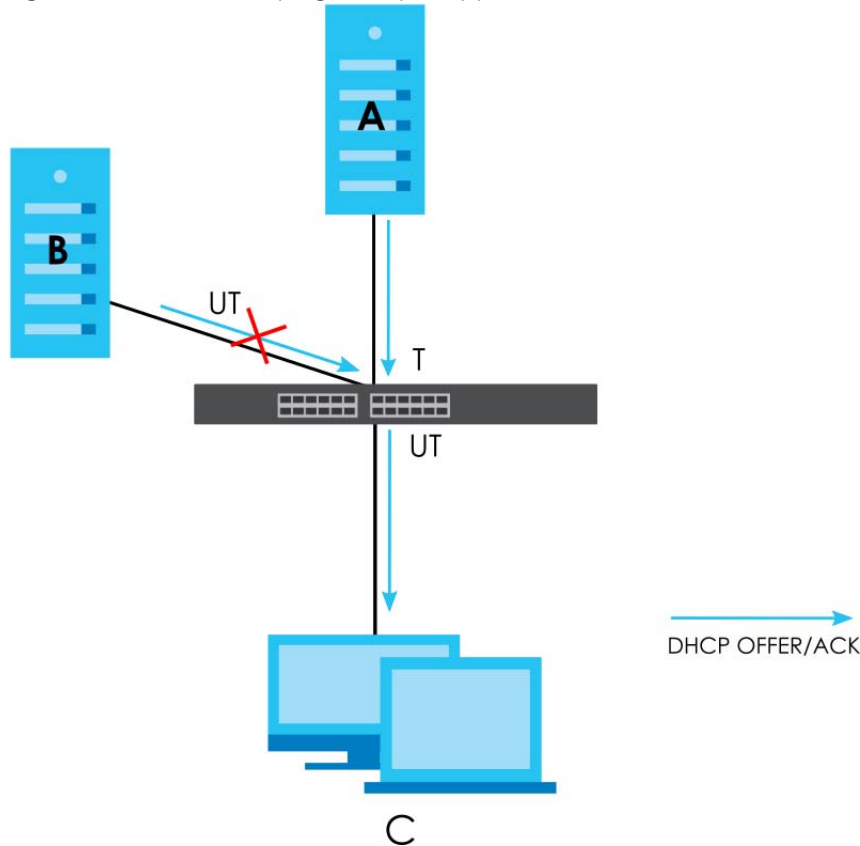

75.1.1 What You Can Do

- Use the **DHCP Snooping Status** screen ([Section 75.2 on page 552](#)) to look at various statistics about the DHCP snooping database.
- Use this **DHCP Snooping Setup** screen ([Section 75.3 on page 555](#)) to enable DHCP snooping on the Switch (not on specific VLAN), specify the VLAN where the default DHCP server is located, and configure the DHCP snooping database.
- Use the **DHCP Snooping Port Setup** screen ([Section 75.4 on page 556](#)) to specify whether ports are trusted or untrusted ports for DHCP snooping.
- Use the **DHCP Snooping VLAN Setup** screen ([Section 75.5 on page 558](#)) to enable DHCP snooping on each VLAN and to specify whether or not the Switch adds DHCP relay agent option 82 information to DHCP requests that the Switch relays to a DHCP server for each VLAN.
- Use the **DHCP Snooping VLAN Port Setup** screen ([Section 75.6 on page 559](#)) to apply a different DHCP option 82 profile to certain ports in a VLAN.

75.2 DHCP Snooping Status

Use this screen to look at various statistics about the DHCP snooping database.

To open this screen, click **SECURITY > DHCP Snooping > DHCP Snp. Status**.

Figure 438 SECURITY > DHCP Snooping > DHCP Snp. Status

DHCP Snp. Status		DHCP Snp. Setup	DHCP Snp. Port Setup	DHCP Snp. VLAN Setup	DHCP Snp. VLAN Port Setup
DHCP Snooping					
Database Status			Database Detail		
Agent URL			First Successful Access	None	
Write Delay Timer	300		Last Ignored Bindings Counters		
Abort Timer	300		Binding Collisions	0	
Agent Running	None		Invalid Interfaces	0	
Delay Timer Expiry	Not Running		Parse Failures	0	
Abort Timer Expiry	Not Running		Expired Leases	0	
Last Succeeded Time	None		Unsupported VLANs	0	
Last Failed Time	None		Last Ignored Time	None	
Last Failed Reason	No failure recorded		Total Ignored Bindings Counters		
Counters			Binding Collisions	0	
Total Attempts	0		Invalid Interfaces	0	
Startup Failures	0		Parse Failures	0	
Successful Transfers	0		Expired Leases	0	
Failed Transfers	0		Unsupported VLANs	0	
Successful Reads	0				
Failed Reads	0				
Successful Writes	0				
Failed Writes	0				

The following table describes the labels in this screen.

Table 287 SECURITY > DHCP Snooping > DHCP Snp. Status

LABEL	DESCRIPTION
Database Status	
This section displays the current settings for the DHCP snooping database. You can configure them in the SECURITY > DHCP Snooping > DHCP Snp. Setup screen.	
Agent URL	This field displays the location of the DHCP snooping database.
Write Delay Timer	This field displays how long (in seconds) the Switch tries to complete a specific update in the DHCP snooping database before it gives up.
Abort Timer	This field displays how long (in seconds) the Switch waits to update the DHCP snooping database after the current bindings change.
Agent Running	This field displays the status of the current update or access of the DHCP snooping database. None: The Switch is not accessing the DHCP snooping database. Read: The Switch is loading dynamic bindings from the DHCP snooping database. Write: The Switch is updating the DHCP snooping database.
Delay Timer Expiry	This field displays how much longer (in seconds) the Switch tries to complete the current update before it gives up. It displays Not Running if the Switch is not updating the DHCP snooping database right now.
Abort Timer Expiry	This field displays when (in seconds) the Switch is going to update the DHCP snooping database again. It displays Not Running if the current bindings have not changed since the last update.
Last Succeeded Time	This field displays the last time the Switch updated the DHCP snooping database successfully.
Last Failed Time	This field displays the last time the Switch updated the DHCP snooping database unsuccessfully.

Table 287 SECURITY > DHCP Snooping > DHCP Snp. Status (continued)

LABEL	DESCRIPTION
Last Failed Reason	This field displays the reason the Switch updated the DHCP snooping database unsuccessfully.
<p>Counters</p> <p>This section displays historical information about the number of times the Switch successfully or unsuccessfully read or updated the DHCP snooping database.</p>	
Total Attempts	This field displays the number of times the Switch has tried to access the DHCP snooping database for any reason.
Startup Failures	This field displays the number of times the Switch could not create or read the DHCP snooping database when the Switch started up or a new URL is configured for the DHCP snooping database.
Successful Transfers	This field displays the number of times the Switch read bindings from or updated the bindings in the DHCP snooping database successfully.
Failed Transfers	This field displays the number of times the Switch was unable to read bindings from or update the bindings in the DHCP snooping database.
Successful Reads	This field displays the number of times the Switch read bindings from the DHCP snooping database successfully.
Failed Reads	This field displays the number of times the Switch was unable to read bindings from the DHCP snooping database.
Successful Writes	This field displays the number of times the Switch updated the bindings in the DHCP snooping database successfully.
Failed Writes	This field displays the number of times the Switch was unable to update the bindings in the DHCP snooping database.
Database Detail	
First Successful Access	This field displays the first time the Switch accessed the DHCP snooping database for any reason.
<p>Last Ignored Bindings Counters</p> <p>This section displays the number of times and the reasons the Switch ignored bindings the last time it read bindings from the DHCP binding database. You can clear these counters by restarting the Switch or using CLI commands. See the Ethernet Switch CLI Reference Guide.</p>	
Binding Collisions	This field displays the number of bindings the Switch ignored because the Switch already had a binding with the same MAC address and VLAN ID.
Invalid Interfaces	This field displays the number of bindings the Switch ignored because the port number was a trusted interface or does not exist anymore.
Parse Failures	This field displays the number of bindings the Switch ignored because the Switch was unable to understand the binding in the DHCP binding database.
Expired Leases	This field displays the number of bindings the Switch ignored because the lease time had already expired.
Unsupported VLANs	This field displays the number of bindings the Switch ignored because the VLAN ID does not exist anymore.
Last Ignored Time	This field displays the last time the Switch ignored any bindings for any reason from the DHCP binding database.
<p>Total Ignored Bindings Counters</p> <p>This section displays the reasons the Switch has ignored bindings any time it read bindings from the DHCP binding database. You can clear these counters by restarting the Switch or using CLI commands. See the Ethernet Switch CLI Reference Guide.</p>	
Binding Collisions	This field displays the number of bindings the Switch has ignored because the Switch already had a binding with the same MAC address and VLAN ID.
Invalid Interfaces	This field displays the number of bindings the Switch has ignored because the port number was a trusted interface or does not exist anymore.

Table 287 SECURITY > DHCP Snooping > DHCP Snp. Status (continued)

LABEL	DESCRIPTION
Parse Failures	This field displays the number of bindings the Switch has ignored because the Switch was unable to understand the binding in the DHCP binding database.
Expired Leases	This field displays the number of bindings the Switch has ignored because the lease time had already expired.
Unsupported VLANs	This field displays the number of bindings the Switch has ignored because the VLAN ID does not exist anymore.

75.3 DHCP Snooping Setup

Use this screen to enable DHCP snooping on the Switch (not on specific VLAN), specify the VLAN where the default DHCP server is located, and configure the DHCP snooping database. The DHCP snooping database stores the current bindings on a secure, external TFTP server so that they are still available after a restart.

To open this screen, click **SECURITY > DHCP Snooping > DHCP Snp. Setup**.

Note: The input string of any field in this screen should not contain [?], [|], ['], ["], or [,].

Figure 439 SECURITY > DHCP Snooping > DHCP Snp. Setup

The following table describes the labels in this screen.

Table 288 SECURITY > DHCP Snooping > DHCP Snp. Setup

LABEL	DESCRIPTION
DHCP Snooping Setup	
Active	Enable the switch button to enable DHCP snooping on the Switch. You still have to enable DHCP snooping on specific VLAN and specify trusted ports. Note: If DHCP is enabled and there are no trusted ports, DHCP requests will not succeed.

Table 288 SECURITY > DHCP Snooping > DHCP Snp. Setup (continued)

LABEL	DESCRIPTION
DHCP VLAN	<p>Select a VLAN ID if you want the Switch to forward DHCP packets to DHCP servers on a specific VLAN.</p> <p>Note: You have to enable DHCP snooping on the DHCP VLAN too.</p> <p>You can enable Option 82 Profile in the SECURITY > DHCP Snooping > DHCP Snp. VLAN Setup screen to help the DHCP servers distinguish between DHCP requests from different VLAN.</p> <p>Select Disable if you do not want the Switch to forward DHCP packets to a specific VLAN.</p>
<p>Database</p> <p>If Timeout Interval is greater than Write Delay Interval, it is possible that the next update is scheduled to occur before the current update has finished successfully or timed out. In this case, the Switch waits to start the next update until it completes the current one.</p>	
Agent URL	Enter the location of the DHCP snooping database. The location should be expressed like this: ftp://{domain name or IP address}/directory, if applicable/file name ; for example, ftp://192.168.10.1/database.txt . You can enter up to 256 printable ASCII characters except [?], [], ['], ["] or [.] .
Timeout Interval	Enter how long (10 – 65535 seconds) the Switch tries to complete a specific update in the DHCP snooping database before it gives up.
Write Delay Interval	Enter how long (10 – 65535 seconds) the Switch waits to update the DHCP snooping database the first time the current bindings change after an update. Once the next update is scheduled, additional changes in current bindings are automatically included in the next update.
Renew DHCP Snooping URL	<p>Enter the location of a DHCP snooping database, and click Renew if you want the Switch to load it. You can use this to load dynamic bindings from a different DHCP snooping database than the one specified in Agent URL.</p> <p>When the Switch loads dynamic bindings from a DHCP snooping database, it does not discard the current dynamic bindings first. If there is a conflict, the Switch keeps the dynamic binding in volatile memory and updates the Binding Collisions counter in the DHCP Snooping Status screen (Section 75.2 on page 552).</p>
Apply	Click Apply to save your changes to the Switch's run-time memory. The Switch loses these changes if it is turned off or loses power, so use the Save link on the top navigation panel to save your changes to the non-volatile memory when you are done configuring.
Cancel	Click this to reset the values in this screen to their last-saved values.

75.4 DHCP Snooping Port Setup

Use this screen to specify whether ports are trusted or untrusted ports for DHCP snooping.

Note: If DHCP snooping is enabled but there are no trusted ports, DHCP requests cannot reach the DHCP server.

Note: The Switch will drop all DHCP requests if you enable DHCP snooping and there are no trusted ports.

You can also specify the maximum number for DHCP packets that each port (trusted or untrusted) can receive each second.

To open this screen, click **SECURITY > DHCP Snooping > DHCP Snp. Port Setup**.

Figure 440 SECURITY > DHCP Snooping > DHCP Snp. Port Setup (Standalone Mode)

Port	Server Trusted State	Rate (pps)
*	Untrusted ▼	<input type="text"/>
1	Untrusted ▼	0 <input type="text"/>
2	Untrusted ▼	0 <input type="text"/>
3	Untrusted ▼	0 <input type="text"/>
4	Untrusted ▼	0 <input type="text"/>
5	Untrusted ▼	0 <input type="text"/>
6	Untrusted ▼	0 <input type="text"/>
7	Untrusted ▼	0 <input type="text"/>

Figure 441 SECURITY > DHCP Snooping > DHCP Snp. Port Setup (Stacking Mode)

SLOT 1 ▼

Port	Server Trusted State	Rate (pps)
1/*	Untrusted ▼	<input type="text"/>
1/1	Untrusted ▼	0 <input type="text"/>
1/2	Untrusted ▼	0 <input type="text"/>
1/3	Untrusted ▼	0 <input type="text"/>
1/4	Untrusted ▼	0 <input type="text"/>
1/5	Untrusted ▼	0 <input type="text"/>
1/6	Untrusted ▼	0 <input type="text"/>
1/7	Untrusted ▼	0 <input type="text"/>

The following table describes the labels in this screen.

Table 289 SECURITY > DHCP Snooping > DHCP Snp. Port Setup

LABEL	DESCRIPTION
SLOT	This field appears only in Stacking mode. Click the drop-down list to choose the slot number of the Switch in a stack.
Port	This field displays the port number. In Stacking mode, the first number represents the slot ID and the second is the port number. Please note that the default stacking ports (the last four ports of your Switch) cannot be configured. They are reserved for stacking only.

Table 289 SECURITY > DHCP Snooping > DHCP Snp. Port Setup (continued)

LABEL	DESCRIPTION
*	<p>Settings in this row apply to all ports.</p> <p>Use this row only if you want to make some settings the same for all ports. Use this row first to set the common settings and then make adjustments on a port-by-port basis.</p> <p>Note: Changes in this row are copied to all the ports as soon as you make them.</p>
Server Trusted state	<p>Select whether this port is a trusted port (Trusted) or an untrusted port (Untrusted).</p> <p>Trusted ports are connected to DHCP servers or other switches, and the Switch discards DHCP packets from trusted ports only if the rate at which DHCP packets arrive is too high.</p> <p>Untrusted ports are connected to subscribers, and the Switch discards DHCP packets from untrusted ports in the following situations:</p> <ul style="list-style-type: none"> • The packet is a DHCP server packet (for example, OFFER, ACK, or NACK). • The source MAC address and source IP address in the packet do not match any of the current bindings. • The packet is a RELEASE or DECLINE packet, and the source MAC address and source port do not match any of the current bindings. • The rate at which DHCP packets arrive is too high.
Rate (pps)	<p>Specify the maximum number for DHCP packets (1 – 2048) that the Switch receives from each port each second. The Switch discards any additional DHCP packets. Enter 0 to disable this limit, which is recommended for trusted ports.</p>
Apply	<p>Click Apply to save your changes to the Switch's run-time memory. The Switch loses these changes if it is turned off or loses power, so use the Save link on the top navigation panel to save your changes to the non-volatile memory when you are done configuring.</p>
Cancel	<p>Click this to reset the values in this screen to their last-saved values.</p>

75.5 DHCP Snooping VLAN Setup

Use this screen to enable DHCP snooping on each VLAN and to specify whether or not the Switch adds DHCP relay agent option 82 information to DHCP requests that the Switch relays to a DHCP server for each VLAN.

To open this screen, click **SECURITY > DHCP Snooping > DHCP Snp. VLAN Setup**.

Figure 442 SECURITY > DHCP Snooping > DHCP Snp. VLAN Setup

The following table describes the labels in this screen.

Table 290 SECURITY > DHCP Snooping > DHCP Snp. VLAN Setup

LABEL	DESCRIPTION
Search VLAN by VID	Enter the VLAN ID you want to manage. Use a comma (,) to separate individual VLANs or a hyphen (-) to indicates a range of VLANs. For example, "3,4" or "3-9".
Search	Click this to display the specified range of VLANs in the section below.
The Number of VLANs	This displays the number of VLAN search results.
VID	This field displays the VLAN ID of each VLAN in the range specified above. If you configure the * VLAN, the settings are applied to all VLANs.
Enabled	Select Yes to enable DHCP snooping on the VLAN. You still have to enable DHCP snooping on the Switch and specify trusted ports. Note: The Switch will drop all DHCP requests if you enable DHCP snooping and there are no trusted ports.
Option 82 Profile	Select a pre-defined DHCP option 82 profile that the Switch applies to all ports in the specified VLANs. The Switch adds the information (such as slot number, port number, VLAN ID and/or system name) specified in the profile to DHCP requests that it broadcasts to the DHCP VLAN, if specified, or VLAN. You can specify the DHCP VLAN in the SECURITY > DHCP Snooping > DHCP Snp. Setup screen.
Apply	Click Apply to save your changes to the Switch's run-time memory. The Switch loses these changes if it is turned off or loses power, so use the Save link on the top navigation panel to save your changes to the non-volatile memory when you are done configuring.
Cancel	Click this to reset the values in this screen to their last-saved values.

75.6 DHCP Snooping VLAN Port Setup

Use this screen to apply a different DHCP option 82 profile to certain ports in a VLAN.

To open this screen, click **SECURITY > DHCP Snooping > DHCP Snp. VLAN Port Setup**.

Figure 443 SECURITY > DHCP Snooping > DHCP Snp. VLAN Port Setup

The following table describes the labels in this screen.

Table 291 SECURITY > DHCP Snooping > DHCP Snp. VLAN Port Setup

LABEL	DESCRIPTION
Index	This field displays a sequential number for each entry.
VID	This field displays the VLAN to which the ports belongs.
Port	This field displays the ports to which the Switch applies the settings. In Stacking mode, the first number represents the slot and the second the port number.
Profile Name	This field displays the DHCP option 82 profile that the Switch applies to the ports.
Add/Edit	Click Add/Edit to add a new entry or edit a selected one.
Delete	Click Delete to remove the selected entries.

75.6.1 Add/EDIT DHCP Snooping VLAN Ports

Use this screen to apply a different DHCP option 82 profile to certain ports in a VLAN.

Click **Add/Edit**, or select an entry and click **Add/Edit** in the **SECURITY > DHCP Snooping > DHCP Snp. VLAN Port Setup** screen to display this screen.

Figure 444 SECURITY > DHCP Snooping > DHCP Snp. VLAN Port Setup > Add/Edit

The following table describes the labels in this screen.

Table 292 SECURITY > DHCP Snooping > DHCP Snp. VLAN Port Setup > Add/Edit

LABEL	DESCRIPTION
VID	Enter the ID number of the VLAN you want to configure here.
Port	Enter the number of ports to which you want to apply the specified DHCP option 82 profile. You can enter multiple ports separated by (no space) comma (,) or hyphen (-) for a range. For example, enter "3-5" for ports 3, 4, and 5. Enter "3,5,7" for ports 3, 5, and 7. In Stacking mode, the first number represents the slot and the second the port number. Enter 1/1-1/24,2/23 for ports 1 to 24 for the Switch in slot 1 and port 23 for the Switch in slot 2, for example.

Table 292 SECURITY > DHCP Snooping > DHCP Snp. VLAN Port Setup > Add/Edit (continued)

LABEL	DESCRIPTION
Option 82 Profile	Select a pre-defined DHCP option 82 profile that the Switch applies to the specified ports in this VLAN. The Switch adds the information (such as slot number, port number, VLAN ID and/or system name) specified in the profile to DHCP requests that it broadcasts to the DHCP VLAN, if specified, or VLAN. You can specify the DHCP VLAN in the SECURITY > DHCP Snooping > DHCP Snp. Setup screen. Note: The profile you select here has priority over the one you select in the SECURITY > DHCP Snooping > DHCP Snp. VLAN Setup screen.
Apply	Click Apply to save your changes to the Switch's run-time memory. The Switch loses these changes if it is turned off or loses power, so use the Save link on the top navigation panel to save your changes to the non-volatile memory when you are done configuring.
Clear	Click Clear to clear the fields to the factory defaults.
Cancel	Click Cancel to not save the configuration you make and return to the last screen.

75.7 Technical Reference

This section provides technical background information on the topics discussed in this chapter.

75.7.1 DHCP Snooping Overview

Use DHCP snooping to filter unauthorized DHCP packets on the network and to build the binding table dynamically. This can prevent clients from getting IP addresses from unauthorized DHCP servers.

75.7.1.1 Trusted vs. Untrusted Ports

Every port is either a trusted port or an untrusted port for DHCP snooping. This setting is independent of the trusted or untrusted setting for ARP inspection. You can also specify the maximum number for DHCP packets that each port (trusted or untrusted) can receive each second.

Trusted ports are connected to DHCP servers or other switches. The Switch discards DHCP packets from trusted ports only if the rate at which DHCP packets arrive is too high. The Switch learns dynamic bindings from trusted ports.

Note: If DHCP is enabled and there are no trusted ports, DHCP requests will not succeed.

Untrusted ports are connected to subscribers. The Switch discards DHCP packets from untrusted ports in the following situations:

- The packet is a DHCP server packet (for example, OFFER, ACK, or NACK).
- The rate at which DHCP packets arrive is too high.

75.7.1.2 DHCP Snooping Database

The Switch stores the binding table in volatile memory. If the Switch restarts, it loads static bindings from permanent memory but loses the dynamic bindings, in which case the devices in the network have to send DHCP requests again. As a result, it is recommended you configure the DHCP snooping database.

The DHCP snooping database maintains the dynamic bindings for DHCP snooping and ARP inspection in a file on an external TFTP server. If you set up the DHCP snooping database, the Switch can reload the dynamic bindings from the DHCP snooping database after the Switch restarts.

You can configure the name and location of the file on the external TFTP server. The file has the following format:

Figure 445 DHCP Snooping Database File Format

```
<initial-checksum>
TYPE DHCP-SNOOPING
VERSION 1
BEGIN
<binding-1> <checksum-1>
<binding-2> <checksum-1-2>
...
...
<binding-n> <checksum-1-2-..-n>
END
```

The <initial-checksum> helps distinguish between the bindings in the latest update and the bindings from previous updates. Each binding consists of 72 bytes, a space, and another checksum that is used to validate the binding when it is read. If the calculated checksum is not equal to the checksum in the file, that binding and all others after it are ignored.

75.7.1.3 DHCP Relay Option 82 Information

The Switch can add information to DHCP requests that it does not discard. This provides the DHCP server more information about the source of the requests. The Switch can add the following information:

- Slot ID (1 byte), port ID (1 byte), and source VLAN ID (2 bytes)
- System name (up to 32 bytes)

This information is stored in an Agent Information field in the option 82 field of the DHCP headers of client DHCP request frames.

When the DHCP server responds, the Switch removes the information in the Agent Information field before forwarding the response to the original source.

You can configure this setting for each source VLAN. This setting is independent of the DHCP relay settings.

75.7.1.4 Configuring DHCP Snooping

Follow these steps to configure DHCP snooping on the Switch.

- 1 Enable DHCP snooping on the Switch.
- 2 Enable DHCP snooping on each VLAN, and configure DHCP relay option 82.
- 3 Configure trusted and untrusted ports, and specify the maximum number of DHCP packets that each port can receive per second.
- 4 Configure static bindings.

CHAPTER 76

ARP Inspection

76.1 ARP Inspection Status

Use this screen to look at the current list of MAC address filters that were created because the Switch identified an unauthorized ARP packet. When the Switch identifies an unauthorized ARP packet, it automatically creates a MAC address filter to block traffic from the source MAC address and source VLAN ID of the unauthorized ARP packet. To open this screen, click **SECURITY > IPv4 Source Guard > ARP Inspection > ARP Insp. Status**.

Figure 446 SECURITY > IPv4 Source Guard > ARP Inspection > ARP Insp. Status

The following table describes the labels in this screen.

Table 293 SECURITY > IPv4 Source Guard > ARP Inspection > ARP Insp. Status

LABEL	DESCRIPTION
Total Number of Bindings	This field displays the current number of MAC address filters that were created because the Switch identified unauthorized ARP packets.
Index	This field displays a sequential number for each MAC address filter.
MAC Address	This field displays the source MAC address in the MAC address filter.
VID	This field displays the source VLAN ID in the MAC address filter.
Port	This field displays the source port of the discarded ARP packet. In Stacking mode, the first number represents the slot and the second the port number.
Expiry (sec)	This field displays how long (in seconds) the MAC address filter remains in the Switch. You can also delete the record manually (Delete).
	Select an entry's check box to select a specific entry. Otherwise, select the check box in the table heading row to select all entries.
Delete	Click this to remove the selected entries.
Cancel	Click this to clear the Delete check boxes above.

76.2 ARP Inspection VLAN Status

Use this screen to look at various statistics about ARP packets in each VLAN. To open this screen, click **SECURITY > IPv4 Source Guard > ARP Inspection > ARP Insp. VLAN Status**.

Figure 447 SECURITY > IPv4 Source Guard > ARP Inspection > ARP Insp. VLAN Status

The following table describes the labels in this screen.

Table 294 SECURITY > IPv4 Source Guard > ARP Inspection > ARP Insp. VLAN Status

LABEL	DESCRIPTION
Search VLAN by VID	Specify the VLANs you want to view in the section below. Use a comma (,) to separate individual VLANs or a hyphen (-) to indicates a range of VLANs. For example, "3,4" or "3-9".
Search	Click this to display the specified range of VLANs in the section below.
The Number of VLANs	This is the number of VLANs that match the searching criteria and display in the list below. The number displays when you use the Search button to look for certain VLANs. The default value is 0.
VID	This field displays the VLAN ID of each VLAN in the range specified above.
Received	This field displays the total number of ARP packets received from the VLAN since the Switch last restarted.
Request	This field displays the total number of ARP Request packets received from the VLAN since the Switch last restarted.
Reply	This field displays the total number of ARP Reply packets received from the VLAN since the Switch last restarted.
Forwarded	This field displays the total number of ARP packets the Switch forwarded for the VLAN since the Switch last restarted.
Dropped	This field displays the total number of ARP packets the Switch discarded for the VLAN since the Switch last restarted.

76.3 ARP Inspection Log Status

Use this screen to look at log messages that were generated by ARP packets and that have not been sent to the syslog server yet. To open this screen, click **SECURITY > IPv4 Source Guard > ARP Inspection > ARP Insp. Log Status**.

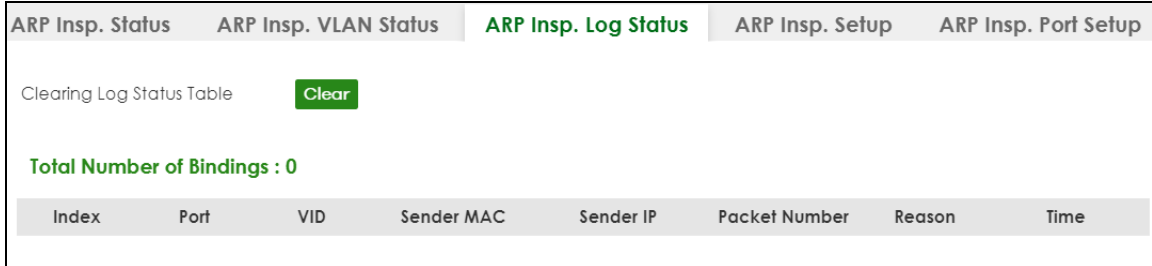
Figure 448 SECURITY > IPv4 Source Guard > ARP Inspection > ARP Insp. Log Status

The following table describes the labels in this screen.

Table 295 SECURITY > IPv4 Source Guard > ARP Inspection > ARP Insp. Log Status

LABEL	DESCRIPTION
Clearing Log Status Table	Click Clear to remove all the log messages that were generated by ARP packets and that have not been sent to the syslog server yet.
Total number of Bindings	This field displays the number of log messages that were generated by ARP packets and that have not been sent to the syslog server yet. If one or more log messages are dropped due to unavailable buffer, there is an entry called overflow with the current number of dropped log messages.
Index	This field displays a sequential number for each log message.
Port	This field displays the source port of the ARP packet. In Stacking mode, the first number represents the slot and the second the port number.
VID	This field displays the source VLAN ID of the ARP packet.
Sender MAC	This field displays the source MAC address of the ARP packet.
Sender IP	This field displays the source IP address of the ARP packet.
Packet Number	This field displays the number of ARP packets that were consolidated into this log message. The Switch consolidates identical log messages generated by ARP packets in the log consolidation interval into one log message. You can configure this interval in the SECURITY > IPv4 Source Guard > ARP Inspection > ARP Insp. Setup screen.
Reason	This field displays the reason the log message was generated. dhcp deny: An ARP packet was discarded because it violated a dynamic binding with the same MAC address and VLAN ID. static deny: An ARP packet was discarded because it violated a static binding with the same MAC address and VLAN ID. deny: An ARP packet was discarded because there were no bindings with the same MAC address and VLAN ID. dhcp permit: An ARP packet was forwarded because it matched a dynamic binding. static permit: An ARP packet was forwarded because it matched a static binding. In the SECURITY > IPv4 Source Guard > ARP Inspection > ARP Insp. VLAN Setup screen, you can configure the Switch to generate log messages when ARP packets are discarded or forwarded based on the VLAN ID of the ARP packet.
Time	This field displays when the log message was generated.

76.4 ARP Inspection Setup

Use this screen to enable ARP inspection on the Switch. You can also configure the length of time the Switch stores records of discarded ARP packets and global settings for the ARP inspection log. To open

this screen, click **SECURITY > IPv4 Source Guard > ARP Inspection > ARP Insp. Setup**.

Figure 449 SECURITY > IPv4 Source Guard > ARP Inspection > ARP Insp. Setup

The following table describes the labels in this screen.

Table 296 SECURITY > IPv4 Source Guard > ARP Inspection > ARP Insp. Setup

LABEL	DESCRIPTION
ARP Inspection Setup	
Active	Enable the switch button to enable ARP inspection on the Switch. You still have to enable ARP inspection on specific VLAN and specify trusted ports.
Filter Aging Time	
Filter Aging Time	This setting has no effect on existing MAC address filters. Enter how long (1 – 2147483647 seconds) the MAC address filter remains in the Switch after the Switch identifies an unauthorized ARP packet. The Switch automatically deletes the MAC address filter afterwards. Type 0 if you want the MAC address filter to be permanent.
Log Profile	
Log Buffer Size	Enter the maximum number (1 – 1024) of log messages that were generated by ARP packets and have not been sent to the syslog server yet. Make sure this number is appropriate for the specified Syslog Rate and Log Interval . If the number of log messages in the Switch exceeds this number, the Switch stops recording log messages and simply starts counting the number of entries that were dropped due to unavailable buffer. Click Clearing Log Status Table in the SECURITY > IPv4 Source Guard > ARP Inspection > ARP Insp. Log Status screen to clear the log and reset this counter.

Table 296 SECURITY > IPv4 Source Guard > ARP Inspection > ARP Insp. Setup (continued)

LABEL	DESCRIPTION
Syslog Rate	Type the maximum number of syslog messages the Switch can send to the syslog server in one batch. This number is expressed as a rate because the batch frequency is determined by the Log Interval . You must configure the syslog server to use this. Enter 0 if you do not want the Switch to send log messages generated by ARP packets to the syslog server. The relationship between Syslog Rate and Log Interval is illustrated in the following examples: <ul style="list-style-type: none"> Four invalid ARP packets per second, Syslog Rate is 5, Log Interval is 1: the Switch sends 4 syslog messages every second. Six invalid ARP packets per second, Syslog Rate is 5, Log Interval is 2: the Switch sends 5 syslog messages every 2 seconds.
Log interval	Type how often (1 – 86400 seconds) the Switch sends a batch of syslog messages to the syslog server. Enter 0 if you want the Switch to send syslog messages immediately. See Syslog Rate for an example of the relationship between Syslog Rate and Log Interval .
Apply	Click Apply to save your changes to the Switch's run-time memory. The Switch loses these changes if it is turned off or loses power, so use the Save link on the top navigation panel to save your changes to the non-volatile memory when you are done configuring.
Cancel	Click this to reset the values in this screen to their last-saved values.

76.5 ARP Inspection Port Setup

Use this screen to specify whether ports are trusted or untrusted ports for ARP inspection. You can also specify the maximum rate at which the Switch receives ARP packets on each untrusted port. To open this screen, click **SECURITY > IPv4 Source Guard > ARP Inspection > ARP Insp. Port Setup**.

Figure 450 SECURITY > IPv4 Source Guard > ARP Inspection > ARP Insp. Port Setup (Standalone Mode)

Port	Trusted State	Limit	
		Rate(pps)	Burst Interval (seconds)
*	Untrusted ▼	<input type="text"/>	<input type="text"/>
1	Untrusted ▼	<input type="text" value="15"/>	<input type="text" value="1"/>
2	Untrusted ▼	<input type="text" value="15"/>	<input type="text" value="1"/>
3	Untrusted ▼	<input type="text" value="15"/>	<input type="text" value="1"/>
4	Untrusted ▼	<input type="text" value="15"/>	<input type="text" value="1"/>
5	Untrusted ▼	<input type="text" value="15"/>	<input type="text" value="1"/>
6	Untrusted ▼	<input type="text" value="15"/>	<input type="text" value="1"/>
7	Untrusted ▼	<input type="text" value="15"/>	<input type="text" value="1"/>

Figure 451 SECURITY > IPv4 Source Guard > ARP Inspection > ARP Insp. Port Setup (Stacking Mode)

VLAN Status		ARP Insp. Log Status		ARP Insp. Setup		ARP Insp. Port Setup	
SLOT 1 ▾							
Port	Trusted State	Limit					
		Rate(pps)	Burst Interval (seconds)				
1/*	Untrusted ▾	<input type="text"/>	<input type="text"/>				
1/1	Untrusted ▾	15	1				
1/2	Untrusted ▾	15	1				
1/3	Untrusted ▾	15	1				
1/4	Untrusted ▾	15	1				
1/5	Untrusted ▾	15	1				
1/6	Untrusted ▾	15	1				
1/7	Untrusted ▾	15	1				
<input type="button" value="Apply"/> <input type="button" value="Cancel"/>							

The following table describes the labels in this screen.

Table 297 SECURITY > IPv4 Source Guard > ARP Inspection > ARP Insp. Port Setup

LABEL	DESCRIPTION
SLOT	This field appears only in Stacking mode. Click the drop-down list to choose the slot number of the Switch in a stack.
Port	This field displays the port number. In Stacking mode, the first number represents the slot ID and the second is the port number. Please note that the default stacking ports (the last four ports of your Switch) cannot be configured. They are reserved for stacking only.
*	Settings in this row apply to all ports. Use this row only if you want to make some settings the same for all ports. Use this row first to set the common settings and then make adjustments on a port-by-port basis. Note: Changes in this row are copied to all the ports as soon as you make them.
Trusted State	Select whether this port is a trusted port (Trusted) or an untrusted port (Untrusted). The Switch does not discard ARP packets on trusted ports for any reason. The Switch discards ARP packets on untrusted ports in the following situations: <ul style="list-style-type: none"> The sender's information in the ARP packet does not match any of the current bindings. The rate at which ARP packets arrive is too high. You can specify the maximum rate at which ARP packets can arrive on untrusted ports.
Limit	Rate and Burst Interval settings have no effect on trusted ports.
Rate (pps)	Specify the maximum rate (1 – 2048 packets per second) at which the Switch receives ARP packets from each port. The Switch discards any additional ARP packets. Enter 0 to disable this limit.

Table 297 SECURITY > IPv4 Source Guard > ARP Inspection > ARP Insp. Port Setup (continued)

LABEL	DESCRIPTION
Burst Interval (seconds)	The burst interval is the length of time over which the rate of ARP packets is monitored for each port. For example, if the Rate is 15 pps and the burst interval is 1 second, then the Switch accepts a maximum of 15 ARP packets in every one-second interval. If the burst interval is 5 seconds, then the Switch accepts a maximum of 75 ARP packets in every five-second interval. Enter the length (1 – 15 seconds) of the burst interval.
Apply	Click Apply to save your changes to the Switch's run-time memory. The Switch loses these changes if it is turned off or loses power, so use the Save link on the top navigation panel to save your changes to the non-volatile memory when you are done configuring.
Cancel	Click this to reset the values in this screen to their last-saved values.

76.6 ARP Inspection VLAN Setup

Use this screen to enable ARP inspection on each VLAN and to specify when the Switch generates log messages for receiving ARP packets from each VLAN. To open this screen, click **SECURITY > IPv4 Source Guard > ARP Inspection > ARP Insp. VLAN Setup**.

Figure 452 SECURITY > IPv4 Source Guard > ARP Inspection > ARP Insp. VLAN Setup

ARP Insp. Log Status ARP Insp. Setup ARP Insp. Port Setup **ARP Insp. VLAN Setup**

Search VLAN by VID

The Number of VLANs: 1

« < Page 1 of 1 > »

VID	Enabled	Log
*	No ▾	None ▾
1	No ▾	Deny ▾

« < Page 1 of 1 > »

The following table describes the labels in this screen.

Table 298 SECURITY > IPv4 Source Guard > ARP Inspection > ARP Insp. VLAN Setup

LABEL	DESCRIPTION
Search VLAN by VID	Specify the VLANs you want to manage in the section below. Use a comma (,) to separate individual VLANs or a hyphen (-) to indicate a range of VLANs. For example, "3,4" or "3-9".
Search	Click this to display the specified range of VLANs in the section below.
The Number of VLANs	This displays the number of ARP inspection VLAN search results.
VID	This field displays the VLAN ID of each VLAN in the range specified above. If you configure the * VLAN, the settings are applied to all VLANs.

Table 298 SECURITY > IPv4 Source Guard > ARP Inspection > ARP Insp. VLAN Setup (continued)

LABEL	DESCRIPTION
Enabled	Select Yes to enable ARP inspection on the VLAN. Select No to disable ARP inspection on the VLAN.
Log	Specify when the Switch generates log messages for receiving ARP packets from the VLAN. None: The Switch does not generate any log messages when it receives an ARP packet from the VLAN. Deny: The Switch generates log messages when it discards an ARP packet from the VLAN. Permit: The Switch generates log messages when it forwards an ARP packet from the VLAN. All: The Switch generates log messages every time it receives an ARP packet from the VLAN.
Apply	Click Apply to save your changes to the Switch's run-time memory. The Switch loses these changes if it is turned off or loses power, so use the Save link on the top navigation panel to save your changes to the non-volatile memory when you are done configuring.
Cancel	Click this to reset the values in this screen to their last-saved values.

76.7 IPv6 Source Guard

The purpose of IPv6 source guard is to distinguish between authorized and unauthorized users by using a binding table that validates the source of IPv6 traffic. The binding table can be manually created or be learned through Dynamic Host Configuration Protocol version 6 snooping (DHCPv6 snooping). IPv6 source guard can deny IPv6 traffic from an unknown source. The IPv6 source guard binding table includes:

- IPv6 address
- IPv6 prefix
- VLAN ID
- Port number
- MAC address

Enable IPv6 source guard on a port for the Switch to check incoming IPv6 packets on that port. A packet is allowed when it matches any entry in the IPSG binding table. If a user tries to send IPv6 packets to the Switch that do not match an entry in the IPSG binding table, the Switch will drop these packets. The Switch forwards matching traffic normally. The IPv6 source guard related screens are available in standalone mode.

76.8 IPv6 Source Binding Status

Use this screen to look at the current IPv6 dynamic and static bindings and to remove dynamic bindings based on IPv6 address and/or IPv6 prefix. Bindings are used to distinguish between authorized and unauthorized packets in the network. The Switch learns the bindings by snooping DHCP packets (dynamic bindings) and from information provided manually by administrators (static bindings). To open this screen, click **SECURITY > IPv6 Source Guard > IP Static Binding > IP Source Binding Status**.

Figure 453 SECURITY > IPv6 Source Guard > IP Static Binding > IP Source Binding Status

The following table describes the labels in this screen.

Table 299 SECURITY > IPv6 Source Guard > IP Static Binding > IP Source Binding Status

LABEL	DESCRIPTION
Clear Dynamic Source Binding	Specify how you want the Switch to remove dynamic IPv6 source binding entries when you click Flush . <ul style="list-style-type: none"> Select All to remove all of the dynamic entries from the IPv6 source binding table. Select IPv6 Address and enter an IPv6 address to remove the dynamic entries snooped with the specified IPv6 address. Select IPv6 Prefix and enter a Prefix address to remove the dynamic entries snooped with the specified Prefix address.
Flush	Click this to remove dynamic IPv6 source binding entries according to your selections.
Cancel	Click this to reset the values above based or if not applicable, to clear the fields above.
Index	This field displays a sequential number for each binding.
Source Address	This field displays the source IP address in the binding. If the entry is blank, this field will not be checked in the binding.
MAC Address	This field displays the source MAC address in the binding. If the entry is blank, this field will not be checked in the binding.
VLAN	This field displays the source VLAN ID in the binding. If the entry is blank, this field will not be checked in the binding.
Port	This field displays the port number in the binding. If this field is blank, the binding applies to all ports.
Lease	This field displays how many days, hours, minutes, and seconds the binding is valid; for example, 2d3h4m5s means the binding is still valid for 2 days, 3 hours, 4 minutes, and 5 seconds. This field displays infinity if the binding is always valid (for example, a static binding).
Type	This field displays how the Switch learned the binding. <p>S: This static binding was learned from information provided manually by an administrator.</p> <p>DH: This dhcp-snooping binding was learned by snooping DHCP packets.</p>

76.9 IPv6 Static Binding

Use this screen to view or configure an IPv6 source guard binding table entry and manage IPv6 static bindings. Static bindings are uniquely identified by the source IPv6 address / prefix. Each source IPv6 address / prefix can only be in one static binding. If you try to create a static binding with the same

source IPv6 address / prefix as an existing static binding, the new static binding replaces the original one. To open this screen, click **SECURITY > IPv6 Source Guard > IPv6 Static Binding > IPv6 Static Binding**.

Figure 454 SECURITY > IPv6 Source Guard > IPv6 Static Binding > IPv6 Static Binding

<input type="checkbox"/>	Index	Source Address	MAC Address	VLAN	Port
--------------------------	-------	----------------	-------------	------	------

The following table describes the labels in this screen.

Table 300 SECURITY > IPv6 Source Guard > IPv6 Static Binding > IPv6 Static Binding

LABEL	DESCRIPTION
Index	This field displays a sequential number for each binding.
Source Address	This field displays the IPv6 address or IPv6 prefix and prefix length in the binding.
MAC Address	This field displays the source MAC address in the binding. If the entry is blank, this field will not be checked in the binding.
VLAN	This field displays the source VLAN ID in the binding. If the entry is blank, this field will not be checked in the binding.
Port	This field displays the port number in the binding. If this field is blank, the binding applies to all ports. In Stacking mode, the first number represents the slot and the second the port number
	Select an entry's check box to select a specific entry. Otherwise, select the check box in the table heading row to select all entries.
Add/Edit	Click Add/Edit to add a new entry or edit a selected one.
Delete	Click Delete to remove the selected entries.

76.9.1 Add/Edit IPv6 Static Binding

Use this screen to manually create an IPv6 source guard binding table entry and manage IPv6 static bindings. Click **Add/Edit**, or select an entry and click **Add/Edit** in the **SECURITY > IPv6 Source Guard > IPv6 Static Binding > IPv6 Static Binding** screen to display this screen.

Figure 455 SECURITY > IPv6 Source Guard > IPv6 Static Binding > IPv6 Static Binding > Add/Edit (Standalone Mode)

Source Address: IPv6 Address
 IPv6 Prefix /

MAC Address: Any

VLAN: Any

Port: Any

Apply **Clear** **Cancel**

Figure 456 SECURITY > IPv6 Source Guard > IPv6 Static Binding > IPv6 Static Binding > Add/Edit (Stacking Mode)

The following table describes the labels in this screen.

Table 301 SECURITY > IPv6 Source Guard > IPv6 Static Binding > IPv6 Static Binding > Add/Edit

LABEL	DESCRIPTION
Source Address	Enter the IPv6 Address or IPv6 Prefix and prefix length in the binding.
MAC Address	Enter the source MAC address in the binding. If this binding does not check this field, select Any . Note: You cannot choose Any for all three of MAC Address , VLAN and Port . You must fill in at least one.
VLAN	Enter the source VLAN ID in the binding. If this binding does not check this field, select Any .
Port	Specify the ports in the binding. If this binding has one port, select the first radio button and enter the port number in the field to the right. In Stacking mode, the first field is the slot ID and the second field is the port number. If this binding applies to all ports, select Any .
Apply	Click Apply to save your changes to the Switch's run-time memory. The Switch loses these changes if it is turned off or loses power, so use the Save link on the top navigation panel to save your changes to the non-volatile memory when you are done configuring.
Clear	Click Clear to clear the fields to the factory defaults.
Cancel	Click Cancel to not save the configuration you make and return to the last screen.

76.10 IPv6 Source Guard Policy

Use this screen to have IPv6 source guard forward valid IPv6 addresses and/or IPv6 prefixes that are stored in the binding table and allow or block data traffic from all link-local addresses. To open this screen, click **SECURITY > IPv6 Source Guard > IPv6 Source Guard > IPv6 Source Guard Policy**.

- If you select **Validate Address** and not **Validate Prefix**, traffic for a binding entry that matches a IPv6 address and VLAN ID, port number, and MAC address will be forwarded. If this binding entry is a IPv6 prefix, the traffic will be denied.
- If you select **Validate Prefix** and not **Validate Address**, traffic for a binding entry that matches a IPv6 prefix and VLAN ID, port number, and MAC address will be forwarded. If this binding entry is a IPv6 address, the traffic will be denied.

- If you select both **Validate Prefix** and **Validate Address** then traffic matching either IPv6 address or prefix will be forwarded.

Figure 457 SECURITY > IPv6 Source Guard > IPv6 Source Guard > IPv6 Source Guard Policy

<input type="checkbox"/>	Index	Name	Validate Address	Validate Prefix	Link Local
--------------------------	-------	------	------------------	-----------------	------------

The following table describes the labels in this screen.

Table 302 SECURITY > IPv6 Source Guard > IPv6 Source Guard > IPv6 Source Guard Policy

LABEL	DESCRIPTION
Index	This field displays a sequential number for each policy.
Name	This field displays the descriptive name for identification purposes for this IPv6 source guard policy.
Validate Address	This field displays the Validate Address status for this IPv6 source guard policy.
Validate Prefix	This field displays the Validate Prefix status for this IPv6 source guard policy.
Link Local	This field displays the Link Local traffic status for this IPv6 source guard policy.
	Select an entry's check box to select a specific entry. Otherwise, select the check box in the table heading row to select all entries.
Add/Edit	Click Add/Edit to add a new entry or edit a selected one.
Delete	Click Delete to remove the selected entries.

76.10.1 Add/Edit an IPv6 Source Guard Policy

Click **Add/Edit**, or select an entry and click **Add/Edit** in the **SECURITY > IPv6 Source Guard > IPv6 Source Guard > IPv6 Source Guard Policy** screen to display this screen.

Figure 458 SECURITY > IPv6 Source Guard > IPv6 Source Guard > IPv6 Source Guard Policy > Add/Edit

The following table describes the labels in this screen.

Table 303 SECURITY > IPv6 Source Guard > IPv6 Source Guard > IPv6 Source Guard Policy > Add/Edit

LABEL	DESCRIPTION
Name	Enter a descriptive name for identification purposes for this IPv6 source guard policy. You can enter up to 32 printable ASCII characters except [?], [], ['], [*] or [,].
Validate Address	Select Validate Address to have IPv6 source guard forward valid addresses that are stored in the binding table.

Table 303 SECURITY > IPv6 Source Guard > IPv6 Source Guard > IPv6 Source Guard Policy > Add/Edit

LABEL	DESCRIPTION
Validate Prefix	Select Validate Prefix to have IPv6 source guard forward valid prefixes that are stored in the binding table.
Link Local	Select Permit to allow data traffic from all link-local addresses; otherwise leave the setting at Deny . A link-local address is an IPv6 unicast address that can be automatically configured on any interface using the link-local prefix FE80::/10 and the interface identifier in the modified EUI-64 format.
Apply	Click Apply to save your changes to the Switch's run-time memory. The Switch loses these changes if it is turned off or loses power, so use the Save link on the top navigation panel to save your changes to the non-volatile memory when you are done configuring.
Clear	Click Clear to clear the fields to the factory defaults.
Cancel	Click Cancel to not save the configuration you make and return to the last screen.

76.11 IPv6 Source Guard Port Setup

Use this screen to apply configured IPv6 source guard policies to ports you specify. Use port * to apply a policy to all ports. To open this screen, click **SECURITY > IPv6 Source Guard > IPv6 Source Guard > IPv6 Source Guard Port Setup**.

Figure 459 SECURITY > IPv6 Source Guard > IPv6 Source Guard > IPv6 Source Guard Port Setup (Standalone Mode)

Port	Policy Name
*	▼
1	▼
2	▼
3	▼
4	▼
5	▼
6	▼
7	▼

Figure 460 SECURITY > IPv6 Source Guard > IPv6 Source Guard > IPv6 Source Guard Port Setup (Stacking Mode)

The following table describes the labels in this screen.

Table 304 SECURITY > IPv6 Source Guard > IPv6 Source Guard > IPv6 Source Guard Port Setup

LABEL	DESCRIPTION
SLOT	This field appears only in Stacking mode. Click the drop-down list to choose the slot number of the Switch in a stack.
Port	This field displays the port number. In Stacking mode, the first number represents the slot ID and the second is the port number. Please note that the default stacking ports (the last four ports of your Switch) cannot be configured. They are reserved for stacking only.
*	Settings in this row apply to all ports. Use this row only if you want to make some settings the same for all ports. Use this row first to set the common settings and then make adjustments on a port-by-port basis. Note: Changes in this row are copied to all the ports as soon as you make them.
Policy Name	Select an IPv6 source guard policy that the Switch will apply to this port.
Apply	Click Apply to save your changes to the Switch's run-time memory. The Switch loses these changes if it is turned off or loses power, so use the Save link on the top navigation panel to save your changes to the non-volatile memory when you are done configuring.
Cancel	Click this to reset the values in this screen to their last-saved values.

76.12 IPv6 Snooping Policy Setup

Use this screen to view and dynamically create an IPv6 source guard binding table using a DHCPv6 snooping policy. A DHCPv6 snooping policy lets the Switch sniff DHCPv6 packets sent from a DHCPv6 server to a DHCPv6 client when it is assigning an IPv6 address. When a DHCPv6 client successfully gets a valid IPv6 address, DHCPv6 snooping builds the binding table dynamically. To open this screen, click **SECURITY > IPv6 Source Guard > IPv6 Snooping > IPv6 Snooping Policy Setup**.

Note: If you do not select **Protocol** and **Prefix Glean**, then the Switch cannot perform DHCPv6 snooping.

Figure 461 SECURITY > IPv6 Source Guard > IPv6 Snooping > IPv6 Snooping Policy Setup

<input type="checkbox"/>	Index	Name	Protocol	Prefix Glean	Limit Address Count
--------------------------	-------	------	----------	--------------	---------------------

The following table describes the labels in this screen.

Table 305 SECURITY > IPv6 Source Guard > IPv6 Snooping > IPv6 Snooping Policy Setup

LABEL	DESCRIPTION
Index	This field displays a sequential number for each IPv6 snooping policy.
Name	This field displays the descriptive name for identification purposes for this IPv6 source guard policy.
Protocol	This field displays the protocols learned from DHCPv6 sniffed packets.
Prefix Glean	This field displays the IPv6 prefixes learned from DHCPv6 sniffed packets.
Limit Address Count	This field displays the number of IPv6 addresses and prefixes learned using the IPv6 snooping policy.
	Select an entry's check box to select a specific entry. Otherwise, select the check box in the table heading row to select all entries.
Add/Edit	Click Add/Edit to add a new entry or edit a selected one.
Delete	Click Delete to remove the selected entries.

76.12.1 Add/Edit a IPv6 Snooping Policy

Use this screen to dynamically create an IPv6 source guard binding table using a DHCPv6 snooping policy. Click **Add/Edit**, or select an entry and click **Add/Edit** in the **SECURITY > IPv6 Source Guard > IPv6 Snooping > IPv6 Snooping Policy Setup** screen to display this screen.

Figure 462 SECURITY > IPv6 Source Guard > IPv6 Snooping > IPv6 Snooping Policy Setup > Add/Edit

The following table describes the labels in this screen.

Table 306 SECURITY > IPv6 Source Guard > IPv6 Snooping > IPv6 Snooping Policy Setup > Add/Edit

LABEL	DESCRIPTION
Name	Enter a descriptive name for identification purposes for this IPv6 snooping policy. You can enter up to 32 printable ASCII characters except [?], [], ['], ["] or [,].
Protocol	Select DHCP to let the Switch sniff DHCPv6 packets sent from a DHCPv6 server to a DHCPv6 client.
Prefix Glean	Enable the switch button to learn the IPv6 prefix and length from DHCPv6 sniffed packets.
Limit Address Count	This is the number of IPv6 addresses and prefixes learned using the IPv6 snooping policy. Note: The maximum limit address count is the maximum size of the IPv6 source guard binding table. See the product data sheet for the latest specifications.
Apply	Click Apply to save your changes to the Switch's run-time memory. The Switch loses these changes if it is turned off or loses power, so use the Save link on the top navigation panel to save your changes to the non-volatile memory when you are done configuring.
Clear	Click Clear to clear the fields to the factory defaults.
Cancel	Click Cancel to not save the configuration you make and return to the last screen.

76.13 IPv6 Snooping VLAN Setup

Use this screen to enable a DHCPv6 snooping policy on a specific VLAN interface. To open this screen, click **SECURITY > IPv6 Source Guard > IPv6 Snooping > IPv6 Snp. VLAN Setup**.

Figure 463 SECURITY > IPv6 Source Guard > IPv6 Snooping > IPv6 Snp. VLAN Setup

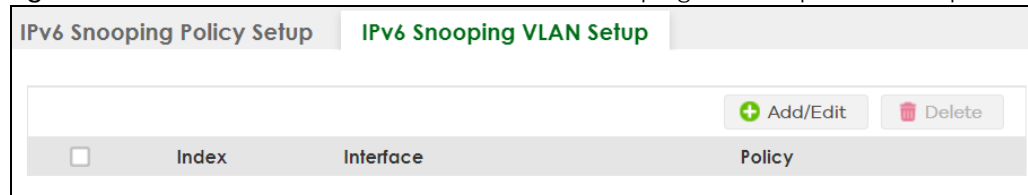

The following table describes the labels in this screen.

Table 307 SECURITY > IPv6 Source Guard > IPv6 Snooping > IPv6 Snp. VLAN Setup

LABEL	DESCRIPTION
Index	This field displays a sequential number for each binding.
Interface	This field displays the VLAN interface.
Policy	This field displays the DHCPv6 snooping policy.
	Select an entry's check box to select a specific entry. Otherwise, select the check box in the table heading row to select all entries.
Add/Edit	Click Add/Edit to add a new entry or edit a selected one.
Delete	Click Delete to remove the selected entries.

76.13.1 Add/Edit an IPv6 Snooping VLAN

Use this screen to add/edit a DHCPv6 snooping policy on a specific VLAN interface. Click **Add/Edit**, or select an entry and click **Add/Edit** in the **SECURITY > IPv6 Source Guard > IPv6 Snooping > IPv6 Snp. VLAN Setup** screen to display this screen.

Figure 464 SECURITY > IPv6 Source Guard > IPv6 Snooping > IPv6 Snp. VLAN Setup > Add/Edit

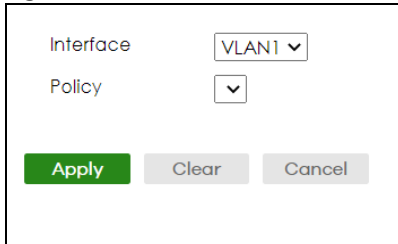

The following table describes the labels in this screen.

Table 308 SECURITY > IPv6 Source Guard > IPv6 Snooping > IPv6 Snp. VLAN Setup > Add/Edit

LABEL	DESCRIPTION
Interface	Select the VLAN interface to apply the selected DHCPv6 snooping policy.
Policy	Select the IPv6 snooping policy to apply to this VLAN interface.
Apply	Click Apply to save your changes to the Switch's run-time memory. The Switch loses these changes if it is turned off or loses power, so use the Save link on the top navigation panel to save your changes to the non-volatile memory when you are done configuring.
Clear	Click Clear to clear the fields to the factory defaults.
Cancel	Click Cancel to not save the configuration you make and return to the last screen.

76.14 IPv6 DHCP Trust Setup

Use this screen to specify which ports are trusted for DHCPv6 snooping. To open this screen, click **SECURITY > IPv6 Source Guard > DHCPv6 Trust Setup**.

Note: DHCPv6 solicit packets are sent from a DHCPv6 client to a DHCPv6 server. Reply packets from a DHCPv6 server connected to an untrusted port are discarded.

Use port * to have all ports be **Untrusted** or **Trusted**.

Figure 465 SECURITY > IPv6 Source Guard > DHCPv6 Trust Setup (Standalone Mode)

DHCPv6 Trust Setup

Trust Setting

Active OFF

Port Setting

Port	Trusted State
*	Untrusted ▼
1	Untrusted ▼
2	Untrusted ▼
3	Untrusted ▼
4	Untrusted ▼
5	Untrusted ▼
6	Untrusted ▼
7	Untrusted ▼

Apply **Cancel**

Figure 466 SECURITY > IPv6 Source Guard > DHCPv6 Trust Setup (Stacking Mode)

DHCPv6 Trust Setup

Trust Setting

Active OFF

Port Setting

SLOT 1 ▼

Port	Trusted State
1/*	Untrusted ▼
1/1	Untrusted ▼
1/2	Untrusted ▼
1/3	Untrusted ▼
1/4	Untrusted ▼
1/5	Untrusted ▼
1/6	Untrusted ▼
1/7	Untrusted ▼

Apply **Cancel**

The following table describes the labels in this screen.

Table 309 SECURITY > IPv6 Source Guard > DHCPv6 Trust Setup

LABEL	DESCRIPTION
Trust Setting	
Active	Enable the switch button to specify whether ports are trusted or untrusted ports for DHCP snooping. If you do not select this then IPv6 DHCP Trust is not used and all ports are automatically trusted.
Port Setting	
SLOT	This field appears only in Stacking mode. Click the drop-down list to choose the slot number of the Switch in a stack.
Port	This field displays the port number. In Stacking mode, the first number represents the slot ID and the second is the port number. Please note that the default stacking ports (the last four ports of your Switch) cannot be configured. They are reserved for stacking only.
*	Settings in this row apply to all ports. Use this row only if you want to make some settings the same for all ports. Use this row first to set the common settings and then make adjustments on a port-by-port basis. Note: Changes in this row are copied to all the ports as soon as you make them.
Trusted State	Select whether this port is a trusted port (Trusted) or an untrusted port (Untrusted). Trusted ports are connected to DHCPv6 servers or other switches. Untrusted ports are connected to subscribers, and the Switch discards DHCPv6 packets from untrusted ports in the following situations: <ul style="list-style-type: none"> • The packet is a DHCPv6 server packet (for example, ADVERTISE, REPLY, or RELAY-REPLY). • The source MAC address and source IP address in the packet do not match any of the current bindings.
Apply	Click Apply to save your changes to the Switch's run-time memory. The Switch loses these changes if it is turned off or loses power, so use the Save link on the top navigation panel to save your changes to the non-volatile memory when you are done configuring.
Cancel	Click this to reset the values in this screen to their last-saved values.

76.15 Technical Reference

This section provides technical background information on the topics discussed in this chapter.

76.15.1 ARP Inspection Overview

Use ARP inspection to filter unauthorized ARP packets on the network. This can prevent many kinds of man-in-the-middle attacks, such as the one in the following example.

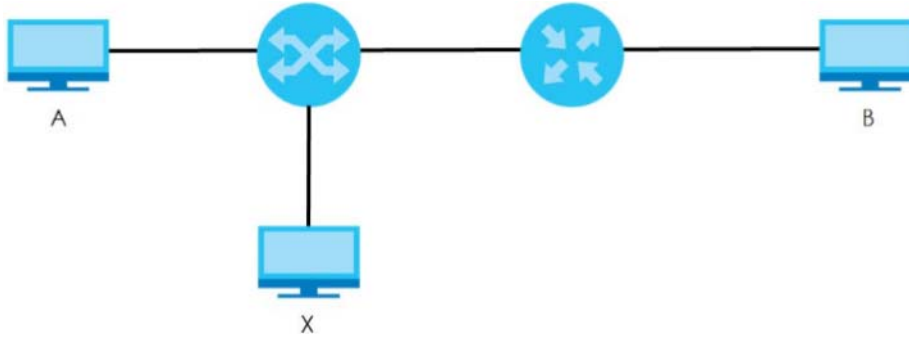
Figure 467 Example: Man-in-the-middle Attack

In this example, computer **B** tries to establish a connection with computer **A**. Computer **X** is in the same broadcast domain as computer **A** and intercepts the ARP request for computer **A**. Then, computer **X** does the following things:

- It pretends to be computer **A** and responds to computer **B**.
- It pretends to be computer **B** and sends a message to computer **A**.

As a result, all the communication between computer **A** and computer **B** passes through computer **X**. Computer **X** can read and alter the information passed between them.

76.15.1.1 ARP Inspection and MAC Address Filters

When the Switch identifies an unauthorized ARP packet, it automatically creates a MAC address filter to block traffic from the source MAC address and source VLAN ID of the unauthorized ARP packet. You can configure how long the MAC address filter remains in the Switch.

These MAC address filters are different than regular MAC address filters.

- They are stored only in volatile memory.
- They do not use the same space in memory that regular MAC address filters use.
- They appear only in the **ARP Inspection** screens and commands, not in the **MAC Address Filter** screens and commands.

76.15.1.2 Trusted vs. Untrusted Ports

Every port is either a trusted port or an untrusted port for ARP inspection. This setting is independent of the trusted or untrusted setting for DHCP snooping. You can also specify the maximum rate at which the Switch receives ARP packets on untrusted ports.

The Switch does not discard ARP packets on trusted ports for any reason.

The Switch discards ARP packets on untrusted ports in the following situations:

- The sender's information in the ARP packet does not match any of the current bindings.
- The rate at which ARP packets arrive is too high.

76.15.1.3 Syslog

The Switch can send syslog messages to the specified syslog server when it forwards or discards ARP packets. The Switch can consolidate log messages and send log messages in batches to make this mechanism more efficient.

76.15.1.4 Configuring ARP Inspection

Follow these steps to configure ARP inspection on the Switch.

- 1 Configure DHCP snooping.

Note: It is recommended you enable DHCP snooping at least one day before you enable ARP inspection so that the Switch has enough time to build the binding table.

- 2 Enable ARP inspection on each VLAN.
- 3 Configure trusted and untrusted ports, and specify the maximum number of ARP packets that each port can receive per second.

CHAPTER 77

Port Authentication

77.1 Port Authentication Overview

This chapter describes the IEEE 802.1x, MAC, Guest VLAN, and Compound authentication methods.

- **IEEE 802.1x²** – An authentication server validates access to a port based on a user name and password provided by the user. A user that fails an authentication server can still access the port, but traffic from the user is forwarded to the guest VLAN port.
- **MAC Authentication** – An authentication server validates access to a port based on the MAC address and password of the client.
- **Guest VLAN** – In either mode, if authentication fails the Switch can still allow the client to access the network on a **Guest VLAN**.
- **Compound Authentication** – An authentication server validates access to a port based on combination of IEEE 802.1x and MAC Authentication. There are two modes:
 - **Loose:** The client authenticates using either IEEE 802.1x authentication or MAC Authentication.
 - **Strict:** The client authenticates using both IEEE 802.1x authentication and MAC Authentication.

Note: All types of authentication use the RADIUS (Remote Authentication Dial In User Service, RFC 2138, 2139) protocol to validate users. You must configure a RADIUS server before enabling port authentication.

Note: If you enable IEEE 802.1x authentication and MAC authentication on the same port, the Switch performs IEEE 802.1x authentication and MAC authentication. If a user fails to authenticate either through the IEEE 802.1x or MAC authentication method, then access to the port is denied.

Note: IEEE 802.1x is not supported by all user operating systems. For details on compatibility, see your operating system documentation. If your operating system does not support 802.1x, you must install 802.1x client software.

77.1.1 What You Can Do

- Use the **802.1x** screen ([Section 77.2 on page 586](#)) to activate IEEE 802.1x security.
- Use the **MAC Authentication** screen ([Section 77.3 on page 588](#)) to activate MAC authentication.
- Use the **Guest VLAN** screen ([Section 77.4 on page 591](#)) to enable and assign a guest VLAN to a port.

2. At the time of writing, IEEE 802.1x is not supported by all operating systems. See your operating system documentation. If your operating system does not support 802.1x, then you may need to install 802.1x client software.

- Use the **Compound Authentication** screen ([Section 77.5 on page 594](#)) to allow network access for clients that pass either IEEE 802.1x authentication OR MAC authentication, or pass both IEEE 802.1x authentication AND MAC authentication.

77.1.2 What You Need to Know

IEEE 802.1x Authentication

The following figure illustrates how a client connecting to a IEEE 802.1x authentication enabled port goes through a validation process. The Switch prompts the client for login information in the form of a user name and password after the client responds to its identity request. When the client provides the login credentials, the Switch sends an authentication request to a RADIUS server. The RADIUS server validates whether this client is allowed access to the port.

Figure 468 IEEE 802.1x Authentication Process

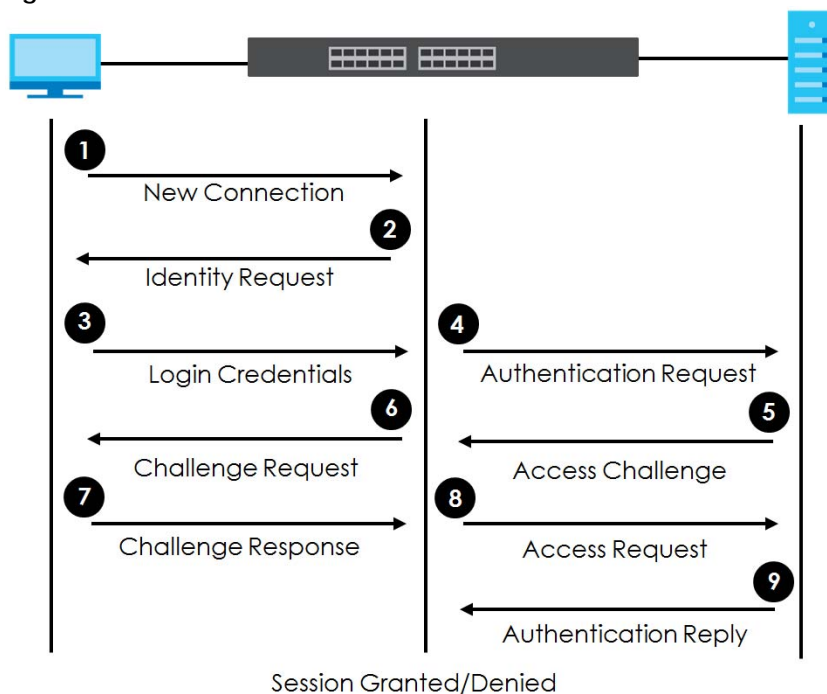

77.1.3 MAC Authentication

MAC authentication works in a very similar way to IEEE 802.1x authentication. The main difference is that the Switch does not prompt the client for login credentials. The login credentials are based on the source MAC address of the client connecting to a port on the Switch along with a password configured specifically for MAC authentication on the Switch.

Figure 469 MAC Authentication Process

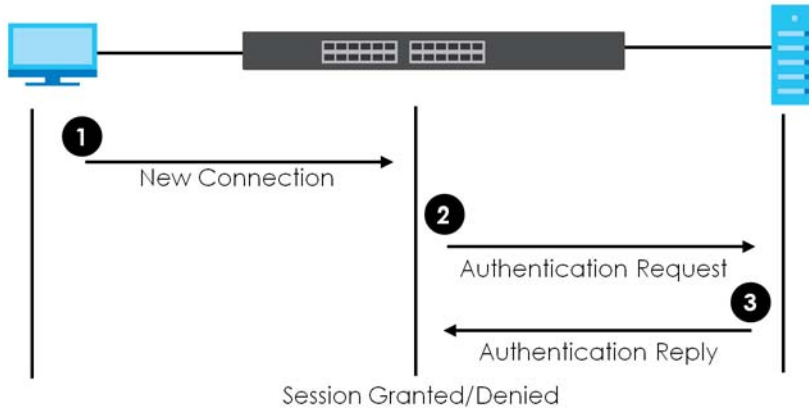

Note: To enable port authentication, first activate the port authentication methods (both on the Switch and the ports), then configure the RADIUS server settings in the **SECURITY > AAA > RADIUS Server Setup** screen.

77.2 Activate IEEE 802.1x Security

Use this screen to activate IEEE 802.1x security. Click **SECURITY > Port Authentication > 802.1x** to display the configuration screen as shown.

Figure 470 SECURITY > Port Authentication > 802.1x (Standalone Mode)

802.1x

Active OFF

EAPOL flood OFF

Port	Active	Max-Req	Reauth	Reauth-period secs	Quiet-period secs	Tx-period secs	Supp-Timeout secs
*	<input type="checkbox"/>	<input type="text"/>	On ▼	<input type="text"/>	<input type="text"/>	<input type="text"/>	<input type="text"/>
1	<input type="checkbox"/>	<input type="text" value="2"/>	On ▼	<input type="text" value="3600"/>	<input type="text" value="60"/>	<input type="text" value="30"/>	<input type="text" value="30"/>
2	<input type="checkbox"/>	<input type="text" value="2"/>	On ▼	<input type="text" value="3600"/>	<input type="text" value="60"/>	<input type="text" value="30"/>	<input type="text" value="30"/>
3	<input type="checkbox"/>	<input type="text" value="2"/>	On ▼	<input type="text" value="3600"/>	<input type="text" value="60"/>	<input type="text" value="30"/>	<input type="text" value="30"/>
4	<input type="checkbox"/>	<input type="text" value="2"/>	On ▼	<input type="text" value="3600"/>	<input type="text" value="60"/>	<input type="text" value="30"/>	<input type="text" value="30"/>
5	<input type="checkbox"/>	<input type="text" value="2"/>	On ▼	<input type="text" value="3600"/>	<input type="text" value="60"/>	<input type="text" value="30"/>	<input type="text" value="30"/>
6	<input type="checkbox"/>	<input type="text" value="2"/>	On ▼	<input type="text" value="3600"/>	<input type="text" value="60"/>	<input type="text" value="30"/>	<input type="text" value="30"/>
7	<input type="checkbox"/>	<input type="text" value="2"/>	On ▼	<input type="text" value="3600"/>	<input type="text" value="60"/>	<input type="text" value="30"/>	<input type="text" value="30"/>

Figure 471 SECURITY > Port Authentication > 802.1x (Stacking Mode)

802.1x

Active OFF

EAPOL flood OFF

SLOT 1 ▾

Port	Active	Max-Req	Reauth	Reauth-period secs	Quiet-period secs	Tx-period secs	Supp-Timeout secs
1/*	<input type="checkbox"/>	<input type="text"/>	On ▾	<input type="text"/>	<input type="text"/>	<input type="text"/>	<input type="text"/>
1/1	<input type="checkbox"/>	2	On ▾	3600	60	30	30
1/2	<input type="checkbox"/>	2	On ▾	3600	60	30	30
1/3	<input type="checkbox"/>	2	On ▾	3600	60	30	30
1/4	<input type="checkbox"/>	2	On ▾	3600	60	30	30
1/5	<input type="checkbox"/>	2	On ▾	3600	60	30	30
1/6	<input type="checkbox"/>	2	On ▾	3600	60	30	30
1/7	<input type="checkbox"/>	2	On ▾	3600	60	30	30

Apply Cancel

The following table describes the labels in this screen.

Table 310 SECURITY > Port Authentication > 802.1x

LABEL	DESCRIPTION
Active	<p>Enable the switch button to permit 802.1x authentication on the Switch.</p> <p>Note: You must first enable 802.1x authentication on the Switch before configuring it on each port.</p>
EAPOL flood	<p>Enable the switch button to flood EAPOL packets to all ports in the same VLAN.</p> <p>EAP over LAN (EAPOL) is a port authentication protocol used in IEEE 802.1x. It is used to encapsulate and transmit EAP packets between the supplicant (a client device that requests access to the network resources or services) and authenticator (the Switch) directly over the LAN.</p> <p>Note: EAPOL flood will not take effect when 802.1x authentication is enabled.</p>
SLOT	<p>This field appears only in Stacking mode. Click the drop-down list to choose the slot number of the Switch in a stack.</p>
Port	<p>This field displays the port number. In Stacking mode, the first number represents the slot ID and the second is the port number. Please note that the default stacking ports (the last four ports of your Switch) cannot be configured. They are reserved for stacking only.</p>
*	<p>Settings in this row apply to all ports.</p> <p>Use this row only if you want to make some settings the same for all ports. Use this row first to set the common settings and then make adjustments on a port-by-port basis.</p> <p>Note: Changes in this row are copied to all the ports as soon as you make them.</p>

Table 310 SECURITY > Port Authentication > 802.1x (continued)

LABEL	DESCRIPTION
Active	Select this to permit 802.1x authentication on this port. You must first allow 802.1x authentication on the Switch before configuring it on each port.
Max-Req	Specify the number of times the Switch tries to authenticate clients before sending unresponsive ports to the Guest VLAN. This is set to 2 by default. That is, the Switch attempts to authenticate a client twice. If the client does not respond to the first authentication request, the Switch tries again. If the client still does not respond to the second request, the Switch sends the client to the Guest VLAN. The client needs to send a new request to be authenticated by the Switch again.
Reauth	Specify if a subscriber has to periodically re-enter his or her user name and password to stay connected to the port.
Reauth-period secs	Specify the length of time required to pass before a client has to re-enter his or her user name and password to stay connected to the port.
Quiet-period secs	Specify the number of seconds the port remains in the HELD state and rejects further authentication requests from the connected client after a failed authentication exchange.
Tx-period secs	Specify the number of seconds the Switch waits for client's response before re-sending an identity request to the client.
Supp-Timeout secs	Specify the number of seconds the Switch waits for client's response to a challenge request before sending another request.
Apply	Click Apply to save your changes to the Switch's run-time memory. The Switch loses these changes if it is turned off or loses power, so use the Save link on the top navigation panel to save your changes to the non-volatile memory when you are done configuring.
Cancel	Click Cancel to begin configuring this screen afresh.

77.3 Activate MAC Authentication

Use this screen to activate MAC authentication. Click **SECURITY > Port Authentication > MAC Authentication** to display the configuration screen as shown.

Figure 472 SECURITY > Port Authentication > MAC Authentication (Standalone Mode)

MAC Authentication

Active OFF

Name Prefix

Delimiter

Case Upper Lower

Password Type Static MAC-Address

Password

Timeout

Port	Active	Trusted-VLAN List
*	<input type="checkbox"/>	<input type="text"/>
1	<input type="checkbox"/>	<input type="text"/>
2	<input type="checkbox"/>	<input type="text"/>
3	<input type="checkbox"/>	<input type="text"/>
4	<input type="checkbox"/>	<input type="text"/>
5	<input type="checkbox"/>	<input type="text"/>
6	<input type="checkbox"/>	<input type="text"/>
7	<input type="checkbox"/>	<input type="text"/>

Figure 473 SECURITY > Port Authentication > MAC Authentication (Stacking Mode)

MAC Authentication

Active OFF

Name Prefix

Delimiter

Case Upper Lower

Password Type Static MAC-Address

Password

Timeout

SLOT 1

Port	Active	Trusted-VLAN List
1/*	<input type="checkbox"/>	<input type="text"/>
1/1	<input type="checkbox"/>	<input type="text"/>
1/2	<input type="checkbox"/>	<input type="text"/>
1/3	<input type="checkbox"/>	<input type="text"/>
1/4	<input type="checkbox"/>	<input type="text"/>
1/5	<input type="checkbox"/>	<input type="text"/>
1/6	<input type="checkbox"/>	<input type="text"/>
1/7	<input type="checkbox"/>	<input type="text"/>

The following table describes the labels in this screen.

Table 311 SECURITY > Port Authentication > MAC Authentication

LABEL	DESCRIPTION
Active	Enable the switch button to permit MAC authentication on the Switch. Note: You must first enable MAC authentication on the Switch before configuring it on each port.
Name Prefix	Type the prefix that is appended to all MAC addresses sent to the RADIUS server for authentication. You can enter up to 32 printable ASCII characters except [?], [], ['], ["] or [,]. If you leave this field blank, then only the MAC address of the client is forwarded to the RADIUS server.
Delimiter	Select the delimiter the RADIUS server uses to separate the pairs in MAC addresses used as the account user name (and password). You can select Dash (-), Colon (:), or None to use no delimiters at all in the MAC address.
Case	Select the case (Upper or Lower) the RADIUS server requires for letters in MAC addresses used as the account user name (and password).
Password Type	Select Static to have the Switch send the password you specify below or MAC-Address to use the client MAC address as the password.

Table 311 SECURITY > Port Authentication > MAC Authentication (continued)

LABEL	DESCRIPTION
Password	Type the password the Switch sends along with the MAC address of a client for authentication with the RADIUS server. You can enter up to 32 printable ASCII characters except [?], [], ['], ["] or [,].
Timeout	<p>Specify the amount of time before the Switch allows a client MAC address that fails authentication to try and authenticate again. Maximum time is 3000 seconds.</p> <p>When a client fails MAC authentication, its MAC address is learned by the MAC address table with a status of denied. The timeout period you specify here is the time the MAC address entry stays in the MAC address table until it is cleared. If you specify 0 for the timeout value, the Switch uses the Aging Time configured in the SYSTEM > Switch Setup screen.</p> <p>Note: If the Aging Time in the SYSTEM > Switch Setup screen is set to a lower value, then it supersedes this setting.</p>
SLOT	This field appears only in Stacking mode. Click the drop-down list to choose the slot number of the Switch in a stack.
Port	This field displays the port number. In Stacking mode, the first number represents the slot ID and the second is the port number. Please note that the default stacking ports (the last four ports of your Switch) cannot be configured. They are reserved for stacking only.
*	<p>Use this row to make the setting the same for all ports. Use this row first and then make adjustments on a port-by-port basis.</p> <p>Note: Changes in this row are copied to all the ports as soon as you make them.</p>
Active	Select this check box to permit MAC authentication on this port. You must first allow MAC authentication on the Switch before configuring it on each port.
Trusted-VLAN List	Enter the ID numbers of the trusted VLANs (separated by a comma). If a client's VLAN ID is specified here, the client can access the port and the connected networks without MAC authentication.
Apply	Click Apply to save your changes to the Switch's run-time memory. The Switch loses these changes if it is turned off or loses power, so use the Save link on the top navigation panel to save your changes to the non-volatile memory when you are done configuring.
Cancel	Click Cancel to begin configuring this screen afresh.

77.4 Guest VLAN

When 802.1x or MAC Authentication is enabled on the Switch and its ports, clients that do not have the correct credentials are blocked from using the ports. You can configure your Switch to have one VLAN that acts as a guest VLAN. If you enable the guest VLAN (**102** in the example) on a port (**2** in the example), the user (**A** in the example) that is not IEEE 802.1x capable or fails to enter the correct user name and password can still access the port, but traffic from the user is forwarded to the guest VLAN. That is, unauthenticated users can have access to limited network resources in the same guest VLAN, such as the Internet. The access granted to the Guest VLAN depends on how the network administrator configures switches or routers with the guest network feature.

Figure 474 Guest VLAN Example

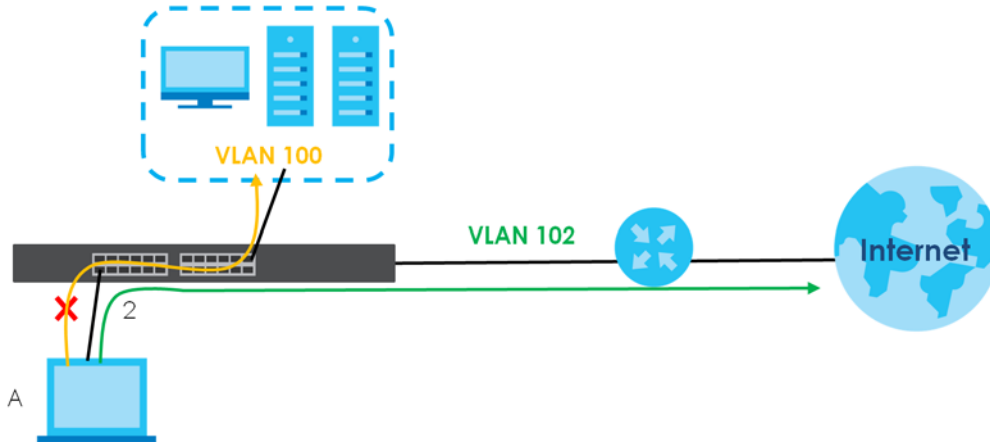

Use this screen to enable and assign a guest VLAN to a port. Click **SECURITY > Port Authentication > Guest VLAN** to display the configuration screen as shown.

Figure 475 SECURITY > Port Authentication > Guest VLAN (Standalone Mode)

Guest VLAN

Port	Active	Guest VLAN	Host-mode	Multi-secure Num
*	<input type="checkbox"/>	<input type="text"/>	Multi-Host <input type="text"/>	<input type="text"/>
1	<input type="checkbox"/>	<input type="text" value="1"/>	Multi-Host <input type="text"/>	<input type="text" value="1"/>
2	<input type="checkbox"/>	<input type="text" value="1"/>	Multi-Host <input type="text"/>	<input type="text" value="1"/>
3	<input type="checkbox"/>	<input type="text" value="1"/>	Multi-Host <input type="text"/>	<input type="text" value="1"/>
4	<input type="checkbox"/>	<input type="text" value="1"/>	Multi-Host <input type="text"/>	<input type="text" value="1"/>
5	<input type="checkbox"/>	<input type="text" value="1"/>	Multi-Host <input type="text"/>	<input type="text" value="1"/>
6	<input type="checkbox"/>	<input type="text" value="1"/>	Multi-Host <input type="text"/>	<input type="text" value="1"/>
7	<input type="checkbox"/>	<input type="text" value="1"/>	Multi-Host <input type="text"/>	<input type="text" value="1"/>

Figure 476 SECURITY > Port Authentication > Guest VLAN (Stacking Mode)

Guest VLAN

SLOT 1 ▾

Port	Active	Guest VLAN	Host-mode	Multi-secure Num
1/*	<input type="checkbox"/>	<input type="text"/>	Multi-Host ▾	<input type="text"/>
1/1	<input type="checkbox"/>	1	Multi-Host ▾	1
1/2	<input type="checkbox"/>	1	Multi-Host ▾	1
1/3	<input type="checkbox"/>	1	Multi-Host ▾	1
1/4	<input type="checkbox"/>	1	Multi-Host ▾	1
1/5	<input type="checkbox"/>	1	Multi-Host ▾	1
1/6	<input type="checkbox"/>	1	Multi-Host ▾	1
1/7	<input type="checkbox"/>	1	Multi-Host ▾	1

Apply Cancel

The following table describes the labels in this screen.

Table 312 SECURITY > Port Authentication > Guest VLAN

LABEL	DESCRIPTION
SLOT	This field appears only in Stacking mode. Click the drop-down list to choose the slot number of the Switch in a stack.
Port	This field displays the port number. In Stacking mode, the first number represents the slot ID and the second is the port number. Please note that the default stacking ports (the last four ports of your Switch) cannot be configured. They are reserved for stacking only.
*	Settings in this row apply to all ports. Use this row only if you want to make some settings the same for all ports. Use this row first to set the common settings and then make adjustments on a port-by-port basis. Changes in this row are copied to all the ports as soon as you make them.
Active	Select this check box to enable the guest VLAN feature on this port. Clients that fail authentication are placed in the guest VLAN and can receive limited services.
Guest VLAN	A guest VLAN is a pre-configured VLAN on the Switch that allows non-authenticated users to access limited network resources through the Switch. You must also enable IEEE 802.1x authentication on the Switch and the associated ports. Enter the number that identifies the guest VLAN. Make sure this is a VLAN recognized in your network.
Host-mode	Specify how the Switch authenticates users when more than one user connect to the port (using a hub). Select Multi-Host to authenticate only the first user that connects to this port. If the first user enters the correct credential, any other users are allowed to access the port without authentication. If the first user fails to enter the correct credential, they are all put in the guest VLAN. Once the first user who did authentication logs out or disconnects from the port, the rest of the users are blocked until a user does the authentication process again. Select Multi-Secure to authenticate each user that connects to this port.

Table 312 SECURITY > Port Authentication > Guest VLAN (continued)

LABEL	DESCRIPTION
Multi-secure Num	If you set Host-mode to Multi-Secure , specify the maximum number of users (between 1 and 24) that the Switch will authenticate on this port.
Apply	Click Apply to save your changes to the Switch's run-time memory. The Switch loses these changes if it is turned off or loses power, so use the Save link on the top navigation panel to save your changes to the non-volatile memory when you are done configuring.
Cancel	Click Cancel to begin configuring this screen afresh.

77.5 Compound Authentication

Use this screen to allow network access for clients that:

- pass either IEEE 802.1x authentication OR MAC authentication, or
- pass both IEEE 802.1x authentication AND MAC authentication.

The authentication modes are:

- In IEEE 802.1x authentication, the Switch prompts the client for login information in the form of a user name and password. When the client provides the login credentials, the Switch sends an authentication request to a RADIUS server. The RADIUS server validates whether this client is allowed access to the port. Use the **SECURITY > AAA > RADIUS Server Setup** screen to configure the RADIUS server.
- In MAC authentication, the login credentials are based on the source MAC address of the client connecting to a port on the Switch along with a password configured specifically for MAC authentication on the Switch.

Click **SECURITY > Port Authentication > Compound Authentication Mode** to display the configuration screen as shown.

Figure 477 SECURITY > Port Authentication > Compound Authentication Mode (Standalone Mode)

Port	Compound Authentication Mode
*	Strict ▼
1	Strict ▼
2	Strict ▼
3	Strict ▼
4	Strict ▼
5	Strict ▼
6	Strict ▼
7	Strict ▼

Figure 478 SECURITY > Port Authentication > Compound Authentication Mode (Stacking Mode)

The screenshot shows the 'Compound Authentication Mode' configuration interface. At the top, there is a tab labeled 'Compound Authentication Mode' and a dropdown menu for 'SLOT 1'. Below this is a table with two columns: 'Port' and 'Compound Authentication Mode'. The 'Port' column contains the following entries: 1/*, 1/1, 1/2, 1/3, 1/4, 1/5, 1/6, and 1/7. The 'Compound Authentication Mode' column contains a dropdown menu set to 'Strict' for each port. At the bottom of the screen, there are two buttons: 'Apply' (highlighted in green) and 'Cancel'.

The following table describes the labels in this screen.

Table 313 SECURITY > Port Authentication > Compound Authentication Mode

LABEL	DESCRIPTION
SLOT	This field appears only in Stacking mode. Click the drop-down list to choose the slot number of the Switch in a stack.
Port	This field displays the port number. In Stacking mode, the first number represents the slot ID and the second is the port number. Please note that the default stacking ports (the last four ports of your Switch) cannot be configured. They are reserved for stacking only.
*	Settings in this row apply to all ports. Use this row only if you want to make some settings the same for all ports. Use this row first to set the common settings and then make adjustments on a port-by-port basis. Changes in this row are copied to all the ports as soon as you make them.
Compound Authentication Mode	Specify how the Switch authenticates clients for network access. Select Strict to allow network access to clients only when clients passes IEEE 802.1x authentication AND MAC authentication at the same time. Select Loose to allow network access to clients when clients passes IEEE 802.1x authentication OR MAC authentication.
Apply	Click Apply to save your changes to the Switch's run-time memory. The Switch loses these changes if it is turned off or loses power, so use the Save link on the top navigation panel to save your changes to the non-volatile memory when you are done configuring.
Cancel	Click Cancel to begin configuring this screen afresh.

77.6 Technical Reference

This section provides technical background information on the topics discussed in this chapter.

77.6.1 IEEE 802.1x

The IEEE 802.1x is a standard for authentication as well as providing additional accounting and control features. It can be implemented both on wired and wireless networks. It is supported by Windows XP and a number of network devices. Some advantages of IEEE 802.1x are:

- User based identification
- Support for RADIUS (Remote Authentication Dial In User Service, RFC 2138, 2139) for centralized user profile and accounting management on a network RADIUS server.
- Support for EAP (Extensible Authentication Protocol, RFC 2486) that allows additional authentication methods to be deployed with no changes to the switch or the wired clients.

77.6.2 RADIUS

RADIUS is based on a client-server model that supports authentication, authorization and accounting. The RADIUS server handles the following tasks:

- Authentication

Determines the identity of the users.

- Authorization

Determines the network services available to authenticated users once they are connected to the network.

- Accounting

Keeps track of the actions that are performed on the switch, such as login events.

RADIUS is a simple package exchange in which your switch acts as a message relay between the wired client and the network RADIUS server.

77.6.2.1 Types of RADIUS Messages

The following types of RADIUS messages are exchanged between the switch and the RADIUS server for user authentication:

- Access-Request

Sent by a switch requesting authentication.

- Access-Reject

Sent by a RADIUS server rejecting access.

- Access-Accept

Sent by a RADIUS server allowing access.

- Access-Challenge

Sent by a RADIUS server requesting more information in order to allow access. The switch sends a proper response from the user and then sends another Access-Request message.

The following types of RADIUS messages are exchanged between the switch and the RADIUS server for user accounting:

- Accounting-Request

Sent by the switch requesting accounting.

- Accounting-Response

Sent by the RADIUS server to indicate that it has started or stopped accounting.

The switch and the RADIUS server use a shared secret key, which is a password, they both know to authenticate the communications between them, and ensure network security. A shared key is not sent over the network.

The switch forwards the RADIUS requests of a client to the RADIUS server. The login password information exchanged is sent over the network and encrypted to protect the network from unauthorized access.

77.6.3 EAP (Extensible Authentication Protocol) Authentication

This section discusses some popular authentication types: EAP-MD5, EAP-TLS, EAP-TTLS, PEAP and LEAP. Your wired LAN device may not support all authentication types.

EAP (Extensible Authentication Protocol) is an authentication protocol that runs on top of the IEEE 802.1x transport mechanism in order to support multiple types of user authentication. By using EAP to interact with an EAP-compatible RADIUS server, a switch helps a wired station and a RADIUS server perform authentication.

The type of authentication you use depends on the RADIUS server and an intermediary switch that supports IEEE 802.1x.

For EAP-TLS authentication type, you must first have a wired connection to the network and obtain the certificates from a certificate authority (CA). A certificate (also called digital IDs) can be used to authenticate users and a CA issues certificates and guarantees the identity of each certificate owner.

- EAP-MD5 (Message-Digest Algorithm 5)

MD5 authentication is the simplest one-way authentication method. The authentication server sends a challenge to the wired client. The wired client 'proves' that it knows the password by encrypting the password with the challenge and sends back the information. Password is not sent in plain text.

However, MD5 authentication has some weaknesses. Since the authentication server needs to get the plain text passwords, the passwords must be stored. Thus someone other than the authentication server may access the password file. In addition, it is possible to impersonate an authentication server as MD5 authentication method does not perform mutual authentication. Finally, MD5 authentication method does not support data encryption with dynamic session key. You must configure WEP encryption keys for data encryption.

- EAP-TLS (Transport Layer Security)

With EAP-TLS, digital certifications are needed by both the server and the wired clients for mutual authentication. The server presents a certificate to the client. After validating the identity of the server, the client sends a different certificate to the server. The exchange of certificates is done in the open before a secured tunnel is created. This makes user identity vulnerable to passive attacks. A digital certificate is an electronic ID card that authenticates the sender's identity. However, to implement

EAP-TLS, you need a Certificate Authority (CA) to handle certificates, which imposes a management overhead.

- EAP-TTLS (Tunneled Transport Layer Service)

EAP-TTLS is an extension of the EAP-TLS authentication that uses certificates for only the server-side authentications to establish a secure connection. Client authentication is then done by sending user name and password through the secure connection, thus client identity is protected. For client authentication, EAP-TTLS supports EAP methods and legacy authentication methods such as PAP, CHAP, MS-CHAP and MS-CHAP v2.

- PEAP (Protected EAP)

Like EAP-TTLS, server-side certificate authentication is used to establish a secure connection, then use simple user name and password methods through the secured connection to authenticate the clients, thus hiding client identity. However, PEAP only supports EAP methods, such as EAP-MD5, EAP-MSCHAPv2 and EAP-GTC (EAP-Generic Token Card), for client authentication. EAP-GTC is implemented only by Cisco.

- LEAP

LEAP (Lightweight Extensible Authentication Protocol) is a Cisco implementation of IEEE 802.1x.

77.6.4 EAPOL (EAP over LAN)

EAPOL is a port authentication protocol used in IEEE 802.1x. It encapsulates and sends EAP packets from the LAN. EAPOL exchanges the following messages between a wired client and switch.

- EAPOL-Start

A wired client will send this message to a switch to let it know the wired client is ready.

- EAPOL-Key

The switch will send an encryption key to the wired client. It will be allowed access to the network when both of the switch and wired client have the correct encryption keys.

- EAPOL-Packet

Both of the wired client and the switch will send this message to complete the authentication process.

- EAPOL-Logoff

This message will be sent when the wired client wants to be disconnected from the network.

- EAPOL-Encapsulated-ASF-Alert

This message is sent if the authentication process is not completed yet, and alerts needs to be forwarded.

CHAPTER 78

Port Security

78.1 Port Security Overview

This chapter shows you how to set up port security.

78.2 About Port Security

Port security allows only packets with dynamically learned MAC addresses and/or configured static MAC addresses to pass through a port on the Switch. The Switch can learn up to 32K 8k MAC addresses in total with no limit on individual ports other than the sum cannot exceed 32K 8k.

For maximum port security, enable this feature, disable MAC address learning and configure static MAC addresses for a port. It is not recommended you disable port security together with MAC address learning as this will result in many broadcasts. By default, MAC address learning is still enabled even though the port security is not activated.

78.3 Port Security Setup

Click **SECURITY > Port Security** in the navigation panel to display the screen as shown.

Figure 479 SECURITY > Port Security (Standalone Mode)

Port Security

MAC Freeze

Port List MAC Freeze

Port Security

Active ON

Port	Active	Address Learning	Limited Number of Learned MAC Address
-	<input type="checkbox"/>	<input type="checkbox"/>	<input type="text"/>
1	<input type="checkbox"/>	<input checked="" type="checkbox"/>	0 <input type="text"/>
2	<input type="checkbox"/>	<input checked="" type="checkbox"/>	0 <input type="text"/>
3	<input type="checkbox"/>	<input checked="" type="checkbox"/>	0 <input type="text"/>
4	<input type="checkbox"/>	<input checked="" type="checkbox"/>	0 <input type="text"/>
5	<input type="checkbox"/>	<input checked="" type="checkbox"/>	0 <input type="text"/>
6	<input type="checkbox"/>	<input checked="" type="checkbox"/>	0 <input type="text"/>
7	<input type="checkbox"/>	<input checked="" type="checkbox"/>	0 <input type="text"/>
8	<input type="checkbox"/>	<input checked="" type="checkbox"/>	0 <input type="text"/>

Apply
Cancel

Figure 480 SECURITY > Port Security (Stacking Mode)

Port Security

MAC Freeze

Port List **MAC Freeze**

Port Security

Active ON

SLOT 1

Port	Active	Address Learning	Limited Number of Learned MAC Address
1/*	<input type="checkbox"/>	<input type="checkbox"/>	<input type="text"/>
1/1	<input type="checkbox"/>	<input checked="" type="checkbox"/>	<input type="text" value="0"/>
1/2	<input type="checkbox"/>	<input checked="" type="checkbox"/>	<input type="text" value="0"/>
1/3	<input type="checkbox"/>	<input checked="" type="checkbox"/>	<input type="text" value="0"/>
1/4	<input type="checkbox"/>	<input checked="" type="checkbox"/>	<input type="text" value="0"/>
1/5	<input type="checkbox"/>	<input checked="" type="checkbox"/>	<input type="text" value="0"/>
1/6	<input type="checkbox"/>	<input checked="" type="checkbox"/>	<input type="text" value="0"/>
1/7	<input type="checkbox"/>	<input checked="" type="checkbox"/>	<input type="text" value="0"/>
1/8	<input type="checkbox"/>	<input checked="" type="checkbox"/>	<input type="text" value="0"/>
1/9	<input type="checkbox"/>	<input checked="" type="checkbox"/>	<input type="text" value="0"/>
1/10	<input type="checkbox"/>	<input checked="" type="checkbox"/>	<input type="text" value="0"/>
1/11	<input type="checkbox"/>	<input checked="" type="checkbox"/>	<input type="text" value="0"/>
1/12	<input type="checkbox"/>	<input checked="" type="checkbox"/>	<input type="text" value="0"/>

Apply **Cancel**

The following table describes the labels in this screen.

Table 314 SECURITY > Port Security

LABEL	DESCRIPTION
Port List	Enter the number of the ports (separated by a comma) on which you want to enable port security and disable MAC address learning. In Stacking mode, the first number represents the slot and the second the port number. Enter 1/1-1/24,2/23 for ports 1 to 24 for the Switch in slot 1 and port 23 for the Switch in slot 2, for example. After you click MAC Freeze , all previously learned MAC addresses on the specified ports will become static MAC addresses and display in the SWITCHING > Static MAC Forwarding screen.
MAC Freeze	Click MAC Freeze to have the Switch automatically select the Active check boxes and clear the Address Learning check boxes only for the ports specified in the Port List .
Port Security	
Active	Enable the switch button to enable port security on the Switch.
SLOT	This field appears only in Stacking mode. Click the drop-down list to choose the slot number of the Switch in a stack.
Port	This field displays the port number. In Stacking mode, the first number represents the slot ID and the second is the port number. Please note that the default stacking ports (the last four ports of your Switch) cannot be configured. They are reserved for stacking only.

Table 314 SECURITY > Port Security (continued)

LABEL	DESCRIPTION
*	<p>Settings in this row apply to all ports.</p> <p>Use this row only if you want to make some of the settings the same for all ports. Use this row first to set the common settings and then make adjustments on a port-by-port basis.</p> <p>Note: Changes in this row are copied to all the ports as soon as you make them.</p>
Active	<p>Select this check box to enable the port security feature on this port. The Switch forwards packets whose MAC addresses is in the MAC address table on this port. Packets with no matching MAC addresses are dropped.</p> <p>Clear this check box to disable the port security feature. The Switch forwards all packets on this port.</p>
Address Learning	<p>MAC address learning reduces outgoing broadcast traffic. For MAC address learning to occur on a port, the port itself must be active with address learning enabled.</p>
Limited Number of Learned MAC Address	<p>Use this field to limit the number of (dynamic) MAC addresses that may be learned on a port. For example, if you set this field to "5" on port 2, then only the devices with these five learned MAC addresses may access port 2 at any one time. A sixth device must wait until one of the five learned MAC addresses ages out. MAC address aging out time can be set in the SYSTEM > Switch Setup screen. The valid range is from "0" to "32K". "0" means this feature is disabled.</p>
Apply	<p>Click Apply to save your changes to the Switch's run-time memory. The Switch loses these changes if it is turned off or loses power, so use the Save link on the top navigation panel to save your changes to the non-volatile memory when you are done configuring.</p>
Cancel	<p>Click Cancel to begin configuring this screen afresh.</p>

CHAPTER 79

MAINTENANCE

79.1 Overview

This chapter explains how to configure the screens that let you maintain the firmware and configuration files.

79.1.1 What You Can Do

- Use the **Certificates** screen ([Section 79.2 on page 603](#)) to see the **Certificates** screen and import the Switch's CA-signed certificates.
- Use the **Cluster Management** screens ([Section 79.5 on page 608](#)) to manage the switches within a cluster and view cluster status.
- Use the **Restore Configuration** screen ([Section 79.8 on page 613](#)) to upload a stored device configuration file.
- Use the **Backup Configuration** screen ([Section 79.9 on page 613](#)) to save your configurations for later use.
- Use the **Auto Configuration** screen ([Section 79.10 on page 614](#)) to overwrite the running configuration stored in the Switch's RAM.
- Use the **Erase Running-Configuration** screen ([Section 79.11 on page 615](#)) to reset the configuration to the Zyxel default configuration settings.
- Use the **Save Configuration** screen ([Section 79.12 on page 616](#)) to save the current configuration settings to a specific configuration file on the Switch.
- Use the **Configure Clone** screen ([Section 79.13 on page 617](#)) to copy the basic and advanced settings from a source port to a destination port or ports.
- Use the **Diagnostic** screen ([Section 79.14 on page 619](#)) to ping IP addresses, run a traceroute, perform port tests or show the Switch's location between devices.
- Use the **Firmware Upgrade** screen ([Section 79.15 on page 622](#)) to upload the latest firmware.
- Use the **Reboot System** screen ([Section 79.16 on page 625](#)) to restart the Switch without physically turning the power off and load a specific configuration file.
- Use the **Tech-Support** screen ([Section 79.17 on page 627](#)) to create reports for customer support if there are problems with the Switch.

79.2 Certificates

The Switch can use HTTPS certificates that are verified by a third party to create secure HTTPS connections between your computer and the Switch. This way, you may securely access the Switch using the Web Configurator. See [Section 67.5.2 on page 505](#) for more information about HTTPS.

Certificates are based on public-private key pairs. A certificate contains the certificate owner's identity and public key. Certificates provide a way to exchange public keys for use in authentication.

Click **MAINTENANCE > Certificates** to open the following screen. Use this screen to import the Switch's CA-signed certificates.

Figure 481 MAINTENANCE > Certificates

Certificates

Certificates

Please specify the location of the HTTPS certificate file to be imported. The certificate file must be the Binary PKCS#12 format.

File Path No file chosen

Password

<input type="checkbox"/>	Service	Subject	Issuer	Valid From	Valid To
<input type="checkbox"/>	HTTPS	/CN=XS3800 bc99119bb8c3	Mar 27 00:00:43 2081 GMT		

The following table describes the labels in this screen.

Table 315 MAINTENANCE > Certificates

LABEL	DESCRIPTION
File Path	Click Choose File or Browse to find the certificate file you want to upload.
Password	Enter the certificate file's password that was created when the PKCS #12 file was exported. The password consists of up to 32 printable ASCII characters except [?], [], ['], ["] or [,].
Import	Click this button to save the certificate that you have enrolled from a certification authority from your computer to the Switch.
Synchronize Certificate	Note: This part only appears in Stacking mode.
Active	Enable this option to allow the master Switch in Stacking mode to synchronize CA-signed certificates to all stacking members and save it to their non-volatile memory. Or, delete the stacking members' CA-signed certificate if a CA-signed certificate does not exist in the master Switch. Otherwise, disable this option.
Apply	Click Apply to save your changes to the Switch's run-time memory. The Switch loses these changes if it is turned off or loses power, so use the Save link on the top navigation panel to save your changes to the non-volatile memory when you are done configuring.
Cancel	Click Cancel to begin configuring this screen afresh.
Service	This field displays the service type that this certificate is for.
Subject	This field displays identifying information about the certificate's owner, such as CN (Common Name), OU (Organizational Unit or department), O (Organization or company) and C (Country). It is recommended that each certificate have unique subject information.
Issuer	This field displays identifying information about the certificate's issuing certification authority, such as a common name, organizational unit or department, organization or company and country.
Valid From	This field displays the date that the certificate becomes applicable.
Valid To	This field displays the date that the certificate expires.

Table 315 MAINTENANCE > Certificates (continued)

LABEL	DESCRIPTION
	Select an entry's check box to select a specific entry.
Delete	Click this button to delete the certificate (or certification request). You cannot delete a certificate that one or more features is configured to use.

79.2.1 HTTPS Certificates

Use this screen to view the HTTPS certificate details. Click a hyperlink in the **Service** column in the **MAINTENANCE > Certificates** screen to open the following screen.

Figure 482 MAINTENANCE > Certificates > HTTPS

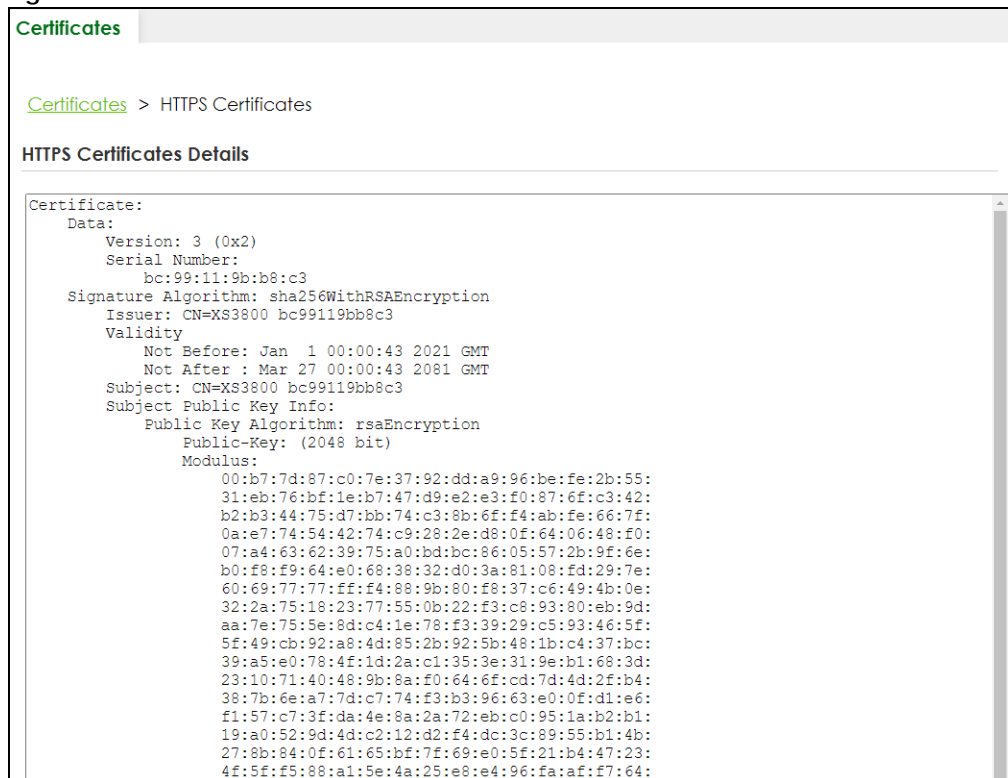

79.3 Technical Reference

This section provides technical background information on the topics discussed in this chapter.

79.3.1 FTP Command Line

This section shows some examples of uploading to or downloading files from the Switch using FTP commands. First, understand the filename conventions.

79.3.2 Filename Conventions

The configuration file (also known as the romfile or ROM) contains the Zyxel factory default configuration settings in the screens such as password, Switch setup, IP Setup, and so on. Once you have customized the Switch's settings, they can be saved back to your computer under a filename of your choosing.

ZyNOS (Zyxel Network Operating System sometimes referred to as the "ras" file) is the system firmware and has a "bin" filename extension.

Table 316 Filename Conventions

FILE TYPE	INTERNAL NAME	EXTERNAL NAME	DESCRIPTION
Configuration File	config1 config2	*.cfg	This is the configuration filename on the Switch. Uploading the config file replaces the specified configuration file system, including your Switch configurations, system-related data (including the default password), the error log and the trace log.
Firmware	ras	*.bin	This is the generic name for the ZyNOS firmware on the Switch.

You can store up to two images, or firmware files of the same device model, on the Switch. Only one image is used at a time.

- Run the `boot image <1 | 2>` command to specify which image is updated when firmware is loaded using the Web Configurator and to specify which image is loaded when the Switch starts up.
- You can also use FTP commands to upload firmware to any image.

The Switch supports dual firmware images, `ras-0` and `ras-1`. You can switch from one to the other by using the `boot image <index>` command, where `<index>` is 1 (`ras-0`) or 2 (`ras-1`). See the CLI Reference Guide for more information about using commands. The system does not reboot after it switches from one image to the other.

79.3.2.1 Example FTP Commands

```
ftp> put firmware.bin ras-0
```

This is a sample FTP session showing the transfer of the computer file "firmware.bin" to the Switch's **Firmware 1**.

```
ftp> get config1 config1.cfg
```

This is a sample FTP session saving the Switch's configuration file 1 (**Config1**) to a file called "config1.cfg" on your computer.

If your (T)FTP client does not allow you to have a destination filename different than the source, you will need to rename them as the Switch only recognizes "config" and "ras". Be sure you keep unaltered copies of both files for later use.

Be sure to upload the correct model firmware as uploading the wrong model firmware may damage your device.

79.3.3 FTP Command Line Procedure

- 1 Launch the FTP client on your computer.
- 2 Enter `open`, followed by a space and the IP address of your Switch.
- 3 Press **[ENTER]** when prompted for a user name.
- 4 Enter your password as requested (the default is "1234").
- 5 Enter `bin` to set transfer mode to binary.
- 6 Use `put` to transfer files from the computer to the Switch, for example, `put firmware.bin ras` transfers the firmware on your computer (`firmware.bin`) to the Switch and renames it to "ras". Similarly, `put config.cfg config1` transfers the configuration file on your computer (`config.cfg`) to the Switch and renames it to "config1". Likewise `get config1 config.cfg` transfers the configuration file on the Switch to your computer and renames it to "config.cfg". See [Table 316 on page 606](#) for more information on filename conventions.
- 7 Enter `quit` to exit the ftp prompt.

79.3.4 GUI-based FTP Clients

The following table describes some of the commands that you may see in GUI-based FTP clients.

Table 317 General Commands for GUI-based FTP Clients

COMMAND	DESCRIPTION
Host Address	Enter the address of the host server.
Login Type	Anonymous. This is when a user I.D. and password is automatically supplied to the server for anonymous access. Anonymous logins will work only if your ISP or service administrator has enabled this option. Normal. The server requires a unique User ID and Password to login.
Transfer Type	Transfer files in either single-byte printable characters (plain text format) or in binary mode. Configuration and firmware files should be transferred in binary mode.
Initial Remote Directory	Specify the default remote directory (path).
Initial Local Directory	Specify the default local directory (path).

79.3.5 FTP Restrictions

FTP will not work when:

- FTP service is disabled in the **SECURITY > Access Control > Service Access Control** screen.
- The IP addresses in the **SECURITY > Access Control > Remote Management** screen does not match the client IP address. If it does not match, the Switch will disconnect the FTP session immediately.

79.4 Cluster Management Overview

Cluster Management allows you to manage switches through one Switch, called the cluster manager. The switches must be directly connected and be in the same VLAN group so as to be able to communicate with one another.

Table 318 Zyxel Clustering Management Specifications

Maximum number of cluster members	24
Cluster Member Models	Must be compatible with Zyxel cluster management implementation.
Cluster Manager	The Switch through which you manage the cluster member switches.
Cluster Members	The switches being managed by the cluster manager Switch.

In the following example, switch **A** in the basement is the cluster manager and the other switches on the upper floors of the building are cluster members.

Figure 483 Clustering Application Example

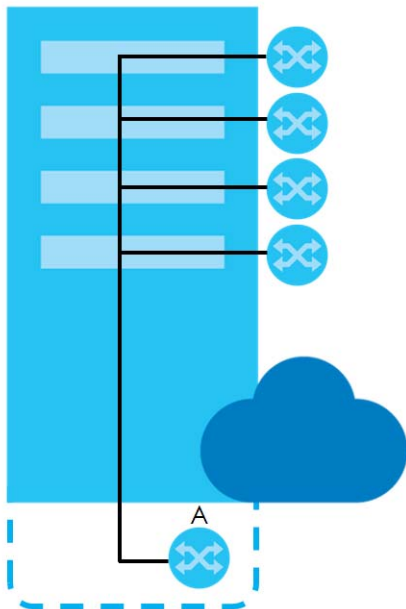

79.4.1 What You Can Do

- Use the **Cluster Management Status** screen ([Section 79.5 on page 608](#)) to view the role of the Switch within the cluster and to access a cluster member Switch's Web Configurator.
- Use the **Cluster Management Setup** screen ([Section 79.6 on page 609](#)) to configure clustering management.

79.5 Cluster Management Status

Use this screen to view the role of the Switch within the cluster and to access a cluster member Switch's Web Configurator.

Click **MAINTENANCE > Cluster Management** in the navigation panel to display the following screen.

Note: A cluster can only have one manager.

Figure 484 MAINTENANCE > Cluster Management > Cluster Management Status

Cluster Management Status		Cluster Management Setup		
Status	Manager			
Manager	bc:99:bc:99:bc:99			
The Number Of Member = 1				
Index	MAC Address	Name	Model	Status
1	bc:cf:bc:cf:bc:cf	X500	X500	On-Line

The following table describes the labels in this screen.

Table 319 MAINTENANCE > Cluster Management > Cluster Management Status

LABEL	DESCRIPTION
Status	This field displays the role of this Switch within the cluster. Manager Member (you see this if you access this screen in the cluster member Switch directly and not through the cluster manager) None (neither a manager nor a member of a cluster)
Manager	This field displays the cluster manager Switch's hardware MAC address.
The Number Of Member	This field displays the number of switches that make up this cluster. The following fields describe the cluster member switches.
Index	You can manage cluster member switches through the cluster manager Switch. Each number in the Index column is a hyperlink leading to the cluster member Switch's Web Configurator.
MAC Address	This is the cluster member Switch's hardware MAC address.
Name	This is the cluster member Switch's System Name .
Model	This field displays the model name.
Status	This field displays: Online (the cluster member Switch is accessible) Error (for example the cluster member Switch password was changed or the Switch was set as the manager and so left the member list, and so on) Offline (the Switch is disconnected – Offline shows approximately 1.5 minutes after the link between cluster member and manager goes down)

79.6 Clustering Management Setup

Use this screen to configure clustering management. Click **MAINTENANCE > Cluster Management > Cluster Management Setup** to display the next screen.

Figure 485 MAINTENANCE > Cluster Management > Cluster Management Setup

Cluster Management Status **Cluster Management Setup**

Clustering Manager

Active OFF

Name

VID

Apply **Cancel**

Clustering Candidate

<input type="checkbox"/>	Index	MAC Address	Name	Model
<input type="checkbox"/>	1	bc:4f:4f:4f:bc:bc	X500	X500

The following table describes the labels in this screen.

Table 320 MAINTENANCE > Cluster Management > Cluster Management Setup

LABEL	DESCRIPTION
Clustering Manager	The following fields relate to configuring the cluster manager.
Active	Enable the switch button to have this Switch become the cluster manager switch. A cluster can only have one manager. Other (directly connected) switches that are set to be cluster managers will not be visible in the Clustering Candidates list. If a Switch that was previously a cluster member is later set to become a cluster manager, then its Status is displayed as Error in the Cluster Management Status screen and a warning icon (⚠) appears in the member summary list below.
Name	Type a name to identify the Clustering Manager . You may use up to 32 printable ASCII characters except [?], [], ['], ["] or [,]. (spaces are allowed).
VID	This is the VLAN ID and is only applicable if the Switch is set to 802.1Q VLAN. All switches must be directly connected and in the same VLAN group to belong to the same cluster. Switches that are not in the same VLAN group are not visible in the Clustering Candidates list. This field is ignored if the Clustering Manager is using Port-based VLAN.
Apply	Click Apply to save your changes to the Switch's run-time memory. The Switch loses these changes if it is turned off or loses power, so use the Save link on the top navigation panel to save your changes to the non-volatile memory when you are done configuring.
Cancel	Click Cancel to begin configuring this screen afresh.
Clustering Candidate	The next summary table shows the information for the clustering members configured.
Add/Edit	Click this button to create or configure a clustering candidate.
Delete	Click this button to remove the clustering candidate.
	Select an entry's check box to select a specific entry. Otherwise, select the check box in the table heading row to select all entries.
Index	This is the index number of a cluster member switch.
MAC Address	This is the cluster member switch's hardware MAC address.
Name	This is the cluster member switch's System Name .
Model	This is the cluster member switch's model name.

Click the **Add/Edit** button to open the **Add/Edit** screen. Use this screen to configure a clustering candidate for the Switch.

Figure 486 MAINTENANCE > Cluster Management > Cluster Management Setup > Add/Edit

The following table describes the labels in this screen.

Table 321 MAINTENANCE > Cluster Management > Cluster Management Setup > Add/Edit

LABEL	DESCRIPTION
List	A list of suitable candidates found by auto-discovery is shown here. The switches must be directly connected. Directly connected switches that are set to be cluster managers will not be visible in the Clustering Candidate list. Switches that are not in the same management VLAN group will not be visible in the Clustering Candidate list.
Password	Each cluster member's password is its Web Configurator password. Select a member in the Clustering Candidate list and then enter its Web Configurator password. If that switch administrator changes the Web Configurator password afterwards, then it cannot be managed from the Cluster Manager . Its Status is displayed as Error in the Cluster Management Status screen. If multiple devices have the same password then hold [SHIFT] and click those switches to select them. Then enter their common Web Configurator password. You can enter up to 32 printable ASCII characters except [?], [], ['], ["] or [.].
Apply	Click Apply to save your changes to the Switch's run-time memory. The Switch loses these changes if it is turned off or loses power, so use the Save link on the top navigation panel to save your changes to the non-volatile memory when you are done configuring.
Clear	Click Clear to reset the fields to the factory defaults.
Cancel	Click Cancel to begin configuring this screen afresh.

79.7 Technical Reference

This section provides technical background information on the topics discussed in this chapter.

79.7.1 Cluster Member Switch Management

Go to the **MAINTENANCE > Clustering Management > Clustering Management Status** screen of the cluster manager switch and then select an **Index** hyperlink from the list of members to go to that cluster member switch's Web Configurator home page. This cluster member Web Configurator home page and the home page that you would see if you accessed it directly are different.

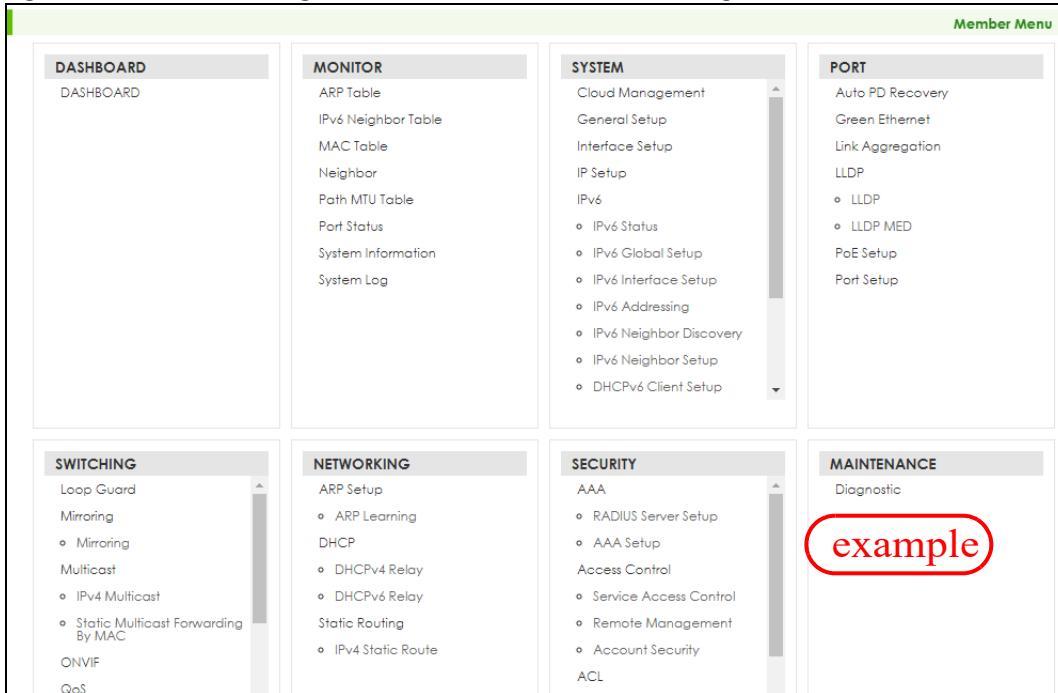
Figure 487 Cluster Management: Cluster Member Web Configurator Screen

79.7.1.1 Uploading Firmware to a Cluster Member Switch

You can use FTP to upload firmware to a cluster member switch through the cluster manager switch as shown in the following example.

Figure 488 Example: Uploading Firmware to a Cluster Member Switch

```

C:\>ftp 192.168.1.1
Connected to 192.168.1.1.
220 Switch FTP version 1.0 ready at Thu Jan  1 00:58:46 1970
User (192.168.0.1:(none)): admin
331 Enter PASS command
Password:
230 Logged in
ftp> ls
200 Port command okay
150 Opening data connection for LIST
--w--w--w-  1 owner   group           3042210 Jul  01 12:00 ras
-rw-rw-rw-  1 owner   group           393216  Jul  01 12:00 config
--w--w--w-  1 owner   group              0 Jul  01 12:00 fw-00-a0-c5-01-23-46
-rw-rw-rw-  1 owner   group              0 Jul  01 12:00 config-00-a0-c5-01-23-46
226 File sent OK
ftp: 297 bytes received in 0.00Seconds 297000.00Kbytes/sec.
ftp> bin
200 Type I OK
ftp> put 470ACAQ0.bin fw-00-a0-c5-01-23-46
200 Port command okay
150 Opening data connection for STOR fw-00-a0-c5-01-23-46
226 File received OK
ftp: 262144 bytes sent in 0.63Seconds 415.44Kbytes/sec.
ftp>

```

The following table explains some of the FTP parameters.

Table 322 FTP Upload to Cluster Member Example

FTP PARAMETER	DESCRIPTION
User	Enter "admin".
Password	The Web Configurator password default is 1234.
ls	Enter this command to list the name of cluster member switch's firmware and configuration file.
470ACAQ0.bin	This is the name of the firmware file you want to upload to the cluster member switch.
fw-00-a0-c5-01-23-46	This is the cluster member switch's firmware name as seen in the cluster manager switch.
config-00-a0-c5-01-23-46	This is the cluster member switch's configuration file name as seen in the cluster manager switch.

79.8 Restore Configuration

Use this screen to restore a previously saved configuration file (See [Section 79.9 on page 613](#) for more information on how to back up a configuration file) from your computer to the Switch.

Click **MAINTENANCE > Configuration > Restore Configuration** to access this screen.

Figure 489 MAINTENANCE > Configuration > Restore Configuration

- 1 Click **Choose File** or **Browse** to locate the configuration file you wish to restore.
- 2 After you have specified the file, click **Restore**.

The Switch will run on the restored configuration after the restore process.

Figure 490 Configuration Restoring

79.9 Backup Configuration

Backing up your Switch configurations allows you to create various "snap shots" of your device from which you may restore at a later date. Use this screen to back up your current Switch configuration to a computer.

To access this screen, click **MAINTENANCE > Configuration > Backup Configuration** in the navigation panel.

Figure 491 MAINTENANCE > Configuration > Backup Configuration

Backup Configuration

This page allows you to back up the device's current configuration to your workstation. Now click the Backup button.

Configuration

Follow the steps below to back up the current Switch configuration to your computer in this screen.

- 1 Select which Switch configuration file you want to download to your computer.
- 2 Click **Backup**.
- 3 If the current configuration file is open and/or downloaded to your computer automatically, you can click **File > Save As** on your computer to save the file to a specific place.

If a dialog box pops up asking whether you want to open or save the file, click **Save** or **Save File** to download it to the default downloads folder on your computer. If a **Save As** screen displays after you click **Save** or **Save File**, choose a location to save the file on your computer from the **Save in** drop-down list box and type a descriptive name for it in the **File name** list box. Click **Save** to save the configuration file to your computer.

79.10 Auto Configuration

The Switch can download a pre-saved auto configuration file automatically when you reboot the Switch using the DHCP or HTTPS mode. This will overwrite the running configuration stored in the Switch's RAM instead of the startup configuration stored in the Switch's flash memory.

To access this screen, click **MAINTENANCE > Configuration > Auto Configuration** in the navigation panel.

Figure 492 MAINTENANCE > Configuration > Auto Configuration

Auto Configuration

Mode None

State None

Filename

Active OFF

Mode

DHCP VLAN ID

HTTPS URL

The following table describes the labels in this screen.

Table 323 MAINTENANCE > Configuration > Auto Configuration

LABEL	DESCRIPTION
Use this section to view the auto configuration status after you restarted the Switch.	
Mode	This field shows the mode (DHCP or HTTPS) that is used for auto configuration after you enabled auto configuration and restarted the Switch. It shows None if auto configuration was not enabled.
State	This field shows whether auto configuration was executed successfully the last time the Switch rebooted. None – Auto configuration was disabled and not executed. Success – An auto configuration file was downloaded successfully to the Switch. Un-success – An auto configuration file was not downloaded to the Switch.
Filename	This field displays the name of the auto configuration file that was downloaded the last time the Switch rebooted. It shows blank if auto configuration was not enabled or not executed successfully.
Use this section to enable auto configuration and select the mode that you want to use for auto configuration.	
Active	Enable the switch button to enable auto configuration.
Mode	Select DHCP to have the Switch use the TFTP server IP address and auto configuration file name assigned by a DHCP server to download a pre-saved configuration file when the Switch reboots. Note: The Switch should act as a DHCP client to send a DHCP request with DHCP option 60 so that it can get the TFTP server address and configuration file name from the DHCP server. Select HTTPS to have the Switch use the URL you specified in the HTTPS URL field to access a web server and download the auto configuration file using HTTPS.
DHCP VLAN ID	Enter the VLAN ID of the DHCP server that assigns the TFTP server IP address and auto configuration file name to the Switch.
HTTPS URL	Enter the URL that can be used to access and download the auto configuration file from a web server using HTTPS. For example, https://webserverIPaddress/configfilename.cfg. Note: You must fill in this field if you select HTTPS in the Mode field. Otherwise, auto configuration will not work.
Apply	Click Apply to save your changes to the Switch's run-time memory. The Switch loses these changes if it is turned off or loses power, so use the Save link on the top navigation panel to save your changes to the non-volatile memory when you are done configuring.
Cancel	Click Cancel to begin configuring this screen afresh.

79.11 Erase Running-Configuration

Follow the steps below to clear current configuration on the Switch. Note that this will NOT reset the Switch back to its factory defaults. For example, if your Switch is set to Stacking mode and you click erase running-configuration, after the Switch restarts, it will remain in Stacking mode. If you want to change the Switch to its factory default Standalone mode, click the **Factory Default** button in **MAINTENANCE > Reboot System**.

To access this screen, click **MAINTENANCE** > **Configuration** > **Erase Running Configuration** in the navigation panel.

- 1 In the **Erase Running Configuration** screen, click the **Erase** button to clear all Switch configuration information you configured and return to the Zyxel default configuration settings.

Figure 493 MAINTENANCE > Configuration > Erase Running Configuration



- 2 Click **YES** to remove the running configuration on the Switch.

Figure 494 Erase Running Configuration: Confirmation

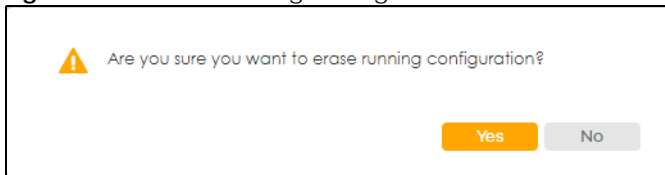

- 3 In the Web Configurator, click the **Save** button in the top of the screen to make the changes take effect. If you want to access the Switch Web Configurator again, you may need to change the IP address of your computer to be in the same subnet as that of the default Switch IP address (192.168.1.1 or DHCP-assigned IP).

79.12 Save Configuration

To access this screen, click **MAINTENANCE** > **Configuration** > **Save Configuration** in the navigation panel.

Click **Config 1** to save the current configuration settings permanently to **Configuration 1** on the Switch. These configurations are set up according to your network environment.

Click **Config 2** to save the current configuration settings permanently to **Configuration 2** on the Switch. These configurations are set up according to your network environment.

Click **Custom Default** to save the current configuration settings permanently to a customized default file on the Switch. If configuration changes cause the Switch to behave abnormally, click **Custom Default** (in the **MAINTENANCE** > **Reboot System** screen) to have the Switch automatically reboot and restore the saved **Custom Default** configuration file.

Figure 495 MAINTENANCE > Configuration > Save Configuration

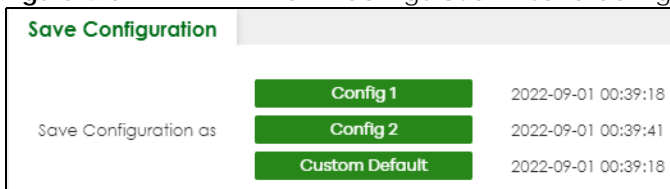

Note: If a customized default file was not saved, clicking **Custom Default** in the **MAINTENANCE** > **Reboot System** screen loads the factory default configuration on the Switch.

Alternatively, click **Save** on the top right in any screen to save the configuration changes to the current configuration.

Note: Clicking the **Apply** button after making configuration does NOT save the changes permanently. All unsaved changes are erased after you reboot the Switch.

79.13 Configure Clone

Cloning allows you to copy the basic and advanced settings from a source port to a destination port or ports. Click **MAINTENANCE > Configuration > Configure Clone** to open the following screen.

Figure 496 MAINTENANCE > Configuration > Configure Clone (Standalone Mode)

Configure Clone

Configure Clone

Source	Destination
Port 1	2

Port Features

- SYSTEM**
 - SNMP Trap
- PORT**
 - Active
 - Ethernet OAM
 - LLDP
 - Speed / Duplex
 - Auto PD Recovery
 - Flow Control
 - Name
 - ZULD
 - BPDU Control
 - Green Ethernet
 - Power over Ethernet
- SWITCHING**
 - Bandwidth Control
 - Layer 2 Protocol Tunneling
 - Mirroring
 - Multiple Spanning Tree Protocol
 - Protocol-based VLAN
 - STP
 - VLAN1q Member
 - Diffserv
 - Loop Guard
 - MLD Snooping-Proxy Filtering
 - Port-based VLAN
 - Queueing Method
 - VLAN1q
 - VLAN Stacking
 - IGMP Filtering
 - MAC Pinning
 - Multiple Rapid Spanning Tree Protocol
 - PPPoE IA
 - sFlow
 - VLAN Mapping
- NETWORKING**
 - ARP Learning
- SECURITY**
 - Anti-Arpscan
 - DHCP Snooping
 - MAC Authentication
 - Storm Control
 - ARP Inspection
 - DHCPv6 Trust Setup
 - Port Access Authenticator
 - CPU Protection
 - IPv6 Source Guard
 - Port Security

Apply **Cancel**

Figure 497 MAINTENANCE > Configuration > Configure Clone (Stacking Mode)

The following table describes the labels in this screen.

Table 324 MAINTENANCE > Configuration > Configure Clone

LABEL	DESCRIPTION
Configure Clone	
Source/ Destination	<p>In Stacking mode, a port is defined by a slot ID representing the Switch in the stack and a port number.</p> <p>Select the source port and slot (in Stacking mode) under the Source label. This port's attributes are copied.</p> <p>Enter the destination port or ports under the Destination label. These are the ports which are going to have the same attributes as the source port. You can enter individual ports separated by a comma or a range of ports by using a hyphen. For example, 2, 4, 6 indicates that ports 2, 4 and 6 are the destination ports. 2-6 indicates that ports 2 through 6 are the destination ports.</p> <p>In Stacking mode, you can select multiple destination slots.</p>
Port Features	
	Select a feature's check box to select a specific feature. Otherwise, select the check box in the table heading row to select all features for a category.
SYSTEM	Select the system feature (you configured in the SYSTEM menus) to be copied to the destination ports. Otherwise, select the SYSTEM check box in the table heading row to select all features for a category.
PORT	Select which port features (you configured in the PORT menus) should be copied to the destination ports. Otherwise, select the PORT check box in the table heading row to select all features for a category.

Table 324 MAINTENANCE > Configuration > Configure Clone (continued)

LABEL	DESCRIPTION
SWITCHING	Select which switching features (you configured in the SWITCHING menus) should be copied to the destination ports. Otherwise, select the SWITCHING check box in the table heading row to select all features for a category.
NETWORKING	Select the networking feature (you configured in the NETWORKING menus) to be copied to the destination ports. Otherwise, select the NETWORKING check box in the table heading row to select all features for a category.
SECURITY	Select which security features (you configured in the SECURITY menus) should be copied to the destination ports. Otherwise, select the SECURITY check box in the table heading row to select all features for a category.
Apply	Click Apply to save your changes to the Switch's run-time memory. The Switch loses these changes if it is turned off or loses power, so use the Save link on the top navigation panel to save your changes to the non-volatile memory when you are done configuring.
Cancel	Click Cancel to begin configuring this screen afresh.

79.14 Diagnostic

Click **MAINTENANCE > Diagnostic** in the navigation panel to open this screen. Use this screen to ping IP addresses, run a traceroute, perform port tests or show the Switch's location between devices.

Figure 498 MAINTENANCE > Diagnostic (Standalone Mode)

Diagnostic

- Info -

Ping Test

IPv4 IPv6

IP Address/Host Name:

Source IP Address:

Count:

Ping

Trace Route Test

IPv4 IPv6

IP Address/Host Name:

TTL:

Wait Time: Seconds

Queries:

Trace Route

Ethernet Port Test

Port:

Port Test

Cable Diagnostics ⓘ

Port:

Diagnose

Locator LED

Minutes

Blink **Stop**

Figure 499 MAINTENANCE > Diagnostic (Stacking Mode)

The following table describes the labels in this screen.

Table 325 MAINTENANCE > Diagnostic

LABEL	DESCRIPTION
Ping Test	
IPv4	Select this option if you want to ping an IPv4 address. Otherwise, select – to send ping requests to all VLANs on the Switch.
IPv6	Select this option if you want to ping an IPv6 address. You can also select vlan and specify the ID number of the VLAN to which the Switch is to send ping requests. Otherwise, select – to send ping requests to all VLANs on the Switch.
IP Address/Host Name	Type the IP address or host name of a device that you want to ping in order to test a connection. Click Ping to have the Switch ping the IP address.
Source IP Address	Type the source IP address that you want to ping in order to test a connection. Click Ping to have the Switch ping the IP address.
Count	Enter the number of ICMP Echo Request (ping) messages the Switch continuously sends.
Trace Route Test	
IPv4	Select this option if you want to trace the route packets taken to a device with an IPv4 address. Otherwise, select – to trace the path on any VLAN. Note: The device to which you want to run a traceroute must belong to the VLAN you specify here.
IPv6	Select this option if you want to trace the route packets taken to a device with an IPv6 address.

Table 325 MAINTENANCE > Diagnostic (continued)

LABEL	DESCRIPTION
IP Address/Host Name	Enter the IP address or host name of a device to which you want to perform a traceroute. Click Trace Route to have the Switch perform the traceroute function. This determines the path a packet takes to the specified device.
TTL	Enter the Time To Live (TTL) value for the ICMP Echo Request packets. This is to set the maximum number of the hops (routers) a packet can travel through. Each router along the path will decrement the TTL value by one and forward the packets. When the TTL value becomes zero and the destination is not found, the router drops the packets and informs the sender.
Wait Time	Specify how many seconds the Switch waits for a response to a probe before running another traceroute.
Queries	Specify how many times the Switch performs the traceroute function.
Ethernet Port Test	
Port	The slot field appears only in Stacking mode. Click the drop-down list to choose the slot number of the Switch in a stack. Enter a port number and click Port Test to perform an internal loopback test.
Cable Diagnostics	
Port	The slot field appears only in Stacking mode. Click the drop-down list to choose the slot number of the Switch in a stack. Enter an Ethernet port number and click Diagnose to perform a physical wire-pair test of the Ethernet connections on the specified ports. The following fields display when you diagnose a port. This field is available only on the Switch that has one or more copper Ethernet ports (except the MGMT port).
Port	Enter an Ethernet port number and click Diagnose to perform a physical wire-pair test of the Ethernet connections on the specified ports. The following fields display when you diagnose a port.
Locator LED	Enter a time interval (in minutes) and click Blink to show the actual location of the Switch between several devices in a rack. The default time interval is 30 minutes. Click Stop to have the Switch terminate the blinking locator LED.

79.15 Firmware Upgrade

You can upgrade the Switch's firmware through Web Configurator or NCC.

Firmware Upgrade Through NCC

In cloud management mode, NCC will first check if the firmware on the Switch needs to be upgraded. If it does, the Switch will upgrade the firmware immediately. If the firmware does not need to be upgraded, but there is newer firmware available for the Switch, then it will be upgraded according to the firmware upgrade schedule for the Switch on the NCC.

On the NCC web portal, go to **Site-wide > Configure > Firmware management** to schedule the firmware upgrade time.

Note: While the Switch is rebooting, do NOT turn off the power.

Firmware Upgrade Through the Web Configurator

Use the following screen to upgrade your Switch to the latest firmware. The Switch supports dual firmware images, **Firmware 1** and **Firmware 2**. Use this screen to specify which image is updated when firmware is uploaded using the Web Configurator and to specify which image is loaded when the Switch starts up.

Note: Make sure you have downloaded (and unzipped) the correct model firmware and version to your computer before uploading to the device.

Click **MAINTENANCE** > **Firmware Upgrade** to view the screen as shown next.

Figure 500 MAINTENANCE > Firmware Upgrade (Standalone Mode)

Firmware Upgrade

Firmware Upgrade

Name	Version	
XGS2220-54FP	Running	V4.80(ACCE.0)b6 04/11/2022
	Firmware 1	V4.80(ACCE.0)b6 04/11/2022
	Firmware 2	

Boot Image

Current Boot Image Firmware 1

Config Boot Image Firmware 1 ▼

Apply
Cancel

To upgrade the switch firmware, browse the location of the binary (.BIN) file and click Upgrade button.

Firmware 1 ▼

File Path Choose File No file chosen

Upgrade

Figure 501 MAINTENANCE > Firmware Upgrade (Stacking Mode)

Firmware Upgrade

Firmware Upgrade

Slot	Name	Status	Running	Version
1	XGS2220-54HP	active	Running	V4.80(ABXQ.2)b6 05/18/2023
			Firmware 1	V4.80(ABXQ.2)b6 05/18/2023
			Firmware 2	V4.80(ABXQ.2)b6 05/18/2023
2		inactive	Running	
			Firmware 1	
			Firmware 2	
3		inactive	Running	
			Firmware 1	
			Firmware 2	
4		inactive	Running	
			Firmware 1	
			Firmware 2	

Boot Image

Current Boot Image Firmware 1

Config Boot Image Firmware 1

To upgrade the switch firmware, browse the location of the binary (.BIN) file and click Upgrade button.

Firmware All / 1

File Path No file chosen

The top of the screen shows which firmware version is currently **Running** on the Switch. Click **Choose File** or **Browse** to locate the firmware file you wish to upload to the Switch in the **File Path** field. Click **Upgrade** to load the new firmware. The Switch does not apply the uploaded firmware immediately. Firmware upgrades are only applied after you reboot the Switch using the uploaded firmware.

Click the **Config Boot Image** drop-down list box to select the boot image (**Firmware1** or **Firmware2**) you want the Switch to use when rebooting, click **Apply**. Restart the Switch (manually or using the **MAINTENANCE > Reboot System** screen) to apply the firmware image you selected.

After the process is complete, see the **DASHBOARD** screen to verify your current firmware version number.

Table 326 MAINTENANCE > Firmware Upgrade

LABEL	DESCRIPTION
Slot	This field appears only in Stacking mode. This is the slot index number.
Name	This is the name of the Switch that you are configuring.

Table 326 MAINTENANCE > Firmware Upgrade (continued)

LABEL	DESCRIPTION
Status	<p>This field displays whether the stacked Switch is active or inactive in a stack system.</p> <p>Init means the master Switch is initializing the slot ID.</p> <p>active* means the Switch is in the stack, but some items fail to initialize. See the system logs for details.</p> <ul style="list-style-type: none"> • If the Switch is not the master, disconnect and reconnect the stacking port and wait. Restart the Switch if it still displays active*. • If the Switch is a master, restart the Switch or select another master.
Version	<p>The Switch has 2 firmware sets, Firmware 1 and Firmware 2, residing in flash.</p> <ul style="list-style-type: none"> • Running shows the version number (and model code) and MM/DD/YYYY creation date of the firmware currently in use on the Switch (Firmware 1 or Firmware 2). The firmware information is also displayed at System Information in Basic Setting. • Firmware 1 shows its version number (and model code) and MM/DD/YYYY creation date. • Firmware 2 shows its version number (and model code) and MM/DD/YYYY creation date.
Boot Image	
Current Boot Image	This displays which firmware is currently in use on the Switch (Firmware 1 or Firmware 2).
Config Boot Image	Select which firmware (Firmware 1 or Firmware 2) should load, click Apply and reboot the Switch to see changes, you will also see changes in the Current Boot Image field above as well.
Apply	Click Apply to save your changes to the Switch's run-time memory. The Switch loses these changes if it is turned off or loses power, so use the Save link on the top navigation panel to save your changes to the non-volatile memory when you are done configuring.
Cancel	Click Cancel to begin configuring this screen afresh.
Firmware	<p>Choose to upload the new firmware to (Firmware) 1 or (Firmware) 2.</p> <p>In Stacking mode, the first field is the slot number. Click the drop-down list to choose the slot number of the Switch in a stack to upgrade the firmware on this slot. Or select All to upgrade the firmware for all slots.</p>
File Path	Click Choose File or Browse to locate the firmware file you wish to upload to the Switch.
Upgrade	Click Upgrade to load the new firmware. Firmwares are only applied after a reboot. To reboot, go to MAINTENANCE > Reboot System and click Config 1 , Config 2 or Factory Default (Config 1 , Config 2 , Factory Default , and Custom Default are the configuration files you want the Switch to use when it restarts). In Stacking mode, you can also choose Stacking Default to reboot.

79.16 Reboot System

Reboot System allows you to restart the Switch without physically turning the power off. It also allows you to load configuration one (**Config 1**), configuration two (**Config 2**), a **Custom Default** or the **Factory Default** configuration when you reboot. Follow the steps below to reboot the Switch.

Click **MAINTENANCE > Reboot System** to view the screen as shown next.

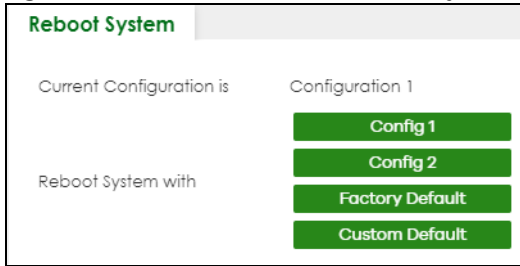
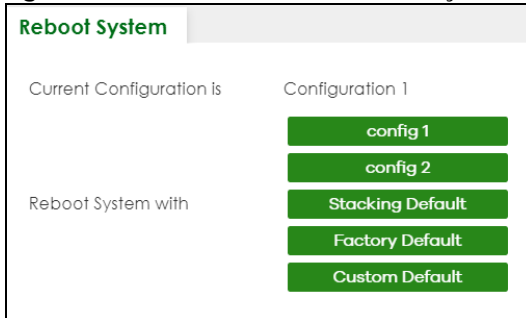
Figure 502 MAINTENANCE > Reboot System (Standalone Mode)**Figure 503** MAINTENANCE > Reboot System (Stacking Mode)

- 1 Click the **Config 1**, **Config 2**, **Factory Default**, or **Custom Default** (or **Stacking Default** in Stacking mode) button to reboot and load that configuration file. The confirmation screen displays.

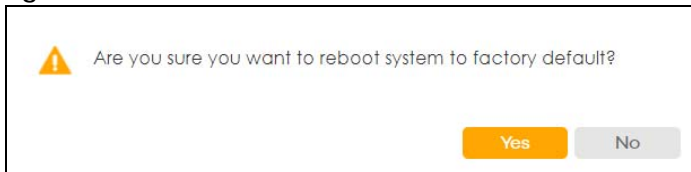
Figure 504 Reboot Confirmation

- 2 Click **YES** and then wait for the Switch to restart. This takes up to 2 minutes.

Click **Config 1** and follow steps 1 to 2 to reboot and load configuration one on the Switch.

Click **Config 2** and follow steps 1 to 2 to reboot and load configuration two on the Switch.

Click **Stacking Default** and follow steps 1 to 2 to reboot and load stacking default configuration settings on the Switch. The master Switch login information will not be reset.

Click **Factory Default** and follow steps 1 to 2 to reboot and load Zyxel factory default configuration settings on the Switch.

Click **Custom Default** and follow steps 1 to 2 to reboot and load a customized default file on the Switch. This will save the custom default configuration settings to both **Configuration 1** and **Configuration 2**.

Note: If a customized default file was not saved, clicking **Custom Default** loads the factory default configuration on the Switch.

Note: Service Register only appears in standalone mode.

79.17 Tech-Support

The Tech-Support feature is a log enhancement tool that logs useful information such as CPU utilization history, memory and Mbuf (Memory Buffer) log and crash reports for issue analysis by customer support should you have difficulty with your Switch. The Tech Support menu eases your effort in obtaining reports and it is also available in CLI command by entering the “Show tech-support” command.

Click **MAINTENANCE > Tech-Support** to see the following screen.

Figure 505 MAINTENANCE > Tech-Support

You may need WordPad or similar software to see the log report correctly. The table below describes the fields in the above screen.

Table 327 MAINTENANCE > Tech-Support

LABEL	DESCRIPTION
CPU	<p>Type a number ranging from 50 to 100 in the CPU threshold box, and type another number ranging from 5 to 60 in the seconds box then click Apply.</p> <p>For example, 80 for CPU threshold and 5 for seconds means a log will be created when CPU utilization reaches over 80% and lasts for 5 seconds.</p> <p>The log report holds 7 days of CPU log data and is stored in volatile memory (RAM). The data is lost if the Switch is turned off or in event of power outage. After 7 days, the logs wrap around and new ones and replace the earliest ones.</p> <p>The higher the CPU threshold number, the fewer logs will be created, and the less data technical support will have to analyze and vice versa.</p>
Mbuf	<p>Type a number ranging from 50 to 100 in the Mbuf (Memory Buffer) threshold box. The Mbuf log report is stored in flash (permanent) memory.</p> <p>For example, Mbuf 50 means a log will be created when the Mbuf utilization is over 50%.</p> <p>The higher the Mbuf threshold number, the fewer logs will be created, and the less data technical support will have to analyze and vice versa.</p>
Apply	<p>Click Apply to save your changes to the Switch’s run-time memory. The Switch loses these changes if it is turned off or loses power, so use the Save link on the top navigation panel to save your changes to the non-volatile memory when you are done configuring.</p>
Cancel	<p>Click Cancel to begin configuring this screen afresh.</p>

Table 327 MAINTENANCE > Tech-Support (continued)

LABEL	DESCRIPTION
All	Click Download to see all the log report and system status. This log report is stored in flash memory. If the All log report is too large, you can download the log reports separately below.
Crash	Click Download to see the crash log report. The log will include information of the last crash and is stored in flash memory.
CPU	Click Download to see the CPU history log report. The 7-days log is stored in RAM and you will need to save it, otherwise it will be lost when the Switch is shutdown or during power outage.
Memory	Click Download to see the memory section log report. This log report is stored in flash memory.
Mbuf	Click Download to see the Mbuf (Memory Buffer) log report. This log report is stored in flash memory.
ROM	Click Download to see the Read Only Memory (ROM) log report. This report is stored in flash memory.
L3	Click Download to see the layer-3 Switch log report. The log only applies to the layer-3 Switch models. This report is stored in flash memory.

79.17.1 Tech-Support Download

When you click **Download** to save your current Switch configuration to a computer, the following screen appears. When the log report has downloaded successfully, click **Back** to return to the previous screen.

Figure 506 MAINTENANCE > Tech-Support: Download

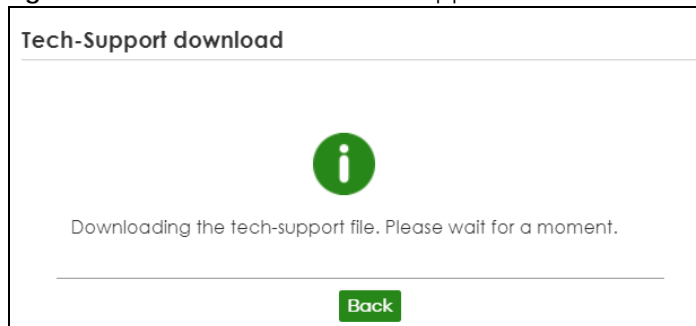

CHAPTER 80

Networked AV Mode

80.1 Overview

Aside from the Web Configurator in Standard mode that has a complete set of configuration for network installation, you can switch to Networked AV mode. Networked AV mode contains just the necessary configurations for setting up and managing audio-video traffic on your network.

AV over IP is the transmission of audio-video data over an IP network.

Use a browser that supports HTML5, such as Microsoft Edge, Mozilla Firefox, or Google Chrome. The recommended minimum screen resolution is 1024 by 768 pixels.

The following sections introduce the configuration and functions of the Web Configurator in Networked AV mode.

Click **Networked AV** at the top left of the Web Configurator to switch between the Web Configurator's **Standard** or **Networked AV** mode.

Figure 507 Web Configurator – Networked AV Mode Switch



80.2 Help

The Web Configurator's online help has descriptions of individual Networked AV mode screens and some supplementary information.

Click the **Help** link from a Web Configurator screen to scan the QR code or click the web link to display the online help.

Figure 508 Open the Online Help

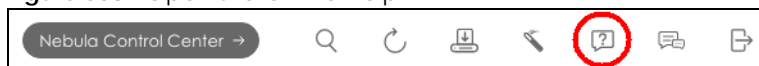

80.3 Summary

Use the **SUMMARY** screen to see the Switch's front panel port status, connected ports information, networked AV information, Nebula Cloud Control status, and a link to go to the **IP Setup** screen ([Section 80.11 on page 637](#)).

The **SUMMARY** screen displays when you log into the Switch in Networked AV mode.

Figure 509 Summary (example PoE model)

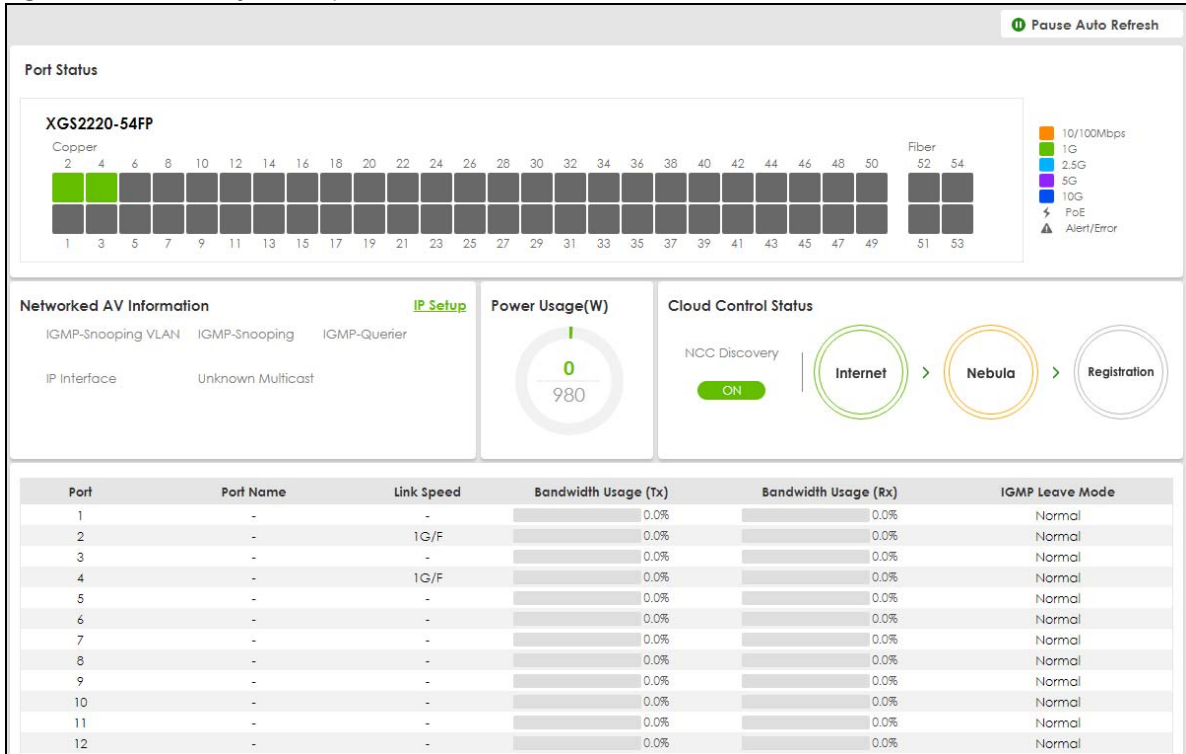

The following table describes the labels in this screen.

Table 328 SUMMARY

LABEL	DESCRIPTION
Auto Refresh	Click the Pause Auto Refresh or Resume Auto Refresh icon to stop or resume the screen update.
Port Status	This chart displays the status of the Switch's front panel ports with connection (LED and Port).
Networked AV Information	
IP Setup	This link takes you to a screen where you can configure the IP address and subnet mask (necessary for Switch management) and set up to 128 IP routing domains.
IGMP-Snooping VLAN	This displays the ID number of the VLAN group upon which the Switch is to perform IGMP snooping.
IGMP-Snooping	This displays Active when IGMP snooping is enabled to forward group multicast traffic only to ports that are members of that group. Otherwise, it is Inactive .
IGMP-Querier	This displays Active when the Switch is allowed to send IGMP General Query messages to the VLANs with the multicast hosts attached. Otherwise, it is Inactive .
IP Interface	This displays the IP address of the Switch for it to be managed over the network.
Unknown Multicast	This displays the action to perform when the Switch receives an unknown multicast frame. It displays Drop when the frames are discarded. It displays Flooding when the frames are sent to all ports. It displays Drop on VLAN when the frames are discarded on the specified VLANs.
Power Usage(W)	For PoE models. This chart displays the used PoE Watts over the total number of Watts provided on this Switch.

Table 328 SUMMARY (continued)

LABEL	DESCRIPTION
Cloud Control Status	This displays the registration and connection status between the Switch and the NCC (Nebula Control Center). Click NCC Discovery or the switch button to go to SYSTEM > Cloud Management screen.
Port	This displays the port of this Switch.
Port Name	This displays the port description of this Switch.
Link Speed	This displays the speed (either 100M for 100 Mbps, 1G for 1 Gbps, 2.5G for 2.5 Gbps, 5G for 5 Gbps, or 10G for 10 Gbps) and the duplex (F for full duplex or H for half). It also shows the cable type (Copper or Fiber) for the combo ports. This field displays Down if the port is not connected to any device.
Bandwidth Usage (Tx) Bandwidth Usage (Rx)	These display the percentage of bandwidth usage on this port as a percentage of the Link Speed .
IGMP Leave Mode	This displays Immediate when the Switch receives IGMP leave packets, the Switch will close the multicast stream immediately without any further action. This displays Fast when the Switch will further generate a group specific query packet to all the receivers. This could prevent the traffic being cut if some receivers still want to receive the multicast stream. This displays Normal when the Switch receives an IGMP leave message from a host on a port, it forwards the message to the multicast router. The multicast router then sends out an IGMP Group-Specific Query (GSQ) message to determine whether other hosts connected to the port should remain in the specific multicast group. The Switch forwards the query message to all hosts connected to the port and waits for IGMP reports from hosts to update the forwarding table for this port.

80.4 MONITOR

The following sections introduce the **MONITOR** screens.

80.5 What You Can Do

- Use the **System Information** screen ([Section 80.6 on page 631](#)) to check the firmware version number and monitor the Switch temperature.

80.6 System Information

In the navigation panel, click **MONITOR > System Information** to display the screen as shown. Use this screen to view general system information. You can check the firmware version number and monitor the Switch temperature.

Figure 510 MONITOR > System Information

System Information					
System Information					
System Name	XGS2220				
Product Model	XGS2220-54FP				
ZyNOS F/W Version	V4.80(ACCE.0)b6 04/11/2022				
Ethernet Address	00:19:cb:00:00:01				
CPU Utilization Current (%)	32.14				
Memory Utilization					
Name	Total (byte)	Used (byte)	Utilization (%)		
common	71230976	9806032	13		
Hardware Monitor					
Temperature Unit: <input checked="" type="radio"/> C <input type="radio"/> F					
Temperature (C)	Status	Current	MAX	MIN	Threshold
MAC	Normal	43.0	43.0	27.0	78.0
BOARD	Normal	47.0	47.0	27.0	110.0
PHY	Normal	45.0	46.0	24.0	88.0
FAN Speed (RPM)	Status	Current	MAX	MIN	Threshold
FAN1	Normal	2622	2638	2553	500
FAN2	Normal	5953	6033	5561	500
FAN3	Normal	6006	6060	5561	500
Voltage (V)	Status	Current	MAX	MIN	Threshold
0.9V	Normal	0.878	0.878	0.878	+6%/-6%
1.1V	Normal	1.072	1.095	1.072	+6%/-6%
3.3V	Normal	3.308	3.308	3.308	+6%/-6%
2.0V	Normal	2.018	2.018	2.018	+6%/-6%
12V	Normal	11.906	11.968	11.906	+10%/-10%

The following table describes the labels in this screen.

Table 329 MONITOR > System Information

LABEL	DESCRIPTION
System Information	
System Name	This field displays the descriptive name of the Switch for identification purposes.
Product Model	This field displays the product model of the Switch. Use this information when searching for firmware upgrade or looking for other support information in the website.
ZyNOS F/W Version	This field displays the version number of the Switch 's current firmware including the creation date.
Ethernet Address	This field refers to the Ethernet MAC (Media Access Control) address of the Switch.
CPU Utilization Current (%)	CPU utilization quantifies how busy the system is. Current (%) displays the current percentage of CPU utilization.
Memory Utilization	
Memory utilization shows how much DRAM memory is available and in use. It also displays the current percentage of memory utilization.	
Name	This field displays the name of memory pool.
Total (byte)	This field displays the total number of bytes in this memory pool.
Used (byte)	This field displays the number of bytes being used in this memory pool.
Utilization (%)	This field displays the percentage (%) of memory being used in this memory pool.
Hardware Monitor	

Table 329 MONITOR > System Information (continued)

LABEL	DESCRIPTION
Temperature (C/F)	BOARD/MAC/PHY refers to the location of the temperature sensor on the Switch printed circuit board.
Status	This field displays Normal for temperatures below the threshold and Error for those above.
Current	This shows the current temperature at this sensor.
MAX	This field displays the maximum temperature measured at this sensor.
MIN	This field displays the minimum temperature measured at this sensor.
Threshold	This field displays the upper temperature limit at this sensor.
Fan Speed (RPM)	A properly functioning fan is an essential component (along with a sufficiently ventilated, cool operating environment) in order for the device to stay within the temperature threshold. Each fan has a sensor that is capable of detecting and reporting if the fan speed falls below the threshold shown.
Status	Normal indicates that this fan is functioning above the minimum speed. Error indicates that this fan is functioning below the minimum speed.
Current	This field displays this fan's current speed in Revolutions Per Minute (RPM).
MAX	This field displays this fan's maximum speed measured in Revolutions Per Minute (RPM).
MIN	This field displays this fan's minimum speed measured in Revolutions Per Minute (RPM). "<41" is displayed for speeds too small to measure (under 2000 RPM).
Threshold	This field displays the minimum speed at which a normal fan should work.
Voltage(V)	The power supply for each voltage has a sensor that is capable of detecting and reporting if the voltage falls out of the tolerance range.
Status	Normal indicates that the voltage is within an acceptable operating range at this point; otherwise Error is displayed.
Current	This is the current voltage reading.
MAX	This field displays the maximum voltage measured at this point.
MIN	This field displays the minimum voltage measured at this point.
Threshold	This field displays the percentage tolerance of the voltage with which the Switch still works.

80.7 SYSTEM

The following sections introduces the **SYSTEM** screens.

80.8 What You Can Do

- Use the **Cloud Management** screen ([Section 80.9 on page 634](#)) to view NCC Connection status and enable/disable NCC Discovery.
- Use the **General Setup** screen ([Section 80.10 on page 635](#)) to configure general settings such as the system name and time.
- Use the **IP Setup** screen ([Section 80.11 on page 637](#)) to configure the default gateway device, the default domain name server and add IP domains.
- Use the **Logins** screen ([Section 80.12 on page 639](#)) to change the system password, configure passwords for up to four users and set their privilege level.

- Use the **SNMP** screen (Section 80.13 on page 641) to configure your SNMP (Simple Network Management Protocol) settings.
- Use the **SNMP User** screen (Section 80.14 on page 643) to create SNMP users for authentication with managers using SNMP v3 and associate them to SNMP groups.
- Use the **SNMP Trap Group** screen (Section 80.15 on page 645) to specify the types of SNMP traps that should be sent to each SNMP manager.
- Use the **SNMP Trap Port** screen (Section 80.16 on page 646) to set whether a trap received on the ports would be sent to the SNMP manager.

80.9 Cloud Management

The Zyxel Nebula Control Center (NCC) is a cloud-based network management system that allows you to remotely manage and monitor Zyxel Nebula APs, Ethernet switches and security gateways.

The Switch is managed and provisioned automatically by the NCC (Nebula Control Center) when:

- It is connected to the Internet.
- The **Nebula Control Center Discovery** feature is enabled.
- It has been registered in the NCC.

Click **SYSTEM > Cloud Management** in the navigation panel to display this screen.

Figure 511 SYSTEM > Cloud Management

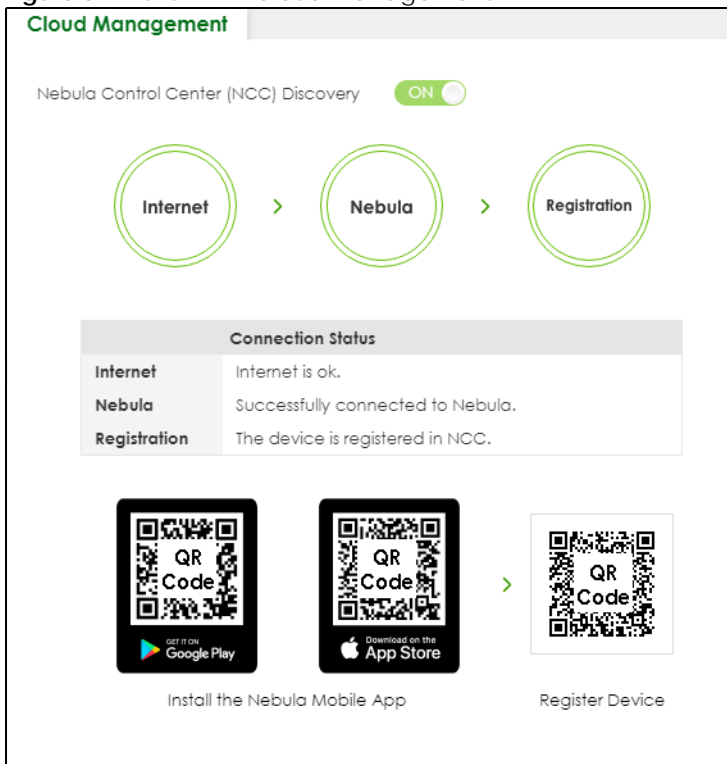

The following table describes the labels in this screen.

Table 330 SYSTEM > Cloud Management

LABEL	DESCRIPTION
Nebula Control Center (NCC) Discovery	<p>Enable the switch button to turn on Nebula Control Center (NCC) discovery on the Switch.</p> <p>This field displays:</p> <ul style="list-style-type: none"> • The Switch Internet connection status. • The connection status between the Switch and NCC. • The Switch registration status on NCC. <p>Mouse over the circles to display detailed information.</p> <p>To pass your Switch management to NCC, first make sure your Switch is connected to the Internet. Then go to NCC and register your Switch.</p> <p>1. Internet</p> <p>Green – The Switch is connected to the Internet.</p> <p>Orange – The Switch is not connected to the Internet.</p> <p>2. Nebula</p> <p>Green – The Switch is connected to NCC.</p> <p>Orange – The Switch is not connected to NCC.</p> <p>3. Registration</p> <p>Green – The Switch is registered on NCC.</p> <p>Gray – The Switch is not registered on NCC.</p> <p>Note: All circles will gray out if you disable Nebula Discovery.</p>
Connection Status	<p>This table displays the NCC connection status information.</p> <p>Use the status logs in the Internet, Nebula, and Registration fields for connection troubleshooting.</p>

Enable **Nebula Control Center (NCC) Discovery** to turn on NCC discovery on the Switch. If the Switch has Internet access and has been registered in the NCC, it will go into cloud management mode.

Disable **Nebula Control Center (NCC) Discovery** to turn off NCC discovery on the Switch. The Switch will NOT discover the NCC and remain in standalone mode.

This screen has a QR code containing the Switch's serial number and Registration MAC address for handy NCC registration of the Switch using the Nebula Mobile app. First, download the app from the Google Play store for Android devices or the App Store for iOS devices and create an organization and site. Open the Nebula Mobile app and follow the wizard to scan the **Register Device** QR code to register the Switch on NCC.

80.10 General Setup

Use this screen to configure general settings such as the system name and time. Click **SYSTEM > General Setup** in the navigation panel to display the screen as shown.

Figure 512 SYSTEM > General Setup

General Setup

System Name: XGS2220

Location:

Contact Person's Name:

Use Time Server when Bootup: NTP(RFC-1305)

Time Server IP Address: 1.pool.ntp.org

Time Server Sync Interval: 1440 minutes

Current Time: 07 : 05 : 08 UTC+00:00

New Time (hh:mm:ss): 07 : 05 : 08

Current Date: 2022 - 05 - 09

New Date (yyyy-mm-dd): 2022 - 05 - 09

Time Zone: UTC

Daylight Saving Time: ON

Start Date: First Sunday of January at 0:00

End Date: First Sunday of January at 0:00

Note: The input string of any field in this screen should not contain [?], [|], ['], ["], or [,].

The following table describes the labels in this screen.

Table 331 SYSTEM > General Setup

LABEL	DESCRIPTION
System Name	Choose a descriptive name for identification purposes. This name consists of up to 64 printable ASCII characters; spaces are allowed.
Location	Enter the geographic location of your Switch. You can use up to 128 printable ASCII characters; spaces are allowed.
Contact Person's Name	Enter the name of the person in charge of this Switch. You can use up to 32 printable ASCII characters; spaces are allowed.
Use Time Server when Bootup	<p>Enter the time service protocol that your time server uses. Not all time servers support all protocols, so you may have to use trial and error to find a protocol that works. The main differences between them are the time format.</p> <p>When you select the Daytime (RFC-867) format, the Switch displays the day, month, year and time with no time zone adjustment. When you use this format it is recommended that you use a Daytime timeserver within your geographical time zone.</p> <p>Time (RFC-868) format displays a 4-byte integer giving the total number of seconds since 1970/1/1 at 00:00:00.</p> <p>NTP (RFC-1305) is similar to Time (RFC-868).</p> <p>None is the default value. Enter the time manually. Each time you turn on the Switch, the time and date will be reset to 2022-01-01 00:00:00.</p>
Time Server IP Address	Enter the IP address or domain name of your timeserver. The Switch searches for the timeserver for up to 60 seconds.
Time Server Sync Interval	Enter the period in minutes between each time server synchronization. The Switch checks the time server after every synchronization interval.
Current Time	This field displays the time you open this menu (or refresh the menu).

Table 331 SYSTEM > General Setup (continued)

LABEL	DESCRIPTION
New Time (hh:mm:ss)	Enter the new time in hour, minute and second format. The new time then appears in the Current Time field after you click Apply .
Current Date	This field displays the date you open this menu.
New Date (yyyy-mm-dd)	Enter the new date in year, month and day format. The new date then appears in the Current Date field after you click Apply .
Time Zone	Select the time difference between UTC (Universal Time Coordinated, formerly known as GMT, Greenwich Mean Time) and your time zone from the drop-down list box.
Daylight Saving Time	<p>Daylight saving is a period from late spring to early fall when many countries set their clocks ahead of normal local time by one hour to give more daytime light in the evening.</p> <p>Enable the switch button if you use Daylight Saving Time.</p>
Start Date	<p>Configure the day and time when Daylight Saving Time starts if you selected Daylight Saving Time. The time is displayed in the 24 hour format. Here are a couple of examples:</p> <p>Daylight Saving Time starts in most parts of the United States on the second Sunday of March. Each time zone in the United States starts using Daylight Saving Time at 2 A.M. local time. So in the United States you would select Second, Sunday, March and 2:00.</p> <p>Daylight Saving Time starts in the European Union on the last Sunday of March. All of the time zones in the European Union start using Daylight Saving Time at the same moment (1 A.M. GMT or UTC). So in the European Union you would select Last, Sunday, March and the last field depends on your time zone. In Germany for instance, you would select 2:00 because Germany's time zone is one hour ahead of GMT or UTC (GMT+1).</p>
End Date	<p>Configure the day and time when Daylight Saving Time ends if you selected Daylight Saving Time. The time field uses the 24 hour format. Here are a couple of examples:</p> <p>Daylight Saving Time ends in the United States on the first Sunday of November. Each time zone in the United States stops using Daylight Saving Time at 2 A.M. local time. So in the United States you would select First, Sunday, November and 2:00.</p> <p>Daylight Saving Time ends in the European Union on the last Sunday of October. All of the time zones in the European Union stop using Daylight Saving Time at the same moment (1 A.M. GMT or UTC). So in the European Union you would select Last, Sunday, October and the last field depends on your time zone. In Germany for instance, you would select 2:00 because Germany's time zone is one hour ahead of GMT or UTC (GMT+1).</p>
Apply	Click Apply to save your changes to the Switch's run-time memory. The Switch loses these changes if it is turned off or loses power, so use the Save link on the top navigation panel to save your changes to the non-volatile memory when you are done configuring.
Cancel	Click Cancel to begin configuring this screen afresh.

80.11 IP Setup

Use the IP Setup screen to configure the default gateway device, the default domain name server and add IP domains.

Note: The Switch allows you to set a static IP interface in the same subnet that already has a DHCP-assigned IP interface on the Switch. The Switch will use the static IP you set and the DHCP-assigned IP will be set to 0.0.0.0.

Figure 513 SYSTEM > IP Setup

IP Setup

Default Gateway

Domain Name Server 1

Domain Name Server 2

Apply **Cancel**

IP Interface

<input type="checkbox"/>	Index	IP Address	IP Subnet Mask	VID	Type
<input type="checkbox"/>	1	10.214.35.43	255.255.255.0	1	DHCP

+ Add/Edit **- Delete**

The following table describes the labels in this screen.

Table 332 SYSTEM > IP Setup

LABEL	DESCRIPTION
IP Setup	
Default Gateway	Type the IP address of the default outgoing gateway in dotted decimal notation, for example 192.168.1.254.
Domain Name Server 1/2	Enter a domain name server IPv4 address in order to be able to use a domain name instead of an IP address.
Apply	Click Apply to save your changes to the Switch's run-time memory. The Switch loses these changes if it is turned off or loses power, so use the Save link on the top navigation panel to save your changes to the non-volatile memory when you are done configuring.
Cancel	Click Cancel to reset the fields to your previous configuration.
IP Interface	
Use this section to view and configure IP routing domains on the Switch.	
Index	This field displays the index number of an entry.
IP Address	This field displays the IP address of the Switch in the IP domain.
IP Subnet Mask	This field displays the subnet mask of the Switch in the IP domain.
VID	This field displays the VLAN identification number of the IP domain on the Switch.
Type	This field displays the type of IP address status. Static or DHCP .
	Select an entry's check box to select a specific entry. Otherwise, select the check box in the table heading row to select all entries.
Add/Edit	Click Add/Edit to add a new IP interface or edit a selected one.
Delete	Click Delete to remove the selected IP interfaces.

80.11.1 Add/Edit IP Interfaces

Use this screen to add or edit IP interfaces. Click **Add/Edit**, or select an entry and click **Add/Edit** in the **SYSTEM > IP Setup** screen to display this screen.

Figure 514 SYSTEM > IP Setup > Add/Edit

The following table describes the labels in this screen.

Table 333 SYSTEM > IP Setup > Add/Edit

LABEL	DESCRIPTION
DHCP Client	Select this option if you have a DHCP server that can assign the Switch an IP address, subnet mask, a default gateway IP address and a domain name server IP address automatically.
Static IP Address	Select this option if you do not have a DHCP server or if you wish to assign static IP address information to the Switch. You need to fill in the following fields when you select this option.
IP Address	Enter the IP address of your Switch in dotted decimal notation, for example, 192.168.1.1. This is the IP address of the Switch in an IP routing domain.
IP Subnet Mask	Enter the IP subnet mask of an IP routing domain in dotted decimal notation, for example, 255.255.255.0.
VID	Enter the VLAN identification number to which an IP routing domain belongs.
Apply	Click Apply to save your changes to the Switch's run-time memory. The Switch loses these changes if it is turned off or loses power, so use the Save link on the top navigation panel to save your changes to the non-volatile memory when you are done configuring.
Clear	Click Clear to clear the fields to the factory defaults.
Cancel	Click Cancel to not save the configuration you make and return to the last screen.

80.12 Logins

Up to five people (one administrator and four non-administrators) may access the Switch through Web Configurator at any one time.

- An administrator is someone who can both view and configure Switch changes. The user name for the Administrator is always **admin**. The default administrator password is **1234**.

Note: It is highly recommended that you change the default administrator password (**1234**).

- A non-administrator (user name is something other than **admin**) is someone who can view and/or configure Switch settings. The configuration right varies depending on the user's privilege level.

Click **SYSTEM > Logins** to view the screen as shown.

Figure 515 SYSTEM > Logins

Logins

Administrator

Old Password

New Password

Retype to confirm

⚠ Please record your new password whenever you change it. The system will lock you out if you have forgotten your password.

Edit Logins

Login	User Name	Password	Retype to confirm	Privilege
1	<input type="text"/>	<input type="text"/>	<input type="text"/>	<input type="text"/>
2	<input type="text"/>	<input type="text"/>	<input type="text"/>	<input type="text"/>
3	<input type="text"/>	<input type="text"/>	<input type="text"/>	<input type="text"/>
4	<input type="text"/>	<input type="text"/>	<input type="text"/>	<input type="text"/>

Note: The input string in any field of this screen should not contain [?], [|], ['], ["] or [,]. In the **Password** fields, [space] is also not allowed.

The following table describes the labels in this screen.

Table 334 SYSTEM > Logins

LABEL	DESCRIPTION
Administrator	
This is the default administrator account with the "admin" user name. You cannot change the default administrator user name.	
Old Password	Enter the existing system password (1234 is the default password when shipped).
New Password	Enter your new system password.
Retype to confirm	Re-enter your new system password for confirmation.
Edit Logins	
You may configure passwords for up to four users. These users can have read-only or read/write access. You can give users higher privileges through the Web Configurator or the CLI. For more information on assigning privileges through the CLI see the Ethernet Switch CLI Reference Guide.	
Login	This is the index of an user account.
User Name	Set a user name (up to 32 printable ASCII characters except [?], [], ['], ["], or [,]).
Password	Enter your new system password.
Retype to confirm	Retype your new system password for confirmation.

Table 334 SYSTEM > Logins (continued)

LABEL	DESCRIPTION
Privilege	<p>Enter the privilege level for this user. At the time of writing, users may have a privilege level of 0, 3, 13, or 14 representing different configuration rights as shown below.</p> <ul style="list-style-type: none"> 0 – Display basic system information. 3 – Display configuration or status. 13 – Configure features except for login accounts, SNMP user accounts, the authentication method sequence and authorization settings, multiple logins, administrator and enable passwords, and configuration information display. 14 – Configure login accounts, SNMP user accounts, the authentication method sequence and authorization settings, multiple logins, and administrator and enable passwords, and display configuration information. <p>Users can run command lines if the session's privilege level is greater than or equal to the command's privilege level. The session privilege initially comes from the privilege of the login account. For example, if the user has a privilege of 5, he or she can run commands that requires privilege level of 5 or less but not more.</p>
Apply	Click Apply to save your changes to the Switch's run-time memory. The Switch loses these changes if it is turned off or loses power, so use the Save link on the top navigation panel to save your changes to the non-volatile memory when you are done configuring.
Cancel	Click Cancel to begin configuring this screen afresh.

80.13 Configure SNMP

Use this screen to configure your SNMP settings. Simple Network Management Protocol (SNMP) is an application layer protocol used to manage and monitor TCP/IP-based devices. SNMP is used to exchange management information between the network management system (NMS) and a network element (NE). A manager station can manage and monitor the Switch through the network through SNMP version 1 (SNMPv1), SNMP version 2c or SNMP version 3. The next figure illustrates an SNMP management operation. SNMP is only available if TCP/IP is configured.

Figure 516 SNMP Management Model

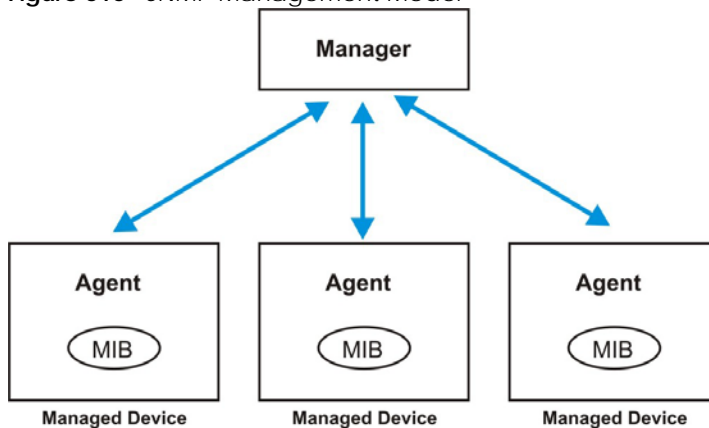

An SNMP managed network consists of two main components: agents and a manager.

An agent is a management software module that resides in a managed Switch (the Switch). An agent translates the local management information from the managed Switch into a form compatible with SNMP. The manager is the console through which network administrators perform network management functions. It executes applications that control and monitor managed devices.

The managed devices contain object variables or managed objects that define each piece of information to be collected about a Switch. Examples of variables include number of packets received, node port status and so on. A Management Information Base (MIB) is a collection of managed objects. SNMP allows a manager and agents to communicate for the purpose of accessing these objects.

SNMP itself is a simple request or response protocol based on the manager or agent model. The manager issues a request and the agent returns responses using the following protocol operations:

Table 335 SNMP Commands

LABEL	DESCRIPTION
Get	Allows the manager to retrieve an object variable from the agent.
GetNext	Allows the manager to retrieve the next object variable from a table or list within an agent. In SNMPv1, when a manager wants to retrieve all elements of a table from an agent, it initiates a Get operation, followed by a series of GetNext operations.
Set	Allows the manager to set values for object variables within an agent.
Trap	Used by the agent to inform the manager of some events.

SNMP v3 and Security

SNMP v3 enhances security for SNMP management. SNMP managers can be required to authenticate with agents before conducting SNMP management sessions.

Security can be further enhanced by encrypting the SNMP messages sent from the managers. Encryption protects the contents of the SNMP messages. When the contents of the SNMP messages are encrypted, only the intended recipients can read them.

Click **SYSTEM > SNMP > SNMP** to view the screen as shown.

Figure 517 SYSTEM > SNMP

The screenshot displays the SNMP configuration page with the following sections:

- General Setting**
 - Version: v2c (dropdown)
 - Get Community: public (text input)
 - Set Community: public (text input)
 - Trap Community: public (text input)
- Trap Destination**

Index	Version	IP	Port	Username
1	v2c	0.0.0.0	162	
2	v2c	0.0.0.0	162	
3	v2c	0.0.0.0	162	
4	v2c	0.0.0.0	162	

At the bottom of the page, there are **Apply** and **Cancel** buttons.

Note: The string of any field in this screen should not contain [?], [|], ['], ["] or [,].

The following table describes the labels in this screen.

Table 336 SYSTEM > SNMP

LABEL	DESCRIPTION
General Setting	
Use this section to specify the SNMP version and community (password) values.	
Version	Select the SNMP version for the Switch. The SNMP version on the Switch must match the version on the SNMP manager. Choose SNMP version 2c (v2c), SNMP version 3 (v3) or both (v3v2c). SNMP version 2c is backwards compatible with SNMP version 1.
Get Community	Enter the Get Community string, which is the password for the incoming Get- and GetNext-requests from the management station. The Get Community string is only used by SNMP managers using SNMP version 2c or lower.
Set Community	Enter the Set Community string, which is the password for incoming Set- requests from the management station. The Set Community string is only used by SNMP managers using SNMP version 2c or lower.
Trap Community	Enter the Trap Community string, which is the password sent with each trap to the SNMP manager. The Trap Community string is only used by SNMP managers using SNMP version 2c or lower.
Trap Destination	
Use this section to configure where to send SNMP traps from the Switch.	
Index	This is the index of a trap destination.
Version	Specify the version of the SNMP trap messages.
IP	Enter the IP addresses of up to four managers to send your SNMP traps to.
Port	Enter the port number upon which the manager listens for SNMP traps.
Username	Enter the user name to be sent to the SNMP manager along with the SNMP v3 trap. This user name must match an existing account on the Switch (configured in the SYSTEM > SNMP > SNMP User screen).
Apply	Click Apply to save your changes to the Switch's run-time memory. The Switch loses these changes if it is turned off or loses power, so use the Save link on the top navigation panel to save your changes to the non-volatile memory when you are done configuring.
Cancel	Click Cancel to begin configuring this screen afresh.

80.14 Configure SNMP User

Use this screen to create SNMP users for authentication with managers using SNMP v3 and associate them to SNMP groups. An SNMP user is an SNMP manager. Click **SYSTEM > SNMP > SNMP User** to view the screen as shown.

Figure 518 SYSTEM > SNMP > SNMP User

The following table describes the labels in this screen.

Table 337 SYSTEM > SNMP > SNMP User

LABEL	DESCRIPTION
Index	This is a read-only number identifying a login account on the Switch.
Username	This field displays the user name of a login account on the Switch.
Security Level	This field displays whether you want to implement authentication and/or encryption for SNMP communication with this user.
Authentication	This field displays the authentication algorithm used for SNMP communication with this user.
Privacy	This field displays the encryption method used for SNMP communication with this user.
Group	This field displays the SNMP group to which this user belongs.
	Select an entry's check box to select a specific entry. Otherwise, select the check box in the table heading row to select all entries.
Add/Edit	Click Add/Edit to add a new entry or edit a selected one.
Delete	Click Delete to remove the selected entries.

80.14.1 Add/Edit SNMP User

Use this screen to create SNMP users for authentication with managers using SNMP v3 and associate them to SNMP groups. An SNMP user is an SNMP manager. Click **Add/Edit**, or select an entry and click **Add/Edit** in the **SYSTEM > SNMP > SNMP User** screen to view this screen.

Note: Use the user name and password of the login accounts you specify in this screen to create accounts on the SNMP v3 manager.

Figure 519 SYSTEM > SNMP > SNMP User > Add/Edit

Note: The input string of any field in this screen should not contain [?], [|], ['], ["], or [,].

The following table describes the labels in this screen.

Table 338 SYSTEM > SNMP > SNMP User > Add/Edit

LABEL	DESCRIPTION
Username	Specify the user name of a login account on the Switch. You can enter up to 32 printable ASCII characters.
Security Level	Select whether you want to implement authentication and/or encryption for SNMP communication from this user. Choose: <ul style="list-style-type: none"> no auth – to use the user name as the password string to send to the SNMP manager. This is equivalent to the Get, Set and Trap Community in SNMP v2c. This is the lowest security level. auth – to implement an authentication algorithm for SNMP messages sent by this user. priv – to implement authentication and encryption for SNMP messages sent by this user. This is the highest security level. <p>Note: The settings on the SNMP manager must be set at the same security level or higher than the security level settings on the Switch.</p>
Authentication	Select an authentication algorithm. MD5 (Message Digest 5) and SHA (Secure Hash Algorithm) are hash algorithms used to authenticate SNMP data. SHA authentication is generally considered stronger than MD5, but is slower.
Password	Enter the password of up to 32 printable ASCII characters (except [?], [], ['], ["], [space], or [,]) for SNMP user authentication.
Privacy	Specify the encryption method for SNMP communication from this user. You can choose one of the following: <ul style="list-style-type: none"> DES – Data Encryption Standard is a widely used (but breakable) method of data encryption. It applies a 56-bit key to each 64-bit block of data. AES – Advanced Encryption Standard is another method for data encryption that also uses a secret key. AES applies a 128-bit key to 128-bit blocks of data.
Password	Enter the password of up to 32 printable ASCII characters (except [?], [], ['], ["], [space], or [,]) for encrypting SNMP packets.
Group	SNMP v3 adopts the concept of View-based Access Control Model (VACM) group. SNMP managers in one group are assigned common access rights to MIBs. Specify in which SNMP group this user is. <p>admin – Members of this group can perform all types of system configuration, including the management of administrator accounts.</p> <p>read-write – Members of this group have read and write rights, meaning that the user can create and edit the MIBs on the Switch, except the user account and AAA configuration.</p> <p>read-only – Members of this group have read rights only, meaning the user can collect information from the Switch.</p>
Apply	Click Apply to save your changes to the Switch's run-time memory. The Switch loses these changes if it is turned off or loses power, so use the Save link on the top navigation panel to save your changes to the non-volatile memory when you are done configuring.
Clear	Click Clear to clear the fields to the factory defaults.
Cancel	Click Cancel to not save the configuration you make and return to the last screen.

80.15 Configure SNMP Trap Group

Use this screen to specify the types of SNMP traps that should be sent to each SNMP manager. Click **SYSTEM > SNMP > SNMP Trap Group** to view the screen as shown.

Figure 520 SYSTEM > SNMP > SNMP Trap Group

The following table describes the labels in this screen.

Table 339 SYSTEM > SNMP > SNMP Trap Group

LABEL	DESCRIPTION
Trap Destination IP	Select one of your configured trap destination IP addresses. These are the IP addresses of the SNMP managers. You must first configure a trap destination IP address in the SYSTEM > SNMP > SNMP screen. Use the rest of the screen to select which traps the Switch sends to that SNMP manager.
	Select the individual SNMP traps that the Switch is to send to the SNMP station. The traps are grouped by category. Selecting a category in the heading row automatically selects all of the SNMP traps under that category. Clear the check boxes for individual traps that you do not want the Switch to send to the SNMP station. Clearing a category's check box automatically clears all of the category's trap check boxes (the Switch only sends traps from selected categories).
Apply	Click Apply to save your changes to the Switch's run-time memory. The Switch loses these changes if it is turned off or loses power, so use the Save link on the top navigation panel to save your changes to the non-volatile memory when you are done configuring.
Cancel	Click Cancel to begin configuring this screen afresh.

80.16 Enable or Disable Sending of SNMP Traps on a Port

Click **SYSTEM > SNMP > SNMP Trap Port** to view the screen as shown. Use this screen to set whether a trap received on the ports would be sent to the SNMP manager.

Figure 521 SYSTEM > SNMP > SNMP Trap Port

Port	Active
*	<input type="checkbox"/>
1	<input checked="" type="checkbox"/>
2	<input checked="" type="checkbox"/>
3	<input checked="" type="checkbox"/>
4	<input checked="" type="checkbox"/>
5	<input checked="" type="checkbox"/>
6	<input checked="" type="checkbox"/>
7	<input checked="" type="checkbox"/>

The following table describes the labels in this screen.

Table 340 SYSTEM > SNMP > SNMP Trap Port

LABEL	DESCRIPTION
Options	Select the trap type you want to configure here.
Port	This field displays a port number.
*	Settings in this row apply to all ports. Use this row only if you want to make some of the settings the same for all ports. Use this row first to set the common settings and then make adjustments on a port-by-port basis. Changes in this row are copied to all the ports as soon as you make them.
Active	Select this check box to enable the trap type of SNMP traps on this port. The Switch sends the related traps received on this port to the SNMP manager. Clear this check box to disable the sending of SNMP traps on this port.
Apply	Click Apply to save your changes to the Switch's run-time memory. The Switch loses these changes if it is turned off or loses power, so use the Save link on the top navigation panel to save your changes to the non-volatile memory when you are done configuring.
Cancel	Click Cancel to begin configuring this screen afresh.

80.17 PORT

The following sections introduce the **PORT** screens.

80.18 Link Aggregation

This section shows you how to logically aggregate physical links to form one logical, higher-bandwidth link.

Link aggregation (trunking) is the grouping of physical ports into one logical higher-capacity link. You may want to trunk ports if for example, it is cheaper to use multiple lower-speed links than to under-utilize a high-speed, but more costly, single-port link. However, the more ports you aggregate then the fewer available ports you have. A trunk group is one logical link containing multiple ports.

The beginning port of each trunk group must be physically connected to form a trunk group.

Figure 522 Link Aggregation

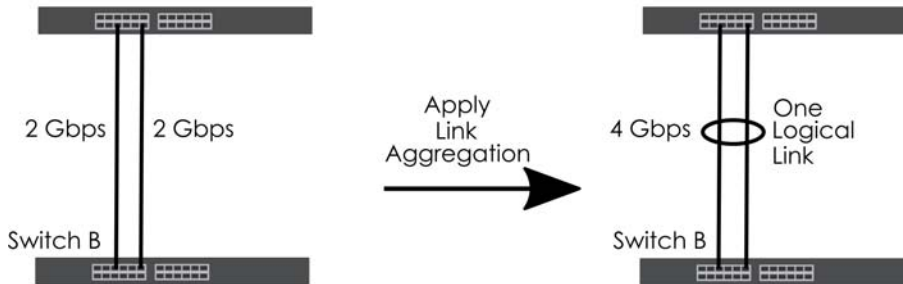

80.18.1 What You Can Do

- Use the **Link Aggregation Status** screen ([Section 80.19 on page 648](#)) to view ports you have configured to be in the trunk group, ports that are currently transmitting data as one logical link in the trunk group and so on.
- Use the **Link Aggregation Setting** screen ([Section 80.20 on page 650](#)) to configure to enable static link aggregation.
- Use the **Link Aggregation Control Protocol** screen ([Section 80.21 on page 651](#)) to enable Link Aggregation Control Protocol (LACP).

80.19 Link Aggregation Status

Use the **Link Aggregation Status** screen to view ports you have configured to be in the trunk group, ports that are currently transmitting data as one logical link in the trunk group and so on.

Click **PORT > Link Aggregation > Link Aggregation Status** in the navigation panel to display the screen as shown.

Figure 523 PORT > Link Aggregation > Link Aggregation Status

Link Aggregation Status					
Link Aggregation Setting			Link Aggregation Control Protocol		
Group ID	Enabled Ports	Synchronized Ports	Aggregator ID	Criteria	Status
T1	-	-	-	src-dst-mac	-
T2	-	-	-	src-dst-mac	-
T3	-	-	-	src-dst-mac	-
T4	-	-	-	src-dst-mac	-
T5	-	-	-	src-dst-mac	-
T6	-	-	-	src-dst-mac	-
T7	-	-	-	src-dst-mac	-

The following table describes the labels in this screen.

Table 341 PORT > Link Aggregation > Link Aggregation Status

LABEL	DESCRIPTION
Group ID	This field displays the group ID to identify a trunk group, that is, one logical link containing multiple ports.
Enabled Ports	These are the ports you have configured in the Link Aggregation Setting screen to be in the trunk group. The port numbers displays only when this trunk group is activated and there is a port belonging to this group.
Synchronized Ports	These are the ports that are currently transmitting data as one logical link in this trunk group.
Aggregator ID	Link Aggregator ID consists of the following: system priority, MAC address, key, port priority and port number. The ID displays only when there is a port belonging to this trunk group and LACP is also enabled for this group.
Criteria	This shows the outgoing traffic distribution algorithm used in this trunk group. Packets from the same source and/or to the same destination are sent over the same link within the trunk. src-mac means the Switch distributes traffic based on the packet's source MAC address. dst-mac means the Switch distributes traffic based on the packet's destination MAC address. src-dst-mac means the Switch distributes traffic based on a combination of the packet's source and destination MAC addresses. src-ip means the Switch distributes traffic based on the packet's source IP address. dst-ip means the Switch distributes traffic based on the packet's destination IP address. src-dst-ip means the Switch distributes traffic based on a combination of the packet's source and destination IP addresses.
Status	This field displays how these ports were added to the trunk group. It displays: <ul style="list-style-type: none"> • Static – if the ports are configured as static members of a trunk group. • LACP – if the ports are configured to join a trunk group through LACP.

80.20 Link Aggregation Setting

Use the **Link Aggregation Setting** screen to enable static link. Link aggregation (trunking) is the grouping of physical ports into one logical higher-capacity link. You may want to trunk ports if for example, it is cheaper to use multiple lower-speed links than to under-utilize a high-speed, but more costly, single-port link. However, the more ports you aggregate then the fewer available ports you have. A trunk group is one logical link containing multiple ports.

Click **PORT > Link Aggregation > Link Aggregation Setting** to display the screen shown next.

Figure 524 PORT > Link Aggregation > Link Aggregation Setting

Group ID	Active	Criteria
T1	<input checked="" type="checkbox"/>	src-dst-mac ▼
T2	<input type="checkbox"/>	src-dst-mac ▼
T3	<input type="checkbox"/>	src-dst-mac ▼
T4	<input type="checkbox"/>	src-dst-mac ▼
T5	<input type="checkbox"/>	src-dst-mac ▼
T6	<input type="checkbox"/>	src-dst-mac ▼
T7	<input type="checkbox"/>	src-dst-mac ▼

Port	Group
1	T1 ▼
2	None ▼
3	None ▼
4	None ▼
5	None ▼
6	None ▼
7	None ▼

The following table describes the labels in this screen.

Table 342 PORT > Link Aggregation > Link Aggregation Setting

LABEL	DESCRIPTION
	This is the only screen you need to configure to enable static link aggregation.
Group ID	The field identifies the link aggregation group, that is, one logical link containing multiple ports.
Active	Select this to activate a trunk group.

Table 342 PORT > Link Aggregation > Link Aggregation Setting (continued)

LABEL	DESCRIPTION
Criteria	<p>Select the outgoing traffic distribution type. Packets from the same source and/or to the same destination are sent over the same link within the trunk. By default, the Switch uses the src-dst-mac distribution type. If the Switch is behind a router, the packet's destination or source MAC address will be changed. In this case, set the Switch to distribute traffic based on its IP address to make sure port trunking can work properly.</p> <p>Select src-mac to distribute traffic based on the packet's source MAC address.</p> <p>Select dst-mac to distribute traffic based on the packet's destination MAC address.</p> <p>Select src-dst-mac to distribute traffic based on a combination of the packet's source and destination MAC addresses.</p> <p>Select src-ip to distribute traffic based on the packet's source IP address.</p> <p>Select dst-ip to distribute traffic based on the packet's destination IP address.</p> <p>Select src-dst-ip to distribute traffic based on a combination of the packet's source and destination IP addresses.</p>
Port	This field displays the port number.
Group	<p>Select the trunk group to which a port belongs.</p> <p>Note: When you enable the port security feature on the Switch and configure port security settings for a port, you cannot include the port in an active trunk group.</p>
Apply	Click Apply to save your changes to the Switch's run-time memory. The Switch loses these changes if it is turned off or loses power, so use the Save link on the top navigation panel to save your changes to the non-volatile memory when you are done configuring.
Cancel	Click Cancel to begin configuring this screen afresh.

80.21 Link Aggregation Control Protocol

When you enable LACP link aggregation on a port, the port can automatically negotiate with the ports at the remote end of a link to establish trunk groups. LACP also allows port redundancy, that is, if an operational port fails, then one of the "standby" ports become operational without user intervention.

Click **PORT > Link Aggregation > Link Aggregation Control Protocol** to display the screen shown next.

Note: Do NOT configure this screen unless you want to enable dynamic link aggregation.

Figure 525 PORT > Link Aggregation > Link Aggregation Control Protocol

Status Link Aggregation Setting **Link Aggregation Control Protocol**

Active ON
 System Priority

Group ID	LACP Active
T1	<input type="checkbox"/>
T2	<input type="checkbox"/>
T3	<input type="checkbox"/>
T4	<input type="checkbox"/>
T5	<input type="checkbox"/>
T6	<input type="checkbox"/>
T7	<input type="checkbox"/>

Port	LACP Timeout
*	30 seconds
1	30 seconds
2	30 seconds
3	30 seconds
4	30 seconds
5	30 seconds
6	30 seconds
7	30 seconds

The following table describes the labels in this screen.

Table 343 PORT > Link Aggregation > Link Aggregation Control Protocol

LABEL	DESCRIPTION
Active	Enable the switch button to enable Link Aggregation Control Protocol (LACP).
System Priority	LACP system priority is a number between 1 and 65535. The switch with the lowest system priority (and lowest port number if system priority is the same) becomes the LACP "server". The LACP "server" controls the operation of LACP setup. Enter a number to set the priority of an active port using Link Aggregation Control Protocol (LACP). The smaller the number, the higher the priority level.
Use this section to enable LACP on trunks.	
Group ID	The field identifies the link aggregation group, that is, one logical link containing multiple ports.
LACP Active	Select this option to enable LACP for a trunk.
Use this section to configure LACP timeout on ports.	
Port	This field displays the port number.

Table 343 PORT > Link Aggregation > Link Aggregation Control Protocol (continued)

LABEL	DESCRIPTION
*	<p>Settings in this row apply to all ports.</p> <p>Use this row only if you want to make some settings the same for all ports. Use this row first to set the common settings and then make adjustments on a port-by-port basis.</p> <p>Note: Changes in this row are copied to all the ports as soon as you make them.</p>
LACP Timeout	<p>Timeout is the time interval between the individual port exchanges of LACP packets in order to check that the peer port in the trunk group is still up. If a port does not respond after three tries, then it is deemed to be "down" and is removed from the trunk. Set a short timeout (1 second) for busy trunked links to ensure that disabled ports are removed from the trunk group as soon as possible.</p> <p>Select either 1 second or 30 seconds.</p>
Apply	<p>Click Apply to save your changes to the Switch's run-time memory. The Switch loses these changes if it is turned off or loses power, so use the Save link on the top navigation panel to save your changes to the non-volatile memory when you are done configuring.</p>
Cancel	<p>Click Cancel to begin configuring this screen afresh.</p>

80.22 PoE Status

A powered device (PD) is a device such as an access point or a switch, that supports PoE (Power over Ethernet) so that it can receive power from another device through an Ethernet port.

You can also set priorities so that the Switch is able to reserve and allocate power to certain PDs.

Note: The PoE (Power over Ethernet) devices that supply or receive power and their connected Ethernet cables must all be completely indoors.

Figure 526 PoE Example Application

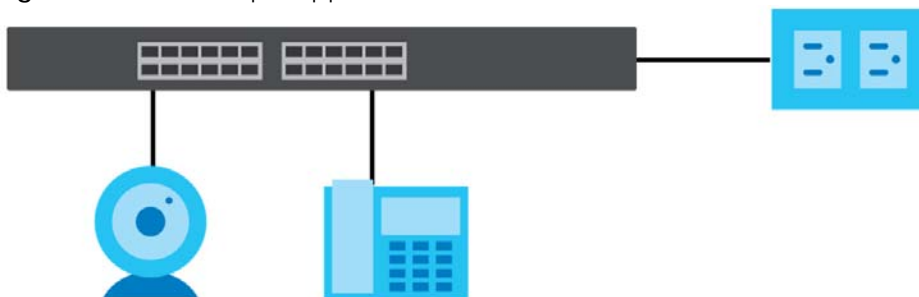

To view the current amount of power that PDs are receiving from the Switch, click **PORT > PoE Setup > PoE Status**.

Figure 527 PORT > PoE Setup > PoE Status

PoE Status		PoE Setup				
PoE Mode	Consumption					
Total Power (W)	980.0					
PoE Usage (%)	0					
Consuming Power (W)	0.0					
Allocated Power (W)	NA					
Remaining Power (W)	980.0					
Port	State	Class	Priority	Power-Up	Consuming Power (W)	Max Power (W)
1	Enable	0	Low	802.3af	0.0	-
2	Enable	0	Low	802.3af	0.0	-
3	Enable	0	Low	802.3af	0.0	-
4	Enable	0	Low	802.3af	0.0	-
5	Enable	0	Low	802.3af	0.0	-
6	Enable	0	Low	802.3af	0.0	-
7	Enable	0	Low	802.3af	0.0	-
8	Enable	0	Low	802.3af	0.0	-
9	Enable	0	Low	802.3af	0.0	-

The following table describes the labels in this screen.

Table 344 PORT > PoE Setup > PoE Status

LABEL	DESCRIPTION
PoE Mode	This field displays the power management mode used by the Switch, whether it is in Classification or Consumption mode.
Total Power (W)	This field displays the total power the Switch can provide to the connected PoE-enabled devices on the PoE ports.
PoE Usage (%)	This field displays the amount of power currently being supplied to connected PoE devices (PDs) as a percentage of the total PoE power the Switch can supply. When PoE usage reaches 100%, the Switch will shut down one-by-one according to the PD priority which you configured in PORT > PoE Setup > PoE Setup .
Consuming Power (W)	This field displays the amount of power the Switch is currently supplying to the connected PoE-enabled devices.
Allocated Power (W)	This field displays the total amount of power the Switch (in classification mode) has reserved for PoE after negotiating with the connected PoE devices. It shows NA when the Switch is in consumption mode. Consuming Power (W) can be less than or equal but not more than the Allocated Power (W) .
Remaining Power (W)	This field displays the amount of power the Switch can still provide for PoE. Note: The Switch must have at least 16 W of remaining power in order to supply power to a PoE device, even if the PoE device needs less than 16 W.
Port	This is the port index number.
State	This field shows which ports can receive power from the Switch. You can set this in Section 80.23 on page 655 . <ul style="list-style-type: none"> • Disable – The PD connected to this port cannot get power supply. • Enable – The PD connected to this port can receive power.

Table 344 PORT > PoE Setup > PoE Status (continued)

LABEL	DESCRIPTION
Class	<p>This shows the power classification of the PD. Each PD has a specified maximum power that fall under one of the classes.</p> <p>The Class is a number from 0 to 6, where each value represents the range of power that the Switch provides to the PD.</p> <p>Each class corresponds to a default maximum power that can be extended in Port > PoE Setup > PoE Setup to the following values.</p> <ul style="list-style-type: none"> • Class 0 – default: 0.44 W to 15.4 W. • Class 1 – default: 0.44 W to 4 W. • Class 2 – default: 0.44 W to 7 W. • Class 3 – default: 0.44 W to 15.4 W. • Class 4 – default: 0.44 W to 30 W. • Class 5 – default: 0.44 W to 45 W. • Class 6 – default: 0.44 W to 60 W.
Priority	<p>When the total power requested by the PDs exceeds the total PoE power budget on the Switch, you can set the PD priority to allow the Switch to provide power to ports with higher priority first.</p> <ul style="list-style-type: none"> • Critical has the highest priority. • High has the Switch assign power to the port after all critical priority ports are served. • Low has the Switch assign power to the port after all critical and high priority ports are served.
Power-Up	This field displays the PoE standard the Switch uses to provide power on this port.
Consuming Power (W)	This field displays the current amount of power consumed by the PD from the Switch on this port.
Max Power (W)	This field displays the maximum amount of power the PD could use from the Switch on this port.

80.23 PoE Setup

Use this screen to set the PoE power management mode, priority levels, power-up mode and the maximum amount of power for the connected PDs.

Click **PORT > PoE Setup > PoE Setup**, the following screen opens.

Figure 528 PORT > PoE Setup > PoE Setup

Port	Active	Priority	Power-Up	Max Power (mW)	LLDP Power Via MDI
*	<input type="checkbox"/>	Critical	802.3af		<input type="checkbox"/>
1	<input checked="" type="checkbox"/>	Low	802.3af		<input checked="" type="checkbox"/>
2	<input checked="" type="checkbox"/>	Low	802.3af		<input checked="" type="checkbox"/>
3	<input checked="" type="checkbox"/>	Low	802.3af		<input checked="" type="checkbox"/>
4	<input checked="" type="checkbox"/>	Low	802.3af		<input checked="" type="checkbox"/>
5	<input checked="" type="checkbox"/>	Low	802.3af		<input checked="" type="checkbox"/>
6	<input checked="" type="checkbox"/>	Low	802.3af		<input checked="" type="checkbox"/>
7	<input checked="" type="checkbox"/>	Low	802.3af		<input checked="" type="checkbox"/>
8	<input checked="" type="checkbox"/>	Low	802.3af		<input checked="" type="checkbox"/>
9	<input checked="" type="checkbox"/>	Low	802.3af		<input checked="" type="checkbox"/>
10	<input checked="" type="checkbox"/>	Low	802.3af		<input checked="" type="checkbox"/>
11	<input checked="" type="checkbox"/>	Low	802.3af		<input checked="" type="checkbox"/>
12	<input checked="" type="checkbox"/>	Low	802.3af		<input checked="" type="checkbox"/>
13	<input checked="" type="checkbox"/>	Low	802.3af		<input checked="" type="checkbox"/>
14	<input checked="" type="checkbox"/>	Low	802.3af		<input checked="" type="checkbox"/>
15	<input checked="" type="checkbox"/>	Low	802.3af		<input checked="" type="checkbox"/>
16	<input checked="" type="checkbox"/>	Low	802.3af		<input checked="" type="checkbox"/>

The following table describes the labels in this screen.

Table 345 Port > PoE Setup > PoE Setup

LABEL	DESCRIPTION
PoE Mode	<p>Select the power management mode you want the Switch to use.</p> <ul style="list-style-type: none"> Classification – Select this if you want the Switch to reserve the maximum power for each PD according to the PD’s power class and priority level. If the total power supply runs out, PDs with lower priority do not get power to function. In this mode, the maximum power is reserved based on what you configure in Max Power or the standard power limit for each class. Consumption – Select this if you want the Switch to supply the actual power that the PD needs. The Switch also allocates power based on a port’s Max Power and the PD’s power class and priority level. The Switch puts a limit on the maximum amount of power the PD can request and use. In this mode, the default maximum power that can be delivered to the PD is 33 W (IEEE 802.3at Class 4) or 22 W (IEEE 802.3af Classes 0 to 3).
Continuous PoE	<p>Select ON to guarantee continuous power supply to the connected PDs while the Switch is restarting after a warm reboot. The Switch will NOT perform a power cycle on the connected PDs.</p> <p>If you do a cold reboot, the Switch also restarts the connected PDs.</p>
Port	This is the port index number.
*	<p>Settings in this row apply to all ports.</p> <p>Use this row only if you want to make some settings the same for all ports. Use this row first to set the common settings and then make adjustments on a port-by-port basis.</p> <p>Changes in this row are copied to all the ports as soon as you make them.</p>
Active	<p>Select this to provide power to a PD connected to the port.</p> <p>If left unchecked, the PD connected to the port cannot receive power from the Switch.</p>

Table 345 Port > PoE Setup > PoE Setup (continued)

LABEL	DESCRIPTION
Priority	<p>When the total power requested by the PDs exceeds the total PoE power budget on the Switch, you can set the PD priority to allow the Switch to provide power to ports with higher priority.</p> <p>Select Critical to give the highest PD priority on the port.</p> <p>Select High to set the Switch to assign the remaining power to the port after all critical priority ports are served.</p> <p>Select Low to set the Switch to assign the remaining power to the port after all critical and high priority ports are served.</p>
Power-Up	<p>Set how the Switch provides power to a connected PD at power-up.</p> <p>802.3af – the Switch follows the IEEE 802.3af Power over Ethernet standard to supply power to the connected PDs during power-up.</p> <p>Legacy – the Switch can provide power to the connected PDs that require high inrush currents at power-up. Inrush current is the maximum, instantaneous input current drawn by the PD when first turned on.</p> <p>Pre-802.3at – the Switch initially offers power on the port according to the IEEE 802.3af standard, and then switches to support the IEEE 802.3at standard within 75 milliseconds after a PD is connected to the port. Select this option if the Switch is performing 2-event Layer-1 classification (PoE+ hardware classification) or the connected PD is NOT performing Layer 2 power classification using Link Layer Discovery Protocol (LLDP).</p> <p>802.3at – the Switch supports the IEEE 802.3at High Power over Ethernet standard and can supply power of up to 30 W per Ethernet port. IEEE 802.3at is also known as PoE+ or PoE Plus. An IEEE 802.3at compatible device is referred to as Type 2. Power Class 4 (High Power) can only be used by Type 2 devices. If the connected PD requires a Class 4 current when it is turned on, it will be powered up in this mode.</p> <p>Force-802.3at – the Switch offers power of up to 33 W on the port without performing PoE hardware classification. Select this option if the connected PD does not comply with any PoE standard and requests power higher than a standard power limit.</p> <p>Pre-802.3bt – the Switch offers power on the port according to the IEEE 802.3bt standard. Select this option if the connected PD was developed before the IEEE 802.3bt standard is implemented but requires power between 33 W and 60 W. IEEE 802.3bt is also known as PoE++ or PoE Plus Plus.</p> <p>802.3bt – the Switch supports the IEEE 802.3bt standard and can supply power of up to 60 W per Ethernet port to the connected PDs at power-up.</p>
Max Power (mW)	Specify the maximum amount of power the PD could use from the Switch on this port. If you leave this field blank, the Switch refers to the standard or default maximum power for each class.
LLDP Power Via MDI	<p>Select this to have the Switch negotiate PoE power with the PD connected to the port by transmitting LLDP Power Via MDI TLV frames. This helps the Switch allocate less power to the PD on this port. The connected PD must be able to request PoE power through LLDP.</p> <p>The Power Via MDI TLV allows PoE devices to advertise and discover the MDI power support capabilities of the sending port on the remote device.</p> <ul style="list-style-type: none"> • Port Class • MDI Supported • MDI Enabled • Pair Controllable • PSE Power Pairs • Power Class
Apply	Click Apply to save your changes to the Switch's run-time memory. The Switch loses these changes if it is turned off or loses power, so use the Save link on the top navigation panel to save your changes to the non-volatile memory when you are done configuring.
Cancel	Click Cancel to begin configuring this screen afresh.

80.24 Port Setup

Use this screen to configure Switch port settings. Click **PORT > Port Setup** in the navigation panel to display the configuration screen.

Figure 529 PORT > Port Setup

Port	Active	Name	Speed / Duplex	Flow Control	802.1p Priority	BPDU Ctrl	Media Type
*	<input type="checkbox"/>		Auto	Disable	0	Peer	SFP+
1	<input checked="" type="checkbox"/>		Auto	Disable	0	Peer	SFP+
2	<input checked="" type="checkbox"/>		Auto	Disable	0	Peer	SFP+
3	<input checked="" type="checkbox"/>		Auto	Disable	0	Peer	SFP+
4	<input checked="" type="checkbox"/>		Auto	Disable	0	Peer	SFP+
5	<input checked="" type="checkbox"/>		Auto	Disable	0	Peer	SFP+
6	<input checked="" type="checkbox"/>		Auto	Disable	0	Peer	SFP+
7	<input checked="" type="checkbox"/>		Auto	Disable	0	Peer	SFP+

The following table describes the labels in this screen.

Table 346 PORT > Port Setup

LABEL	DESCRIPTION
Port	This is the port index number.
*	<p>Settings in this row apply to all ports.</p> <p>Use this row only if you want to make some settings the same for all ports. Use this row first to set the common settings and then make adjustments on a port-by-port basis.</p> <p>Note: Changes in this row are copied to all the ports as soon as you make them.</p>
Active	Select this check box to enable a port. The factory default for all ports is enabled. A port must be enabled for data transmission to occur.
Name	<p>Type a descriptive name that identifies this port. You can enter up to 128 printable ASCII characters except [?], [], ['] or ["].</p> <p>Note: Due to space limitations, the port name may be truncated in some Web Configurator screens.</p>

Table 346 PORT > Port Setup (continued)

LABEL	DESCRIPTION
Speed/Duplex	<p>Select the speed and the duplex mode of the Ethernet connection on this port. The choices are Auto, Auto-1G, 10-an (10M/auto-negotiation), 10M / Full Duplex, 100-an (100M/auto-negotiation), 2.5G / Full Duplex, 5G / Full Duplex, and 100M / Full Duplex for a 100Base-T connection. 1G / Full Duplex is supported by both 1000Base-T and 1000Base-X connections. 10G / Full Duplex is supported by the 10 Gigabit Ethernet connections on the Switch that has a 10 Gigabit interface.</p> <p>Selecting Auto-1G or Auto (auto-negotiation) allows one port to negotiate with a peer port automatically to obtain the connection speed and duplex mode that both ends support. When auto-negotiation is turned on, a port on the Switch negotiates with the peer automatically to determine the connection speed and duplex mode. If the peer port does not support auto-negotiation or turns off this feature, the Switch determines the connection speed by detecting the signal on the cable and using half duplex mode. When the Switch's auto-negotiation is turned off, a port uses the pre-configured speed and duplex mode when making a connection, thus requiring you to make sure that the settings of the peer port are the same in order to connect.</p>
Flow Control	<p>A concentration of traffic on a port decreases port bandwidth and overflows buffer memory causing packet discards and frame losses. Flow Control is used to regulate transmission of signals to match the bandwidth of the receiving port.</p> <p>The Switch uses IEEE 802.3x flow control in full duplex mode and backpressure flow control in half duplex mode.</p> <p>IEEE 802.3x flow control is used in full duplex mode to send a pause signal to the sending port, causing it to temporarily stop sending signals when the receiving port memory buffers fill.</p> <p>Back Pressure flow control is typically used in half duplex mode to send a "collision" signal to the sending port (mimicking a state of packet collision) causing the sending port to temporarily stop sending signals and resend later.</p> <p>Select Tx Rx to allow the Switch port to send pause signal to the connected device, and for the connected device to send a pause signal to the Switch. The Switch will temporarily stop sending signals after receiving pause signal.</p> <p>Select Tx to allow the Switch port to send pause signal to the connected device.</p> <p>Select Rx to allow the connected device to send a pause signal to the Switch. The Switch will temporarily stop sending signals.</p> <p>Otherwise, select Disable.</p>
802.1p Priority	<p>This priority value is added to incoming frames without a (802.1p) tag.</p>
BPDU Ctrl	<p>Configure the way to treat BPDUs received on this port. You must activate Bridging Control Protocol Transparency in the SYSTEM > Switch Setup screen first.</p> <p>Select Peer to process any BPDU (Bridge Protocol Data Units) received on this port.</p> <p>Select Tunnel to forward BPDUs received on this port.</p> <p>Select Discard to drop any BPDU received on this port.</p> <p>Select Network to process a BPDU with no VLAN tag and forward a tagged BPDU.</p>
Media Type	<p>You can insert either an SFP+ transceiver or an SFP+ Direct Attach Copper (DAC) cable into the 10 Gigabit interface of the Switch.</p> <p>Select the media type (SFP+ or DAC10G) of the SFP+ module that is attached to the 10 Gigabit interface.</p>
Apply	<p>Click Apply to save your changes to the Switch's run-time memory. The Switch loses these changes if it is turned off or loses power, so use the Save link on the top navigation panel to save your changes to the non-volatile memory when you are done configuring.</p>
Cancel	<p>Click Cancel to begin configuring this screen afresh.</p>

80.25 SWITCHING

The following sections introduce the **SWITCHING** screens.

80.26 Port Mirroring

Port mirroring allows you to copy a traffic flow to a monitor port (the port you copy the traffic to) in order that you can examine the traffic from the monitor port without interference.

Click **SWITCHING > Mirroring** in the navigation panel to display the **Mirroring** screen. Use this screen to select a monitor port and specify the traffic flow to be copied to the monitor port.

Figure 530 SWITCHING > Mirroring

Port	Mirrored	Direction
*	<input type="checkbox"/>	ingress ▼
1	<input type="checkbox"/>	ingress ▼
2	<input type="checkbox"/>	ingress ▼
3	<input type="checkbox"/>	ingress ▼
4	<input type="checkbox"/>	ingress ▼
5	<input type="checkbox"/>	ingress ▼
6	<input type="checkbox"/>	ingress ▼
7	<input type="checkbox"/>	ingress ▼

The following table describes the labels in this screen.

Table 347 SWITCHING > Mirroring

LABEL	DESCRIPTION
Active	Enable the switch button to activate port mirroring on the Switch. Disable the switch to disable the feature.
Monitor Port	The monitor port is the port you copy the traffic to in order to examine it in more detail without interfering with the traffic flow on the original ports. Type the port number of the monitor port. In Stacking mode, the first box field is the slot ID and the second field is the port number.
Port	This field displays the port number.

Table 347 SWITCHING > Mirroring (continued)

LABEL	DESCRIPTION
*	Settings in this row apply to all ports. Use this row only if you want to make some settings the same for all ports. Use this row first to set the common settings and then make adjustments on a port-by-port basis. Note: Changes in this row are copied to all the ports as soon as you make them.
Mirrored	Select this option to mirror the traffic on a port.
Direction	Specify the direction of the traffic to mirror by selecting from the drop-down list box. Choices are Egress (outgoing), Ingress (incoming) and Both .
Apply	Click Apply to save your changes to the Switch's run-time memory. The Switch loses these changes if it is turned off or loses power, so use the Save link on the top navigation panel to save your changes to the non-volatile memory when you are done configuring.
Cancel	Click Cancel to reset the fields.

80.27 Multicast

Traditionally, IP packets are transmitted in one of either two ways – Unicast (1 sender to 1 recipient) or Broadcast (1 sender to everybody on the network). Multicast delivers IP packets to just a group of hosts on the network.

IGMP (Internet Group Management Protocol) is a network-layer protocol used to establish membership in a multicast group – it is not used to carry user data. Refer to RFC 1112, RFC 2236 and RFC 3376 for information on IGMP versions 1, 2 and 3 respectively.

This section shows you how to configure various multicast features.

80.27.1 What You Can Do

- Use the **IPv4 Multicast Status** screen ([Section 80.28 on page 661](#)) to view multicast group information.
- Use the **IGMP Snooping** screen ([Section 80.29 on page 662](#)) to enable IGMP snooping to forward group multicast traffic only to ports that are members of that group.
- Use the **IGMP Snooping VLAN** screen ([Section 80.30 on page 666](#)) to perform IGMP snooping on up to 16 VLANs.
- Use the **IGMP Filtering Profile** screen ([Section 80.31 on page 668](#)) to specify a range of multicast groups that clients connected to the Switch are able to join.

80.28 IPv4 Multicast Status

Click **SWITCHING > Multicast > IPv4 Multicast Status** to display the screen as shown. This screen shows the IPv4 multicast group information.

Figure 531 SWITCHING > Multicast > IPv4 Multicast Status

IPv4 Multicast Status			
IGMP Snooping		IGMP Snooping VLAN	
Index	VID	Port	Multicast Group
1	1	18	224.0.0.251
2	1	18	224.0.0.252
3	1	18	239.255.255.250

The following table describes the labels in this screen.

Table 348 SWITCHING > Multicast > IPv4 Multicast Status

LABEL	DESCRIPTION
Index	This is the index number of the entry.
VID	This field displays the multicast VLAN ID.
Port	This field displays the port number that belongs to the multicast group. In Stacking mode, the first number represents the slot and the second is the port number.
Multicast Group	This field displays IP multicast group addresses.

80.29 IGMP Snooping

A Switch can passively snoop on IGMP packets transferred between IP multicast routers or switches and IP multicast hosts to learn the IP multicast group membership. It checks IGMP packets passing through it, picks out the group registration information, and configures multicasting accordingly. IGMP snooping allows the Switch to learn multicast groups without you having to manually configure them.

The Switch forwards multicast traffic destined for multicast groups (that it has learned from IGMP snooping or that you have manually configured) to ports that are members of that group. IGMP snooping generates no additional network traffic, allowing you to significantly reduce multicast traffic passing through your Switch.

Click **SWITCHING > Multicast > IGMP Snooping** to display the screen as shown.

Figure 532 SWITCHING > Multicast > IGMP Snooping

IPv4 Multicast Status **IGMP Snooping** IGMP Snooping VLAN IGMP Filtering Profile

Active OFF

Querier

Querier Version v3

Report Proxy

Host Timeout 260 seconds

802.1p Priority No-Change

IGMP Filtering Active OFF

IGMP Snooping Smart Forward Active ON

Unknown Multicast Frame Flooding Drop Drop on VLAN

Unknown Multicast Frame to Querier Port Drop Forwarding Forwarding on VLAN

Reserved Multicast Group Flooding Drop

Port	Immediate Leave	Normal Leave	Fast Leave	Group Limited	Max Group Number	Throttling	IGMP Filtering Profile	IGMP Querier Mode
*	<input type="radio"/>	<input checked="" type="radio"/>	<input type="radio"/>	<input type="checkbox"/>	<input type="text"/>	Deny	Default	Auto
1	<input type="radio"/>	<input checked="" type="radio"/>	<input type="radio"/>	<input type="checkbox"/>	<input type="text"/>	Deny	Default	Auto
2	<input type="radio"/>	<input checked="" type="radio"/>	<input type="radio"/>	<input type="checkbox"/>	<input type="text"/>	Deny	Default	Auto
3	<input type="radio"/>	<input checked="" type="radio"/>	<input type="radio"/>	<input type="checkbox"/>	<input type="text"/>	Deny	Default	Auto
4	<input type="radio"/>	<input checked="" type="radio"/>	<input type="radio"/>	<input type="checkbox"/>	<input type="text"/>	Deny	Default	Auto
5	<input type="radio"/>	<input checked="" type="radio"/>	<input type="radio"/>	<input type="checkbox"/>	<input type="text"/>	Deny	Default	Auto
6	<input type="radio"/>	<input checked="" type="radio"/>	<input type="radio"/>	<input type="checkbox"/>	<input type="text"/>	Deny	Default	Auto
7	<input type="radio"/>	<input checked="" type="radio"/>	<input type="radio"/>	<input type="checkbox"/>	<input type="text"/>	Deny	Default	Auto

Apply Cancel

The following table describes the labels in this screen.

Table 349 SWITCHING > Multicast > IGMP Snooping

LABEL	DESCRIPTION
Active	Enable the switch button to enable IGMP Snooping to forward group multicast traffic only to ports that are members of that group.
Querier	Select this to allow the Switch to send IGMP General Query messages to the VLANs with the multicast hosts attached.
Querier Version	IGMP snooping query works only when both host and Switch support the same IGMP version. Select v2 to allow the Switch to send IGMPv2 queries only. Select v3 to allow the Switch to send IGMPv3 queries only.

Table 349 SWITCHING > Multicast > IGMP Snooping (continued)

LABEL	DESCRIPTION
Report Proxy	<p>Select this to allow the Switch to act as the IGMP report proxy and leave proxy. It will report group changes to a connected multicast router.</p> <p>The Switch not only checks IGMP packets between multicast routers or switches and multicast hosts to learn the multicast group membership, but also replaces the source MAC address in an IGMP v1/v2 report with its own MAC address before forwarding to the multicast router or switch. When the Switch receives more than one IGMP v1/v2 join report that requests to join the same multicast group, it only sends a new join report with its MAC address. This helps reduce the number of multicast join reports passed to the multicast router or switch.</p> <p>The Switch sends a leave message with its MAC address to the multicast router or switch only when it receives the leave message from the last host in a multicast group.</p>
Host Timeout	Specify the time (from 1 to 16711450) in seconds that elapses before the Switch removes an IGMP group membership entry if it does not receive report messages from the port.
802.1p Priority	Select a priority level (0 – 7) to which the Switch changes the priority in outgoing IGMP control packets. Otherwise, select No-Change to not replace the priority.
IGMP Filtering Active	<p>Enable the switch button to enable IGMP filtering to control which IGMP groups a subscriber on a port can join.</p> <p>If you enable IGMP filtering, you must create and assign IGMP filtering profiles for the ports that you want to allow to join multicast groups.</p>
IGMP Snooping Smart Forward Active	Enable the switch button to enable sending of multicast frame to querier port and IGMP subscriber groups. Otherwise, the querier port forwards the frames only when it receives a join report and it belongs to the IGMP group.
Unknown Multicast Frame	<p>Specify the action to perform when the Switch receives an unknown multicast frame.</p> <ul style="list-style-type: none"> • Select Flooding to send the frames to all ports. • Select Drop to discard the frames. • Select Drop on VLAN and enter the VLAN ID numbers to discard the frames on the specified VLANs. Use a dash to specify consecutive VLANs and a comma (no spaces) to specify non-consecutive VLANs. For example, 51–53 includes 51, 52 and 53, but 51,53 does not include 52.
Unknown Multicast Frame to Querier Port	<p>Specify the action to perform when Unknown Multicast Frame is set to Drop.</p> <ul style="list-style-type: none"> • Select Drop to discard the frames. • Select Forwarding to send the frames to all querier ports. • Select Forwarding on VLAN and enter the VLAN ID numbers to send the frames to the ports which are used as an IGMP query port on the specified VLANs. Use a dash to specify consecutive VLANs and a comma (no spaces) to specify non-consecutive VLANs. For example, 51–53 includes 51, 52 and 53, but 51,53 does not include 52.
Reserved Multicast Group	<p>The IP address range of 224.0.0.0 to 224.0.0.255 are reserved for multicasting on the local network only. For example, 224.0.0.1 is for all hosts on a local network segment and 224.0.0.9 is used to send RIP routing information to all RIP v2 routers on the same network segment. A multicast router will not forward a packet with the destination IP address within this range to other networks. See the IANA web site for more information.</p> <p>The layer-2 multicast MAC addresses used by Cisco layer-2 protocols, 01:00:0C:CC:CC:CC and 01:00:0C:CC:CC:CD, are also included in this group.</p> <p>Specify the action to perform when the Switch receives a frame with a reserved multicast address.</p> <ul style="list-style-type: none"> • Select Flooding to send the frames to all ports. • Select Drop to discard the frames.
Use this section to configure IGMP Snooping on each port.	
Port	This field displays the port number.

Table 349 SWITCHING > Multicast > IGMP Snooping (continued)

LABEL	DESCRIPTION
*	<p>Settings in this row apply to all ports.</p> <p>Use this row only if you want to make some settings the same for all ports. Use this row first to set the common settings and then make adjustments on a port-by-port basis.</p> <p>Changes in this row are copied to all the ports as soon as you make them.</p>
Immediate Leave	<p>Select this option to set the Switch to remove this port from the multicast tree when an IGMP version 2 leave message is received on this port.</p> <p>Select this option if there is only one host connected to this port.</p>
Normal Leave	<p>Enter an IGMP normal leave timeout value (from 200 to 6348800) in milliseconds. Select this option to have the Switch use this timeout to update the forwarding table for the port.</p> <p>In normal leave mode, when the Switch receives an IGMP leave message from a host on a port, it forwards the message to the multicast router. The multicast router then sends out an IGMP Group-Specific Query (GSQ) message to determine whether other hosts connected to the port should remain in the specific multicast group. The Switch forwards the query message to all hosts connected to the port and waits for IGMP reports from hosts to update the forwarding table.</p> <p>This defines how many seconds the Switch waits for an IGMP report before removing an IGMP snooping membership entry when an IGMP leave message is received on this port from a host.</p>
Fast Leave	<p>Enter an IGMP fast leave timeout value (from 200 to 6348800) in milliseconds. Select this option to have the Switch use this timeout to update the forwarding table for the port.</p> <p>In fast leave mode, right after receiving an IGMP leave message from a host on a port, the Switch itself sends out an IGMP Group-Specific Query (GSQ) message to determine whether other hosts connected to the port should remain in the specific multicast group. This helps speed up the leave process.</p> <p>This defines how many seconds the Switch waits for an IGMP report before removing an IGMP snooping membership entry when an IGMP leave message is received on this port from a host.</p>
Group Limited	<p>Select this option to limit the number of multicast groups this port is allowed to join.</p>
Max Group Number	<p>Enter the number of multicast groups this port is allowed to join. Once a port is registered in the specified number of multicast groups, any new IGMP join report frames is dropped on this port.</p>
Throttling	<p>IGMP throttling controls how the Switch deals with the IGMP reports when the maximum number of the IGMP groups a port can join is reached.</p> <p>Select Deny to drop any new IGMP join report received on this port until an existing multicast forwarding table entry is aged out.</p> <p>Select Replace to replace an existing entry in the multicast forwarding table with the new IGMP reports received on this port.</p>
IGMP Filtering Profile	<p>Select the name of the IGMP filtering profile to use for this port. Otherwise, select Default to prohibit the port from joining any multicast group.</p> <p>You can create IGMP filtering profiles in the SWITCHING > Multicast > IGMP Filtering Profile screen.</p>

Table 349 SWITCHING > Multicast > IGMP Snooping (continued)

LABEL	DESCRIPTION
IGMP Querier Mode	<p>The Switch treats an IGMP query port as being connected to an IGMP multicast router (or server). The Switch forwards IGMP join or leave packets to an IGMP query port.</p> <p>Select Auto to have the Switch use the port as an IGMP query port if the port receives IGMP query packets.</p> <p>Select Fixed to have the Switch always use the port as an IGMP query port. Select this when you connect an IGMP multicast server to the port.</p> <p>Select Edge to stop the Switch from using the port as an IGMP query port. The Switch will not keep any record of an IGMP router being connected to this port. The Switch does not forward IGMP join or leave packets to this port.</p>
Apply	Click Apply to save your changes to the Switch's run-time memory. The Switch loses these changes if it is turned off or loses power, so use the Save link on the top navigation panel to save your changes to the non-volatile memory when you are done configuring.
Cancel	Click Cancel to begin configuring this screen afresh.

80.30 IGMP Snooping VLAN

You can configure the Switch to automatically learn multicast group membership of any VLANs. The Switch then performs IGMP snooping on the first 16 VLANs that send IGMP packets. This is referred to as auto mode. Alternatively, you can specify the VLANs that IGMP snooping should be performed on. This is referred to as fixed mode. In fixed mode the Switch does not learn multicast group membership of any VLANs other than those explicitly added as an IGMP snooping VLAN.

Click **SWITCHING > Multicast > IGMP Snooping VLAN** to display the screen as shown.

Note: You can perform IGMP snooping on up to 16 VLANs.

Figure 533 SWITCHING > Multicast > IGMP Snooping VLAN

The screenshot shows the configuration interface for IGMP Snooping VLAN. At the top, there are four tabs: "IPv4 Multicast Status", "IGMP Snooping", "IGMP Snooping VLAN" (which is active and highlighted in green), and "IGMP Filtering Profile". Below the tabs, the "IGMP Snooping VLAN" section is visible. It includes a "Mode" section with two radio buttons: "auto" (selected with a green dot) and "fixed". Below the mode selection are "Apply" and "Cancel" buttons. Underneath is a "VLAN" section containing a table with columns for "Index", "Name", and "VID". The table has one row with the value "1" in the Index column, "VLAN66" in the Name column, and "66" in the VID column. To the right of the table are "Add/Edit" and "Delete" buttons.

Index	Name	VID
1	VLAN66	66

The following table describes the labels in this screen.

Table 350 SWITCHING > Multicast > IGMP Snooping VLAN

LABEL	DESCRIPTION
IGMP Snooping VLAN	
Mode	<p>Select auto to have the Switch learn multicast group membership information of any VLANs automatically.</p> <p>Select fixed to have the Switch only learn multicast group membership information of the VLANs that you specify below.</p> <p>In either auto or fixed mode, the Switch can learn up to 16 VLANs.</p> <p>The Switch drops any IGMP control messages which do not belong to these 16 VLANs.</p> <p>You must also enable IGMP snooping in the SWITCHING > Multicast > IGMP Snooping screen first.</p>
Apply	Click Apply to save your changes to the Switch's run-time memory. The Switch loses these changes if it is turned off or loses power, so use the Save link on the top navigation panel to save your changes to the non-volatile memory when you are done configuring.
Cancel	Click Cancel to begin configuring this screen afresh.
VLAN	
Use this section of the screen to add VLANs on which the Switch is to perform IGMP snooping.	
Index	This is the index number of the IGMP snooping VLAN entry in the table.
Name	This field displays the descriptive name for this VLAN group.
VID	This field displays the ID number of the VLAN group.
	Select an entry's check box to select a specific entry. Otherwise, select the check box in the table heading row to select all entries.
Add/Edit	Click Add/Edit to create a new entry or edit a selected one.
Delete	Click Delete to remove the selected entries.

80.30.1 Add/Edit IGMP Snooping VLANs

This screen allows you to add an IGMP snooping VLAN or edit an existing one.

To access this screen, click the **Add/Edit** button or select an entry from the list and click the **Add/Edit** button.

Figure 534 SWITCHING > Multicast > IGMP Snooping VLAN > Add/Edit

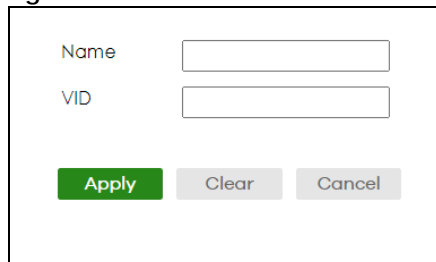

The screenshot shows a form with two input fields: "Name" and "VID". Below the fields are three buttons: "Apply" (green), "Clear" (grey), and "Cancel" (grey).

The following table describes the labels in this screen.

Table 351 SWITCHING > Multicast > IGMP Snooping VLAN > Add/Edit

LABEL	DESCRIPTION
Name	Enter the descriptive name (up to 32 printable ASCII characters except [?], [], ['], ["] or [,]) of the VLAN for identification purposes.
VID	Enter the ID of a static VLAN; the valid range is between 1 and 4094.
Apply	Click Apply to save your changes to the Switch's run-time memory. The Switch loses these changes if it is turned off or loses power, so use the Save link on the top navigation panel to save your changes to the non-volatile memory when you are done configuring.
Clear	Click Clear to clear the fields to the factory defaults.
Cancel	Click Cancel to not save the configuration you make and return to the last screen.

80.31 IGMP Filtering Profile

An IGMP filtering profile specifies a range of multicast groups that clients connected to the Switch are able to join. A profile contains a range of multicast IP addresses which you want clients to be able to join. Profiles are assigned to ports (in the **SWITCHING > Multicast > IGMP Snooping** screen). Clients connected to those ports are then able to join the multicast groups specified in the profile. Each port can be assigned a single profile. A profile can be assigned to multiple ports.

Click **SWITCHING > Multicast > IGMP Filtering Profile** link to display the screen as shown.

Figure 535 SWITCHING > Multicast > IGMP Filtering Profile

<input type="checkbox"/>	Profile Name	Start Address	End Address
<input type="checkbox"/>	Default	0.0.0.0	0.0.0.0
<input type="checkbox"/>	Profile 1	224.0.0.0	224.0.0.0
<input type="checkbox"/>		225.0.0.0	225.225.0.0

The following table describes the labels in this screen.

Table 352 SWITCHING > Multicast > IGMP Filtering Profile

LABEL	DESCRIPTION
Profile Name	This field displays the descriptive name of the profile.
Start Address	This field displays the start of the multicast address range.
End Address	This field displays the end of the multicast address range.
	Select an entry's check box to select a specific entry. Otherwise, select the check box in the table heading row to select all entries.
Add Profile	Click this to add a new IGMP filtering profile.

Table 352 SWITCHING > Multicast > IGMP Filtering Profile (continued)

LABEL	DESCRIPTION
Add Rule	Click Add Rule to add a new rule and specify the profile it belongs to in the Add Rule screen. You can also select a profile entry and click Add Rule to add an additional rule for the selected profile.
Delete	Select a profile and click Delete to remove the selected profile and the accompanying rules. Select a rule from a profile and click Delete to remove the selected rule.

80.31.1 Add IGMP Filtering Profile

To access this screen, click the **Add Profile** button in the **SWITCHING > Multicast > IGMP Filtering Profile** screen.

Figure 536 SWITCHING > Multicast > IGMP Filtering Profile > Add Profile

The following table describes the labels in this screen.

Table 353 SWITCHING > Multicast > IGMP Filtering Profile > Add Profile

LABEL	DESCRIPTION
Profile Name	Enter a descriptive name for the profile for identification purposes. You can enter up to 32 printable ASCII characters except [?], [], ['], ["] or [,].
Start Address	Enter the starting multicast IP address for a range of multicast IP addresses that you want to belong to the IGMP filter profile.
End Address	Enter the ending multicast IP address for a range of IP addresses that you want to belong to the IGMP filter profile. If you want to add a single multicast IP address, enter it in both the Start Address and End Address fields.
Apply	Click Apply to save your changes to the Switch's run-time memory. The Switch loses these changes if it is turned off or loses power, so use the Save link on the top navigation panel to save your changes to the non-volatile memory when you are done configuring.
Clear	Click Clear to clear the fields to the factory defaults.
Cancel	Click Cancel to not save the configuration you make and return to the last screen.

80.31.2 Add IGMP Filtering Rule

Click **Add Rule** in the **SWITCHING > Multicast > IGMP Filtering Profile** screen to access this screen.

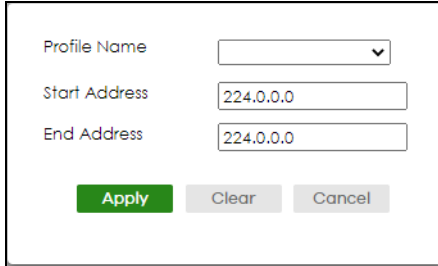
Figure 537 SWITCHING > Multicast > IGMP Filtering Profile > Add Rule

The following table describes the labels in this screen.

Table 354 SWITCHING > Multicast > IGMP Filtering Profile > Add Rule

LABEL	DESCRIPTION
Profile Name	Select a profile from the drop-down list to add a additional rule for the existing profile.
Start Address	Enter the starting multicast IP address for a range of multicast IP addresses that you want to belong to the IGMP filter profile.
End Address	Enter the ending multicast IP address for a range of IP addresses that you want to belong to the IGMP filter profile. If you want to add a single multicast IP address, enter it in both the Start Address and End Address fields.
Apply	Click Apply to save your changes to the Switch's run-time memory. The Switch loses these changes if it is turned off or loses power, so use the Save link on the top navigation panel to save your changes to the non-volatile memory when you are done configuring.
Clear	Click Clear to clear the fields to the factory defaults.
Cancel	Click Cancel to not save the configuration you make and return to the last screen.

80.32 VLAN

This section shows you how to configure 802.1Q tagged and port-based VLANs.

80.32.1 What You Can Do

- Use the **VLAN Status** screen ([Section 80.33 on page 673](#)) to view and search all static VLAN groups.
- Use the **VLAN Detail** screen ([Section 80.33.1 on page 674](#)) to view detailed port settings and status of the static VLAN group.
- Use the **Static VLAN** screen ([Section 80.34 on page 675](#)) to configure a static VLAN for the Switch.
- Use the **VLAN Port Setup** screen ([Section 80.35 on page 677](#)) to configure the static VLAN (IEEE 802.1Q) settings on a port.

80.32.2 What You Need to Know

Read this section to know more about VLAN and how to configure the screens.

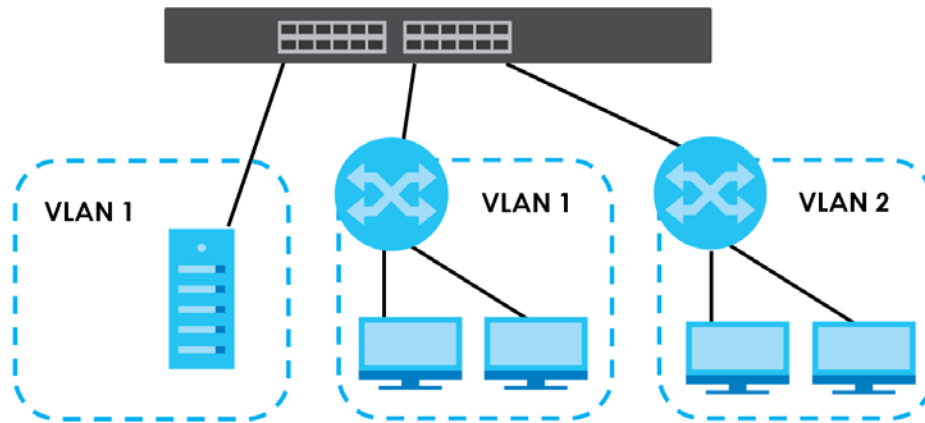
Figure 538 Shared Server Using VLAN Example

IEEE 802.1Q Tagged VLANs

A tagged VLAN uses an explicit tag (VLAN ID) in the MAC header to identify the VLAN membership of a frame across bridges – they are not confined to the switch on which they were created. The VLANs can be created statically by hand dynamically through GVRP. The VLAN ID associates a frame with a specific VLAN and provides the information that switches need to process the frame across the network. A tagged frame is 4 bytes longer than an untagged frame and contains 2 bytes of TPID (Tag Protocol Identifier, residing within the type or length field of the Ethernet frame) and 2 bytes of TCI (Tag Control Information, starts after the source address field of the Ethernet frame).

The CFI (Canonical Format Indicator) is a single-bit flag, always set to zero for Ethernet switches. If a frame received at an Ethernet port has a CFI set to 1, then that frame should not be forwarded as it is to an untagged port. The remaining twelve bits define the VLAN ID, giving a possible maximum number of 4,096 VLANs. Note that user priority and VLAN ID are independent of each other. A frame with VID (VLAN Identifier) of null (0) is called a priority frame, meaning that only the priority level is significant and the default VID of the ingress port is given as the VID of the frame. Of the 4,096 possible VIDs, a VID of 0 is used to identify priority frames and value 4095 (FFF) is reserved, so the maximum possible VLAN configurations are 4,094.

TPID	User Priority	CFI	VLAN ID
2 Bytes	3 Bits	1 Bit	12 bits

Forwarding Tagged and Untagged Frames

Each port on the Switch is capable of passing tagged or untagged frames. To forward a frame from an 802.1Q VLAN-aware switch to an 802.1Q VLAN-unaware switch, the Switch first decides where to forward the frame and then strips off the VLAN tag. To forward a frame from an 802.1Q VLAN-unaware switch to an 802.1Q VLAN-aware switch, the Switch first decides where to forward the frame, and then inserts a VLAN tag reflecting the ingress port's default VID. The default PVID is VLAN 1 for all ports, but this can be changed.

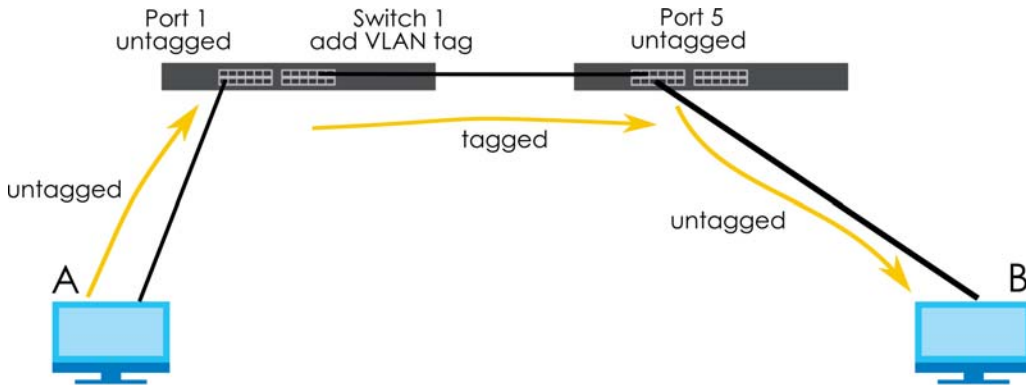
Figure 539 VLAN Forwarding Frame

A broadcast frame (or a multicast frame for a multicast group that is known by the system) is duplicated only on ports that are members of the VID (except the ingress port itself), thus confining the broadcast to a specific domain.

80.32.2.1 Automatic VLAN Registration

GARP and GVRP are the protocols used to automatically register VLAN membership across switches.

GARP

GARP (Generic Attribute Registration Protocol) allows network switches to register and de-register attribute values with other GARP participants within a bridged LAN. GARP is a protocol that provides a generic mechanism for protocols that serve a more specific application, for example, GVRP.

GARP Timers

Switches join VLANs by making a declaration. A declaration is made by issuing a Join message using GARP. Declarations are withdrawn by issuing a Leave message. A Leave All message terminates all registrations. GARP timers set declaration timeout values.

GVRP

GVRP (GARP VLAN Registration Protocol) is a registration protocol that defines a way for switches to register necessary VLAN members on ports across the network. Enable this function to permit VLAN groups beyond the local Switch.

Please refer to the following table for common IEEE 802.1Q VLAN terminology.

Table 355 IEEE 802.1Q VLAN Terminology

VLAN PARAMETER	TERM	DESCRIPTION
VLAN Type	Permanent VLAN	This is a static VLAN created manually.
	Dynamic VLAN	This is a VLAN configured by a GVRP registration or de-registration process.
VLAN Administrative Control	Registration Fixed	Fixed registration ports are permanent VLAN members.
	Registration Forbidden	Ports with registration forbidden are forbidden to join the specified VLAN.
	Normal Registration	Ports dynamically join a VLAN using GVRP.

Table 355 IEEE 802.1Q VLAN Terminology (continued)

VLAN PARAMETER	TERM	DESCRIPTION
VLAN Tag Control	Tagged	Ports belonging to the specified VLAN tag all outgoing frames transmitted.
	Untagged	Ports belonging to the specified VLAN do not tag all outgoing frames transmitted.
VLAN Port	Port VID	This is the VLAN ID assigned to untagged frames that this port received.
	Acceptable Frame Type	You may choose to accept both tagged and untagged incoming frames, just tagged incoming frames or just untagged incoming frames on a port.
	Ingress filtering	If set, the Switch discards incoming frames for VLANs that do not have this port as a member.

80.32.2.2 Port VLAN Trunking

Enable **VLAN Trunking** on a port to allow frames belonging to unknown VLAN groups to pass through that port. This is useful if you want to set up VLAN groups on end devices without having to configure the same VLAN groups on intermediary devices.

Refer to the following figure. Suppose you want to create VLAN groups 1 and 2 (V1 and V2) on devices A and B. Without **VLAN Trunking**, you must configure VLAN groups 1 and 2 on all intermediary switches C, D and E; otherwise they will drop frames with unknown VLAN group tags. However, with **VLAN Trunking** enabled on ports in each intermediary switch you only need to create VLAN groups in the end devices (A and B). C, D and E automatically allow frames with VLAN group tags 1 and 2 (VLAN groups that are unknown to those switches) to pass through their VLAN trunking ports.

Figure 540 Port VLAN Trunking

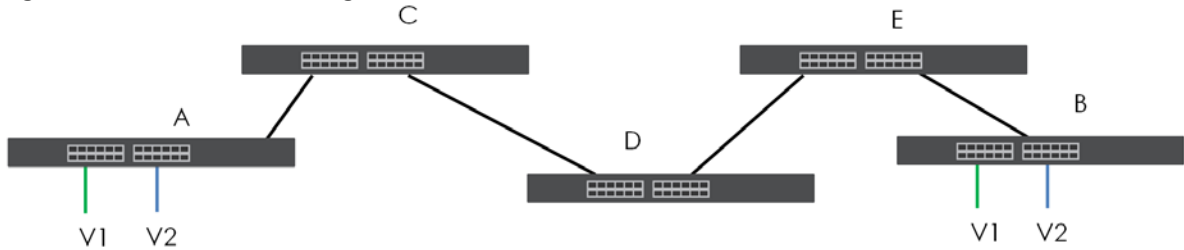

80.33 VLAN Status

Use this screen to view and search all static VLAN groups. Click **SWITCHING > VLAN > VLAN Status** from the navigation panel to display the screen as shown next.

Figure 541 SWITCHING > VLAN > VLAN Status

Index	VID	Name	Tagged Port	Untagged Port	Elapsed Time	Status
1	1	1	1	1-54	9:54:59	Static
2	2	2	2		0:51:05	Static
3	3	3			0:50:37	Static
4	100	VLAN100	5		0:50:13	Static

The following table describes the labels in this screen.

Table 356 SWITCHING > VLAN > VLAN Status

LABEL	DESCRIPTION
VLAN Search by VID	Enter (an) existing VLAN ID numbers (use a comma (,) to separate individual VLANs or a hyphen (-) to indicate a range of VLANs. For example, "3,4" or "3-9") and click Search to display only the specified VLANs in the list below. Leave this field blank and click Search to display all VLANs configured on the Switch.
The Number of VLAN	This is the number of VLANs configured on the Switch.
The Number of Search Results	This is the number of VLANs that match the searching criteria and display in the list below. This field displays only when you use the Search button to look for certain VLANs.
Index	This is the VLAN index number. Click an index number to view more VLAN details.
VID	This is the VLAN identification number that was configured in the corresponding VLAN configuration screen.
Name	This fields shows the descriptive name of the VLAN.
Tagged Port	This field shows the tagged ports that are participating in the VLAN.
Untagged Port	This field shows the untagged ports that are participating in the VLAN.
Elapsed Time	This field shows how long it has been since a normal VLAN was registered or a static VLAN was set up.
Status	This field shows how this VLAN was added to the Switch. <ul style="list-style-type: none"> • Dynamic – using GVRP • Static – added as a permanent VLAN

80.33.1 VLAN Details

Use this screen to view detailed port settings and status of the static VLAN group. Click an index number in the **VLAN Status** screen to display VLAN details.

Figure 542 SWITCHING > VLAN > VLAN Status > VLAN Status Details

VLAN Status		Static VLAN	VLAN Port Setup																								
VLAN Status > VLAN Status Details																											
VID	1																										
Elapsed Time	8:54:33																										
Status	Static																										
Port Number																											
		U:Untagged T:Tagged																									
2	4	6	8	10	12	14	16	18	20	22	24	26	28	30	32	34	36	38	40	42	44	46	48	50	52	54	
1	3	5	7	9	11	13	15	17	19	21	23	25	27	29	31	33	35	37	39	41	43	45	47	49	51	53	
U	U	U	U	U	U	U	U	U	U	U	U	U	U	U	U	U	U	U	U	U	U	U	U	U	U	U	U
U	U	U	U	U	U	U	U	U	U	U	U	U	U	U	U	U	U	U	U	U	U	U	U	U	U	U	U

The following table describes the labels in this screen.

Table 357 SWITCHING > VLAN > VLAN Status > VLAN Status Details

LABEL	DESCRIPTION
VID	This is the VLAN identification number that was configured in the corresponding VLAN configuration screen.
Elapsed Time	This field shows how long it has been since a normal VLAN was registered or a static VLAN was set up.
Status	This field shows how this VLAN was added to the Switch. <ul style="list-style-type: none"> • Dynamic: using GVRP • Static: added as a permanent entry
Port Number	This section displays the ports that are participating in a VLAN. A tagged port is marked as T, an untagged port is marked as U and ports not participating in a VLAN are marked as “-”.

80.34 Configure a Static VLAN

Use a static VLAN to decide whether an incoming frame on a port should be

- sent to a VLAN group as normal depending on its VLAN tag.
- sent to a group whether it has a VLAN tag or not.
- blocked from a VLAN group regardless of its VLAN tag.

You can also tag all outgoing frames (that were previously untagged) from a port with the specified VID.

Use this screen to view and configure a static VLAN for the Switch. Click **SWITCHING > VLAN > Static VLAN** to display the screen as shown next.

Figure 543 SWITCHING > VLAN > Static VLAN

	VID	Active	Name
<input type="checkbox"/>	1	ON	1
<input type="checkbox"/>	2	ON	2
<input checked="" type="checkbox"/>	3	ON	3
<input type="checkbox"/>	100	ON	VLAN100

The following table describes the related labels in this screen.

Table 358 SWITCHING > VLAN > Static VLAN

LABEL	DESCRIPTION
VID	This field displays the ID number of the VLAN group.
Active	This field indicates whether the VLAN settings are enabled or disabled.
Name	This field displays the descriptive name for this VLAN group.
	Select an entry's check box to select a specific entry. Otherwise, select the check box in the table heading row to select all entries.
Add/Edit	Click Add/Edit to add a new static VLAN or edit a selected one.
Delete	Click Delete to remove the selected static VLAN.

80.34.1 Add/Edit a Static VLAN

Use this screen to configure a static VLAN for the Switch. Click **Add/Edit**, or select an entry and click **Add/Edit** in the **SWITCHING > VLAN > Static VLAN** screen to display this screen.

Figure 544 SWITCHING > VLAN > Static VLAN > Add/Edit

Active: OFF

Name:

VLAN Group ID:

Port	Control	Tagging
*	Normal	<input checked="" type="checkbox"/> Tx Tagging
1	<input checked="" type="radio"/> Normal <input type="radio"/> Fixed <input type="radio"/> Forbidden	<input checked="" type="checkbox"/> Tx Tagging
2	<input checked="" type="radio"/> Normal <input type="radio"/> Fixed <input type="radio"/> Forbidden	<input checked="" type="checkbox"/> Tx Tagging
3	<input checked="" type="radio"/> Normal <input type="radio"/> Fixed <input type="radio"/> Forbidden	<input checked="" type="checkbox"/> Tx Tagging
4	<input checked="" type="radio"/> Normal <input type="radio"/> Fixed <input type="radio"/> Forbidden	<input checked="" type="checkbox"/> Tx Tagging
5	<input checked="" type="radio"/> Normal <input type="radio"/> Fixed <input type="radio"/> Forbidden	<input checked="" type="checkbox"/> Tx Tagging
6	<input checked="" type="radio"/> Normal <input type="radio"/> Fixed <input type="radio"/> Forbidden	<input checked="" type="checkbox"/> Tx Tagging
7	<input checked="" type="radio"/> Normal <input type="radio"/> Fixed <input type="radio"/> Forbidden	<input checked="" type="checkbox"/> Tx Tagging

Buttons: **Apply** Clear Cancel

The following table describes the related labels in this screen.

Table 359 SWITCHING > VLAN > Static VLAN > Add/Edit

LABEL	DESCRIPTION
Active	Enable the switch button to activate the VLAN settings.
Name	Enter a descriptive name for the VLAN group for identification purposes. This name consists of up to 64 printable ASCII characters. The string should not contain [?], [], ['], ["] or [,].
VLAN Group ID	Enter the VLAN ID for this static entry; the valid range is between 1 and 4094.
Port	The port number identifies the port you are configuring.
*	Settings in this row apply to all ports. Use this row only if you want to make some settings the same for all ports. Use this row first to set the common settings and then make adjustments on a port-by-port basis. Note: Changes in this row are copied to all the ports as soon as you make them.
Control	Select Normal for the port to dynamically join this VLAN group using GVRP. This is the default selection. Select Fixed for the port to be a permanent member of this VLAN group. Select Forbidden if you want to prohibit the port from joining this VLAN group.
Tagging	Select Tx Tagging if you want the port to tag all outgoing frames transmitted with this VLAN Group ID.
Apply	Click Apply to save your changes to the Switch's run-time memory. The Switch loses these changes if it is turned off or loses power, so use the Save link on the top navigation panel to save your changes to the non-volatile memory when you are done configuring.
Clear	Click Clear to clear the fields to the factory defaults.
Cancel	Click Cancel to not save the configuration you make and return to the last screen.

80.35 VLAN Port Setup

Use this screen to configure the static VLAN (IEEE 802.1Q) settings on a port. Click **SWITCHING > VLAN > VLAN Port Setup** to display the screen as shown.

Figure 545 SWITCHING > VLAN > VLAN Port Setup

Port	Ingress Check	PVID	Acceptable Frame Type	VLAN Trunking	Isolation
*	<input type="checkbox"/>	<input type="text"/>	All	<input type="checkbox"/>	<input type="checkbox"/>
1	<input type="checkbox"/>	1	All	<input type="checkbox"/>	<input type="checkbox"/>
2	<input type="checkbox"/>	1	All	<input type="checkbox"/>	<input type="checkbox"/>
3	<input type="checkbox"/>	1	All	<input type="checkbox"/>	<input type="checkbox"/>
4	<input type="checkbox"/>	1	All	<input type="checkbox"/>	<input type="checkbox"/>
5	<input type="checkbox"/>	1	All	<input type="checkbox"/>	<input type="checkbox"/>
6	<input type="checkbox"/>	1	All	<input type="checkbox"/>	<input type="checkbox"/>
7	<input type="checkbox"/>	1	All	<input type="checkbox"/>	<input type="checkbox"/>
8	<input type="checkbox"/>	1	All	<input type="checkbox"/>	<input type="checkbox"/>
9	<input type="checkbox"/>	1	All	<input type="checkbox"/>	<input type="checkbox"/>

The following table describes the labels in this screen.

Table 360 SWITCHING > VLAN > VLAN Port Setup

LABEL	DESCRIPTION
Port	This field displays the port number.
*	Settings in this row apply to all ports. Use this row only if you want to make some settings the same for all ports. Use this row first to set the common settings and then make adjustments on a port-by-port basis. Note: Changes in this row are copied to all the ports as soon as you make them.
Ingress Check	If this check box is selected, the Switch discards incoming frames on a port for VLANs that do not include this port in its member set. Clear this check box to disable ingress filtering.
PVID	A PVID (Port VLAN ID) is a tag that adds to incoming untagged frames received on a port so that the frames are forwarded to the VLAN group that the tag defines. Enter a number between 1 and 4094 as the port VLAN ID.
Acceptable Frame Type	Specify the type of frames allowed on a port. Choices are All , Tag Only and Untag Only . Select All from the drop-down list box to accept all untagged or tagged frames on this port. This is the default setting. Select Tag Only to accept only tagged frames on this port. All untagged frames will be dropped. Select Untag Only to accept only untagged frames on this port. All tagged frames will be dropped.
VLAN Trunking	Enable VLAN Trunking on ports connected to other switches or routers (but not ports directly connected to end users) to allow frames belonging to unknown VLAN groups to pass through the Switch.
Isolation	Select this to allow this port to communicate only with the CPU management port and the ports on which the isolation feature is NOT enabled.
Apply	Click Apply to save your changes to the Switch's run-time memory. The Switch loses these changes if it is turned off or loses power, so use the Save link on the top navigation panel to save your changes to the non-volatile memory when you are done configuring.
Cancel	Click Cancel to begin configuring this screen afresh.

80.36 SECURITY

The following sections introduce the **SECURITY** screens.

80.37 Access Control

A console port and FTP are allowed one session each, Telnet and SSH share nine sessions, up to five Web sessions (five different user names and passwords) and/or limitless SNMP access control sessions are allowed.

Table 361 Access Control Overview

Console Port	SSH	Telnet	FTP	Web	SNMP
One session	Share up to 9 sessions		One session	Up to 5 accounts	No limit

A console port access control session and Telnet access control session cannot coexist when multi-login is disabled. See the CLI Reference Guide for more information on disabling multi-login.

This section describes how to control access to the Switch.

80.37.1 What You Can Do

- Use the **Service Access Control** screen (Section 80.38 on page 679) to decide what services you may use to access the Switch.
- Use the **Remote Management** screen (Section 80.39 on page 680) to specify a group of one or more “trusted computers” from which an administrator may use a service to manage the Switch.

80.38 Service Access Control

Service Access Control allows you to decide what services you may use to access the Switch. You may also change the default service port and configure “trusted computers” for each service in the **Remote Management** screen (discussed earlier). Click **SECURITY > Access Control > Service Access Control** to view the screen as shown.

Figure 546 SECURITY > Access Control > Service Access Control

Services	Active	Service Port	Timeout	Login Timeout
Console	<input type="checkbox"/>		5 Minutes	
Telnet	<input checked="" type="checkbox"/>	23	5 Minutes	150 Seconds
SSH	<input checked="" type="checkbox"/>	22		
FTP	<input checked="" type="checkbox"/>	21	5 Minutes	
HTTP	<input checked="" type="checkbox"/>	80	5 Minutes	
HTTPS	<input checked="" type="checkbox"/>	443		
ICMP	<input checked="" type="checkbox"/>			
SNMP	<input type="checkbox"/>			

The following table describes the fields in this screen.

Table 362 SECURITY > Access Control > Service Access Control

LABEL	DESCRIPTION
Services	Services you may use to access the Switch are listed here.
Active	Enable the switch button for the corresponding services that you want to allow to access the Switch.
Service Port	For Telnet, SSH, FTP, HTTP or HTTPS services, you may change the default service port by typing the new port number in the Service Port field. If you change the default port number then you will have to let people (who wish to use the service) know the new port number for that service.
Timeout	Enter how many minutes (from 1 to 255) a management session can be left idle before the session times out. After it times out you have to log in with your password again. Very long idle timeouts may have security risks.

Table 362 SECURITY > Access Control > Service Access Control (continued)

LABEL	DESCRIPTION
Login Timeout	The Telnet or SSH server do not allow multiple user logins at the same time. Enter how many seconds (from 30 to 300 seconds) a login session times out. After it times out you have to start the login session again. Very long login session timeouts may have security risks. For example, if User A attempts to connect to the Switch (through SSH), but during the login stage, do not enter the user name and/or password, User B cannot connect to the Switch (through SSH) before the Login Timeout for User A expires (default 150 seconds).
Apply	Click Apply to save your changes to the Switch's run-time memory. The Switch loses these changes if it is turned off or loses power, so use the Save link on the top navigation panel to save your changes to the non-volatile memory when you are done configuring.
Cancel	Click Cancel to begin configuring this screen afresh.

80.39 Remote Management

Use this screen to specify a group of one or more "trusted computers" from which an administrator may use a service to manage the Switch.

Click **SECURITY > Access Control > Remote Management** to view the screen as shown next.

Figure 547 SECURITY > Access Control > Remote Management

The screenshot shows the 'Remote Management' configuration page. At the top, there is a 'Secured Client Setup' section with a table. The table has the following columns: Entry, Active, Start Address, End Address, Telnet, FTP, HTTP, ICMP, SNMP, SSH, and HTTPS. There are 7 rows in the table. Row 1 is active (ON) and has all services checked. Rows 2 through 7 are inactive (OFF) and have all services unchecked. Below the table, there are 'Apply' and 'Cancel' buttons.

Entry	Active	Start Address	End Address	Telnet	FTP	HTTP	ICMP	SNMP	SSH	HTTPS
1	ON	0.0.0.0	0.0.0.0	<input checked="" type="checkbox"/>	<input checked="" type="checkbox"/>	<input checked="" type="checkbox"/>	<input checked="" type="checkbox"/>	<input checked="" type="checkbox"/>	<input checked="" type="checkbox"/>	<input checked="" type="checkbox"/>
2	OFF	0.0.0.0	0.0.0.0	<input type="checkbox"/>	<input type="checkbox"/>	<input type="checkbox"/>	<input type="checkbox"/>	<input type="checkbox"/>	<input type="checkbox"/>	<input type="checkbox"/>
3	OFF	0.0.0.0	0.0.0.0	<input type="checkbox"/>	<input type="checkbox"/>	<input type="checkbox"/>	<input type="checkbox"/>	<input type="checkbox"/>	<input type="checkbox"/>	<input type="checkbox"/>
4	OFF	0.0.0.0	0.0.0.0	<input type="checkbox"/>	<input type="checkbox"/>	<input type="checkbox"/>	<input type="checkbox"/>	<input type="checkbox"/>	<input type="checkbox"/>	<input type="checkbox"/>
5	OFF	0.0.0.0	0.0.0.0	<input type="checkbox"/>	<input type="checkbox"/>	<input type="checkbox"/>	<input type="checkbox"/>	<input type="checkbox"/>	<input type="checkbox"/>	<input type="checkbox"/>
6	OFF	0.0.0.0	0.0.0.0	<input type="checkbox"/>	<input type="checkbox"/>	<input type="checkbox"/>	<input type="checkbox"/>	<input type="checkbox"/>	<input type="checkbox"/>	<input type="checkbox"/>
7	OFF	0.0.0.0	0.0.0.0	<input type="checkbox"/>	<input type="checkbox"/>	<input type="checkbox"/>	<input type="checkbox"/>	<input type="checkbox"/>	<input type="checkbox"/>	<input type="checkbox"/>

The following table describes the labels in this screen.

Table 363 SECURITY > Access Control > Remote Management

LABEL	DESCRIPTION
Entry	This is the client set index number. A "client set" is a group of one or more "trusted computers" from which an administrator may use a service to manage the Switch.
Active	Enable the switch button to activate this secured client set. Clear the check box if you wish to temporarily disable the set without deleting it.

Table 363 SECURITY > Access Control > Remote Management (continued)

LABEL	DESCRIPTION
Start Address	Configure the IP address range of trusted computers from which you can manage this Switch.
End Address	The Switch checks if the client IP address of a computer requesting a service or protocol matches the range set here. The Switch immediately disconnects the session if it does not match.
Telnet / FTP / HTTP / ICMP / SNMP / SSH / HTTPS	Select services that may be used for managing the Switch from the specified trusted computers.
Apply	Click Apply to save your changes to the Switch's run-time memory. The Switch loses these changes if it is turned off or loses power, so use the Save link on the top navigation panel to save your changes to the non-volatile memory when you are done configuring.
Cancel	Click Cancel to begin configuring this screen afresh.

80.40 Storm Control

Storm control limits the number of broadcast, multicast and destination lookup failure (DLF) packets the Switch receives per second on the ports. When the maximum number of allowable broadcast, multicast and/or DLF packets is reached per second, the subsequent packets are discarded. Enable this feature to reduce broadcast, multicast and/or DLF packets in your network. You can specify limits for each packet type on each port.

Click **SECURITY > Storm Control** in the navigation panel to display the screen as shown next.

Figure 548 SECURITY > Storm Control

Storm Control

Active OFF

Port	Broadcast (pkt/s)	Multicast (pkt/s)	DLF (pkt/s)
*	<input type="checkbox"/> <input type="text"/>	<input type="checkbox"/> <input type="text"/>	<input type="checkbox"/> <input type="text"/>
1	<input type="checkbox"/> <input type="text" value="0"/>	<input type="checkbox"/> <input type="text" value="0"/>	<input type="checkbox"/> <input type="text" value="0"/>
2	<input type="checkbox"/> <input type="text" value="0"/>	<input type="checkbox"/> <input type="text" value="0"/>	<input type="checkbox"/> <input type="text" value="0"/>
3	<input type="checkbox"/> <input type="text" value="0"/>	<input type="checkbox"/> <input type="text" value="0"/>	<input type="checkbox"/> <input type="text" value="0"/>
4	<input type="checkbox"/> <input type="text" value="0"/>	<input type="checkbox"/> <input type="text" value="0"/>	<input type="checkbox"/> <input type="text" value="0"/>
5	<input type="checkbox"/> <input type="text" value="0"/>	<input type="checkbox"/> <input type="text" value="0"/>	<input type="checkbox"/> <input type="text" value="0"/>
6	<input type="checkbox"/> <input type="text" value="0"/>	<input type="checkbox"/> <input type="text" value="0"/>	<input type="checkbox"/> <input type="text" value="0"/>
7	<input type="checkbox"/> <input type="text" value="0"/>	<input type="checkbox"/> <input type="text" value="0"/>	<input type="checkbox"/> <input type="text" value="0"/>

The following table describes the labels in this screen.

Table 364 SECURITY > Storm Control

LABEL	DESCRIPTION
Active	Enable the switch button to enable traffic storm control on the Switch. Disable the switch button to disable this feature.
Port	This field displays the port number.
*	Settings in this row apply to all ports. Use this row only if you want to make some settings the same for all ports. Use this row first to set the common settings and then make adjustments on a port-by-port basis. Note: Changes in this row are copied to all the ports as soon as you make them.
Broadcast (pkt/s)	Select this option and specify how many broadcast packets the port receives per second.
Multicast (pkt/s)	Select this option and specify how many multicast packets the port receives per second.
DLF (pkt/s)	Select this option and specify how many destination lookup failure (DLF) packets the port receives per second.
Apply	Click Apply to save your changes to the Switch's run-time memory. The Switch loses these changes if it is turned off or loses power, so use the Save link on the top navigation panel to save your changes to the non-volatile memory when you are done configuring.
Cancel	Click Cancel to reset the fields.

80.41 MAINTENANCE

This section explains how to configure the screens that let you maintain the firmware and configuration files.

80.42 What You Can Do

- Use the **Restore Configuration** screen ([Section 80.43 on page 682](#)) to upload a stored device configuration file.
- Use the **Backup Configuration** screen ([Section 80.44 on page 683](#)) to save your configuration for later use.
- Use the **Save Configuration** screen ([Section 80.45 on page 684](#)) to save the current configuration settings to a specific configuration file on the Switch.
- Use the **Firmware Upgrade** screen ([Section 80.46 on page 684](#)) to upload the latest firmware.
- Use the **Reboot System** screen ([Section 80.47 on page 685](#)) to restart the Switch without physically turning the power off and load a specific configuration file.
- Use the **Tech-Support** screen ([Section 80.48 on page 686](#)) to create reports for customer support if there are problems with the Switch.

80.43 Restore Configuration

Use this screen to restore a previously saved configuration file from your computer to the Switch.

Click **MAINTENANCE > Configuration > Restore Configuration** to access this screen.

Figure 549 MAINTENANCE > Configuration > Restore Configuration

- 1 Click **Choose File** or **Browse** to locate the configuration file you wish to restore.
- 2 After you have specified the file, click **Restore**.

The Switch will run on the restored configuration after the restore process.

Figure 550 Configuration Restoring

80.44 Backup Configuration

Backing up your Switch configurations allows you to create various “snap shots” of your device from which you may restore at a later date. Use this screen to back up your current Switch configuration to a computer.

To access this screen, click **MAINTENANCE > Configuration > Backup Configuration** in the navigation panel.

Figure 551 MAINTENANCE > Configuration > Backup Configuration

Follow the steps below to back up the current Switch configuration to your computer in this screen.

- 1 Select which Switch configuration file you want to download to your computer.
- 2 Click **Backup**.

- 3 If the current configuration file is open and/or downloaded to your computer automatically, you can click **File > Save As** on your computer to save the file to a specific place.

If a dialog box pops up asking whether you want to open or save the file, click **Save** or **Save File** to download it to the default downloads folder on your computer. If a **Save As** screen displays after you click **Save** or **Save File**, choose a location to save the file on your computer from the **Save in** drop-down list box and type a descriptive name for it in the **File name** list box. Click **Save** to save the configuration file to your computer.

80.45 Save Configuration

To access this screen, click **MAINTENANCE > Configuration > Save Configuration** in the navigation panel.

Click **Current Configuration** to save the current configuration settings permanently to the Switch. This configuration is set up according to your network environment.

Click **Custom Default** to save the current configuration settings permanently to a customized default file on the Switch.

Figure 552 Maintenance > Configuration > Save Configuration

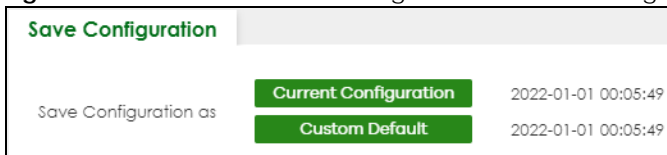

Note: If a customized default file was not saved, clicking **Custom Default** loads the factory default configuration on the Switch.

Alternatively, click **Save** on the top right in any screen to save the configuration changes to the current configuration.

Note: Clicking the **Apply** button after making configuration does NOT save the changes permanently. All unsaved changes are erased after you reboot the Switch.

80.46 Firmware Upgrade

Use the following screen to upgrade your Switch to the latest firmware.

Note: Make sure you have downloaded (and unzipped) the correct model firmware and version to your computer before uploading to the device.

Click **MAINTENANCE > Firmware Upgrade** to view the screen as shown next.

Figure 553 MAINTENANCE > Firmware Upgrade

Name	Version
XGS2220-54FP	Running V4.80[ACCE.0]b6 04/11/2022

To upgrade the switch firmware, browse the location of the binary (.BIN) file and click Upgrade button.

File Path No file chosen

Click **Choose File** or **Browse** to locate the firmware file you wish to upload to the Switch. Firmware upgrades are only applied after a reboot. Click **Upgrade** to load the new firmware.

After the firmware upgrade process is complete, see the **MONITOR > System Information** screen to verify your current firmware version number.

Table 365 MAINTENANCE > Firmware Upgrade

LABEL	DESCRIPTION
Name	This is the name of the Switch that you are configuring.
Version	This is the version number (and model code) and MM/DD/YYYY creation date of the firmware currently in use on the Switch. The firmware information is also displayed in MONITOR > SYSTEM Information .
File Path	Click Choose File or Browse to locate the firmware file you wish to upload to the Switch.
Upgrade	Click Upgrade to load the new firmware. Firmware upgrades are only applied after a reboot. To reboot, go to MAINTENANCE > Reboot System and click Current Configuration , Factory Default , or Custom Default (Current Configuration , Factory Default , and Custom Default are the configuration files you want the Switch to use when it restarts).

80.47 Reboot System

Reboot System allows you to restart the Switch without physically turning the power off. It also allows you to load the **Current Configuration**, a **Custom Default** or the **Factory Default** configuration when you reboot. Follow the steps below to reboot the Switch.

Click **MAINTENANCE > Reboot System** to view the screen as shown next.

Figure 554 MAINTENANCE > Reboot System

Current Configuration is Configuration 1

Reboot System with

- 1 Click the **Current Configuration**, **Factory Default**, or **Custom Default** button to reboot and load that configuration file. The confirmation screen displays.

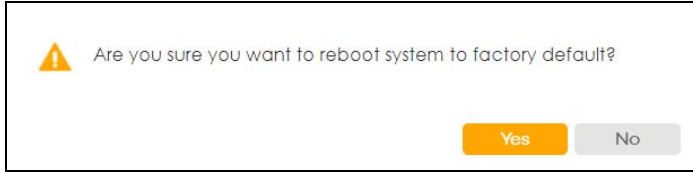
Figure 555 Reboot Confirmation Example: Factory Default

- 2 Click **YES** and then wait for the Switch to restart. This takes up to 2 minutes.

Click **Current Configuration** and follow steps 1 to 2 to reboot and load configuration one on the Switch.

Click **Factory Default** and follow steps 1 to 2 to reboot and load Zyxel factory default configuration settings on the Switch.

Click **Custom Default** and follow steps 1 to 2 to reboot and load a customized default file on the Switch.

80.48 Tech-Support

The Tech-Support feature is a log enhancement tool that logs useful information such as CPU utilization history, memory and Mbuf (Memory Buffer) log and crash reports for issue analysis by customer support should you have difficulty with your Switch. The Tech Support menu eases your effort in obtaining reports and it is also available in CLI command by typing "Show tech-support" command.

Click **MAINTENANCE > Tech-Support** to see the following screen.

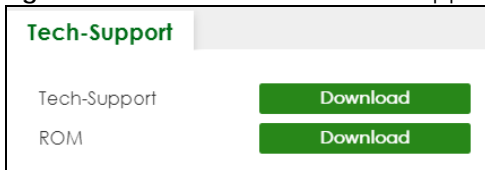
Figure 556 MAINTENANCE > Tech-Support

You may need WordPad or similar software to see the log report correctly. The table below describes the fields in the above screen.

Table 366 MAINTENANCE > Tech-Support

LABEL	DESCRIPTION
Tech-Support	Click Download to see all the log report and system status. This log report is stored in flash memory. If the All log report is too large, you can download the log reports separately below.
ROM	Click Download to see the Read Only Memory (ROM) log report. This report is stored in flash memory.

80.48.1 Tech-Support Download

When you click **Download** to save your current Switch configuration to a computer, the following screen appears. When the log report has downloaded successfully, click **Back** to return to the previous screen.

Figure 557 MAINTENANCE > Tech-Support: Download

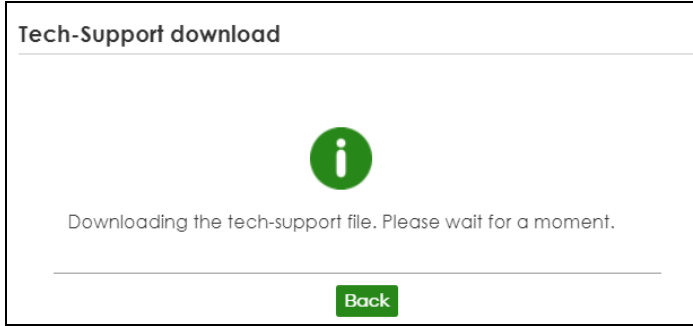

PART III

Troubleshooting and Appendices

CHAPTER 81

Troubleshooting

This chapter offers some suggestions to solve problems you might encounter. The potential problems are divided into the following categories.

- [Power, Hardware Connections, and LEDs](#)
- [Switch Access and Login](#)
- [Switch Configuration](#)
- [PoE Supply](#)
- [Nebula Registration](#)

81.1 Power, Hardware Connections, and LEDs

[The Switch does not turn on. None of the LEDs turn on.](#)

- 1 Make sure you are using the power adapter or cord included with the Switch.
- 2 Make sure the power adapter or cord is connected to the Switch and plugged in to an appropriate power source. Make sure the power source is turned on.
- 3 Disconnect and re-connect the power adapter or cord to the Switch.
- 4 If the problem continues, contact the vendor.

[One of the LEDs does not behave as expected.](#)

- 1 Make sure you understand the normal behavior of the LED. See [Section 3.3 on page 54](#).
- 2 Check the hardware connections. See [Section 3.1 on page 45](#).
- 3 Inspect your cables for damage. Contact the vendor to replace any damaged cables.
- 4 Disconnect and re-connect the power adapter or cord to the Switch.
- 5 If the problem continues, contact the vendor.

81.2 Switch Access and Login

I can see the **Login** screen, but I cannot log in to the Switch. (I forgot the user name and/or password.)

- 1 Check the Switch's management mode by using the **CLOUD** LED. See [Section 3.3 on page 54](#) for more information on the LED descriptions.
 - If you are in Cloud management mode, use the **Local credentials Password** to log in to the cloud mode – local GUI. The **Local credentials Password** can be found in **Site-wide > Configure > Site settings > Device configuration: Local credentials: Password** in the NCC portal.
 - If you are in standalone management mode, use the default user name **admin** and the default password **1234**.

- 2 Depending on your Switch's management mode, make sure you have entered the correct user name and password. These fields are case-sensitive, please make sure [Caps Lock] is not on.

Note: Steps 1 and 2 are applicable if you get an invalid administrator password when using some functions in the ZON utility. See [Section 1.1.5 on page 34](#) for more information.

- 3 You may have exceeded the maximum number of concurrent Telnet sessions. Close other Telnet sessions or try connecting again later.

Check that you have enabled logins for HTTP or Telnet. If you have configured a secured client IP address, your computer's IP address must match it. Refer to the chapter on access control for details.

- 4 If this does not work, or you are not sure what the Switch's management mode is, you have to reset the device to its factory defaults (standalone management mode) first. See [Section 4.9 on page 98](#) for more information on resetting the Switch. (Temporarily disconnect the Internet connection to the Switch after the reset process, to prevent the Switch from being managed by NCC again.)

Note: After performing step 4 and you want to use the Cloud management mode, make sure the Switch is registered in your organization and site in the NCC portal. To register the Switch again, scan the QR code using the Zyxel Nebula Mobile app. See the [Section on page 33](#) for more information on using the app to register the Switch.

I forgot the IP address for the Switch.

- 1 Use the domain name "setup.zyxel" to access the Switch whether the Switch is using a DHCP-assigned IP or static IP address. If you cannot use this method, please use the following method to find the IP address.

Note: This requires your computer to be directly connected to the Switch. Make sure your computer is able to connect to a DNS server through the Switch.

- 2 The default IP address is **http://DHCP-assigned IP** (when connecting to a DHCP server) or **192.168.1.1**.
- 3 Use the NCC (Nebula Control Center) or the ZON utility to find the IP address. The Switch must be registered and added to a site in Nebula in order for it to be managed using Nebula.

- 4 If the Switch is removed from a site in Nebula, all the settings in the configuration file are reset to the Nebula factory defaults except for the IP address. If you changed the default dynamic IP address to a static IP address while the Switch was in a site in Nebula, the Switch will retain that static IP address after you remove it from the site in Nebula.
- 5 If this does not work, you have to reset the device to its factory defaults. See [Section 4.9 on page 98](#).

I cannot see or access the **Login** screen in the Web Configurator.

- 1 Make sure you are using the correct IP address.
 - If you changed the IP address, use the new IP address.
 - The default in-band IP address in standalone mode is [http://DHCP-assigned IP](#) (when connecting to a DHCP server) or [192.168.1.1](#).
The default in-band IP address in stacking mode is **192.168.1.1**.
 - If you changed the IP address and have forgotten it, see the troubleshooting suggestions for [I forgot the IP address for the Switch](#).
- 2 Check the hardware connections, and make sure the LEDs are behaving as expected. See [Section 3.3 on page 54](#).
- 3 Make sure your Internet browser does not block pop-up windows and has JavaScripts and Java enabled.
- 4 Make sure your computer is in the same subnet as the Switch. (If you know that there are routers between your computer and the Switch, skip this step.)
- 5 Reset the device to its factory defaults, and try to access the Switch with the default IP address. See [Section 4.8 on page 97](#).
- 6 If the problem continues, contact Zyxel technical support, or try the advanced suggestion.

Advanced Suggestion

- Try to access the Switch using another service, such as Telnet. If you can access the Switch, check the remote management settings to find out why the Switch does not respond to HTTP.

Pop-up Windows, JavaScripts and Java Permissions

In order to use the Web Configurator you need to allow:

- Web browser pop-up windows from your device.
- JavaScripts (enabled by default).
- Java permissions (enabled by default).

There is unauthorized access to my Switch through telnet, HTTP and SSH.

Go to the **MONITOR > System Log** screen to check for logs of unauthorized access to your Switch. To avoid unauthorized access, configure the secured client setting in the **SECURITY > Access Control > Remote Management** screen for telnet, HTTP and SSH (see [Section 67.3 on page 500](#)). Computers not belonging to the secured client set cannot get permission to access the Switch.

81.3 Switch Configuration

[I lost my configuration settings after I restarted the Switch.](#)

Make sure you save your configuration into the Switch's non-volatile memory each time you make changes. Click **Save** at the top right of the Web Configurator to save the configuration permanently. See also [Section 79.12 on page 616](#) for more information about how to save your configuration.



[I accidentally unplugged the Switch. I am not sure which configuration file will be loaded.](#)

If you plug the power cable back to the Switch, it will reboot and load the configuration file that was used the last time. For example, if **Config 1** was used on the Switch before you accidentally unplugged the Switch, **Config 1** will be loaded when rebooting.

[I want to use a different configuration file on the Switch, what should I do?](#)

- 1 Go to **MAINTENANCE > Configuration > Restore Configuration**.
- 2 Click **Choose File** or **Browse** to locate the configuration file you wish to restore.
- 3 After you have specified the file, click **Restore**. The Switch will run on the restored configuration after the restore process.

81.4 PoE Supply

[My Powered Devices \(PDs\) are not receiving power.](#)

- 1 Check the **PoE Usage** on the **Dashboard**. This field displays the amount of power the Switch is currently supplying to the connected PDs and the total power the Switch can provide to the connected PDs. It also shows the percentage of PoE power usage.
When PoE usage reaches 100%, the Switch will shut down PDs one-by-one according to the PD **Priority** which you configured in **PORT > PoE Setup > PoE Setup**.
- 2 Use the correct type of Ethernet cable for the corresponding PoE standard you are using.
- 3 Make sure the **Active** check box for the port supplying PoE power to PDs is enabled.
- 4 Check if you have set a pre-defined schedule to control when the Switch enables PoE to provide power on the port in **PORT > PoE Setup > PoE Time Range Setup**.
- 5 If the connected IEEE 802.3at / IEEE 802.3af PD does not fully comply with any PoE standard, select **Legacy** or **Force-802.3at** in **PORT > PoE Setup > PoE Setup > Power-Up**.
- 6 If the problem continues, contact Zyxel technical support.

81.5 Nebula Registration

[I cannot register the Switch in Nebula because the previous owner has registered/locked it.](#)

- To register a pre-owned Switch in Nebula, use the Nebula Mobile app to scan the Nebula QR code on the back label of the Switch.
- To register a pre-owned Switch in Nebula locked by the previous owner, inform the previous owner to remove the Switch from the Nebula organization or contact Zyxel technical support.

[I no longer want to use Nebula to manage the Switch, what should I do?](#)

- Remove the Switch from the Nebula organization first. See [From Nebula-managed to Standalone on page 34](#) for details. The Switch will reboot and restore its factory-default settings.
- Make sure the **CLOUD** LED is off or blinking green. See [LEDs on page 54](#) for more information on LED behavior. This means the Switch is operating in standalone mode. Nebula Control Center Discovery is disabled in **SYSTEM > Cloud Management > Nebula Control Center Discovery** in the Web Configurator.

APPENDIX A

Customer Support

In the event of problems that cannot be solved by using this manual, you should contact your vendor. If you cannot contact your vendor, then contact a Zyxel office for the region in which you bought the device.

For Zyxel Communications offices, see <https://service-provider.zyxel.com/global/en/contact-us> for the latest information.

For Zyxel Networks offices, see <https://www.zyxel.com/index.shtml> for the latest information.

Please have the following information ready when you contact an office.

Required Information

- Product model and serial number.
- Warranty Information.
- Date that you received your device.
- Brief description of the problem and the steps you took to solve it.

Corporate Headquarters (Worldwide)

Taiwan

- Zyxel Communications (Taiwan) Co., Ltd.
- <https://www.zyxel.com>

Asia

China

- Zyxel Communications Corporation–China Office
- <https://www.zyxel.com/cn/sc>

India

- Zyxel Communications Corporation–India Office
- <https://www.zyxel.com/in/en-in>

Kazakhstan

- Zyxel Kazakhstan
- <https://www.zyxel.com/ru/ru>

Korea

- Zyxel Korea Co., Ltd.
- <http://www.zyxel.kr/>

Malaysia

- Zyxel Communications Corp.
- <https://www.zyxel.com/global/en>

Philippines

- Zyxel Communications Corp.
- <https://www.zyxel.com/global/en>

Singapore

- Zyxel Communications Corp.
- <https://www.zyxel.com/global/en>

Taiwan

- Zyxel Communications (Taiwan) Co., Ltd.
- <https://www.zyxel.com/tw/zh>

Thailand

- Zyxel Thailand Co., Ltd.
- <https://www.zyxel.com/th/th>

Vietnam

- Zyxel Communications Corporation–Vietnam Office
- <https://www.zyxel.com/vn/vi>

Europe

Belarus

- Zyxel Communications Corp.
- <https://www.zyxel.com/ru/ru>

Belgium (Netherlands)

- Zyxel Benelux
- <https://www.zyxel.com/nl/nl>
- <https://www.zyxel.com/fr/fr>

Bulgaria

- Zyxel Bulgaria

- <https://www.zyxel.com/bg/bg>

Czech Republic

- Zyxel Communications Czech s.r.o.
- <https://www.zyxel.com/cz/cs>

Denmark

- Zyxel Communications A/S
- <https://www.zyxel.com/dk/da>

Finland

- Zyxel Communications
- <https://www.zyxel.com/fi/fi>

France

- Zyxel France
- <https://www.zyxel.com/fr/fr>

Germany

- Zyxel Deutschland GmbH.
- <https://www.zyxel.com/de/de>

Hungary

- Zyxel Hungary & SEE
- <https://www.zyxel.com/hu/hu>

Italy

- Zyxel Communications Italy S.r.l.
- <https://www.zyxel.com/it/it>

Norway

- Zyxel Communications A/S
- <https://www.zyxel.com/no/no>

Poland

- Zyxel Communications Poland
- <https://www.zyxel.com/pl/pl>

Romania

- Zyxel Romania
- <https://www.zyxel.com/ro/ro>

Russian Federation

- Zyxel Communications Corp.
- <https://www.zyxel.com/ru/ru>

Slovakia

- Zyxel Slovakia
- <https://www.zyxel.com/sk/sk>

Spain

- Zyxel Iberia
- <https://www.zyxel.com/es/es>

Sweden

- Zyxel Communications A/S
- <https://www.zyxel.com/se/sv>

Switzerland

- Studerus AG
- <https://www.zyxel.com/ch/de-ch>
- <https://www.zyxel.com/fr/fr>

Turkey

- Zyxel Turkey A.S.
- <https://www.zyxel.com/tr/tr>

UK

- Zyxel Communications UK Ltd.
- <https://www.zyxel.com/uk/en-gb>

Ukraine

- Zyxel Ukraine
- <https://www.zyxel.com/ua/uk-ua>

South America

Argentina

- Zyxel Communications Corp.
- <https://www.zyxel.com/co/es-co>

Brazil

- Zyxel Communications Brasil Ltda.

- <https://www.zyxel.com/br/pt>

Colombia

- Zyxel Communications Corp.
- <https://www.zyxel.com/co/es-co>

Ecuador

- Zyxel Communications Corp.
- <https://www.zyxel.com/co/es-co>

South America

- Zyxel Communications Corp.
- <https://www.zyxel.com/co/es-co>

Middle East

Israel

- Zyxel Communications Corp.
- <https://il.zyxel.com>

North America

USA

- Zyxel Communications, Inc. – North America Headquarters
- <https://www.zyxel.com/us/en-us>

APPENDIX B

Common Services

The following table lists some commonly-used services and their associated protocols and port numbers. For a comprehensive list of port numbers, ICMP type or code numbers and services, visit the IANA (Internet Assigned Number Authority) web site.

- **Name:** This is a short, descriptive name for the service. You can use this one or create a different one, if you like.
- **Protocol:** This is the type of IP protocol used by the service. If this is **TCP/UDP**, then the service uses the same port number with TCP and UDP. If this is **User-Defined**, the **Port(s)** is the IP protocol number, not the port number.
- **Port(s):** This value depends on the **Protocol**. Please refer to RFC 1700 for further information about port numbers.
 - If the **Protocol** is **TCP, UDP, or TCP/UDP**, this is the IP port number.
 - If the **Protocol** is **USER**, this is the IP protocol number.
- **Description:** This is a brief explanation of the applications that use this service or the situations in which this service is used.

Table 367 Commonly Used Services

NAME	PROTOCOL	PORT(S)	DESCRIPTION
AH (IPSEC_TUNNEL)	User-Defined	51	The IPSEC AH (Authentication Header) tunneling protocol uses this service.
AIM/New-ICQ	TCP	5190	AOL's Internet Messenger service. It is also used as a listening port by ICQ.
AUTH	TCP	113	Authentication protocol used by some servers.
BGP	TCP	179	Border Gateway Protocol.
BOOTP_CLIENT	UDP	68	DHCP Client.
BOOTP_SERVER	UDP	67	DHCP Server.
CU-SEEME	TCP UDP	7648 24032	A popular videoconferencing solution from White Pines Software.
DNS	TCP/UDP	53	Domain Name Server, a service that matches web names (for example www.zyxel.com) to IP numbers.
ESP (IPSEC_TUNNEL)	User-Defined	50	The IPSEC ESP (Encapsulation Security Protocol) tunneling protocol uses this service.
FINGER	TCP	79	Finger is a UNIX or Internet related command that can be used to find out if a user is logged on.
FTP	TCP TCP	20 21	File Transfer Program, a program to enable fast transfer of files, including large files that may not be possible by email.
H.323	TCP	1720	NetMeeting uses this protocol.
HTTP	TCP	80	Hyper Text Transfer Protocol – a client or server protocol for the world wide web.

Table 367 Commonly Used Services (continued)

NAME	PROTOCOL	PORT(S)	DESCRIPTION
HTTPS	TCP	443	HTTPS is a secured http session often used in e-commerce.
ICMP	User-Defined	1	Internet Control Message Protocol is often used for diagnostic or routing purposes.
ICQ	UDP	4000	This is a popular Internet chat program.
IGMP (MULTICAST)	User-Defined	2	Internet Group Multicast Protocol is used when sending packets to a specific group of hosts.
IKE	UDP	500	The Internet Key Exchange algorithm is used for key distribution and management.
IRC	TCP/UDP	6667	This is another popular Internet chat program.
MSN Messenger	TCP	1863	Microsoft Networks' messenger service uses this protocol.
NEW-ICQ	TCP	5190	An Internet chat program.
NEWS	TCP	144	A protocol for news groups.
NFS	UDP	2049	Network File System – NFS is a client or server distributed file service that provides transparent file sharing for network environments.
NNTP	TCP	119	Network News Transport Protocol is the delivery mechanism for the USENET newsgroup service.
PING	User-Defined	1	Packet Internet Groper is a protocol that sends out ICMP echo requests to test whether or not a remote host is reachable.
POP3	TCP	110	Post Office Protocol version 3 lets a client computer get e-mail from a POP3 server through a temporary connection (TCP/IP or other).
PPTP	TCP	1723	Point-to-Point Tunneling Protocol enables secure transfer of data over public networks. This is the control channel.
PPTP_TUNNEL (GRE)	User-Defined	47	PPTP (Point-to-Point Tunneling Protocol) enables secure transfer of data over public networks. This is the data channel.
RCMD	TCP	512	Remote Command Service.
REAL_AUDIO	TCP	7070	A streaming audio service that enables real time sound over the web.
REXEC	TCP	514	Remote Execution Daemon.
RLOGIN	TCP	513	Remote Login.
RTELNET	TCP	107	Remote Telnet.
RTSP	TCP/UDP	554	The Real Time Streaming (media control) Protocol (RTSP) is a remote control for multimedia on the Internet.
SFTP	TCP	115	Simple File Transfer Protocol.
SMTP	TCP	25	Simple Mail Transfer Protocol is the message-exchange standard for the Internet. SMTP enables you to move messages from one email server to another.
SNMP	TCP/UDP	161	Simple Network Management Program.
SNMP-TRAPS	TCP/UDP	162	Traps for use with the SNMP (RFC:1215).

Table 367 Commonly Used Services (continued)

NAME	PROTOCOL	PORT(S)	DESCRIPTION
SQL-NET	TCP	1521	Structured Query Language is an interface to access data on many different types of database systems, including mainframes, midrange systems, UNIX systems and network servers.
SSH	TCP/UDP	22	Secure Shell Remote Login Program.
STRM WORKS	UDP	1558	Stream Works Protocol.
SYSLOG	UDP	514	Syslog allows you to send system logs to a UNIX server.
TACACS	UDP	49	Login Host Protocol used for (Terminal Access Controller Access Control System).
TELNET	TCP	23	Telnet is the login and terminal emulation protocol common on the Internet and in UNIX environments. It operates over TCP/IP networks. Its primary function is to allow users to log into remote host systems.
TFTP	UDP	69	Trivial File Transfer Protocol is an Internet file transfer protocol similar to FTP, but uses the UDP (User Datagram Protocol) rather than TCP (Transmission Control Protocol).
VDOLIVE	TCP	7000	Another videoconferencing solution.

APPENDIX C

IPv6

Overview

IPv6 (Internet Protocol version 6), is designed to enhance IP address size and features. The increase in IPv6 address size to 128 bits (from the 32-bit IPv4 address) allows up to 3.4×10^{38} IP addresses.

IPv6 Addressing

The 128-bit IPv6 address is written as eight 16-bit hexadecimal blocks separated by colons (:). This is an example IPv6 address `2001:0db8:1a2b:0015:0000:0000:1a2f:0000`.

IPv6 addresses can be abbreviated in two ways:

- Leading zeros in a block can be omitted. So `2001:0db8:1a2b:0015:0000:0000:1a2f:0000` can be written as `2001:db8:1a2b:15:0:0:1a2f:0`.
- Any number of consecutive blocks of zeros can be replaced by a double colon. A double colon can only appear once in an IPv6 address. So `2001:0db8:0000:0000:1a2f:0000:0000:0015` can be written as `2001:0db8::1a2f:0000:0000:0015`, `2001:0db8:0000:0000:1a2f::0015`, `2001:db8::1a2f:0:0:15` or `2001:db8:0:0:1a2f::15`.

Prefix and Prefix Length

Similar to an IPv4 subnet mask, IPv6 uses an address prefix to represent the network address. An IPv6 prefix length specifies how many most significant bits (start from the left) in the address compose the network address. The prefix length is written as “/x” where x is a number. For example,

`2001:db8:1a2b:15::1a2f:0/32`

means that the first 32 bits (`2001:db8`) is the subnet prefix.

Link-local Address

A link-local address uniquely identifies a device on the local network (the LAN). It is similar to a “private IP address” in IPv4. You can have the same link-local address on multiple interfaces on a device. A link-local unicast address has a predefined prefix of `fe80::/10`. The link-local unicast address format is as follows.

Table 368 Link-local Unicast Address Format

1111 1110 10	0	Interface ID
10 bits	54 bits	64 bits

Global Address

A global address uniquely identifies a device on the Internet. It is similar to a “public IP address” in IPv4. A global unicast address starts with a 2 or 3.

Unspecified Address

An unspecified address (0:0:0:0:0:0 or ::) is used as the source address when a device does not have its own address. It is similar to "0.0.0.0" in IPv4.

Loopback Address

A loopback address (0:0:0:0:0:1 or ::1) allows a host to send packets to itself. It is similar to "127.0.0.1" in IPv4.

Multicast Address

In IPv6, multicast addresses provide the same functionality as IPv4 broadcast addresses. Broadcasting is not supported in IPv6. A multicast address allows a host to send packets to all hosts in a multicast group.

Multicast scope allows you to determine the size of the multicast group. A multicast address has a predefined prefix of ff00::/8. The following table describes some of the predefined multicast addresses.

Table 369 Predefined Multicast Address

MULTICAST ADDRESS	DESCRIPTION
FF01:0:0:0:0:0:0:1	All hosts on a local node.
FF01:0:0:0:0:0:0:2	All routers on a local node.
FF02:0:0:0:0:0:0:1	All hosts on a local connected link.
FF02:0:0:0:0:0:0:2	All routers on a local connected link.
FF05:0:0:0:0:0:0:2	All routers on a local site.
FF05:0:0:0:0:0:1:3	All DHCP servers on a local site.

The following table describes the multicast addresses which are reserved and cannot be assigned to a multicast group.

Table 370 Reserved Multicast Address

MULTICAST ADDRESS
FF00:0:0:0:0:0:0:0
FF01:0:0:0:0:0:0:0
FF02:0:0:0:0:0:0:0
FF03:0:0:0:0:0:0:0
FF04:0:0:0:0:0:0:0
FF05:0:0:0:0:0:0:0
FF06:0:0:0:0:0:0:0
FF07:0:0:0:0:0:0:0
FF08:0:0:0:0:0:0:0
FF09:0:0:0:0:0:0:0
FF0A:0:0:0:0:0:0:0
FF0B:0:0:0:0:0:0:0
FF0C:0:0:0:0:0:0:0
FF0D:0:0:0:0:0:0:0
FF0E:0:0:0:0:0:0:0
FF0F:0:0:0:0:0:0:0

Subnet Masking

Both an IPv6 address and IPv6 subnet mask compose of 128-bit binary digits, which are divided into eight 16-bit blocks and written in hexadecimal notation. Hexadecimal uses 4 bits for each character (1 – 10, A – F). Each block's 16 bits are then represented by 4 hexadecimal characters. For example, FFFF:FFFF:FFFF:FFFF:FC00:0000:0000:0000.

Interface ID

In IPv6, an interface ID is a 64-bit identifier. It identifies a physical interface (for example, an Ethernet port) or a virtual interface (for example, the management IP address for a VLAN). One interface should have a unique interface ID.

EUI-64

The EUI-64 (Extended Unique Identifier) defined by the IEEE (Institute of Electrical and Electronics Engineers) is an interface ID format designed to adapt with IPv6. It is derived from the 48-bit (6-byte) Ethernet MAC address as shown next. EUI-64 inserts the hex digits fffe between the third and fourth bytes of the MAC address and complements the seventh bit of the first byte of the MAC address. See the following example.

Table 371

MAC	00	:	13	:	49	:	12	:	34	:	56
------------	----	---	----	---	----	---	----	---	----	---	----

Table 372

EUI-64	02	:	13	:	49	:	FF	:	FE	:	12	:	34	:	56
---------------	----	---	----	---	----	---	----	---	----	---	----	---	----	---	----

DHCPv6

The Dynamic Host Configuration Protocol for IPv6 (DHCPv6, RFC 3315) is a server-client protocol that allows a DHCP server to assign and pass IPv6 network addresses, prefixes and other configuration information to DHCP clients. DHCPv6 servers and clients exchange DHCP messages using UDP.

Each DHCP client and server has a unique DHCP Unique Identifier (DUID), which is used for identification when they are exchanging DHCPv6 messages. The DUID is generated from the MAC address, time, vendor assigned ID and/or the vendor's private enterprise number registered with the IANA. It should not change over time even after you reboot the device.

Identity Association

An Identity Association (IA) is a collection of addresses assigned to a DHCP client, through which the server and client can manage a set of related IP addresses. Each IA must be associated with exactly one interface. The DHCP client uses the IA assigned to an interface to obtain configuration from a DHCP server for that interface. Each IA consists of a unique IAID and associated IP information.

The IA type is the type of address in the IA. Each IA holds one type of address. IA_NA means an identity association for non-temporary addresses and IA_TA is an identity association for temporary addresses.

An IA_NA option contains the T1 and T2 fields, but an IA_TA option does not. The DHCPv6 server uses T1 and T2 to control the time at which the client contacts with the server to extend the lifetimes on any addresses in the IA_NA before the lifetimes expire. After T1, the client sends the server (**S1**) (from which the addresses in the IA_NA were obtained) a Renew message. If the time T2 is reached and the server does not respond, the client sends a Rebind message to any available server (**S2**). For an IA_TA, the

client may send a Renew or Rebind message at the client's discretion.

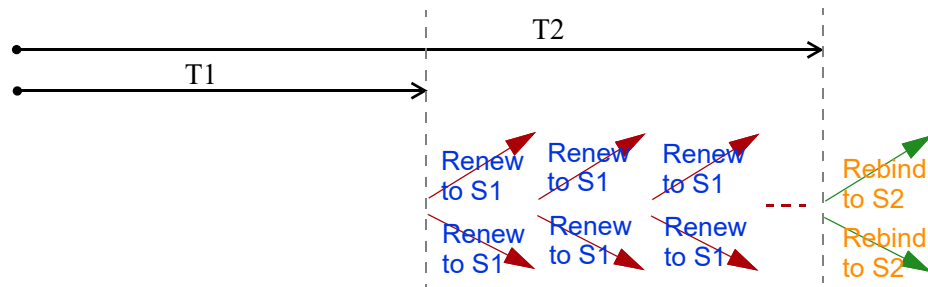

DHCP Relay Agent

A DHCP relay agent is on the same network as the DHCP clients and helps forward messages between the DHCP server and clients. When a client cannot use its link-local address and a well-known multicast address to locate a DHCP server on its network, it then needs a DHCP relay agent to send a message to a DHCP server that is not attached to the same network.

The DHCP relay agent can add the remote identification (remote-ID) option and the interface-ID option to the Relay-Forward DHCPv6 messages. The remote-ID option carries a user-defined string, such as the system name. The interface-ID option provides slot number, port information and the VLAN ID to the DHCPv6 server. The remote-ID option (if any) is stripped from the Relay-Reply messages before the relay agent sends the packets to the clients. The DHCP server copies the interface-ID option from the Relay-Forward message into the Relay-Reply message and sends it to the relay agent. The interface-ID should not change even after the relay agent restarts.

Prefix Delegation

Prefix delegation enables an IPv6 router to use the IPv6 prefix (network address) received from the ISP (or a connected uplink router) for its LAN. The Switch uses the received IPv6 prefix (for example, 2001:db2::/48) to generate its LAN IP address. Through sending Router Advertisements (RAs) regularly by multicast, the Switch passes the IPv6 prefix information to its LAN hosts. The hosts then can use the prefix to generate their IPv6 addresses.

ICMPv6

Internet Control Message Protocol for IPv6 (ICMPv6 or ICMP for IPv6) is defined in RFC 4443. ICMPv6 has a preceding Next Header value of 58, which is different from the value used to identify ICMP for IPv4. ICMPv6 is an integral part of IPv6. IPv6 nodes use ICMPv6 to report errors encountered in packet processing and perform other diagnostic functions, such as "ping".

Neighbor Discovery Protocol (NDP)

The Neighbor Discovery Protocol (NDP) is a protocol used to discover other IPv6 devices and track neighbor's reachability in a network. An IPv6 device uses the following ICMPv6 messages types:

- Neighbor solicitation: A request from a host to determine a neighbor's link-layer address (MAC address) and detect if the neighbor is still reachable. A neighbor being "reachable" means it responds to a neighbor solicitation message (from the host) with a neighbor advertisement message.
- Neighbor advertisement: A response from a node to announce its link-layer address.
- Router solicitation: A request from a host to locate a router that can act as the default router and

forward packets.

- Router advertisement: A response to a router solicitation or a periodical multicast advertisement from a router to advertise its presence and other parameters.

IPv6 Cache

An IPv6 host is required to have a neighbor cache, destination cache, prefix list and default router list. The Switch maintains and updates its IPv6 caches constantly using the information from response messages. In IPv6, the Switch configures a link-local address automatically, and then sends a neighbor solicitation message to check if the address is unique. If there is an address to be resolved or verified, the Switch also sends out a neighbor solicitation message. When the Switch receives a neighbor advertisement in response, it stores the neighbor's link-layer address in the neighbor cache. When the Switch uses a router solicitation message to query for a router and receives a router advertisement message, it adds the router's information to the neighbor cache, prefix list and destination cache. The Switch creates an entry in the default router list cache if the router can be used as a default router.

When the Switch needs to send a packet, it first consults the destination cache to determine the next hop. If there is no matching entry in the destination cache, the Switch uses the prefix list to determine whether the destination address is on-link and can be reached directly without passing through a router. If the address is onlink, the address is considered as the next hop. Otherwise, the Switch determines the next-hop from the default router list or routing table. Once the next hop IP address is known, the Switch looks into the neighbor cache to get the link-layer address and sends the packet when the neighbor is reachable. If the Switch cannot find an entry in the neighbor cache or the state for the neighbor is not reachable, it starts the address resolution process. This helps reduce the number of IPv6 solicitation and advertisement messages.

Multicast Listener Discovery

The Multicast Listener Discovery (MLD) protocol (defined in RFC 2710) is derived from IPv4's Internet Group Management Protocol version 2 (IGMPv2). MLD uses ICMPv6 message types, rather than IGMP message types. MLDv1 is equivalent to IGMPv2 and MLDv2 is equivalent to IGMPv3.

MLD allows an IPv6 switch or router to discover the presence of MLD listeners who wish to receive multicast packets and the IP addresses of multicast groups the hosts want to join on its network.

MLD snooping and MLD proxy are analogous to IGMP snooping and IGMP proxy in IPv4.

MLD filtering controls which multicast groups a port can join.

MLD Messages

A multicast router or switch periodically sends general queries to MLD hosts to update the multicast forwarding table. When an MLD host wants to join a multicast group, it sends an MLD Report message for that address.

An MLD Done message is equivalent to an IGMP Leave message. When an MLD host wants to leave a multicast group, it can send a Done message to the router or switch. The router or switch then sends a group-specific query to the port on which the Done message is received to determine if other devices connected to this port should remain in the group.

Example – Enabling IPv6 on Windows 7

Windows 7 supports IPv6 by default. DHCPv6 is also enabled when you enable IPv6 on a Windows 7 computer.

To enable IPv6 in Windows 7:

- 1 Select **Control Panel > Network and Sharing Center > Local Area Connection**.
- 2 Select the **Internet Protocol Version 6 (TCP/IPv6)** check box to enable it.
- 3 Click **OK** to save the change.

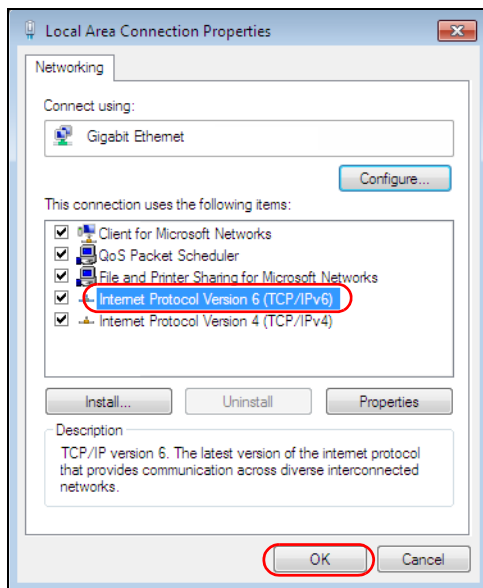

- 4 Click **Close** to exit the **Local Area Connection Status** screen.
- 5 Select **Start > All Programs > Accessories > Command Prompt**.
- 6 Use the `ipconfig` command to check your dynamic IPv6 address. This example shows a global address (2001:b021:2d::1000) obtained from a DHCP server.

```
C:\>ipconfig

Windows IP Configuration

Ethernet adapter Local Area Connection:

    Connection-specific DNS Suffix  . :
    IPv6 Address. . . . . : 2001:b021:2d::1000
    Link-local IPv6 Address . . . . . : fe80::25d8:dcab:c80a:5189%11
    IPv4 Address. . . . . : 172.16.100.61
    Subnet Mask . . . . . : 255.255.255.0
    Default Gateway . . . . . : fe80::213:49ff:feaa:7125%11
                                172.16.100.254
```

Example – Enabling IPv6 on Windows 10

Windows 10 supports IPv6 by default. DHCPv6 is enabled when you enable IPv6 on a Windows 10 PC.

To enable IPv6 in Windows 10:

- 1 Select **Control Panel > Network and Sharing Center**.
- 2 On the left side of the **Network and Sharing Center**, select **Change adapter settings**.
- 3 Right-click your network connection and select **Properties**.
- 4 Select the **Internet Protocol Version 6 (TCP/IPv6)** check box to enable it.
- 5 Click **OK** to save the changes for the selected network adapter.

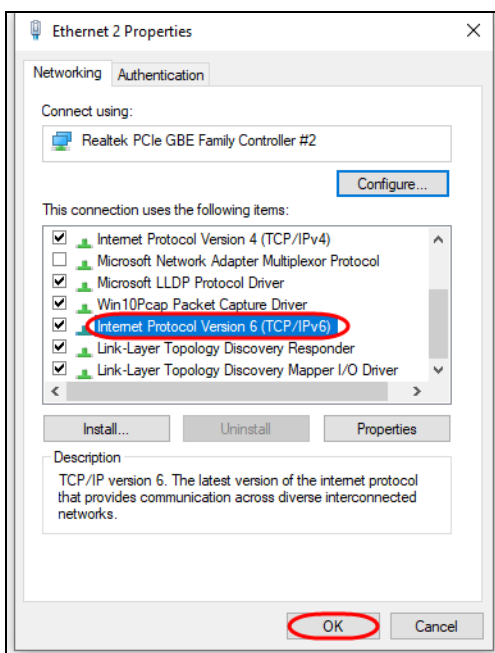

- 6 Click **OK** to exit the selected network adapter **Properties** screen.

Example – Enabling DHCPv6 on Windows 10

Windows 10 supports DHCPv6 by default. To enable DHCPv6 client on your computer:

- 1 Select **Start > Settings > Network & Internet**.
- 2 On the left side of the **Network & Internet**, select **Ethernet**. Then select the Ethernet network you are connected to.
- 3 Under **IP assignment**, select **Edit**.
- 4 Under **Edit IP settings**, select **Automatic (DHCP)** or **Manual**. Then click **Save**.

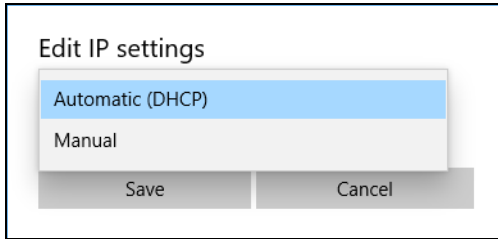

- When you select **Automatic (DHCP)**, the IP address settings and DNS server address setting are set automatically by your router.
- When you select **Manual**, you can manually set your IP address settings and DNS server address.

Now your computer can obtain an IPv6 address from a DHCPv6 server.

APPENDIX D

Legal Information

Copyright

Copyright © 2023 by Zyxel and/or its affiliates.

The contents of this publication may not be reproduced in any part or as a whole, transcribed, stored in a retrieval system, translated into any language, or transmitted in any form or by any means, electronic, mechanical, magnetic, optical, chemical, photocopying, manual, or otherwise, without the prior written permission of Zyxel and/or its affiliates.

Published by Zyxel and/or its affiliates. All rights reserved.

Disclaimer

Zyxel does not assume any liability arising out of the application or use of any products, or software described herein. Neither does it convey any license under its patent rights nor the patent rights of others. Zyxel further reserves the right to make changes in any products described herein without notice. This publication is subject to change without notice.

Regulatory Notice and Statement

United States of America



The following information applies if you use the product within USA area.

US Importer: Zyxel Communications, Inc, 1130 North Miller Street Anaheim, CA92806-2001, <https://www.zyxel.com/us/en/>

Federal Communications Commission (FCC) EMC Statement

- This device complies with Part 15 of FCC rules. Operation is subject to the following two conditions:
 - (1) This device may not cause harmful interference.
 - (2) This device must accept any interference received, including interference that may cause undesired operations.
- Changes or modifications not expressly approved by the party responsible for compliance could void the user's authority to operate the equipment.
- This equipment has been tested and found to comply with the limits for a Class A digital device, pursuant to part 15 of the FCC Rules. These limits are designed to provide reasonable protection against harmful interference when the equipment is operated in a commercial environment. This equipment generates, uses, and can radiate radio frequency energy and, if not installed and used in accordance with the instruction manual, may cause harmful interference to radio communications. Operation of this equipment in a residential area is likely to cause harmful interference in which case the user will be required to correct the interference at his own expense.

Canada

The following information applies if you use the product within Canada area.

Innovation, Science and Economic Development Canada ICES statement

CAN ICES-3 (A)/NMB-3(A)

European Union and United Kingdom



The following information applies if you use the product within the European Union and United Kingdom.

EMC statement

WARNING: This equipment is compliant with Class A of EN55032. In a residential environment this equipment may cause radio interference.

List of National Codes

COUNTRY	ISO 3166 2 LETTER CODE	COUNTRY	ISO 3166 2 LETTER CODE
Austria	AT	Liechtenstein	LI
Belgium	BE	Lithuania	LT
Bulgaria	BG	Luxembourg	LU
Croatia	HR	Malta	MT
Cyprus	CY	Netherlands	NL
Czech Republic	CR	Norway	NO
Denmark	DK	Poland	PL
Estonia	EE	Portugal	PT
Finland	FI	Romania	RO
France	FR	Serbia	RS
Germany	DE	Slovakia	SK
Greece	GR	Slovenia	SI
Hungary	HU	Spain	ES
Iceland	IS	Sweden	SE
Ireland	IE	Switzerland	CH
Italy	IT	Turkey	TR
Latvia	LV	United Kingdom	GB

Safety Warnings

- To avoid possible eye injury, do NOT look into an operating fiber-optic module's connector.
- Do NOT use this device near water, for example, in a wet basement or near a swimming pool.
- Do NOT expose your device to dampness, dust or corrosive liquids.
- Do NOT store things on the device.
- Do NOT obstruct the device ventilation slots as insufficient airflow may harm your device. For example, do not place the device in an enclosed space such as a box or on a very soft surface such as a bed or sofa.
- Do NOT install or service this device during a thunderstorm. There is a remote risk of electric shock from lightning.
- Connect ONLY suitable accessories to the device.
- Do NOT open the device or unit. Opening or removing covers can expose you to dangerous high voltage points or other risks. Only qualified service personnel should service or disassemble this device. Please contact your vendor for further information.
- Make sure to connect the cables to the correct ports.
- Place connecting cables carefully so that no one will step on them or stumble over them.
- Always disconnect all cables from this device before servicing or disassembling.
- Do NOT remove the plug and connect it to a power outlet by itself; always attach the plug to the power adaptor first before connecting it to a power outlet.
- Do NOT allow anything to rest on the power adaptor or cord and do NOT place the device where anyone can walk on the power adaptor or cord.
- Please use the provided or designated connection cables/power cables/adaptors. Connect it to the right supply voltage (for example, 120V AC in North America or 230V AC in Europe). If the power adaptor or cord is damaged, it might cause electrocution. Remove it from the device and the power source, repairing the power adapter or cord is prohibited. Contact your local vendor to order a new one.
- Do NOT use the device outside, and make sure all the connections are indoors. There is a remote risk of electric shock from lightning.
- CAUTION: RISK OF EXPLOSION IF BATTERY IS REPLACED BY AN INCORRECT TYPE, DISPOSE OF USED BATTERIES ACCORDING TO THE INSTRUCTION. Dispose them at the applicable collection point for the recycling of electrical and electronic device. For detailed information about recycling of this device, please contact your local city office, your household waste disposal service or the store where you purchased the device.
- Use ONLY power wires of the appropriate wire gauge for your device. Connect it to a power supply of the correct voltage.
- Fuse Warning! Replace a fuse only with a fuse of the same type and rating.
- The POE (Power over Ethernet) devices that supply or receive power and their connected Ethernet cables must all be completely indoors.
- The following warning statements apply, where the disconnect device is not incorporated in the device or where the plug on the power supply cord is intended to serve as the disconnect device.
 - For PERMANENTLY CONNECTED DEVICES, a readily accessible disconnect device shall be incorporated external to the device;
 - For PLUGGABLE DEVICES, the socket-outlet shall be installed near the device and shall be easily accessible.
- This device must be grounded by qualified service personnel. Never defeat the ground conductor or operate the device in the absence of a suitably installed ground conductor. Contact the appropriate electrical inspection authority or an electrician if you are uncertain that suitable grounding is available.
- If your device has an earthing screw (frame ground), connect the screw to a ground terminal using an appropriate AWG ground wire. Do this before you make other connections.
- If your device has no earthing screw, but has a 3-prong power plug, make sure to connect the plug to a 3-hole earthed socket.
- When connecting or disconnecting power to hot-pluggable power supplies, if offered with your system, observe the following guidelines:
 - Install the power supply before connecting the power cable to the power supply.
 - Unplug the power cable before removing the power supply.
 - If the system has multiple sources of power, disconnect power from the system by unplugging all power cables from the power supply.
- Do not put the device in a place that is humid, dusty or has extreme temperatures as these conditions may harm your device.
- Please refer to the device back label, datasheet, box specifications or catalog information for the power rating of the device and operating temperature.

- CLASS 1 LASER PRODUCT
- APPAREIL À LASER DE CLASS 1

- PRODUCT COMPLIES WITH 21 CFR 1040.10 AND 1040.11.
- PRODUIT CONFORME SELON 21 CFR 1040.10 ET 1040.11.

Important Safety Instructions

1 Warning! Energy Hazard. Remove all metal jewelry, watches, and so on from your hands and wrists before serving the Switch.

2 Caution! The RJ-45 jacks are not used for telephone line connection.

3  Hazardous Moving Parts. Keep body parts away from fan blades.

4  Hot Surface. Do not touch.

1 Avertissement: Risque de choc électrique. Retirer tout bijoux en métal et votre montre de vos mains et poignets avant de manipuler cet appareil.

2 Attention: Les câbles RJ-45 ne doivent pas être utilisés pour les connections téléphoniques.

3  Mobilité des pièces détachées. S'assurer que les pièces détachées ne sont pas en contact avec les pales du ventilateur.

4  Surface brûlante. Ne pas toucher.

Environment Statement

Disposal and Recycling Information

The symbol below means that according to local regulations your product and/or its battery shall be disposed of separately from domestic waste. If this product is end of life, take it to a recycling station designated by local authorities. At the time of disposal, the separate collection of your product and/or its battery will help save natural resources and ensure that the environment is sustainable development.

Die folgende Symbol bedeutet, dass Ihr Produkt und/oder seine Batterie gemäß den örtlichen Bestimmungen getrennt vom Hausmüll entsorgt werden muss. Wenden Sie sich an eine Recyclingstation, wenn dieses Produkt das Ende seiner Lebensdauer erreicht hat. Zum Zeitpunkt der Entsorgung wird die getrennte Sammlung von Produkt und/oder seiner Batterie dazu beitragen, natürliche Ressourcen zu sparen und die Umwelt und die menschliche Gesundheit zu schützen.

El símbolo de abajo indica que según las regulaciones locales, su producto y/o su batería deberán depositarse como basura separada de la doméstica. Cuando este producto alcance el final de su vida útil, llévelo a un punto limpio. Cuando llegue el momento de desechar el producto, la recogida por separado éste y/o su batería ayudará a salvar los recursos naturales y a proteger la salud humana y medioambiental.

Le symbole ci-dessous signifie que selon les réglementations locales votre produit et/ou sa batterie doivent être éliminés séparément des ordures ménagères. Lorsque ce produit atteint sa fin de vie, amenez-le à un centre de recyclage. Au moment de la mise au rebut, la collecte séparée de votre produit et/ou de sa batterie aidera à économiser les ressources naturelles et protéger l'environnement et la santé humaine.

Il simbolo sotto significa che secondo i regolamenti locali il vostro prodotto e/o batteria deve essere smaltito separatamente dai rifiuti domestici. Quando questo prodotto raggiunge la fine della vita di servizio portarlo a una stazione di riciclaggio. Al momento dello smaltimento, la raccolta separata del vostro prodotto e/o della sua batteria aiuta a risparmiare risorse naturali e a proteggere l'ambiente e la salute umana.

Symbolen innebär att enligt lokal lagstiftning ska produkten och/eller dess batteri kastas separat från hushållsavfallet. När den här produkten når slutet av sin livslängd ska du ta den till en återvinningsstation. Vid tiden för kasseringen bidrar du till en bättre miljö och mänsklig hälsa genom att göra dig av med den på ett återvinningsställe.

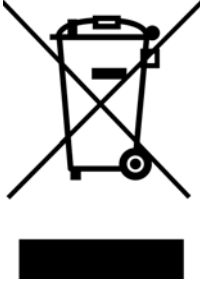

台灣

以下訊息僅適用於產品銷售至台灣地區

- 這是甲類的資訊產品，在居住的環境中使用時，可能會造成射頻干擾，在這種情況下，使用者會被要求採取某些適當的對策。
- 為避免電磁干擾，本產品不應安裝或使用於住宅環境。



安全警告 – 為了您的安全，請先閱讀以下警告及指示：

- 請勿將此產品接近水、火焰或放置在高溫的環境。
- 避免設備接觸
 - 任何液體 - 切勿讓設備接觸水、雨水、高濕度、污水腐蝕性的液體或其他水份。
 - 灰塵及污物 - 切勿接觸灰塵、污物、沙土、食物或其他不合適的材料。
- 雷雨天氣時，不要安裝或維修此設備。有遭受電擊的風險。
- 切勿重摔或撞擊設備，並勿使用不正確的電源變壓器。
- 若接上不正確的電源變壓器會有爆炸的風險。
- 請勿隨意更換產品內的電池。
- 如果更換不正確之電池型式，會有爆炸的風險，請依製造商說明書處理使用過之電池。
- 請將廢電池丟棄在適當的電器或電子設備回收處。
- 請勿將設備解體。
- 請勿阻礙設備的散熱孔，空氣對流不足將會造成設備損害。
- 請使用隨貨提供或指定的連接線 / 電源線 / 電源變壓器，將其連接到合適的供應電壓 (如：台灣供應電壓 110 伏特)。
- 假若電源變壓器或電源變壓器的纜線損壞，請從插座拔除，若您還繼續插電使用，會有觸電死亡的風險。
- 請勿試圖修理電源變壓器或電源變壓器的纜線，若有毀損，請直接聯絡您購買的店家，購買一個新的電源變壓器。
- 請勿將此設備安裝於室外，此設備僅適合放置於室內。
- 請勿隨一般垃圾丟棄。
- 請參閱產品背貼上的設備額定功率。
- 請參考產品型錄或是彩盒上的作業溫度。
- 設備必須接地，接地導線不允許被破壞或沒有適當安裝接地導線，如果不確定接地方式是否符合要求可聯繫相應的電氣檢驗機構檢驗。
- 如果您提供的系統中有提供熱插拔電源，連接或斷開電源請遵循以下指導原則：
 - 先連接電源線至設備連，再連接電源。
 - 先斷開電源再拔除連接至設備的電源線。
 - 如果系統有多個電源，需拔除所有連接至電源的電源線再關閉設備電源。
- 產品沒有斷電裝置或者採用電源線的插頭視為斷電裝置的一部分，以下警語將適用：
 - 對永久連接之設備，在設備外部須安裝可觸及之斷電裝置；
 - 對插接式之設備，插座必須接近安裝之地點而且是易於觸及的。

About the Symbols

Various symbols are used in this product to ensure correct usage, to prevent danger to the user and others, and to prevent property damage. The meaning of these symbols are described below. It is important that you read these descriptions thoroughly and fully understand the contents.

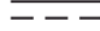
Explanation of the Symbols

SYMBOL	EXPLANATION
	Alternating current (AC): AC is an electric current in which the flow of electric charge periodically reverses direction.
	Direct current (DC): DC is the unidirectional flow or movement of electric charge carriers.
	Earth; ground: A wiring terminal intended for connection of a Protective Earthing Conductor.
	Class II equipment: The method of protection against electric shock in the case of class II equipment is either double insulation or reinforced insulation.

Viewing Certifications

Go to <http://www.zyxel.com> to view this product's documentation and certifications.

Zyxel Limited Warranty

Zyxel warrants to the original end user (purchaser) that this product is free from any defects in material or workmanship for a specific period (the Warranty Period) from the date of purchase. The Warranty Period varies by region. Check with your vendor and/or the authorized Zyxel local distributor for details about the Warranty Period of this product. During the warranty period, and upon proof of purchase, should the product have indications of failure due to faulty workmanship and/or materials, Zyxel will, at its discretion, repair or replace the defective products or components without charge for either parts or labor, and to whatever extent it shall deem necessary to restore the product or components to proper operating condition. Any replacement will consist of a new or re-manufactured functionally equivalent product of equal or higher value, and will be solely at the discretion of Zyxel. This warranty shall not apply if the product has been modified, misused, tampered with, damaged by an act of God, or subjected to abnormal working conditions.

Note

Repair or replacement, as provided under this warranty, is the exclusive remedy of the purchaser. This warranty is in lieu of all other warranties, express or implied, including any implied warranty of merchantability or fitness for a particular use or purpose. Zyxel shall in no event be held liable for indirect or consequential damages of any kind to the purchaser.

To obtain the services of this warranty, contact your vendor. You may also refer to the warranty policy for the region in which you bought the device at <https://www.zyxel.com/global/en/support/warranty-information>.

Registration

Register your product online at www.zyxel.com to receive email notices of firmware upgrades and related information.

Trademarks

The trademarks mentioned in this publication are used for identification purposes only and may be properties of their respective owners.

Numbers

- 10 Gigabit port
 - requirement for maximum performance [29](#)
- 10G port [29](#)
- 802.1P priority [293, 659](#)

A

- AAA [485](#)
 - accounting [485](#)
 - authentication [485](#)
 - authorization [485](#)
- AAA (Authentication, Authorization and Accounting) [485](#)
- access control
 - account security [501](#)
 - limitations [499, 679](#)
 - login account [190, 639](#)
 - overview [499, 678](#)
 - remote management [500, 680](#)
 - service port [499, 679](#)
 - SNMP [198](#)
- account security [501](#)
- Account Security screen [502](#)
- accounting
 - setup [490](#)
- Address Resolution Protocol (ARP) [124, 460, 617, 618](#)
- admin [502](#)
- administrator password [62, 191, 640](#)
- age [402](#)
- aging time [213](#)
- air circulation
 - for cooling [41](#)
- All connected
 - Setting Wizard [440](#)
- anti-arpscan [524](#)
 - blocked hosts [526](#)
 - host threshold [527](#)
 - status [525](#)
- trusted hosts [529](#)
- applications
 - backbone [36](#)
 - bridging [37](#)
 - fiber uplink [37](#)
 - IEEE 802.1Q VLAN [38](#)
 - PoE [36](#)
 - switched workgroup [37](#)
- ARP
 - how it works [460](#)
 - learning mode [460](#)
 - overview [460](#)
- ARP (Address Resolution Protocol) [124](#)
- ARP inspection [546, 581](#)
 - and MAC filter [582](#)
 - configuring [583](#)
 - syslog messages [582](#)
 - trusted ports [582](#)
- ARP Learning screen [462](#)
- ARP scan [524](#)
- ARP Setup screen [462](#)
- ARP Table screen [124](#)
- ARP-Reply [461](#)
- ARP-Request [462](#)
- authentication
 - setup [490](#)
- authentication, authorization and accounting [485](#)
- authorization
 - privilege levels [493](#)
 - setup [490](#)
- authorized technician
 - install the Switch [41](#)
- auto PD recovery [221](#)
 - enable [221](#)
 - restart [221](#)
 - use LLDP or ping [221](#)
- auto-crossover port [47](#)
- automatic PD recovery
 - create [223](#)
- automatic VLAN registration [416, 672](#)
- auto-MDIX port [47](#)

B

- back up
 - configuration file [613, 683](#)
- bandwidth control [371, 373](#)
 - egress rate [373](#)
 - ingress rate [373](#)
 - setup [371](#)
- Bandwidth Control screen [371](#)
- basic setup tutorial [106](#)
- binding table [546](#)
 - build [551](#)
 - building [546](#)
- BPDU (Bridge Protocol Data Units) [531](#)
- BPDU guard [531](#)
 - and Errdisable Recovery [531](#)
 - port status [531](#)
- BPDU s [379](#)
- Bridge Protocol Data Units [531](#)
- Bridge Protocol Data Units (BPDUs) [379](#)
- bridging application [37](#)
- broadcast storm control [535](#)
 - Wizard [83](#)

C

- cable type
 - bandwidth capacity [30](#)
 - distance limitation [30](#)
 - transmission speed [30](#)
- cables
 - supported [36](#)
- Cat 5 cable [29](#)
- Cat 5e cable [29](#)
- Cat 6 cable [29](#)
- Cat 6a cable [29](#)
- CDP [304](#)
- Certificates screen [604](#)
- certifications
 - viewing [714](#)
- CFI (Canonical Format Indicator) [416, 671](#)
- changing the password [97](#)
- Cisco Discovery Protocol, see CDP
- CIST [408](#)

- Class of Service [360](#)
- classifier [509](#)
 - and QoS [509](#)
 - example [516](#)
 - logging [515](#)
 - match order [515](#)
 - overview [509](#)
 - setup [510, 512](#)
 - status [510](#)
- clearance
 - Switch installation [41](#)
- cloning a port, see port cloning
- Cloud Connection Status [120](#)
- cluster management [608](#)
 - and switch passwords [611](#)
 - cluster manager [608, 610](#)
 - cluster member [608](#)
 - cluster member firmware upgrade [612](#)
 - network example [608](#)
 - setup [609](#)
 - specification [608](#)
 - status [608](#)
 - switch models [608](#)
 - VID [610](#)
 - Web Configurator [611](#)
- Cluster Management Configuration screen [609](#)
- cluster manager [608](#)
- Common and Internal Spanning Tree, see CIST [408](#)
- Config 1 [626](#)
- Config 2 [626](#)
- configuration [480](#)
 - back up [40](#)
 - change running config [625, 685](#)
 - saving [97](#)
- configuration file [98](#)
 - backup [613, 683](#)
 - restore [98, 613, 682](#)
 - save [616](#)
- Configure Clone screen [617](#)
- contact information [694](#)
- copying port settings, see port cloning
- copyright [710](#)
- CoS [360](#)
- CPU management port [439](#)
- CPU protection [538](#)
- crossover Ethernet cable [46](#)

Current Configuration [686](#)
current date [161, 637](#)
current time [161, 636](#)
Custom Default [626, 686](#)
customer support [694](#)

D

date
 current [161, 637](#)
daylight saving time [161, 637](#)
DDMI Details screen [145](#)
DDMI screen [144](#)
debug port [49](#)
device back label
 Switch [33](#)
DHCP [466](#)
 configuration options [467](#)
 modes [466](#)
DHCP (Dynamic Host Configuration Protocol) [466](#)
DHCP Option 82 Profile screen [467, 468](#)
DHCP relay
 configure [113](#)
 tutorial [110](#)
DHCP relay agent [705](#)
DHCP relay option 82 [562](#)
DHCP server
 block [551](#)
DHCP snooping [106, 546, 551, 561](#)
 configure [562](#)
 DHCP relay option 82 [562](#)
 trusted ports [561](#)
 untrusted ports [561](#)
DHCP snooping database [561](#)
DHCP Status screen [467](#)
DHCP Unique Identifier (DUID) [704](#)
DHCP-assigned IP [690](#)
DHCPv4
 global relay [469](#)
 global relay example [471](#)
 option 82 profiles [467, 468](#)
DHCPv6
 enable in Windows 10 [708](#)
DHCPv6 client [39](#)

DHCPv6 Client Setup screen [188](#)
DHCPv6 relay [39](#)
 interface-ID [475](#)
 remote-ID [475](#)
DHCPv6 Relay screen [475, 476](#)
diagnostics
 ping [621](#)
Differentiated Service (DiffServ) [360](#)
DiffServ [360](#)
 activate [361](#)
 DS field [360](#)
 DSCP [360](#)
 network example [361](#)
 PHB [360](#)
 service level [360](#)
DiffServ Code Points [360](#)
Digital Diagnostics Monitoring Interface [144](#)
disclaimer [710](#)
disposal and recycling information
 EU [712](#)
double-tagged frames [450](#)
DS (Differentiated Services) [360](#)
DSCP [360](#)
 what it does [360](#)
dual firmware images [623, 684](#)
duplex mode [46](#)
dust plug [48](#)
Dynamic Host Configuration Protocol for IPv6
 (DHCPv6) [704](#)
dynamic link aggregation [234](#)

E

egress port [440](#)
egress rate [373](#)
electrical inspection authority [51](#)
electrician [52](#)
electrostatic discharge (ESD) [47](#)
EMC statement [710](#)
Environment Statement [712](#)
Errdisable Detect screen [543](#)
Errdisable Recovery screen [544](#)
errdisable status [541](#)
error disable [538](#)

- control packets [541](#)
- CPU protection [541](#)
 - detect [543](#)
 - recovery [544](#)
 - status [539](#)
- error-disable recovery [538](#)
- Ethernet broadcast address [124, 460](#)
- Ethernet MAC [152, 632](#)
- Ethernet OAM [272](#)
- Ethernet port
 - auto-crossover [46](#)
 - auto-negotiating [46](#)
- Ethernet settings
 - default [47](#)
- external authentication server [486](#)

F

- Factory Default [626, 686](#)
- fan speed [153](#)
- FCC interference statement [710](#)
- fiber cable
 - connecting [48](#)
 - removal [49](#)
- file transfer using FTP
 - command example [606](#)
- filename convention, configuration
 - file names [606](#)
- filtering [410](#)
 - rules [410](#)
- filtering database, MAC table [130](#)
- Filtering screen [410](#)
- firmware [632](#)
 - upgrade [612, 623, 684](#)
 - ZyNOS [152](#)
- Firmware Upgrade screen [623, 684](#)
- flow control [293, 659](#)
 - back pressure [293, 659](#)
 - IEEE802.3x [293, 659](#)
- forwarding
 - delay [402](#)
- frames
 - tagged [425, 678](#)
 - untagged [425, 678](#)
- freestanding installation

- precautions [42](#)
- front panel [45](#)
- FTP [605](#)
 - file transfer procedure [607](#)
 - restrictions over WAN [607](#)
- full duplex
 - Ethernet port [46](#)

G

- GARP (Generic Attribute Registration Protocol) [416, 672](#)
- GARP timer [213, 416, 672](#)
- general setup [160](#)
- General Setup screen [160, 635](#)
- getting help [99](#)
- gigabit ports [46](#)
- GMT (Greenwich Mean Time) [161, 637](#)
- gratuitous ARP [461](#)
- green Ethernet [230](#)
 - and uplink port [230](#)
 - auto power down [230](#)
 - EEE [230](#)
 - short reach [230](#)
- grounding
 - for safety [50](#)
- GVRP [672](#)
- GVRP (GARP VLAN Registration Protocol) [417, 672](#)

H

- half duplex
 - Ethernet port [46](#)
- hardware installation [41](#)
- hardware monitor [152, 153, 632](#)
- hardware overview [45](#)
- hello time [402](#)
- hops [402](#)
- HTTPS [505](#)
 - certificates [505](#)
 - implementation [505](#)
 - public keys, private keys [505](#)
- HTTPS Certificates screen [605](#)

HTTPS example [506](#)

I

IANA (Internet Assigned Number Authority) [699](#)

Identity Association (IA) [704](#)

IEEE 802.1x

activate [586](#)

port authentication [584](#)

re-authentication [588](#)

IEEE 802.3at [35](#)

IEEE 802.3az [230](#)

IEEE 802.3bt [35](#)

IEEE 802.3bz [29](#)

IEEE standard [35](#)

IGMP filtering [316](#)

profile [326](#), [327](#), [668](#), [669](#)

profiles [321](#)

IGMP leave timeout

fast [323](#), [665](#)

normal [323](#), [665](#)

IGMP snooping [316](#)

MVR [318](#)

IGMP snooping and VLANs [317](#)

IGMP throttling [323](#), [665](#)

ingress port [440](#)

ingress rate [373](#)

initial setup [101](#)

Innovation, Science and Economic Development

Canada ICES statement [710](#)

installation

air circulation [41](#)

desktop [41](#)

freestanding [41](#)

rack-mounting [42](#)

transceiver [47](#)

installation scenarios [41](#)

Interface Setup screen [164](#), [165](#)

Internet Protocol version 6, see IPv6

IP

configuration [169](#)

interface [166](#)

routing domain [166](#)

status [167](#)

IP address [168](#)

Switch management [103](#)

IP Setup screen [166](#)

IP source guard [546](#)

ARP inspection [546](#), [581](#)

DHCP snooping [546](#)

static bindings [546](#)

IP Status Detail screen [167](#)

IP subnet mask [168](#)

IP table [126](#)

how it works [126](#)

IPv4/IPv6 dual stack [39](#)

IPv6 [39](#), [702](#)

addressing [702](#)

enable in Windows 10 [708](#)

enable in Windows 7 [707](#)

EUI-64 [704](#)

global address [702](#)

interface ID [704](#)

link-local address [702](#)

Neighbor Discovery Protocol [39](#), [702](#)

neighbor table [128](#)

ping [39](#), [702](#)

prefix [702](#)

prefix length [702](#)

unspecified address [703](#)

IPv6 address size [39](#)

IPv6 cache [706](#)

IPv6 Global Setup screen [176](#)

IPv6 interface [164](#)

DHCPv6 client [187](#), [188](#)

enable [177](#), [178](#)

global address [180](#)

global unicast address [176](#)

link-local address [178](#), [179](#)

link-local IP [175](#)

neighbor discovery [181](#), [182](#)

neighbor table [186](#)

status [174](#)

IPv6 Interface Setup Edit screen [178](#)

IPv6 Interface Setup screen [177](#)

IPv6 Interface Status screen [175](#)

IPv6 multicast

status [328](#)

IPv6 Neighbor Setup screen [186](#), [187](#)

IPv6 Neighbor Table screen [128](#)

IPv6 screen [173](#)

IPv6 static route

configuration [482](#)

J

Java permission [58, 691](#)

JavaScript [58, 691](#)

L

L2PT [301](#)

access port [302](#)

CDP [301](#)

configuration [302](#)

encapsulation [301](#)

example [301](#)

LACP [302](#)

MAC address [301, 304](#)

mode [302](#)

overview [301](#)

PAGP [302](#)

point to point [302](#)

STP [301](#)

tunnel port [302](#)

UDLD [302](#)

VTP [301](#)

LACP [234, 304](#)

system priority [242, 652](#)

timeout [243, 653](#)

Layer 2 protocol tunneling, see L2PT

LED behavior

CLOUD [32](#)

LED description [32](#)

LEDs [54](#)

limit MAC address learning [602](#)

link aggregation [72, 81, 234](#)

dynamic [234](#)

ID information [235](#)

setup [237, 650](#)

traffic distribution algorithm [237, 649](#)

traffic distribution type [240, 651](#)

trunk group [234](#)

link aggregation (trunking) [650](#)

Link Aggregation Control Protocol (LACP) [234](#)

Link Aggregation screen

Wizard [81](#)

Link Aggregation Setting screen [650](#)

Link Aggregation Status screen [648](#)

Link Layer Discovery Protocol [245](#)

LLDP [245](#)

basic TLV [261](#)

global settings [258](#)

local port status [249](#)

organization-specific TLV [263](#)

status of remote device [253](#)

TLV [245](#)

LLDP (Link Layer Discovery Protocol) [245](#)

LLDP-MED [246](#)

classes of endpoint devices [246](#)

example [246](#)

LLDP-MED Location screen [268](#)

LLDP-MED Setup screen [264](#)

lockout [97](#)

Switch [97](#)

log message [156](#)

login [58](#)

password [97](#)

privilege level [191, 641](#)

login account

administrator [190, 639](#)

non-administrator [190, 639](#)

login accounts [190, 639](#)

configuring through Web Configurator [190, 639](#)

multiple [190, 639](#)

number of [190, 639](#)

login password

edit [191, 640](#)

login user name

display [502](#)

Logins screen [190, 639](#)

loop guard [306](#)

examples [307](#)

port shut down [307](#)

setup [308](#)

vs. STP [306](#)

Wizard [83](#)

M

MAC (Media Access Control) [152, 632](#)

- MAC address [124](#), [152](#), [632](#)
 - maximum number per port [602](#)
- MAC address learning [213](#), [602](#)
 - specify limit [602](#)
- MAC Based VLAN screen [435](#), [436](#)
- MAC filter
 - and ARP inspection [582](#)
- MAC freeze [601](#)
- MAC table [130](#)
 - display criteria [132](#)
 - how it works [130](#)
 - sorting criteria [132](#)
 - viewing [131](#)
- MAC-based VLAN [435](#)
- maintenance
 - configuration backup [613](#), [683](#)
 - firmware [623](#), [684](#)
 - restore configuration [613](#), [682](#)
- Management Information Base (MIB) [199](#), [642](#)
- management IP address [103](#)
- management method [31](#)
- management mode [31](#)
- management port [440](#)
- managing the device
 - using the command line interface, see command line interface [39](#)
- managing the Switch
 - cluster management [40](#)
 - good habits [40](#)
 - NCC [39](#)
 - using FTP, see FTP [39](#)
 - using SNMP [39](#)
 - Web Configurator [39](#)
 - ZON Utility [40](#)
- man-in-the-middle attacks [581](#)
- max
 - age [402](#)
 - hops [402](#)
- maximum transmission unit [139](#)
- Maximum Transmission Unit (MTU) [175](#)
- Mbuf (Memory Buffer) [627](#)
- MDIX (Media Dependent Interface Crossover) [47](#)
- Media Access Control [152](#), [632](#)
- Memory Buffer [627](#)
- MIB
 - and SNMP [199](#), [642](#)
 - supported MIBs [199](#)
- MIB (Management Information Base) [199](#), [642](#)
- mirroring ports [313](#)
- MLD filtering profile [336](#), [337](#), [338](#)
- MLD proxy [39](#)
- MLD snooping [39](#)
- MLD snooping-proxy [329](#)
 - filtering [334](#)
 - filtering profile [336](#), [337](#), [338](#)
 - port role [332](#)
 - VLAN ID [331](#)
- models
 - XS1930 [28](#)
- monitor port [313](#), [314](#), [660](#)
- mounting brackets
 - attaching [43](#)
- MSA (MultiSource Agreement) [47](#)
- MST Instance, see MSTI [408](#)
- MST region [407](#)
- MSTI [408](#)
- MSTP
 - bridge ID [399](#)
 - configuration [401](#)
 - configuration digest [400](#)
 - forwarding delay [402](#)
 - Hello Time [400](#)
 - hello time [402](#)
 - Max Age [400](#)
 - max age [402](#)
 - max hops [402](#)
 - path cost [405](#)
 - port priority [405](#)
 - revision level [403](#)
 - status [397](#)
- MTU [139](#)
- MTU (Multi-Tenant Unit) [211](#)
- multicast
 - 802.1 priority [321](#)
 - IGMP throttling [323](#), [665](#)
 - IP addresses [316](#)
 - setup [321](#)
- multicast group [326](#), [327](#), [668](#), [669](#)
- multicast IP address [346](#)
- multicast MAC address [346](#)
- Multi-Gigabit (IEEE 802.3bz) [29](#)
- Multi-Gigabit port [29](#)

Multi-Tenant Unit [211](#)

MVR [318](#)

configuration [338](#), [339](#)

network example [318](#)

MVR (Multicast VLAN Registration) [318](#)

myZyxel account

sign up [33](#)

myZyxel account information

enter [32](#)

N

Nebula Cloud Management [31](#)

switching to [32](#)

Nebula web portal [31](#), [32](#)

access in three ways [32](#)

Neighbor Details [135](#)

Neighbor Discovery Protocol (NDP) [705](#)

Neighbor screen [133](#)

network applications [29](#), [36](#)

network element (NE) [641](#)

network management system (NMS) [198](#), [641](#)

Networked AV mode [34](#), [629](#)

overview [629](#)

Networked AV screen

Wizard [70](#), [75](#)

NTP (RFC-1305) [161](#), [636](#)

O

OAM [272](#)

details [274](#)

discovery [272](#)

port configuration [272](#)

remote loopback [272](#), [280](#)

Operations, Administration and Maintenance [272](#)

organization

create [33](#)

Organizationally Unique Identifiers (OUI) [433](#)

Org-specific TLV Setting screen [263](#)

overheating

prevention [41](#)

P

PAGP [304](#)

password [97](#)

administrator [62](#), [191](#), [640](#)

change [40](#)

change through Wizard [69](#), [74](#), [80](#)

display [502](#)

write down [40](#)

password change

through Password / SNMP link [61](#)

password encryption

activate [503](#)

Path MTU Discovery [139](#)

Path MTU Table screen [139](#)

Per-Hop Behavior [360](#)

PHB [360](#)

ping, test connection [621](#)

PoE

PD priority [287](#), [657](#)

power management mode [286](#), [656](#)

power-up mode [285](#), [655](#)

PoE (Power over Ethernet) [282](#)

PoE features

by model [35](#)

PoE Setup screen [285](#)

PoE standards [35](#)

PoE Status screen [283](#)

PoE Time Range Setup screen [288](#), [289](#)

PoE type [35](#)

policy [519](#), [520](#)

and classifier [519](#), [520](#)

and DiffServ [518](#)

configuration [519](#), [520](#)

example [522](#)

overview [518](#)

rules [518](#), [519](#)

port

maximum power [35](#)

setup [291](#), [658](#)

speed/duplex [292](#)

voltage range [36](#)

Port Aggregation Protocol, see PAGP

port authentication

guest VLAN [591](#)

IEEE802.1x [586](#)

- MAC authentication [588](#)
 - method [586](#)
- port cloning [617](#), [618](#)
 - advanced settings [617](#), [618](#)
 - basic settings [617](#), [618](#)
- port details [142](#)
- port isolation
 - Setting Wizard [440](#)
- port mirroring [313](#), [314](#), [660](#)
- port redundancy [234](#)
- Port screen
 - DHCPv4 Global Relay [470](#)
- port security [599](#)
 - address learning [602](#)
 - limit MAC address learning [602](#)
 - setup [599](#)
- Port Setup screen [291](#), [658](#)
- port status
 - port details [142](#)
 - port utilization [147](#)
- port utilization [147](#)
- Port VID (PVID) [102](#)
- port VLAN ID, see PVID [425](#), [678](#)
- port VLAN trunking [417](#), [673](#)
- port-based VLAN [438](#)
 - all connected [440](#)
 - configure [439](#)
 - port isolation [440](#)
 - settings wizard [440](#)
- ports
 - diagnostics [622](#)
 - mirroring [313](#)
 - speed/duplex [659](#)
 - standby [235](#)
- power
 - maximum per port [35](#)
 - voltage [153](#), [154](#), [633](#)
- power connections [52](#)
- power connector [52](#)
- power cord requirement
 - XGS2220-54HP / XGS2220-54FP [52](#)
- Power Sourcing Equipment (PSE) [35](#)
- power status [153](#), [154](#), [633](#)
- powered device (PD) [35](#), [282](#)
- PPPoE IA [351](#)
 - agent sub-options [353](#)

- drop PPPoE packets [355](#)
- port state [353](#)
- sub-option format [352](#)
- tag format [351](#)
- trusted ports [353](#)
- untrusted ports [353](#)
 - VLAN [358](#)
- PPPoE Intermediate Agent [351](#)
- prefix delegation [705](#)
- product registration [714](#)
- protocol based VLAN
 - example [432](#)
- PVID [416](#), [671](#)

Q

- QoS [360](#)
 - and classifier [509](#)
 - priority setting [87](#)
- QoS setting [86](#)
- QR code
 - Switch [33](#)
 - where to find [33](#)
- Quality of Service [360](#)
- queue weight [366](#)
- queuing [365](#), [366](#)
 - SPQ [365](#)
 - WRR [365](#)
- queuing method [365](#), [367](#)
- Quick Start Guide
 - steps for registering the Switch [32](#)

R

- rack-mounting [42](#)
 - installation requirements [42](#)
 - precautions [42](#)
- RADIUS [486](#), [499](#)
 - advantages [486](#)
 - setup [486](#)
- Rapid Spanning Tree Protocol (RSTP) [378](#)
- rear panel [49](#)
- reboot
 - load configuration [625](#), [685](#)

- reboot system **625, 685**
 - registration
 - product **714**
 - Registration MAC address **33**
 - Regulatory Notice and Statement **710**
 - remote management **39, 500, 680**
 - service **501, 681**
 - trusted computers **501, 681**
 - Remote Management screen **680**
 - RESET button **98**
 - resetting **98, 615**
 - to factory default settings **615**
 - restore
 - configuration **40**
 - restore configuration **98, 613, 682**
 - RFC 3164 **214**
 - Round Robin Scheduling **365**
 - Router Advertisement (RA) **705**
 - routing domain **166**
 - RSTP
 - configuration **387**
 - rubber feet
 - attach **42**
 - running configuration **615**
 - erase **615**
 - reset **615**
- ## S
- safety precautions
 - using the Switch **41**
 - safety warnings **711**
 - save configuration **97, 616**
 - Save link **97**
 - schedule
 - type **218**
 - Secure Shell, see SSH
 - serial number
 - Switch **33**
 - service access control **499, 679**
 - service port **500, 679**
 - Service Access Control screen **679**
 - Setup Wizard
 - parts **67, 77**
 - Setup Wizard screen **60**
 - sFlow **374**
 - configuration **374**
 - datagram **374**
 - overview **374**
 - poll interval **376**
 - sample rate **376**
 - UDP port **377**
 - sFlow agent **374**
 - sFlow collector **374**
 - SFP/SFP+ slot **47**
 - Simple Network Management Protocol (SNMP) **641**
 - Simple Network Management Protocol, see SNMP
 - site
 - create **33**
 - SNMP **198**
 - agent **199, 641**
 - and MIB **199, 642**
 - authentication **194, 195, 644, 645**
 - communities **62, 193, 643**
 - management model **199, 641**
 - manager **199, 641**
 - MIB **199**
 - network components **199, 641**
 - object variables **199, 642**
 - protocol operations **199, 642**
 - security **195, 645**
 - security level **194, 644**
 - settings **641**
 - setup **192, 641**
 - traps **196, 645**
 - users **194, 643**
 - version 3 and security **199, 642**
 - versions supported **198, 641**
 - SNMP agent
 - enable through Wizard **69, 74, 80**
 - SNMP screen **642**
 - SNMP traps **200**
 - supported **200**
 - SNMP version
 - select **69, 74, 80**
 - specifications
 - power cord **52**
 - SPQ (Strict Priority Queuing) **365**
 - SSH
 - encryption methods **504**
 - how it works **503**

- implementation [504](#)
 - SSH (Secure Shell) [503](#)
 - SSL (Secure Socket Layer) [505](#)
 - Stacking Default [626](#)
 - Stacking mode [29, 30](#)
 - default static IP address [30](#)
 - Standalone mode
 - switch to [34](#)
 - standby ports [235](#)
 - static address assignment [39](#)
 - static bindings [546](#)
 - static MAC address [412](#)
 - static MAC forwarding [412](#)
 - Static MAC Forwarding screen [412, 413](#)
 - static multicast forwarding [346](#)
 - static route [480](#)
 - enable [482](#)
 - metric [482](#)
 - overview [480](#)
 - static VLAN [421, 675](#)
 - control [423, 677](#)
 - tagging [423, 677](#)
 - status [87](#)
 - MSTP [397](#)
 - power [153, 154, 633](#)
 - STP [385](#)
 - VLAN [418, 673](#)
 - Storm Control screen [681](#)
 - STP [304](#)
 - bridge ID [386, 392](#)
 - bridge priority [389, 395](#)
 - designated bridge [379](#)
 - edge port [390, 396](#)
 - forwarding delay [390](#)
 - Hello BPDU [379](#)
 - Hello Time [386, 389, 392, 395](#)
 - how it works [379](#)
 - Max Age [386, 390, 392, 396](#)
 - path cost [379, 390, 396](#)
 - port priority [390, 396](#)
 - port role [387, 393](#)
 - port state [379, 387, 393](#)
 - root port [379](#)
 - status [381, 385](#)
 - terminology [379](#)
 - vs. loop guard [306](#)
 - STP Path Cost [379](#)
 - straight-through Ethernet cable [46](#)
 - subnet based VLANs [427](#)
 - subnet masking [704](#)
 - Summary screen [629](#)
 - supply voltage [52](#)
 - Switch
 - DHCP client [58](#)
 - fanless-type usage precaution [41](#)
 - fan-type usage precaution [41](#)
 - switch lockout [97](#)
 - Switch reset [98](#)
 - syslog [214, 582](#)
 - protocol [214](#)
 - settings [214](#)
 - setup [214](#)
 - severity levels [214](#)
 - Syslog Setup screen [214](#)
 - System Info screen [151, 631](#)
 - system reboot [625, 685](#)
- ## T
- TACACS+ [486, 499](#)
 - advantages [486](#)
 - setup [488](#)
 - tag-based VLAN
 - example [38](#)
 - tagged VLAN [416, 671](#)
 - Tech-Support [627, 686, 687](#)
 - log enhancement [627, 686](#)
 - Tech-Support screen [627, 686](#)
 - temperature indicator [152, 153, 154, 633](#)
 - time
 - current [161, 636](#)
 - daylight saving [161, 637](#)
 - format [161, 636](#)
 - Time (RFC-868) [161, 636](#)
 - time server [161, 636](#)
 - time service protocol [161, 636](#)
 - ToS [360](#)
 - trademarks [714](#)
 - traffic distribution criteria [235](#)
 - transceiver
 - connection interface [47](#)

connection speed [47](#)
 installation [47](#)
 removal [48](#)
 traps
 destination [193, 643](#)
 troubleshooting [114](#)
 trunk group [234](#)
 Trunk Tagged port [86](#)
 trunking [234](#)
 trusted ports
 ARP inspection [582](#)
 DHCP snooping [561](#)
 PPPoE IA [353](#)
 tutorial
 basic setup [106](#)
 DHCP snooping [106](#)
 twisted pair
 used [36](#)
 Type of Service [360](#)
 Type Transfer [132](#)

U

UDLD [304](#)
 UniDirectional Link Detection, see UDLD
 unregister
 Switch [34](#)
 untrusted ports
 ARP inspection [582](#)
 DHCP snooping [561](#)
 PPPoE IA [353](#)
 uplink connection
 super-fast [37](#)
 user name [59](#)
 default [59](#)
 user profiles [486](#)
 UTC (Universal Time Coordinated) [161, 637](#)

V

Vendor ID Based VLAN screen [437](#)
 Vendor Specific Attribute, see VSA [493](#)
 ventilation holes [41](#)

VID [171, 419, 420, 452, 639, 674, 675](#)
 number of possible VIDs [416, 671](#)
 priority frame [416, 671](#)
 VID (VLAN Identifier) [416, 671](#)
 Virtual Local Area Network [211](#)
 VLAN [211](#)
 acceptable frame type [425, 678](#)
 and IGMP snooping [317](#)
 automatic registration [416, 672](#)
 creation [101, 110](#)
 ID [416, 671](#)
 ingress filtering [425, 678](#)
 introduction [211, 416, 671](#)
 number of VLANs [419, 674](#)
 port number [420, 675](#)
 port settings [423, 425, 677](#)
 port-based [440](#)
 port-based VLAN [438](#)
 port-based, isolation [440](#)
 port-based, wizard [440](#)
 PVID [425, 678](#)
 static VLAN [421, 675](#)
 status [418, 419, 420, 673, 674, 675](#)
 subnet based [427](#)
 tagged [416, 671](#)
 terminology [417, 672](#)
 trunking [417, 425, 673, 678](#)
 type [213, 418](#)
 VLAN (Virtual Local Area Network) [211](#)
 VLAN ID [416, 671](#)
 VLAN mapping [445](#)
 activating [446](#)
 configuration [447, 448](#)
 example [445](#)
 priority level [445](#)
 tagged [445](#)
 traffic flow [445](#)
 untagged [445](#)
 VLAN ID [445](#)
 VLAN member port [86](#)
 VLAN number [168, 171, 639](#)
 VLAN setting
 Wizard [85](#)
 VLAN Setting screen
 DHCPv4 [474](#)
 VLAN stacking [450, 452](#)
 configuration [452](#)
 example [450](#)

- frame format [452](#)
- port roles [451, 454](#)
- port-based Q-in-Q [454](#)
- priority [452](#)
- selective Q-in-Q [456](#)
- VLAN terminology [417, 672](#)
- VLAN trunking [425, 678](#)
- VLAN Trunking Protocol, see VTP
- VLAN-unaware devices [102](#)
- voice VLAN [433](#)
- Voice VLAN Setup screen [433, 434](#)
- voltage range
 - port [36](#)
- VSA [493](#)
- VTP [304](#)

W

- warranty
 - note [714](#)
- Web browser pop-up window [58, 691](#)
- Web Configurator
 - getting help [99](#)
 - home [87](#)
 - login [58](#)
 - logout [99](#)
 - navigating components [88](#)
 - navigation panel [89](#)
 - online help [99](#)
 - usage prerequisite [58](#)
- weight [366](#)
- Wizard
 - link aggregation [72](#)
- WRR (Weighted Round Robin Scheduling) [365](#)

Z

- ZDP [63](#)
- ZON Utility [63](#)
 - compatible OS [63](#)
 - fields description [66](#)
 - icon description [66](#)
 - installation requirements [63](#)
 - introduction [34](#)

- minimum hardware requirements [63](#)
- network adapter select [64](#)
- password prompt [66](#)
- run [63](#)
- supported firmware version [64](#)
- supported models [64](#)
- Switch IP address [58](#)
- ZON utility
 - use for troubleshooting [690](#)
- ZULD
 - example [294](#)
 - probe time [297](#)
 - status [295](#)
- ZULD (Zyxel Unidirectional Link Detection) [294](#)
- ZyNOS (Zyxel Network Operating System) [606](#)
- Zyxel AP Configurator (ZAC) [66](#)
- Zyxel Discovery Protocol (ZDP) [63](#)
- Zyxel Nebula Mobile app [33](#)
- Zyxel One Network (ZON) Utility [34](#)
- Zyxel Unidirectional Link Detection (ZULD) [294](#)