

Dell Wyse 5070 Extended Thin Client

User Guide



Notes, cautions, and warnings

 **NOTE:** A NOTE indicates important information that helps you make better use of your product.

 **CAUTION:** A CAUTION indicates either potential damage to hardware or loss of data and tells you how to avoid the problem.

 **WARNING:** A WARNING indicates a potential for property damage, personal injury, or death.

Contents

Chapter 1: Welcome to Dell Wyse 5070 extended thin client.....	6
Chapter 2: Chassis overview.....	7
Chapter 3: Major components of your thin client	9
Chapter 4: Supported system peripherals for Wyse 5070 thin client.....	10
Supported displays	10
Supported mounts	11
Supported system peripherals	11
Chapter 5: Setting up the thin client.....	12
Chapter 6: Before working on your thin client.....	16
Chapter 7: After working on your thin client.....	17
Chapter 8: Removing and installing components.....	18
Safety instructions.....	18
Before working on your thin client.....	19
Safety precautions.....	19
Electrostatic discharge—ESD protection.....	19
ESD field service kit	20
Transporting sensitive components.....	21
After working on your thin client.....	21
Recommended tools.....	21
Screw size list.....	22
Chassis cover.....	23
Remove the chassis cover.....	23
Install the chassis cover.....	26
PCIe module.....	29
Remove the PCIe module.....	29
Install the PCIe module.....	31
Coin-cell battery.....	33
Remove the coin-cell battery.....	33
Install the coin-cell battery.....	34
Solid-state drive.....	35
Remove the solid-state drive.....	35
Install the solid-state drive.....	36
Expansion module.....	36
Remove the expansion module-VGA-RJ45-SFP.....	36
Install the expansion module-VGA-RJ45-SFP.....	38
Wireless card.....	39
Remove the wireless card.....	39

Install the wireless card.....	40
CAC reader.....	40
Remove the CAC reader.....	40
Install the CAC reader.....	43
Memory.....	46
Remove the memory module.....	46
Install the memory module.....	50
Speaker and power button.....	51
Remove the speaker and power button.....	51
Install the speaker and power button.....	53
Serial and parallel port.....	54
Remove the serial and parallel port.....	54
Install the serial and parallel port.....	56
Heat sink.....	57
Remove the heat sink.....	57
Install the heat sink.....	58
System board.....	60
Remove the system board.....	60
Install the system board.....	63
Chapter 9: Technical specifications.....	64
System specifications.....	64
Processor.....	64
Operating systems.....	65
Memory specifications.....	65
Storage.....	65
Audio specifications.....	66
Communication specifications.....	66
Ports and connectors specifications.....	67
Security.....	67
Battery specifications.....	67
AC adapter specifications.....	68
Physical specifications.....	68
Environment.....	68
Chapter 10: Wyse 5070 thin client configuration on ThinOS.....	69
Introduction.....	69
Configuring ThinOS using the First Boot Wizard.....	69
Logging on to the Wyse 5070 thin client running Wyse ThinOS.....	71
Local settings menu	71
Configuring the keyboard settings.....	71
Configuring the mouse settings.....	72
Configuring the display setup.....	72
Configuring the LPD settings.....	73
Configuring the printer settings.....	73
Configuring the ports settings.....	74
Configuring the LPD settings.....	74
Configuring the SMBs settings.....	75
Using the printer setup options.....	75

Chapter 11: Wyse 5070 thin client on ThinLinux.....	76
Introduction.....	76
Logging on to the Wyse 5070 thin client running ThinLinux.....	76
Configuring peripherals settings on Wyse ThinLinux.....	76
Configuring display on Dell Wyse ThinLinux.....	76
Setting the keyboard preferences.....	77
Customizing the display.....	78
Setting the mouse preferences.....	79
Configuring the printer settings.....	80
Chapter 12: Wyse 5070 thin client on Windows 10 IoT Enterprise.....	82
Introduction.....	82
Before configuring your thin clients.....	82
Automatic and manual login.....	82
Enabling auto logon.....	83
Keyboard and region settings.....	83
Devices and printers.....	84
Adding printers.....	84
Configuring multi-monitor display.....	84
Chapter 13: BIOS overview.....	86
Accessing thin client BIOS settings.....	86
System Setup overview.....	86
Boot Sequence.....	87
Navigation keys.....	87
General screen options.....	87
System Configuration screen options.....	88
Video screen option.....	90
Security screen options.....	90
Secure Boot screen options.....	92
Performance screen options.....	92
Power management screen options.....	93
POST behavior screen options.....	94
Wireless screen option.....	94
Virtualization support screen options.....	95
Maintenance screen options.....	95
System Logs screen option.....	95
Chapter 14: Troubleshooting your system.....	96
Power state and LED status.....	96
Power behavior.....	96
Power LED error code behavior.....	97

Welcome to Dell Wyse 5070 extended thin client

Wyse 5070 extended thin client is a high-performance thin client with quad core processors, designed for secure, and easy-to-manage virtual desktop environments. The thin client supports ThinOS, ThinLinux, and Windows 10 IoT Enterprise operating systems.

Dell Wyse 5070 is a 5000 series thin client which offers the following:

- Intel Gemini Lake Pentium Quad Core processor.
- Realtek ALC3253 and Intel audio controllers.
- Intel UHD Graphics 605 and an optional External Gfx Card (AMD E9173) with 4 GB GDDR5 memory.
- Common access card reader—optional.

Chassis overview

This section explains the front and rear views of Dell Wyse 5070 extended thin client.

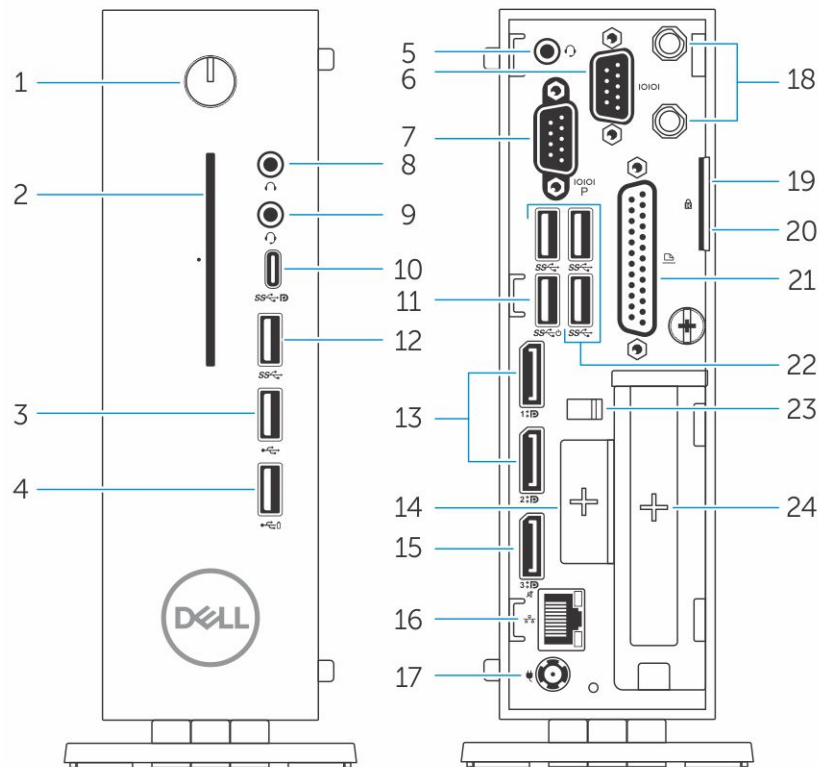

Figure 1. Chassis overview

1. Power button/Power light

Press to turn on the thin client if it is turned off, in sleep state.

2. Common Access Card reader

Reads the CAC or smart card for multi factor authentication.

3. USB 2.0 port

Connect peripherals such as external storage devices and printers. Provides data transfer speeds up to 480 Mbps.

4. USB 2.0 port with PowerShare

Connect peripherals such as external storage devices and printers, and charges the USB devices when thin client is in sleep state. Provides data transfer speeds up to 480 Mbps.

5. Headset port

Connect headphones or speakers. This is valid for pentium processor based model.

6. Serial port

Connect serial device. Internal jumpers to enable supply of 5V/1A total to selected pin(s).

7. Serial port with power

Connect the serial devices to transfer data and power.

8. **Line out port**

Denotes the audio output to the active speaker. Connect peripherals such as external storage devices, display, and printers. Provides data transfer speeds up to 10 Gbps.

9. **Headset port**

Connect headphones output, a headset (headphone and microphone combo), or speakers.

10. **USB Type-C port**

Enables you to connect peripherals such as external storage devices, display, and printers. Provides data transfer speeds up to 5 Gbps. It provides up to 5 V/3 A power output that enables faster charging.

11. **USB 3.0 with Smart Power-on**

Connect keyboard or monitor to wake up your thin client from off state.

12. **USB 3.0 port**

Connect peripherals such as storage devices and printers. Provides data transfer speeds up to 5 Gbps.

13. **Display port**

Connect an external display or a projector.

14. **Expansion slot—RJ45/SFP/VGA**

Connect RJ45/SFP/VGA to your thin client.

15. **Display port without audio**

Connect an external display or a projector. Video output only. No audio output from this port.

16. **Network port**

Connect an Ethernet (RJ45) cable from a router or a broadband modem for network or internet access. The two lights next to the connector indicate the connectivity status and network activity.

17. **Power connector port**

Connect a power cable to provide power to your thin client.

NOTE:

DP1 is natural output from SOC directly while additional circuitry is required in the path of DP2/DP3 in order to support DP2/Type C mux and DP3/VGA mux. The additional circuitry consumes more power once the DP2 or DP3 is being used. To maintain ENERGY STAR designation you should use DP1.

18. **Wireless antenna**

Connect wireless card wire to extend the wireless connectivity of your thin client.

19. **Pad lock**

Apply pad lock to prevent unauthorized access to the hardware components of your thin client.

20. **Kensington lock**

Connect a security cable to prevent unauthorized movement of your thin client.

21. **Parallel port**

Connector that sends or receives data using more than one wire.

22. **USB 3.0** Connect peripherals such as storage devices and printers. Provides data transfer speeds up to 5 Gbps.

23. **Power cable hook**

Secures the power adaptor cable of your thin client.

24. **PCIe slot**

Connect internal Wi-Fi cards.

Major components of your thin client

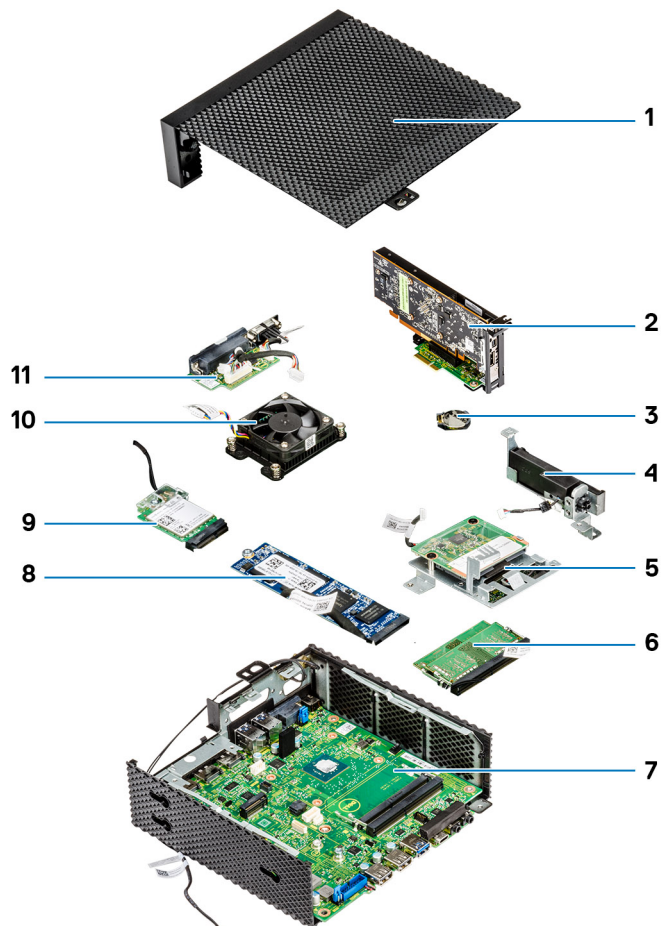

- | | |
|------------------------------|-----------------------------|
| 1. Chassis cover | 2. PCIe module |
| 3. Coin-cell battery | 4. Speaker and power button |
| 5. CAC reader | 6. Memory |
| 7. System board | 8. Solid-state drive |
| 9. Wireless card | 10. Heat sink |
| 11. Serial and parallel port | |

Supported system peripherals for Wyse 5070 thin client

This section contains details on the supported system peripherals that are shipped as part of Wyse 5070 thin client.

Topics:

- [Supported displays](#)
- [Supported mounts](#)
- [Supported system peripherals](#)

Supported displays

The following Dell displays are supported by Dell Wyse 5070 thin client:

- MR2416
- U2518D
- U2718Q
- U2419H/HC
- U2415
- U2719D/DC
- P2415Q
- P2417H
- P2317H
- P2217H
- P2016
- P2419H/HC
- P2719H/HC
- P4317Q
- E2417H
- E2318H
- E2218HN
- E2016H
- E1916H
- P3418HW
- P2219HC/P2219H
- P2319H

For more information about these displays, see [Dell Support](#).

Supported mounts

This section contains details on the supported mounts for Wyse 5070 thin client.

- P mount
- E mount
- U mount
- Dual VESA mount
- VESA Wall mount

 **NOTE:** Vertical stand will be shipped as part of Wyse 5070 thin client.

For more information on mounts, see [Dell Support](#).

Supported system peripherals

This section contains details on the supported system peripherals for Wyse 5070 thin client.

- Dell Pro stereo headset
- Jabra Pro 935 wireless headset (mono)
- Microsoft LX-6000 headset
- Dell USB wired keyboard with optical mouse
- Dell USB wired keyboard with smart card reader
- Cherry smart card keyboard
- Dell wireless Keyboard and mouse

For more information on system accessories, see [Dell Support](#).

Setting up the thin client

This section explains how to setup the Wyse 5070 extended thin client on premise.

The Wyse 5070 extended thin client can be setup with any one of the operating systems at your work place:

- ThinOS
- Windows 10 IoT Enterprise
- ThinLinux

To set up the Wyse 5070 extended thin client, do the following:

1. Install the stand.

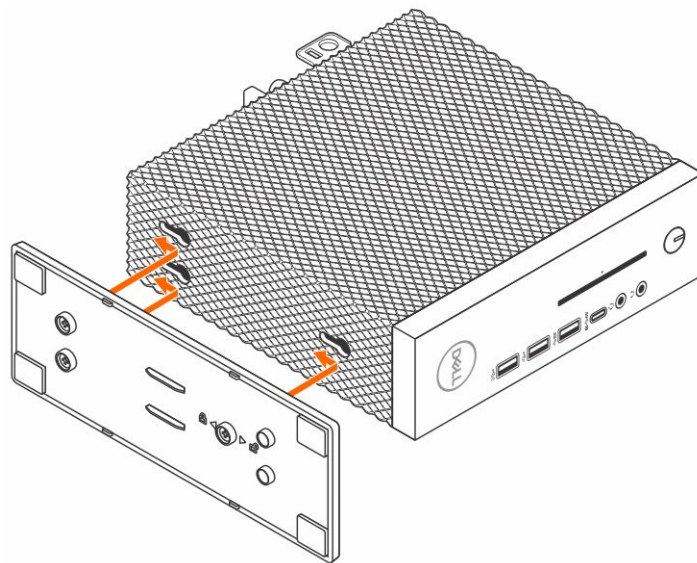

Figure 2. Install the stand

2. Connect the keyboard and mouse.

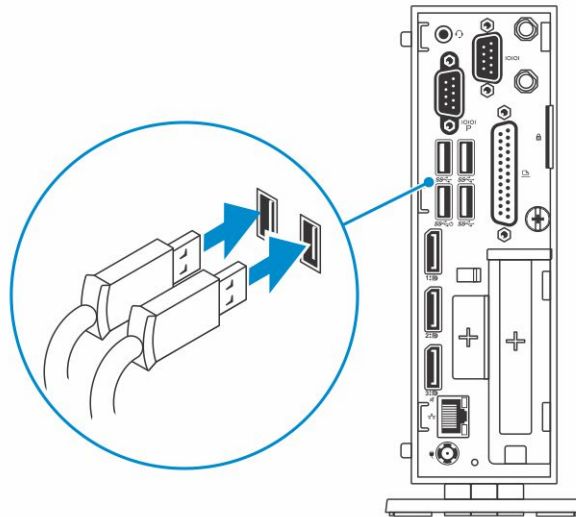

Figure 3. Install keyboard and mouse

3. Connect the network cable.

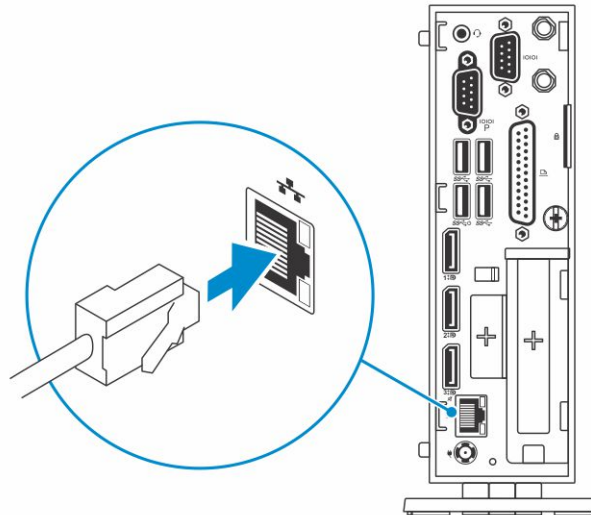

Figure 4. Connect the network cable

4. Connect the display and press the power button.

i **NOTE:** The Wyse 5070 thin client must be mounted only on a vertical orientation.

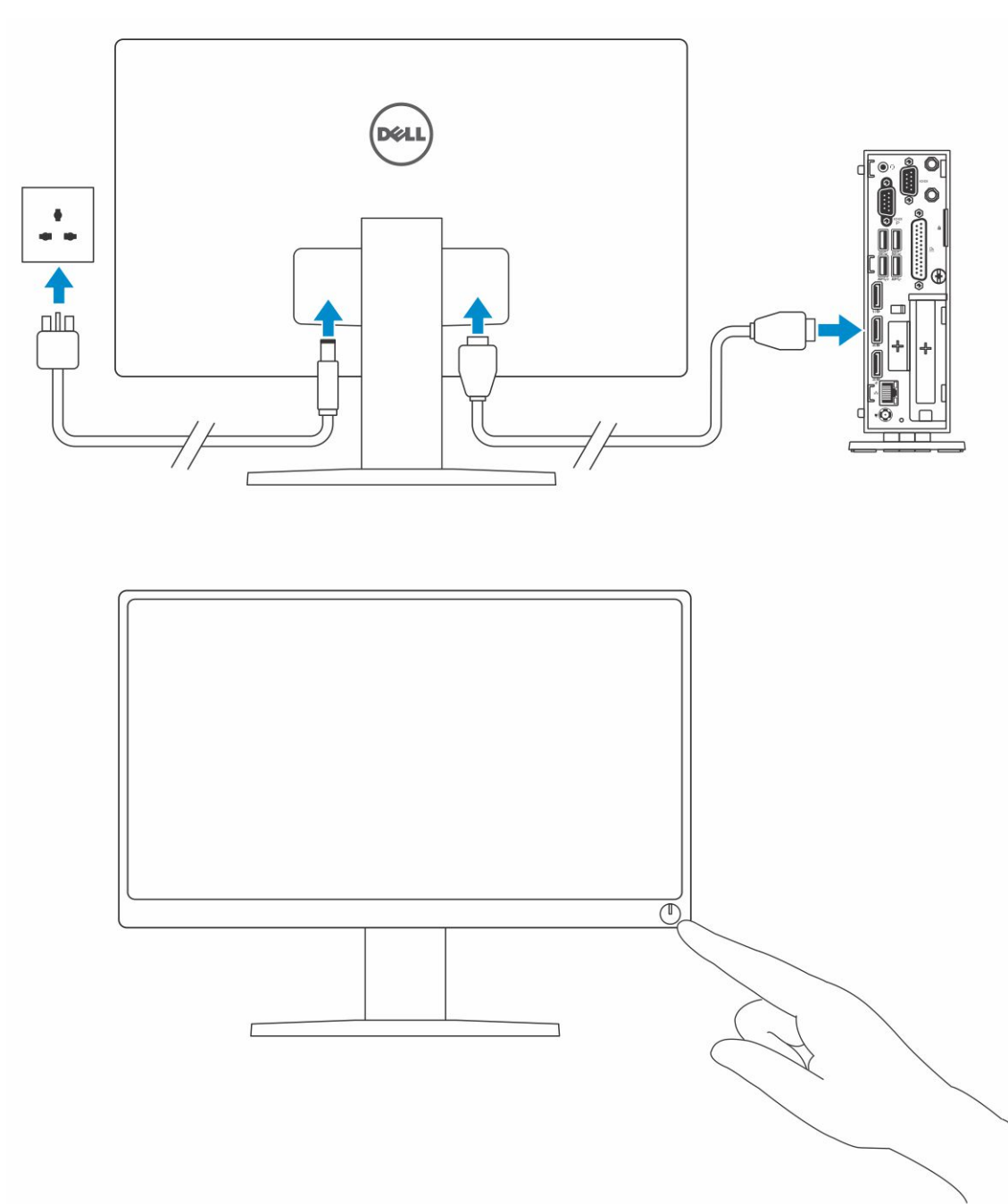

Figure 5. Connect the display

5. Connect the power cable and route the power cable through the cable clip, and press the power button.

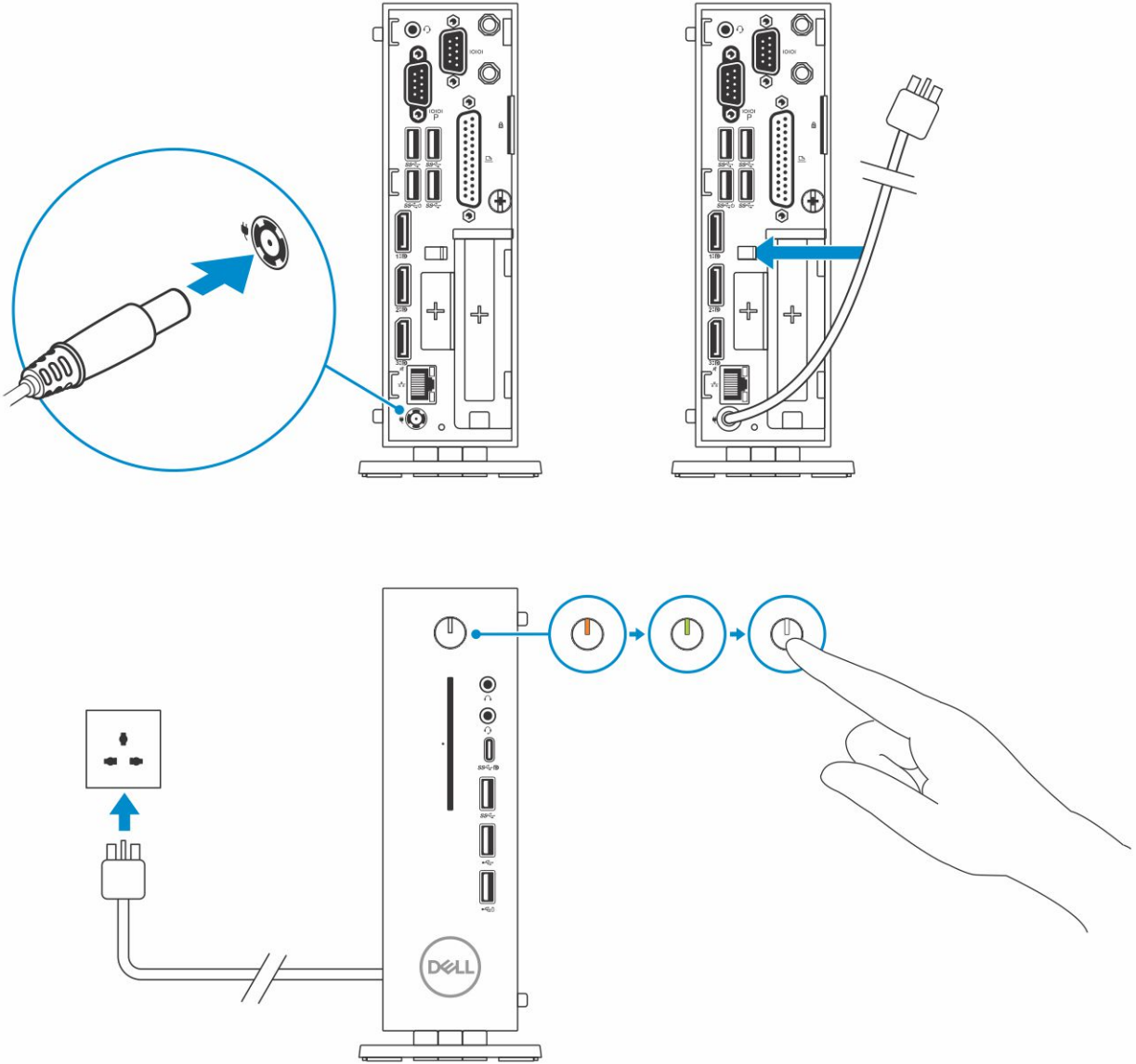



Figure 6. Connect the power cable

Before working on your thin client

You must perform the below steps before you work on the thin client.

 **NOTE:** For more safety best practices, see the Regulatory Compliance home page at www.dell.com/regulatory-compliance.

1. Save and close all open files and exit all open applications.
2. Click **Start > Power > Shut down** to shut down your thin client.

 **NOTE:** For shut down instructions, see documentation of the respective operating system.

3. Disconnect your thin client and all the attached devices from their electrical outlets.
4. Disconnect all network cables from your thin client.
5. Disconnect all attached devices and peripherals, such as keyboard, mouse, and monitor, from your thin client.

After working on your thin client

NOTE: You must not leave the stray or loose the screws inside your thin client. This may damage your thin client.

1. Reinstall all the screws and ensure that no stray screws remain inside your thin client.
2. Connect any external devices, peripherals, or cables you removed before working on your thin client.
3. Connect your thin client and all attached devices to their electrical outlets.
4. Turn on your thin client.

Removing and installing components

This section provides detailed information about how to remove or install the chassis and memory module of your thin client.

Topics:

- [Safety instructions](#)
- [Before working on your thin client](#)
- [Safety precautions](#)
- [After working on your thin client](#)
- [Recommended tools](#)
- [Screw size list](#)
- [Chassis cover](#)
- [PCIe module](#)
- [Coin-cell battery](#)
- [Solid-state drive](#)
- [Expansion module](#)
- [Wireless card](#)
- [CAC reader](#)
- [Memory](#)
- [Speaker and power button](#)
- [Serial and parallel port](#)
- [Heat sink](#)
- [System board](#)

Safety instructions

Use the following safety guidelines to protect your thin client from potential damage and to ensure your personal safety. Unless otherwise noted, each procedure included in this document assumes that the following conditions exist:

- You have read the safety information that shipped with your thin client.
- A component can be replaced or, if purchased separately, installed by performing the removal procedure in reverse order.

 **WARNING:** Disconnect all power sources before opening the thin client cover or panels. After you finish working inside the computer, replace all covers, panels, and screws before connecting to the electrical outlet.

 **NOTE:** Before working on your thin client, read the safety information that shipped with your thin client. For additional safety best practices information, see the Regulatory Compliance home page at www.Dell.com/regulatory_compliance.

 **CAUTION:** Many repairs may only be done by a certified service technician. You should only perform troubleshooting and simple repairs as authorized in your product documentation, or as directed by the online or telephone service and support team. Damage due to servicing that is not authorized by Dell is not covered by your warranty. Read and follow the safety instructions that ship with the product.

 **CAUTION:** To avoid electrostatic discharge, ground yourself by using a wrist grounding strap or by periodically touching an unpainted metal surface at the same time as touching a connector on the back of the thin client.

 **CAUTION:** Handle components and cards with care. Do not touch the components or contacts on a card. Hold a card by its edges or by its metal mounting bracket. Hold a component such as a processor by its edges, not by its pins.

 **CAUTION:** When you disconnect a cable, pull on its connector or on its pull-tab, not on the cable itself. Some cables have connectors with locking tabs; if you are disconnecting this type of cable, press in on the locking tabs before you disconnect the cable. As you pull connectors apart, keep them evenly aligned to avoid bending

any connector pins. Also, before you connect a cable, ensure that both connectors are correctly oriented and aligned.

i | **NOTE:** The color of your thin client and certain components may appear differently than shown in this document.

Before working on your thin client

You must perform the below steps before you work on the thin client.

i | **NOTE:** For more safety best practices, see the Regulatory Compliance home page at www.dell.com/regulatory-compliance.

1. Save and close all open files and exit all open applications.
2. Click **Start > Power > Shut down** to shut down your thin client.

i | **NOTE:** For shut down instructions, see documentation of the respective operating system.

3. Disconnect your thin client and all the attached devices from their electrical outlets.
4. Disconnect all network cables from your thin client.
5. Disconnect all attached devices and peripherals, such as keyboard, mouse, and monitor, from your thin client.

Safety precautions

The safety precautions chapter details the primary steps to be taken before performing any disassembly instructions.

Observe the following safety precautions before you perform any installation or break/fix procedures involving disassembly or reassembly:

- Turn off the system and all attached peripherals.
- Disconnect the system and all attached peripherals from AC power.
- Disconnect all network cables, telephone, and telecommunications lines from the system.
- Use an ESD field service kit when working on thin client to avoid electrostatic discharge (ESD) damage.
- After removing any system component, carefully place the removed component on an anti-static mat.
- Wear shoes with non-conductive rubber soles to reduce the chance of getting electrocuted.

Standby power

Dell products with standby power must be unplugged before you open the case. Systems that incorporate standby power are essentially powered while turned off. The internal power enables the system to be remotely turned on (wake on LAN) and suspended into a sleep mode and has other advanced power management features.

Unplugging, pressing and holding the power button for 15 seconds should discharge residual power in the system board, remove the battery from the thin client.

Bonding

Bonding is a method for connecting two or more grounding conductors to the same electrical potential. This is done through the use of a field service electrostatic discharge (ESD) kit. When connecting a bonding wire, ensure that it is connected to bare metal and never to a painted or non-metal surface. The anti-static wrist strap should be secure and in full contact with your skin, and ensure that you remove all jewelry such as watches, bracelets, or rings prior to bonding yourself and the equipment.

Electrostatic discharge—ESD protection

ESD is a major concern when you handle electronic components, especially sensitive components such as expansion cards, processors, memory DIMMs, and system boards. Very slight charges can damage circuits in ways that may not be obvious, such as intermittent problems or a shortened product life span. As the industry pushes for lower power requirements and increased density, ESD protection is an increasing concern.

Due to the increased density of semiconductors used in recent Dell products, the sensitivity to static damage is now higher than in previous Dell products. For this reason, some previously approved methods of handling parts are no longer applicable.

Two recognized types of ESD damage are catastrophic and intermittent failures.

- **Catastrophic**—Catastrophic failures represent approximately 20 percent of ESD-related failures. The damage causes an immediate and complete loss of device functionality. An example of catastrophic failure is a memory DIMM that has received a static shock and immediately generates a "No POST/No Video" symptom with a beep code emitted for missing or nonfunctional memory.
- **Intermittent**—Intermittent failures represent approximately 80 percent of ESD-related failures. The high rate of intermittent failures means that most of the time when damage occurs, it is not immediately recognizable. The DIMM receives a static shock, but the tracing is merely weakened and does not immediately produce outward symptoms related to the damage. The weakened trace may take weeks or months to melt, and in the meantime may cause degradation of memory integrity, intermittent memory errors, etc.

The more difficult type of damage to recognize and troubleshoot is the intermittent (also called latent or "walking wounded") failure.

Perform the following steps to prevent ESD damage:

- Use a wired anti-static wrist strap that is properly grounded. The use of wireless anti-static wrist straps is no longer allowed because they do not provide adequate protection. Touching the chassis before handling parts does not ensure adequate ESD protection on parts with increased sensitivity to ESD damage.
- Handle all static-sensitive components in a static-safe area. If possible, use anti-static floor pads and workbench pads.
- When unpacking a static-sensitive component from its shipping carton, do not remove the component from the anti-static packing material until you are ready to install the component. Before unwrapping the anti-static packaging, ensure that you discharge static electricity from your body.
- Before transporting a static-sensitive component, place it in an anti-static container or packaging.

ESD field service kit

The unmonitored Field Service kit is the most commonly used service kit. Each Field Service kit includes three main components: anti-static mat, anti-static wrist strap, and bonding wire.

Components of an ESD field service kit

The components of an ESD field service kit are:

- **Anti-static mat**—The anti-static mat is dissipative and parts can be placed on it during service procedures. When using an anti-static mat, your anti-static wrist strap should be snug and the bonding wire should be connected to the mat and to any bare metal on the system being worked on. Once deployed properly, service parts can be removed from the ESD bag and placed directly on the mat. ESD-sensitive items are safe in your hand, on the ESD mat, in the system, or inside a bag.
- **Anti-static wrist strap and bonding wire**—The anti-static wrist strap and bonding wire can be either directly connected between your wrist and bare metal on the hardware if the ESD mat is not required, or connected to the anti-static mat to protect hardware that is temporarily placed on the mat. The physical connection of the anti-static wrist strap and bonding wire between your skin, the ESD mat, and the hardware is known as bonding. Use only Field Service kits with an anti-static wrist strap, mat, and bonding wire. Never use wireless anti-static wrist straps. Always be aware that the internal wires of a anti-static wrist strap are prone to damage from normal wear and tear, and must be checked regularly with a anti-static wrist strap tester in order to avoid accidental ESD hardware damage. It is recommended to test the anti-static wrist strap and bonding wire at least once per week.
- **ESD wrist strap tester**—The wires inside of an ESD strap are prone to damage over time. When using an unmonitored kit, it is a best practice to regularly test the strap prior to each service call, and at a minimum, test once per week. A wrist strap tester is the best method for doing this test. If you do not have your own wrist strap tester, check with your regional office to find out if they have one. To perform the test, plug the wrist-strap's bonding-wire into the tester while it is strapped to your wrist and push the button to test. A green LED is lit if the test is successful; a red LED is lit and an alarm sounds if the test fails.
- **Insulator Elements** —It is critical to keep ESD sensitive devices, such as plastic heat sink casings, away from internal parts that are insulators and often highly charged.
- **Working Environment** – Before deploying the ESD Field Service kit, assess the situation at the customer location. For example, deploying the kit for a server environment is different than for a desktop or portable environment. Servers are typically installed in a rack within a data center; desktops or portables are typically placed on office desks or cubicles. Always look for a large open flat work area that is free of clutter and large enough to deploy the ESD kit with additional space to accommodate the type of system that is being repaired. The workspace should also be free of insulators that can cause an ESD event. On the work area, insulators such as Styrofoam and other plastics should always be moved at least 12 inches or 30 centimeters away from sensitive parts before physically handling any hardware components

- **ESD Packaging** – All ESD-sensitive devices must be shipped and received in static-safe packaging. Metal, static-shielded bags are preferred. However, you should always return the damaged part using the same ESD bag and packaging that the new part arrived in. The ESD bag should be folded over and taped shut and all the same foam packing material should be used in the original box that the new part arrived in. ESD-sensitive devices should be removed from packaging only at an ESD-protected work surface, and parts should never be placed on top of the ESD bag because only the inside of the bag is shielded. Always place parts in your hand, on the ESD mat, in the system, or inside an anti-static bag.
- **Transporting Sensitive Components** – When transporting ESD sensitive components such as replacement parts or parts to be returned to Dell, it is critical to place these parts in anti-static bags for safe transport.

ESD protection summary

It is recommended that all field service technicians use the traditional wired ESD grounding anti-static wrist strap and protective anti-static mat at all times when servicing Dell products. In addition, it is critical that technicians keep sensitive parts separate from all insulator parts while performing service and that they use anti-static bags for transporting sensitive components.

Transporting sensitive components

When transporting ESD sensitive components such as replacement parts or parts to be returned to Dell, it is critical to place these parts in anti-static bags for safe transport.

Lifting equipment

Adhere to the following guidelines when lifting heavy weight equipment:

 **CAUTION: Do not lift greater than 50 pounds. Always obtain additional resources or use a mechanical lifting device.**

1. Get a firm balanced footing. Keep your feet apart for a stable base, and point your toes out.
2. Tighten stomach muscles. Abdominal muscles support your spine when you lift, offsetting the force of the load.
3. Lift with your legs, not your back.
4. Keep the load close. The closer it is to your spine, the less force it exerts on your back.
5. Keep your back upright, whether lifting or setting down the load. Do not add the weight of your body to the load. Avoid twisting your body and back.
6. Follow the same techniques in reverse to set the load down.

After working on your thin client

 **NOTE:** You must not leave the stray or loose the screws inside your thin client. This may damage your thin client.

1. Reinstall all the screws and ensure that no stray screws remain inside your thin client.
2. Connect any external devices, peripherals, or cables you removed before working on your thin client.
3. Connect your thin client and all attached devices to their electrical outlets.
4. Turn on your thin client.

Recommended tools

The procedures in this document require the following tools:

- Phillips head screwdrivers: #0, #1, and #2
- Plastic scribe



Screw size list

This section provides the detailed information about the screws available in the thin client.

Table 1. Screw size list

Components	Secured to	Screw type	Quantity	Screw image
Cover	Chassis	#632 x¼"	1	
VGA	Chassis	M3x3.5	2	
Serial and parallel	Chassis	#4-40 x 0.44"	4	
CAC reader	Chassis and system board	M3x3.5	2	
System board	Chassis	M3x3	1	
Speaker and power button	System board	M3x3.5	1	
Wireless card	WiFi holder	M2x3.5	1	

Table 1. Screw size list (continued)

Components	Secured to	Screw type	Quantity	Screw image
Solid-state drive	System board	M2x3.5	1	
Heat sink	System board	M3x17.5	4	
System board	Chassis	M3x5	4	

Chassis cover

Chassis cover provides security for the entire thin client and also helps in maintaining proper air flow inside the thin client.

Remove the chassis cover

Procedure

1. Follow the procedure in [Before working inside your thin client](#).
2. Loosen the thumb screw that secures the chassis cover to the thin client.

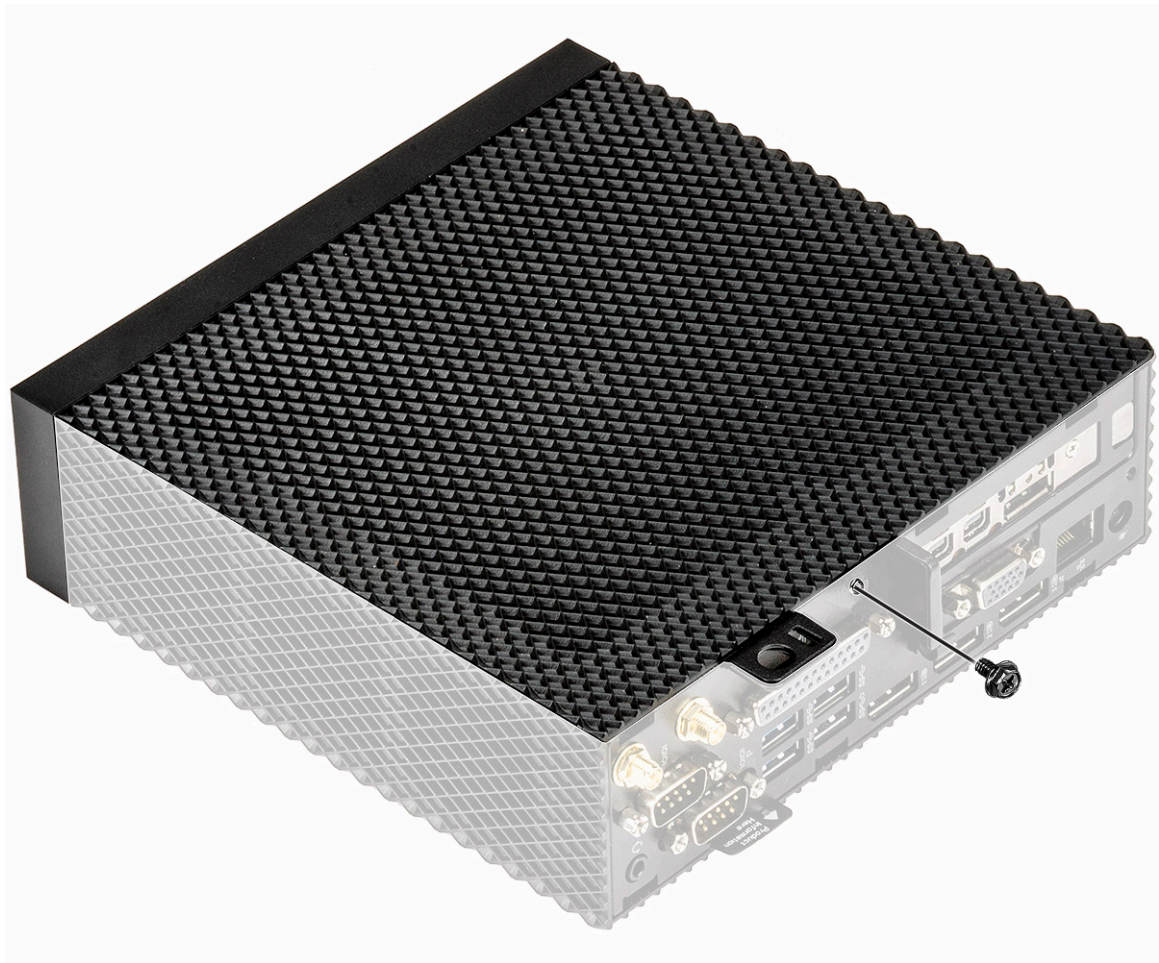

Figure 7. Loosen the thumb screw

3. Slide the cover towards the front of the system to disengage the tabs from the guide slots on the thin client.

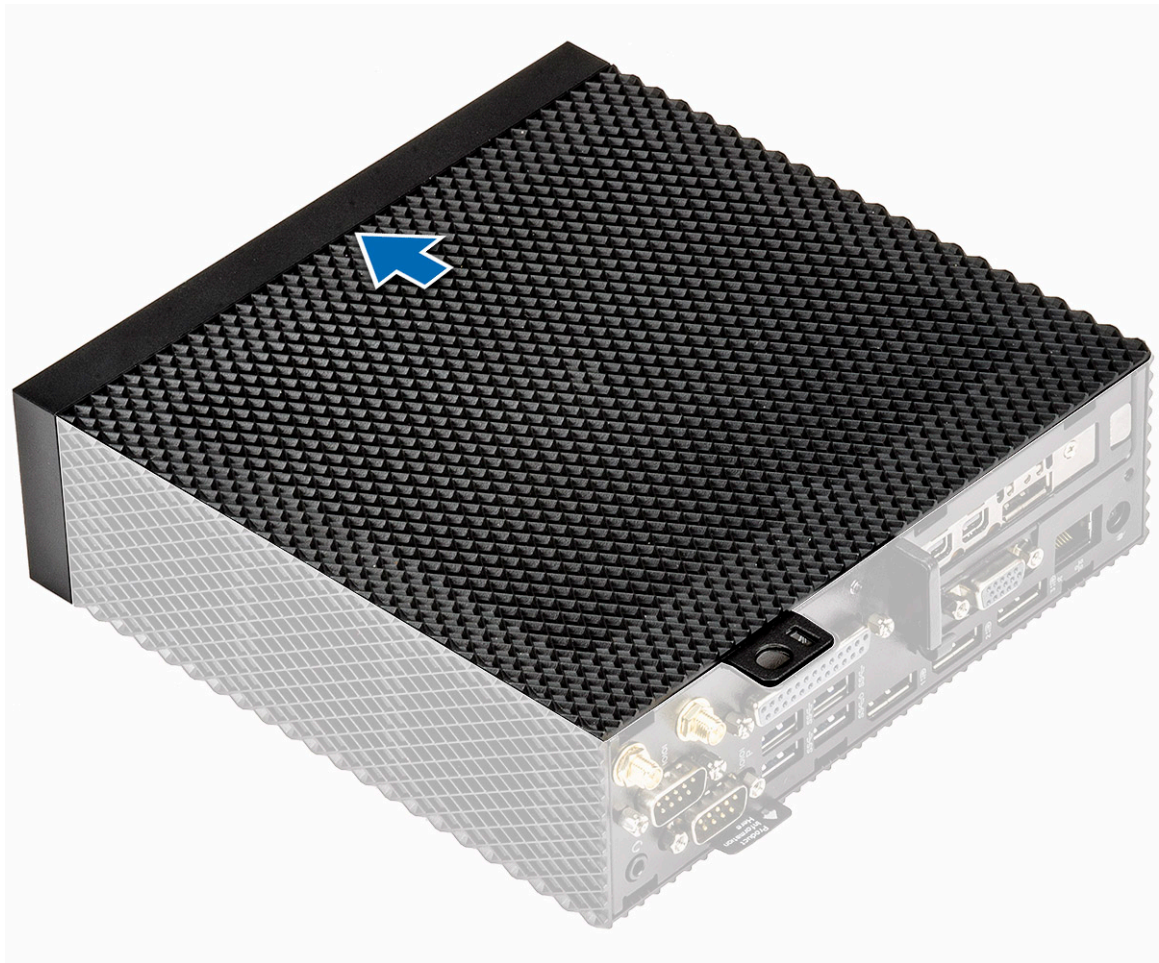

Figure 8. Slide the cover

4. Lift the cover away from the thin client.

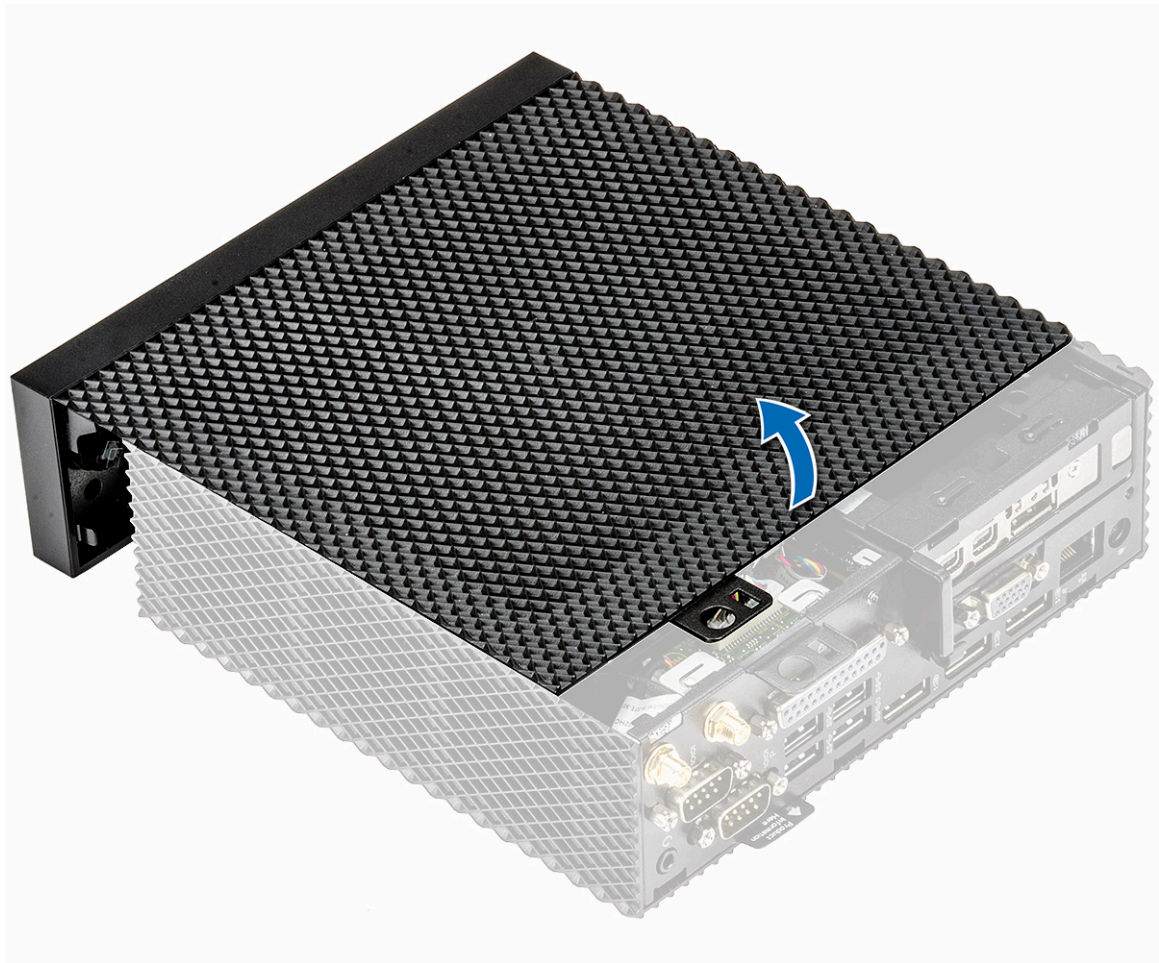

Figure 9. Lift the cover

Install the chassis cover

Procedure

1. Align the tabs on the chassis cover with the guide slots on the thin client.

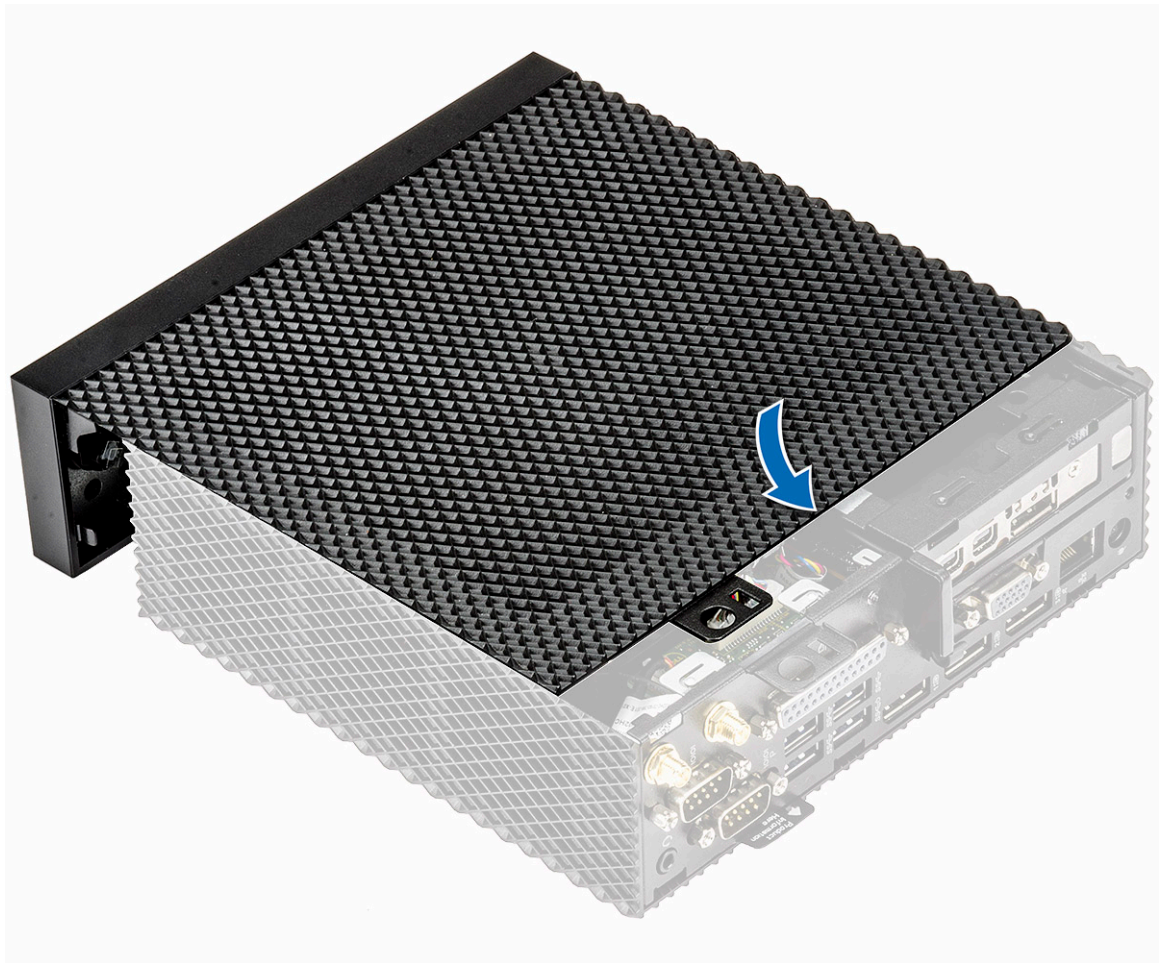

Figure 10. Align the tabs

2. Slide the cover until the tabs snap into place.

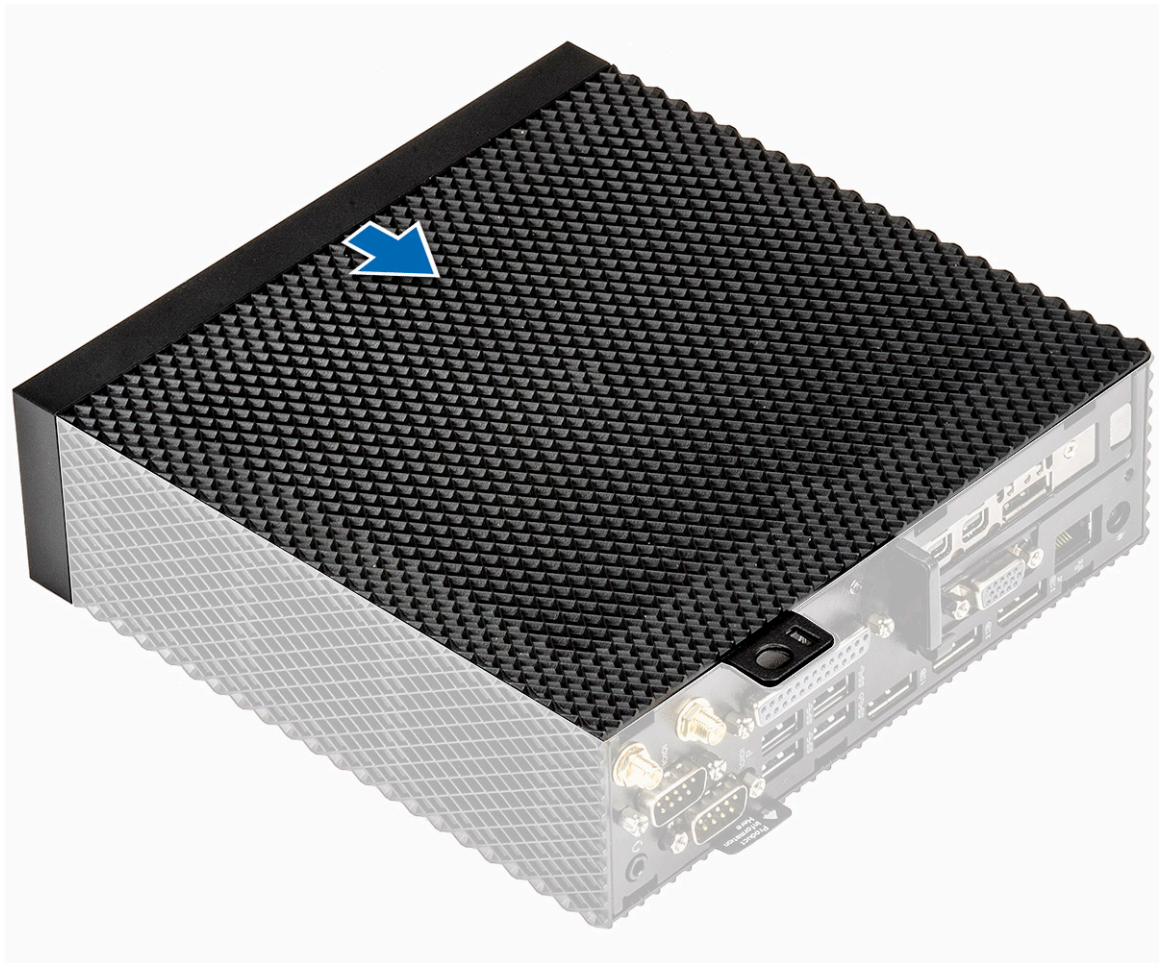

Figure 11. Slide the cover

3. Tighten the thumb screw to secure the chassis cover to the thin client.

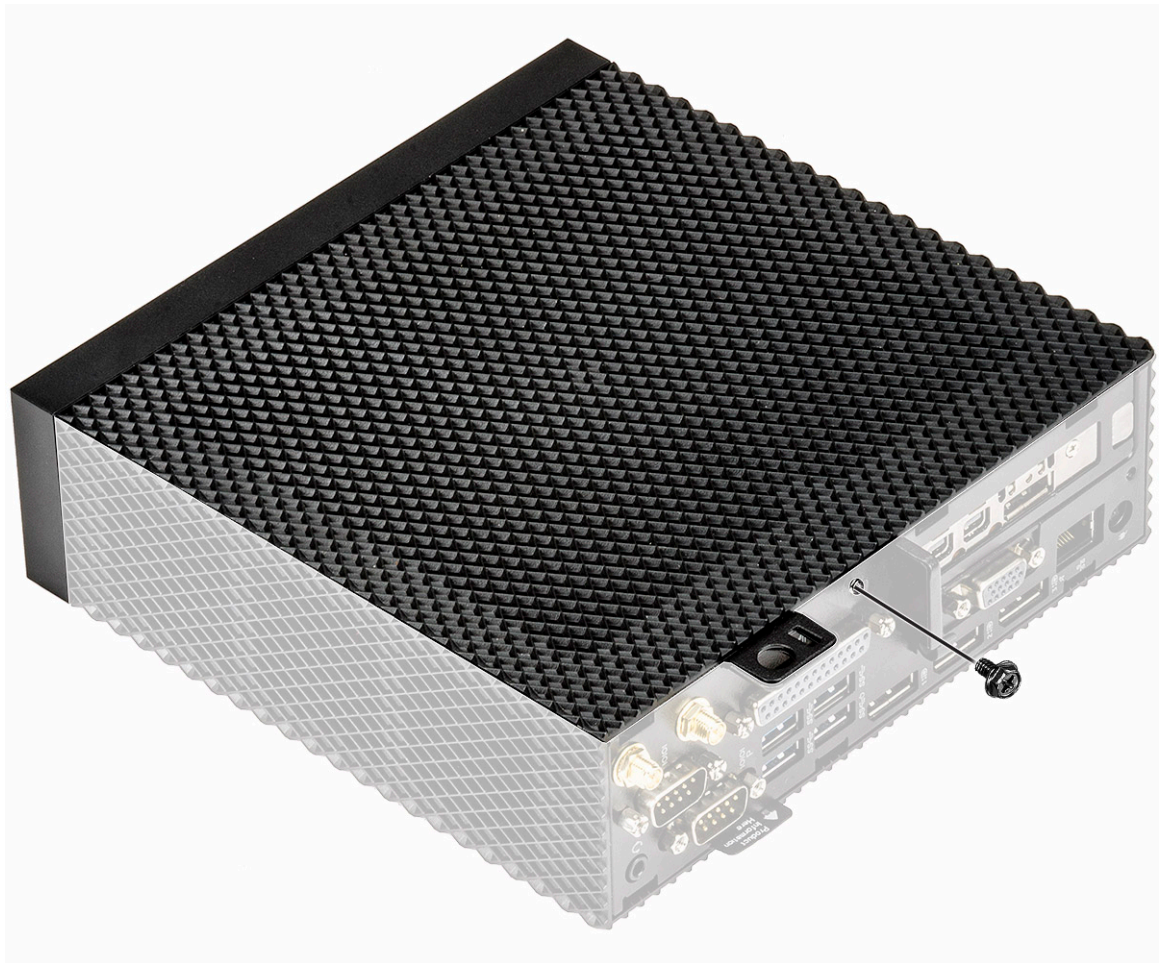

Figure 12. Tighten the thumb screw

4. Follow the procedure in [After working inside your thin client.](#)

PCIe module

The PCIe module is a high-speed serial replacement of the older PCI/PCI-X bus. PCIe uses a shared parallel bus architecture, in which the PCI host and all devices share a common set of address, data, and control lines.

Remove the PCIe module

Prerequisites

Remove the [Chassis cover](#).

Procedure

1. Follow the procedure in [Before working inside your thin client.](#)
2. Hold both ends of the PCIe module and lift the module away from the thin client.

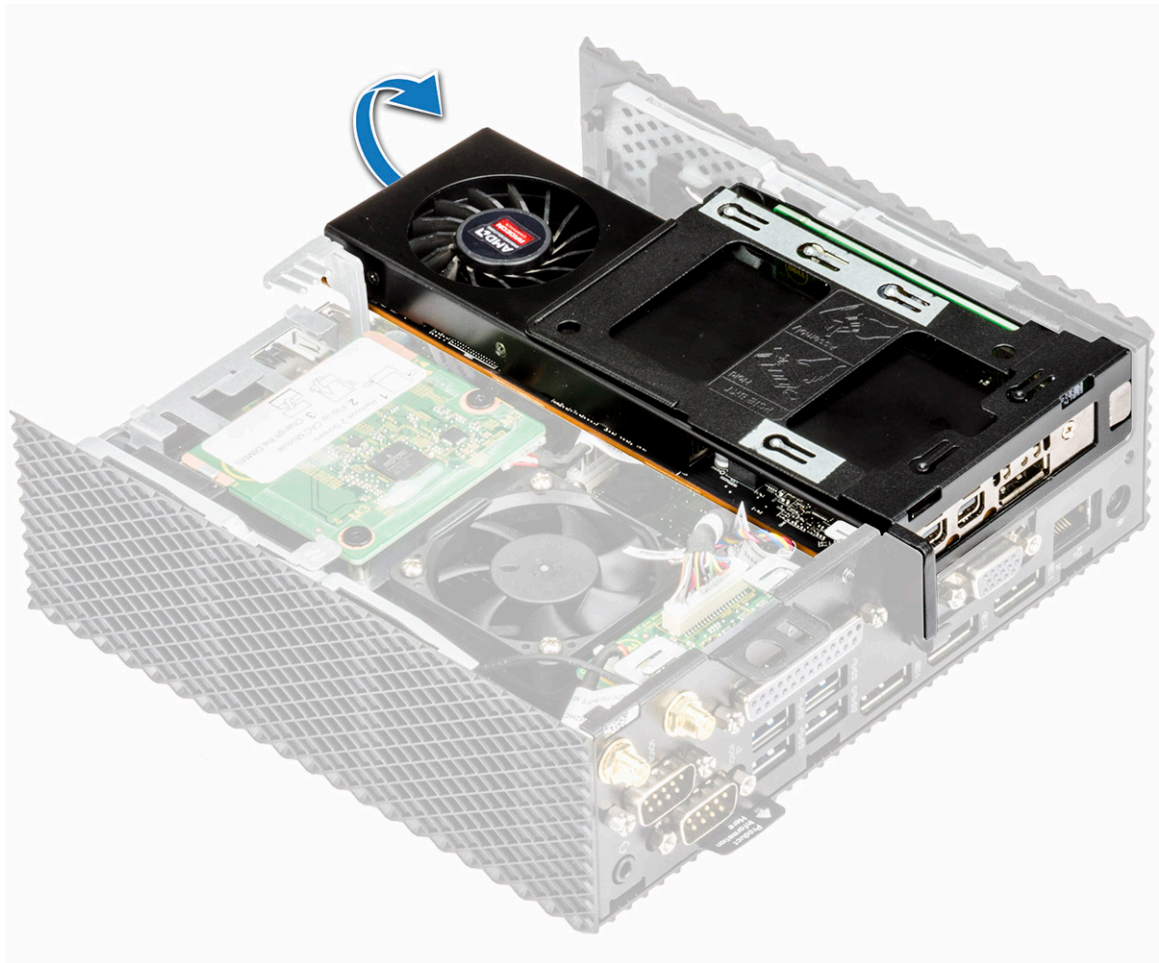

Figure 13. Remove the PCIe module

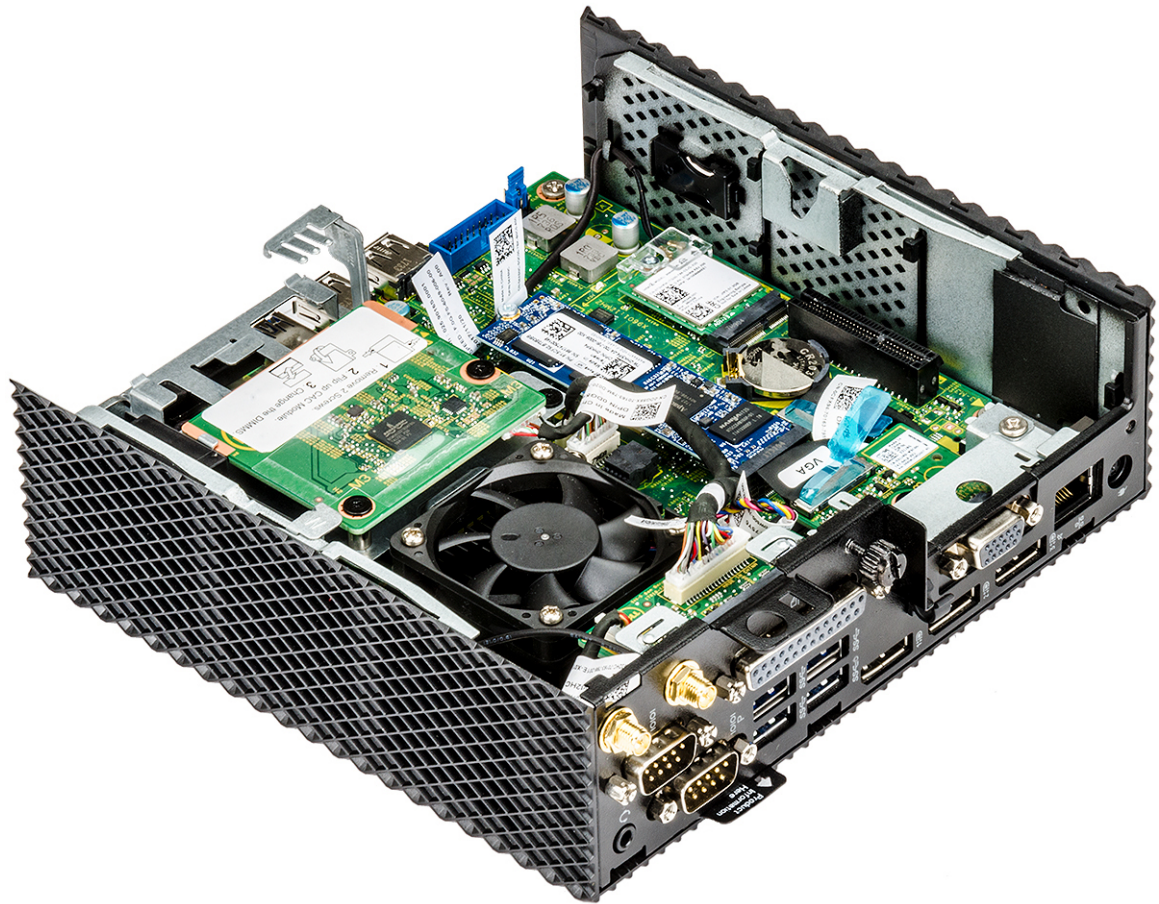

Figure 14. PCIe module is removed

Install the PCIe module

Procedure

1. Align the PCIe module with the connector on the system board.

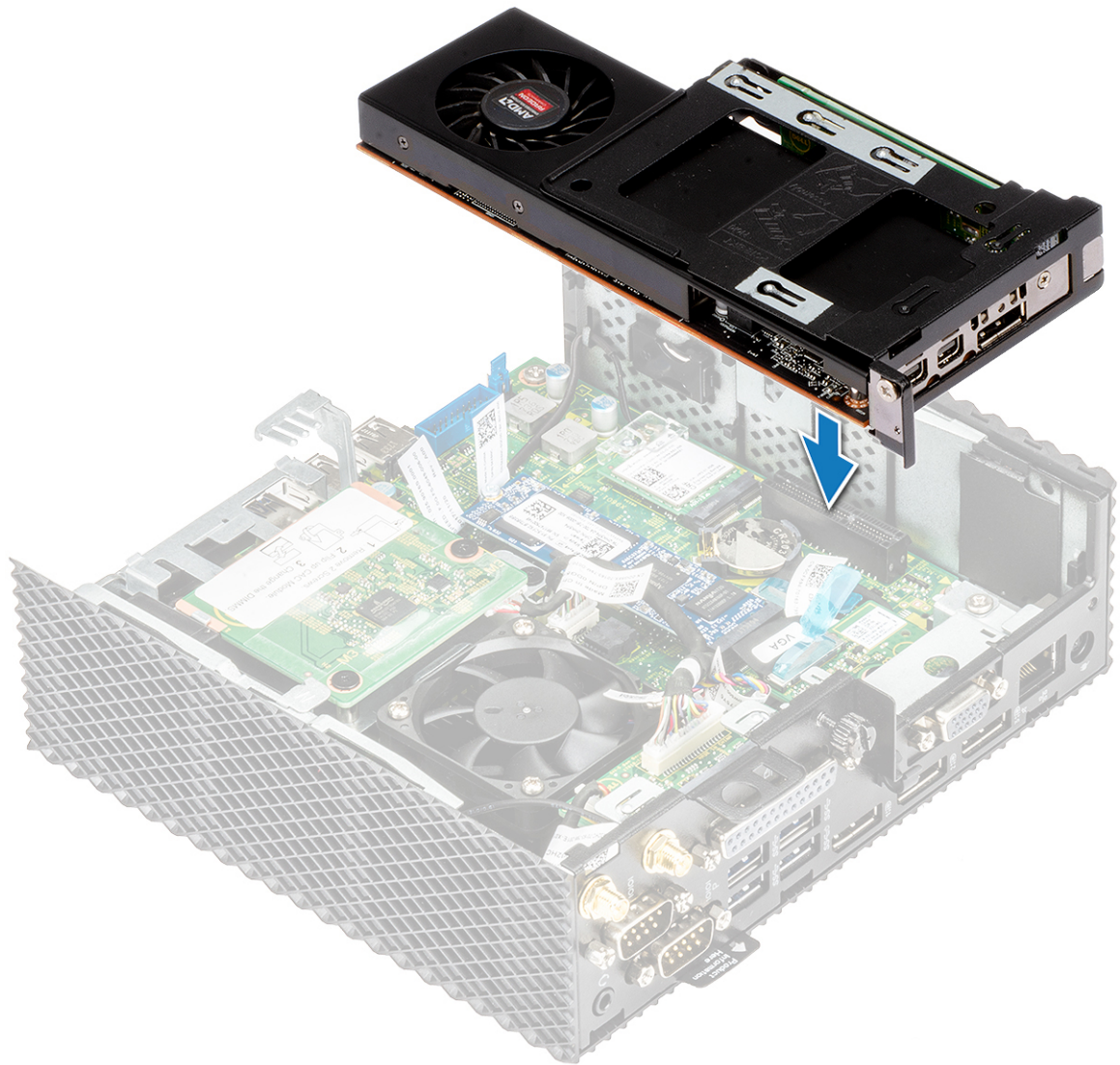

Figure 15. Align the PCIe module

2. Push down the PCIe module to secure it to the system board.



Figure 16. Push down the PCIe module

3. Follow the procedure in [After working inside your thin client](#).

Postrequisites

Replace the [Chassis cover](#).

Coin-cell battery

Coin-cell battery is used to power the thin client. The coin-cell batteries hold their charge for a long time.

Remove the coin-cell battery

Prerequisites

1. Remove the [Chassis cover](#).
2. If applicable, remove the [PCIe module](#).

Procedure

1. Follow the procedure in [Before working inside your thin client](#).
2. Pry open the coin-cell battery from the holder by using a scribe.

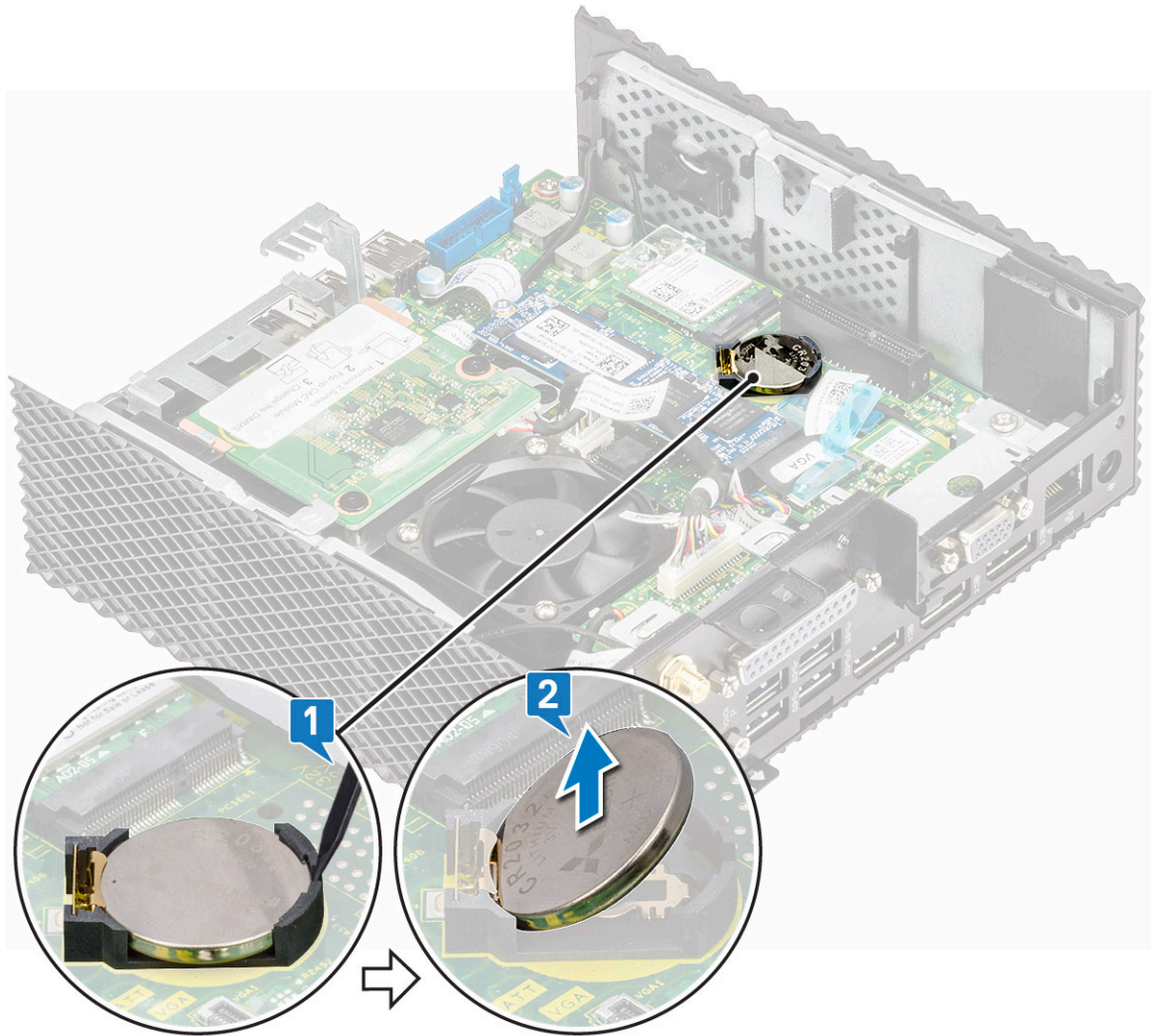

Figure 17. Remove the coin-cell battery

Install the coin-cell battery

Procedure

1. Snap the coin-cell battery in the place holder.
2. Follow the procedure in [After working inside your thin client](#).

Postrequisites

1. If applicable, replace the [PCIe module](#).
2. Replace the [Chassis cover](#).

Solid-state drive

A solid-state drive is a nonvolatile storage device that stores persistent data on solid-state flash memory.

Remove the solid-state drive

Prerequisites

1. Remove the [Chassis cover](#).
2. If applicable, remove the [PCIe module](#).

Procedure

1. Follow the procedure in [Before working inside your thin client](#).
2. Remove the screw that secures the solid-state drive to the system board.

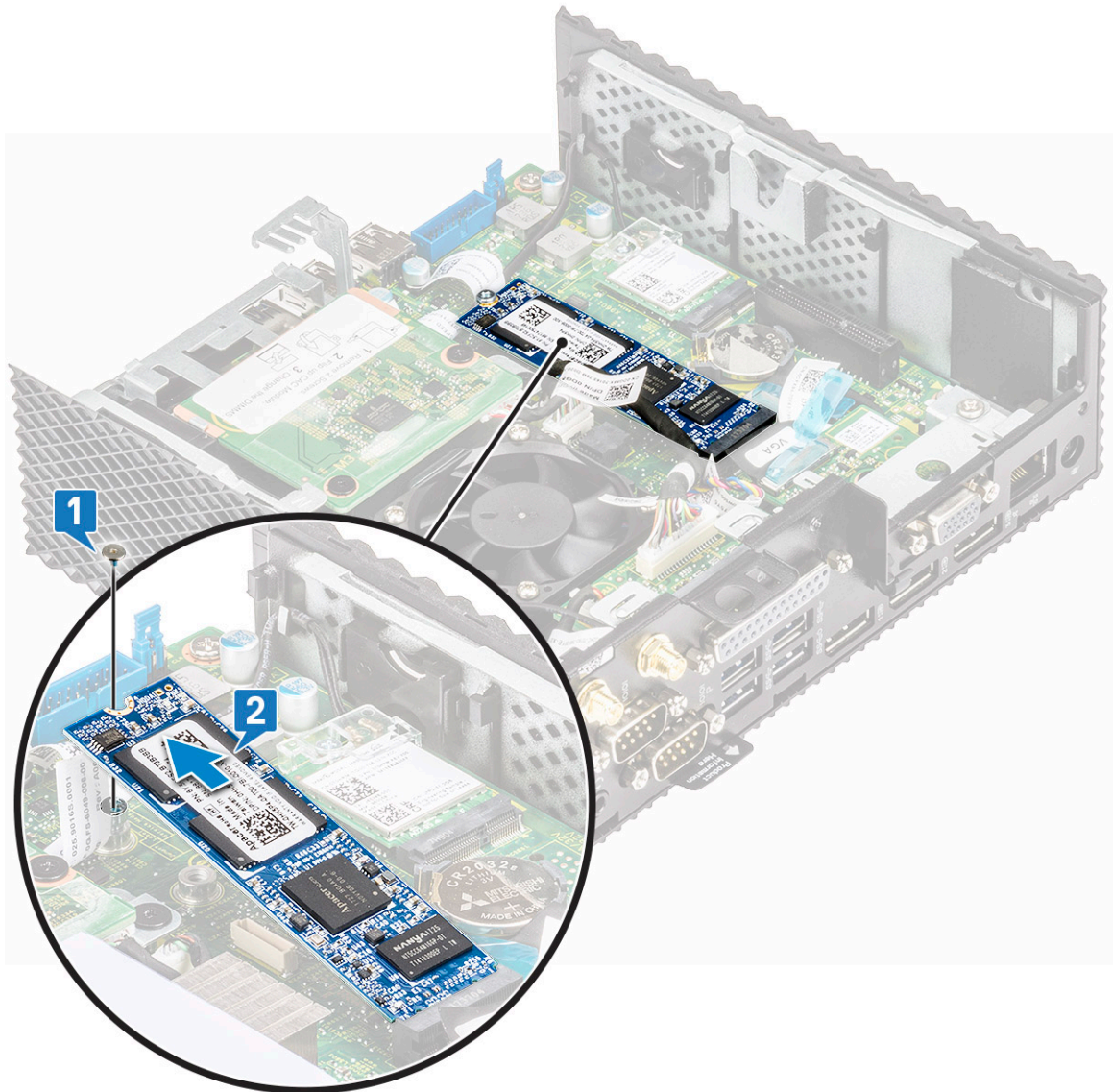

Figure 18. Remove the screw

3. Pull the solid-state drive from the solid-state drive slot on the system board.

Install the solid-state drive

Procedure

1. Align the notch on the solid-state drive with the tab on the solid-state drive slot.
2. Slide the solid-state drive into the solid-state drive slot at an angle.
3. Replace the screw that secures the solid-state drive to the system board.
4. Follow the procedure in [After working inside your thin client](#).

Postrequisites

1. If applicable, replace the [PCIe module](#).
2. Replace the [Chassis cover](#).

Expansion module

You can connect RJ45, SFP, or VGA to the thin client.

Remove the expansion module-VGA-RJ45-SFP

Prerequisites

1. Remove the [Chassis cover](#).
2. If applicable, remove the [PCIe module](#).

Procedure

1. Follow the procedure in [Before working inside your thin client](#).
2. Disconnect the VGA-RJ45-SFP cable from the system board by using the blue pull tab and lift the expansion module connector that is connected to the system board.

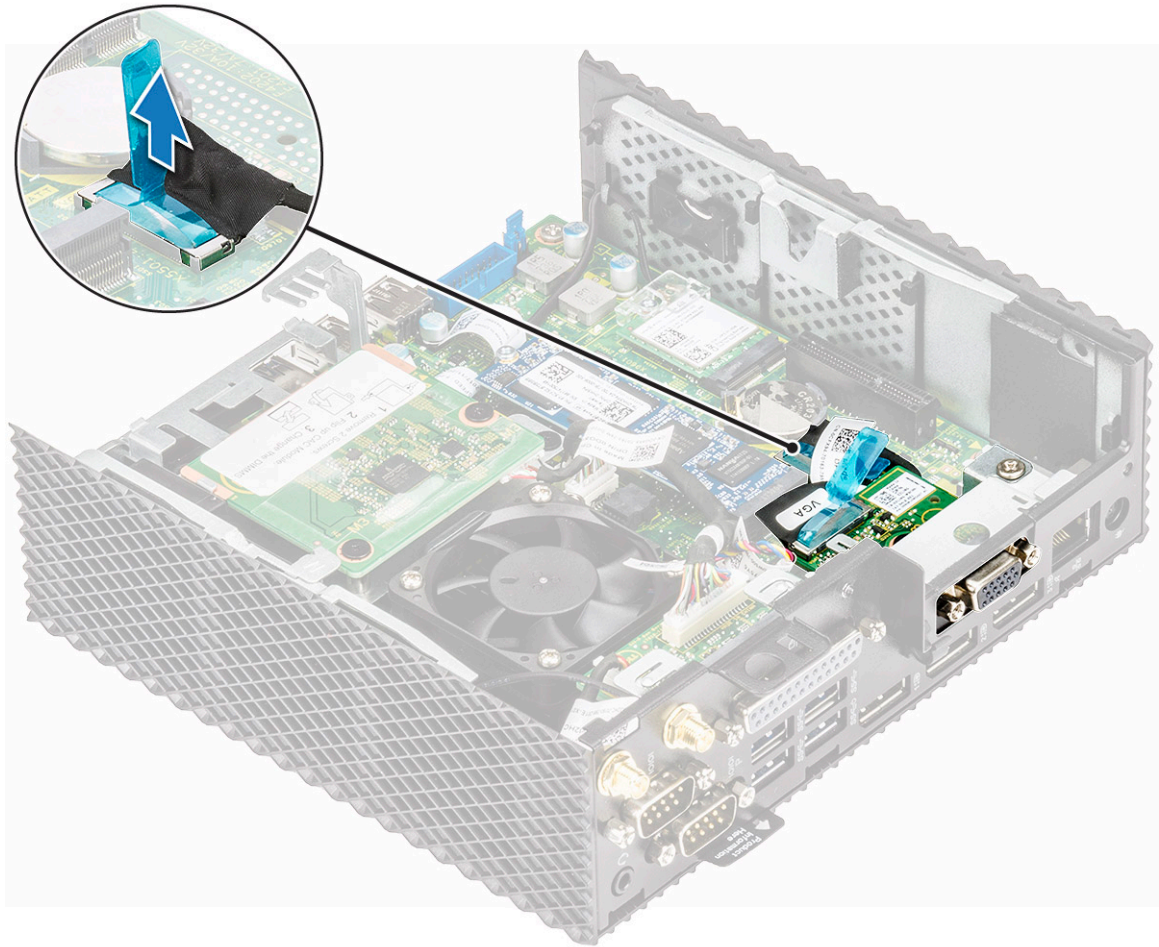

Figure 19. Disconnect the VGA-RJ45-SFP cable

3. Remove the two screws that secure the expansion module to the thin client.

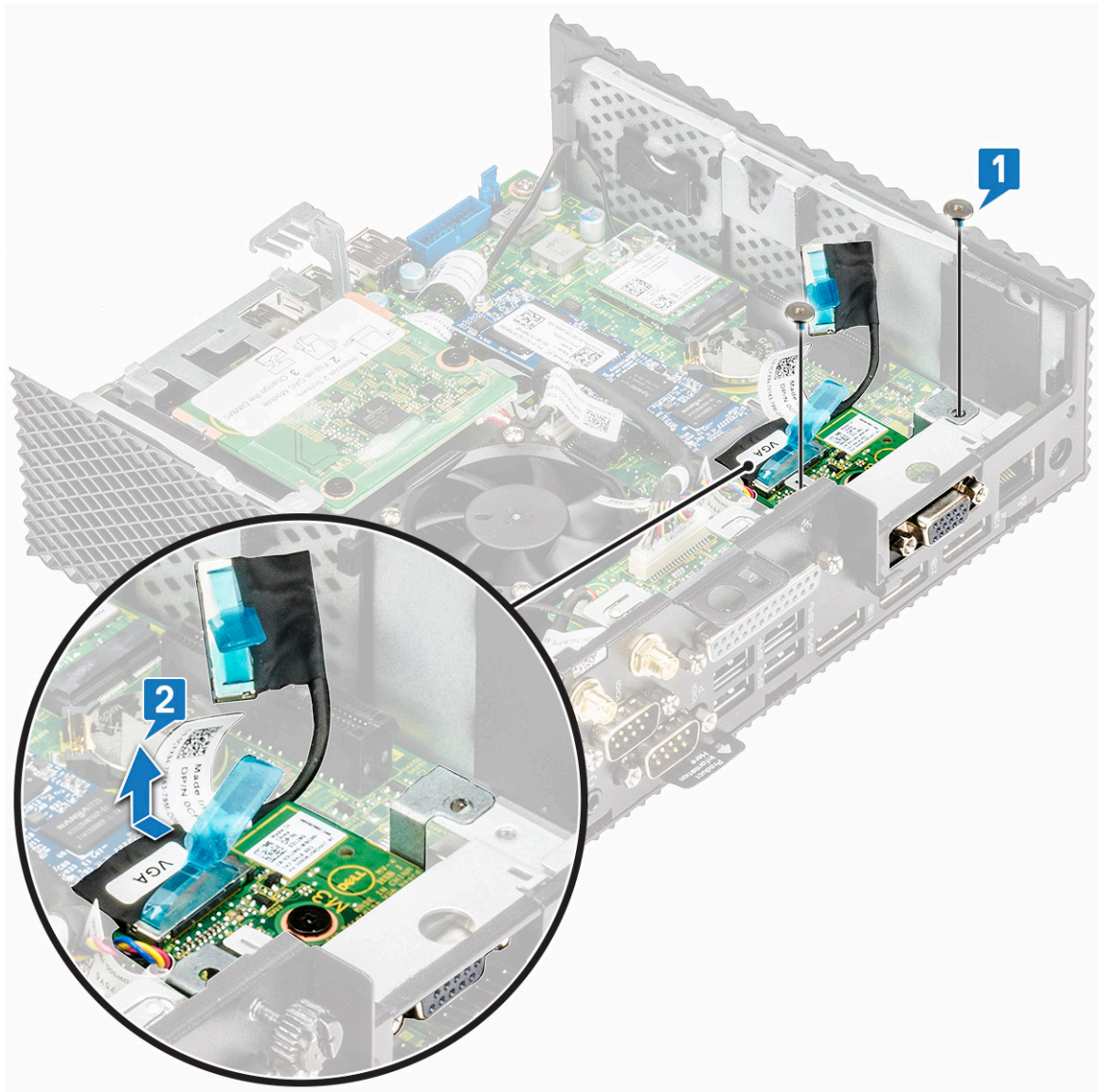

Figure 20. Remove the two screws

4. Pull the expansion module away from the chassis.

Install the expansion module-VGA-RJ45-SFP

Procedure

1. Align the screw holes on the expansion module with the screw holes on the chassis.
2. Replace the two screws that secure the expansion module to the chassis.
3. Connect the VGA/RJ45/SFP cable to the system board.
4. Follow the procedure in [After working inside your thin client](#).

Postrequisites

1. If applicable, replace the [PCIe module](#).
2. Replace the [Chassis cover](#).

Wireless card

A high-speed wireless network card is used to access network through a USB port on the thin client.

Remove the wireless card

Prerequisites

1. Remove the [Chassis cover](#).
2. If applicable, remove the [PCIe module](#).

Procedure

1. Follow the procedure in [Before working inside your thin client](#).
2. Remove the screw that secures the wireless card holder to the system

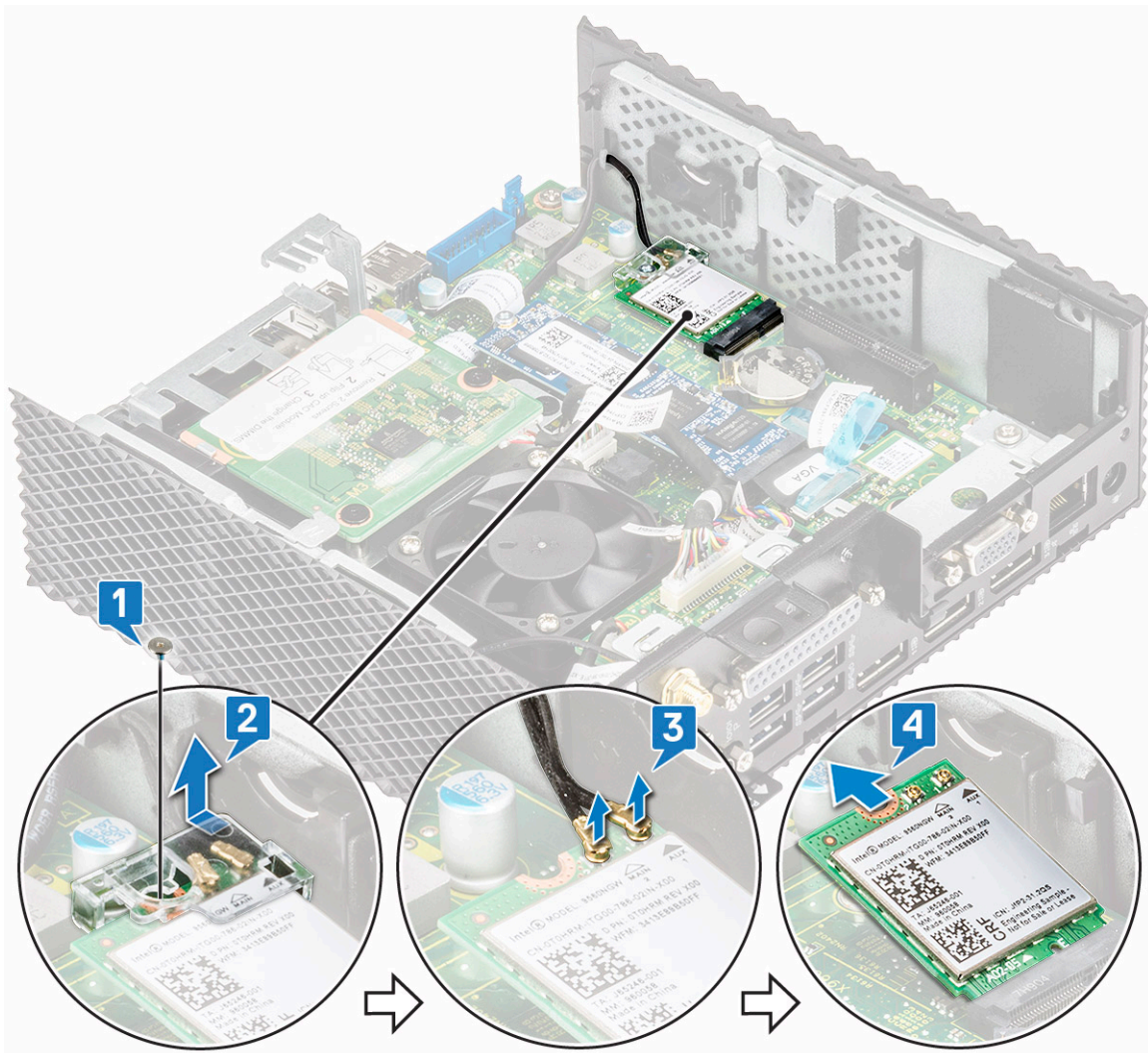

board.

3. Remove the wireless card holder off the wireless card.
4. Disconnect the antenna cables from the wireless card.
5. Slide and remove the wireless card out of the wireless card slot.

Install the wireless card

Procedure

1. Connect the antenna cables to the wireless card.
2. Align the notch on the wireless card with the tab on the wireless card slot and slide the card into the slot.
3. Replace the wireless card holder on the wireless card.
4. Replace the screw that secures the wireless card holder to the system board.
5. Follow the procedure in [After working on your thin client](#).

Postrequisites

1. If applicable, replace the [PCIe module](#).
2. Replace the [Chassis cover](#).

CAC reader

CAC reader enables to read the smart card for multi factor authentication.

Remove the CAC reader

Prerequisites

1. Remove the [Chassis cover](#).
2. If applicable, remove the [PCIe module](#).

Procedure

1. Follow the procedure in [Before working inside your thin client](#).
2. Disconnect the CAC reader cable from the system board.

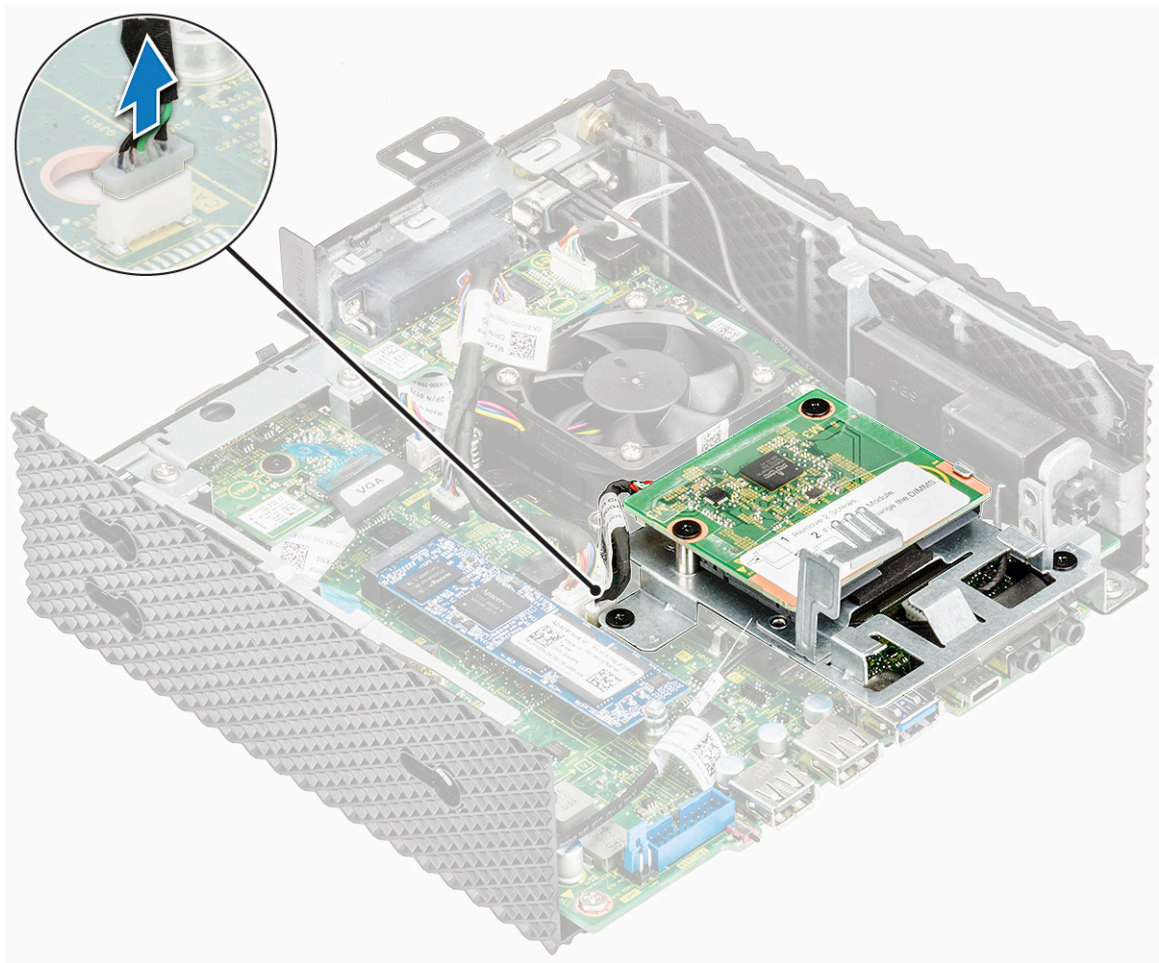

Figure 21. Disconnect the cable

3. Remove the two screws 1 and 2 that secure the CAC reader bracket to the system board and the chassis.

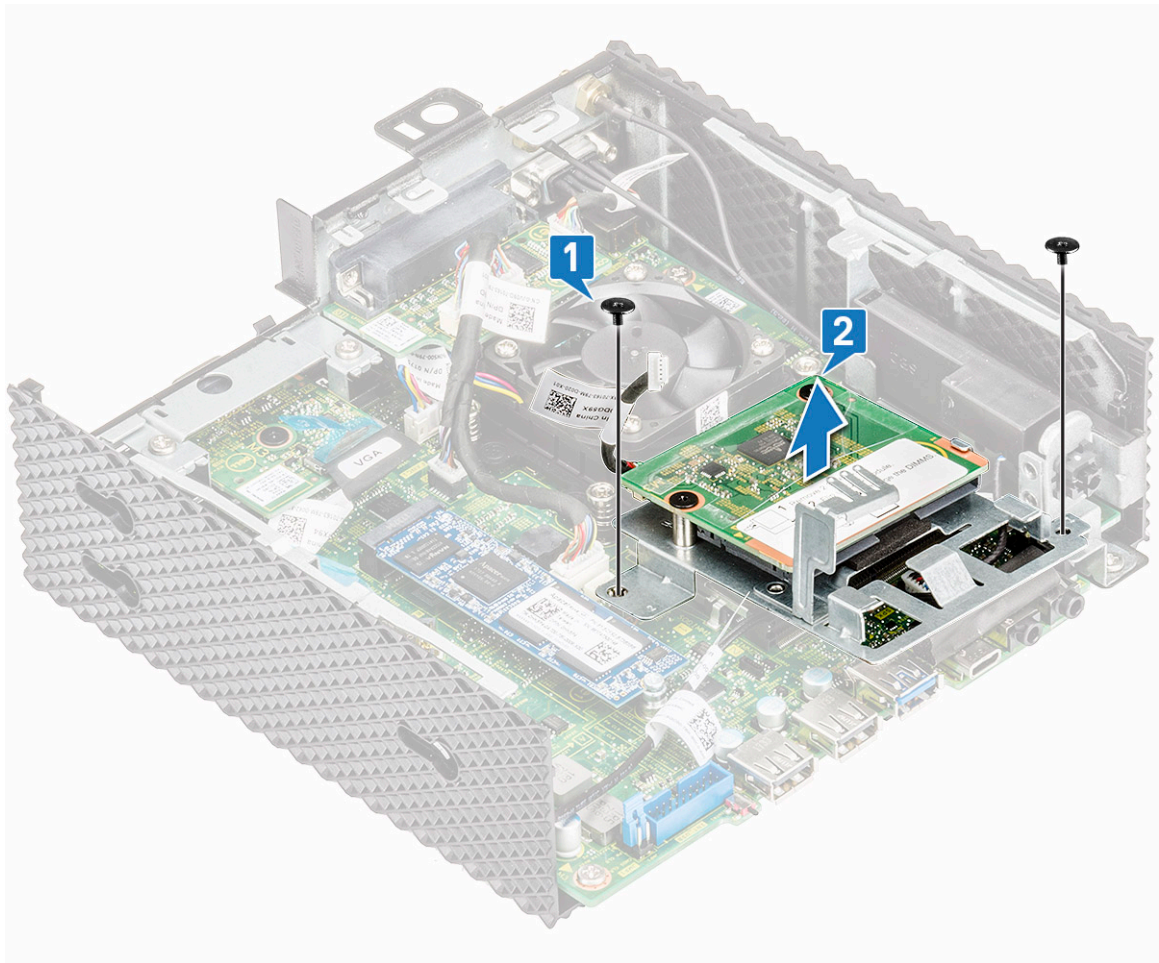

Figure 22. Remove the screws

4. Lift the CAC reader bracket away from the system board.

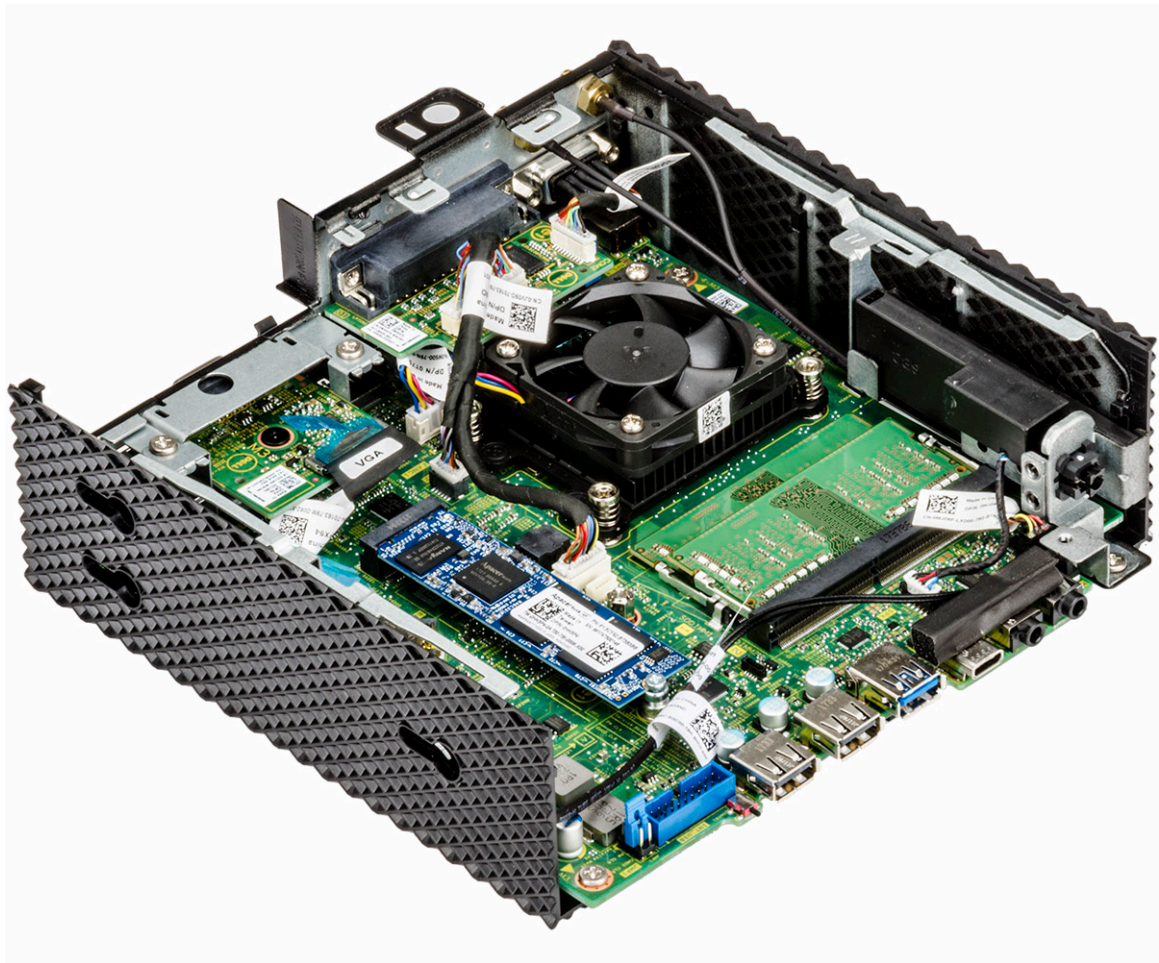

Figure 23. CAC reader is removed

Install the CAC reader

Procedure

1. Align the screw holes on the CAC reader bracket with the screw holes on the system board and chassis.
2. Replace the two screws that secure the CAC reader bracket to the system board and the chassis.

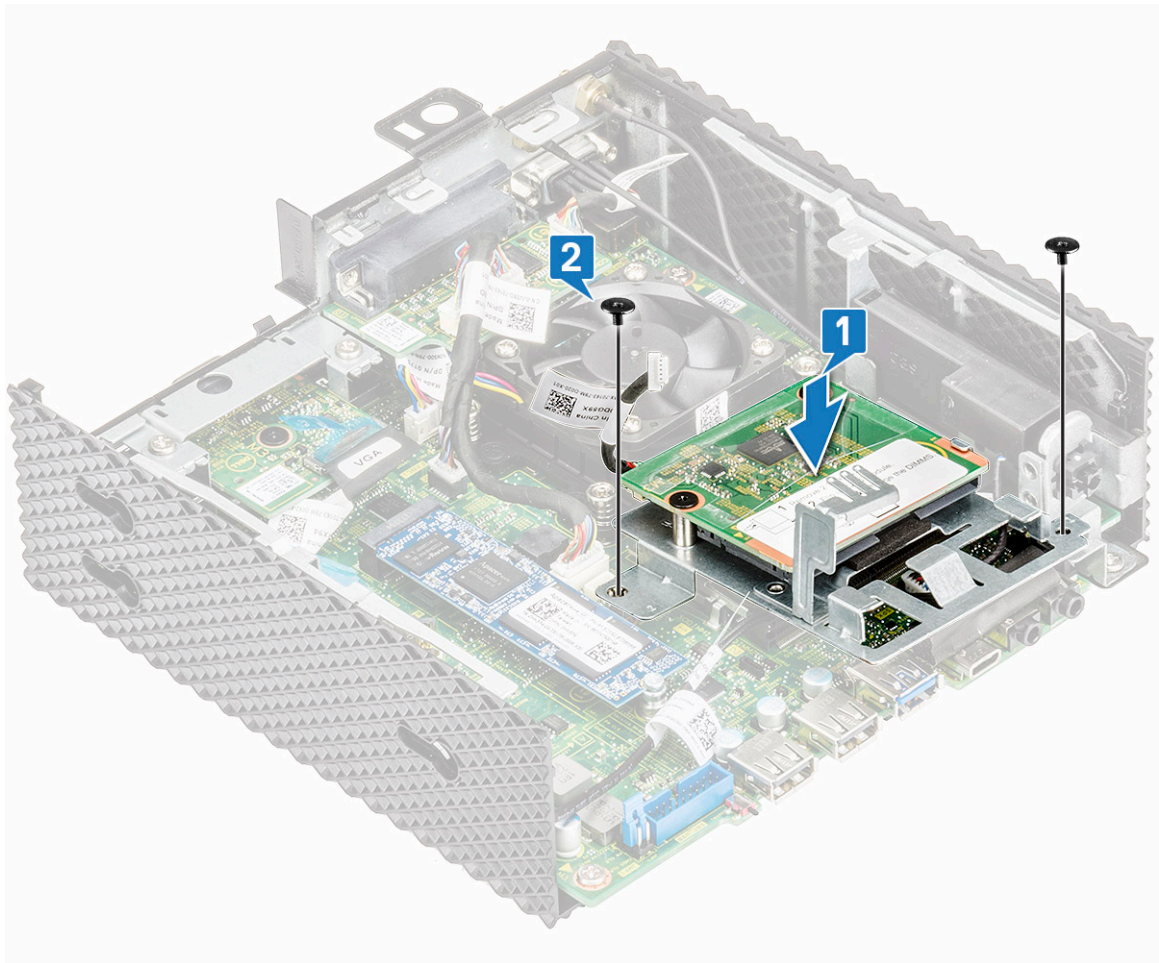

Figure 24. Align the screw holes and replace the screws

3. Connect the CAC reader cable to the system board.

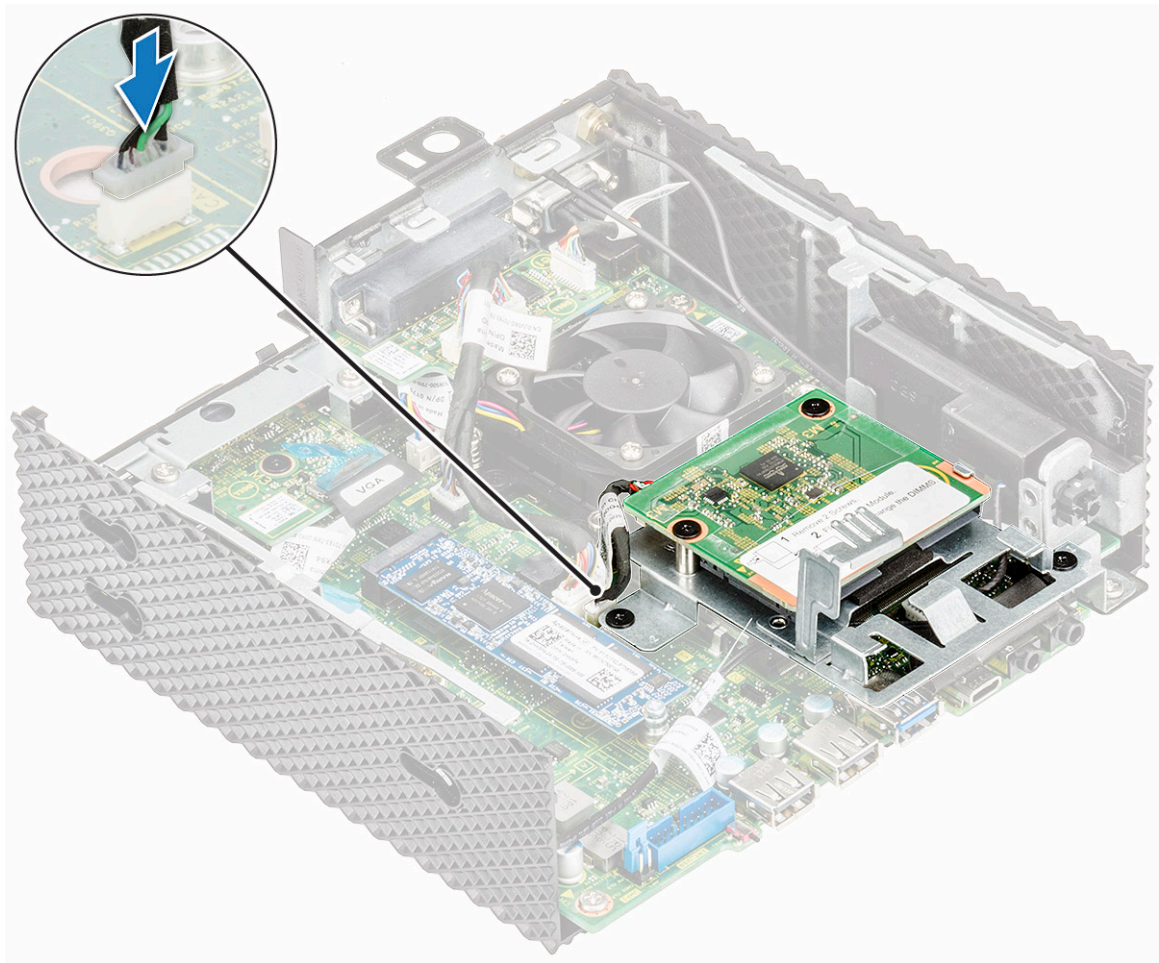

Figure 25. Connect CAC cable

4. Follow the procedure in [After working inside your thin client.](#)

Postrequisites

1. If applicable, replace the [PCIe module.](#)
2. Replace the [Chassis cover.](#)

Memory

A memory module is a circuit board that contains DRAM-integrated circuits that are installed into the memory slot on a system board.

Remove the memory module

Speaker and power button

A speaker contains an internal amplifier and therefore requires a power source through an power adapter, batteries, or a USB port. The power button is used to power on or off the thin client.

Remove the speaker and power button

Prerequisites

1. Remove the [Chassis cover](#).
2. If applicable, remove the [PCIe module](#).
3. Remove the [CAC reader](#).

Procedure

1. Follow the procedure in [Before working inside your thin client](#).
2. Disconnect the cables (1) and (2).

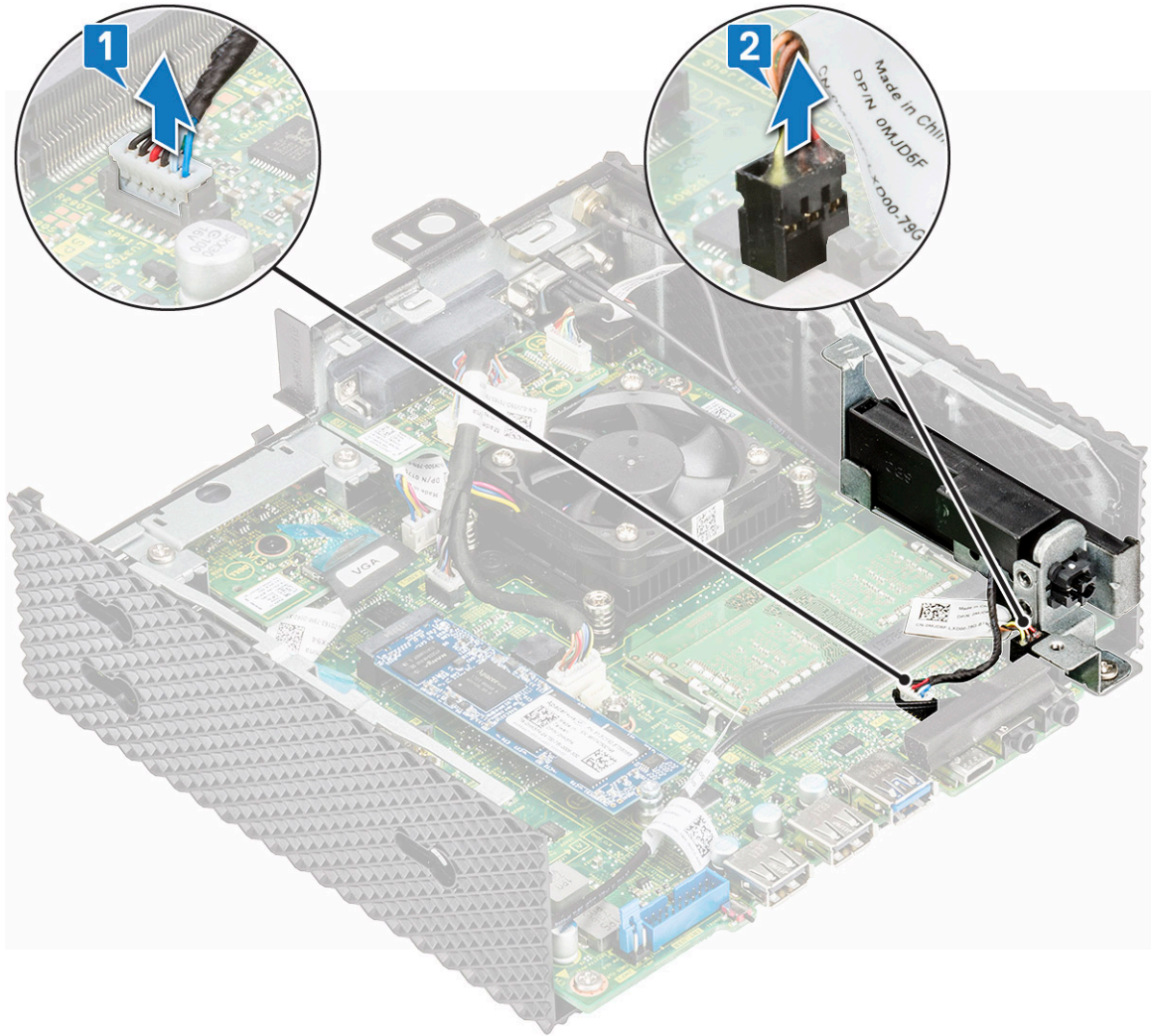

Figure 26. Disconnect the cables

3. Remove the screw that is securing the speaker/power button to the chassis.

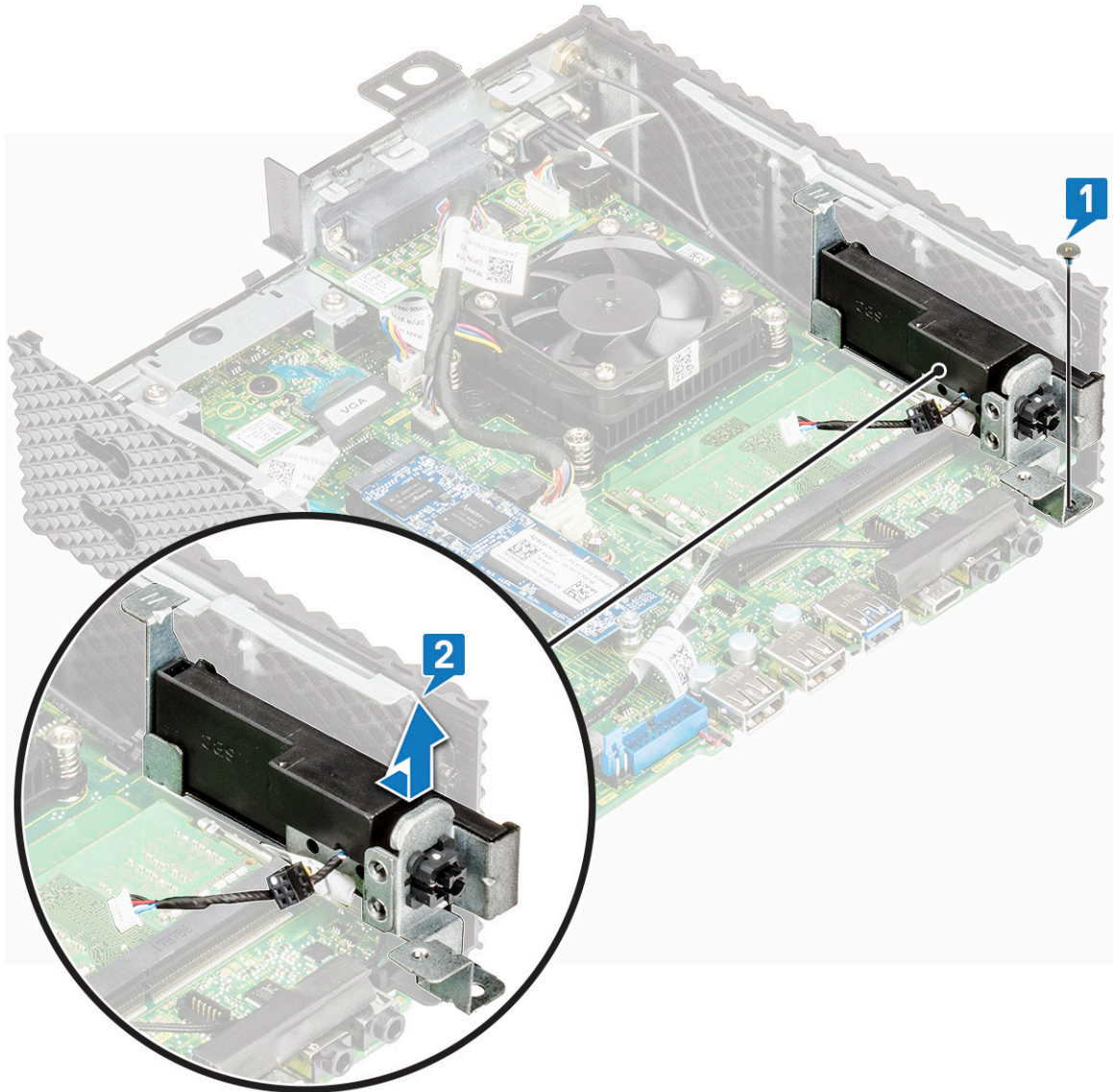

Figure 27. Remove the screw

4. Lift and slide the speaker/power button away from the chassis.

Install the speaker and power button

Procedure

1. Align the speaker/power button on the chassis.
2. Replace the screw that secure the speaker/power button to the chassis.
3. Connect the cables (1) and (2).
4. Follow the procedure in [After working inside your thin client](#).

Postrequisites

1. Replace the [CAC reader](#).
2. If applicable, replace the [PCIe module](#).
3. Replace the [Chassis cover](#).

Procedure

1. Follow the procedure in [Before working inside your thin client](#).
2. Using your fingertips, spread apart the securing clips on each end of the memory module slot until the memory module pops up.

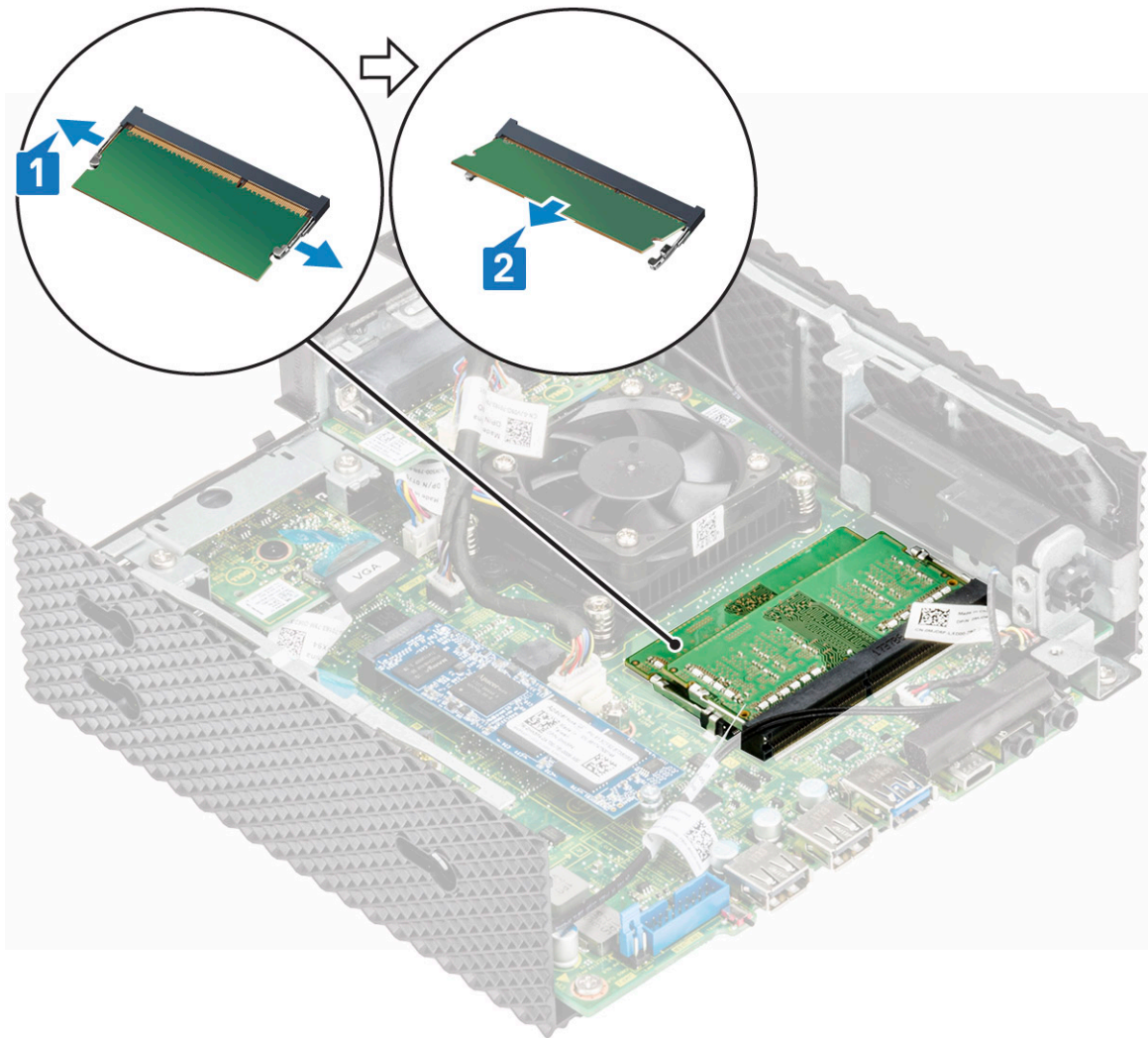

Figure 28. Remove the memory module

3. Slide and remove the memory module from the memory module slot.

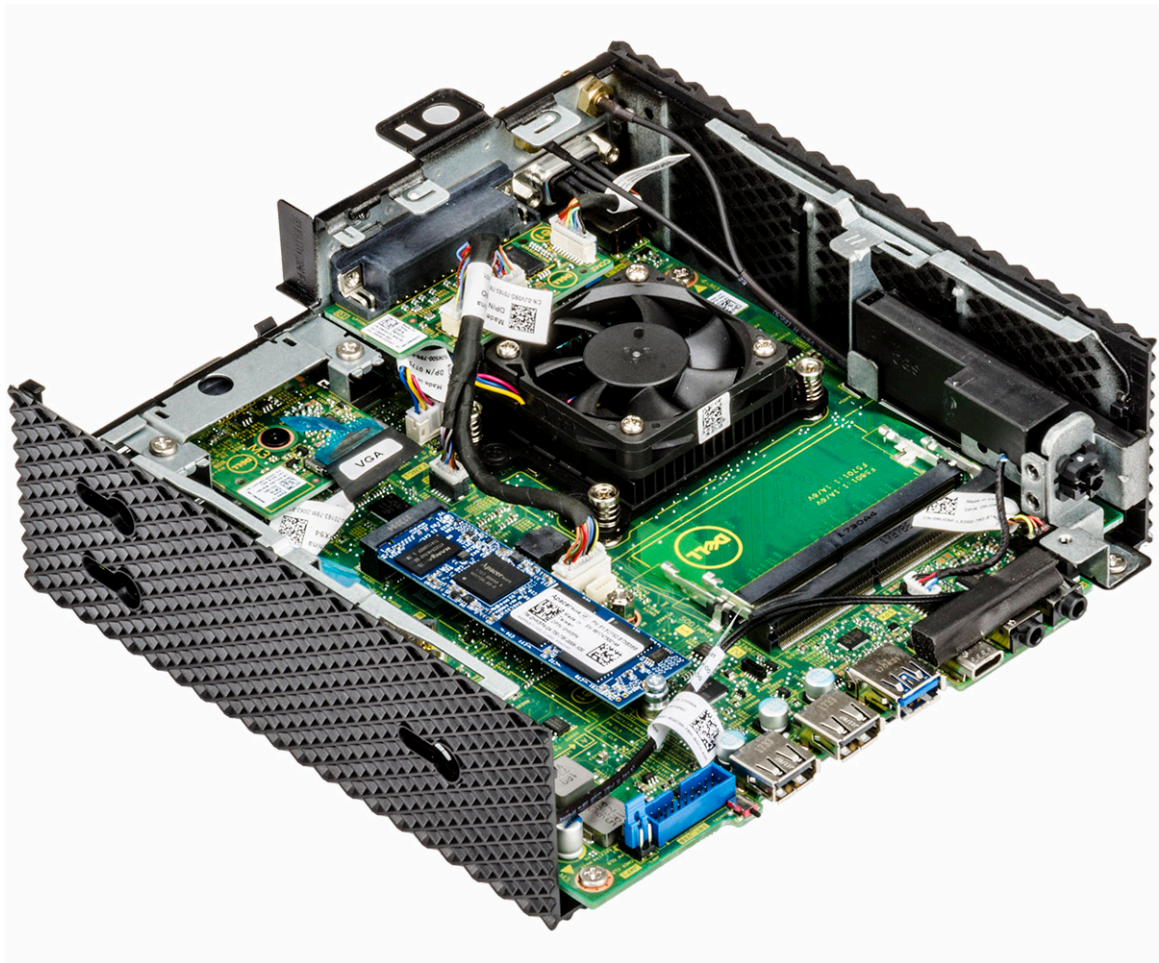

Figure 29. Memory cards are removed

Install the memory module

Procedure

1. Align the notch on the memory module with the tab on the memory module slot.
2. Slide the memory module firmly into the slot at an angle and gently press the memory module down until it clicks into place.

NOTE: If you do not hear the click, remove the memory module and reinstall it.

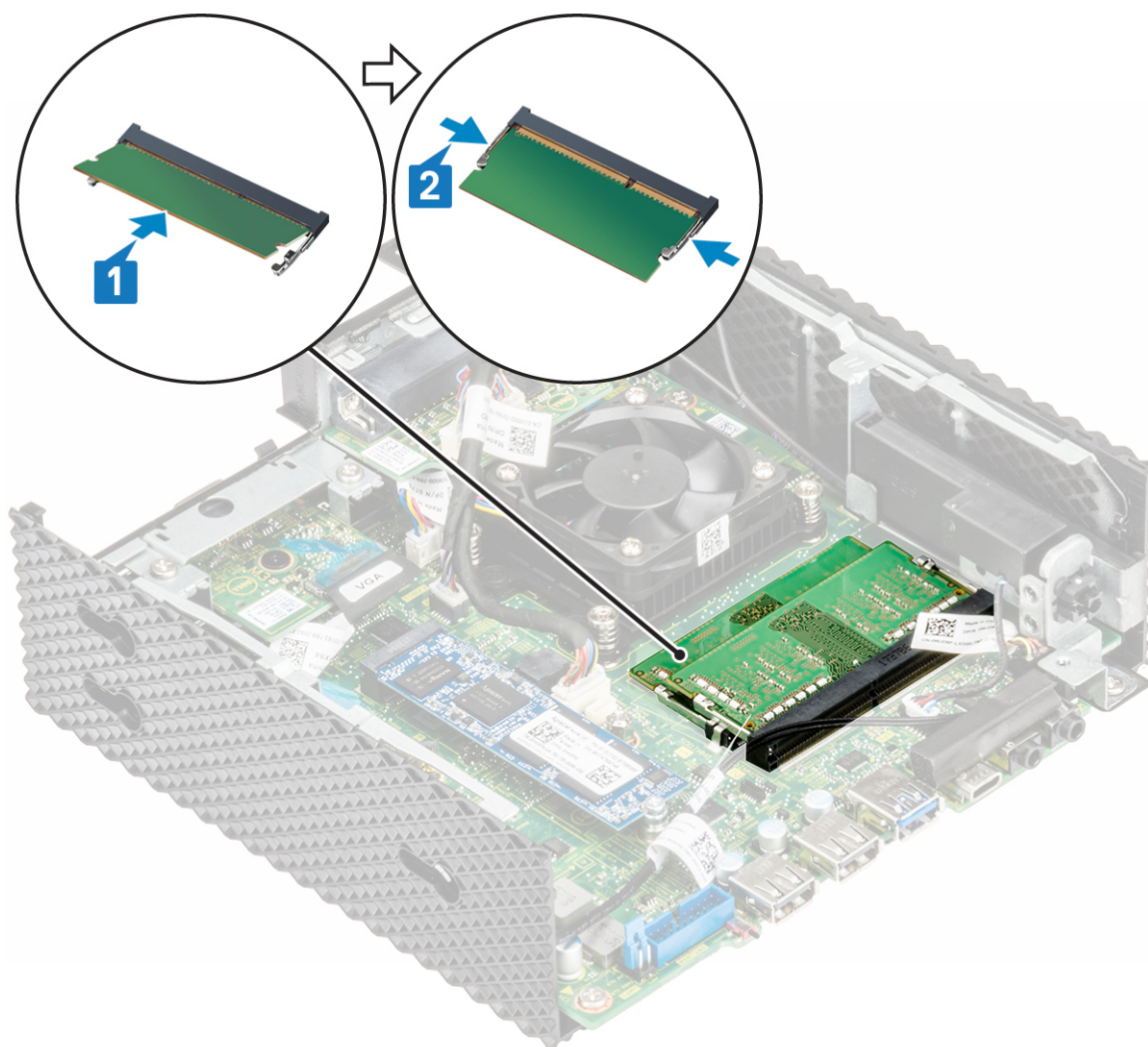

Figure 30. Install memory module

3. Follow the procedure in [After working inside your thin client](#).

Speaker and power button

A speaker contains an internal amplifier and therefore requires a power source through an power adapter, batteries, or a USB port. The power button is used to power on or off the thin client.

Remove the speaker and power button

Prerequisites

1. Remove the [Chassis cover](#).
2. If applicable, remove the [PCIe module](#).
3. Remove the [CAC reader](#).

Procedure

1. Follow the procedure in [Before working inside your thin client](#).
2. Disconnect the cables (1) and (2).

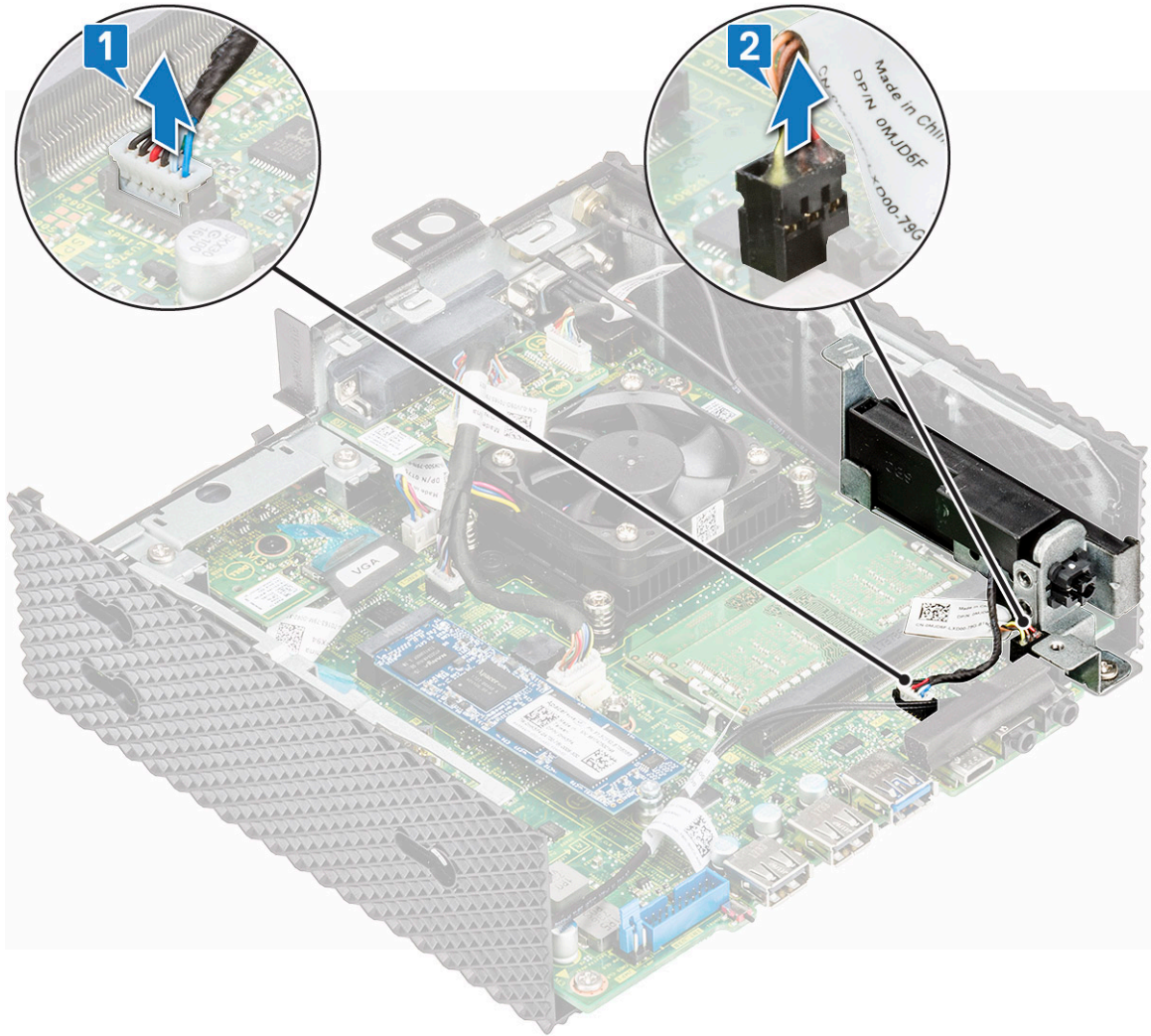

Figure 31. Disconnect the cables

3. Remove the screw that is securing the speaker/power button to the chassis.

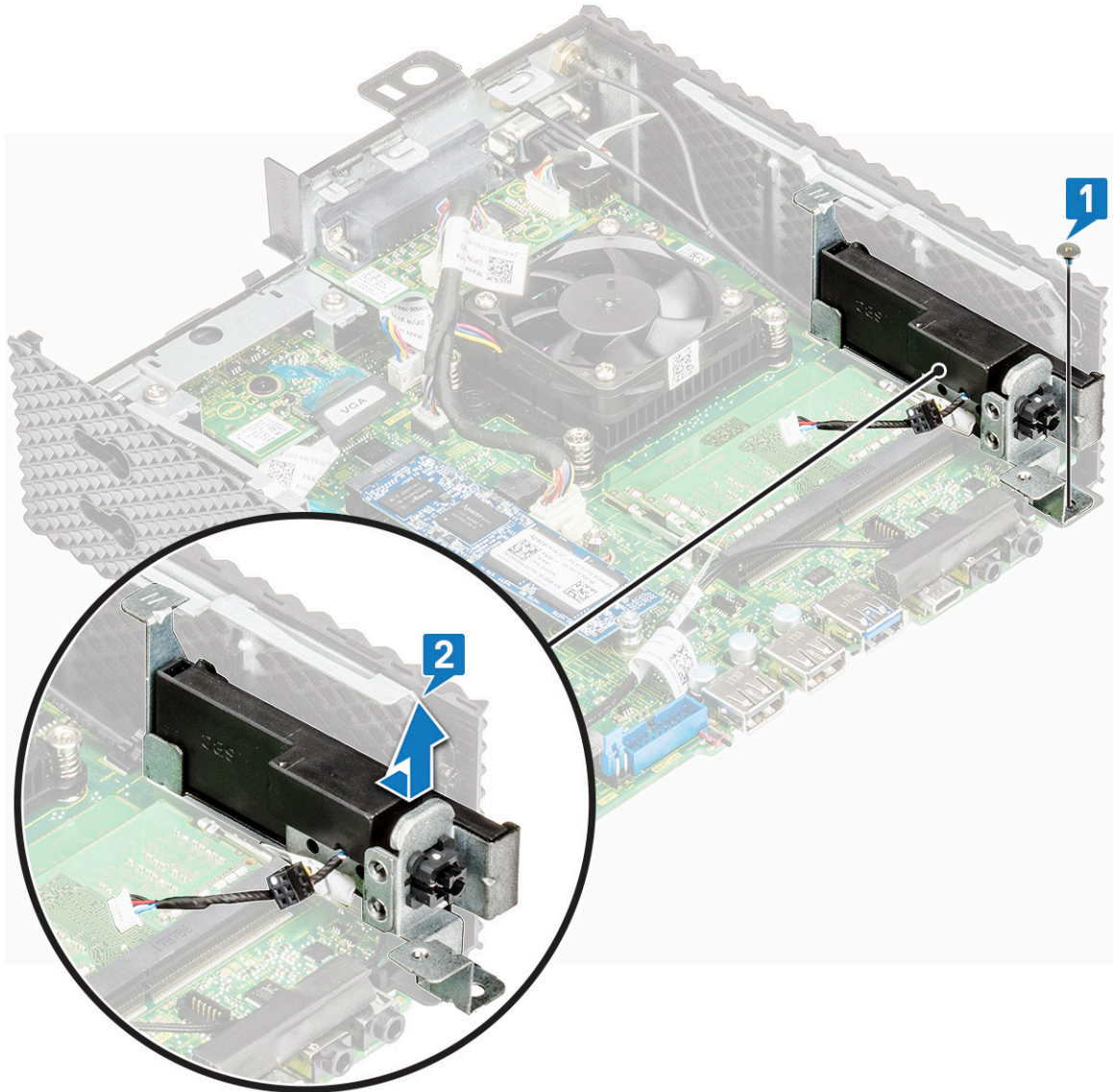

Figure 32. Remove the screw

4. Lift and slide the speaker/power button away from the chassis.

Install the speaker and power button

Procedure

1. Align the speaker/power button on the chassis.
2. Replace the screw that secure the speaker/power button to the chassis.
3. Connect the cables (1) and (2).
4. Follow the procedure in [After working inside your thin client](#).

Postrequisites

1. Replace the [CAC reader](#).
2. If applicable, replace the [PCIe module](#).
3. Replace the [Chassis cover](#).

Serial and parallel port

The parallel port interface is virtually nonexistent because of the rise of universal serial bus devices, along with the network printing by using Ethernet and Wi-Fi connected printers. A serial port is an interface on a thin client by which the information is transferred in or out 1 bit at a time.

Remove the serial and parallel port

Prerequisites

1. Remove the [Chassis cover](#).
2. If applicable, remove the [PCIe module](#).

Procedure

1. Follow the procedure in [Before working inside your thin client](#).
2. Disconnect the parallel port cable from the system board.

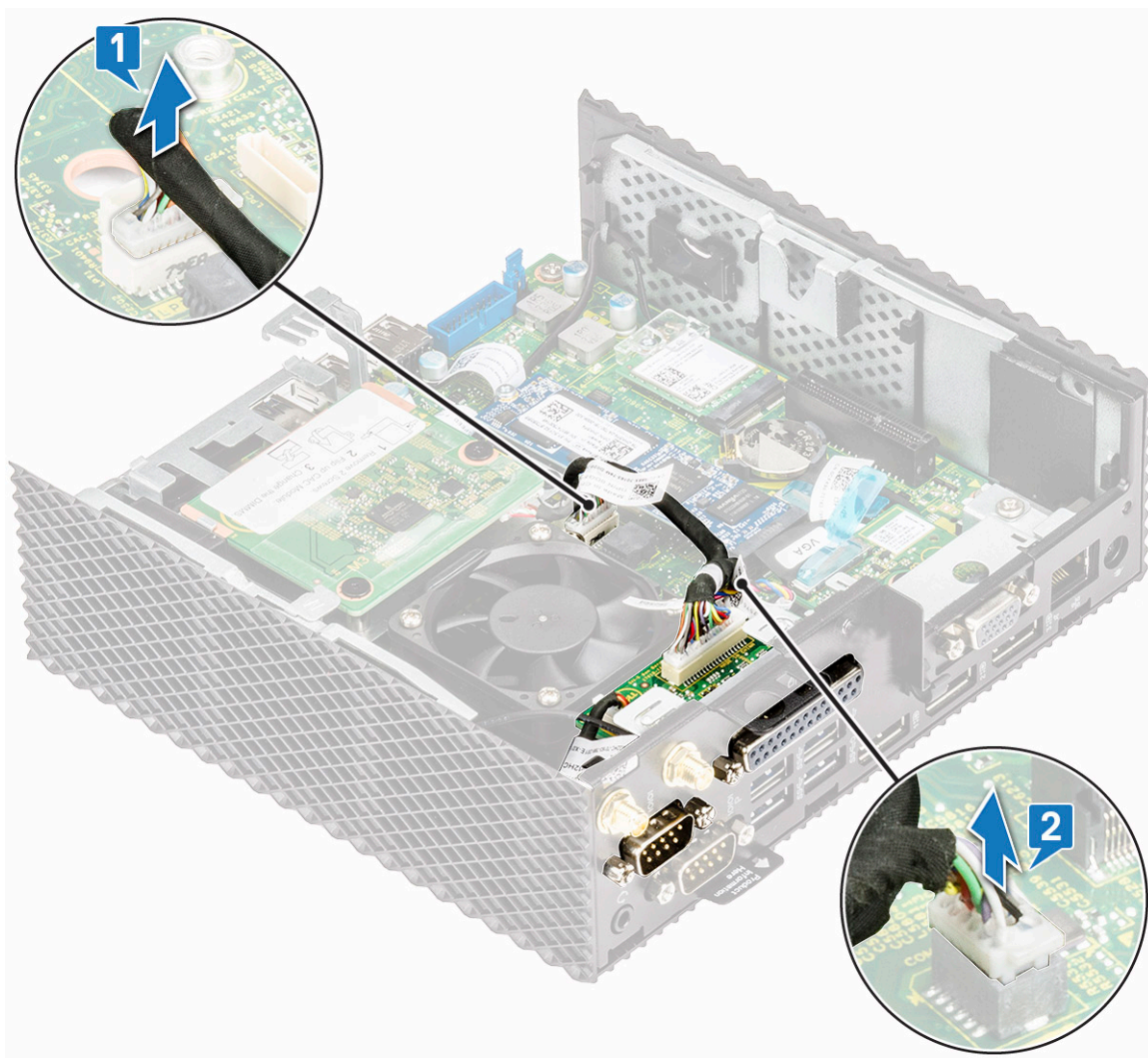

Figure 33. Disconnect the parallel port cable

3. Remove the four screws that secure the serial and parallel port to the chassis.

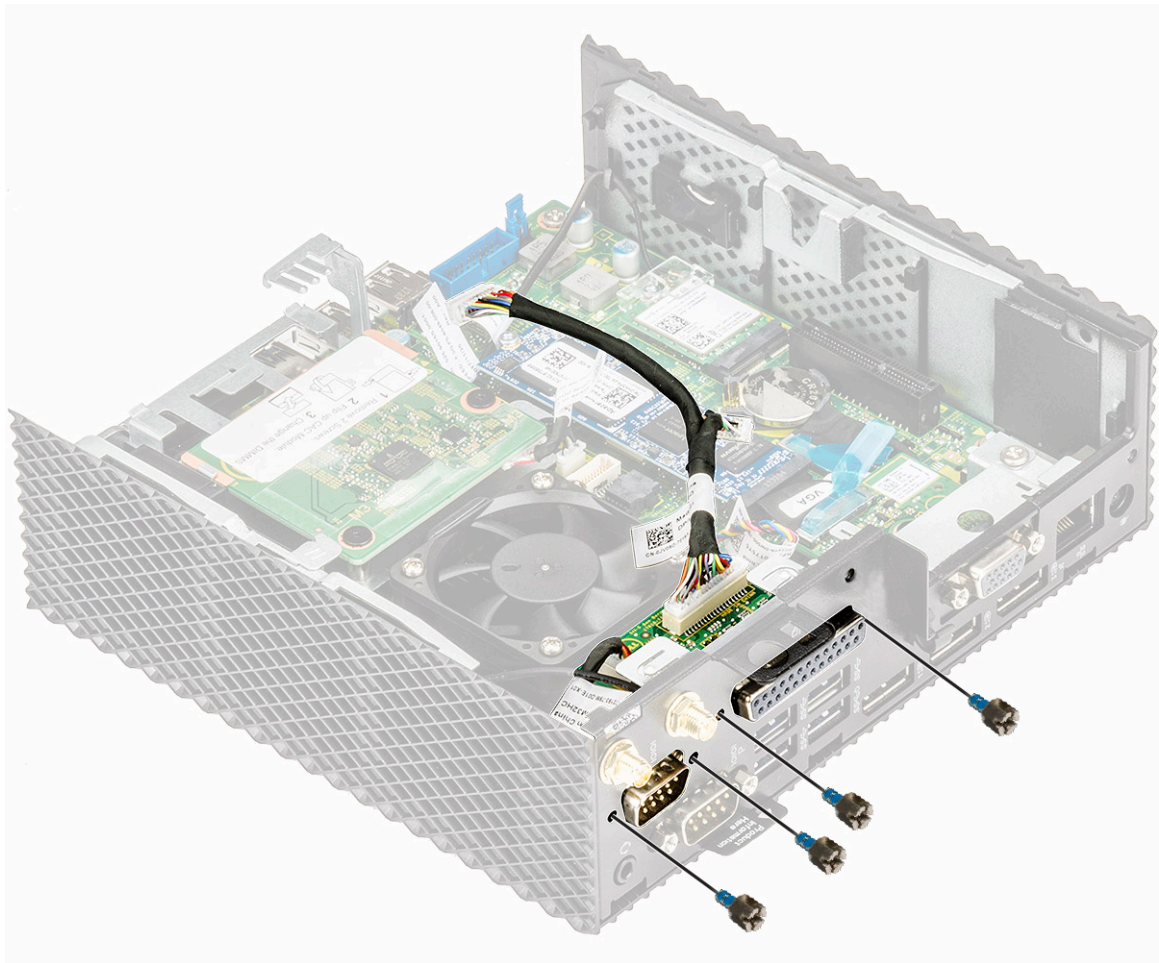

Figure 34. Remove the four screws

4. Pull and lift the serial and parallel port away from the chassis.

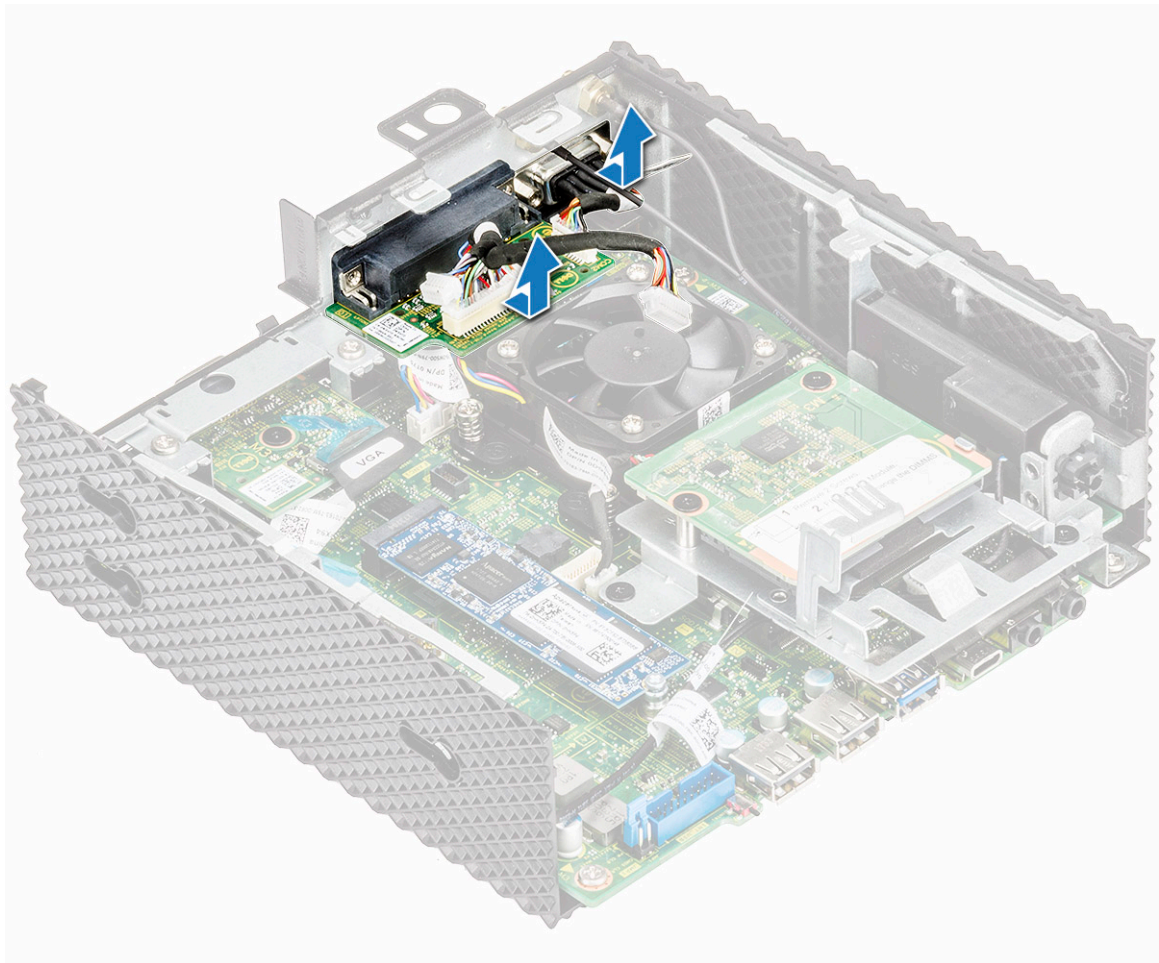

Figure 35. Pull and lift the serial and parallel port

Install the serial and parallel port

Procedure

1. Align the screw holes on the serial and parallel port with the screw holes on the chassis.
2. Replace the four screws that secure the serial and parallel port to the chassis.
3. Connect the parallel port cable to the system board.
4. Follow the procedure in [After working inside your thin client](#).

Postrequisites

1. If applicable, replace the [PCIe module](#).
2. Replace the [Chassis cover](#).

Heat sink

A heat sink is a passive heat exchanger that transfers the heat generated by the thin client to a fluid medium such as air or a liquid coolant. Heat is dissipated away from the thin client to allow the regulation of the thin client temperature at optimal level.

Remove the heat sink

Prerequisite

1. Remove the [Chassis cover](#).
2. If applicable, remove the [PCIe module](#).
3. Remove the [Serial and parallel port](#).

Procedure

1. Follow the procedure in [Before working inside your thin client](#).
2. Disconnect the heat sink cable from the system board.

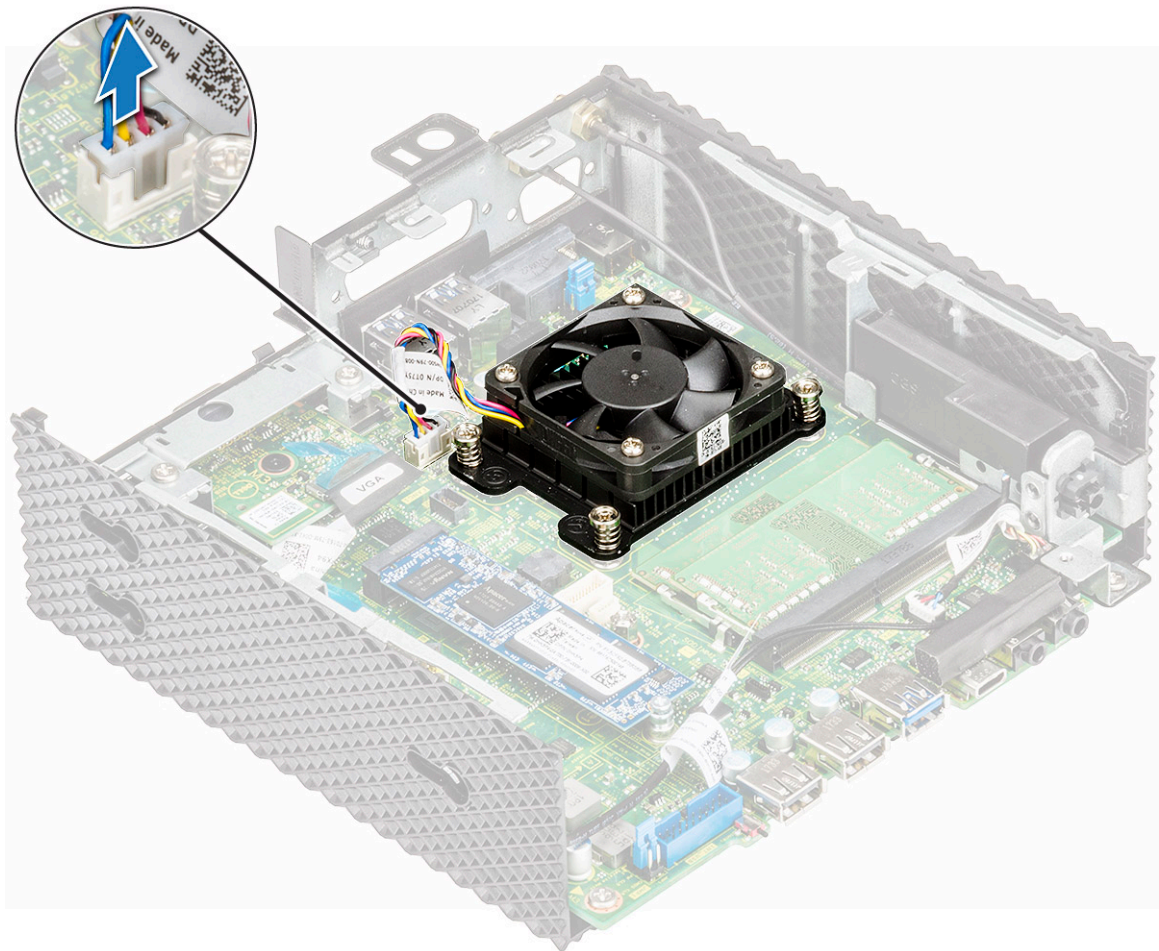

Figure 36. Disconnect the heat sink cable

3. Loosen the four screws that secure the heat sink to the system board.

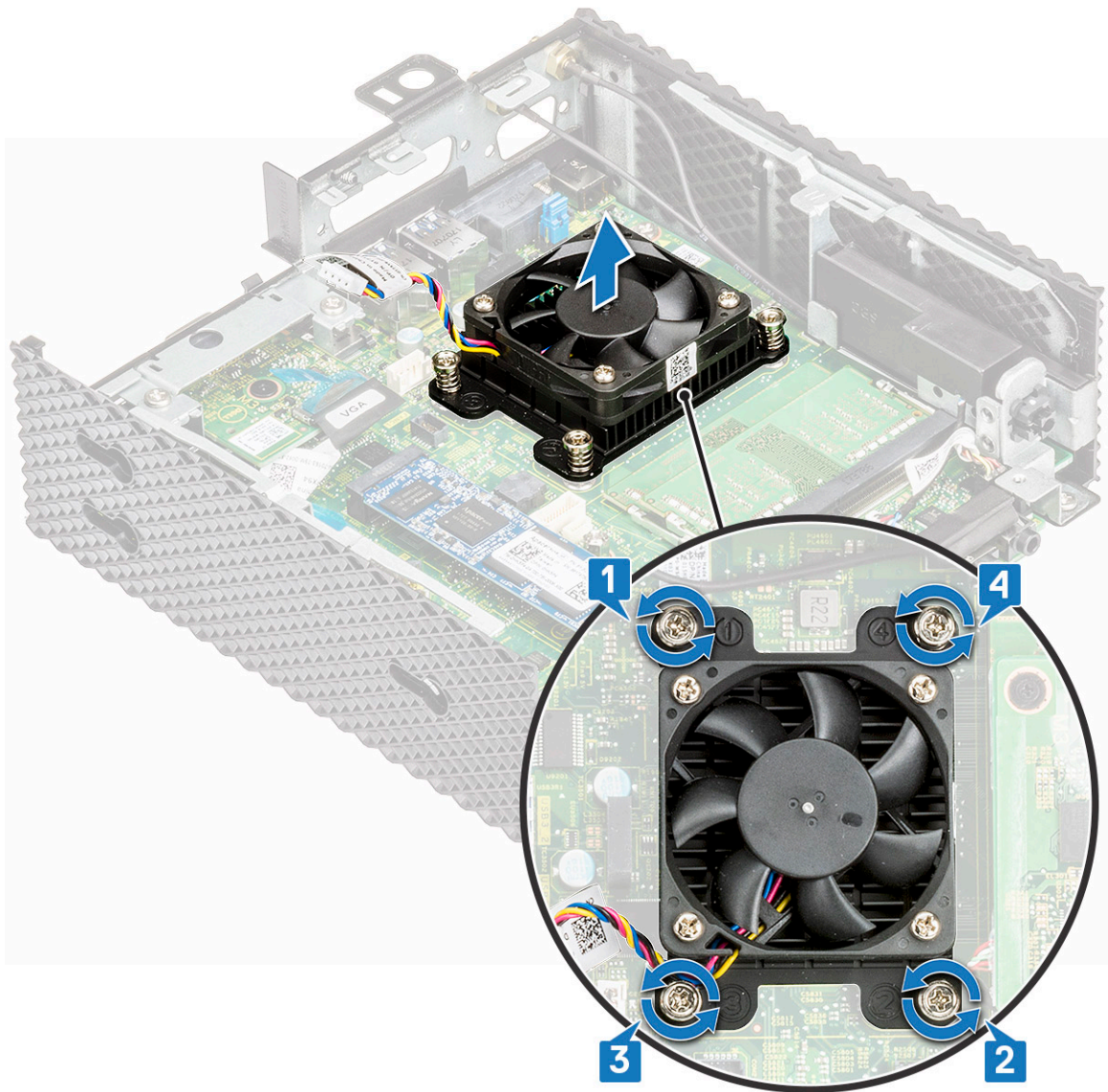

Figure 37. Remove the four screws

4. Lift the heat sink away from the system board.

Install the heat sink

Procedure

1. Align the screw holes on the heat sink with the screw holes on the system board.

CAUTION: Hold the heat sink by the metal edges and not the central portion. To avoid damaging the processor, do not press down on the central portion when placing the heat sink onto the processor.

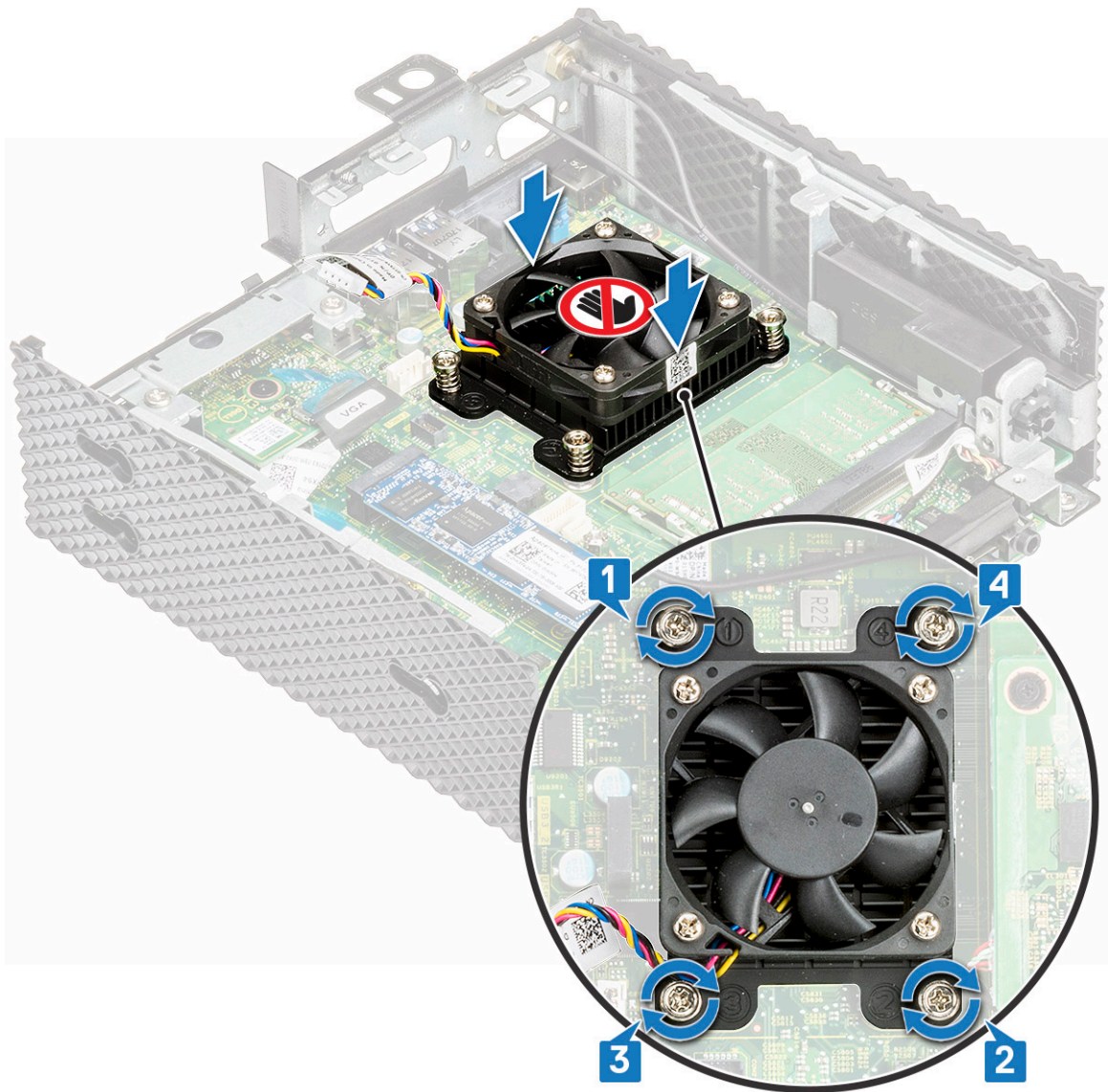

Figure 38. Installing the heat sink

2. Tighten the four screws that secure the heat sink to the system board.
3. Connect the heat sink cable to the system board.
4. Follow the procedure in [After working inside your thin client](#).

Postrequisite

1. Replace the [Serial and parallel port](#).
2. If applicable, replace the [PCIe module](#).
3. Replace the [Chassis cover](#).

System board

A system board (also known as the motherboard) is the main printed circuit board in the thin client with different connectors used to connect different components or peripherals of the thin client. A system board provides the electrical connections to the components in the thin client to communicate.

Remove the system board

Prerequisites

1. Remove the [Chassis cover](#).
2. If applicable, remove the [PCIe module](#).
3. Remove the [Coin-cell battery](#).
4. Remove the [Solid-state drive](#).
5. Remove the [Wireless card](#).
6. Remove the [Expansion module](#).
7. Remove the [CAC reader](#).
8. Remove the [Memory](#).
9. Remove the [Speaker and power button](#).
10. Remove the [Serial and parallel port](#).
11. Remove the [Heat sink](#).

Procedure

1. Follow the procedure in [Before working inside your thin client](#).
2. Disconnect the cable from the system board.

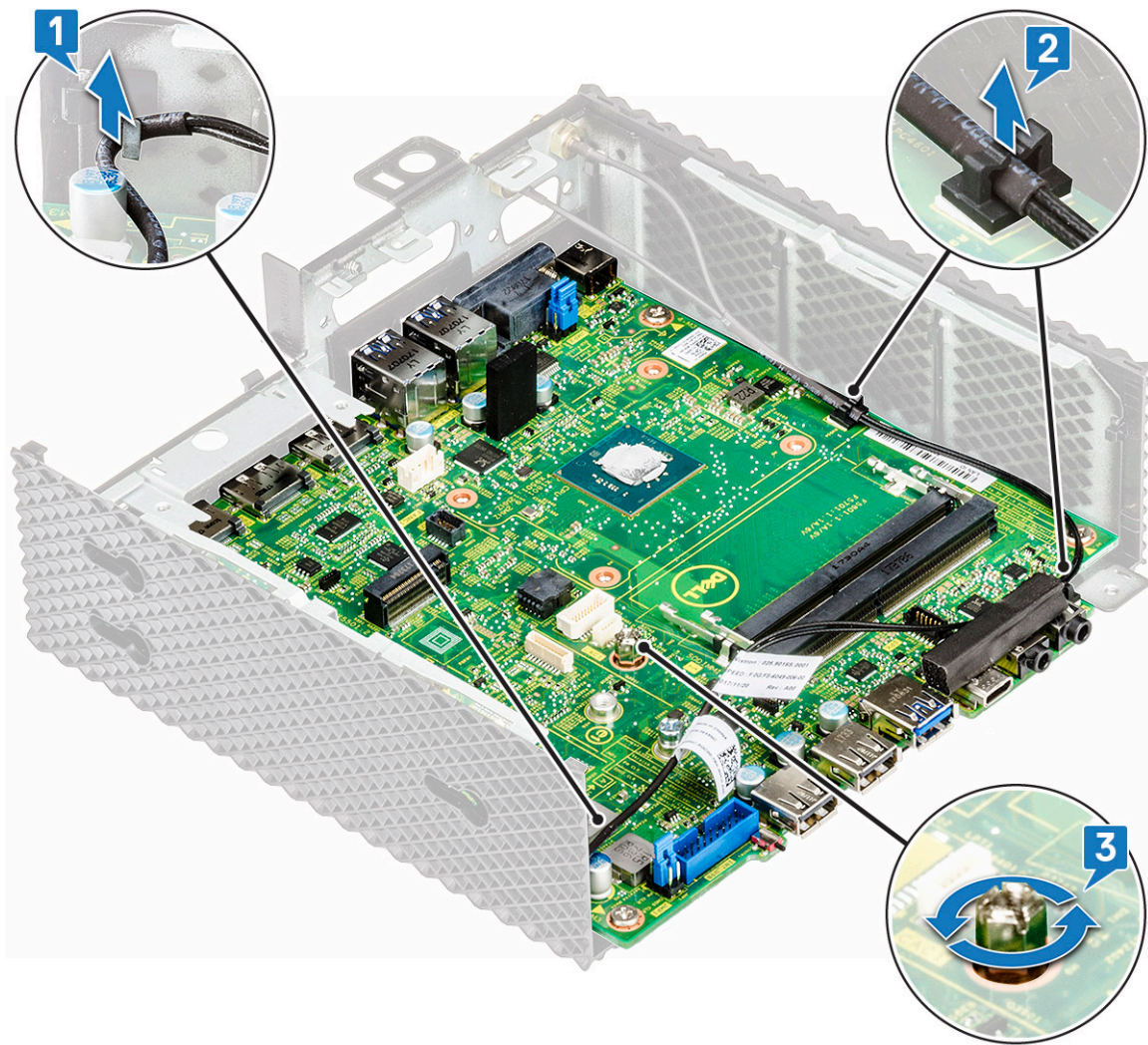

Figure 39. Disconnect the cable

3. Remove the screw that secure the system board to the chassis.
4. Remove the four screws that secure the system board to the chassis (1).

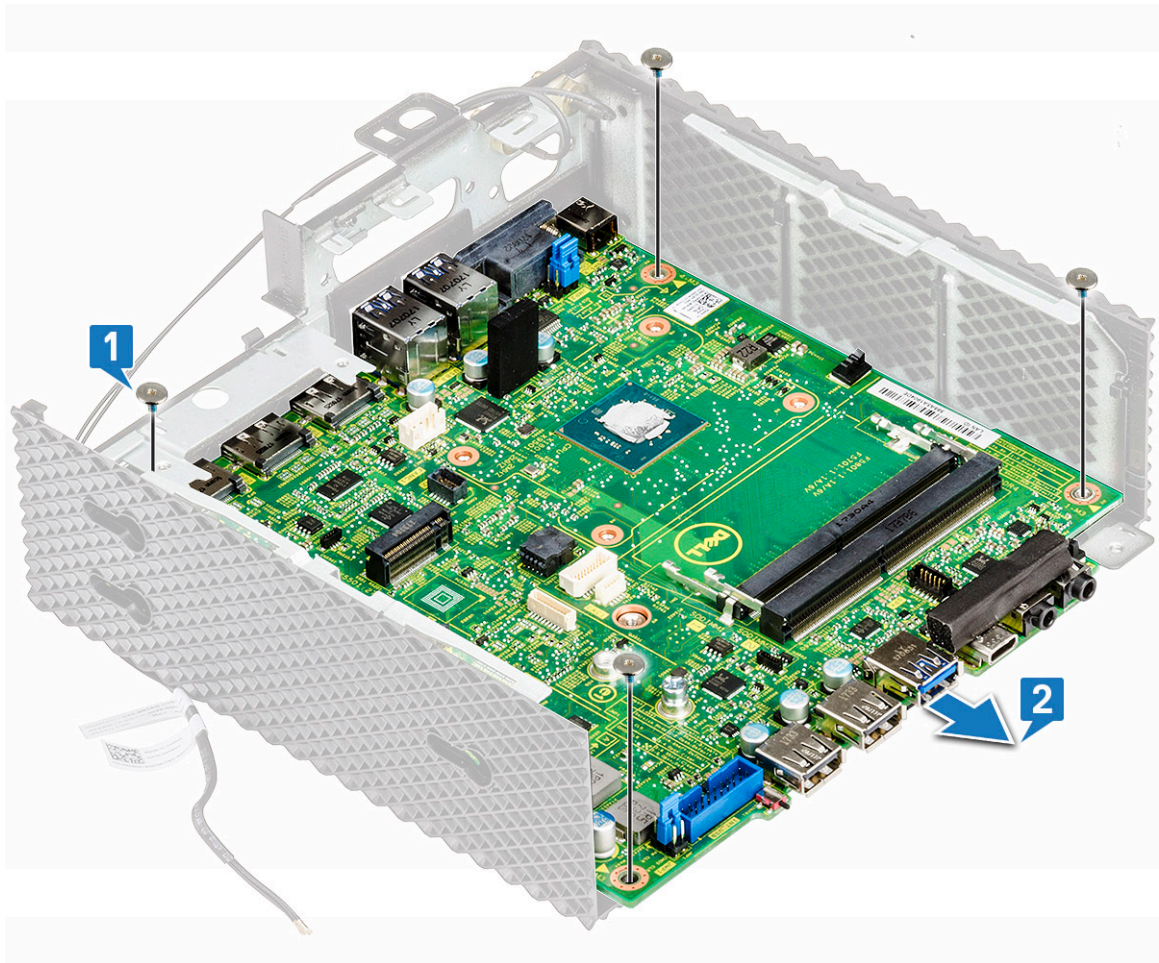

Figure 40. Remove the four screws

5. Pull the system board out of the chassis (2).

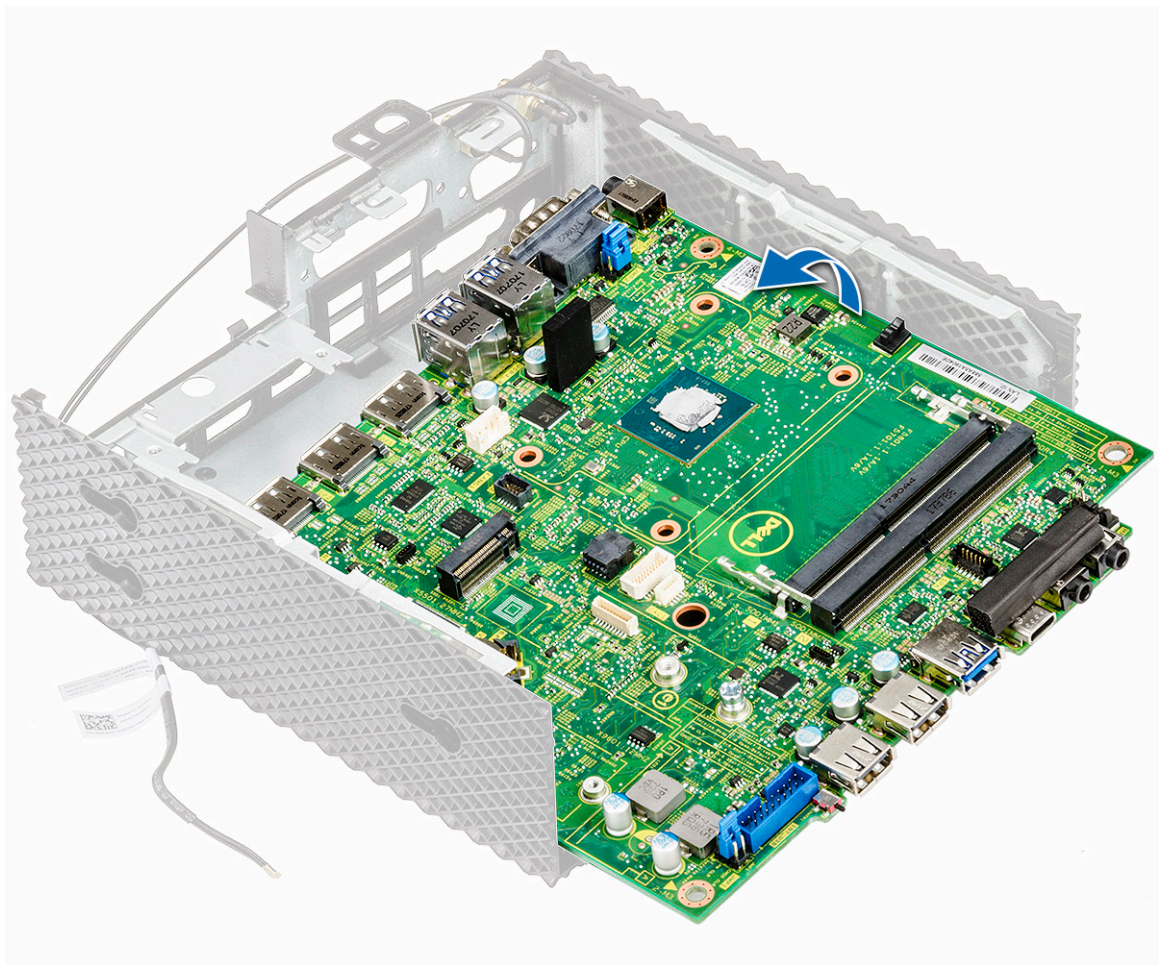

Figure 41. Pull the system board

Install the system board

Procedure

1. Place the system board and align the screw holes on the system board with the screw holes on the chassis.
2. Replace the five screws on the system board.
3. Route the wireless antenna cables through the routing guides.
4. Follow the procedure in [After working inside your thin client](#).

Postrequisites

1. Replace the [Heat sink](#).
2. Replace the [Serial and parallel port](#).
3. Replace the [Speaker and power button](#).
4. Replace the [Memory](#).
5. Replace the [CAC reader](#).
6. Replace the [Expansion module](#).
7. Replace the [Wireless card](#).
8. Replace the [Solid-state drive](#).
9. Replace the [Coin-cell battery](#).
10. If applicable, replace the [PCIe module](#).
11. Replace the [Chassis cover](#).

Technical specifications

This section provides the technical specifications of the Wyse 5070 extended thin client.

Topics:

- [System specifications](#)
- [Processor](#)
- [Operating systems](#)
- [Memory specifications](#)
- [Storage](#)
- [Audio specifications](#)
- [Communication specifications](#)
- [Ports and connectors specifications](#)
- [Security](#)
- [Battery specifications](#)
- [AC adapter specifications](#)
- [Physical specifications](#)
- [Environment](#)

System specifications

This section describes the system specifications of the thin client.

Table 2. System specifications

Feature	Specification
Chipset	Intel Gemini Lake
DRAM bus width	64 bit
Flash EPROM	SPI 16 MB

Processor

This thin client is shipped with the following processor:

Table 3. Processor specifications

Feature	Intel Gemini Lake Pentium Quad Core
Cache	<ul style="list-style-type: none"> • 56 KB L1 cache • 4 MB L2 cache
Number of cores	Four
Package	25x24 FCBGA
Processor minimum core frequency	800 MHz
Processor base core frequency	1.5 GHz
Maximum single core burst frequency	2.8 GHz
Maximum two core burst frequency	2.7 GHz

Table 3. Processor specifications (continued)

Feature	Intel Gemini Lake Pentium Quad Core
Maximum three core burst frequency	2.7 GHz
Maximum four core burst frequency	2.7 GHz
Graphics Executive Unit (EU)	18
Graphics minimum frequency	100 MHz
Graphics base frequency	250 MHz
Graphics maximum dynamic frequency	800 MHz
Supported memory technology	LPDDR4, DDR4
Maximum memory controller frequency	2400 MT/s
Supported DIMMS per channel	Two
TjMax	105° C (221° F)
Thermal Design Power (TDP)	10 W

Operating systems

The following operating systems are supported for Wyse 5070 thin client:

- ThinLinux
- ThinOS
- ThinOS with PCoIP
- Windows 10 IoT Enterprise

Memory specifications

This section describes the memory specifications of the thin client.

Table 4. Memory specifications

Feature	Specification
Memory connector	Two SODIMM slots
Memory capacity	4 GB (1 x 4 GB), 8 GB (2 x 4 GB)
Memory type	DDR4 SODIMM
Speed	2133/2400 MHz
Minimum memory	4 GB
Maximum memory	8 GB

Storage

The following table provides information about the storage capability:

Table 5. Storage specifications

Feature	Specification
Solid-state drive	One M.2 2260/2280 slot
Standard SATA interface	<ul style="list-style-type: none"> • Serial ATA v3.2

Table 5. Storage specifications (continued)

Feature	Specification
	<ul style="list-style-type: none"> • SATA 6.0 Gbps interface • ATA-8 command set • Supports Self-Monitoring, Analysis and Reporting Technology (S.M.A.R.T) • Supports NCQ up to queue depth of 32
Connector type	75-pin SATA-based M.2 module pinout
Supply voltage	3.3 V +-5%
Operation temperature	0°C to 70°C
Capacity	<ul style="list-style-type: none"> • eMMC—16 GB and 32 GB • SSD—0, 32, 64, 128, 256, and up to 512 GB
Flash management	<ul style="list-style-type: none"> • Built-in hardware ECC • Dynamic and static wear-leveling to extend the life of the SSD • Flash bad-block management • Supports TRIM command to sustain drivers high performance over time • Supports ATA register and command set (ATA-8/ACS-2 standard)

Audio specifications

This section describes the audio specifications of the thin client.

Table 6. Audio specifications

Feature	Specification
Controller	Realtek ALC3253 and Intel
Internal interface	<ul style="list-style-type: none"> • High-definition audio codec • DP audio
External interface	<ul style="list-style-type: none"> • Headset/mic combo jack • Headphone jack

Communication specifications

This section describes the communication specifications of the thin client.

Table 7. Communication specifications

Feature	Specification
Network adapter—onboard	10/100/1000 Mb/s Ethernet—RJ45
Second network adapter—optional	10/100/1000 Mb/s Ethernet—RJ45 or 100/1000—SFP <i>i</i> NOTE: On Wyse 5070 Extended Thin Clients, you must enable the WiFi option in BIOS to use the expansion slot for SFP.
Wireless card	One M.2 2230 WLAN slot
Wi-Fi—optional	Intel 9560 Wi-Fi and Bluetooth combo module

Table 7. Communication specifications (continued)

Feature	Specification
	802.11a/b/g/n/ac dual band 2 x 2 MIMO Wi-Fi through CNVi interface
Antenna	<ul style="list-style-type: none"> • Dual external antenna connected to the Wireless card • Frequency (GHz)—2.4 and 5
Wireless options	<ul style="list-style-type: none"> • Intel Dual Band Wireless-AC 2x2 • USB 2.0 interface for Bluetooth 5.0

Ports and connectors specifications

This section provide details about the ports and connectors in the thin client.

Table 8. Ports and connectors specifications

Feature	Specification
Audio	<ul style="list-style-type: none"> • Two headset/mic combo jacks • One headphone jack
Video	<ul style="list-style-type: none"> • Two DisplayPort v1.2a supports up to two displays at 4K x 60 Hz • One DisplayPort v1.2a without audio • One VGA—optional
Network adapter	<ul style="list-style-type: none"> • One RJ45 connector • Second RJ45 or SFP module (fiber and 1Gbps copper)—optional
USB	Front
	<ul style="list-style-type: none"> • One USB 2.0 port • One USB 2.0 port with PowerShare • One USB Type-C port • One USB 3.0 port
	Back
	<ul style="list-style-type: none"> • One USB 3.0 with Smart Power-on • Three USB 3.0 ports
Common Access Card reader	Accepts 1.8 V, 3 V, and 5 V cards

Security

The section provides security options available for Wyse 5070 thin client:

- TPM chip onboard v2.0
- Chassis intrusion detection
- Kensington lock
- Pad lock

 **NOTE:** The total depth of the Pad/Kensington lock is 1.54 cm (0.60 inch).

Battery specifications

The Wyse 5070 extended thin client supports the following coin-cell battery:

Table 9. Battery specifications

Feature	Specification
Coin-cell battery	3 V CR2032 lithium coin-cell battery

AC adapter specifications

This section describes the power adapter specifications of the thin client.

Table 10. AC adapter specifications

Feature	Specification
Type	130 W
Input voltage	100-240 VAC
Input current (maximum)	1.8 A
Input frequency	50-60 Hz
Output current	6.7 A
Rated output voltage	19.5 VDC
Temperature range (Operating)	0 ~ 40° C (32 ~ 104° F)
Temperature range (Non-Operating)	-40 ~ 70° C (-40 ~ 158° F)

Physical specifications

This section describes the physical dimensions of the thin client.

Table 11. Physical specifications

Feature	Specification
Height	18.4 cm (7.24 inches)
Width	6.6 cm (2.5 inches)
Depth	18.4 cm (7.24 inches)
Starting weight	1.47 kg (3.25 lb)

Environment

This section describes environmental specifications of the thin client.

Table 12. Environmental specifications

Feature	Specification
Temperature	<ul style="list-style-type: none">• Operating—0 ~ 40° C (32 ~ 104° F)• Storage—-40 ~ 70° C (-40 ~ 158° F)
Relative humidity (Maximum)	<ul style="list-style-type: none">• Operating—95% non-condensing• Storage—95% non-condensing
Altitude (Maximum)	<ul style="list-style-type: none">• Operating—5000 m (16404.2 ft)• Non-operating—10668 m (35000 ft)

Wyse 5070 thin client configuration on ThinOS

This section provides the instructions on how to easily configure and efficiently manage Wyse 5070 thin client that runs on ThinOS. .

Topics:

- [Introduction](#)
- [Configuring ThinOS using the First Boot Wizard](#)
- [Logging on to the Wyse 5070 thin client running Wyse ThinOS](#)
- [Local settings menu](#)
- [Configuring the printer settings](#)

Introduction

Thin clients running Dell Wyse ThinOS firmware are designed solely for optimal thin client security and performance. These efficient purpose-built thin clients are virus and malware resistant, and offer ultrafast access to applications, files and network resources within Citrix, Microsoft, VMware and Dell vWorkspace environments, and other leading infrastructures. ThinOS based thin clients are self-managed, go from power-on to fully productive in seconds, and with no published API, locally accessible file system or browser, require no local McAfee Anti-Virus software or firewall to protect against viruses or malware.

Configuring ThinOS using the First Boot Wizard

The First Boot Wizard runs the first time you start a new thin client with the ThinOS version 8.5. The thin client starts the First Boot Wizard application before you enter the ThinOS system desktop, and allows you to perform a set of tasks, such as, configuring system preferences, setting up the internet connectivity, loading USB configurations, configuring management software, and configuring broker connections.

If you are an existing thin client user, and you have upgraded to the ThinOS version 8.5, then you can reset your thin client to factory default settings to enter the First Boot Wizard.

The First Boot Wizard runs the first time you start a new thin client with the ThinOS version 8.5.1. The thin client starts the First Boot Wizard application before you enter the ThinOS system desktop, and allows you to perform a set of tasks, such as, configuring system preferences, setting up the internet connectivity, loading USB configurations, configuring management software, and configuring broker connections.

You can also reset your thin client to factory default settings to enter the First Boot Wizard.

To configure the First Boot Wizard:

1. Connect a new thin client or existing thin client to the Ethernet using a wired connection. The existing thin client must be reset to factory default settings to enter the First Boot Wizard.
2. Turn on your thin client.
The thin client checks for a wired network connection. If the network connection is successful, a welcome screen with the model name of your thin client is displayed.

The thin client validates the IP address from DHCP. If the DHCP contains the file server or the Wyse Device Manager or Wyse Management Suite configurations, then the ThinOS system desktop is loaded without entering the First Boot Wizard. If the DHCP validation fails or if you have not connected to Ethernet, then follow the next step.

NOTE: To exit the First Boot Wizard during the network connection status check on the welcome screen, press the Ctrl + Esc key.

3. On the **Would you like to load a ThinOS configuration file from USB?** screen, do either of the following:

- To load a ThinOS configuration file from the USB drive, ensure that you create a `wnos.ini` file and add the file to the `/wnos` directory on the USB drive. Using this option, you can load packages, and wallpapers that are specified in the INI file. Plug in the USB drive to thin client, and click **Yes**.

NOTE: Only FAT, FAT32, and ExFAT file systems on the USB disk are supported. NTFS file system is not supported.

The thin client validates the configuration file in the USB drive.

- If the ThinOS configuration file in the USB drive is correct, the **Read configuration success** message is displayed. Click **OK** to exit the First Boot Wizard, and log in to the ThinOS system desktop.
- If the ThinOS configuration file in the USB drive is corrupted or the appropriate file is not available, then the **Cannot find configuration files, or read configuration failure** message is displayed. Upload the correct file on the USB drive, plug the USB drive again, and then click **Retry**. If the file is correct, the **Read configuration success** message is displayed. Click **OK** to exit the First Boot Wizard, and log in to the ThinOS system desktop.

If you do not want to use the **Retry** option to load the ThinOS configuration file, then click **Abort** to enter the **System Preferences configuration** setup.

NOTE: To exit the **Cannot find configuration files, or read configuration failure message** screen, and load the ThinOS system desktop, click **Exit**.

- To enter the **System Preferences configuration** setup, click **No**.

4. On the **System Preferences Configuration** screen, configure the following options:

- **Locale**—Select a language to start ThinOS in the regional specific language.
- **Keyboard Layout**—Select a keyboard layout to set the keyboard layout in the regional specific language.
- **Time Zone**—Select a time zone to set the time zone for your thin client.
- **Time Server**—Displays the IP addresses or host names with optional port number of time servers.
- **Advanced**—Click **Advanced** to configure settings, such as daylight saving, time format, date format, and time servers.

NOTE: To exit the **System Preferences Configuration** screen, and load the ThinOS system desktop, click **Exit**.

If you are not connected to Ethernet, you cannot continue with the setup, and the **Attach the Ethernet cable** screen is displayed. Do either of the following:

- Connect the Ethernet cable to the thin client.
- Click **Define a wireless connection**. From the list, select a wireless network, and click **Connect**.

NOTE:

- The option to define a wireless connection is not available on thin clients without a WLAN module.
- To exit the **Attach the Ethernet cable** screen, and load the ThinOS system desktop, click **Exit**.

After the connection is established, the thin client validates the IP address from DHCP. If the DHCP contains the file server or the Wyse Device Manager or Wyse Management Suite configurations, then the ThinOS system desktop is loaded. If the DHCP validation fails, or the network connection fails, then the **Management Configuration** screen is displayed. Follow steps 6–9.

5. Click **Next** to enter the **Management Configuration** setup.

6. On the **Management Configuration** screen, configure the following:

- **File Server**—Enter the file server details to apply configurations including INI files, firmware, packages, and so on, from a file server.
- **WMS**—Enter the group registration key and the Wyse Management Suite server URL to register the thin client to the Wyse Management Suite.
- **WDM**—Enter the IP addresses or host names.
- **Disable SSL warning**—Select this check box to disable the SSL (Secure Sockets Layer) connection warnings.
- **Certificates Manager**—Click **Certificates Manager** to import or request a certificate.

NOTE: To exit the **Management Configuration** screen, and load the ThinOS system desktop, click **Exit**.

7. Click **Done** to exit the First Boot Wizard or click **Next** to enter the **Connection Broker Configuration** setup.

8. On the **Connection Broker Configuration** screen, configure the following:

- **Citrix**—The broker allows you to connect to full desktops using XenDesktop or individual applications using XenApp from a centralized host through Citrix Receiver Client.
 - **Server Address**—Enter the host name or IP address of the broker connection.
 - **Enable theme: ThinOS Lite**—Select this check box to boot the thin client in ThinOS Lite mode.
 - **StoreFront style**—Select this check box to enable the Citrix StoreFront based layout of published applications and desktops on the thin client.

- **Microsoft**—The broker allows you to connect to the virtual desktops using RemoteApp and Desktop connection. Enter the host name or IP address of the broker connection.
- **VMware**—The broker allows you to connect to the remote desktops using VMware Horizon Client.
 - **Server Address**—Enter the host name or IP address of the broker connection.
 - **Enable theme: VMware View**—Select this check box to set the ThinOS desktop theme to VMware View mode.
- **DELL**—The broker allows you to connect to the virtual desktops or applications using Dell vWorkspace. Enter the host name or IP address of the broker connection.
- **Amazon WorkSpaces**—The broker allows your PCoIP clients to connect to virtual desktops that run on AWS. Enter the host name/IP address/FQDN of the broker connection.
 - **NOTE:** Amazon WorkSpaces option is applicable only to the PCoIP clients.
- **Other**—The broker allows you to connect to the virtual desktops or applications using other supported protocols. Enter the host name or IP address of the broker connection.
- **Certificates Manager**—Click **Certificates Manager** to import or request a certificate.
- **Disable SSL warning**—Select this check box to disable the warnings for your SSL (Secure Sockets Layer) connection.

9. Click **Done**.

NOTE: To configure the Management Configuration setup again, click **Back**, and follow steps 6 and 7.

The device exists from the First Boot Wizard mode, and the ThinOS desktop is displayed.

Logging on to the Wyse 5070 thin client running Wyse ThinOS

What you see after logging on to the server depends on the administrator configurations.

- **Users with a Classic Desktop** - will see the classic ThinOS desktop with full taskbar, desktop, and Connect Manager familiar to ThinOS users. This option is the default out-of-the-box experience and is recommended for terminal server environments with published applications and for backward compatibility with ThinOS 6.x versions.
- **Users with a Zero Desktop** - will see the Zero Desktop with the Zero Toolbar showing the assigned list of connections from which to select. This option is recommended for VDI and any full-screen only connections.

In any desktop case, you can select the desktop option you want (Classic Desktop or Zero Desktop) and create the connections you need using the Visual Experience tab on the **Remote Connections** dialog box.

To open the **Remote Connections** dialog box, perform one of the following tasks:

- **Classic Desktop** — Click **User Name**, and then select **System Setup > Remote Connections**.
 - **NOTE:** User Name is the user who is logged-on and is located at the lower-left pane of the taskbar
- **Zero Desktop** — Click the **System Settings** icon on the Zero Toolbar, and then select **Remote Connections**.

Local settings menu

To access the Local settings menu:

- **Zero desktop** — Click the **System Settings** icon on the Zero toolbar. Administrators can also click the **Admin Mode** button on the **Login** dialog box.
- **Classic desktop** — Click **User Name**, and select **System Setup**.

NOTE: User Name is the user who is logged-on.

Configuring the keyboard settings

To configure the keyboard settings:

1. From the desktop menu, click **System Setup**, and then click **Peripherals**. The **Peripherals** dialog box is displayed.

- Click the **Keyboard** tab and set the Character Set, Keyboard Layout, Delay Before Repeat and Repeat Rate parameters. The following table explains the keyboard parameters.

Table 13. Keyboard parameters

Parameter	Description
Character Set	Lists the character sets. Each character is represented by a number. The ASCII character set, for example, uses the numbers 0 through 127 to represent all English characters and special control characters. European ISO character sets are similar to ASCII, but they contain additional characters for European languages.
Keyboard Layout	Presently the keyboard languages listed in the Keyboard layout drop-down list are supported. The default value is English (United States) .
Delay Before Repeat	Lists the repeat parameters. Select Delay Before Repeat value as either 1/5 second , 1/4 second , 1/3 second , 1/2 second , 3/4 second , 1 second , 2 seconds , or No Repeat . The default is 1/3 second .
Repeat Rate	Select Slow , Normal , or Fast . The default value is Medium .

- Click **OK** to save the settings.

Configuring the mouse settings

To configure the mouse settings:

- From the desktop menu, click **System Setup**, and then click **Peripherals**. The **Peripherals** dialog box is displayed.
- Click the **Mouse** tab, select the mouse speed and mouse orientation.
- Select the **Swap left and right mouse buttons** check box to swap mouse buttons for left-handed operations.
- Click **OK** to save the settings.

Configuring the display setup

Use the **Display Setup** dialog box to configure the display settings for the connected monitors.

To configure the display setup:

- From the desktop menu, click **System Setup**, and then click **Display**. The **Display Setup** dialog box is displayed.
- In the **Display Setup** dialog box, configure the following options:
 - Mirror mode**—Select the **Mirror mode** check box to enable all connected monitors to use the same display settings configured on the primary monitor.

The following screen represents the Mirror mode configuration.

If you clear the **Mirror mode** check box, the **Span Mode** is enabled. The following screen represents the span mode configuration.

Blocks displayed on the screen represent the number of monitor screens connected to thin client. Each block represents a single monitor screen.

Every monitor contains a unique display order number and display configuration. To construct a new display layout, move the blocks to your preferred position, and click **Apply**. A new display layout is created. However, the system sets the block to its default position if the block is moved to an incorrect position.

 **NOTE:** Wyse 5070 thin client supports up to six monitors.

- Main screen**—Select the **Main screen** check box to set the monitor as primary monitor or main screen. To set a monitor as main screen, click the monitor block, and select the **Main screen** check box. After you set the monitor as

main screen, the monitor block is highlighted with an underline, and the **Main screen** option is disabled for that monitor block. The **Main screen** option is available for other monitor blocks.

NOTE: Main screen option is effective only in **Span Mode** and always disabled in **Mirror Mode**.

- **Resolution**—From the **Resolution** drop-down list, select a display resolution supported by your monitor.
In **Mirror Mode**, the resolution list is derived from the intersection of resolutions in all connected monitors.
In **Span Mode**, select a monitor block and change its resolution from the **Resolution** drop-down list.
- **Rotation**—From the **Rotation** drop-down list, select an option to rotate the monitor screen in different directions—**Left turn 90 degrees** or **Right turn 90 degrees**. By default, the option is set to **None**.

3. Click **Apply**.

The new display settings are applied, and you can see the modified display.

4. Click **OK** to confirm the new settings.

NOTE: Use the **Identify** option, to know the display order number of the connected monitors.

Configuring the LPD settings

1. From the desktop menu, click **System Setup**, and then click **Printer**.

The **Printer Setup** dialog box is displayed.

2. Click the **LPDs** tab, and use the following guidelines when printing to a non-Windows network printer:

NOTE: Be sure to check with your vendor that the printer can accept from Line Printer Request.

- a. **Select LPD** —Select the required port from the list.
- b. **Printer Name** —(Required) Enter the name of the printer that is displayed on the Windows printer driver.
- c. **Printer Identification**—Enter the name of the printer exactly as it appears on the Windows printer driver.

In an MS Windows system, this name is either the device driver name of the printer or a key to map the printer to the device driver. The name will be defaulted to the printer-supplied identification for standard direct-connected USB printers or **Generic / Text** for non-USB connected printers on connection to Windows hosts. The driver name mapping takes place either through a printer-mapping file read by the system as part of the global profile (wnos.ini) or by MetaFrame servers through the MetaFrame printer configuration file (\winnt\system32\wtsprnt.inf).

- d. **LPD Hosts**—The DNS or WINS name of the server for the network printer. An IP address of the printer on the network can also be entered.

If the printer is attached to another thin client on your network, the entry in the LPD Hosts box is the name or address of that thin client.

- e. **LPD Queue Name** — An LPD host maintains a named queue for each supported printer. Enter the name of the queue associated with the printer to be used.

This name can be different for each vendor. This is a required field, and you must ensure to add the correct queue name, as the network printer uses this name for mapping the incoming print jobs. For example, auto can be used for HP LaserJet 4200n PCL6 as per documentation found on the HP Web site.

NOTE: If the printer is attached to another thin client on your network, the LPD Queue Name must match the content of the Printer Name box displayed on the thin client.

- f. **Printer Class** — (Optional) Select the printer class from the list.
- g. **Enable the printer device** — Select this option to enable the printer on a remote device.

3. Click **OK** to save the settings.

Configuring the printer settings

Use the **Printer Setup** dialog box to configure network printers and local printers that are connected to the thin client. A thin client has multiple ports that can be used for connecting multiple printers. You can also connect multiple printers to a single port by using a USB hub.

Configuring the ports settings

To configure the ports settings:

1. From the desktop menu, click **System Setup**, and then click **Printer**. The **Printer Setup** dialog box is displayed.

2. Click the **Ports** tab, and use the following guidelines:

- a. **Select Port**— Select the required port from the list. **LPT1** or **LPT2** are directly connected to the USB printer..
- b. **Printer Name** — (Required) Enter name you want displayed in your list of printers.

Most USB direct-connected printers report/fill in their printer name automatically.

NOTE: If **Enable LPD service for the printer** is selected, the printer name becomes the queue name for other clients that are using LPR to print to this printer.

- c. **Printer Identification** — Enter the printer name and model in the **Windows printer driver name**—including capitalization and spaces, most USB direct-connected printers report/fill in their printer identifications automatically.

This entry must be either the device driver name for the printer under the Microsoft Windows system, or a key to map to the device driver. The printer name is used to identify standard direct-connected USB printers or **Generic / Text Only** for non-USB connected printers on Windows hosts. The driver name mapping takes place either through a printer-mapping file read by the system as part of the global profile (wnos.ini) or by MetaFrame servers through the MetaFrame printer configuration file (\winnt\system32\wtsprnt.inf).

NOTE: The maximum characters allowed in the Printer Identification field is 31. If your printer driver string is more than 31 characters (including space), you can create a txt file (printer.txt) and upload to your file server. Edit the txt file and type the content, such as "**HP Color**" = "**HP Color LaserJet CM1312 MFP PCL6 Class Driver**". Add the command line `printermap=printer.txt` to your wnos.ini file. Now, you can type "**HP Color**" in the Printer Identification field instead of the full driver string.

- d. **Printer Class**— This is optional. Select the printer class from the list.
- e. **Enable the printer device** — Select this option to enable the directly-connected printer. It enables remote host to display the device.
- f. **Enable LPD service for the printer** — Select this to make the thin client. Write the spelled out for first, with abbreviation in parentheses.

NOTE:

If the thin client is to be used as an LPD printer server, DHCP must not be used and a static IP address must be assigned to the client.

3. Click **OK** to save the settings.

Configuring the LPD settings

1. From the desktop menu, click **System Setup**, and then click **Printer**. The **Printer Setup** dialog box is displayed.

2. Click the **LPDs** tab, and use the following guidelines when printing to a non-Windows network printer:

NOTE: Be sure to check with your vendor that the printer can accept from Line Printer Request.

- a. **Select LPD** —Select the required port from the list.
- b. **Printer Name** —(Required) Enter the name of the printer that is displayed on the Windows printer driver.
- c. **Printer Identification**—Enter the name of the printer exactly as it appears on the Windows printer driver.

In an MS Windows system, this name is either the device driver name of the printer or a key to map the printer to the device driver. The name will be defaulted to the printer-supplied identification for standard direct-connected USB printers or **Generic / Text** for non-USB connected printers on connection to Windows hosts. The driver name mapping takes place either through a printer-mapping file read by the system as part of the global profile (wnos.ini) or by MetaFrame servers through the MetaFrame printer configuration file (\winnt\system32\wtsprnt.inf).

- d. **LPD Hosts**—The DNS or WINS name of the server for the network printer. An IP address of the printer on the network can also be entered.

If the printer is attached to another thin client on your network, the entry in the LPD Hosts box is the name or address of that thin client.

- e. **LPD Queue Name** — An LPD host maintains a named queue for each supported printer. Enter the name of the queue associated with the printer to be used.

This name can be different for each vendor. This is a required field, and you must ensure to add the correct queue name, as the network printer uses this name for mapping the incoming print jobs. For example, auto can be used for HP LaserJet 4200n PCL6 as per documentation found on the HP Web site.

 **NOTE:** If the printer is attached to another thin client on your network, the LPD Queue Name must match the content of the Printer Name box displayed on the thin client.

- f. **Printer Class** — (Optional) Select the printer class from the list.
 - g. **Enable the printer device** — Select this option to enable the printer on a remote device.
3. Click **OK** to save the settings.

Configuring the SMBs settings

1. From the desktop menu, click **System Setup**, and then click **Printer**. The **Printer Setup** dialog box is displayed.
2. Click **SMBs** tab, and use the following guidelines when printing to a Windows network printer.
 - a. **Select SMB**—Select the SMB you want from the list.
 - b. **Printer Name**—(Required) Enter the name to be displayed in your list of printers.
 - c. **Printer Identification**—Enter the type or model of the printer in the exact text of the Windows printer driver name—including capitalizations and spaces.

This name must be either the device driver name for the printer under the Microsoft Windows system, or a key to map to the device driver. If not specified, the name will be defaulted to the printer-supplied identification for standard direct-connected USB printers or **Generic / Text** for non-USB connected printers upon connection to Windows hosts. The driver name mapping takes place either through a printer-mapping file read by the system as part of the global profile (wnos.ini) or by MetaFrame servers through the MetaFrame printer configuration file (\winnt\system32\wtsprnt.inf).

- d. **\\Host\Printer**—Enter the Host\Printer or use the browse folder icon next to the box to browse your Microsoft Networks and make the printer selection you want from the network printers available (the DNS name or IP address of the Windows print server on the network).
 - e. **Printer Class** —(Optional) Select the printer class from the list.
 - f. **Enable the printer device**—Must be selected to enable the printer. It enables the device so it displays on the remote host.
 - g. **Enable LPD service for the printer**—Select this to make the thin client an LPD (Line Printer Daemon) network print server for LPR printing requests from the network.

If the thin client is to be used as an LPD printer server, DHCP must not be used and a static IP address must be assigned to the thin client as described in network settings.
3. Click **OK** to save the settings.

Using the printer setup options

To configure the printer setup options:

1. From the desktop menu, click **System Setup**, and then click **Printer**. The **Printer Setup** dialog box is displayed.
2. Click the **Options** tab, and do the following:
 - a. **Default Printer** —From the list of available printers, select the printer that you want to be default printer.
 - b. **Enable .print Client** and **Port** —If you want to enable .print Client, select **Enable print Client** , and then enter the port name.
3. Click **OK** to save the settings.

Wyse 5070 thin client on ThinLinux

This section provides instructions on how to easily configure and efficiently manage Wyse 5070 thin client that runs on ThinLinux.

Topics:

- [Introduction](#)
- [Logging on to the Wyse 5070 thin client running ThinLinux](#)
- [Configuring peripherals settings on Wyse ThinLinux](#)

Introduction

The thin clients running Wyse ThinLinux from Dell simplifies the user management paradigm with elegant application icons and comes with a single built-in user to enhance user experience along with having the benefits of a single-operating system. ThinLinux running on thin client combines the security, flexibility, and market-leading usability of enterprise-grade Linux with Dell's thin computing optimizations in management. It is ideal for organizations that want to run server-based, Web-based, or local applications including legacy applications without the deployment and security concerns of a nonstandard Linux distribution.

Logging on to the Wyse 5070 thin client running ThinLinux

On your initial configuration, Dell recommends that you connect by using a wired connection by plugging in the network connected ethernet cable to your thin client.

After you turn on your thin client, you are automatically logged in to the local **thinuser** account. By default, the password of the thinuser account is set to **thinuser**.

 **NOTE:** In cases where a GDM login is needed (for example, AD/Domain login, PNAgent login and so on), the auto-login option can be turned off through the GUI or by using the INI.

Admin mode enables you to perform system administration tasks such as adding or removing connections and setting up specific device settings. To enter into the **Admin** mode, click the **Switch to Admin** button from **Setting application** screen to admin mode and then enter the default root password in the **Password Needed** window. The default root password is **admin**.

Configuring peripherals settings on Wyse ThinLinux

On the **System Settings** page, click the **Peripherals** icon. The following tabs are displayed on the left pane of the System Settings page.

- Keyboard
- Mouse
- Printers
- Sound

Configuring display on Dell Wyse ThinLinux

By default, the **Customize your display** screen is available in both User mode and Admin mode. Any changes to display preferences made through this screen is saved and available for the built-in thinuser. In a **Dual-monitor** configuration, if both monitors are connected, then by default, the monitors are in extended mode. The **primary monitor** is on the left (monitor 1)

and the **secondary monitor** is on the right (monitor 2). The resolutions of the monitors are auto detected by the system by analyzing the monitor's capabilities.

1. Click the **Display** tab.

The **Customize Your Display** page is displayed.

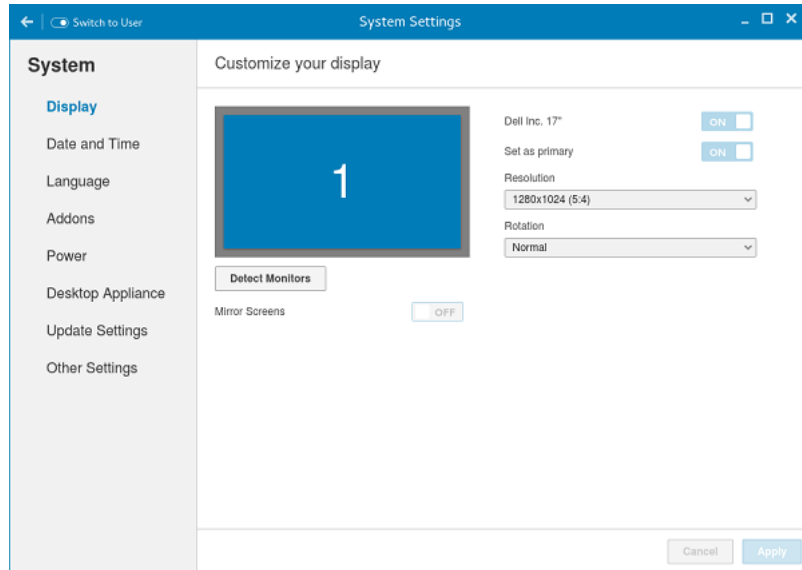

Figure 42. Display Settings

2. Select the preferred **Resolution** from the drop-down list.
3. Select the **Rotation** type from the drop-down list.
 - Normal
 - Right
 - Left
 - Upside-down
4. Click the **ON/OFF** button to switch between dual display and mirror mode in a dual monitor configuration.
5. Click the **ON/OFF** button to enable the **Set as primary** option. This option allows you to set the selected monitor as primary.
6. Click the **ON/OFF** button to enable the **Monitor On/Off** option. This option allows you to switch off and switch on the preferred monitor in a dual monitor configuration.

Setting the keyboard preferences

The **Keyboard** setting page enables you to set the Keyboard preferences and make the Keyboard layout.

NOTE: By default, the **Keyboard** screen is available in both User mode and Admin mode. Any changes made through Keyboard preferences screen is saved and continued for the built-in thinuser

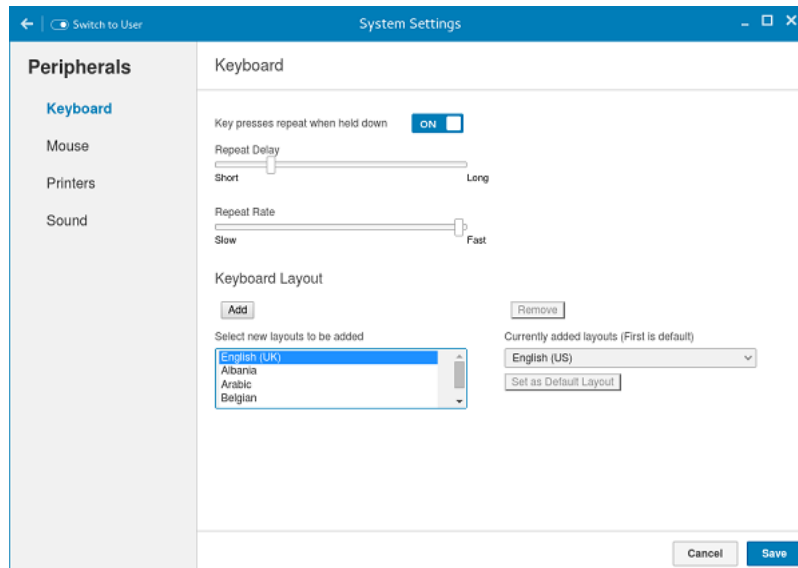

Figure 43. Keyboard Preferences

1. Click the **ON/OFF** button to disable or enable the **Key presses repeat when held down** option after you log in to the session.
2. Move the slider to the left to decrease the repeated delay time of the pointer or move the slider to the right to increase the repeated delay time of the pointer.
3. Move the slider to the left to decrease the repeat rate of the pointer or move the slider to the right to increase the repeat rate of the pointer.
4. In the **keyboard layout** box, select the layout you want to use and click **Add** to include the preferred layout in the **currently added layouts** list.
5. Select the preferred keyboard layout from the currently added layouts list, and click **Set as Default Layout** button to set the default layout.

NOTE: The default keyboard layout is listed on the top of the currently added layout list.

6. Click **Save** to save your changes.

Customizing the display

This section explains how to customize display for Wyse 5070 extended thin client.

Customizing Wyse 5070 extended thin client display

NOTE: This section is applicable only to Wyse 5070 extended thin client.

By default, the **Customize your display** screen is available in both user mode and admin mode. Any changes to display preferences are saved and available for the built-in user named **thinuser**.

To customize the display, do the following:

1. Click the **Display** tab.
The **Customize Your Display** page is displayed.
2. From the **Resolution** drop-down list, select the preferred resolution.
3. From the **Layout** drop-down list, select any of the following layout types:
 - **Horizontal**—Enables you to drag the applet window horizontally, from the primary monitor to the rest of the monitors.
 - **Vertical**—Enables you to drag the applet window vertically, from the primary monitor to the rest of the monitors.
 - **2 screens per row**—Enables you to drag the applet window from the primary monitor to the rest of the monitors as described in the following table. For example, you can drag the applet window from the primary monitor to monitor 2 horizontally, or to monitor 3 vertically.

Table 14. 2 screens per row layout

Applet window placement at monitor	Traverse horizontally to monitor	Traverse vertically to monitor
Primary monitor (Monitor 1)	Monitor 2	Monitor 3
Monitor 2	Primary monitor (Monitor 1)	Monitor 4
Monitor 3	Monitor 4	Monitor 5, Primary monitor (Monitor 1)
Monitor 4	Monitor 3	Monitor 2, Monitor 6
Monitor 5	Monitor 6	Monitor 3
Monitor 6	Monitor 5	Monitor 4



NOTE:

- You cannot drag the applet window diagonally across the monitors.
- Dell recommends that you set up even number of monitors for a better user experience. 3-monitor setup and 5-monitor setup are not recommended.

- **3 screens per row**—Enables you to drag the applet window from the primary monitor to the rest of the monitors as described in the following table. For example, you can drag the applet window from the primary monitor to monitor 2 horizontally, or to monitor 4 vertically.

Table 15. 3 screens per row layout

Applet window placement at monitor	Traverse horizontally to monitor	Traverse vertically to monitor
Primary monitor (Monitor 1)	Monitor 2	Monitor 4
Monitor 2	Monitor 3, Primary monitor (Monitor 1)	Monitor 5
Monitor 3	Monitor 2	Monitor 6
Monitor 4	Monitor 5	Primary monitor (Monitor 1)
Monitor 5	Monitor 4, Monitor 6	Monitor 2
Monitor 6	Monitor 5	Monitor 3



NOTE:

- You cannot drag the applet window diagonally across the monitors.
- Dell recommends that you set up six monitors for a better user experience. 4-monitor setup and 5-monitor setup are not recommended.

Setting the mouse preferences

By default, the **Mouse** screen is available in both User mode and Admin mode. Any changes made through the Mouse preferences screen is saved and continued for the built-in thinuser.

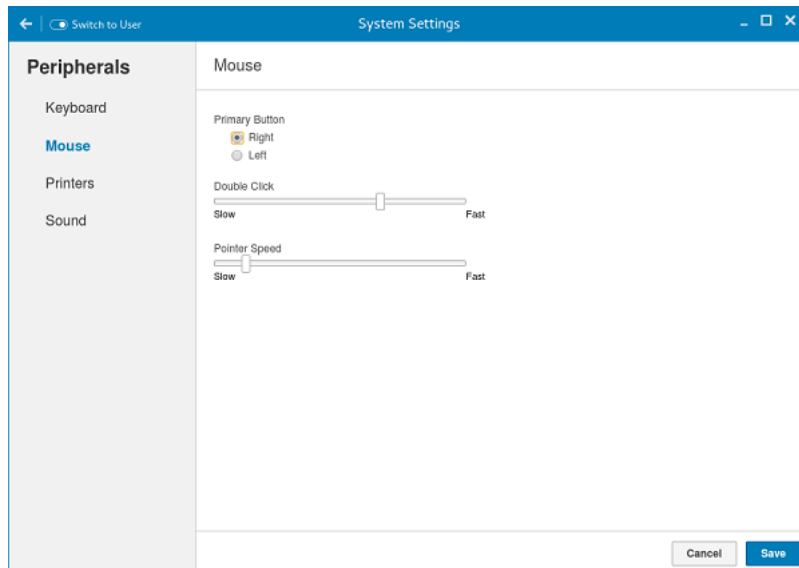

Figure 44. Mouse Preferences

The Mouse setting page enables you to set the Mouse preferences.

1. Click **Right** or **Left** to set the **primary button** of the mouse.
2. Move the slider to the left to increase the speed of the pointer when double-clicked or move the slider to the right to decrease the length of double-clicked.
3. Move the slider to the left to increase the speed of the mouse pointer or move the slider to the right to decrease the speed of the mouse pointer.
4. Click **Save** to save your changes.

Configuring the printer settings

By default, the **Printers** screen is available only in Admin mode. On the **Printer setting** page, click the printer icon to start the **gnome-control-center printer**.

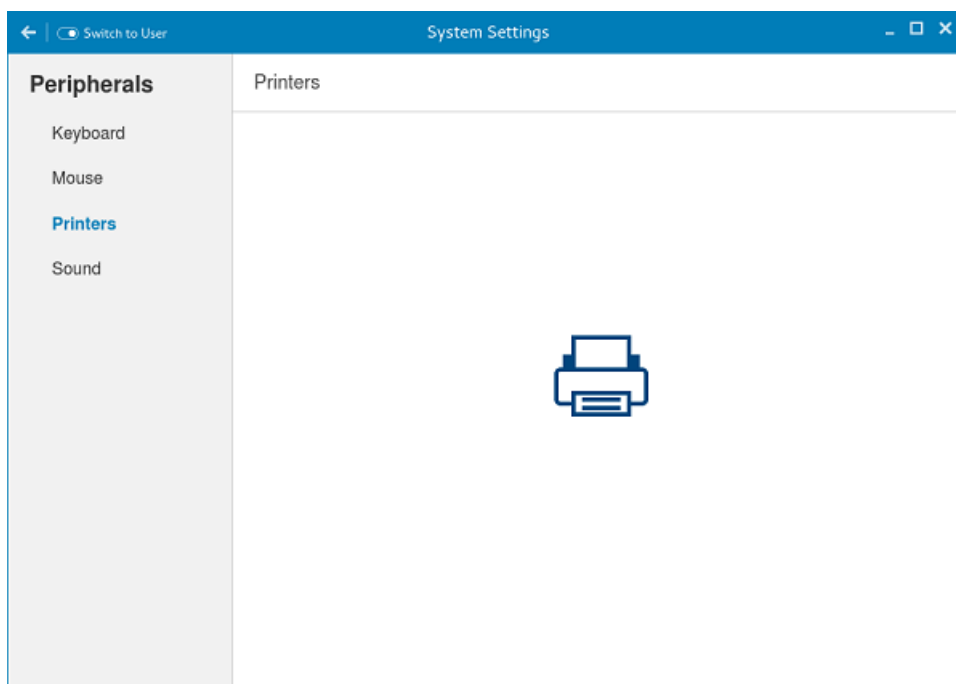

Figure 45. Printer Settings

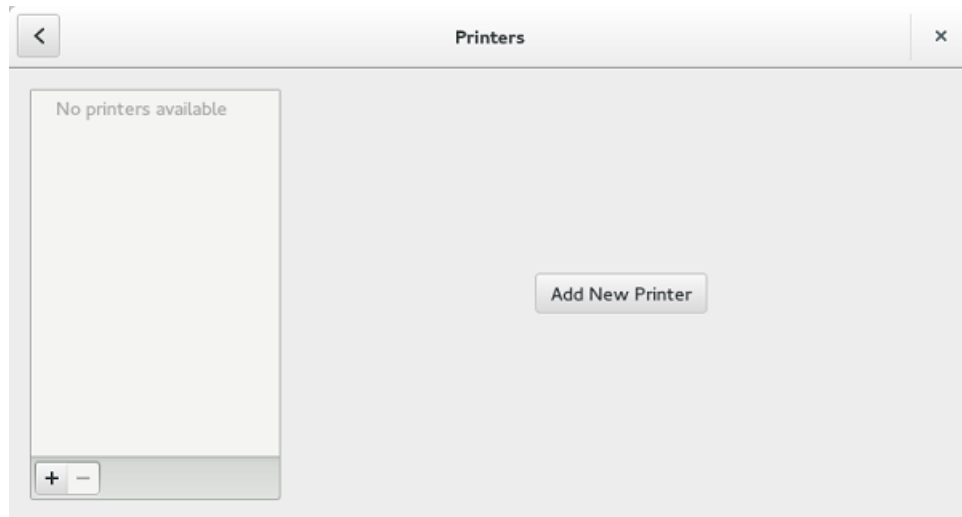

Figure 46. Add New Printer

1. Click the printer icon.
The **gnome-control-center printer** dialog box is displayed.
2. Click **Add New Printer** button to include the new printer in the printers list available on the left pane.
The **Add a new printer** window is displayed.
3. Enter the address of the printer or the text to filter results.
NOTE: If a USB printer is connected, then it is displayed by default. The printer is not found if wrong address is provided or the USB is not attached.
4. Click the **Add** option. Click **Print Test Page** to test the printer and click **(-)** icon to remove the printer.

Wyse 5070 thin client on Windows 10 IoT Enterprise

This section provides the instructions on how to easily configure and efficiently manage Wyse 5070 thin client that runs on Windows 10 IoT Enterprise.

Topics:

- [Introduction](#)
- [Before configuring your thin clients](#)
- [Automatic and manual login](#)
- [Keyboard and region settings](#)
- [Devices and printers](#)

Introduction

The thin clients running Windows 10 IoT Enterprise provide access to applications, files, and network resources. The applications and files are made available on machines hosting Citrix Receiver, Microsoft Remote Desktop Connection, VMware Horizon client session, and Dell Wyse vWorkspace services.

Other locally installed software permits remote administration of the thin clients and provides local maintenance functions. More add-ons are available that support a wide range of specialty peripherals and features for environments that require a secure user interface with 64-bit Windows compatibility. Your thin client device supports Microsoft Silverlight, Microsoft Lync VDI 2013 plug-in, and Microsoft .Net Framework 4.6 or later versions. For more information, see [Microsoft Website](#)

Before configuring your thin clients

Before you configure your thin clients, ensure that you configure Unified Write Filter and xData Cleanup Manager that protect your thin clients. The Unified Write Filter Utility prevents undesired flash memory writes, and xData Cleanup Manager cleans up extraneous information from being stored on the local disk.

However, there are instances where administrators can retain the changed configurations after you log out and restart the thin client.

Automatic and manual login

What you see when a thin client turns on or reboots depends on the administrator's configuration. After creating a user account, an administrator can configure the account to log in automatically or manually with user credentials. Ensure that you disable the Unified Write Filter (UWF) before you change a password on the thin client, and then enable UWF after your change. To change the password, press Ctrl+Alt+Delete, and then click **Change a password**. However, this feature is not applicable for **User** accounts.

CAUTION:

CAUTION: Please follow proper write filter and Windows Page File usage instructions at all times. Such instructions include making sure that the write filter is enabled during regular use and is disabled only temporarily by an administrator when required for image upgrades, applying security patches, registry changes and application installation. The write filter should be re-enabled as soon as such tasks are completed. Such instructions further include never enabling the Windows Page File feature during regular use of the thin client.

Any operation of a Dell Wyse Windows Embedded Thin Client with the write filter turned off during regular use and/or with the Windows Page file enabled will prematurely wear out your Flash/SSD storage, decrease performance and decrease the lifespan of the product.

Dell is not responsible for, and will not, warrant, support, repair or replace any thin client device or component that fails to operate properly due to a failure to follow these instructions.

When you start the thin client, you will automatically log in to the user desktop by default.

 **NOTE:** The Windows icon on the taskbar is the start menu button.

To log in as a different user or administrator:

1. Go to **Start > User icon > Sign Out** to log out from the current desktop.
2. Click anywhere on the lock screen to view the login window.
3. You can view the user accounts list on the screen. Click the preferred user account and then enter the login credentials.
 - **Administrators**—The default user name is **Admin** and the default case-sensitive password is **DellCCCvdi**.
 - **Users**—The default user name is **User** and default case-sensitive password is **DellCCCvdi**.
 - **Customized User**—Log in to your thin client by entering the user credentials which you have set for the customized user account.

If automatic login is not enabled, the login window displays when you boot the thin client device. You can log in using the options mentioned in **step 2** and **step 3**.

Enabling auto logon

Automatic logon to a user desktop is enabled by default on the thin client device. To enable or disable auto logon, and to change the default user name, password, and domain for a thin client, use the auto logon feature.

To enable/disable auto logon:

1. Log in as an administrator.
2. Go to **Start > Dell Thin Client Application**.
The **Dell Thin Client Application** window is displayed.
3. On the left navigation bar, click **Auto Logon**.
4. To start with the admin logon page, enter **Admin** in the **Default User Name** field.

 **NOTE:** By default, the **Enable Auto Logon** check box is selected.

5. If you want to start with the **Logon** window with default administrator and user selections and other accounts, clear the **Enable Auto Logon** check box.

 **CAUTION:** To permanently save the information, disable/enable the Unified Write Filter (UWF). For more information, see [Before Configuring your thin clients](#).

 **NOTE:**

If auto login is enabled and you log off from your current desktop, the lock screen is displayed. Click anywhere on the lock screen to view the **Logon** window. Use this window to log in to your preferred administrator or user account.

Keyboard and region settings

To select your regional formats including keyboard and the Windows display languages, use the **Region** dialog box.

To select your regional formats, do the following:

1. Log in as an administrator.
2. Go to **Start > Control Panel > Region**.
The **Region** dialog box is displayed.
3. In the **Formats** tab, select the language, date, and time.

To customize the formats, do the following:

- a. Click **Additional Settings**.
The **Customize Format** window is displayed.
 - b. Customize the settings, and click **OK**.
4. Click **Apply**, and then click **OK**.
 5. In the **Location** tab, select a particular location to display additional information such as news and weather.
 6. In the **Administrative** tab, change the language to be displayed in programs that do not support Unicode, and copy the settings.

Devices and printers

To add devices and printers, use the **Devices and Printers** window.

 **CAUTION: To refrain from cleaning up your settings, disable/enable the Unified Write Filter (UWF) and configure Application Launch Manager and xData Cleanup Manager. For more information, see [Before Configuring your thin clients](#).**

To add a device or a printer to the thin client, do the following:

1. Log in as an administrator.
2. Go to **Start > Control Panel > Devices and Printers**.
The **Devices and Printers** window is displayed.

Adding printers

To add a printer to the thin client:

1. Click the **Devices and Printers** icon in Control Panel.
The **Devices and Printers** window is displayed.
2. To open and use the **Add a Printer** wizard, click **Add a Printer**.

The **Add a Printer** wizard session starts.

A Dell Open Print Driver is installed on the thin client along with other built-in print drivers. To print full text and graphics to a local printer, install the driver provided by the manufacturer according to the instructions.

Printing to network printers from **Citrix Receiver**, **Remote Desktop Connection** or **VMware Horizon Client** applications can be achieved through printer drivers on the servers.

Printing to a local printer from **Citrix Receiver**, **Remote Desktop Connection** or **VMware Horizon Client** application using the printer drivers of the server produces full text and graphics functionality from the printer. Install the printer driver on the server, and the text only driver on the thin client using the following procedure:

- a. Click **Add a local printer**, and click **Next**.
- b. Click **Use an existing port**, select the port from the list, and then click **Next**.
- c. Select the manufacturer and model of the printer, and click **Next**.
- d. Enter a name for the printer and click **Next**.
- e. Select **Do not share this printer** and click **Next**.
- f. Select whether to print a test page and click **Next**.
- g. Click **Finish** to complete the installation.

A test page will print after installation if this option was selected.

Configuring multi-monitor display

You can use the **Screen Resolution** window to configure dual monitor settings on your dual-monitor capable thin client device.

To open the **Screen Resolution** window, do the following:

1. Log in as an administrator.
2. Go to **Start > Control Panel > Display > Change Display Settings**.
The **Screen Resolution** window is displayed. For detailed instructions on how to configure the screen resolution, go to www.microsoft.com.

For information about setting up multiple monitors, see the *How to Set up Multiple Monitors in Windows 10* at support.dell.com.

BIOS overview

Topics:

- [Accessing thin client BIOS settings](#)
- [System Setup overview](#)
- [Boot Sequence](#)
- [Navigation keys](#)
- [General screen options](#)
- [System Configuration screen options](#)
- [Video screen option](#)
- [Security screen options](#)
- [Secure Boot screen options](#)
- [Performance screen options](#)
- [Power management screen options](#)
- [POST behavior screen options](#)
- [Wireless screen option](#)
- [Virtualization support screen options](#)
- [Maintenance screen options](#)
- [System Logs screen option](#)

Accessing thin client BIOS settings

This section describes about the Wyse 5070 thin client UEFI BIOS settings. While starting a thin client, a Dell logo is displayed for a short period.

1. During start-up, press the **F2** key, and enter the default password **Fireport**. The **BIOS** settings dialog box is displayed.
2. Use the **System Setup** settings to change the BIOS settings.

 **NOTE:** There is an option to restore BIOS defaults, Factory Defaults, and Custom user settings for Users in the BIOS menu. BIOS default setting restores the values that was part of the BIOS file. Restoring Factory default restores the BIOS setting to the values that was configured in factory before shipping the client.

To access the boot menu during start-up, press the **F12** key. Use the **Boot Selection** menu to select or view the boot sequence order as follows:

- Boot from UEFI: Hard Drive, Partition 4
- Onboard NIC (IPV4)
- Onboard NIC (IPV6)

System Setup overview

System Setup allows you to:

- Change the system configuration information after you add, change, or remove any hardware in your thin client.
- Set or change a user-selectable option such as the user password.
- Read the current amount of memory or set the type of hard drive installed.

Before you use System Setup, Dell recommends that you write down the **System Setup** screen information for future reference.

 **CAUTION:** Unless you are an expert thin client user, do not change the settings for this program. Certain changes can cause your thin client to work incorrectly.

Boot Sequence

Boot Sequence allows you to bypass the System Setup–defined boot device order and boot directly to a specific device. During the Power-on Self Test (POST), when the Dell logo appears you can:

- Access System Setup by pressing the F2 key
- Bring up the one-time boot menu by pressing the F12 key

The one-time boot menu displays the devices that you can boot from including the diagnostic option. The boot menu options are:

- UEFI Boot
 - UEFI: Hard drive, Partition 4
 - Onboard NIC (IPV4)
 - Onboard NIC (IPV6)
- Other options
 - BIOS Setup
 - BIOS Flash Update
 - Diagnostics

i **NOTE:** If you select the Diagnostics option, the **ePSA diagnostics** screen is displayed. To access the System setup menu, click **BIOS Setup**.

Navigation keys

i **NOTE:** For most of the System Setup options, changes that you make are recorded but do not take effect until you restart the system.

Table 16. Navigation keys

Keys	Navigation
Up arrow	Moves to the previous field.
Down arrow	Moves to the next field.
Enter	Selects a value in the selected field (if applicable) or follow the link in the field.
Spacebar	Expands or collapses a drop-down list, if applicable.
Tab	Moves to the next focus area. i NOTE: This option is applicable for the standard graphics browser only.
Esc	Moves to the previous page until you view the main screen. Pressing Esc in the main screen displays a message that prompts you to save any unsaved changes and restarts the system.

General screen options

This section lists the primary hardware features of your computer.

Table 17. General screen options

Option	Description
System Information	This section lists the primary hardware features of your computer. <ul style="list-style-type: none">• System Information: Displays BIOS Version, Service Tag, Asset Tag, Ownership Tag, Ownership Date, Manufacture Date, Express Service Code, the Signed Firmware update —enabled by default

Table 17. General screen options (continued)

Option	Description
	<ul style="list-style-type: none"> ● Memory Information: Displays Memory Installed, Memory Available, Memory Speed, Memory Channels Mode, Memory Technology, DIMM A Size, DIMM B Size ● NOTE: Since Memory Available is less than the Memory Installed, certain operating systems may not be able to use all the available memory. ● PCI information: Displays Slot details, by default Slot1 is empty. ● Processor Information: Displays Processor Type, Core Count, Processor ID, Current Clock Speed, Minimum Clock Speed, Maximum Clock Speed, Processor L2 Cache, Processor L3 Cache, HT Capable, and 64-Bit Technology ● Device Information: Primary Hard Drive, EMMC Device, LOM MAC Address, 2nd NIC MAC Address, Video Controller, Audio Controller, Wi-Fi Device, Bluetooth Device
Boot Sequence	<p>This option enables you to change the order in which the system boots an operating system.</p> <ul style="list-style-type: none"> ● Default Boot Sequence <ul style="list-style-type: none"> ○ UEFI: Hard Drive, Partition 4 ○ Onboard NIC(IPV4) ○ Onboard NIC(IPV6) ● Boot List Option: You can add a boot option, delete an existing boot option, and view the boot options.
UEFI boot path security	<p>This option enables you to control the system prompt of How to enter the Admin Password (if set) when you boot a UEFI boot path from the F12 boot menu.</p> <p>The options include:</p> <ul style="list-style-type: none"> ● Always, except internal HDD (default) ● Always ● Never
Date/Time	<p>This option enables you to change the system date and time.</p>

System Configuration screen options

Table 18. System Configuration options

Option	Description
UEFI Network Stack	<p>If the UEFI Network Stack option is enabled, the UEFI Networking Protocols are installed and allows pre-operating system and early operating system networking features to use any enabled NICs or SFP.</p> <p>The UEFI Network Stack option is enabled by default.</p>
Integrated NIC	<p>The Integrated NIC option controls the on-board LAN controller. The options include:</p> <ul style="list-style-type: none"> ● Disabled—The internal LAN is off and not visible to the operating system. ● Enabled—The internal LAN is enabled. ● Enabled w/PXE—The internal LAN is enabled (with PXE boot). This option is enabled by default.

Table 18. System Configuration options (continued)

Option	Description
2nd NIC (RJ-45/SFP)	<p>The second NIC (RJ-45/SFP) option controls the second on-board NIC. The options include:</p> <ul style="list-style-type: none"> ● Disabled ● Enabled ● Enabled w/PXE—This option is enabled by default
Parallel Port	<p>This option determines how the parallel port on the docking station operates. The options include:</p> <ul style="list-style-type: none"> ● Disabled ● AT—enabled by default ● PS2 ● ECP
Serial Port1	<p>This option determines how the serial port on the docking station operates. It allows you to avoid resource conflicts between devices by disabling or remapping the address. The options include:</p> <ul style="list-style-type: none"> ● Disabled ● COM1—enabled by default ● COM2
SATA Operation	<p>This option configures the operating mode of the integrated SATA hard drive controller. The options include:</p> <ul style="list-style-type: none"> ● Disabled ● AHCI—enabled by default
Drives	<p>Allows you to configure the SATA drives on board.</p> <ul style="list-style-type: none"> ● SATA-0 enabled by default
SMART Reporting	<p>This field controls whether the hard drive errors of integrated drives are reported during system startup.</p>
USB Configuration	<p>This is an optional feature.</p> <p>This field configures the integrated USB controller. If Boot Support is enabled, the system is allowed to boot any type of USB Mass Storage Devices such as hard drives and USB keys.</p> <p>If the USB port is enabled, the device attached to this port is enabled and available for the operating system.</p> <p>If the USB port is disabled, the operating system cannot detect any device attached to this port.</p> <p>The options include:</p> <ul style="list-style-type: none"> ● Enable USB Boot Support—enabled by default ● Enable Front USB Ports—enabled by default ● Enable Rear USB Ports—enabled by default <p> NOTE: USB keyboard and mouse always work in the BIOS setup irrespective of these settings.</p>
Front USB Configuration	<p>This option enables or disables front USB ports. The options include:</p> <ul style="list-style-type: none"> ● Front port Top—enabled by default ● Front port Bottom Medium—enabled by default ● Front port Top Medium—enabled by default ● Front port Bottom—enabled by default
Rear USB Configuration	<p>This option enables or disables rear USB ports. The options are:</p> <ul style="list-style-type: none"> ● Rear port Top Left—enabled by default

Table 18. System Configuration options (continued)

Option	Description
	<ul style="list-style-type: none"> • Rear port Bottom Left—enabled by default • Rear port Top Right—enabled by default • Rear port Bottom Right—enabled by default
USB PowerShare	This option configures the USB PowerShare feature and allows you to charge external devices through the USB PowerShare port when system is off. This option is enabled by default.
Audio	<p>This option enables or disables the integrated audio controller. By default, the Enable Audio option is selected. The options include:</p> <ul style="list-style-type: none"> • Enable Microphone—enabled by default • Enable Internal Speaker—enabled by default

Video screen option

Table 19. Video screen option

Option	Description
Primary Display	<p>This option determines which video controller is the primary display when multiple controllers are available in the system. The options include:</p> <ul style="list-style-type: none"> • Auto—enabled by default • Intel HD Graphics

Security screen options

Table 20. Security screen options

Option	Description
Admin Password	<p>This option enables you to set, change, or delete the administrator password.</p> <p>NOTE:</p> <ul style="list-style-type: none"> • You must set the administrator password before you set the system or hard drive password. Also, deleting the administrator password automatically deletes the system password and the hard drive password. • Successful password changes take effect immediately. <p>By default, the administrator password is not set.</p>
System Password	<p>This option enables you to set, change, or delete the system password.</p> <p>NOTE: Successful password changes take effect immediately.</p> <p>By default, the administrator password is not set.</p>
Strong Password	<p>This option enables you to enforce the option to always set strong passwords.</p> <p>By default, the Enable Strong Password option is not selected.</p> <p>NOTE: If Strong Password is enabled, the administrator and system passwords must contain at least one</p>

Table 20. Security screen options (continued)

Option	Description
	<p>uppercase character and one lowercase character. The password must be at least eight characters long.</p>
Password Configuration	<p>This option enables you to specify the minimum and maximum password lengths of the administrator and system passwords.</p> <ul style="list-style-type: none"> ● min-4—By default, the minimum value is set to 4. You can increase the value. ● max-32—By default, the maximum value is set to 32. You can decrease the value.
Password Bypass	<p>This option enables you to enable and disable the permission to bypass the system and the internal hard drive password, when they are set. The options are:</p> <ul style="list-style-type: none"> ● Disabled—enabled by default ● Reboot Bypass
Password Change	<p>This option enables you to enable the disable permission to the system and hard drive passwords when the administrator password is set.</p> <p>By default, the Allow Non-Admin Password Changes option is selected.</p>
UEFI Capsule Firmware Updates	<p>This option enables you to enable or disable UEFI Capsule Firmware. This option controls whether this system enables BIOS update through UEFI capsule update packages. This option is enabled by default.</p>
TPM 2.0 Security	<p>This option enables you to enable the Trusted Platform Module Technology feature. The options include:</p> <ul style="list-style-type: none"> ● TPM On—enabled by default ● Clear ● PPI Bypass for Enable Commands ● Attestation Enable—enabled by default ● PPI Bypass for Disable Commands ● Key Storage Enable—enabled by default ● PPI Bypass for Clear Command ● SHA-256—enabled by default ● Disabled ● Enabled—selected by default
Chassis Intrusion	<p>This option enables you to controls the chassis intrusion feature. The options include:</p> <ul style="list-style-type: none"> ● Clear Intrusion Warning ● Disabled—enabled by default ● Enabled ● On-Silent
Admin Setup Lockout	<p>This option enables you to prevent users from entering Setup when an administrator password is set.</p>
SMM Security Mitigation	<p>This option enables you to enable and disable additional UEFI SMM security mitigation protections.</p>

Secure Boot screen options

Table 21. Secure Boot screen options

Options	Description
Secure Boot Enable	This option enables or disables the secure boot feature. By default, the Secure Boot Enable option is not set.
Secure Boot Mode	This option enables you to change the secure boot operation mode, modifies the behavior of secure boot to allow evaluation or enforcement of the UEFI driver signatures. The options include: <ul style="list-style-type: none"> • Deployed Mode • Audit Mode
Expert Key Management	<p>This option enables you to manipulate the security key databases only if the system is in Custom Mode. The Enable Custom Mode option is disabled by default. The options include:</p> <ul style="list-style-type: none"> • PK • KEK • db • dbx <p>If you enable the Custom Mode, the relevant options for PK, KEK, db, and dbx is displayed. The options are:</p> <ul style="list-style-type: none"> • Save to File—Saves the key to a user-selected file • Replace from File—Replaces the current key with a key from a user-selected file • Append from File—Adds a key to the current database from a user-selected file • Delete—Deletes the selected key • Reset All Keys—To reset the default setting • Delete All Keys—Deletes all the keys <p>NOTE: If you disable the Custom Mode, all the changes are erased and the keys are restored to the default settings.</p>

Performance screen options

Table 22. Performance options

Option	Description
Multi Core Support	This option specifies whether one or more cores are enabled on the processor. The options include: <ul style="list-style-type: none"> • All—enabled by default • 1 • 2 • 3
Intel SpeedStep	<p>This option enables you to enables or disables the Intel SpeedStep feature. The option is:</p> <p>Enable Intel SpeedStep</p> <p>This option is enabled by default.</p>
C-States Control	This option enables you to enables or disables the additional processor sleep states.

Table 22. Performance options (continued)

Option	Description
	This option is disabled by default.
Intel TurboBoost	This option enables you to enable or disable the Intel TurboBoost mode of the processor. The option is: Enable Intel TurboBoost—This option is enabled by default.

Power management screen options

Table 23. Power management options

Option	Description
AC Recovery	This option enables you to control the system's behavior when AC power is restored after a AC power loss. <ul style="list-style-type: none"> • Power Off—enabled by default • Power On • Last Power State
Auto On Time	This option enables you to set the time at which the computer must turn on automatically. The options include: <ul style="list-style-type: none"> • Disabled—enabled by default • Every Day • Weekdays • Select Days
Deep Sleep Control	This option enables you to determine on how aggressive the system is at conserving power while shutdown—S5 or in Hibernate (S4) mode. The options include: <ul style="list-style-type: none"> • Disabled—This option enabled by default • Enabled in S5 only • Enabled in S4 and S5
Fan Control Override	This option enables you to determine the speed of the system fan. By default, the Fan Control Override option is disabled.
USB Wake Support	This option enables USB devices to wake the system from standby. i NOTE: This feature is only functional when the AC power adapter is connected. If the AC power adapter is removed during standby, the system setup removes power from all the USB ports to conserve battery power. The Enable USB Wake Support option is enabled by default.
Wake on LAN	This option enables or disables the feature that powers on the computer from the Off state when triggered by a LAN signal. The options include: <ul style="list-style-type: none"> • Disabled • LAN Only—This option is enabled by default. • LAN with PXE Boot
Wake on 2nd NIC (RJ-45/SFP)	This option enables the computer to power up from the OFF state when triggered by special LAN signals. The options include: <ul style="list-style-type: none"> • Disabled—This option is enabled by default. • LAN Only

Table 23. Power management options (continued)

Option	Description
	<ul style="list-style-type: none"> LAN with PXE Boot
Block Sleep	<p>The Block Sleep option blocks you from entering to sleep mode in the operating system environment.</p> <p>Block Sleep—This option is disabled by default.</p>

POST behavior screen options

Table 24. POST behavior options

Option	Description
Adapter Warnings	<p>This option enables or disables the system setup (BIOS) warning messages when you use certain power adapters.</p> <p>By default, the Enable Adapter Warnings option is enabled.</p>
Keypad Error	<p>This option enables you to specify whether keyboard related errors are reported when the system boots. By default, the Enable Keyboard Error Detection option is enabled</p>
Numlock LED	<p>This option enables and disables the Numlock LED when the system boots.</p> <p>By default, this option is enabled.</p>
Fastboot	<p>This option enables you to speed up the boot process by bypassing some of the compatibility steps. The options include:</p> <ul style="list-style-type: none"> Minimal Thorough—This option is enabled by default. Auto
Extended BIOS POST Time	<p>This option enables you to create an extra preboot delay. The options include:</p> <ul style="list-style-type: none"> 0 seconds—This option is enabled by default. 5 seconds 10 seconds
Full Screen Logo	<p>This option enables or disables the full screen logo. By default, the Enable Full Screen Logo option is not enabled.</p>

Wireless screen option

Table 25. Wireless option

Option	Description
Wireless Device Enable	<p>This options enables or disables the internal wireless devices. The options include:</p> <ul style="list-style-type: none"> WLAN/WiGig — enabled by default Bluetooth—enabled by default

Virtualization support screen options

Table 26. Virtualization options

Option	Description
Virtualization	This option enables or disables the Intel Virtualization Technology. Enable Intel Virtualization Technology (default).
VT for Direct I/O	This option specifies whether a virtual machine monitor can utilize the additional hardware capabilities provided by Intel Virtualization Technology for Direct I/O. This option is not enabled by default.

Maintenance screen options

Table 27. Maintenance options

Option	Description
Service Tag	Displays the Service Tag of your computer.
Asset Tag	This option enables you to create a system asset tag if an asset tag is not already set. This option is not set by default.
SERR Messages	This option enables you to control the SERR message mechanism. The Enable SERR Message option is enabled by default.
BIOS Downgrade	This controls flashing of the system firmware to previous revisions. The option Allow BIOS downgrade is enabled by default.
Data Wipe	This field enables you to erase the data securely from all internal storage devices. Option Wipe on Next boot is not enabled by default. The following is the list of devices affected: <ul style="list-style-type: none"> • Internal SATA HDD/SSD • Internal M.2 SATA SDD • Internal M.2 PCIe SSD • Internal eMMC  CAUTION: All the information will be lost if you enable this option.
BIOS Recovery	This option enables you to recover certain corrupted BIOS conditions from a recover file on the user's primary hard drive or an external USB key. <ul style="list-style-type: none"> • BIOS Recovery from Hard Drive—enabled by default • BIOS Auto-Recovery—disabled by default
First Power On Date	This option enables you to set the ownership date. The Set Ownership Date option is not set by default.

System Logs screen option

Table 28. System Logs screen option

Option	Description
BIOS Events	This option enables you to delete all the logs.

Troubleshooting your system

You can troubleshoot your system using indicators like diagnostic lights, and error messages during the operation of the device.

Topics:

- [Power state and LED status](#)
- [Power behavior](#)
- [Power LED error code behavior](#)

Power state and LED status

Table 29. Power states and LED behavior

Indicator	Symptoms	Description
Power LED	Solid white	Thin client is in working—S0 state.
	Breathing white	Thin client is in sleep—S3 state.
	Off	Thin client is in off state.
	Solid amber	Thin client booting is in progress.
	Blinking amber	Bad power supply.

 **NOTE:** Press and hold the power button for at least 4 seconds to shut down the thin client forcibly.

Power behavior

Table 30. Power behavior

AC adapter	System behavior	POST error message
AC adapter power is greater than or equal to the system power requirement at full CPU speed.	System boots normally and allows CPU to run at full speed.	None
AC adapter Power is less than the system power requirements at full CPU speed.	Lower the maximum CPU speed to a value that does not exceed the power available by the AC adapter.	Alert—xxxxxxW AC power adapter has been detected, which is less than the recommended xxxxxxW AC adapter originally shipped. The system adjusts the performance to match the power available. Connect a Dell xxxxxxW AC adapter or greater for best system performance.
AC adapter is not genuine Dell.	Limit the CPU speed to the lowest possible value.	Alert—xxxxxxW AC power adapter has been detected, which is less than the recommended xxxxxxW AC adapter originally shipped. The system adjusts the performance to match the power available. Connect a Dell xxxxxxW AC adapter or greater for best system performance.
AC adapter power is less than power state of CPU.	No boot or error message, but the system shuts down.	If the system is able to boot:

Table 30. Power behavior (continued)

AC adapter	System behavior	POST error message
		Alert—xxxxxxW AC power adapter has been detected, which is less than the recommended xxxxxxW AC adapter originally shipped. The system is unable to boot. Please connect a Dell xxxxxxW AC adapter or greater for best system performance. Press any key to shut down.

Power LED error code behavior

Table 31. Power LED error code behavior

LED# of flashes	Fault description	Fault	Action	Comment
2,1	CPU	CPU Failure	Type A	
2,2	Motherboard: BIOS ROM failure	Motherboard, covers BIOS corruption or ROM error	NA	Not applicable to X7 BIOS. No Test Case support.
2,3	Memory	No Memory/RAM detected	NA	Not supported. Memory is solder down on Motherboard. It is difficult to validate this function.
2,4	Memory	Memory/RAM failure	Type A	Supported. Memory is solder down on Motherboard, the Service team could replace the motherboard/memory to repurpose the board for repair.
2,5	Memory	Invalid memory is installed	NA	Memory is solder down on motherboard.
2,6	Motherboard: Chipset	Motherboard / Chipset error	NA	This code is not supported. HW dependent.
2,7	LCD	LCD failure	NA	This code is not supported. There is no LCD.
3,1	RTC Power failure	CMOS battery failure	Type B	
3,2	PCI / Video	PCI or Video card/ Chip failure	NA	Not applicable to X7 BIOS. No test case support.
3,3	BIOS Recovery 1	Recovery Image not found	Type A	
3,4	BIOS Recovery 2	Recovery Image found but invalid	Type A	
4,1	CPU Config or CPU Failure		NA	This code is not supported.

Table 31. Power LED error code behavior (continued)

LED# of flashes	Fault description	Fault	Action	Comment
4,2	Generic POST Video Error—Old LED pattern 1110		NA	Not applicable to X7 BIOS. No test case support.

Example: **LED# of flashes: 2,1** indicates that LED blinks two times, pauses, and then blinks once.

Troubleshooting action

- Type A
 - Log the fault event.
 - Emit the LED error code pattern.
 - Repeat the LED error code pattern in a dead-loop.
- Type B
 - Log the fault event, if possible.
 - Emit the LED error code pattern.
 - Repeat the LED error code 3 more times.
 - Leave the LED light up in amber color.
 - Continue with POST.