

Latitude 3320

Service Manual



Notes, cautions, and warnings

 **NOTE:** A NOTE indicates important information that helps you make better use of your product.

 **CAUTION:** A CAUTION indicates either potential damage to hardware or loss of data and tells you how to avoid the problem.

 **WARNING:** A WARNING indicates a potential for property damage, personal injury, or death.

Chapter 1: Working inside your computer	6
Safety instructions.....	6
Before working inside your computer.....	6
Entering Service Mode.....	7
Exiting Service Mode.....	7
Safety precautions.....	7
Electrostatic discharge—ESD protection.....	8
ESD field service kit	8
Transporting sensitive components.....	9
After working inside your computer.....	9
Chapter 2: Removing and installing components	10
Recommended tools.....	10
Screw List.....	10
Major components of your system.....	12
MicroSD-card.....	13
Removing the microSD-card.....	13
Installing the MicroSD-card.....	14
Base cover.....	14
Removing the base cover.....	14
Installing the base cover.....	16
Solid-state drive.....	17
Removing the M.2 2230 solid-state drive.....	17
Installing the M.2 2230 solid-state drive.....	18
Removing the M.2 2280 solid-state drive.....	20
Installing the M.2 2280 solid-state drive.....	20
Speakers.....	21
Removing the speakers.....	21
Installing the speakers.....	22
WLAN card.....	23
Removing the WLAN card.....	23
Installing the WLAN card.....	24
Coin-cell battery.....	26
Removing the coin-cell battery.....	26
Installing the coin-cell battery.....	26
Battery cable.....	27
Lithium-ion battery precautions.....	27
Removing the battery cable.....	28
Installing the battery cable.....	29
Battery.....	29
Removing the 3-cell battery.....	29
Installing the 3-cell battery.....	30
Removing the 4-cell battery.....	31
Installing the 4-cell battery.....	32

System fan.....	33
Removing the left system fan.....	33
Installing the left system fan.....	34
Removing the right system fan.....	35
Installing the right system fan.....	36
Display assembly.....	38
Removing the display assembly.....	38
Installing the display assembly.....	40
Input Output board.....	42
Removing the Input Output board.....	42
Installing the Input Output board.....	43
Heatsink assembly.....	44
Removing the heatsink assembly.....	44
Installing the heatsink assembly.....	45
Touchpad	46
Removing the touchpad.....	46
Installing the touchpad.....	47
Power-button board.....	48
Removing the power-button board.....	48
Installing the power-button board.....	49
System board.....	50
Removing the system board.....	50
Installing the system board.....	53
Power adapter port.....	56
Removing the power adapter port.....	56
Installing the power adapter port.....	57
Palmrest assembly.....	58
Removing the palmrest assembly.....	58

Chapter 3: Drivers and downloads..... 60

Chapter 4: System setup..... 61

BIOS overview.....	61
Entering BIOS setup program.....	61
Boot menu.....	61
Navigation keys.....	61
Boot Sequence.....	62
System setup options.....	62
Updating the BIOS.....	71
Updating the BIOS in Windows.....	71
Updating the BIOS in Linux and Ubuntu.....	72
Updating the BIOS using the USB drive in Windows.....	72
Updating the BIOS from the F12 One-Time boot menu.....	72
System and setup password.....	73
Assigning a system setup password.....	73
Deleting or changing an existing system setup password.....	74
Clearing BIOS (System Setup) and System passwords.....	74

Chapter 5: Troubleshooting..... 75

Handling swollen Lithium-ion batteries.....	75
Dell SupportAssist Pre-boot System Performance Check diagnostics.....	75
Running the SupportAssist Pre-Boot System Performance Check.....	76
Built-in self-test (BIST).....	76
M-BIST.....	76
LCD Power rail test (L-BIST).....	77
LCD Built-in Self Test (BIST).....	77
System-diagnostic lights.....	77
Recovering the operating system.....	79
Real-Time Clock (RTC Reset).....	79
Backup media and recovery options.....	79
WiFi power cycle.....	80
Drain residual flea power (perform hard reset).....	80

Chapter 6: Getting help and contacting Dell.....81

Working inside your computer

Safety instructions

Prerequisites

Use the following safety guidelines to protect your computer from potential damage and to ensure your personal safety. Unless otherwise noted, each procedure included in this document assumes that the following conditions exist:

- You have read the safety information that shipped with your computer.
- A component can be replaced or, if purchased separately, installed by performing the removal procedure in reverse order.

About this task

⚠ WARNING: Before working inside your computer, read the safety information that shipped with your computer. For additional safety best practices information, see the [Regulatory Compliance Homepage](#)

⚠ CAUTION: Many repairs may only be done by a certified service technician. You should only perform troubleshooting and simple repairs as authorized in your product documentation, or as directed by the online or telephone service and support team. Damage due to servicing that is not authorized by Dell is not covered by your warranty. Read and follow the safety instructions that came with the product.

⚠ CAUTION: To avoid electrostatic discharge, ground yourself by using a wrist grounding strap or by periodically touching an unpainted metal surface at the same time as touching a connector on the back of the computer.

⚠ CAUTION: Handle components and cards with care. Do not touch the components or contacts on a card. Hold a card by its edges or by its metal mounting bracket. Hold a component such as a processor by its edges, not by its pins.

⚠ CAUTION: When you disconnect a cable, pull on its connector or on its pull-tab, not on the cable itself. Some cables have connectors with locking tabs; if you are disconnecting this type of cable, press in on the locking tabs before you disconnect the cable. As you pull connectors apart, keep them evenly aligned to avoid bending any connector pins. Also, before you connect a cable, ensure that both connectors are correctly oriented and aligned.

ⓘ NOTE: Disconnect all power sources before opening the computer cover or panels. After you finish working inside the computer, replace all covers, panels, and screws before connecting to the power source.

ⓘ NOTE: The color of your computer and certain components may appear differently than shown in this document.

Before working inside your computer

Steps

1. Save and close all open files and exit all open applications.

2. Shut down your computer. Click **Start** > **Power** > **Shut down**.

ⓘ NOTE: If you are using a different operating system, see the documentation of your operating system for shut-down instructions.

3. Disconnect your computer and all attached devices from their electrical outlets.

4. Disconnect all attached network devices and peripherals, such as keyboard, mouse, and monitor from your computer.

5. Remove any media card and optical disc from your computer, if applicable.

6. After the computer is unplugged, press and hold the power button for 5 seconds to ground the system board.

 **CAUTION:** Place the computer on a flat, soft, and clean surface to avoid scratches on the display.

7. Place the computer face down.

Entering Service Mode

Service Mode allows users to immediately cut off electricity from the computer and conduct repairs without disconnecting the battery cable from the system board.

To enter **Service Mode**:

1. Shut down your computer and disconnect the AC adapter.
2. Hold **** key on the keyboard and press the power button for 3 seconds or until the Dell logo appears on the screen.
3. Press any key to continue.

 **NOTE:** If the power adapter has not been disconnected, a message prompting you to remove the AC adapter appears on the screen. Remove the AC adapter and then press any key to continue the **Service Mode** procedure.

 **NOTE:** The **Service Mode** procedure automatically skips the following step if the **Owner Tag** of the computer is not set up in advance by the manufacturer.

4. When the ready-to-proceed message appears on the screen, press any key to proceed. The computer emits three short beeps and shuts down immediately.

Once the computer shuts down, you may perform the replacement procedures without disconnecting the battery cable from the system board.

Exiting Service Mode

Service Mode allows users to immediately cut off electricity from the computer and conduct repairs without disconnecting the battery cable from the system board.

To exit **Service Mode**:

1. Connect the AC adapter to the power-adapter port on your computer.
2. Press the power button to turn on the computer. Your computer will automatically return to normal functioning mode.

Safety precautions

The safety precautions chapter details the primary steps to be taken before performing any disassembly instructions.

Observe the following safety precautions before you perform any installation or break/fix procedures involving disassembly or reassembly:

- Turn off the system and all attached peripherals.
- Disconnect the system and all attached peripherals from AC power.
- Disconnect all network cables, telephone, and telecommunications lines from the system.
- Use an ESD field service kit when working inside any notebook to avoid electrostatic discharge (ESD) damage.
- After removing any system component, carefully place the removed component on an anti-static mat.
- Wear shoes with non-conductive rubber soles to reduce the chance of getting electrocuted.

Standby power

Dell products with standby power must be unplugged before you open the case. Systems that incorporate standby power are essentially powered while turned off. The internal power enables the system to be remotely turned on (wake on LAN) and suspended into a sleep mode and has other advanced power management features.

Unplugging, pressing and holding the power button for 20 seconds should discharge residual power in the system board. Remove the battery from notebooks.

Bonding

Bonding is a method for connecting two or more grounding conductors to the same electrical potential. This is done through the use of a field service electrostatic discharge (ESD) kit. When connecting a bonding wire, ensure that it is connected to bare metal and never to a painted or non-metal surface. The wrist strap should be secure and in full contact with your skin, and ensure that you remove all jewelry such as watches, bracelets, or rings prior to bonding yourself and the equipment.

Electrostatic discharge—ESD protection

ESD is a major concern when you handle electronic components, especially sensitive components such as expansion cards, processors, memory DIMMs, and system boards. Very slight charges can damage circuits in ways that may not be obvious, such as intermittent problems or a shortened product life span. As the industry pushes for lower power requirements and increased density, ESD protection is an increasing concern.

Due to the increased density of semiconductors used in recent Dell products, the sensitivity to static damage is now higher than in previous Dell products. For this reason, some previously approved methods of handling parts are no longer applicable.

Two recognized types of ESD damage are catastrophic and intermittent failures.

- **Catastrophic** – Catastrophic failures represent approximately 20 percent of ESD-related failures. The damage causes an immediate and complete loss of device functionality. An example of catastrophic failure is a memory DIMM that has received a static shock and immediately generates a "No POST/No Video" symptom with a beep code emitted for missing or nonfunctional memory.
- **Intermittent** – Intermittent failures represent approximately 80 percent of ESD-related failures. The high rate of intermittent failures means that most of the time when damage occurs, it is not immediately recognizable. The DIMM receives a static shock, but the tracing is merely weakened and does not immediately produce outward symptoms related to the damage. The weakened trace may take weeks or months to melt, and in the meantime may cause degradation of memory integrity, intermittent memory errors, etc.

The more difficult type of damage to recognize and troubleshoot is the intermittent (also called latent or "walking wounded") failure.

Perform the following steps to prevent ESD damage:

- Use a wired ESD wrist strap that is properly grounded. The use of wireless anti-static straps is no longer allowed; they do not provide adequate protection. Touching the chassis before handling parts does not ensure adequate ESD protection on parts with increased sensitivity to ESD damage.
- Handle all static-sensitive components in a static-safe area. If possible, use anti-static floor pads and workbench pads.
- When unpacking a static-sensitive component from its shipping carton, do not remove the component from the anti-static packing material until you are ready to install the component. Before unwrapping the anti-static packaging, ensure that you discharge static electricity from your body.
- Before transporting a static-sensitive component, place it in an anti-static container or packaging.

ESD field service kit

The unmonitored Field Service kit is the most commonly used service kit. Each Field Service kit includes three main components: anti-static mat, wrist strap, and bonding wire.

Components of an ESD field service kit

The components of an ESD field service kit are:

- **Anti-Static Mat** – The anti-static mat is dissipative and parts can be placed on it during service procedures. When using an anti-static mat, your wrist strap should be snug and the bonding wire should be connected to the mat and to any bare metal on the system being worked on. Once deployed properly, service parts can be removed from the ESD bag and placed directly on the mat. ESD-sensitive items are safe in your hand, on the ESD mat, in the system, or inside a bag.
- **Wrist Strap and Bonding Wire** – The wrist strap and bonding wire can be either directly connected between your wrist and bare metal on the hardware if the ESD mat is not required, or connected to the anti-static mat to protect hardware that is temporarily placed on the mat. The physical connection of the wrist strap and bonding wire between your skin, the ESD mat, and the hardware is known as bonding. Use only Field Service kits with a wrist strap, mat, and bonding wire. Never use wireless wrist straps. Always be aware that the internal wires of a wrist strap are prone to damage from normal wear and tear, and must be checked regularly with a wrist strap tester in order to avoid accidental ESD hardware damage. It is recommended to test the wrist strap and bonding wire at least once per week.

- **ESD Wrist Strap Tester** – The wires inside of an ESD strap are prone to damage over time. When using an unmonitored kit, it is a best practice to regularly test the strap prior to each service call, and at a minimum, test once per week. A wrist strap tester is the best method for doing this test. If you do not have your own wrist strap tester, check with your regional office to find out if they have one. To perform the test, plug the wrist-strap's bonding-wire into the tester while it is strapped to your wrist and push the button to test. A green LED is lit if the test is successful; a red LED is lit and an alarm sounds if the test fails.
- **Insulator Elements** – It is critical to keep ESD sensitive devices, such as plastic heat sink casings, away from internal parts that are insulators and often highly charged.
- **Working Environment** – Before deploying the ESD Field Service kit, assess the situation at the customer location. For example, deploying the kit for a server environment is different than for a desktop or portable environment. Servers are typically installed in a rack within a data center; desktops or portables are typically placed on office desks or cubicles. Always look for a large open flat work area that is free of clutter and large enough to deploy the ESD kit with additional space to accommodate the type of system that is being repaired. The workspace should also be free of insulators that can cause an ESD event. On the work area, insulators such as Styrofoam and other plastics should always be moved at least 12 inches or 30 centimeters away from sensitive parts before physically handling any hardware components
- **ESD Packaging** – All ESD-sensitive devices must be shipped and received in static-safe packaging. Metal, static-shielded bags are preferred. However, you should always return the damaged part using the same ESD bag and packaging that the new part arrived in. The ESD bag should be folded over and taped shut and all the same foam packing material should be used in the original box that the new part arrived in. ESD-sensitive devices should be removed from packaging only at an ESD-protected work surface, and parts should never be placed on top of the ESD bag because only the inside of the bag is shielded. Always place parts in your hand, on the ESD mat, in the system, or inside an anti-static bag.
- **Transporting Sensitive Components** – When transporting ESD sensitive components such as replacement parts or parts to be returned to Dell, it is critical to place these parts in anti-static bags for safe transport.

ESD protection summary

It is recommended that all field service technicians use the traditional wired ESD grounding wrist strap and protective anti-static mat at all times when servicing Dell products. In addition, it is critical that technicians keep sensitive parts separate from all insulator parts while performing service and that they use anti-static bags for transporting sensitive components.

Transporting sensitive components

When transporting ESD sensitive components such as replacement parts or parts to be returned to Dell, it is critical to place these parts in anti-static bags for safe transport.

After working inside your computer

About this task

 **NOTE:** Leaving stray or loose screws inside your computer may severely damage your computer.

Steps

1. Replace all screws and ensure that no stray screws remain inside your computer.
2. Connect any external devices, peripherals, or cables you removed before working on your computer.
3. Replace any media cards, discs, or any other parts that you removed before working on your computer.
4. Connect your computer and all attached devices to their electrical outlets.
5. Turn on your computer.

Removing and installing components

NOTE: The images in this document may differ from your computer depending on the configuration you ordered.

Recommended tools

The procedures in this document may require the following tools:

- Phillips #0 screwdriver
- Plastic scribe

Screw List

The following table shows the screw list and the image of the screws.

Table 1. Screw list

















Component	Screw type	Quantity	Image
Base cover	Captive screws	7	
3-cell battery	M2x3	3	
4-cell battery	M2x3	5	
Solid-state drive bracket	M2x3	1	
WLAN	M2x3	1	
Left system Fan	M2x3	2	
Right system Fan	M2x3	2	
Display cable bracket	M2x2.5	1	
Display hinge bracket	M2x2.5 M2x3	1 4	 
Input Output board	M2x2.5	1	
Touchpad bracket	M2x2	3	

Table 1. Screw list (continued)

Component	Screw type	Quantity	Image
Touchpad	M2x2	2	
Heatsink assembly	Captive screws	4	
Power button with fingerprint reader	M2x3	1	
System board	M2x2.5	1	
Type-C bracket	M2x3	1	

Major components of your system

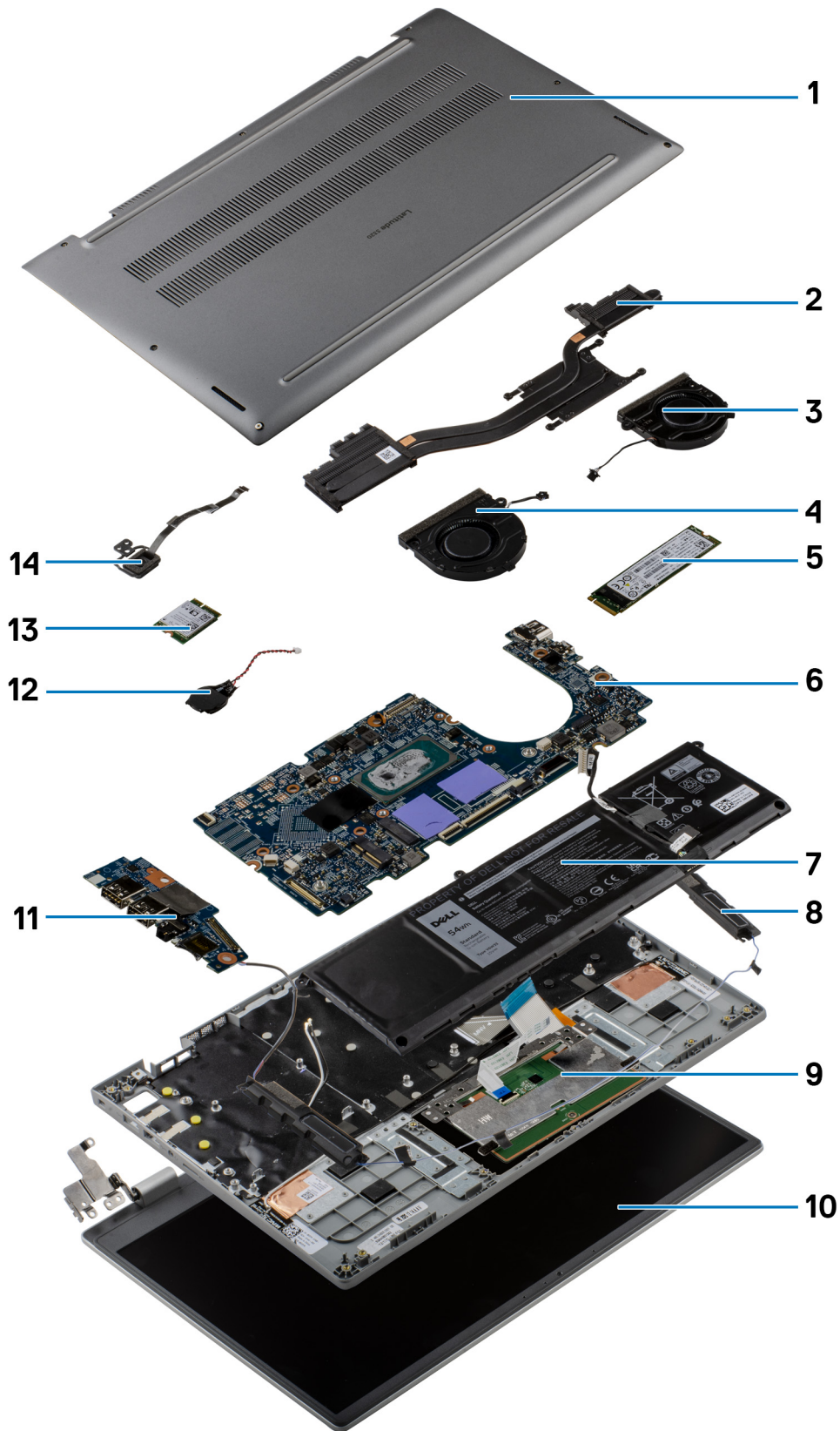

1. Base cover

12 Removing and installing components

2. Heatsink assembly
3. Right system fan
4. Left system fan
5. Solid-state drive
6. System board
7. Battery
8. Speaker
9. Palmrest assembly
10. Display assembly
11. Input Output board
12. Coin-cell battery
13. WLAN card
14. Power button with fingerprint reader

i **NOTE:** Dell provides a list of components and their part numbers for the original system configuration purchased. These parts are available according to warranty coverages purchased by the customer. Contact your Dell sales representative for purchase options.

MicroSD-card

Removing the microSD-card

Prerequisites

1. Follow the procedure in [before working inside your computer](#).

About this task

The following image provides a visual representation of the microSD-card removal procedure.

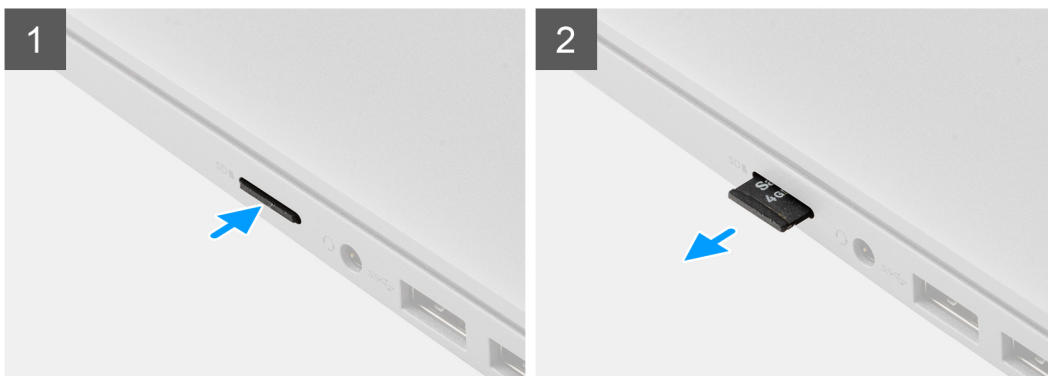

Steps

1. Push the microSD-card to eject it from the slot.
2. Remove the microSD-card from the system.

Installing the MicroSD-card

Prerequisites

If you are replacing a component, remove the existing component before performing the installation procedure.

About this task

The following image provides a visual representation of the MicroSD-card installation procedure.



Steps

Insert the microSD-card into its slot until it clicks into place.

Next steps

1. Follow the procedure in [after working inside your computer](#).

Base cover

Removing the base cover

Prerequisites

1. Follow the procedure in [before working inside your computer](#).
2. Remove the [microSD-card](#).
3. Enter the [service mode](#).

About this task

The following images indicate the location of the base cover, and provide a visual representation of the removal procedure.

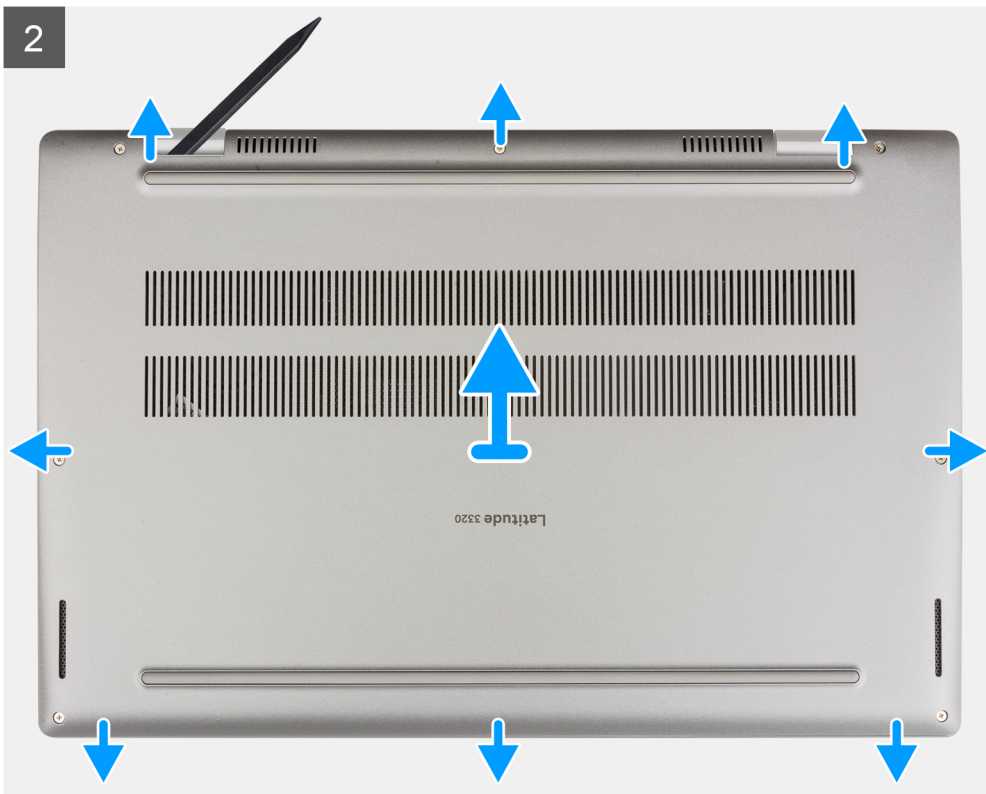

Steps

1. Loosen the seven captive screws that secure the base cover to the chassis.
2. Using a plastic scribe, pry open the base cover starting from the recesses located in the U-shaped indents near the hinges at the top edge of the base cover.
3. Pry open the left, right, and bottom sides of the base cover.
4. Carefully lift and remove the base cover from the chassis.

NOTE: Be careful of the latches while removing the base cover as the latches may break.

Installing the base cover

Prerequisites

If you are replacing a component, remove the existing component before performing the installation procedure.

About this task

The following images indicate the location of the base cover, and provide a visual representation of the installation procedure.

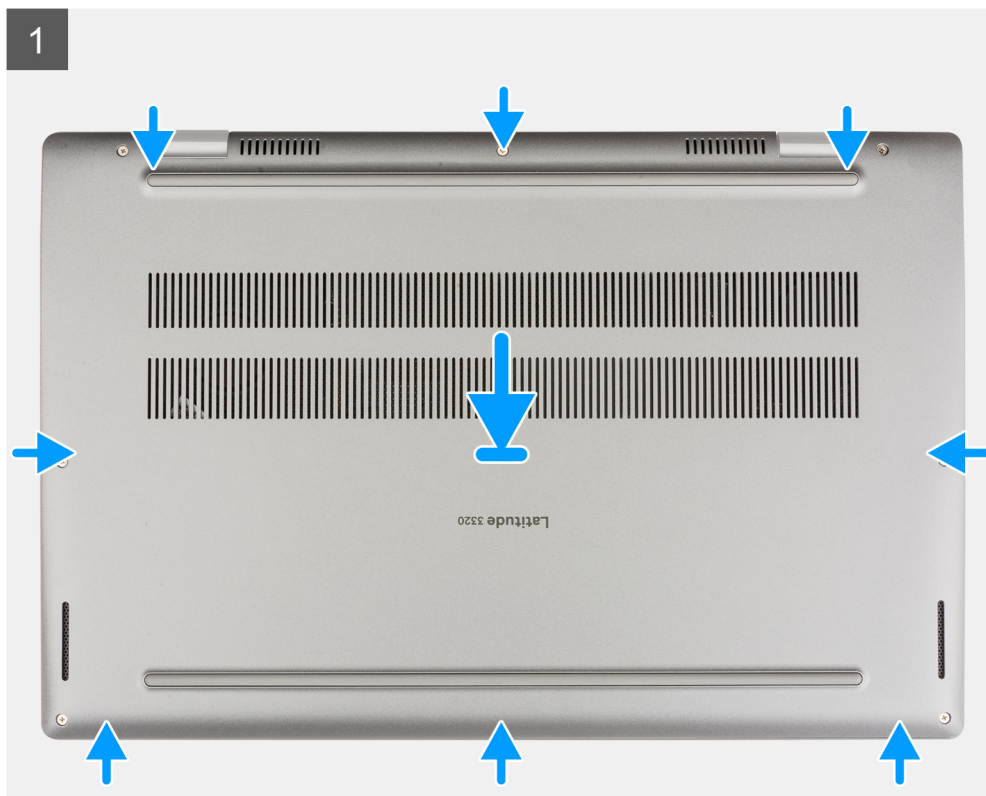



2



Steps

1. Align and place the base cover on the chassis, and snap the base cover into place.
2. Tighten the seven captive screws to secure the base cover to the chassis.

Next steps

1. Exit the [service mode](#).
2. Install the [microSD-card](#).
3. Follow the procedure in [after working inside your computer](#).

Solid-state drive

Removing the M.2 2230 solid-state drive

Prerequisites

1. Follow the procedure in [before working inside your computer](#).
2. Remove the [microSD-card](#).
3. Enter the [service mode](#).
4. Remove the [base cover](#).

About this task

The following image indicates the location of the solid-state drive and provides a visual representation of the removal procedure.



1x
M2x3

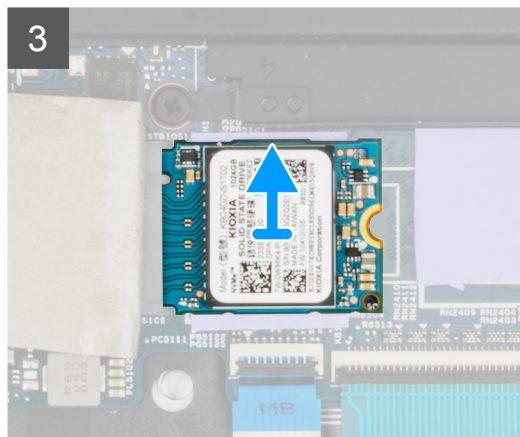
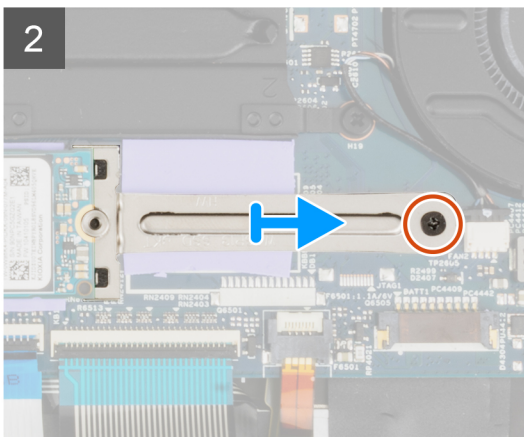
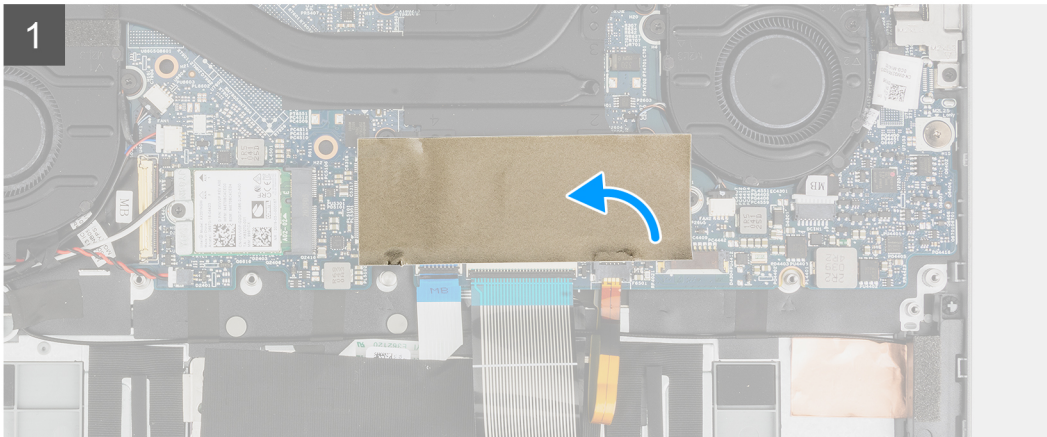
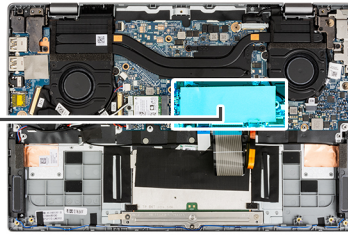

Steps

1. Open the solid-state drive mylar sheet that covers the solid-state drive.
i **NOTE:** There is a protective mylar sheet covering the solid-state drive. This mylar sheet must be opened in order to proceed with the removal procedure.
2. Remove the screw (M2x3) that secures the solid-state drive bracket to the system board.
3. Remove the solid-state drive bracket from the system board.
4. Slide and remove the solid-state drive from the M.2 card connector on the system board.

Installing the M.2 2230 solid-state drive

Prerequisites

If you are replacing a component, remove the existing component before performing the installation procedure.

About this task

The following image indicates the location of the solid-state drive and provides a visual representation of the installation procedure.



1x
M2x3

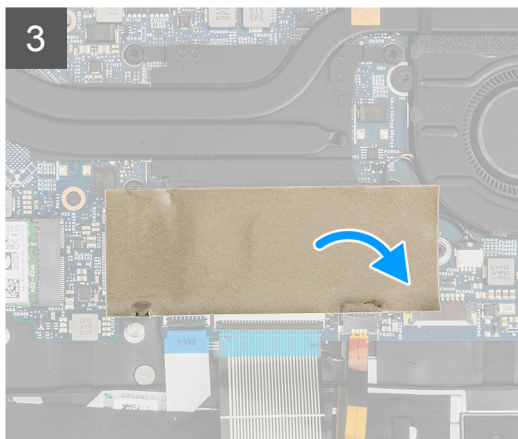
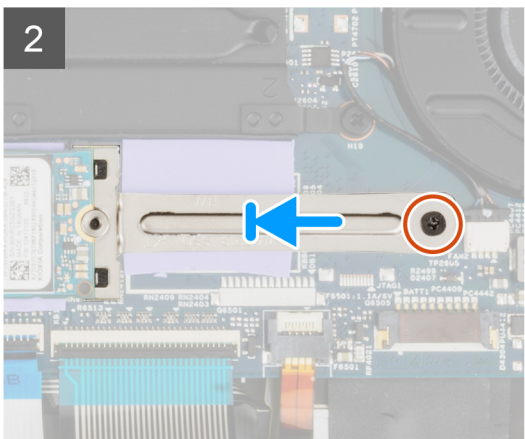
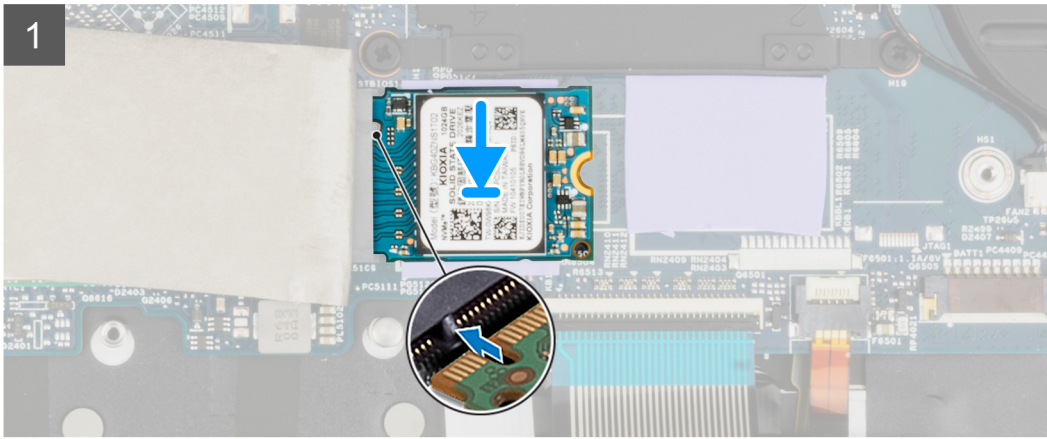
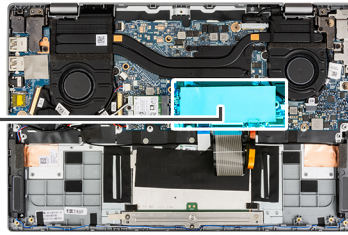

Steps

1. Align the notch on the solid-state drive with the tab on the M.2 card connector.
2. Slide the solid-state drive into the M.2 card connector on the system board.
3. Align and place the solid-state drive bracket.
4. Install the screw (M2x3) that secures the solid-state drive bracket to the system board.
5. Close the solid-state drive mylar sheet to cover the solid-state drive.

i NOTE: There is a protective mylar sheet covering the solid-state drive. This mylar sheet must be closed after the installation procedure.

Next steps

1. Install the [base cover](#).
2. Exit the [service mode](#).
3. Install the [microSD-card](#).
4. Follow the procedure in [After working inside your computer](#).

Removing the M.2 2280 solid-state drive

Prerequisites

1. Follow the procedure in [before working inside your computer](#).
2. Remove the [microSD-card](#).
3. Enter the [service mode](#).
4. Remove the [base cover](#).

About this task

The following image indicates the location of the solid-state drive and provides a visual representation of the removal procedure.

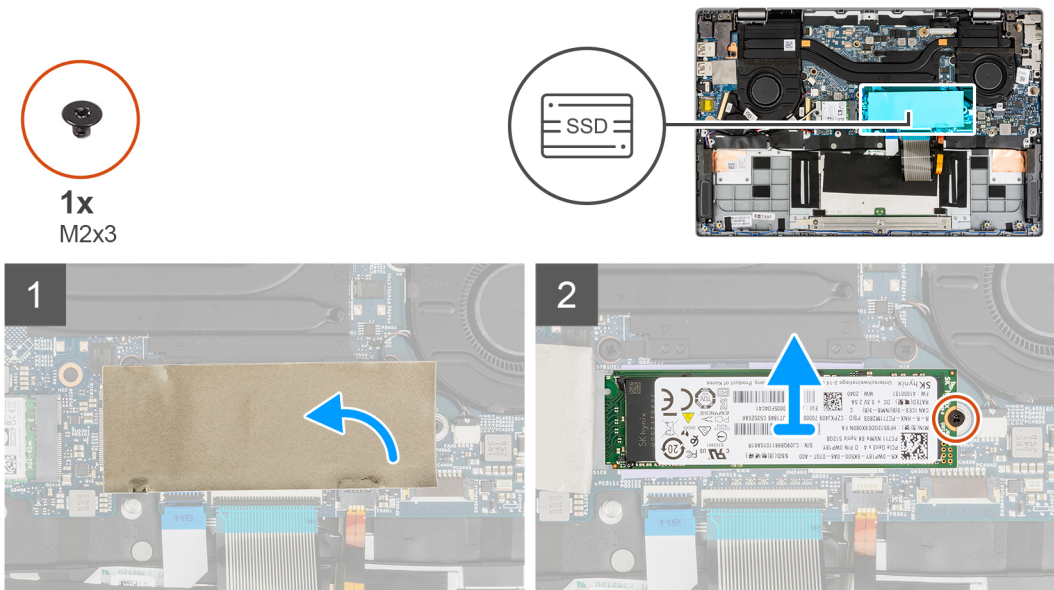

Steps

1. Open the solid-state drive mylar sheet that covers the solid-state drive.
NOTE: There is a protective mylar sheet covering the solid-state drive. This mylar sheet must be opened in order to proceed with the removal procedure.
2. Remove the single screw (M2x3) that secures the solid-state drive to the system board.
3. Slide and remove the solid-state drive from the M.2 card connector on the system board.

Installing the M.2 2280 solid-state drive

Prerequisites

If you are replacing a component, remove the existing component before performing the installation procedure.

About this task

The following image indicates the location of the solid-state drive and provides a visual representation of the installation procedure.



1x
M2x3

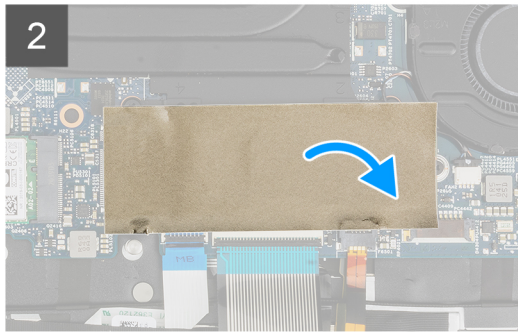
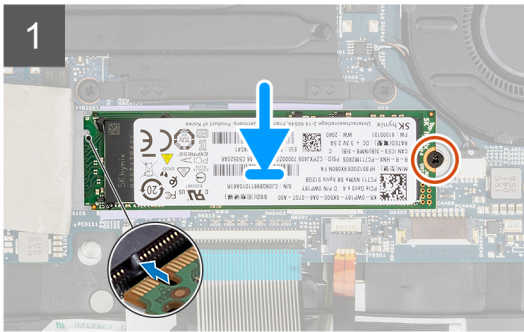
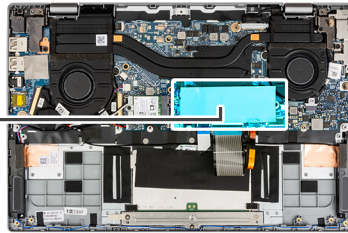

Steps

1. Align the notch on the solid-state drive with the tab on the M.2 card connector.
2. Slide the solid-state drive into the M.2 card connector on the system board.
3. Replace the screw (M2x3) that secures the solid-state drive to the system board.
4. Close the solid-state drive mylar sheet to cover the solid-state drive.

NOTE: There is a protective mylar sheet covering the solid-state drive. This mylar sheet must be closed after the installation procedure.

Next steps

1. Install the [base cover](#).
2. Exit the [service mode](#).
3. Install the [microSD-card](#).
4. Follow the procedure in [After working inside your computer](#).

Speakers

Removing the speakers

Prerequisites

1. Follow the procedure in [before working inside your computer](#).
2. Remove the [microSD-card](#).
3. Enter the [service mode](#).
4. Remove the [base cover](#).

About this task

The following image indicates the location of the speakers and provides a visual representation of the removal procedure.

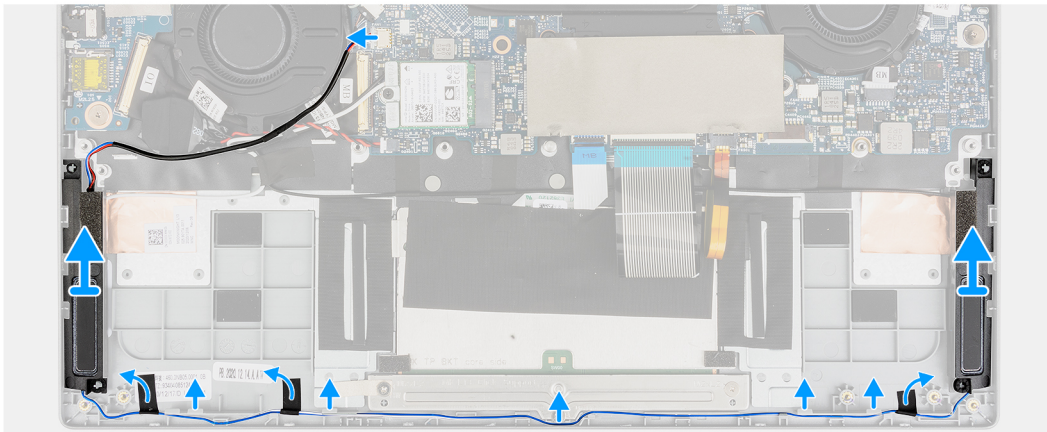
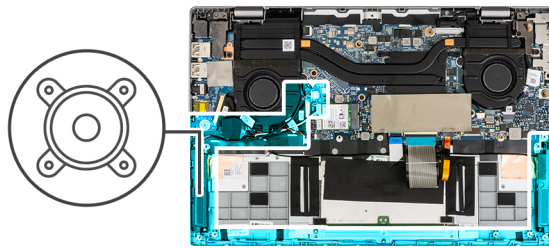

Steps

1. Disconnect the speaker cable from the connector on the system board.
2. Unroute the speaker cable from the routing guide.
3. Peel the adhesive tapes that secure the speakers in place.
4. Remove the speakers from the chassis.

Installing the speakers

Prerequisites

If you are replacing a component, remove the existing component before performing the installation procedure.

About this task

The following image indicates the location of the speakers and provides a visual representation of the installation procedure.

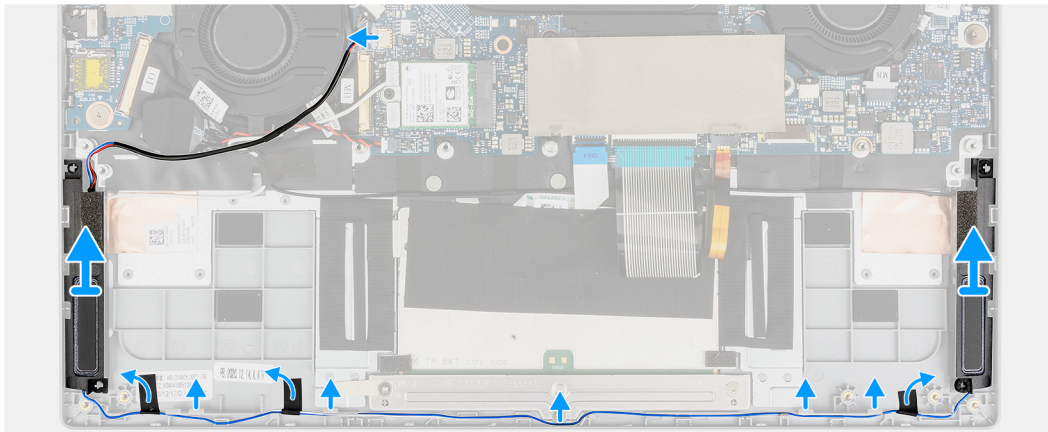
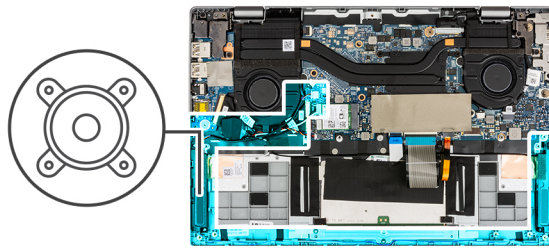

Steps

1. Align and place the speakers in the slot on the chassis.
2. Route the speaker cables through the routing guide.
3. Connect the speaker cable to the connector.
4. Adhere the adhesive tapes to secure the speakers in place.

Next steps

1. Install the [battery](#).
2. Install the [base cover](#).
3. Install the [microSD-card](#).
4. Follow the procedure in [after working inside your computer](#).

WLAN card

Removing the WLAN card

Prerequisites

1. Follow the procedure in [before working inside your computer](#).
2. Remove the [microSD-card](#).
3. Enter the [service mode](#).
4. Remove the [base cover](#).

About this task

The following images indicate the location of the WLAN card and provide a visual representation of the removal procedure.



1x
M2x3

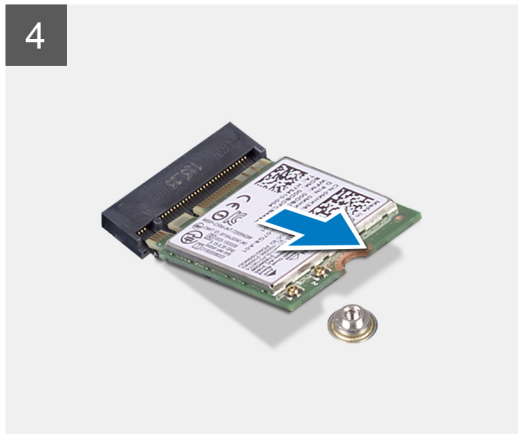
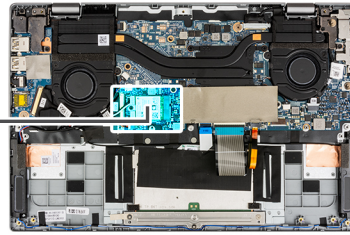

Steps

1. Remove the screw (M2x3) that secures WLAN card bracket to the system board.
2. Lift the WLAN card bracket out of the system.
3. Disconnect the antenna cables from the connectors on the WLAN card.
4. Lift and remove the WLAN card from the WLAN card slot.

Installing the WLAN card

Prerequisites

If you are replacing a component, remove the existing component before performing the installation procedure.

About this task

The following image indicates the location of the WLAN card and provides a visual representation of the installation procedure.



1x
M2x3

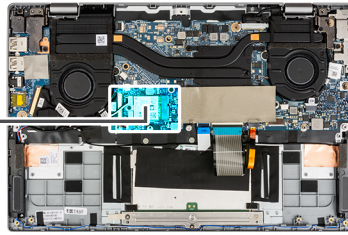

Steps

1. Align the notch on the WLAN card with the tab on the WLAN card slot.
2. Slide the WLAN card at an angle into the WLAN card slot.
3. Connect the antenna cables to the connectors on the WLAN card.

NOTE: The antenna cable connectors are fragile and utmost care should be taken while replacing them.

Table 2. Antenna cable guide

Cable color	Connector
White cable (Main)	White triangle (▲) on the WLAN module of the system board
Black cable (Aux)	Solid triangle (▲) on the WLAN module of the system board

4. Align and place the WLAN card bracket on the WLAN card.
5. Install the screw (M2x3) to secure the WLAN card bracket to the system board.

Next steps

1. Install the [base cover](#).
2. Exit the [service mode](#).

3. Install the [microSD-card](#).
4. Follow the procedure in [After working inside your computer](#).

Coin-cell battery

Removing the coin-cell battery

Prerequisites

1. Follow the procedure in [before working inside your computer](#).
2. Remove the [microSD-card](#).
3. Enter the [service mode](#).
4. Remove the [base cover](#).

About this task

 **NOTE:** When the coin-cell battery is removed, it clears the CMOS settings.

The following image indicates the location of the coin-cell battery and provides a visual representation of the removal procedure.

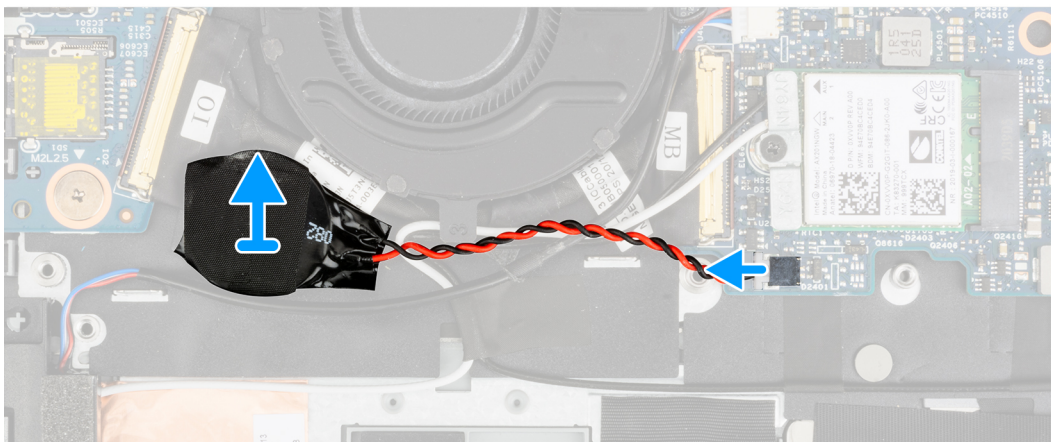
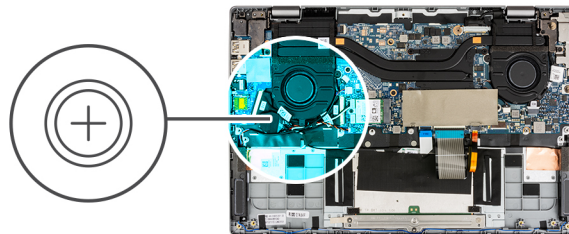

Steps

1. Disconnect the coin-cell battery cable from the connector on the system board.
2. Lift and remove the coin-cell battery from the palmrest assembly.

Installing the coin-cell battery

Prerequisites

If you are replacing a component, remove the existing component before performing the installation procedure.

About this task

The following image indicates the location of the coin-cell battery and provides a visual representation of the installation procedure.

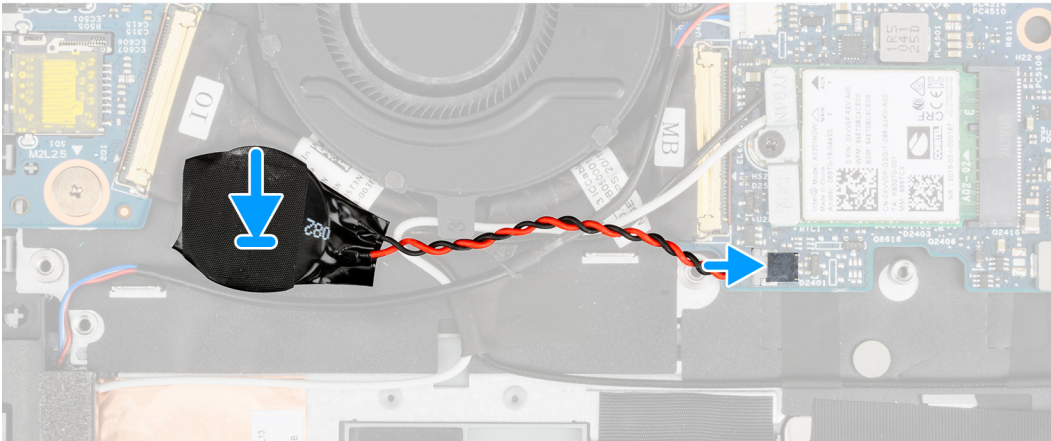
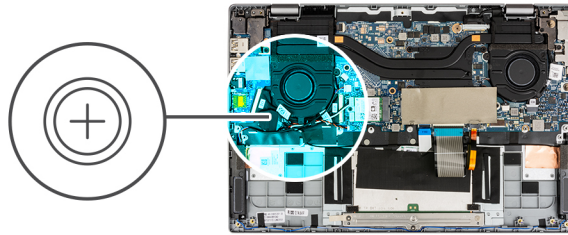

Steps

1. Align and place the coin-cell battery on the palmrest assembly.
2. Connect the coin-cell battery cable to the connector on the system board.

Next steps

1. Install the [base cover](#).
2. Exit the [service mode](#).
3. Install the [microSD-card](#).
4. Follow the procedure in [after working inside your computer](#).

Battery cable

Lithium-ion battery precautions

⚠ CAUTION:

- Exercise caution when handling Lithium-ion batteries.
- Discharge the battery completely before removing it. Disconnect the AC power adapter from the system and operate the computer solely on battery power—the battery is fully discharged when the computer no longer turns on when the power button is pressed.
- Do not crush, drop, mutilate, or penetrate the battery with foreign objects.
- Do not expose the battery to high temperatures, or disassemble battery packs and cells.
- Do not apply pressure to the surface of the battery.
- Do not bend the battery.
- Do not use tools of any kind to pry on or against the battery.

- Ensure any screws during the servicing of this product are not lost or misplaced, to prevent accidental puncture or damage to the battery and other system components.
- If the battery gets stuck inside your computer as a result of swelling, do not try to release it as puncturing, bending, or crushing a lithium-ion battery can be dangerous. In such an instance, contact Dell technical support for assistance. See www.dell.com/contactdell.
- Always purchase genuine batteries from www.dell.com or authorized Dell partners and resellers.
- Swollen batteries should not be used and should be replaced and disposed properly. For guidelines on how to handle and replace swollen Lithium-ion batteries, see [Handling swollen Lithium-ion batteries](#).

Removing the battery cable

Prerequisites

1. Follow the procedure in [before working inside your computer](#).
2. Remove the [microSD-card](#).
3. Enter the [service mode](#).
4. Remove the [base cover](#).
5. Remove the [battery](#).

About this task

NOTE: The battery cable must be disconnected from the connector on the system board only after the battery is removed from the system.

The following image indicates the location of the battery cable and provides a visual representation of the installation procedure.

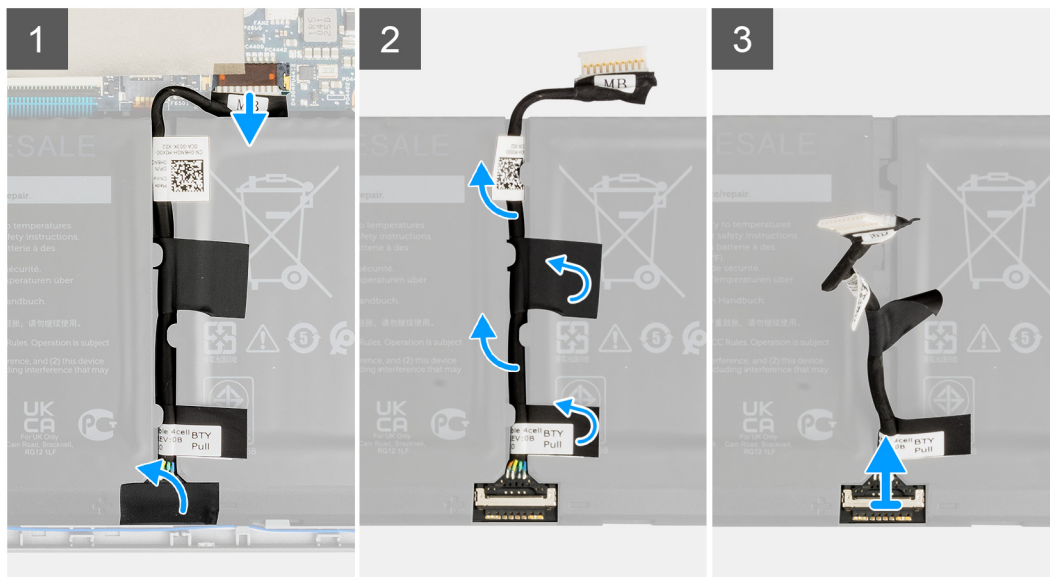
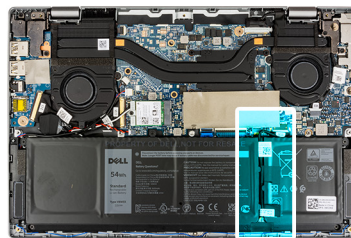

Steps

Disconnect the battery cable from the connector on the system board.

Installing the battery cable

Prerequisites

If you are replacing a component, remove the existing component before performing the installation procedure.

About this task

The following image indicates the location of the battery cable and provides a visual representation of the installation procedure.

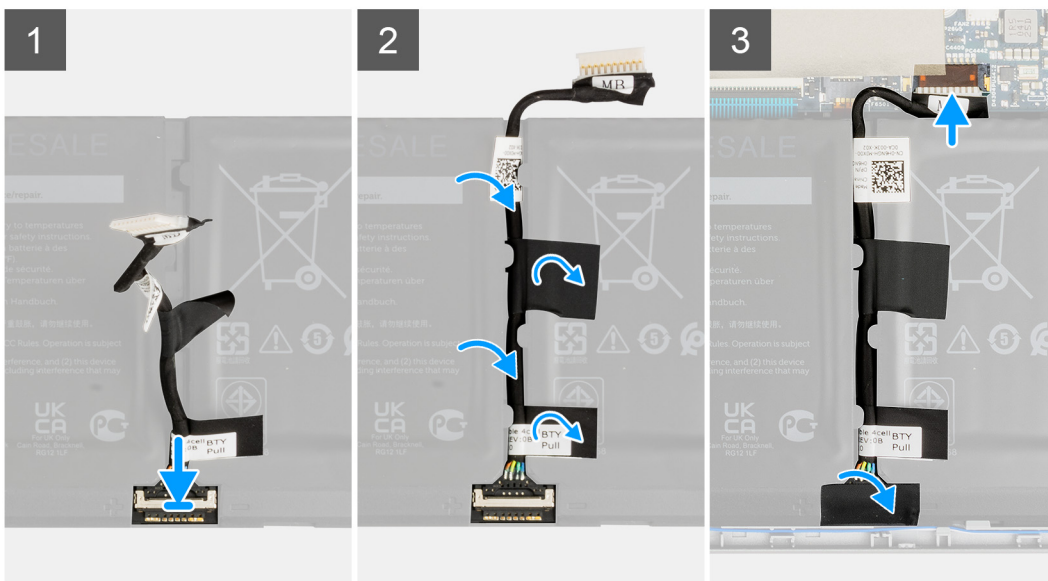
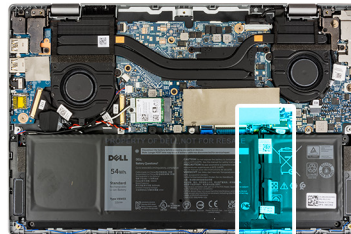

Steps

Connect the battery cable to the connector on the system board.

Next steps

1. Install the [battery](#).
2. Install the [base cover](#).
3. Exit the [service mode](#).
4. Install the [microSD-card](#).
5. Follow the procedure in [After working on your computer](#).

Battery

Removing the 3-cell battery

Prerequisites

1. Follow the procedure in [before working inside your computer](#).
2. Remove the [microSD-card](#).

3. Enter the [service mode](#).
4. Remove the [base cover](#).

About this task

The following image indicates the location of the battery and provide a visual representation of the removal procedure.

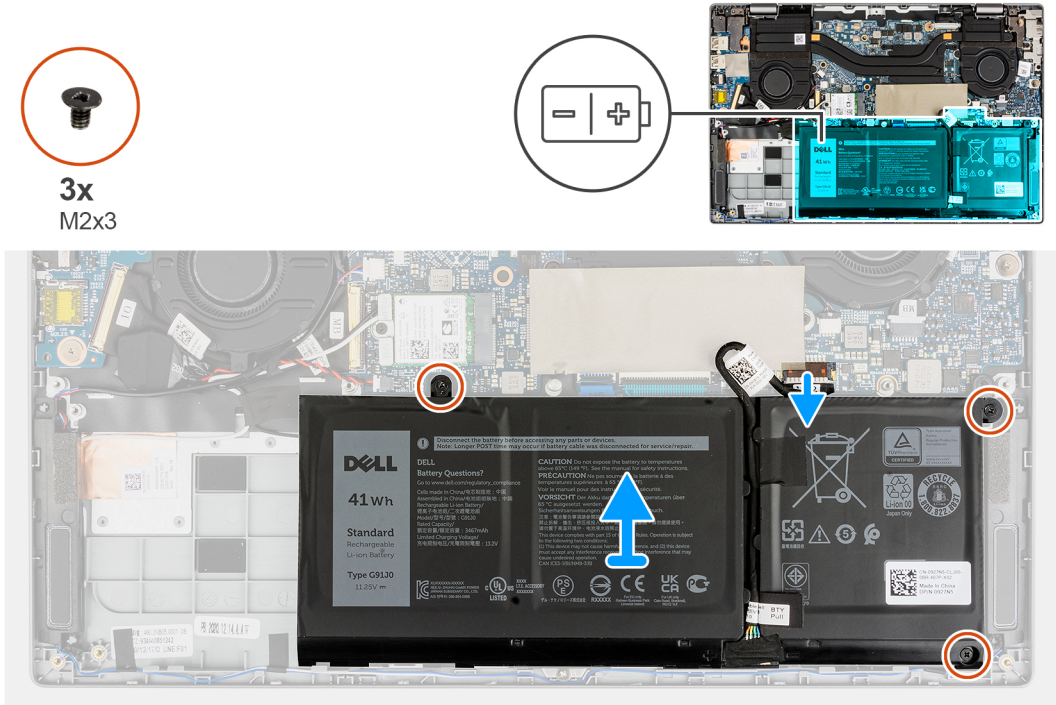

Steps

1. Peel the adhesive tapes that secure the battery in place.
2. Peel the adhesive tape and disconnect the battery cable from the connector on the battery.
3. Peel the adhesive tapes and unroute the battery cable from the routing channel in the battery.
4. Remove the three (M2x3) screws that secure the battery to the palmrest assembly.
5. Carefully lift and remove the battery from the chassis.

Installing the 3-cell battery

Prerequisites

If you are replacing a component, remove the existing component before performing the installation procedure.

About this task

The following image indicates the location of the battery and provides a visual representation of the installation procedure.



3x
M2x3

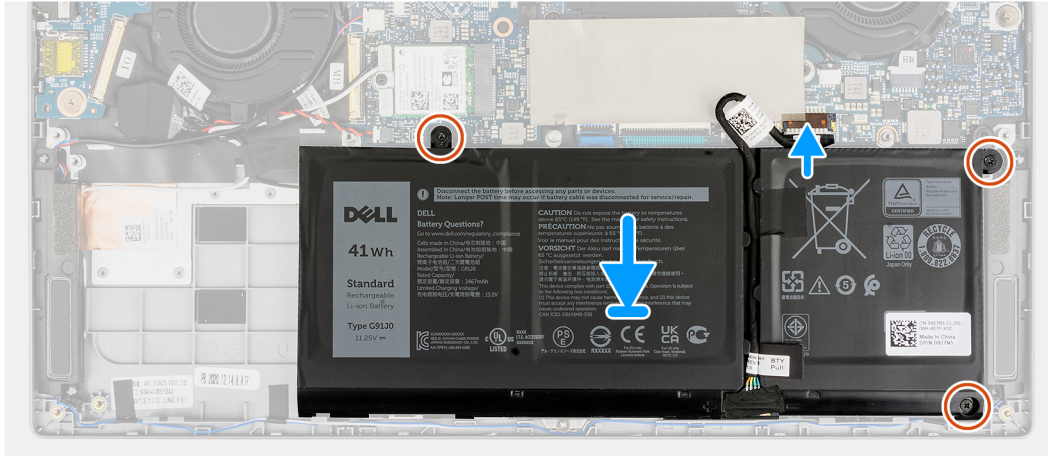
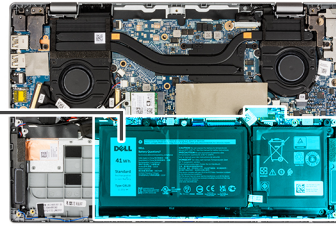
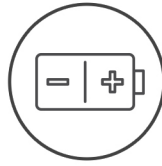

Steps

1. Align and place the battery in the slot on the chassis.
2. Install the three (M2x3) screws to secure the battery in place.
3. Route the battery cable through the routing channel in the battery.
4. Connect the battery cable to the connector on the battery and adhere the adhesive tape.
5. Adhere the adhesive tapes to secure the battery in place.

Next steps

1. Install the [base cover](#).
2. Exit the [service mode](#).
3. Install the [microSD-card](#).
4. Follow the procedure in [After working on your computer](#).

Removing the 4-cell battery

Prerequisites

1. Follow the procedure in [before working inside your computer](#).
2. Remove the [microSD-card](#).
3. Enter the [service mode](#).
4. Remove the [base cover](#).

About this task

The following image indicates the location of the battery and provides a visual representation of the removal procedure.



5x
M2x3

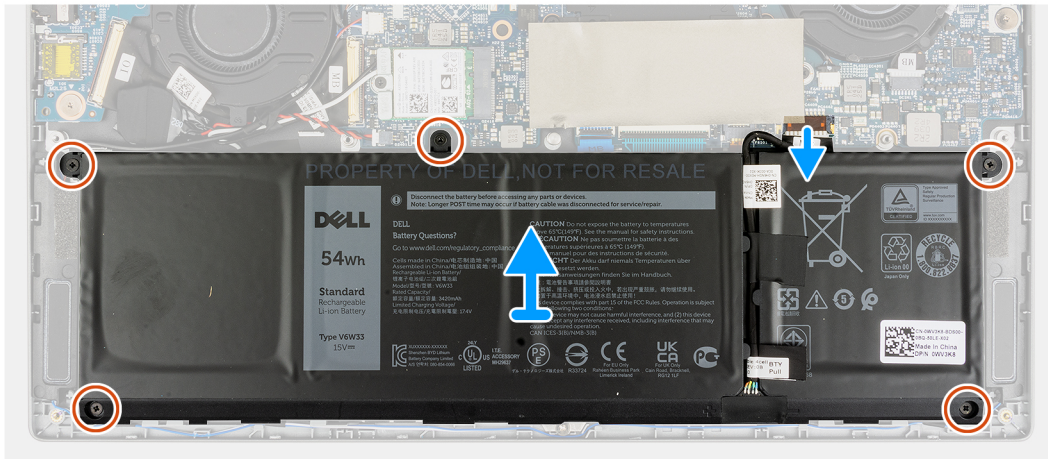
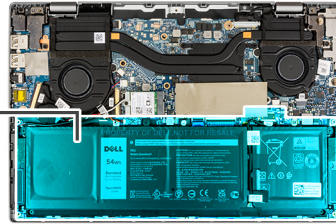
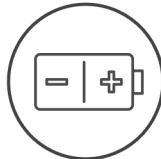

Steps

1. Peel the adhesive tapes that secure the battery in place.
2. Peel the adhesive tape and disconnect the battery cable from the connector on the battery.
3. Peel the adhesive tapes and unrout the battery cable from the routing channel in the battery.
4. Remove the five (M2x3) screws that secure the battery to the palmrest assembly.
5. Carefully lift and remove the battery from the chassis.

Installing the 4-cell battery

Prerequisites

If you are replacing a component, remove the existing component before performing the installation procedure.

About this task

The following image indicates the location of the battery and provides a visual representation of the installation procedure.



5x
M2x3

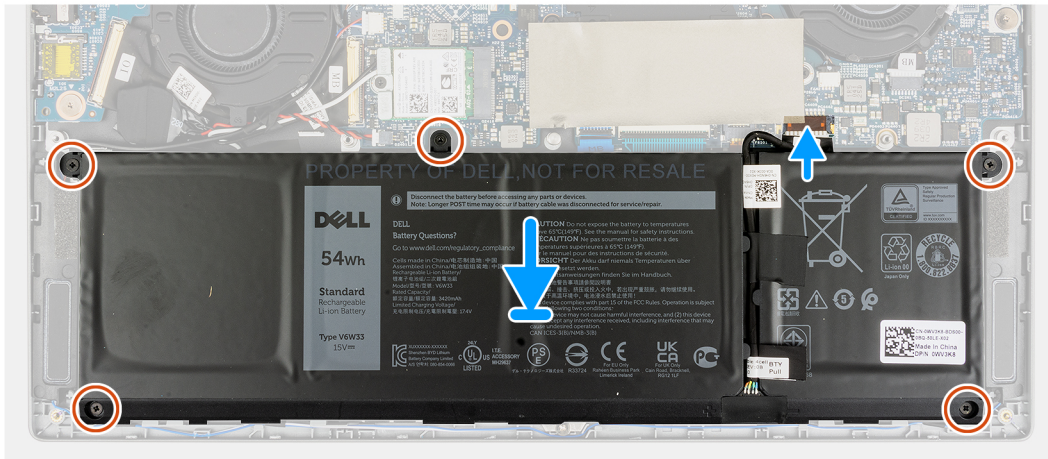
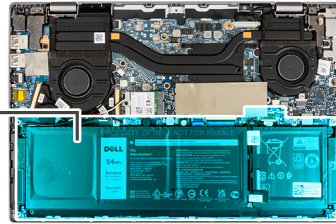
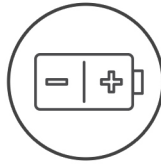

Steps

1. Align and place the battery in the slot on the chassis.
2. Install the five (M2x3) screws to secure the battery in place.
3. Route the battery cable through the routing channel in the battery.
4. Connect the battery cable to the connector on the battery and adhere the adhesive tape.
5. Adhere the adhesive tapes to secure the battery in place.

Next steps

1. Install the [base cover](#).
2. Exit the [service mode](#).
3. Install the [microSD-card](#).
4. Follow the procedure in [After working on your computer](#).

System fan

Removing the left system fan

Prerequisites

1. Follow the procedure in [before working inside your computer](#).
2. Remove the [microSD-card](#).
3. Remove the [base cover](#).
4. Remove the [battery](#).

About this task

The following image indicates the location of the left system fan and provides a visual representation of the removal procedure.



2x
M2x3

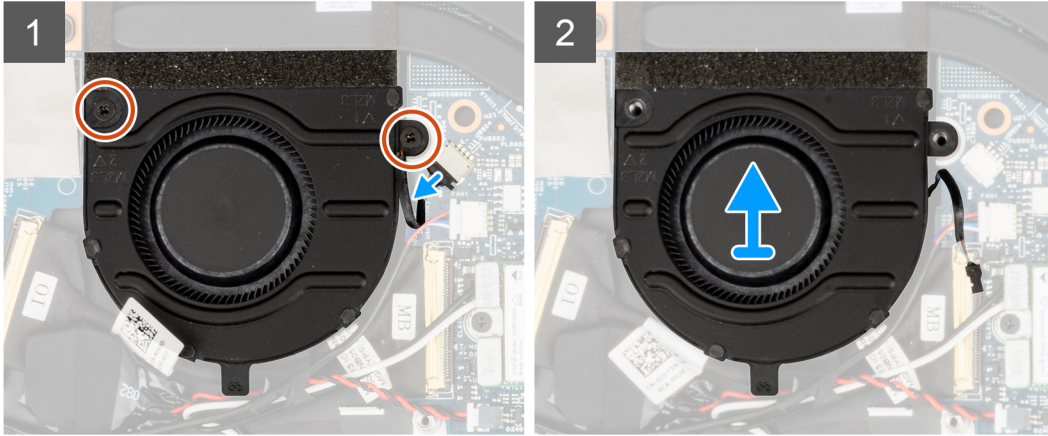
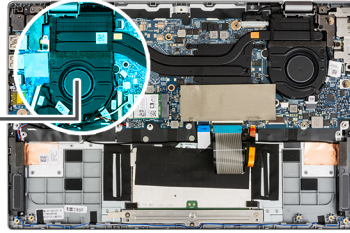
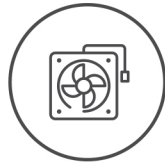

Steps

1. Disconnect the system fan cable from the connector on the system board.
2. Remove the two (M2x3) screws that secure the system fan in place.
3. Lift the system fan off the palmrest assembly.

Installing the left system fan

Prerequisites

If you are replacing a component, remove the existing component before performing the installation procedure.

About this task

The following image indicates the location of the left system fan and provides a visual representation of the installation procedure.



2x
M2x3

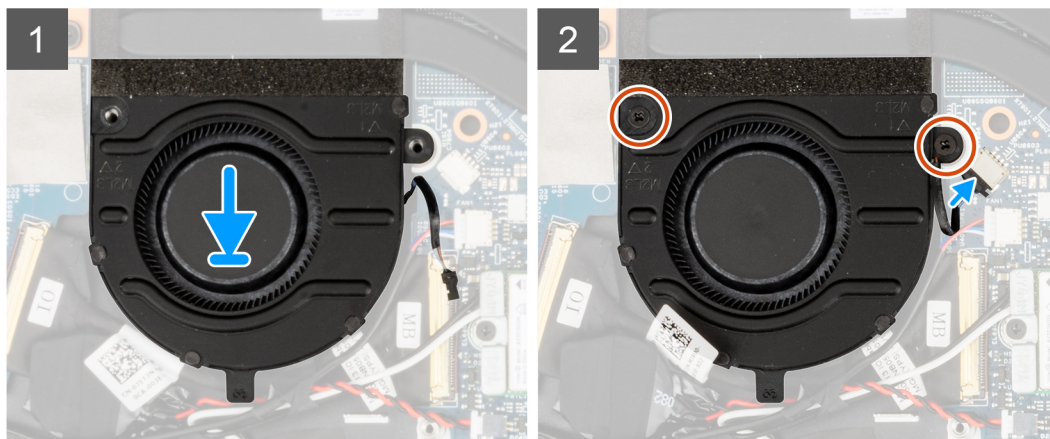
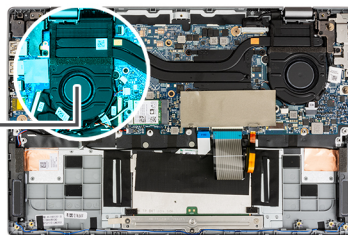
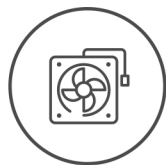

Steps

1. Align and place the system fan onto the palmrest assembly.
2. Install the two (M2x3) screws that secure the system fan in place.
3. Connect the system fan cable to the connector on the system board.

Next steps

1. Install the [battery](#).
2. Install the [base cover](#).
3. Install the [microSD-card](#).
4. Follow the procedure in [after working inside your computer](#).

Removing the right system fan

Prerequisites

1. Follow the procedure in [before working inside your computer](#).
2. Remove the [microSD-card](#).
3. Remove the [base cover](#).
4. Remove the [battery](#).

About this task

The following image indicates the location of the right system fan and provides a visual representation of the removal procedure.



2x
M2x3

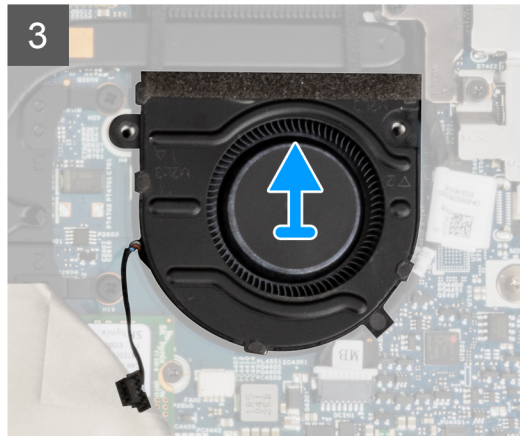
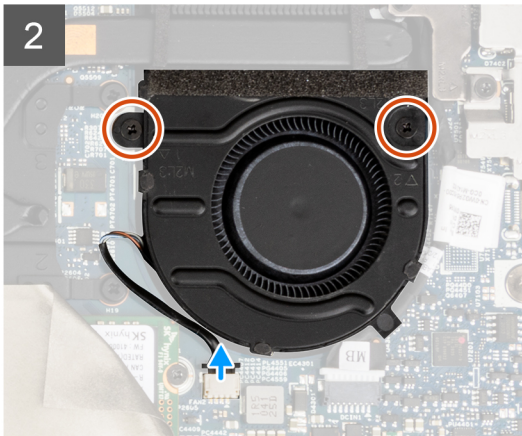
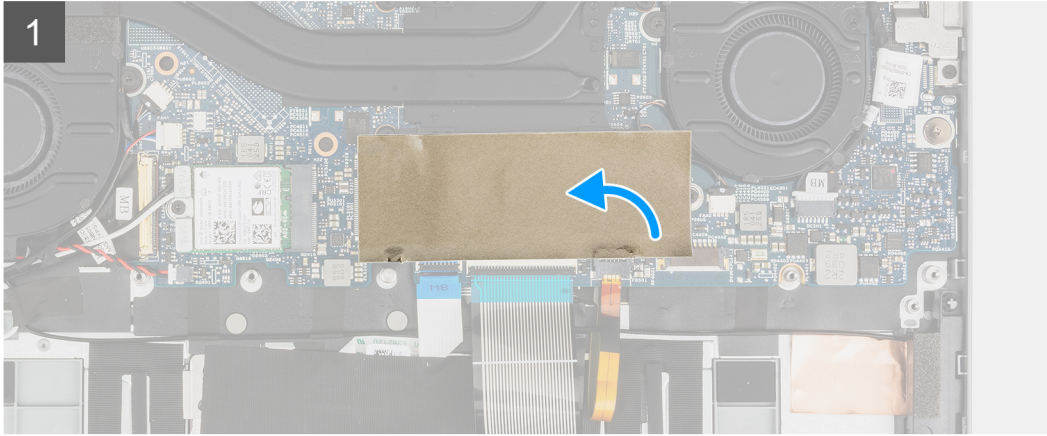
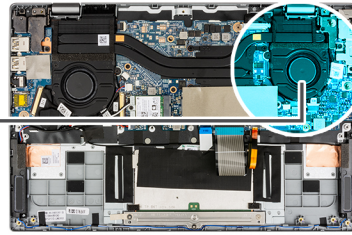
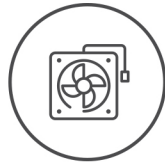

Steps

1. For visibility, open the solid-state drive mylar sheet that covers the solid-state drive.
2. Disconnect the system fan cable from the connector on the system board.
3. Remove the two (M2x3) screws that secure the system fan in place.
4. Lift the system fan off the palmrest assembly.

Installing the right system fan

Prerequisites

If you are replacing a component, remove the existing component before performing the installation procedure.

About this task

The following image indicates the location of the right system fan and provides a visual representation of the installation procedure.



2x
M2x3

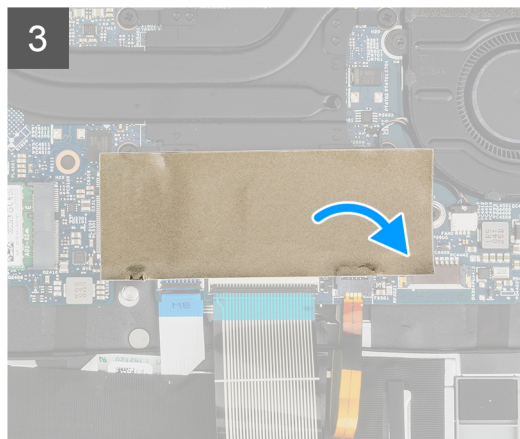
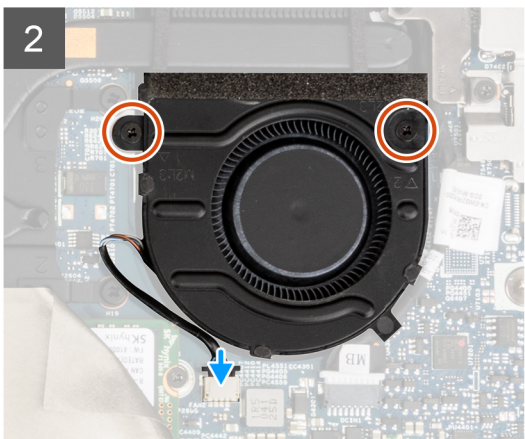
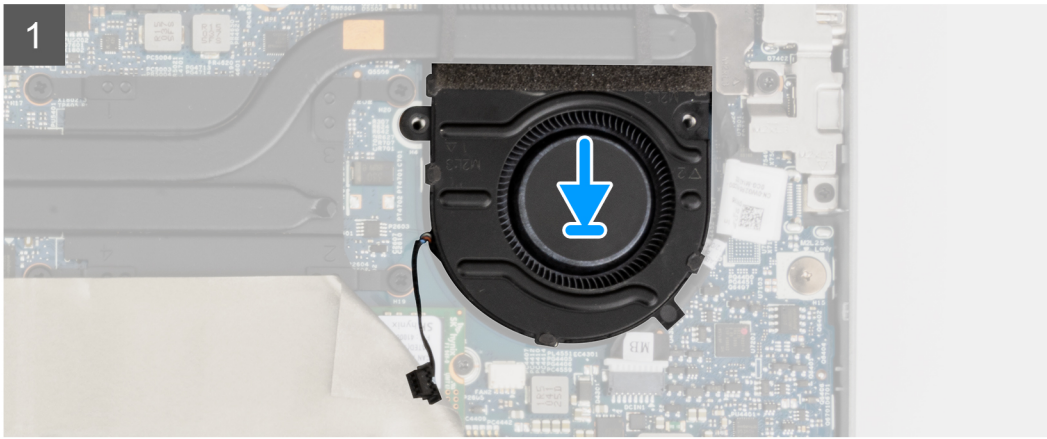
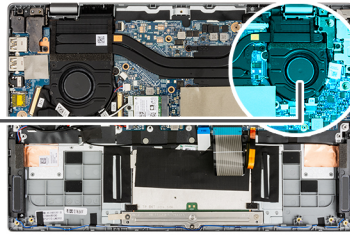
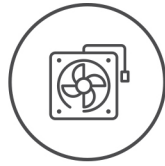

Steps

1. Align and place the system fan onto the palmrest assembly.
2. Install the two (M2x3) screws that secure the system fan in place.
3. Connect the system fan cable to the connector on the system board.
4. Close the solid-state drive mylar sheet to cover the solid-state drive.

Next steps

1. Install the [battery](#).
2. Install the [base cover](#).
3. Install the [microSD-card](#).
4. Follow the procedure in [after working inside your computer](#).

Display assembly

Removing the display assembly

Prerequisites

1. Follow the procedure in [before working inside your computer](#).
2. Remove the [microSD-card](#).
3. Enter the [service mode](#).
4. Remove the [base cover](#).

About this task

The following images indicate the location of the display assembly and provide a visual representation of the removal procedure.

 **NOTE:** The display assembly removal procedure is the same for both laptop and convertible chassis.



1x
M2x2.5

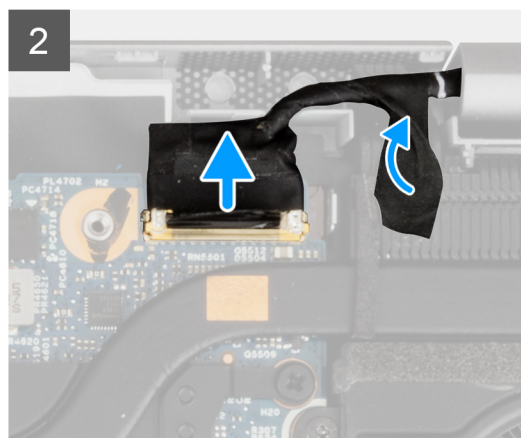
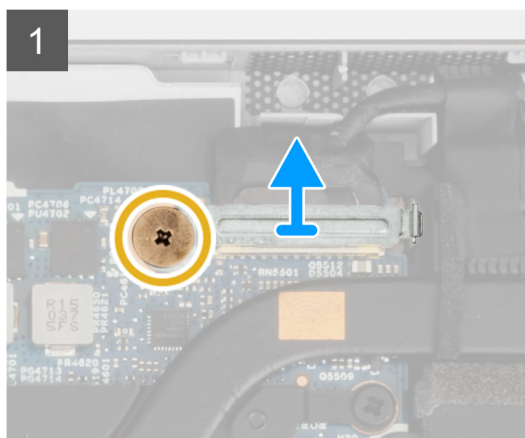
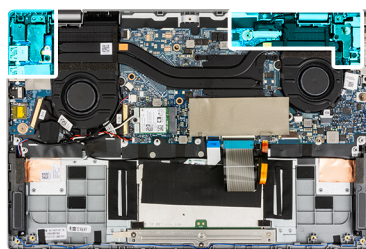



4x
M2x3



1x
M2x2.5

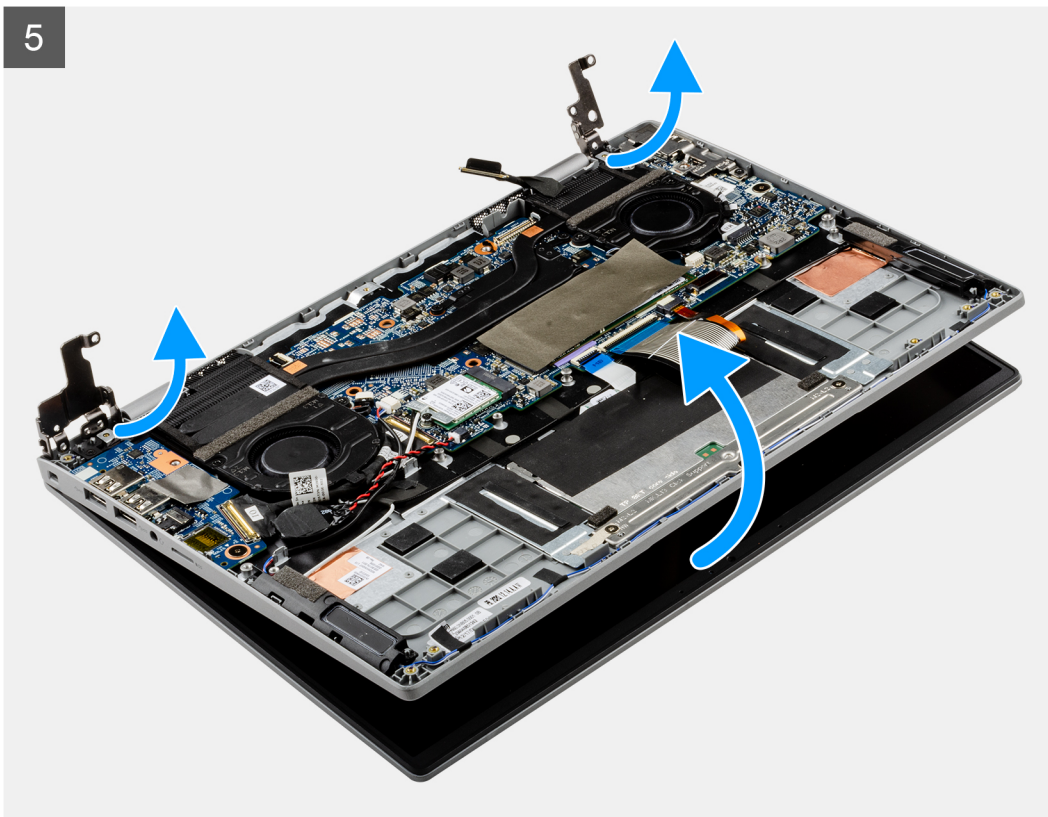
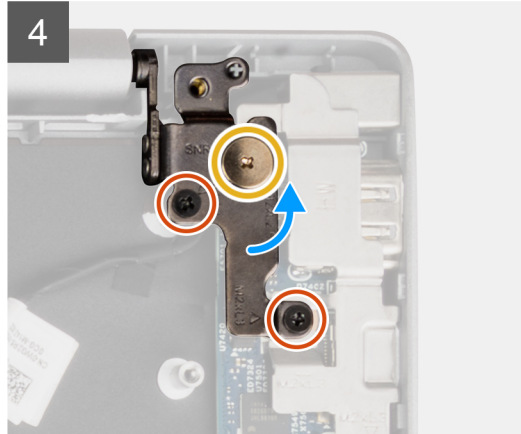
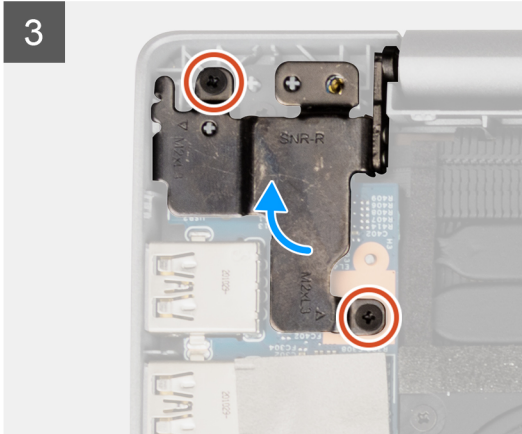

Steps

1. Remove the (M2x2.5) screw that secures the display cable bracket. Remove the display cable bracket.
2. Disconnect the display cable from the connector on the system board.
3. Peel the adhesive tape that secures the display cable.
4. Remove the (M2x2.5) screw and four (M2x3) screws that secure the display hinges to the system.
5. Lift the left and right hinges in upward direction away from the system.
6. Lift the system chassis off the display assembly.

After performing the preceding steps, you are left with the display assembly.



Installing the display assembly

Prerequisites

If you are replacing a component, remove the existing component before performing the installation procedure.

NOTE: The display assembly installation procedure is the same for both laptop and convertible chassis.

About this task

The following images indicate the location of the display assembly and provide a visual representation of the installation procedure.

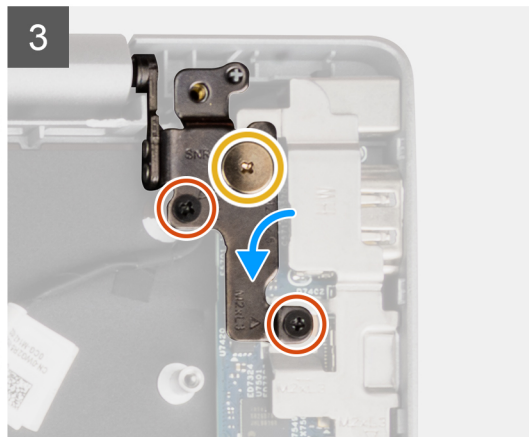
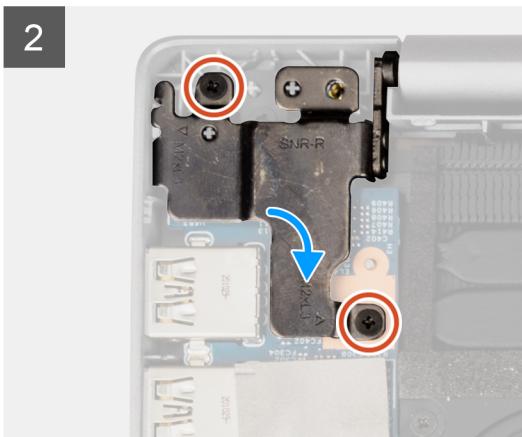
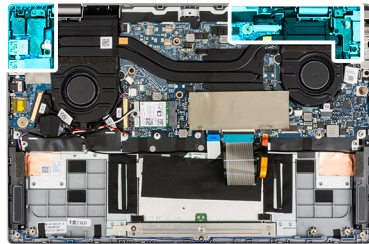
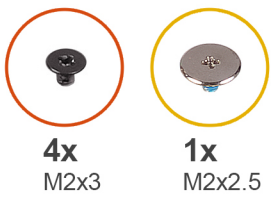
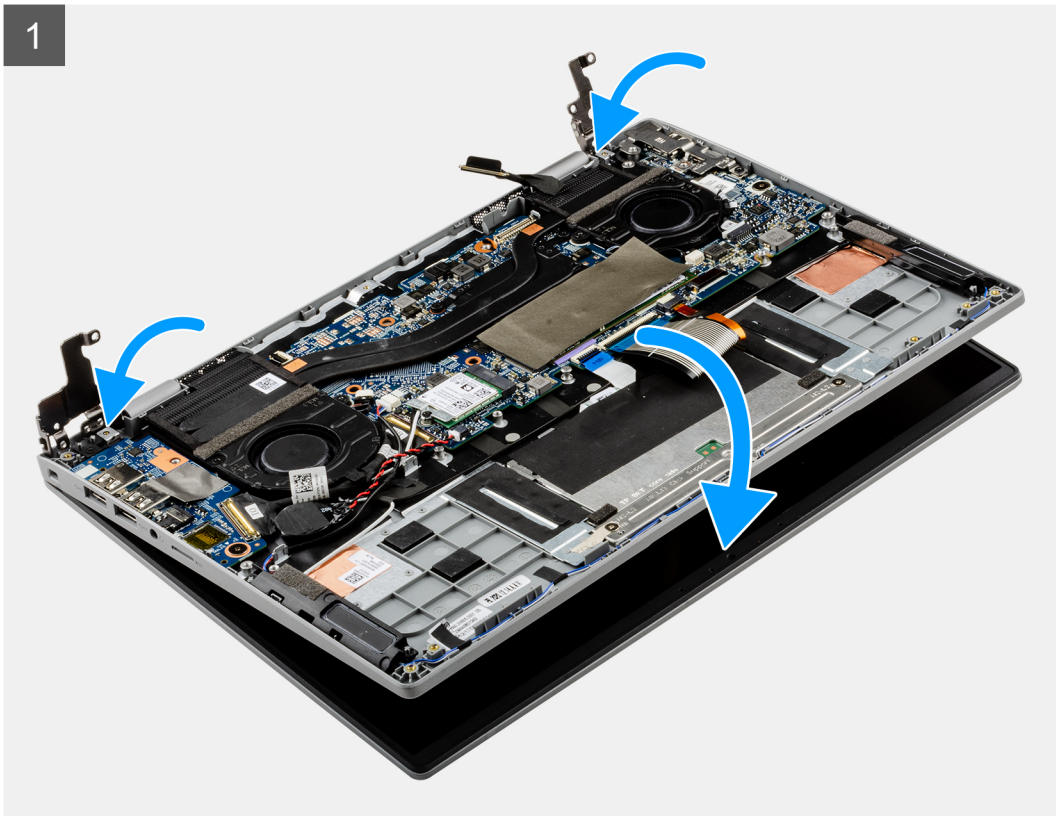



1x
M2x2.5

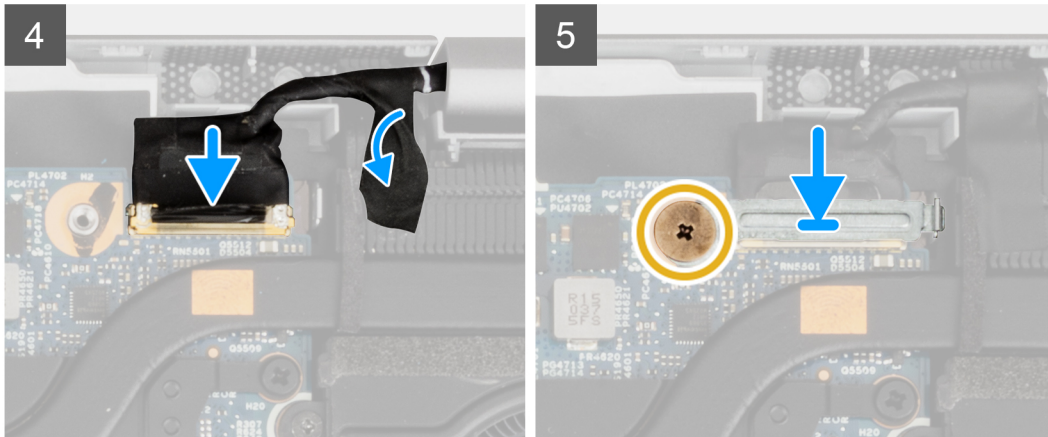

Steps

1. Align and place the system chassis under the hinges of the display assembly.
2. Install the (M2x2.5) screw and four (M2x3) screws that secure the display hinges to the system.
3. Connect the display cable to its connector on the system board. Adhere the adhesive tape to secure the display cable.
4. Align and place the display cable bracket in place.
5. Install the (M2x2.5) screw to secure the display cable bracket.

Next steps

1. Install the [base cover](#).
2. Exit the [service mode](#).
3. Install the [microSD-card](#).
4. Follow the procedure in [after working inside your computer](#).

Input Output board

Removing the Input Output board

Prerequisites

1. Follow the procedure in [before working inside your computer](#).
2. Remove the [microSD-card](#).
3. Enter the [service mode](#).
4. Remove the [base cover](#).

About this task

The following image indicates the location of the Input Output board and provides a visual representation of the removal procedure.

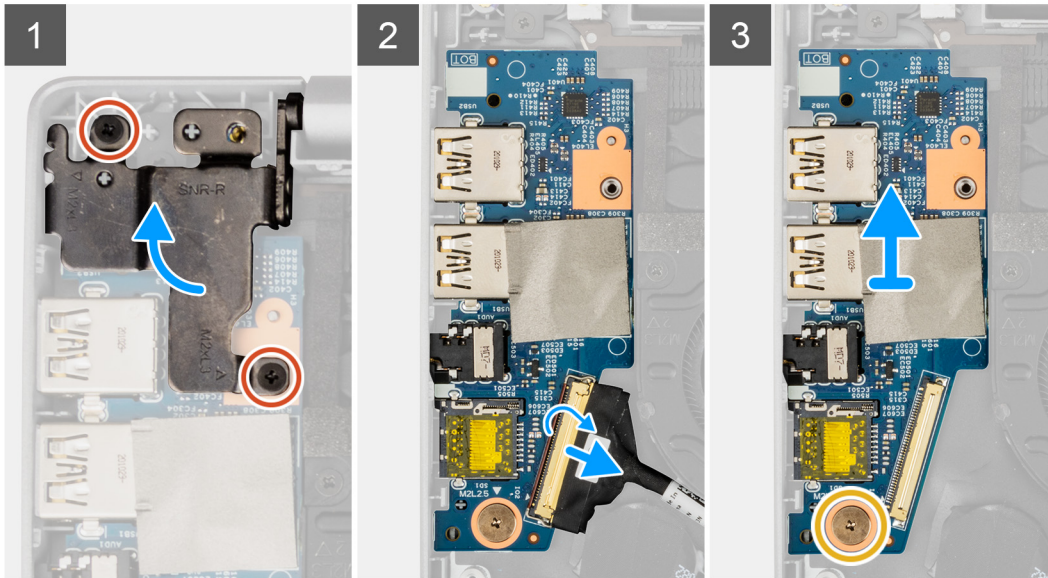
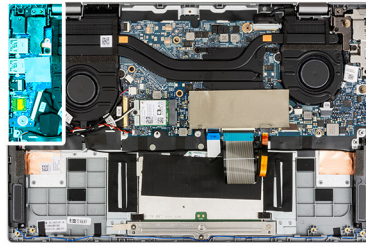
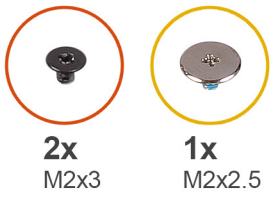

Steps

1. Remove the two (M2x3) screws that secure the left display hinge to the system.
2. Lift the left hinge in upward direction away from the system.
3. Open the latch and disconnect the Input Output board cable from the connector on the Input Output board.
4. Remove the (M2x2.5) screw that secures the Input Output board to the palmrest assembly.
5. Lift the Input Output board off the palmrest assembly.

Installing the Input Output board

Prerequisites

If you are replacing a component, remove the existing component before performing the installation procedure.

About this task

The following image indicates the location of the I/O board and provides a visual representation of the installation procedure.

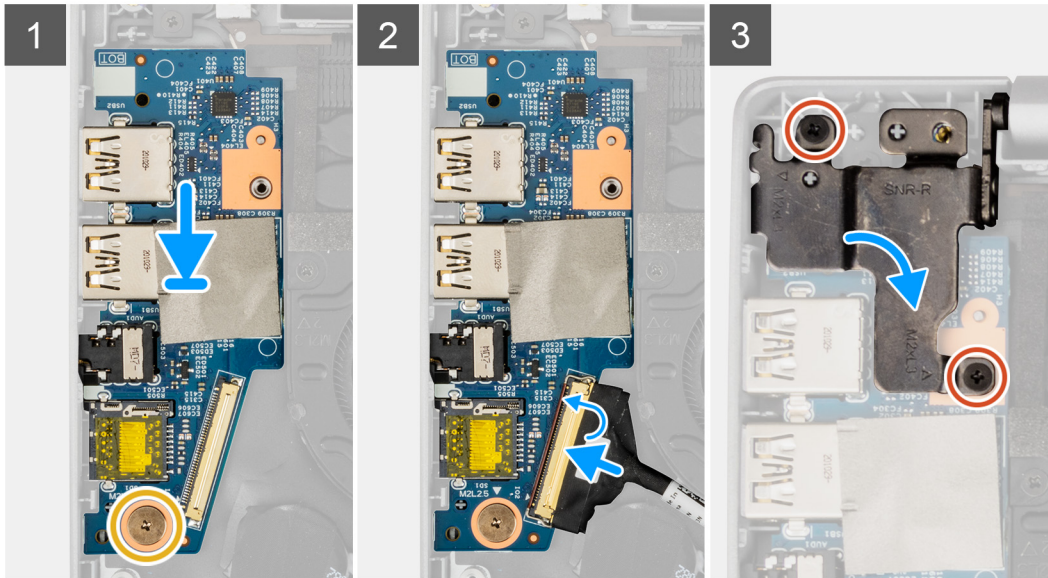
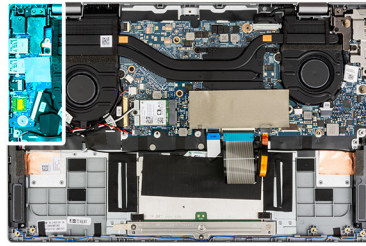
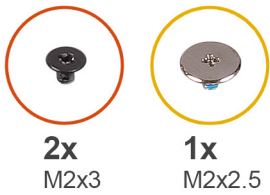

Steps

1. Align and place the Input Output board on the palmrest assembly.
2. Install the (M2x2.5) screw to secure the Input Output board to the palmrest assembly.
3. Connect the Input Output board cable to the connector on the Input Output board and close its latch.
4. Gently press the left hinge in downward direction toward the system.
5. Install the two (M2x3) screws to secure the left display hinge to the system.

Next steps

1. Install the [base cover](#).
2. Exit the [service mode](#).
3. Install the [microSD-card](#).
4. Follow the procedure in [after working inside your computer](#).

Heatsink assembly

Removing the heatsink assembly

Prerequisites

1. Follow the procedure in [before working inside your computer](#).
2. Remove the [microSD-card](#).
3. Enter the [service mode](#).
4. Remove the [base cover](#).

About this task

The following image indicates the location of the heatsink assembly and provides a visual representation of the removal procedure.

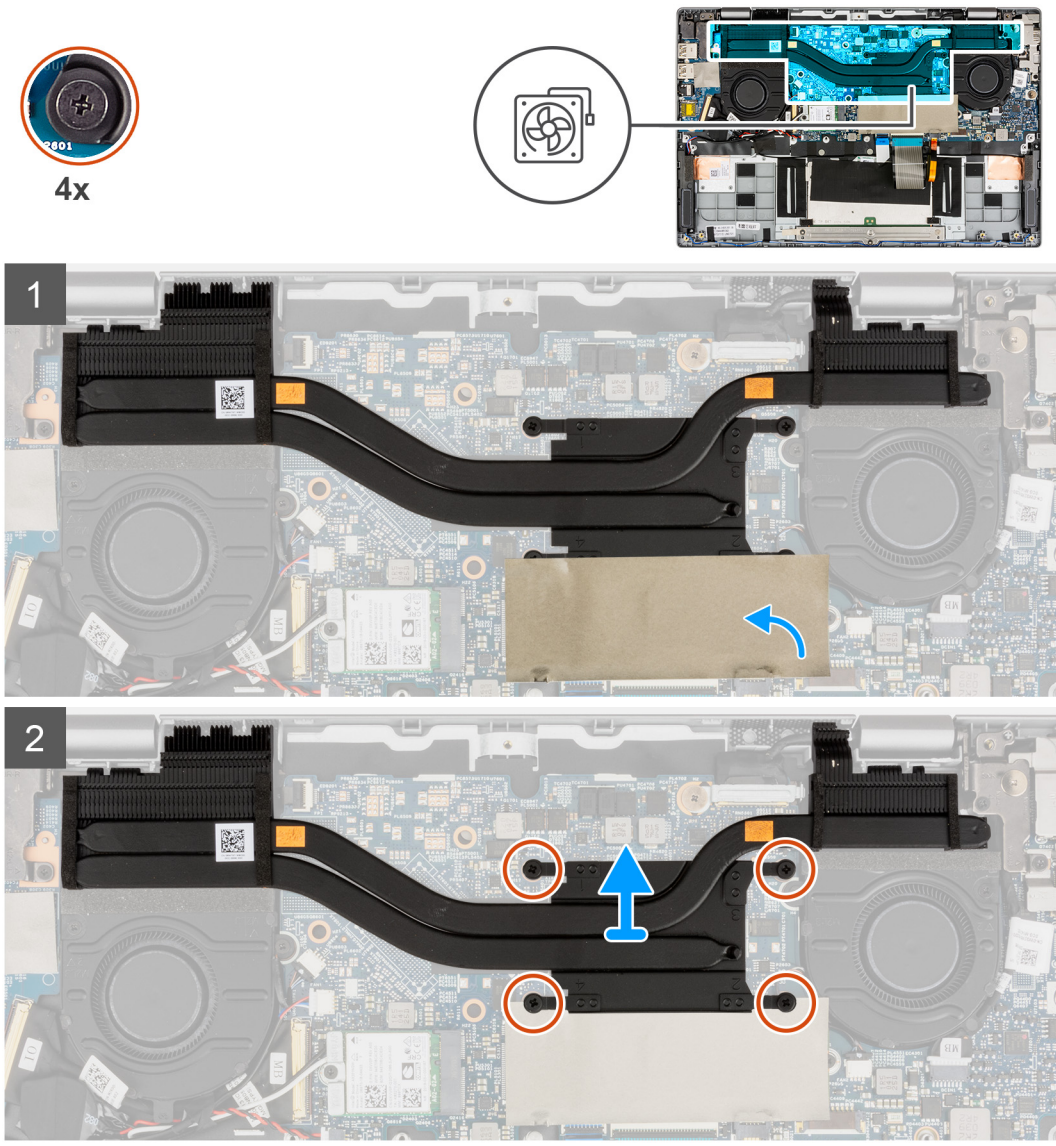

Steps

1. For visibility, open the solid-state drive mylar sheet that covers the solid-state drive.
2. Loosen the four captive screws (in reverse order, 4->3->2->1) that secure the heatsink assembly to the system board.
3. Slide, lift and remove the heatsink assembly from the system board.

Installing the heatsink assembly

Prerequisites

If you are replacing a component, remove the existing component before performing the installation procedure.

About this task

The following image indicates the location of the heatsink assembly and provides a visual representation of the installation procedure.



4x

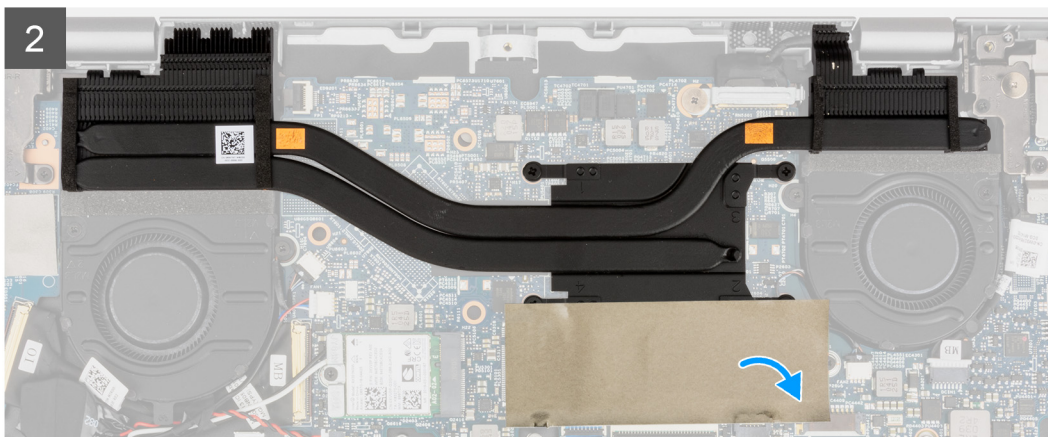
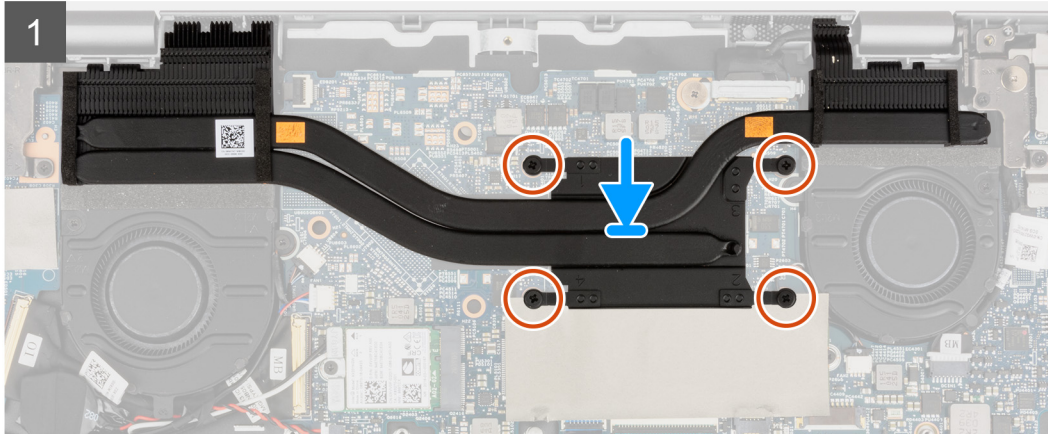
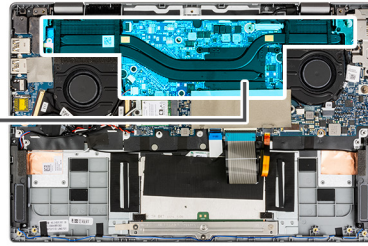
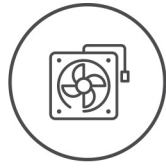

Steps

1. Align and place the heatsink assembly into the slot on the system board.
2. Tighten the four captive screws to secure the heatsink assembly to the system board.
3. Close the solid-state drive mylar sheet to cover the solid-state drive.

Next steps

1. Install the [base cover](#).
2. Exit the [service mode](#).
3. Install the [microSD-card](#).
4. Follow the procedure in [after working inside your computer](#).

Touchpad

Removing the touchpad

Prerequisites

1. Follow the procedure in [before working inside your computer](#).

2. Remove the [microSD-card](#).
3. Remove the [base cover](#).
4. Remove the [battery](#).

About this task

The following image indicates the location of the touchpad and provides a visual representation of the removal procedure.

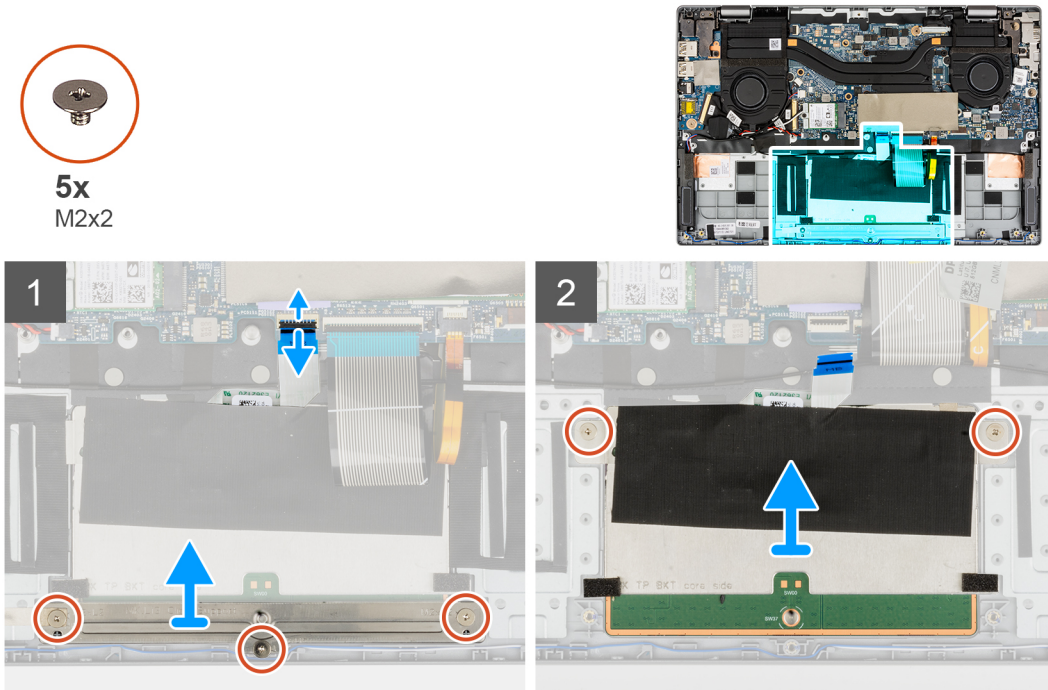

Steps

1. Open the latch and disconnect the touchpad cable from the connector on the system board.
2. Remove the three (M2x2) screws that secure the touchpad bracket to the touchpad module.
3. Lift and remove the touchpad bracket from the touchpad module.
4. Remove the two (M2x2) screws that secure the touchpad module to the palmrest assembly.
5. Lift and remove the touchpad module from the palmrest assembly.

Installing the touchpad

Prerequisites

If you are replacing a component, remove the existing component before performing the installation procedure.

About this task

The following image indicates the location of the touchpad and provides a visual representation of the installation procedure.



5x
M2x2

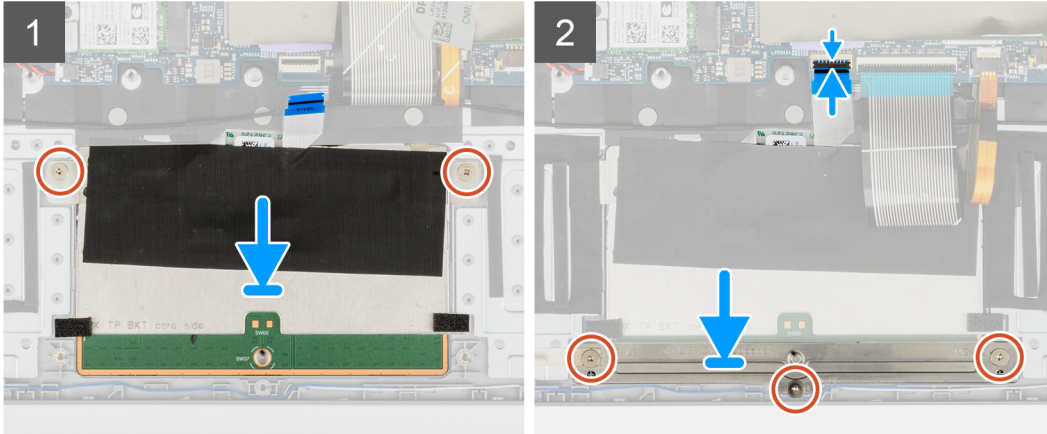
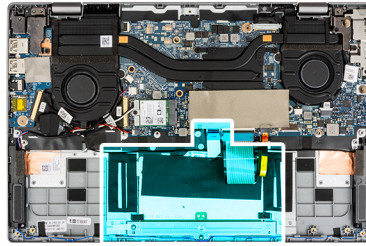

Steps

1. Align and place the touchpad module into the slot on the palmrest assembly.
2. Install the two (M2x2) screws to secure the touchpad module to the palmrest assembly.
3. Align and place the touchpad bracket on the touchpad module.
4. Install the three (M2x2) screws to secure the touchpad bracket to the touchpad module.
5. Connect the touchpad cable to the connector on the system board and close the latch.

Next steps

1. Install the [battery](#).
2. Install the [base cover](#).
3. Install the [microSD-card](#).
4. Follow the procedure in [after working inside your computer](#).

Power-button board

Removing the power-button board

Prerequisites

1. Follow the procedure in [before working inside your computer](#).
2. Remove the [microSD-card](#).
3. Enter the [service mode](#).
4. Remove the [base cover](#).
5. Remove the [display assembly](#).
6. Remove the [input output board](#).
7. Remove the [heatsink assembly](#).

About this task

The following image indicates the location of the power-button board and provides a visual representation of the removal procedure.



1x
M2x3

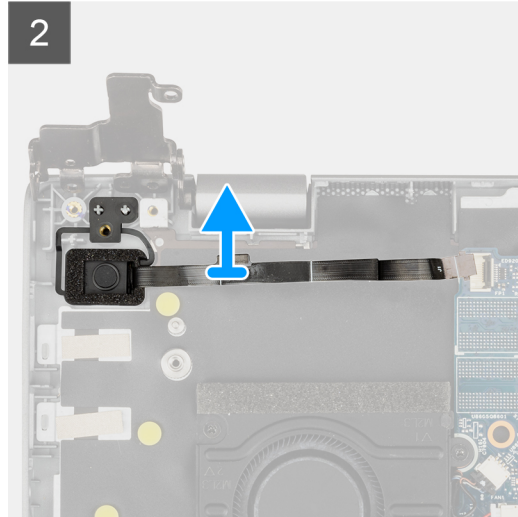
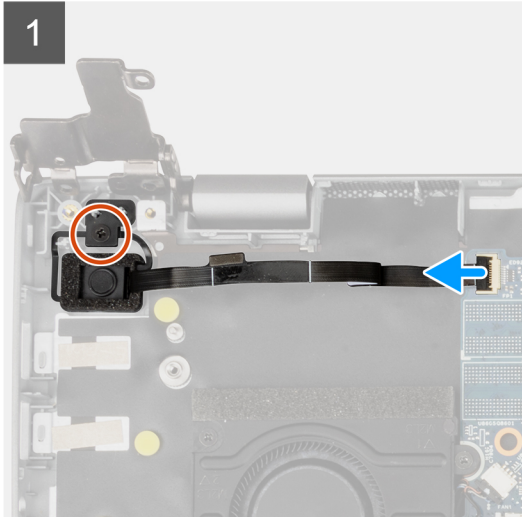
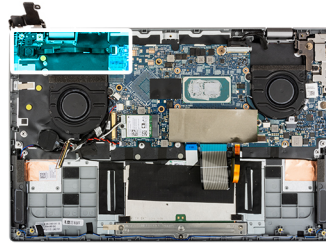

Steps

1. Open the latch and disconnect the power-button board cable from the connector on the system board.
2. Remove the (M2x3) screw that secures the power-button board to the chassis.
3. Remove the power-button board from the chassis.

Installing the power-button board

Prerequisites

If you are replacing a component, remove the existing component before performing the installation procedure.

About this task

The following image indicates the location of the power-button board and provides a visual representation of the installation procedure.



1x
M2x3

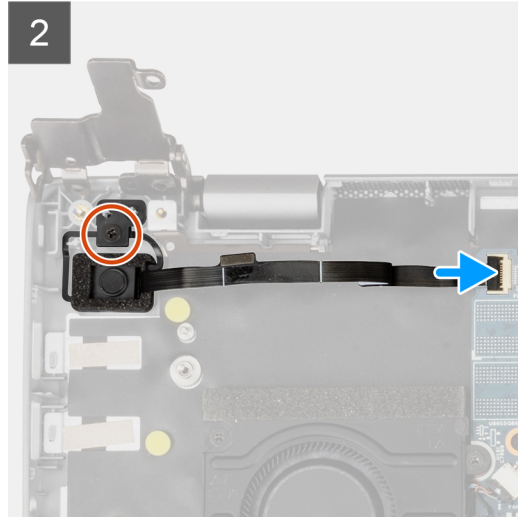
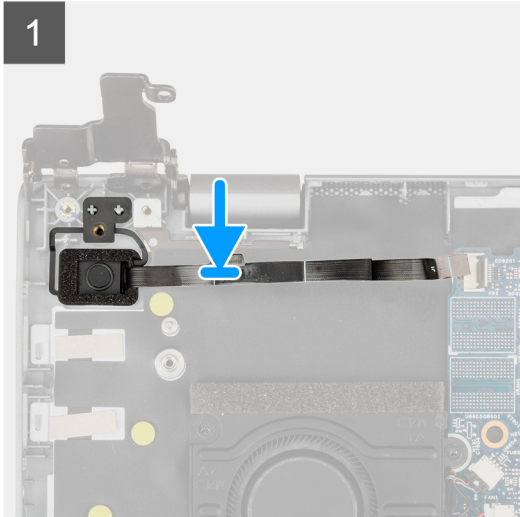
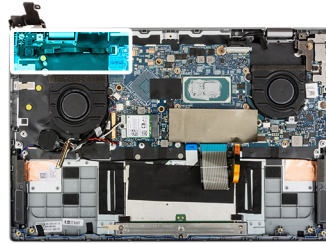

Steps

1. Align and place the power-button board on the chassis.
2. Install the (M2x3) screw to secure the power-button board to the chassis.
3. Connect the power-button board cable to the connector on the system board and close its latch.

Next steps

1. Install the [heatsink assembly](#).
2. Install the [input output board](#).
3. Install the [display assembly](#).
4. Install the [base cover](#).
5. Exit the [service mode](#).
6. Install the [microSD-card](#).
7. Follow the procedure in [after working inside your computer](#).

System board

Removing the system board

Prerequisites

1. Follow the procedure in [before working inside your computer](#).
2. Remove the [microSD-card](#).
3. Enter the [service mode](#).
4. Remove the [base cover](#).
5. Remove the [speaker](#).
6. Remove the [M.2 solid-state drive](#).
7. Remove the [system fan](#).
8. Remove the [display assembly](#).
9. Remove the [input output board](#).

10. Remove the [heatsink assembly](#).
11. Remove the [power button with fingerprint reader](#).

About this task

The following image indicates the connectors on your system board.

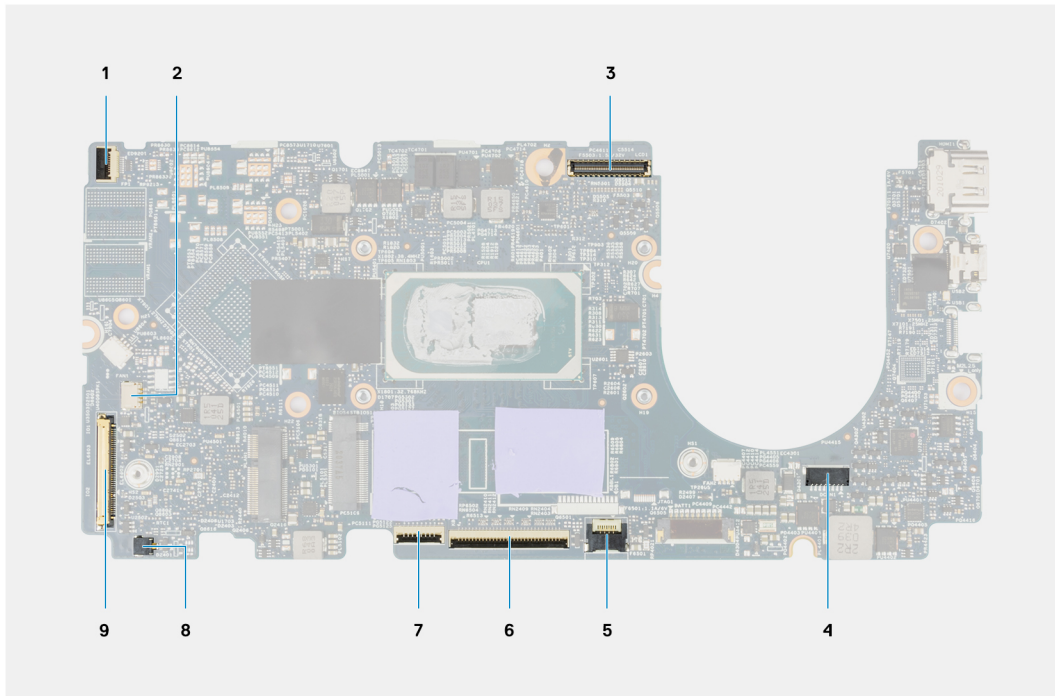
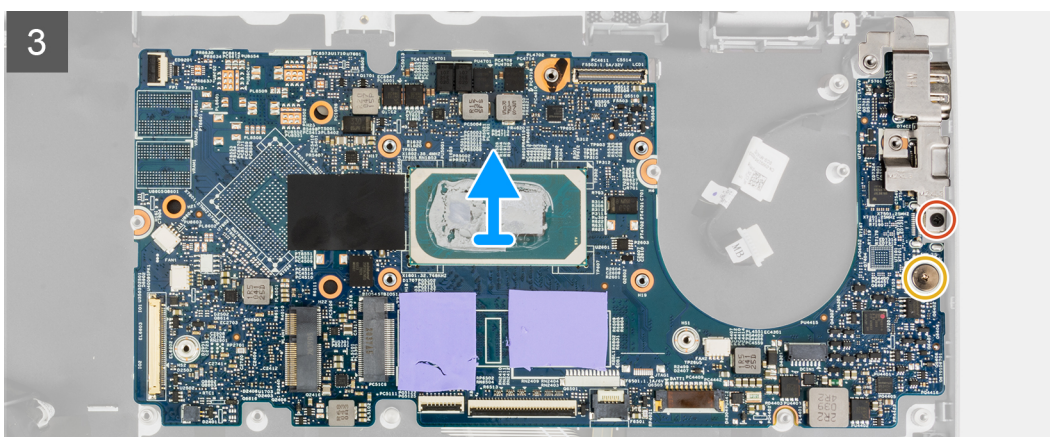
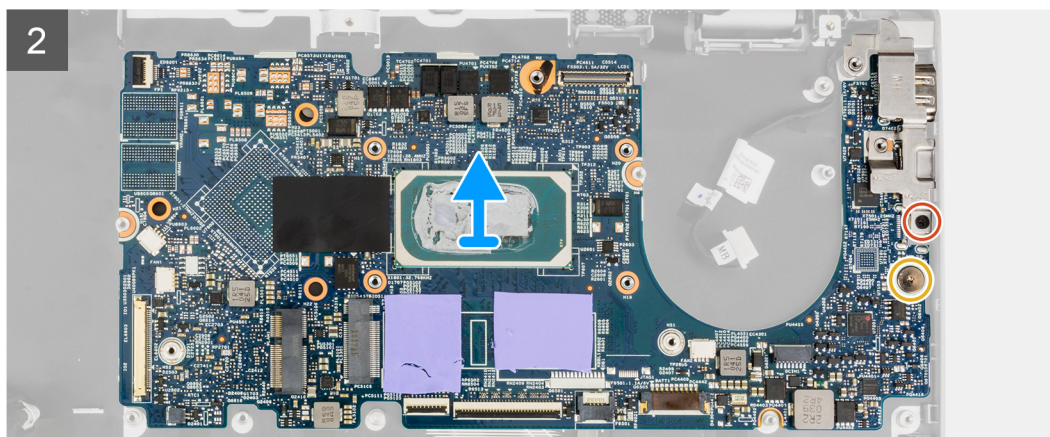
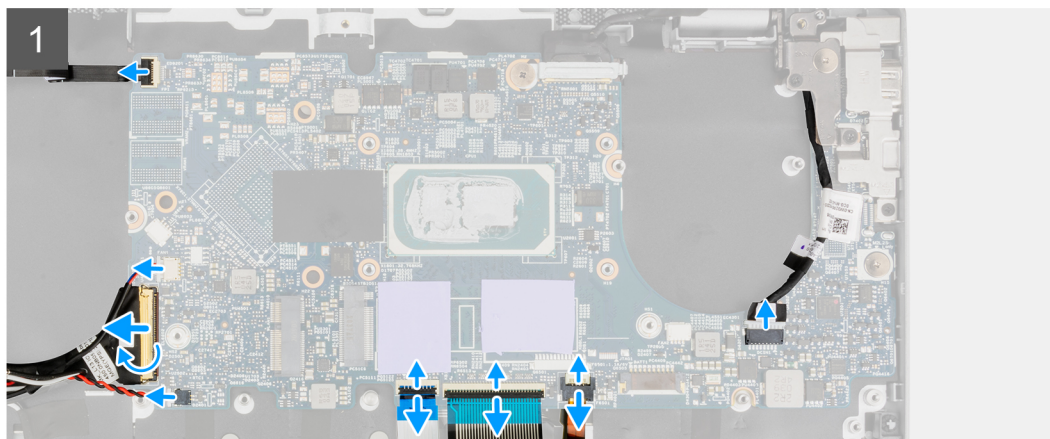
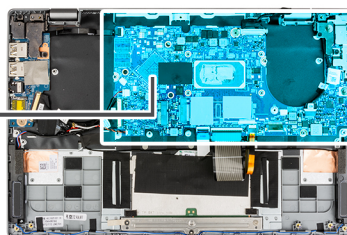
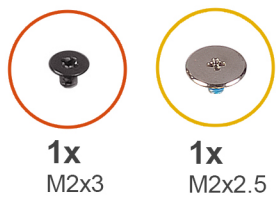

Figure 1. System-board connectors

- | | |
|---|----------------------------|
| 1. Power button with fingerprint reader cable | 2. Speaker cable |
| 3. Display cable | 4. Power cable |
| 5. Backlit LED cable | 6. Keyboard cable |
| 7. Touchpad cable | 8. Coin-cell battery cable |
| 9. Input output board cable | |

The following images indicate the location of the system board assembly and provide a visual representation of the removal procedure.



Steps

1. Open the latch and disconnect the touchpad cable, keyboard cable and LED cable from the connectors on the system board.
2. Disconnect the power cable, power button with finger print reader cable, speaker cable, and coin-cell battery cable from the connectors on the system board.
3. Open the latch and pull the input output board cable from the connector on the system board.
4. Remove the (M2x2.5) screw that secures the system board in place.

5. Remove the (M2x3) screw that secures the type-c bracket in place.
6. Lift and remove the system board from the system.
7. Lift and remove the type-c bracket from the system.

Installing the system board

Prerequisites

If you are replacing a component, remove the existing component before performing the installation procedure.

About this task

The following image indicates the connectors on your system board.

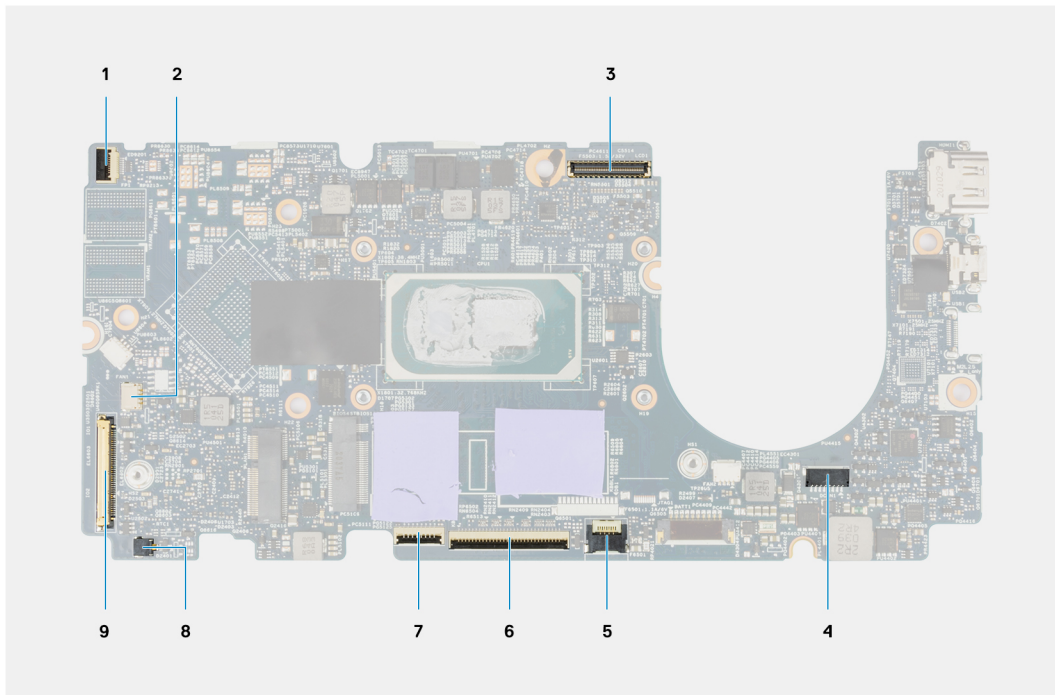

Figure 2. System-board connectors

- | | |
|---|----------------------------|
| 1. Power button with fingerprint reader cable | 2. Speaker cable |
| 3. Display cable | 4. Power cable |
| 5. Backlit LED cable | 6. Keyboard cable |
| 7. Touchpad cable | 8. Coin-cell battery cable |
| 9. Input output board cable | |

The following images indicate the location of the system board and provide a visual representation of the installation procedure.



1x
M2x3



1x
M2x2.5

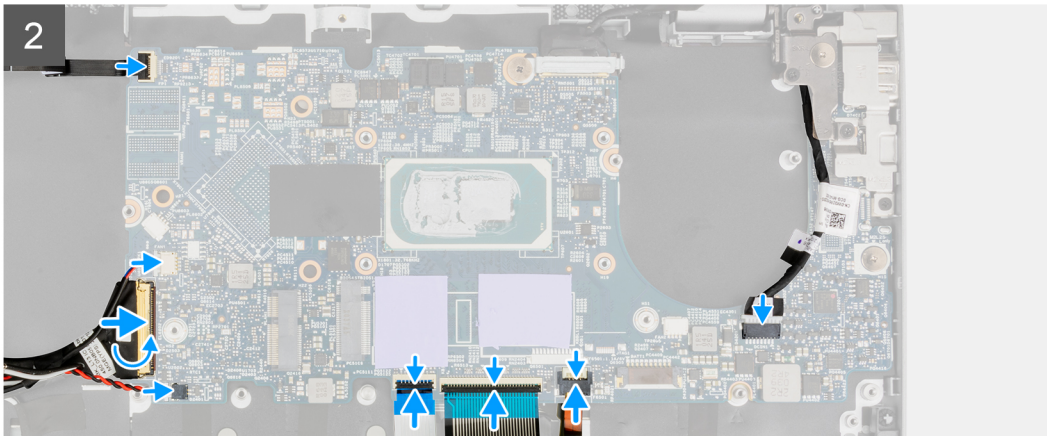
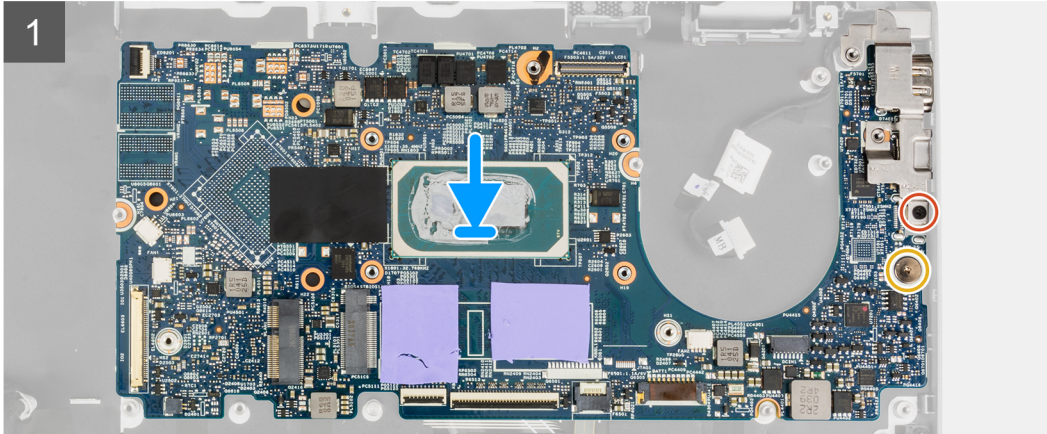
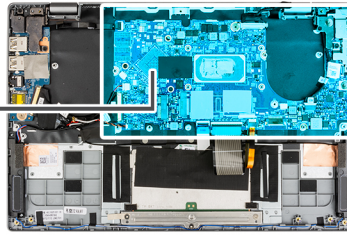

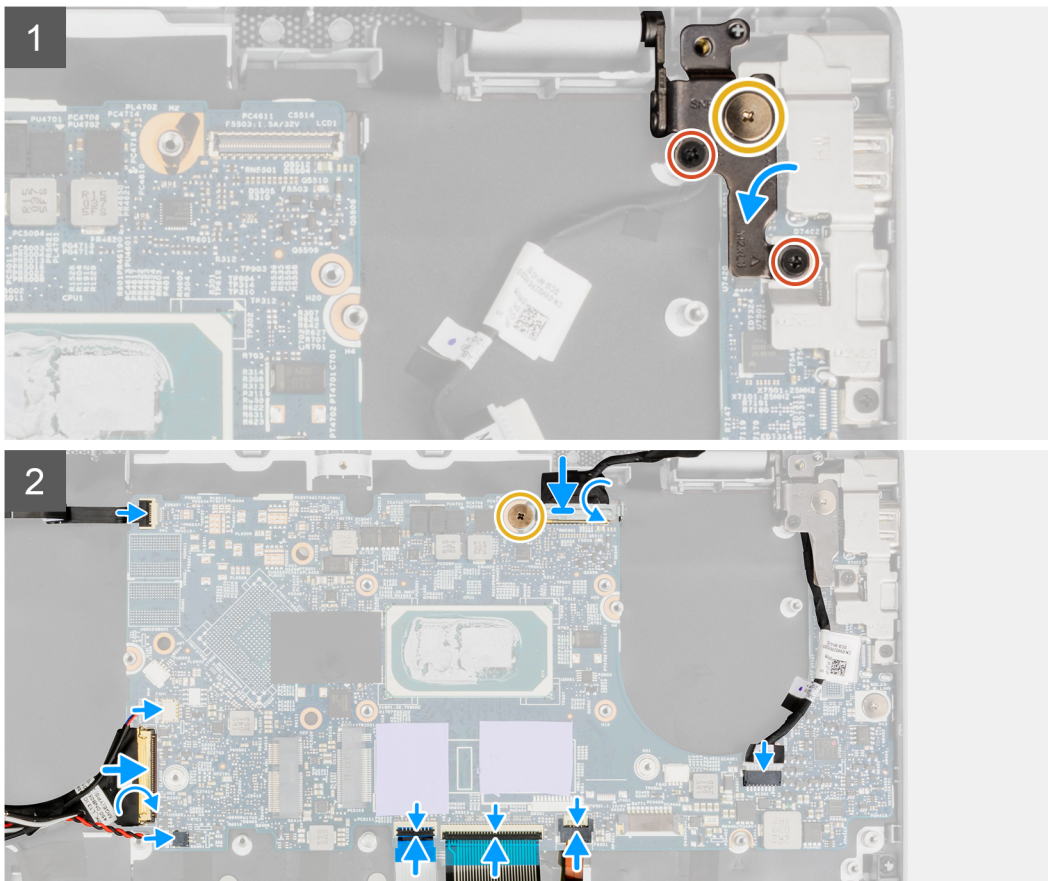

Steps

1. Align and place the type-c bracket on the system board.

NOTE: The type-c bracket must be installed on the system board before installing the system board into the palmrest assembly. Technicians cannot install the Type-c bracket once the system board is assembled into the palmrest assembly.

2. Align and place the system board on the chassis.
3. Install the (M2x3) screw to secure the type-c bracket in place.
4. Install the (M2x2.5) screw to secure the system board in place.
5. Connect the input output board cable to the connector on the system board and close the latch.
6. Connect the power cable, power button with finger print reader cable, speaker cable, and coin-cell battery cable to the connectors on the system board.
7. Connect the touchpad cable, keyboard cable, and LED cable to the connectors on the system board and close the latch.

Next steps

1. Install the [power button with fingerprint reader](#).
2. Install the [heatsink assembly](#).
3. Install the [input output board](#).
4. Install the [display assembly](#).
5. Install the [system fan](#).
6. Install the [M.2 solid-state drive](#).
7. Install the [speakers](#).
8. Install the [base cover](#).
9. Exit the [service mode](#).
10. Install the [microSD-card](#).
11. Follow the procedure in [after working inside your computer](#).

Power adapter port

Removing the power adapter port

Prerequisites

1. Follow the procedure in [before working inside your computer](#).
2. Remove the [microSD-card](#).
3. Enter the [service mode](#).
4. Remove the [base cover](#).
5. Remove the [speaker](#).
6. Remove the [M.2 solid-state drive](#).
7. Remove the [system fan](#).
8. Remove the [display assembly](#).
9. Remove the [input output board](#).
10. Remove the [heatsink assembly](#).
11. Remove the [power button with fingerprint reader](#).
12. Remove the [system board](#).

 **NOTE:** The system board can be removed with the heat sink attached.

About this task

The following image indicates the location of the power adapter port and provides a visual representation of the removal procedure.

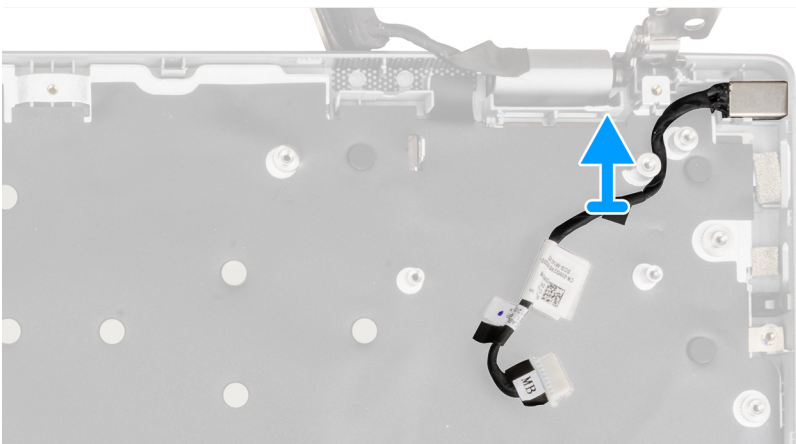
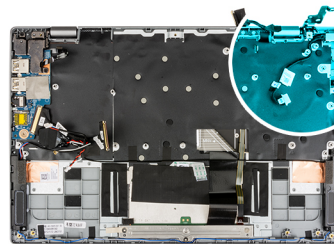

Steps

1. Unroute the power adapter port cable from the screw post.

 **CAUTION:** Carefully unroute the power adapter port cable from the screw post before removing the power adapter port from the chassis.

2. Remove the power adapter port from the chassis.

Installing the power adapter port

Prerequisites

If you are replacing a component, remove the existing component before performing the installation procedure.

About this task

The following image indicates the location of the power adapter port and provides a visual representation of the installation procedure.

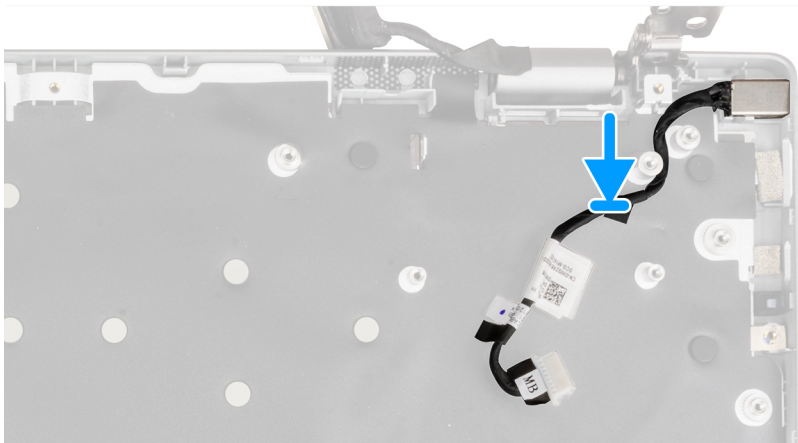
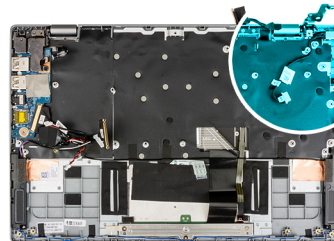

Steps

1. Align and place the power adapter port on the chassis.
2. Route the power adapter port cable through the screw post.

CAUTION: Carefully route the power adapter port cable through the screw post for installing the power adapter port on the chassis.

Next steps

1. Install the [system board](#).
NOTE: The system board can be installed with the heat sink attached.
2. Install the [power button with fingerprint reader](#).
3. Install the [heatsink assembly](#).
4. Install the [input output board](#).
5. Install the [display assembly](#).
6. Install the [system fan](#).
7. Install the [M.2 solid-state drive](#).
8. Install the [speakers](#).
9. Install the [base cover](#).
10. Exit the [service mode](#).
11. Install the [microSD-card](#).
12. Follow the procedure in [after working inside your computer](#).

Palmrest assembly

Removing the palmrest assembly

Prerequisites

1. Follow the procedure in [before working inside your computer](#).
2. Remove the [microSD-card](#).
3. Remove the [base cover](#).
4. Remove the [battery](#).
5. Remove the [speaker](#).
6. Remove the [M.2 solid-state drive](#).
7. Remove the [system fan](#).
8. Remove the [display assembly](#).
9. Remove the [input output board](#).
10. Remove the [heatsink assembly](#).
11. Remove the [touchpad](#).
12. Remove the [power button with fingerprint reader](#).
13. Remove the [system board](#).

i **NOTE:** The system board can be removed with the heat sink attached.

About this task

The following image indicates the location of the palmrest and provides a visual representation of the removal procedure.

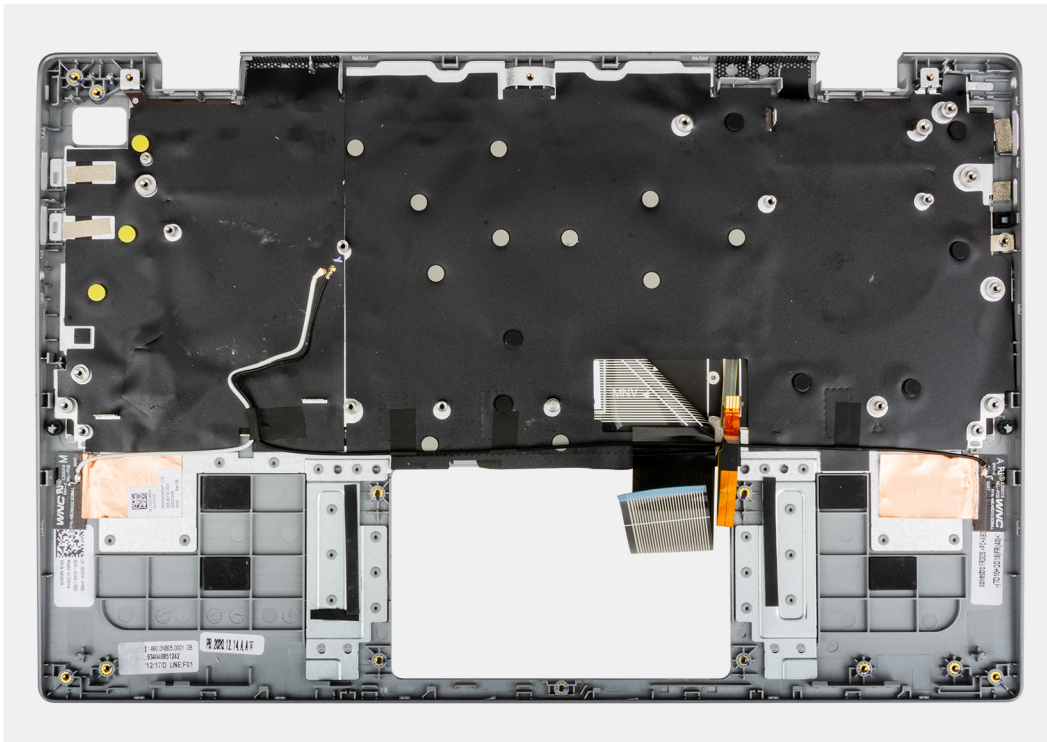

Steps

After performing the preceding steps, you are left with the palmrest assembly.

Next steps

1. Install the [system board](#).

i **NOTE:** The system board can be installed with the heat sink attached.

2. Install the [power button with fingerprint reader](#).
3. Install the [heatsink assembly](#).
4. Install the [touchpad](#).
5. Install the [input output board](#).
6. Install the [display assembly](#).
7. Install the [system fan](#).
8. Install the [M.2 solid-state drive](#).
9. Install the [speakers](#).
10. Install the [battery](#).
11. Install the [base cover](#).
12. Install the [microSD-card](#).
13. Follow the procedure in [after working inside your computer](#).

Drivers and downloads

When troubleshooting, downloading or installing drivers it is recommended that you read the Dell Knowledge Based article, Drivers and Downloads FAQ [000123347](#).

System setup

CAUTION: Unless you are an expert computer user, do not change the settings in the BIOS Setup program. Certain changes can make your computer work incorrectly.

NOTE: Before you change BIOS Setup program, it is recommended that you write down the BIOS Setup program screen information for future reference.

Use the BIOS Setup program for the following purposes:

- Get information about the hardware installed in your computer, such as the amount of RAM and the size of the hard drive.
- Change the system configuration information.
- Set or change a user-selectable option, such as the user password, type of hard drive installed, and enabling or disabling base devices.

BIOS overview

The BIOS manages data flow between the computer's operating system and attached devices such as hard disk, video adapter, keyboard, mouse, and printer.

Entering BIOS setup program

About this task

Turn on (or restart) your computer and press F2 immediately.

Boot menu

Press <F12> when the Dell logo appears to initiate a one-time boot menu with a list of the valid boot devices for the system. Diagnostics and BIOS Setup options are also included in this menu. The devices listed on the boot menu depend on the bootable devices in the system. This menu is useful when you are attempting to boot to a particular device or to bring up the diagnostics for the system. Using the boot menu does not make any changes to the boot order stored in the BIOS.

The options are:

- UEFI Boot:
 - Windows Boot Manager
- Other Options:
 - BIOS Setup
 - BIOS Flash Update
 - Diagnostics
 - Change Boot Mode Settings

Navigation keys

NOTE: For most of the System Setup options, changes that you make are recorded but do not take effect until you restart the system.

Keys

Up arrow

Navigation

Moves to the previous field.



Keys	Navigation
Down arrow	Moves to the next field.
Enter	Selects a value in the selected field (if applicable) or follow the link in the field.
Spacebar	Expands or collapses a drop-down list, if applicable.
Tab	Moves to the next focus area.
Esc	Moves to the previous page until you view the main screen. Pressing Esc in the main screen displays a message that prompts you to save any unsaved changes and restarts the system.

Boot Sequence

Boot sequence enables you to bypass the System Setup–defined boot device order and boot directly to a specific device (for example: optical drive or hard drive). During the Power-on Self-Test (POST), when the Dell logo appears, you can:

- Access System Setup by pressing F2 key
- Bring up the one-time boot menu by pressing F12 key.

The one-time boot menu displays the devices that you can boot from including the diagnostic option. The boot menu options are:

- Removable Drive (if available)
- STXXXX Drive
 -  **NOTE:** XXXX denotes the SATA drive number.
- Optical Drive (if available)
- SATA Hard Drive (if available)
- Diagnostics
 -  **NOTE:** Choosing **Diagnostics**, displays the **SupportAssist** screen.

The boot sequence screen also displays the option to access the System Setup screen.

System setup options

 **NOTE:** Depending on your system and its installed devices, the items that are listed in this section may or may not appear.

Table 3. System setup options—System information menu

Overview	
Latitude 3320	
BIOS Version	Displays the BIOS version number.
Service Tag	Displays the Service Tag of the system.
Asset Tag	Displays the Asset Tag of the system.
Manufacture Date	Displays the manufacture date of the system.
Ownership Date	Displays the ownership date of the system.
Express Service Code	Displays the express service code of the system.
Ownership Tag	Displays the Ownership Tag of the system.
Signed Firmware Update	Displays whether the Signed Firmware Update is enabled on your system.
Battery Information	
Primary	Displays that battery is primary.
Battery Level	Displays the battery level of the system.
Battery State	Displays the battery state of the system.

Table 3. System setup options—System information menu (continued)

Overview	
Health	Displays the battery health of the system.
AC Adapter	Displays whether the AC adapter is connected or not.
Processor Information	
Processor Type	Displays the processor type.
Maximum Clock Speed	Displays the maximum processor clock speed.
Minimum Clock Speed	Displays the minimum processor clock speed.
Current Clock Speed	Displays the current processor clock speed.
Core Count	Displays the number of cores on the processor.
Processor ID	Displays the processor identification code.
Processor L2 Cache	Displays the processor L2 Cache size.
Processor L3 Cache	Displays the processor L3 Cache size.
Microcode Version	Displays the microcode version.
Intel Hyper-Threading Capable	Displays whether the processor is Hyper-Threading (HT) capable.
64-Bit Technology	Displays whether 64-bit technology is used.
Memory Information	
Memory Installed	Displays the total system memory installed.
Memory Available	Displays the total system memory available.
Memory Speed	Displays the memory speed.
Memory Channel Mode	Displays single or dual channel mode.
Memory Technology	Displays the technology that is used for the memory.
Devices Information	
Panel Type	Displays the Panel Type of the system.
Video Controller	Displays the video controller type of the system.
Video Memory	Displays the video memory information of the system.
Wi-Fi Device	Displays the wireless device information of the system.
Native Resolution	Displays the native resolution of the system.
Video BIOS Version	Displays the video BIOS version of the system.
Audio Controller	Displays the audio controller information of the system.
Bluetooth Device	Displays the Bluetooth device information of the system.

Table 4. System setup options—Boot Configuration menu

Boot Configuration	
Boot Sequence	
Boot mode	Displays the boot mode.
Boot Sequence	Displays the boot sequence.
Secure Digital (SD) Card Boot	Enable or disable the SD card read-only boot. By default, the Secure Digital (SD) Card Boot option is not enabled.
Secure Boot	
Enable Secure Boot	Enable or disable the secure boot feature. By default, the option is not enabled.

Table 4. System setup options—Boot Configuration menu (continued)

Boot Configuration	
Secure Boot Mode	Enable or disable to change the secure boot mode options. By default, the Deployed Mode is enabled.
Expert Key Management	
Enable Custom Mode	Enable or disable custom mode. By default, the custom mode option is not enabled.
Custom Mode Key Management	Select the custom values for expert key management.

Table 5. System setup options—Integrated Devices menu

Integrated Devices	
Date/Time	Displays the current date in MM/DD/YYYY format and current time in HH:MM:SS AM/PM format.
Camera	Enables or disable the camera. By default, the Enable Camera option is selected
Audio	
Enable Audio	Enable or disable the integrated audio controller. By default, all the options are enabled.
USB Configuration	<ul style="list-style-type: none"> • Enable or disable booting from USB mass storage devices that are connected to external USB ports. By default, the Enable External USB Ports option is enabled. • Enable or disable booting from USB mass storage devices such as external hard drive, optical drive, and USB drive. By default, the Enable USB Boot Support option is enabled.
Disable USB4 PCIE Tunneling	Disable the USB4 PCIE Tunneling option. By default, the option is disabled.
Video/Power only on Type-C Ports	Enable or disable the Type-C port functionality to video or power only. By default, the Video/Power only on Type-C Ports option is disabled.

Table 6. System setup options—Storage menu

Storage	
SATA/NVMe Operation	
SATA/NVMe Operation	Set the operating mode of the integrated storage device controller. By default, the RAID On option is enabled.
Storage interface	
Port Enablement	This page allows you to enable the onboard drives. By default, the M.2 PCIe SSD option is enabled.
SMART Reporting	
Enable SMART Reporting	Enable or disable Self-Monitoring, Analysis, and Reporting Technology (SMART) during system startup. By default, the Enable SMART Reporting option is not enabled.
Drive Information	
M.2 PCIe SSD	

Table 6. System setup options—Storage menu (continued)

Storage	
Type	Displays the M.2 PCIe SSD type information of the system.
Device	Displays the M.2 PCIe SSD device information of the system.
Enable MediaCard	
Secure Digital (SD) Card	Enable or disable the SD card. By default, the Secure Digital (SD) Card option is enabled.
Secure Digital (SD) Card Read-Only Mode	Enable or disable the SD card read-only mode. By default, the Secure Digital (SD) Card Read-Only Mode option is not enabled.

Table 7. System setup options—Display menu

Display	
Display Brightness	
Brightness on battery power	Enable to set screen brightness when the system is running on battery power.
Brightness on AC power	Enable to set screen brightness when the system is running on AC power.
EcoPower	
	Enable or disable EcoPower Feature in your panel. EcoPower can increase the battery life of your system by reducing the display brightness when appropriate. By default, Enable EcoPower option is enabled.
Full Screen Logo	
	Enable or disable full screen logo. By default, the option is not enabled.

Table 8. System setup options—Connection menu

Connection	
Wireless Device Enable	
WLAN	Enable or disable the internal WLAN device. By default, the option enabled.
Bluetooth	Enable or disable the internal Bluetooth device By default, the option enabled.
Enable UEFI Network Stack	
	Enable or disable UEFI Network Stack and controls the on-board LAN Controller. By default, the Enable UEFI Network Stack option is enabled.
HTTPs Boot Feature	
HTTPs Boot	Enable or disable the HTTPs Boot feature. By default, the HTTPs Boot option is disabled.

Table 9. System setup options—Power menu

Power	
Battery configuration	
	Enables the system to run on battery during peak power usage hours. Use the table Custom Charge Start and Custom Charge Stop , to prevent AC power usage between certain times of each day. By default, the Adaptive option is enabled.
Advanced Configuration	

Table 9. System setup options—Power menu (continued)

Power	
Enable Advanced Battery Charge Configuration	<p>Enable or disable the advanced battery charge configuration.</p> <p>By default, the Enable Advanced Battery Charge Configuration option is disabled.</p>
<p>Peak Shift</p> <p>Enable Peak Shift</p>	<p>Enables the system to run on battery during peak power usage hours.</p> <p>By default, the Enable Peak Shift option is disabled.</p>
<p>Thermal Management</p>	<p>Enables to cool the fan and processor heat management to adjust the system performance, noise, and temperature.</p> <p>By default, the Optimized option is enabled.</p>
<p>USB Wake Support</p> <p>Enable USB Wake Support</p>	<p>When enabled, the USB devices like a mouse or keyboard can be used to wake the system from Standby, Hibernate, and Power Off.</p> <p>i NOTE: This feature requires Deep Sleep Control to be disabled.</p> <p>i NOTE: This feature is only functional when the AC power adapter is connected. If the AC power adapter is removed before Standby, the BIOS will remove power from all of the USB ports to conserve battery power.</p> <p>By default, the Enable USB Wake Support option is disabled.</p>
Wake on Dell USB-C Dock	<p>When enabled, connecting a Dell USB-C Dock will wake the system from Standby, Hibernate, and Power Off.</p> <p>By default, the Wake on Dell USB-C Dock option is enabled.</p>
<p>Block Sleep</p>	<p>Enables to block entering sleep (S3) mode in the operating system.</p> <p>By default, the Block Sleep option is disabled.</p>
<p>Lid Switch</p> <p>Enabled Lid Switch</p>	<p>Enable or disable the lid switch.</p> <p>By default, the Enable Lid Switch option is enabled.</p>
Power On Lid Open	<p>When enabled, allows the system to power up from the off state whenever the lid is opened.</p> <p>By default, the Power On Lid Open option is enabled.</p>
<p>Intel Speed Shift Technology</p>	<p>Enable or disable the Intel speed shift technology support.</p> <p>By default, the Intel Speed Shift Technology option is enabled.</p>

Table 10. System setup options—Security menu

Security	
<p>TPM 2.0 Security</p> <p>TPM 2.0 Security On</p>	<p>Allows you to enable or disable TPM visibility to operating system.</p> <p>By default, the TPM 2.0 Security On option is enabled.</p>
Attestation Enable	<p>Enables to control whether the Trusted Platform Module (TPM) Endorsement Hierarchy is available to the operating system.</p> <p>By default, the Attestation Enable option is enabled.</p>
Key Storage Enable	<p>Enables to control whether the Trusted Platform Module (TPM) Storage Hierarchy is available to the operating system.</p> <p>By default, the Key Storage Enable option is enabled.</p>

Table 10. System setup options—Security menu (continued)

Security	
SHA-256	<p>When enabled, the BIOS and TPM will use the SHA-256 hash algorithm to extend measurements into the TPM PCRs during BIOS boot.</p> <p>By default, the SHA-256 option is enabled.</p>
Clear	<p>Enables to clear the TPM owner information and returns the TPM to the default state.</p> <p>By default, the Clear option is disabled.</p>
PPI Bypass for Clear Commands	<p>Controls the TPM Physical Presence Interface (PPI).</p> <p>By default, the PPI ByPass for clear Commands option is disabled.</p>
SMM Security Mitigation	<p>Enable or disable additional UEFI SMM Security Mitigation protections.</p> <p>By default, the option is enabled.</p>
Data Wipe on Next Boot	
Start Data Wipe	<p>Enable or disable the data wipe on next boot.</p> <p>By default, the Start Data Wipe option is disabled.</p>
Absolute	<p>Enable or disable or permanently disable the BIOS module interface of the optional Absolute Persistence Module service from Absolute software.</p> <p>By default, the option is enabled.</p> <p>⚠ WARNING: The 'Permanently Disabled' option can only be selected once. When 'Permanently Disabled' is selected, Absolute Persistence cannot be re-enabled. No further changes to the Enable/Disable states are allowed.</p> <p>i NOTE: The Enable/Disable options will be unavailable while Computrace is in the activated state.</p>
UEFI Boot Path Security	<p>Controls whether the system will prompt the user to enter the admin password (if set) when booting to a UEFI boot path device from the F12 boot menu.</p> <p>By default, the Always Except Internal HDD option is enabled.</p>

Table 11. System setup options—Passwords menu

Passwords	
Admin Password	Set, change, or delete the administrator password.
System Password	Set, change, or delete the system password.
NVMe SSD0	Set, change, or delete the NVMe SSD0 password.
Password Configuration	
Upper Case Letter	<p>Reinforces password must have at least one upper case letter.</p> <p>By default, the option is disabled.</p>
Lower Case Letter	<p>Reinforces password must have at least one lower case letter.</p> <p>By default, the option is disabled.</p>
Digit	<p>Reinforces password must have at least one digit number.</p> <p>By default, the option is disabled.</p>
Special Character	<p>Reinforces password must have at least one special character.</p> <p>By default, the option is disabled.</p>
Minimum Characters	Set the minimum characters allowed for password.

Table 11. System setup options—Passwords menu (continued)

Passwords	
<p>Password Bypass</p> <p>Password Changes</p> <p>Enable Non-Admin Password Changes</p>	<p>When enabled, this always prompts for system and internal hard drive passwords when powered on from the off state.</p> <p>By default, the Disabled option is selected.</p> <p>Enable or disable to change system and hard drive password without the need for admin password.</p> <p>By default, the option is enabled.</p>
Admin Setup Lockout	
<p>Enable Admin Setup Lockout</p>	<p>Enables administrators control over how their users can or cannot access BIOS setup.</p> <p>By default, the option is disabled.</p>
Master Password Lockout	
<p>Enable Master Password Lockout</p>	<p>When enabled, this disables the master password support.</p> <p>By default, the option is disabled.</p>
Allow Non-Admin PSID Revert	
<p>Enable Allow Non-Admin PSID Revert</p>	<p>Controls access to the Physical Security ID (PSID) revert of NVMe hard-drives from the Dell Security Manager prompt.</p> <p>By default, the option is disabled.</p>

Table 12. System setup options—Service menu

System Management	
<p>Service Tag (required)</p> <p>Asset Tag (optional)</p> <p>BT disabled</p>	<p>Displays the Service Tag of the system.</p> <p>Create a system Asset Tag.</p> <p>By default, the option is disabled.</p>

Table 13. System setup options—Update, Recovery menu

Update, Recovery	
<p>UEFI Capsule Firmware Updates</p>	<p>Enable or disable BIOS updates through UEFI capsule update packages.</p> <p>NOTE: Disabling this option will block BIOS updates from services such as Microsoft Windows Update and Linux Vendor Firmware Service (LVFS).</p> <p>By default, the option is enabled.</p>
<p>BIOS Recovery from Hard Drive</p>	<p>Enables the user to recover from certain corrupted BIOS conditions from a recovery file on the user primary hard drive or an external USB key.</p> <p>By default, the option is enabled.</p> <p>NOTE: BIOS Recovery from Hard Drive is not available for self-encrypting drives (SED).</p>
<p>BIOS Downgrade</p> <p>Allow BIOS Downgrade</p>	<p>This field controls the flashing of the system firmware to previous revisions.</p> <p>By default, the option is enabled.</p>
<p>SupportAssist OS Recovery</p>	<p>Enable or disable the boot flow for SupportAssist OS Recovery tool in the event of certain system errors.</p> <p>By default, the option is enabled.</p>

Table 13. System setup options—Update, Recovery menu (continued)

Update, Recovery	
BIOSConnect	<p>Enable or disable cloud Service operating system recovery if the main operating system fails to boot with the number of failures equal to or greater than the value specified by the Auto operating system Recovery Threshold setup option and local Service operating system does not boot or is not installed.</p> <p>By default, the option is enabled.</p>
Dell Auto operating system Recovery Threshold	<p>Controls the automatic boot flow for SupportAssist System Resolution Console and for Dell operating system Recovery Tool.</p> <p>By default, the threshold value is set to 2.</p>

Table 14. System setup options—System Management menu

System Management	
Service Tag	Displays the Service Tag of the system.
Asset Tag	Create a system Asset Tag.
AC Behavior	
Wake on AC	<p>Enable or disable the wake on AC option.</p> <p>By default, the option is disabled.</p>
Auto on Time	<p>Enable to set the system to turn on automatically every day or on a preselected date and time. This option can be configured only if the Auto On Time is set to Everyday, Weekdays, or Selected Days.</p> <p>By default, the option is disabled.</p>

Table 15. System setup options—Keyboard menu

Keyboard	
Numlock Enable	<p>Allows you to enable or disable the Numlock function when the system boots.</p> <p>By default, the option Fn Lock Options is enabled.</p>
Fn Lock Options	By default, the Fn lock option is enabled.
Lock Mode	By default, the Lock Mode Secondary option is enabled. With this option, the F1-F2 keys scan the code for their secondary functions.

Table 16. System setup options—Pre-boot Behavior menu

Pre-boot Behavior	
Adapter Warnings	
Enable Adapter Warnings	<p>Enable or disable the warning messages during boot when the adapters with less power capacity are detected.</p> <p>By default, the option is enabled.</p>
Warning and Errors	<p>Enable or disable the action to be done when a warning or error is encountered.</p> <p>By default, the Prompt on Warnings and Errors option is enabled.</p>
USB-C Warnings	
Enable Dock Warning Messages	By default, the option is enabled.
Fastboot	<p>Allows you to configure the speed of the UEFI boot process.</p> <p>By default, the Minimal option is enabled.</p>
Extend BIOS POST Time	Set the BIOS POST load time.

Table 16. System setup options—Pre-boot Behavior menu (continued)

Pre-boot Behavior	
By default, the 0 seconds option is enabled.	

Table 17. System setup options—Virtualization menu

Virtualization	
Intel Virtualization Technology	
Enable Intel Virtualization Technology (VT)	When enabled, the system will be able to run a Virtual Machine Monitor (VMM). By default, the option is enabled.
VT for Direct I/O	
	When enabled, the system will be able to perform Virtualization Technology for Direct I/O (VT-d). By default, the option is enabled.
Intel Trusted Execution Technology (TXT)	
Enable Intel Trusted Execution Technology (TXT)	Specifies whether a measured Virtual Machine Monitor (MVMM) can use the additional hardware capabilities that are provided by Intel Trusted Execution Technology. The following must be enabled in order to enable Intel TXT. <ul style="list-style-type: none"> ● Trusted Platform Module (TPM) ● Intel Hyper-Threading ● All CPU cores (Multi-Core Support) ● Intel Virtualization Technology ● Intel VT for Direct I/O By default, the option is disabled.

Table 18. System setup options—Performance menu

Performance	
Multi Core Support	
Active Cores	Enables to change the number of CPU cores available to the operating system. By default, the All Cores option is enabled.
Intel SpeedStep	
Enable Intel SpeedStep Technology	Enables the system to dynamically adjust processor voltage and core frequency, decreasing average power consumption and heat production. By default, the option is enabled.
C-States Control	
Enable C-State Control	Enable the ability of the CPU to enter and exit low power state. When disabled, it disabled all C-states. When enabled, it enabled all C-states that the chipset or platform allows. By default, the option is enabled.
Intel Turbo Boost Technology	
Enable Intel Turbo Boost Technology	Enable or disable the Intel TurboBoost mode of the processor. By default, the option is enabled.
Intel Hyper-Threading Technology	
Enable Intel Hyper-Threading Technology	Enable or disable Hyper-Threading in the processor. By default, the option is enabled.

Table 18. System setup options—Performance menu (continued)

Performance	
Dynamic Tuning:Machine Learning	
Enable Dynamic Tuning:Machine Learning	Enables the operating system capability to enhance dynamic power tuning capabilities based on detected workloads. By default, the option is disabled.

Table 19. System setup options—System Logs menu

System Logs	
BIOS Event Log	
Clear Bios Event Log	Displays BIOS events. By default, the Keep Log option is enabled.
Thermal Event Log	
Clear Thermal Event Log	Displays Thermal events. By default, the Keep Log option is enabled.
Power Event Log	
Clear Power Event Log	Displays power events. By default, the Keep Log option is enabled.
License Information	Displays the license information of the system.

Updating the BIOS

Updating the BIOS in Windows

About this task

CAUTION: If BitLocker is not suspended before updating the BIOS, the next time you reboot the system it will not recognize the BitLocker key. You will then be prompted to enter the recovery key to progress and the system will ask for this on each reboot. If the recovery key is not known this can result in data loss or an unnecessary operating system re-install. For more information on this subject, see Knowledge Article: <https://www.dell.com/support/article/sln153694>

Steps

1. Go to www.dell.com/support.
2. Click **Product support**. In the **Search support** box, enter the Service Tag of your computer, and then click **Search**.
NOTE: If you do not have the Service Tag, use the SupportAssist feature to automatically identify your computer. You can also use the product ID or manually browse for your computer model.
3. Click **Drivers & Downloads**. Expand **Find drivers**.
4. Select the operating system installed on your computer.
5. In the **Category** drop-down list, select **BIOS**.
6. Select the latest version of BIOS, and click **Download** to download the BIOS file for your computer.
7. After the download is complete, browse the folder where you saved the BIOS update file.
8. Double-click the BIOS update file icon and follow the on-screen instructions.
 For more information, see knowledge base article [000124211](https://www.dell.com/support/article/000124211) at www.dell.com/support.

Updating the BIOS in Linux and Ubuntu

To update the system BIOS on a computer that is installed with Linux or Ubuntu, see the knowledge base article [000131486](https://www.dell.com/support/article/000131486) at www.dell.com/support.

Updating the BIOS using the USB drive in Windows

About this task

 **CAUTION:** If BitLocker is not suspended before updating the BIOS, the next time you reboot the system it will not recognize the BitLocker key. You will then be prompted to enter the recovery key to progress and the system will ask for this on each reboot. If the recovery key is not known this can result in data loss or an unnecessary operating system re-install. For more information on this subject, see Knowledge Article: <https://www.dell.com/support/article/sln153694>

Steps

1. Follow the procedure from step 1 to step 6 in [Updating the BIOS in Windows](#) to download the latest BIOS setup program file.
2. Create a bootable USB drive. For more information, see the knowledge base article [000145519](https://www.dell.com/support/article/000145519) at www.dell.com/support.
3. Copy the BIOS setup program file to the bootable USB drive.
4. Connect the bootable USB drive to the computer that needs the BIOS update.
5. Restart the computer and press **F12**.
6. Select the USB drive from the **One Time Boot Menu**.
7. Type the BIOS setup program filename and press **Enter**.
The **BIOS Update Utility** appears.
8. Follow the on-screen instructions to complete the BIOS update.

Updating the BIOS from the F12 One-Time boot menu

Update your computer BIOS using the BIOS update.exe file that is copied to a FAT32 USB drive and booting from the F12 One-Time boot menu.

About this task

 **CAUTION:** If BitLocker is not suspended before updating the BIOS, the next time you reboot the system it will not recognize the BitLocker key. You will then be prompted to enter the recovery key to progress and the system will ask for this on each reboot. If the recovery key is not known this can result in data loss or an unnecessary operating system re-install. For more information on this subject, see Knowledge Article: <https://www.dell.com/support/article/sln153694>

BIOS Update

You can run the BIOS update file from Windows using a bootable USB drive or you can also update the BIOS from the F12 One-Time boot menu on the computer.

Most of the Dell computers built after 2012 have this capability, and you can confirm by booting your computer to the F12 One-Time Boot Menu to see if BIOS FLASH UPDATE is listed as a boot option for your computer. If the option is listed, then the BIOS supports this BIOS update option.

 **NOTE:** Only computers with BIOS Flash Update option in the F12 One-Time boot menu can use this function.

Updating from the One-Time boot menu

To update your BIOS from the F12 One-Time boot menu, you need the following:

- USB drive formatted to the FAT32 file system (key does not have to be bootable)
- BIOS executable file that you downloaded from the Dell Support website and copied to the root of the USB drive
- AC power adapter that is connected to the computer
- Functional computer battery to flash the BIOS

Perform the following steps to perform the BIOS update flash process from the F12 menu:

 **CAUTION:** Do not turn off the computer during the BIOS update process. The computer may not boot if you turn off your computer.

Steps

1. From a turn off state, insert the USB drive where you copied the flash into a USB port of the computer.
2. Turn on the computer and press F12 to access the One-Time Boot Menu, select BIOS Update using the mouse or arrow keys then press Enter.
The flash BIOS menu is displayed.
3. Click **Flash from file**.
4. Select external USB device.
5. Select the file and double-click the flash target file, and then click **Submit**.
6. Click **Update BIOS**. The computer restarts to flash the BIOS.
7. The computer will restart after the BIOS update is completed.

System and setup password

Table 20. System and setup password

Password type	Description
System password	Password that you must enter to log on to your system.
Setup password	Password that you must enter to access and make changes to the BIOS settings of your computer.

You can create a system password and a setup password to secure your computer.

 **CAUTION:** The password features provide a basic level of security for the data on your computer.

 **CAUTION:** Anyone can access the data stored on your computer if it is not locked and left unattended.

 **NOTE:** System and setup password feature is disabled.

Assigning a system setup password

Prerequisites

You can assign a new **System or Admin Password** only when the status is in **Not Set**.

About this task

To enter the system setup, press F2 immediately after a power-on or reboot.

Steps

1. In the **System BIOS** or **System Setup** screen, select **Security** and press **Enter**.
The **Security** screen is displayed.
2. Select **System/Admin Password** and create a password in the **Enter the new password** field.
Use the following guidelines to assign the system password:
 - A password can have up to 32 characters.
 - The password can contain the numbers 0 through 9.
 - Only lower case letters are valid, upper case letters are not allowed.
 - Only the following special characters are allowed: space, ("), (+), (.), (-), (.), (/), (:), ([), (\), (]), (`).
3. Type the system password that you entered earlier in the **Confirm new password** field and click **OK**.
4. Press **Esc** and a message prompts you to save the changes.

5. Press **Y** to save the changes.
The computer reboots.

Deleting or changing an existing system setup password

Prerequisites

Ensure that the **Password Status** is Unlocked (in the System Setup) before attempting to delete or change the existing System and Setup password. You cannot delete or change an existing System or Setup password, if the **Password Status** is Locked.

About this task

To enter the System Setup, press **F2** immediately after a power-on or reboot.

Steps

1. In the **System BIOS** or **System Setup** screen, select **System Security** and press **Enter**.
The **System Security** screen is displayed.
2. In the **System Security** screen, verify that **Password Status** is **Unlocked**.
3. Select **System Password**, alter or delete the existing system password and press **Enter** or **Tab**.
4. Select **Setup Password**, alter or delete the existing setup password and press **Enter** or **Tab**.
 **NOTE:** If you change the System and/or Setup password, re enter the new password when prompted. If you delete the System and Setup password, confirm the deletion when prompted.
5. Press **Esc** and a message prompts you to save the changes.
6. Press **Y** to save the changes and exit from System Setup.
The computer restarts.

Clearing BIOS (System Setup) and System passwords

About this task

To clear the system or BIOS passwords, contact Dell technical support as described at www.dell.com/contactdell.

-  **NOTE:** For information on how to reset Windows or application passwords, refer to the documentation accompanying Windows or your application.

Troubleshooting

Handling swollen Lithium-ion batteries

Like most laptops, Dell laptops use lithium-ion batteries. One type of lithium-ion battery is the lithium-ion polymer battery. Lithium-ion polymer batteries have increased in popularity in recent years and have become standard in the electronics industry due to customer preferences for a slim form factor (especially with newer ultra-thin laptops) and long battery life. Inherent to lithium-ion polymer battery technology is the potential for swelling of the battery cells.

Swollen battery may impact the performance of the laptop. To prevent possible further damage to the device enclosure or internal components leading to malfunction, discontinue the use of the laptop and discharge it by disconnecting the AC adapter and letting the battery drain.

Swollen batteries should not be used and should be replaced and disposed of properly. We recommend contacting Dell product support for options to replace a swollen battery under the terms of the applicable warranty or service contract, including options for replacement by a Dell authorized service technician.

The guidelines for handling and replacing Lithium-ion batteries are as follows:

- Exercise caution when handling Lithium-ion batteries.
- Discharge the battery before removing it from the system. To discharge the battery, unplug the AC adapter from the system and operate the system only on battery power. When the system will no longer power on when the power button is pressed, the battery is fully discharged.
- Do not crush, drop, mutilate, or penetrate the battery with foreign objects.
- Do not expose the battery to high temperatures, or disassemble battery packs and cells.
- Do not apply pressure to the surface of the battery.
- Do not bend the battery.
- Do not use tools of any type to pry on or against the battery.
- If a battery gets stuck in a device as a result of swelling, do not try to free it as puncturing, bending, or crushing a battery can be dangerous.
- Do not attempt to reassemble a damaged or swollen battery into a laptop.
- Swollen batteries that are covered under warranty should be returned to Dell in an approved shipping container (provided by Dell)—this is to comply with transportation regulations. Swollen batteries that are not covered under warranty should be disposed of at an approved recycling center. Contact Dell product support at <https://www.dell.com/support> for assistance and further instructions.
- Using a non-Dell or incompatible battery may increase the risk of fire or explosion. Replace the battery only with a compatible battery purchased from Dell that is designed to work with your Dell computer. Do not use a battery from other computers with your computer. Always purchase genuine batteries from <https://www.dell.com> or otherwise directly from Dell.

Lithium-ion batteries can swell for various reasons such as age, number of charge cycles, or exposure to high heat. For more information on how to improve the performance and lifespan of the laptop battery and to minimize the possibility of occurrence of the issue, see [Dell Laptop Battery - Frequently Asked Questions](#).

Dell SupportAssist Pre-boot System Performance Check diagnostics

About this task

SupportAssist diagnostics (also known as system diagnostics) performs a complete check of your hardware. The Dell SupportAssist Pre-boot System Performance Check diagnostics is embedded with the BIOS and is launched by the BIOS internally. The embedded system diagnostics provides a set of options for particular devices or device groups allowing you to:

- Run tests automatically or in an interactive mode
- Repeat tests
- Display or save test results

- Run thorough tests to introduce additional test options to provide extra information about the failed device(s)
- View status messages that inform you if tests are completed successfully
- View error messages that inform you of problems encountered during testing

NOTE: Some tests for specific devices require user interaction. Always ensure that you are present at the computer terminal when the diagnostic tests are performed.

For more information, see <https://www.dell.com/support/kbdoc/000180971>.

Running the SupportAssist Pre-Boot System Performance Check

Steps

1. Turn on your computer.
2. As the computer boots, press the F12 key as the Dell logo appears.
3. On the boot menu screen, select the **Diagnostics** option.
4. Click the arrow at the bottom left corner.
Diagnostics front page is displayed.
5. Click the arrow in the lower-right corner to go to the page listing.
The items detected are listed.
6. To run a diagnostic test on a specific device, press Esc and click **Yes** to stop the diagnostic test.
7. Select the device from the left pane and click **Run Tests**.
8. If there are any issues, error codes are displayed.
Note the error code and validation number and contact Dell.

Built-in self-test (BIST)

M-BIST

M-BIST (Built In Self-Test) is the system board's built-in self-test diagnostics tool that improves the diagnostics accuracy of system board embedded controller (EC) failures.

NOTE: M-BIST can be manually initiated before POST (Power On Self Test).

How to run M-BIST

NOTE: M-BIST must be initiated on the system from a power-off state either connected to AC power or with battery only.

1. Press and hold both the **M** key on the keyboard and the **power button** to initiate M-BIST.
2. With both the **M** key and the **power button** held down, the battery indicator LED may exhibit two states:
 - a. OFF: No fault detected with the system board
 - b. AMBER: Indicates a problem with the system board
3. If there is a failure with the system board, the battery status LED will flash one of the following error codes for 30 seconds:

Table 21. LED error codes

Blinking Pattern		Possible Problem
Amber	White	
2	1	CPU Failure
2	8	LCD Power Rail Failure
1	1	TPM Detection Failure
2	4	Unrecoverable SPI Failure

4. If there is no failure with the system board, the LCD will cycle through the solid color screens described in the LCD-BIST section for 30 seconds and then power off.

LCD Power rail test (L-BIST)

L-BIST is an enhancement to the single LED error code diagnostics and is automatically initiated during POST. L-BIST will check the LCD power rail. If there is no power being supplied to the LCD (i.e., the L-BIST circuit fails), the battery status LED will flash either an error code [2,8] or an error code [2,7].

NOTE: If L-BIST fails, LCD-BIST cannot function as no power will be supplied to the LCD.

How to invoke L-BIST Test:

1. Press the power button to start the system.
2. If the system does not start up normally, look at the battery status LED:
 - If the battery status LED flashes an error code [2,7], the display cable may not be connected properly.
 - If the battery status LED flashes an error code [2,8], there is a failure on the LCD power rail of the system board, hence there is no power supplied to the LCD.
3. For cases, when a [2,7] error code is shown, check to see if the display cable is properly connected.
4. For cases when a [2,8] error code is shown, replace the system board.

LCD Built-in Self Test (BIST)

Dell laptops have a built-in diagnostic tool that helps you determine if the screen abnormality you are experiencing is an inherent problem with the LCD (screen) of the Dell laptop or with the video card (GPU) and PC settings.

When you notice screen abnormalities like flickering, distortion, clarity issues, fuzzy or blurry image, horizontal or vertical lines, color fade etc., it is always a good practice to isolate the LCD (screen) by running the Built-In Self Test (BIST).

How to invoke LCD BIST Test

1. Power off the Dell laptop.
2. Disconnect any peripherals that are connected to the laptop. Connect only the AC adapter (charger) to the laptop.
3. Ensure that the LCD (screen) is clean (no dust particles on the surface of the screen).
4. Press and hold **D** key and **Power on** the laptop to enter LCD built-in self test (BIST) mode. Continue to hold the D key, until the system boots up.
5. The screen will display solid colors and change colors on the entire screen to white, black, red, green, and blue twice.
6. Then it will display the colors white, black and red.
7. Carefully inspect the screen for abnormalities (any lines, fuzzy color or distortion on the screen).
8. At the end of the last solid color (red), the system will shut down.

NOTE: Dell SupportAssist Pre-boot diagnostics upon launch, initiates an LCD BIST first, expecting a user intervention confirm functionality of the LCD.

System-diagnostic lights

Table 22. System-diagnostic lights

Blinking pattern		Problem description	Suggested resolution
Amber	White		
1	1	TPM detection failure	Replace the system board.
1	2	Unrecoverable SPI Flash Failure	Replace the system board.
1	5	EC unable to program i-Fuse	Replace the system board.

Table 22. System-diagnostic lights (continued)

Blinking pattern		Problem description	Suggested resolution
Amber	White		
1	6	Generic catch-all for ungraceful EC code flow errors	Disconnect all power source (AC, battery, coin cell) and drain flea power by pressing and holding down power button for 3~5 seconds.
2	1	CPU failure	<ul style="list-style-type: none"> Run the Dell Support Assist/Dell Diagnostics tool. If problem persists, replace the system board.
2	2	System board failure (included BIOS corruption or ROM error)	<ul style="list-style-type: none"> Flash latest BIOS version If problem persists, replace the system board.
2	3	No memory/RAM detected	<ul style="list-style-type: none"> Confirm that the memory module is installed properly. If problem persists, replace the memory module.
2	4	Memory/RAM failure	<ul style="list-style-type: none"> Reset and swap memory modules among the slots. If problem persists, replace the memory module.
2	5	Invalid memory installed	<ul style="list-style-type: none"> Reset and swap memory modules among the slots. If problem persists, replace the memory module.
2	6	System board/Chipset Error	Replace the system board.
2	7	LCD failure (SBIOS message)	Replace the LCD module.
2	8	LCD failure (EC detection of power rail failure)	Replace the system board.
3	1	CMOS battery failure	<ul style="list-style-type: none"> Reset the main battery connection. If problem persists, replace the main battery.
3	2	PCI or Video card/chip failure	Replace the system board.
3	3	BIOS Recovery image not found	<ul style="list-style-type: none"> Flash latest BIOS version If problem persists, replace the system board.
3	4	BIOS Recovery image found but invalid	<ul style="list-style-type: none"> Flash latest BIOS version If problem persists, replace the system board.
3	5	Power rail failure	Replace the system board.
3	6	Flash corruption detected by SBIOS.	<ul style="list-style-type: none"> Press power button for over 25 seconds to do

Table 22. System-diagnostic lights (continued)

Blinking pattern		Problem description	Suggested resolution
Amber	White		
			RTC reset. If problem persists, replace the system board. <ul style="list-style-type: none"> • Disconnect all power source (AC, battery, coin cell) and drain flea power by pressing and holding down power button 3~5 seconds to ensure all power are drained. • Run "BIOS recovery from USB", and the instructions are in the website Dell support. • If problem persists, replace the system board.
3	7	Timeout waiting on ME to reply to HECI message.	Replace the system board.

NOTE: Blinking 3-3-3 LEDs on Lock LED (Caps-Lock or Num-Lock), Power button LED (without Fingerprint reader), and Diagnostic LED indicates failure to provide input during LCD panel test on Dell SupportAssist Pre-boot System Performance Check diagnostics.

Recovering the operating system

When your computer is unable to boot to the operating system even after repeated attempts, it automatically starts Dell SupportAssist OS Recovery.

Dell SupportAssist OS Recovery is a standalone tool that is preinstalled in all Dell computers installed with Windows operating system. It consists of tools to diagnose and troubleshoot issues that may occur before your computer boots to the operating system. It enables you to diagnose hardware issues, repair your computer, back up your files, or restore your computer to its factory state.

You can also download it from the Dell Support website to troubleshoot and fix your computer when it fails to boot into their primary operating system due to software or hardware failures.

For more information about the Dell SupportAssist OS Recovery, see *Dell SupportAssist OS Recovery User's Guide* at www.dell.com/serviceabilitytools. Click **SupportAssist** and then, click **SupportAssist OS Recovery**.

Real-Time Clock (RTC Reset)

The Real Time Clock (RTC) reset function allows you or the service technician to recover Dell Inspiron, systems from No POST/No Power/No Boot situations. The legacy jumper enabled RTC reset has been retired on these models.

Start the RTC reset with the system powered off and connected to AC power. Press and hold the power button for thirty (30) seconds. The system RTC Reset occurs after you release the power button.

Backup media and recovery options

It is recommended to create a recovery drive to troubleshoot and fix problems that may occur with Windows. Dell proposes multiple options for recovering Windows operating system on your Dell PC. For more information, see [Dell Windows Backup Media and Recovery Options](#).

WiFi power cycle

About this task

If your computer is unable to access the internet due to WiFi connectivity issues a WiFi power cycle procedure may be performed. The following procedure provides the instructions on how to conduct a WiFi power cycle:

 **NOTE:** Some ISPs (Internet Service Providers) provide a modem/router combo device.

Steps

1. Turn off your computer.
2. Turn off the modem.
3. Turn off the wireless router.
4. Wait for 30 seconds.
5. Turn on the wireless router.
6. Turn on the modem.
7. Turn on your computer.

Drain residual flea power (perform hard reset)

About this task

Flea power is the residual static electricity that remains in the computer even after it has been powered off and the battery is removed.

For your safety, and to protect the sensitive electronic components in your computer, you are requested to drain residual flea power before removing or replacing any components in your computer.

Draining residual flea power, also known as a performing a "hard reset", is also a common troubleshooting step if your computer does not power on or boot into the operating system.

To drain residual flea power (perform a hard reset)

Steps

1. Turn off your computer.
2. Disconnect the power adapter from your computer.
3. Remove the base cover.
4. Remove the battery.
5. Press and hold the power button for 20 seconds to drain the flea power.
6. Install the battery.
7. Install the base cover.
8. Connect the power adapter to your computer.
9. Turn on your computer.



 **NOTE:** For more information about performing a hard reset, see the knowledge base article [000130881](https://www.dell.com/support) at www.dell.com/support.

Getting help and contacting Dell

Self-help resources

You can get information and help on Dell products and services using these self-help resources:

Table 23. Self-help resources

Self-help resources	Resource location
Information about Dell products and services	www.dell.com
My Dell app	
Tips	
Contact Support	In Windows search, type <code>Contact Support</code> , and press Enter.
Online help for operating system	www.dell.com/support/windows
Access top solutions, diagnostics, drivers and downloads, and learn more about your computer through videos, manuals and documents.	Your Dell computer is uniquely identified by a Service Tag or Express Service Code. To view relevant support resources for your Dell computer, enter the Service Tag or Express Service Code at www.dell.com/support . For more information on how to find the Service Tag for your computer, see Locate the Service Tag on your computer .
Dell knowledge base articles for a variety of computer concerns	<ol style="list-style-type: none"> 1. Go to www.dell.com/support. 2. On the menu bar at the top of the Support page, select Support > Knowledge Base. 3. In the Search field on the Knowledge Base page, type the keyword, topic, or model number, and then click or tap the search icon to view the related articles.

Contacting Dell

To contact Dell for sales, technical support, or customer service issues, see www.dell.com/contactdell.

 **NOTE:** Availability varies by country/region and product, and some services may not be available in your country/region.

 **NOTE:** If you do not have an active Internet connection, you can find contact information about your purchase invoice, packing slip, bill, or Dell product catalog.