

THIS COPY IS PROVIDED ON A RESTRICTED BASIS AND IS NOT TO BE USED IN ANY WAY DETRIMENTAL TO THE INTERESTS OF PANDUIT CORP.

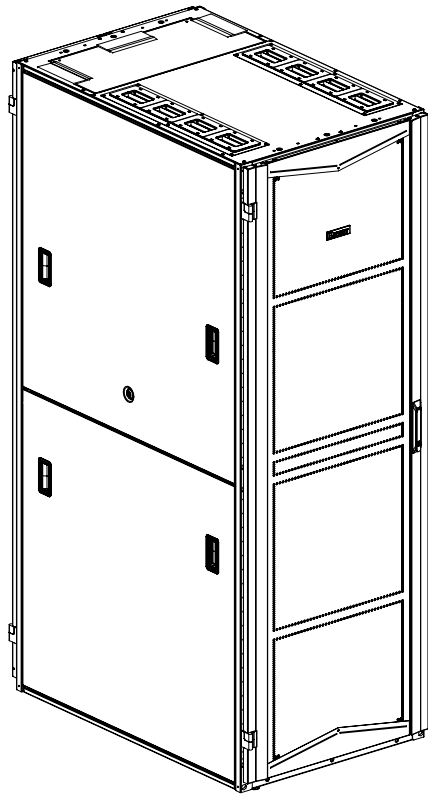

**FLEXFUSION™ CABINET
WITH BEZELS AND COVERS**



**FLEXFUSION™ CABINET
WITH BRUSHES**

700mm CABINET SHOWN

NOTES:

1. VISIT OUR ON-LINE CATALOG AT WWW.PANDUIT.COM FOR A LIST OF CURRENT PARTS APPLICABLE FOR USE WITH THIS PRODUCT.
2. FACTORY SETTINGS:
SERVER CONFIGURATION - ALL WIDTHS AND DEPTHS:
FRONT FACE OF FRONT E-RAILS ARE: 64.0mm ±2.0mm / [2.52in ±0.08in] FROM FRONT FACE OF FRAME.
FRONT FACE OF REAR E-RAILS ARE: 742mm ±2.0mm / [29.2in ±0.08in] FROM FRONT FACE OF FRONT E-RAILS.
NETWORK CONFIGURATION - ALL DEPTHS:
600mm WIDE:
FRONT FACE OF FRONT E-RAILS ARE: 234.0mm ±2.0mm / [9.2in ±0.08in] FROM FRONT FACE OF FRAME.
FRONT FACE OF REAR E-RAILS ARE: 572mm ±2.0mm / [22.5in ±0.08in] FROM FRONT FACE OF FRONT E-RAILS.
700mm & 800mm WIDE:
FRONT FACE OF FRONT E-RAILS ARE: 177.0mm ±2.0mm / [7.0in ±0.08in] FROM FRONT FACE OF FRAME.
FRONT FACE OF REAR E-RAILS ARE: 629mm ±2.0mm / [24.8in ±0.08in] FROM FRONT FACE OF FRONT E-RAILS.
3. FOR REAR E-RAIL ADJUSTMENTS
SEE TABLE ON SHEET 8
4. CAN BE USED WITH ANY 19" EIA STANDARD COMPONENT IN ADDITION TO ALL PANDUIT HORIZONTAL CABLE MANAGEMENT AND PATCH PANEL PRODUCTS
5. EIA UNIVERSAL STANDARD HOLE PROGRESSION ON EQUIPMENT RAILS
15.88mm, 15.88mm, 12.70mm, 15.88mm, 15.88mm, 12.7mm...ETC.
6. RACK UNIT SPACING NUMERALS ARE CLEARLY PRINTED ON EQUIPMENT MOUNTING RAILS
7. FRONT TO BACK BEAMS ARE NUMBERED AND INDEXED FOR E-RAIL LOCATIONS
8. PARTS SUPPLIED:
-FRAME
-E-RAILS
-TOP CAP
-LEVELING LEGS
9. FULLY BONDED STRUCTURE WHEN ASSEMBLED PER INSTRUCTIONS
10. SINGLE POINT GROUND LOCATIONS AT TOP AND BOTTOM, BOTH FRONT AND BACK OF CABINET
11. STATIC LOAD RATING: 1588 Kg (3500 lbs)
12. ROLLING LOAD RATING: 1134 Kg (2500 lbs)
13. PRIMARY DIMENSIONS ARE IN MILLIMETERS

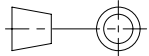
TITLE		FLEXFUSION™ CABINET FAMILY	
		CUSTOMER DRAWING	
ITEM REVISION NAME		00460NXB/03	
DATASET FILE NAME		00460NXB_DC/03A	
		PANDUIT	
		MATERIAL: N/A	
		DRAWING NUMBER: 00460NXB-DC	
 THIRD ANGLE PROJECTION			
DRAWN BY	DATE	CHK	SCALE
LEE	1/5/2021	SSP	NONE
SHT 1 OF 12		A	

REV	DATE	BY	CHK	APR	DESCRIPTION	ECN
03A	11/15/22	MEX-JAGC	MCIS	ELE	UPDATED ALL WIDTHS	V09002FD/05
02A	8/4/22	MEX-JAGC	BRAP	ELE	REPLACED 51RU VALUES W/ 52RU, UPDATED NOTE #2	V09002FD/04
01B	9/13/21	MES	BRAP	ELE	UPDATED DIMENSIONS	V09002FD/03
01A	7/27/2021	MES	BRAP	ELE	ADDED WEIGHTS	V09002FD/02
00A	1/5/2021	LEE	SSP	ELE	DRAWING RELEASE	V09002FD/00

D10100DA/16

THIS COPY IS PROVIDED ON A RESTRICTED BASIS AND IS NOT TO BE USED IN ANY WAY DETRIMENTAL TO THE INTERESTS OF PANDUIT CORP.

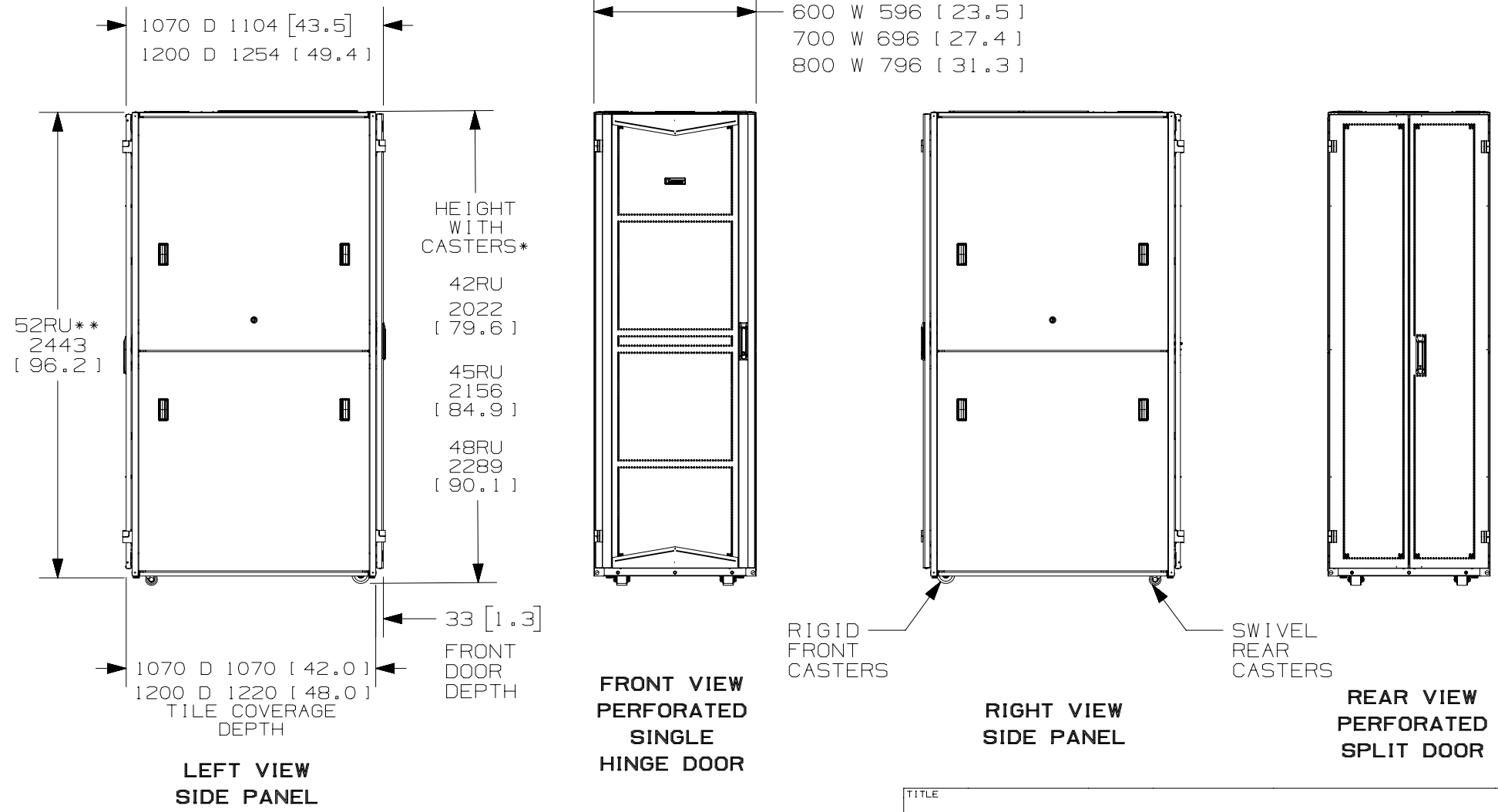

* HEIGHT WITHOUT CASTERS IS 24mm [0.94] LESS
 ** CASTERS ARE NOT AVAILABLE ON 52RU CABINETS

TITLE		FLEXFUSION™ CABINET FAMILY	
CUSTOMER DRAWING			
ITEM REVISION NAME	00460NXB/03	PANDUIT	
DATASET FILE NAME	00460NXB_DC/03A		
MATERIAL:		N/A	
DRAWING NUMBER:		00460NXB-DC	
THIRD ANGLE PROJECTION			
DRAWN BY	DATE	CHK	SCALE
LEE	1/5/2021	SSP	NONE
REV	DATE	BY	CHK
DESCRIPTION		ECN	
SHT 2 OF 12		A	

D110100DA/16

THIS COPY IS PROVIDED ON A RESTRICTED BASIS AND IS NOT TO BE USED IN ANY WAY DETRIMENTAL TO THE INTERESTS OF PANDUIT CORP.

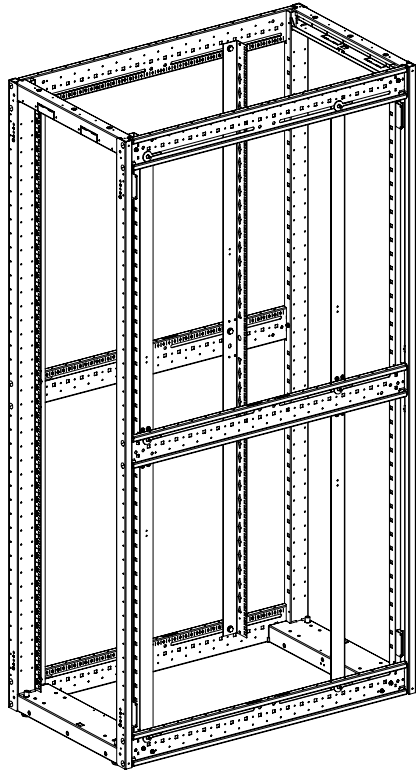

VIEW BN
600mm E-RAIL ARRANGEMENT
NO PASS THRU OPENINGS

PASS THRU COVERS

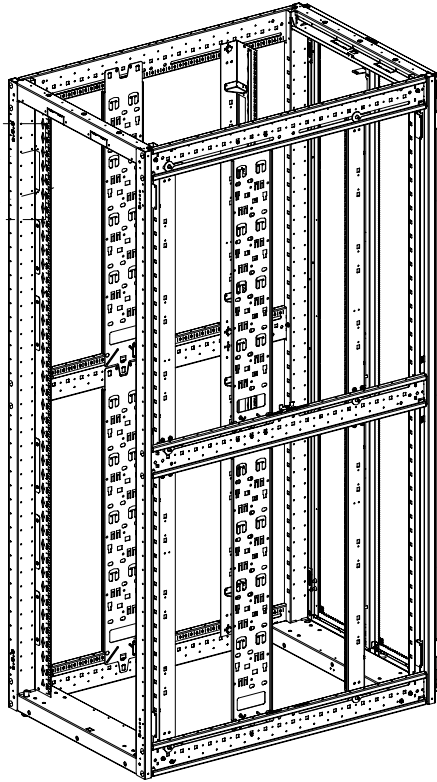

PASS THRU COVERS

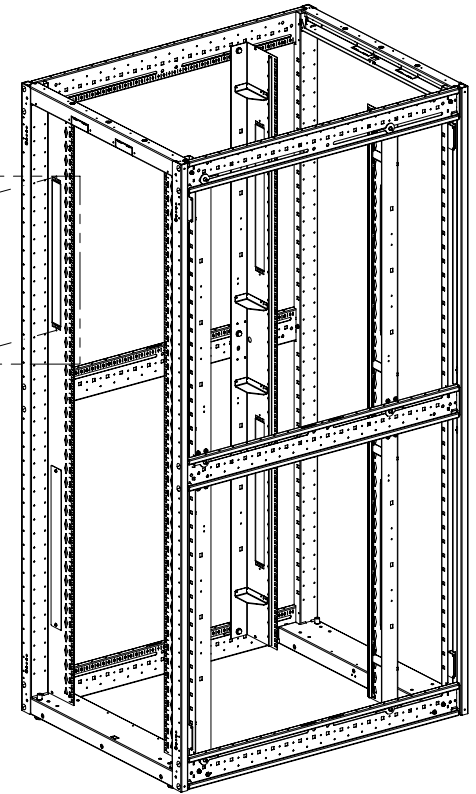

VIEW BM
800mm E-RAIL ARRANGEMENT
4 PASS THRU OPENINGS
FOR ALL RU SIZED CABINETS
19" X 1RU

NOTE:
*OPENINGS WILL FIT
CVPTB1X4 - SOLD SEPARATELY
*PASS THRU OPENING PARTIALLY
BLOCKED WHEN E-RAILS ARE
IN COMPLETELY FORWARD
POSITION

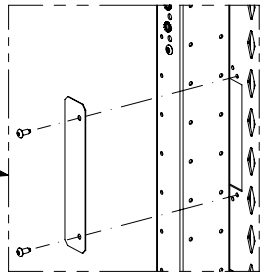

700mm E-RAIL ARRANGEMENT

PASS THRU OPENINGS FOR
42RU - 12 PASS THRU OPENINGS
45RU - 12 PASS THRU OPENINGS
48RU - 16 PASS THRU OPENINGS
52RU - 16 PASS THRU OPENINGS
122mm X 34mm
(4.8) X (1.3) VIEW BL

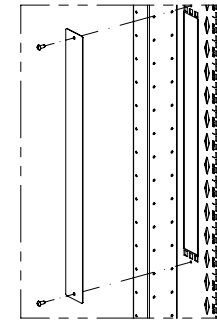

FLEXFUSION™ CABINET FAMILY

CUSTOMER DRAWING

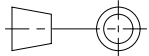
TITLE		FLEXFUSION™ CABINET FAMILY	
ITEM REVISION NAME		00460NXB/03	
DATASET FILE NAME		00460NXB_DC/03A	
MATERIAL:		N/A	
DRAWING NUMBER:		00460NXB-DC	
THIRD ANGLE PROJECTION			
DRAWN BY	DATE	CHK	SCALE
LEE	1/5/2021	SSP	NONE
SHT 3 OF 12		A	

REV	DATE	BY	CHK	APR	DESCRIPTION	ECN
03A	11/15/22	MEX-JAGC	MCIS	ELE	SEE SHEET 1 FOR REVISIONS	V09002FD/05
02A	8/4/22	MEX-JAGC	BRAP	ELE	SEE SHEET 1 FOR REVISIONS	V09002FD/04
01B	9/13/2021	MES	BRAP	ELE	SEE SHEET ONE OF 12 FOR REVISIONS	V09002FD/03
01A	7/27/2021	MES	BRAP	ELE	SEE SHEET ONE OF 12 FOR REVISIONS	V09002FD/02
00A	1/5/2021	LEE	SSP	ELE	DRAWING RELEASE	V09002FD/00

D110100DA/16

THIS COPY IS PROVIDED ON A RESTRICTED BASIS AND IS NOT TO BE USED IN ANY WAY DETRIMENTAL TO THE INTERESTS OF PANDUIT CORP.

**FRONT DOOR, REAR DOOR,
AND SIDE PANELS NOT SHOWN**

600mm 118 [4.6]
700mm 168 [6.6]
800mm 218 [8.6]

2X 180 [7.1]

TOP CAP HATCH
DOOR FOR CABLES

SEE SHEET 8 FOR
OPENING SIZE

REAR

1070 993 [39]
1200 1143 [45]

SEE SHEET 9 FOR
BEZELS AND COVERS
COMPATABILITY TABLE

FRONT

(6) LOCATIONS FOR 1070mm
(6) LOCATIONS FOR 1200mm
TAPPED FOR M10 THREADED ROD

TOP VIEW

RACK UNITS ARE
NUMBERED AND
INDEXED FOR
IDENTIFICATION

VERTICAL CABLE
MANAGEMENT FINGERS
WITH BEND RADIUS
CONTROL CAN BE ASSEMBLED
TO FRONT OR REAR E-RAILS
BY CUSTOMER

(2) ADJUSTABLE REAR
EQUIPMENT RAILS

SEE SHEET 8 FOR
DEFAULT SETTINGS
AND ADJUSTABILITY
RANGE TABLE

REAR

(2) ADJUSTABLE FRONT
EQUIPMENT RAILS

SEE SHEET 8 FOR
DEFAULT SETTINGS
AND ADJUSTABILITY
RANGE TABLE

FRONT

**TOP CAP WITH BEZEL & COVERS OPTION SHOWN
BRUSH OPTION ALSO AVAILABLE**

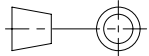
TITLE		FLEXFUSION™ CABINET FAMILY	
ITEM REVISION NAME		CUSTOMER DRAWING	
00460NXB/03		PANDUIT	
DATASET FILE NAME			
00460NXB_DC/03A		MATERIAL:	
		N/A	
		DRAWING NUMBER:	
		00460NXB-DC	
DRAWN BY		THIRD ANGLE PROJECTION	
LEE			
DATE		SCALE	
1/5/2021		NONE	
CHK		SIZE	
SSP		A	
REV		SHT 4 OF 12	

REV	DATE	BY	CHK	APR	DESCRIPTION	ECN
03A	11/15/22	MEX-JAGC	MCIS	ELE	SEE SHEET 1 FOR REVISIONS	V09002FD/05
02A	8/4/22	MEX-JAGC	BRAP	ELE	SEE SHEET 1 FOR REVISIONS	V09002FD/04
01B	9/13/2021	MES	BRAP	ELE	SEE SHEET ONE OF 12 FOR REVISIONS	V09002FD/03
01A	7/27/2021	MES	BRAP	ELE	SEE SHEET ONE OF 12 FOR REVISIONS	V09002FD/02
00A	1/5/2021	LEE	SSP	ELE	DRAWING RELEASE	V09002FD/00

D10100DA/16

THIS COPY IS PROVIDED ON A RESTRICTED BASIS AND IS NOT TO BE USED IN ANY WAY DETRIMENTAL TO THE INTERESTS OF PANDUIT CORP.

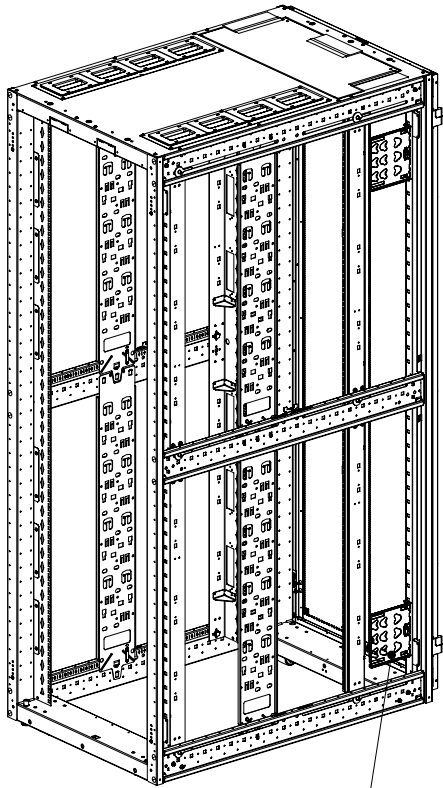

FRONT

(2) STANDARD PDU BRACKETS
CAN BE INSTALLED ON LEFT, RIGHT OR BOTH SIDES

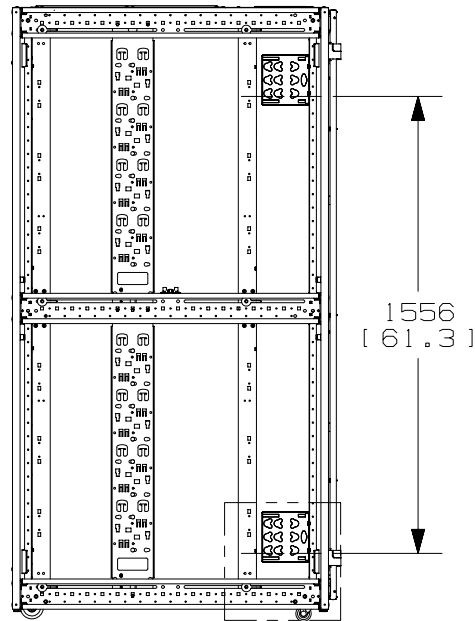

RIGHT SIDE VIEW

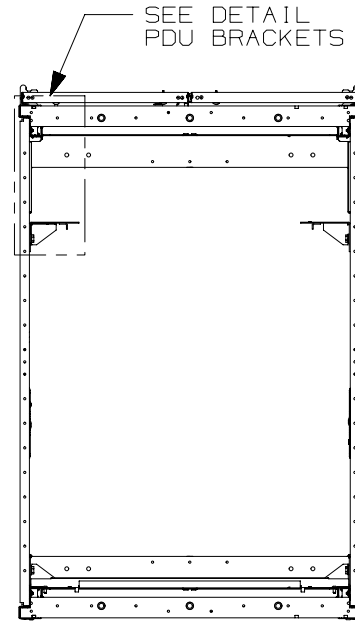

TOP VIEW

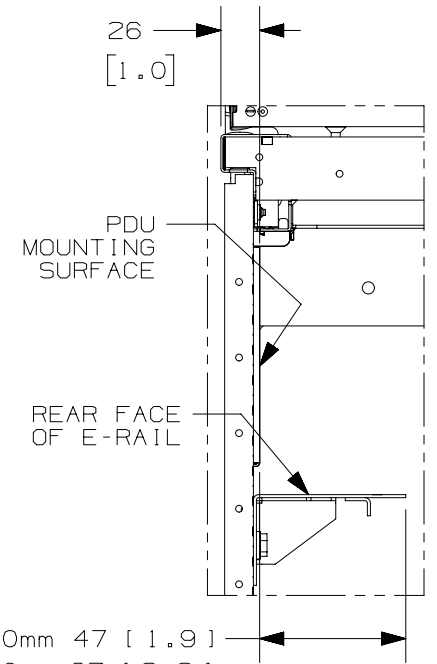

DETAIL

PDU BRACKETS

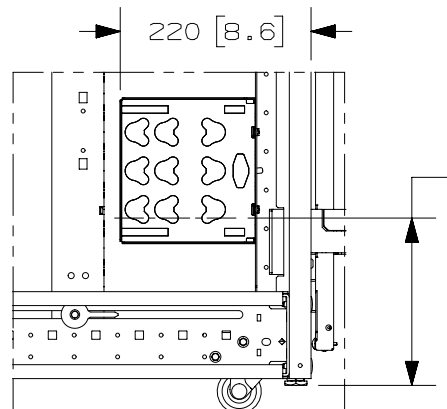

PDU BRACKET DETAIL

- 42RU - 185 [7.3]
- 45RU - 318 [12.5]
- 48RU - 452 [17.8]
- 52RU - 630 [24.8]

TITLE		FLEXFUSION™ CABINET FAMILY	
		CUSTOMER DRAWING	
ITEM REVISION NAME		00460NXB/03	
DATASET FILE NAME		00460NXB_DC/03A	
		MATERIAL: N/A	
		DRAWING NUMBER: 00460NXB-DC	
		THIRD ANGLE PROJECTION	
DRAWN BY	DATE	CHK	SCALE
LEE	1/5/2021	SSP	NONE
REV		DATE	
00A		1/5/2021	
BY		CHK	
LEE		SSP	
APR		DESCRIPTION	
		SHT 5 OF 12	
ECN		SIZE	
		A	

03A	11/15/22	MEX-JAGC	MCIS	ELE	SEE SHEET 1 FOR REVISIONS	V09002FD/05
02A	8/4/22	MEX-JAGC	BRAP	ELE	SEE SHEET 1 FOR REVISIONS	V09002FD/04
01B	9/13/2021	MES	BRAP	ELE	SEE SHEET ONE OF 12 FOR REVISIONS	V09002FD/03
01A	7/27/2021	MES	BRAP	ELE	SEE SHEET ONE OF 12 FOR REVISIONS	V09002FD/02
00A	1/5/2021	LEE	SSP	ELE	DRAWING RELEASE	V09002FD/00

D110100DA/16

THIS COPY IS PROVIDED ON A RESTRICTED BASIS AND IS NOT TO BE USED IN ANY WAY DETRIMENTAL TO THE INTERESTS OF PANDUIT CORP.

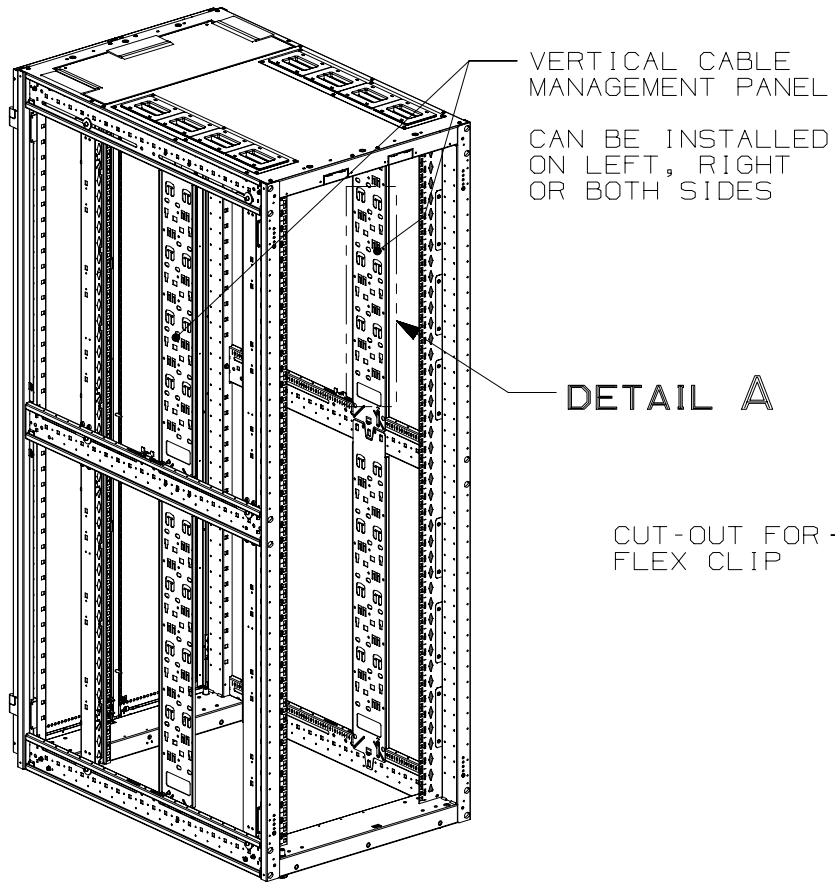

VERTICAL CABLE MANAGEMENT PANEL
CAN BE INSTALLED ON LEFT, RIGHT OR BOTH SIDES

DETAIL A

CUT-OUT FOR FLEX CLIP

SLOT FOR L-RING

CUT-OUT FOR HOOK & LOOP

SLOT FOR D-RING

DETAIL A

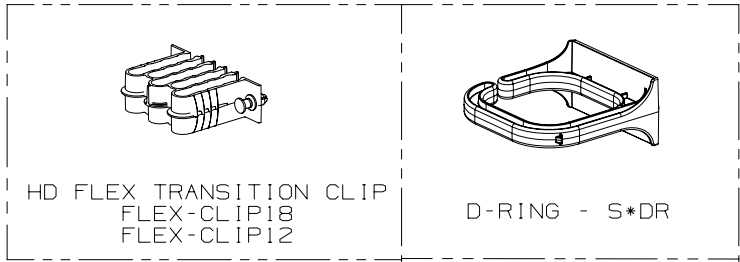

HD FLEX TRANSITION CLIP
FLEX-CLIP18
FLEX-CLIP12

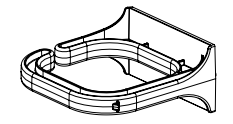

D-RING - S*DR

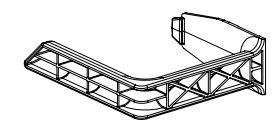

L-RING S*LR

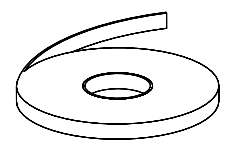

HOOK & LOOP
HLS-75R0

OPTIONAL-NOT INCLUDED

FRONT

VERTICAL CABLE MANAGER PANEL OPTIONS

REAR

REV	DATE	BY	CHK	APR	DESCRIPTION	ECN
03A	11/15/22	MEX-JAGC	MCIS	ELE	SEE SHEET 1 FOR REVISIONS	V09002FD/05
02A	8/4/22	MEX-JAGC	BRAP	ELE	SEE SHEET 1 FOR REVISIONS	V09002FD/04
01B	9/13/2021	MES	BRAP	ELE	SEE SHEET ONE OF 12 FOR REVISIONS	V09002FD/03
01A	7/27/2021	MES	BRAP	ELE	SEE SHEET ONE OF 12 FOR REVISIONS	V09002FD/02
00A	1/5/2021	LEE	SSP	ELE	DRAWING RELEASE	V09002FD/00

TITLE							FLEXFUSION™ CABINET FAMILY		
							CUSTOMER DRAWING		
ITEM REVISION NAME							00460NXB/03		PANDUIT
DATASET FILE NAME							00460NXB_DC/03A		
							MATERIAL:		N/A
							DRAWING NUMBER:		00460NXB-DC
DRAWN BY		DATE		CHK		SCALE		SIZE	
LEE		1/5/2021		SSP		NONE		SHT 6 OF 12	

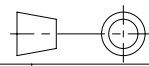

THIRD ANGLE PROJECTION

D101000DA/16

THIS COPY IS PROVIDED ON A RESTRICTED BASIS AND IS NOT TO BE USED IN ANY WAY DETRIMENTAL TO THE INTERESTS OF PANDUIT CORP.

DESCRIPTION	DIM "A"	DIM "B"	DIM "C"	DIM "D"	DIM "E"	DIM "F"
	LEVELING LEGS		FLOOR MOUNT		FLOOR OPENING	
FLEX FUSION™ 600mm WIDE X 1070mm DEEP	462 (18.2)	1010 (39.8)	390 (15.4)	744 (29.3)	792 (31.2)	553 (21.2)
FLEX FUSION™ 600mm WIDE X 1200mm DEEP	462 (18.2)	1160 (45.7)	390 (15.4)	894 (35.2)	942 (37.1)	553 (21.2)
FLEX FUSION™ 700mm WIDE X 1070mm DEEP	562 (22.1)	1010 (39.8)	490 (19.3)	744 (29.3)	792 (31.2)	653 (25.7)
FLEX FUSION™ 700mm WIDE X 1200mm DEEP	562 (22.1)	1160 (45.7)	490 (19.3)	894 (35.2)	942 (37.1)	653 (25.7)
FLEX FUSION™ 800mm WIDE X 1070mm DEEP	662 (26.1)	1010 (39.8)	590 (23.2)	744 (29.3)	792 (31.2)	753 (29.7)
FLEX FUSION™ 800mm WIDE X 1200mm DEEP	662 (26.1)	1160 (45.7)	590 (23.2)	894 (35.2)	942 (37.1)	753 (29.7)

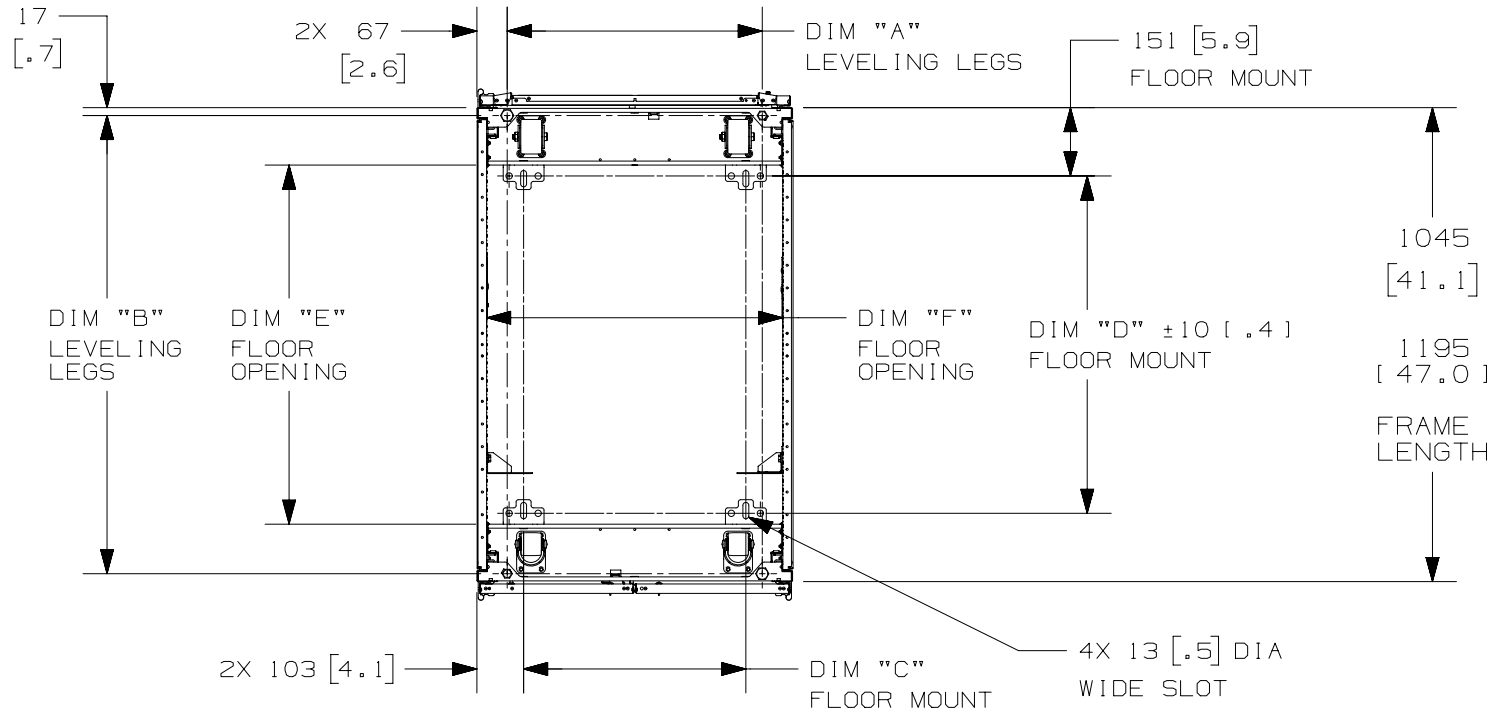

FLOOR MOUNTING HOLE LOCATIONS - SOME PARTS REMOVED FOR CLARITY

REV	DATE	BY	CHK	APR	DESCRIPTION	ECN
03A	11/15/22	MEX-JAGC	MCIS	ELE	SEE SHEET 1 FOR REVISIONS	V09002FD/05
02A	8/4/22	MEX-JAGC	BRAP	ELE	SEE SHEET 1 FOR REVISIONS	V09002FD/04
01B	9/13/2021	MES	BRAP	ELE	SEE SHEET ONE OF 12 FOR REVISIONS	V09002FD/03
01A	7/27/2021	MES	BRAP	ELE	SEE SHEET ONE OF 12 FOR REVISIONS	V09002FD/02
00A	1/5/21	LEE	SSP	ELE	DRAWING RELEASE	V09002FD/00

TITLE		FLEXFUSION™ CABINET FAMILY	
CUSTOMER DRAWING			
ITEM REVISION NAME		00460NXB/03	
DATASET FILE NAME		00460NXB_DC/03A	
MATERIAL:		N/A	
DRAWING NUMBER:		00460NXB-DC	
THIRD ANGLE PROJECTION			
DRAWN BY	DATE	CHK	SCALE
LEE	1/5/2021	SSP	NONE
SHT 7 OF 12		A	

D10100DA/16

2

1

THIS COPY IS PROVIDED ON A RESTRICTED BASIS AND IS NOT TO BE USED IN ANY WAY DETRIMENTAL TO THE INTERESTS OF PANDUIT CORP.

FRONT AND REAR E-RAIL POSITION RANGE

WIDTH	DEPTH	FRONT OF FRAME TO FRONT RAIL	FRONT TO REAR RAIL SPAN
600	1070	64mm (2.5")	154mm TO 915mm / (6.1" TO 36.0")
600	1200	64mm (2.5")	154mm TO 1065mm / (6.1" TO 42.0")
700	1070	64mm (2.5")	166mm TO 915mm / (6.5" TO 36.0")
700	1200	64mm (2.5")	166mm TO 1065mm / (6.5" TO 42.0")
800	1070	64mm (2.5")	166mm TO 915mm / (6.5" TO 36.0")
800	1200	64mm (2.5")	166mm TO 1065mm / (6.5" TO 42.0")

NOTE: MAXIMUM E-RAIL SPAN ONLY POSSIBLE IF NO VERTICAL CABLE MANAGEMENT FINGERS OR PDU BRACKETS ARE INSTALLED

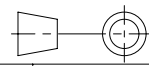
REV	DATE	BY	CHK	APR	DESCRIPTION	ECN	TITLE FLEXFUSION™ CABINET FAMILY CUSTOMER DRAWING								
03A	11/15/22	MEX-JAGC	MCIS	ELE	SEE SHEET 1 FOR REVISIONS	V09002FD/05	ITEM REVISION NAME 00460NXB/03								
02A	8/4/22	MEX-JAGC	BRAP	ELE	SEE SHEET 1 FOR REVISIONS	V09002FD/04	DATASET FILE NAME 00460NXB_DC/03A								
01B	9/13/2021	MES	BRAP	ELE	SEE SHEET ONE OF 12 FOR REVISIONS	V09002FD/03	THIRD ANGLE PROJECTION 				MATERIAL: N/A				
01A	7/27/2021	MES	BRAP	ELE	SEE SHEET ONE OF 12 FOR REVISIONS	V09002FD/02					DRAWING NUMBER: 00460NXB-DC				
00A	1/5/2021	LEE	SSP	ELE	DRAWING RELEASE	V09002FD/00	DRAWN BY LEE				DATE 1/5/2021	CHK SSP	SCALE NONE	SHT 8 OF 12	SIZE A

2

1

D110100DA/16

THIS COPY IS PROVIDED ON A RESTRICTED BASIS AND IS NOT TO BE USED IN ANY WAY DETRIMENTAL TO THE INTERESTS OF PANDUIT CORP.

TOP CAP BEZELS AND COVERS COMPATABILITY - 600, 700 & 800

DEPTH	# OF CABLE OPENINGS	SIZE OF CABLE OPENING	COMPATIBLE WITH COOL BOOT-SOLD SEPARATELY
1070	8	83mm [3.3] X 120mm [4.7]	CTGN3X5
1200	10	83mm [3.3] X 120mm [4.7]	CTGN3X5

TOP CAP BRUSH COMPATABILITY - 600, 700 & 800

DEPTH	# OF CABLE OPENINGS	SIZE OF CABLE OPENING	REPLACEMENT BRUSH KIT
1070	2	87mm [3.4] X 600mm [23.6]	XG-TCBS1B or XG-TCBS1W
1200	2	87mm [3.4] X 750mm [29.5]	XG-TCBS2B or XG-TCBS2W

TOP CAP HATCH BRUSH OPENING - 600, 700 & 800

DEPTH	# OF HATCH BRUSH OPENINGS	HATCH BRUSH OPENING
1070 OR 1200	3	(1) 170 [6.7] X 59 [2.3] (2) 169 [6.7] X 56 [2.2]

TOP CAP HATCH OPENING - 1070 & 1200 DEPTH

WIDTH	REAR SIDE HATCH OPENING
600	284mm X 548mm (11.2 X 23.0)
700	284mm X 648mm (11.2 X 25.5)
800	284mm X 748mm (11.2 X 29.5)

REV	DATE	BY	CHK	APR	DESCRIPTION	ECN
03A	11/15/22	MEX-JAGC	MCIS	ELE	SEE SHEET 1 FOR REVISIONS	V09002FD/05
02A	8/4/22	MEX-JAGC	BRAP	ELE	SEE SHEET 1 FOR REVISIONS	V09002FD/04
01B	9/13/2021	MES	BRAP	ELE	SEE SHEET ONE OF 12 FOR REVISIONS	V09002FD/03
01A	7/27/2021	MES	BRAP	ELE	SEE SHEET ONE OF 12 FOR REVISIONS	V09002FD/02
00A	1/5/2021	LEE	SSP	ELE	DRAWING RELEASE	V09002FD/00

TITLE		FLEXFUSION™ CABINET FAMILY	
		CUSTOMER DRAWING	
ITEM REVISION NAME		00460NXB/03	
DATASET FILE NAME		00460NXB_DC/03A	
		PANDUIT	
		MATERIAL:	
		N/A	
		DRAWING NUMBER:	
		00460NXB-DC	
DRAWN BY	DATE	CHK	SCALE
LEE	1/5/2021	SSP	NONE
		SHT 9 OF 12	
		A	

D10100DA/16

THIS COPY IS PROVIDED ON A RESTRICTED BASIS AND IS NOT TO BE USED IN ANY WAY DETRIMENTAL TO THE INTERESTS OF PANDUIT CORP.

PART NO.	DESCRIPTION	CABINET WEIGHT FULLY UNPACKAGED	CABINET WEIGHT SHIPPING WEIGHT
XG64212*	FLEXFUSION™ CABINET 600mm X 42RU X 1070mm DEEP W/SIDE PANELS	125 Kg/EACH 276 LBS/EACH	145 Kg/EACH 320 LBS/EACH
XG64219*	FLEXFUSION™ CABINET 600mm X 42RU X 1070mm DEEP W/O SIDE PANELS	89 Kg/EACH 196 LBS/EACH	109 Kg/EACH 240 LBS/EACH
XG64512*	FLEXFUSION™ CABINET 600mm X 45RU X 1070mm DEEP W/SIDE PANELS	132 Kg/EACH 292 LBS/EACH	152 Kg/EACH 336 LBS/EACH
XG64519*	FLEXFUSION™ CABINET 600mm X 45RU X 1070mm DEEP W/O SIDE PANELS	93 Kg/EACH 206 LBS/EACH	113 Kg/EACH 250 LBS/EACH
XG64812*	FLEXFUSION™ CABINET 600mm X 48RU X 1070mm DEEP W/SIDE PANELS	138 Kg/EACH 304 LBS/EACH	158 Kg/EACH 348 LBS/EACH
XG64819*	FLEXFUSION™ CABINET 600mm X 48RU X 1070mm DEEP W/O SIDE PANELS	96 Kg/EACH 213 LBS/EACH	116 Kg/EACH 257 LBS/EACH
XG65212*	FLEXFUSION™ CABINET 600mm X 52RU X 1070mm DEEP W/SIDE PANELS	147 Kg/EACH 323 LBS/EACH	167 Kg/EACH 368 LBS/EACH
XG65219*	FLEXFUSION™ CABINET 600mm X 52RU X 1070mm DEEP W/O SIDE PANELS	102 Kg/EACH 224 LBS/EACH	122 Kg/EACH 269 LBS/EACH
XG64222*	FLEXFUSION™ CABINET 600mm X 42RU X 1200mm DEEP W/SIDE PANELS	133 Kg/EACH 292 LBS/EACH	153 Kg/EACH 337 LBS/EACH
XG64229*	FLEXFUSION™ CABINET 600mm X 42RU X 1200mm DEEP W/O SIDE PANELS	91 Kg/EACH 201 LBS/EACH	112 Kg/EACH 246 LBS/EACH
XG64522*	FLEXFUSION™ CABINET 600mm X 45RU X 1200mm DEEP W/SIDE PANELS	142 Kg/EACH 313 LBS/EACH	162 Kg/EACH 358 LBS/EACH
XG64529*	FLEXFUSION™ CABINET 600mm X 45RU X 1200mm DEEP W/O SIDE PANELS	98 Kg/EACH 216 LBS/EACH	118 Kg/EACH 261 LBS/EACH
XG64822*	FLEXFUSION™ CABINET 600mm X 48RU X 1200mm DEEP W/SIDE PANELS	148 Kg/EACH 326 LBS/EACH	168 Kg/EACH 371 LBS/EACH
XG64829*	FLEXFUSION™ CABINET 600mm X 48RU X 1200mm DEEP W/O SIDE PANELS	101 Kg/EACH 223 LBS/EACH	122 Kg/EACH 268 LBS/EACH
XG65222*	FLEXFUSION™ CABINET 600mm X 52RU X 1200mm DEEP W/SIDE PANELS	157 Kg/EACH 346 LBS/EACH	177 Kg/EACH 391 LBS/EACH
XG65229*	FLEXFUSION™ CABINET 600mm X 52RU X 1200mm DEEP W/O SIDE PANELS	106 Kg/EACH 235 LBS/EACH	127 Kg/EACH 280 LBS/EACH

* DENOTES COLOR
 "B" = BLACK
 "W" = WHITE

ABOVE WEIGHTS ARE CABINET THAT INCLUDES SINGLE HINGED FRONT DOOR, SPLIT HINGED REAR DOOR, 1 SET OF PDU BRACKETS AND CASTERS

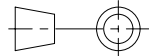
REV	DATE	BY	CHK	APR	DESCRIPTION	ECN	TITLE				
							FLEXFUSION™ CABINET FAMILY				
							CUSTOMER DRAWING				
							ITEM REVISION NAME		PANDUIT		
							00460NXB/03				
							DATASET FILE NAME		MATERIAL: N/A		
							00460NXB_DC/03A				
03A	11/15/22	MEX-JAGC	MCIS	ELE	SEE SHEET 1 FOR REVISIONS	V09002FD/05	 THIRD ANGLE PROJECTION		DRAWING NUMBER: 00460NXB-DC		
02A	8/4/22	MEX-JAGC	BRAP	ELE	SEE SHEET 1 FOR REVISIONS	V09002FD/04					
01B	9/13/2021	MES	BRAP	ELE	SEE SHEET ONE OF 12 FOR REVISIONS	V09002FD/03					
01A	7/27/2021	MES	BRAP	ELE	SEE SHEET ONE OF 12 FOR REVISIONS	V09002FD/02					
00A	1/5/2021	LEE	SSP	ELE	DRAWING RELEASE	V09002FD/00					
							DRAWN BY	DATE	CHK	SCALE	
							LEE	1/5/2021	SSP	NONE	
										SHT 10 OF 12	SIZE A

D10100DA/20

THIS COPY IS PROVIDED ON A RESTRICTED BASIS AND IS NOT TO BE USED IN ANY WAY DETRIMENTAL TO THE INTERESTS OF PANDUIT CORP.

PART NO.	DESCRIPTION	CABINET WEIGHT FULLY UNPACKAGED	CABINET WEIGHT SHIPPING WEIGHT
XG74212*	FLEXFUSION™ CABINET 700mm X 42RU X 1070mm DEEP W/SIDE PANELS	143 Kg/EACH 315 LBS/EACH	166 Kg/EACH 367 LBS/EACH
XG74219*	FLEXFUSION™ CABINET 700mm X 42RU X 1070mm DEEP W/O SIDE PANELS	106 Kg/EACH 234 LBS/EACH	130 Kg/EACH 286 LBS/EACH
XG74512*	FLEXFUSION™ CABINET 700mm X 45RU X 1070mm DEEP W/SIDE PANELS	151 Kg/EACH 332 LBS/EACH	174 Kg/EACH 384 LBS/EACH
XG74519*	FLEXFUSION™ CABINET 700mm X 45RU X 1070mm DEEP W/O SIDE PANELS	112 Kg/EACH 246 LBS/EACH	135 Kg/EACH 298 LBS/EACH
XG74812*	FLEXFUSION™ CABINET 700mm X 48RU X 1070mm DEEP W/SIDE PANELS	157 Kg/EACH 346 LBS/EACH	181 Kg/EACH 398 LBS/EACH
XG74819*	FLEXFUSION™ CABINET 700mm X 48RU X 1070mm DEEP W/O SIDE PANELS	116 Kg/EACH 255 LBS/EACH	139 Kg/EACH 307 LBS/EACH
XG75212*	FLEXFUSION™ CABINET 700mm X 52RU X 1070mm DEEP W/SIDE PANELS	167 Kg/EACH 368 LBS/EACH	192 Kg/EACH 421 LBS/EACH
XG75219*	FLEXFUSION™ CABINET 700mm X 52RU X 1070mm DEEP W/O SIDE PANELS	122 Kg/EACH 270 LBS/EACH	147 Kg/EACH 323 LBS/EACH
XG74222*	FLEXFUSION™ CABINET 700mm X 42RU X 1200mm DEEP W/SIDE PANELS	153 Kg/EACH 338 LBS/EACH	181 Kg/EACH 399 LBS/EACH
XG74229*	FLEXFUSION™ CABINET 700mm X 42RU X 1200mm DEEP W/O SIDE PANELS	112 Kg/EACH 248 LBS/EACH	140 Kg/EACH 309 LBS/EACH
XG74522*	FLEXFUSION™ CABINET 700mm X 45RU X 1200mm DEEP W/SIDE PANELS	161 Kg/EACH 354 LBS/EACH	188 Kg/EACH 415 LBS/EACH
XG74529*	FLEXFUSION™ CABINET 700mm X 45RU X 1200mm DEEP W/O SIDE PANELS	117 Kg/EACH 257 LBS/EACH	144 Kg/EACH 318 LBS/EACH
XG74822*	FLEXFUSION™ CABINET 700mm X 48RU X 1200mm DEEP W/SIDE PANELS	167 Kg/EACH 369 LBS/EACH	195 Kg/EACH 430 LBS/EACH
XG74829*	FLEXFUSION™ CABINET 700mm X 48RU X 1200mm DEEP W/O SIDE PANELS	121 Kg/EACH 266 LBS/EACH	148 Kg/EACH 327 LBS/EACH
XG75222*	FLEXFUSION™ CABINET 700mm X 52RU X 1200mm DEEP W/SIDE PANELS	177 Kg/EACH 392 LBS/EACH	206 Kg/EACH 453 LBS/EACH
XG75229*	FLEXFUSION™ CABINET 700mm X 52RU X 1200mm DEEP W/O SIDE PANELS	127 Kg/EACH 280 LBS/EACH	156 Kg/EACH 343 LBS/EACH

* DENOTES COLOR
 "B" = BLACK
 "W" = WHITE

ABOVE WEIGHTS ARE CABINET THAT INCLUDES SINGLE HINGED FRONT DOOR, SPLIT HINGED REAR DOOR, 1 SET OF PDU BRACKETS AND CASTERS

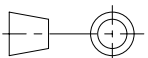
REV	DATE	BY	CHK	APR	DESCRIPTION	ECN	TITLE				
							FLEXFUSION™ CABINET FAMILY				
							CUSTOMER DRAWING				
03A	11/15/22	MEX-JAGC	MCIS	ELE	SEE SHEET 1 FOR REVISIONS	V09002FD/05	ITEM REVISION NAME 00460NXB/03				
02A	8/4/22	MEX-JAGC	BRAP	ELE	SEE SHEET 1 FOR REVISIONS	V09002FD/04	DATASET FILE NAME 00460NXB_DC/03A				
01B	9/13/2021	MES	BRAP	ELE	SEE SHEET ONE OF 12 FOR REVISIONS	V09002FD/03	 THIRD ANGLE PROJECTION		MATERIAL: N/A		
01A	7/27/2021	MES	BRAP	ELE	SEE SHEET ONE OF 12 FOR REVISIONS	V09002FD/02			DRAWING NUMBER: 00460NXB-DC		
00A	1/5/2021	LEE	SSP	ELE	DRAWING RELEASE	V09002FD/00					
							DRAWN BY LEE	DATE 1/5/2021	CHK SSP	SCALE NONE	SIZE A

D10100DA/20

THIS COPY IS PROVIDED ON A RESTRICTED BASIS AND IS NOT TO BE USED IN ANY WAY DETRIMENTAL TO THE INTERESTS OF PANDUIT CORP.

PART NO.	DESCRIPTION	CABINET WEIGHT FULLY UNPACKAGED	CABINET WEIGHT SHIPPING WEIGHT
XG84212*	FLEXFUSION™ CABINET 800mm X 42RU X 1070mm DEEP W/SIDE PANELS	153 Kg/EACH 338 LBS/EACH	177 Kg/EACH 390 LBS/EACH
XG84219*	FLEXFUSION™ CABINET 800mm X 42RU X 1070mm DEEP W/O SIDE PANELS	117 Kg/EACH 257 LBS/EACH	140 Kg/EACH 309 LBS/EACH
XG84512*	FLEXFUSION™ CABINET 800mm X 45RU X 1070mm DEEP W/SIDE PANELS	160 Kg/EACH 353 LBS/EACH	184 Kg/EACH 405 LBS/EACH
XG84519*	FLEXFUSION™ CABINET 800mm X 45RU X 1070mm DEEP W/O SIDE PANELS	121 Kg/EACH 267 LBS/EACH	145 Kg/EACH 319 LBS/EACH
XG84812*	FLEXFUSION™ CABINET 800mm X 48RU X 1070mm DEEP W/SIDE PANELS	167 Kg/EACH 369 LBS/EACH	191 Kg/EACH 421 LBS/EACH
XG84819*	FLEXFUSION™ CABINET 800mm X 48RU X 1070mm DEEP W/O SIDE PANELS	126 Kg/EACH 278 LBS/EACH	150 Kg/EACH 330 LBS/EACH
XG85212*	FLEXFUSION™ CABINET 800mm X 52RU X 1070mm DEEP W/SIDE PANELS	178 Kg/EACH 393 LBS/EACH	202 Kg/EACH 446 LBS/EACH
XG85219*	FLEXFUSION™ CABINET 800mm X 52RU X 1070mm DEEP W/O SIDE PANELS	134 Kg/EACH 294 LBS/EACH	157 Kg/EACH 347 LBS/EACH
XG84222*	FLEXFUSION™ CABINET 800mm X 42RU X 1200mm DEEP W/SIDE PANELS	163 Kg/EACH 359 LBS/EACH	190 Kg/EACH 420 LBS/EACH
XG84229*	FLEXFUSION™ CABINET 800mm X 42RU X 1200mm DEEP W/O SIDE PANELS	122 Kg/EACH 268 LBS/EACH	149 Kg/EACH 329 LBS/EACH
XG84522*	FLEXFUSION™ CABINET 800mm X 45RU X 1200mm DEEP W/SIDE PANELS	170 Kg/EACH 375 LBS/EACH	198 Kg/EACH 436 LBS/EACH
XG84529*	FLEXFUSION™ CABINET 800mm X 45RU X 1200mm DEEP W/O SIDE PANELS	126 Kg/EACH 278 LBS/EACH	154 Kg/EACH 339 LBS/EACH
XG84822*	FLEXFUSION™ CABINET 800mm X 48RU X 1200mm DEEP W/SIDE PANELS	178 Kg/EACH 392 LBS/EACH	205 Kg/EACH 453 LBS/EACH
XG84829*	FLEXFUSION™ CABINET 800mm X 48RU X 1200mm DEEP W/O SIDE PANELS	131 Kg/EACH 289 LBS/EACH	159 Kg/EACH 350 LBS/EACH
XG85222*	FLEXFUSION™ CABINET 800mm X 52RU X 1200mm DEEP W/SIDE PANELS	189 Kg/EACH 416 LBS/EACH	217 Kg/EACH 478 LBS/EACH
XG85229*	FLEXFUSION™ CABINET 800mm X 52RU X 1200mm DEEP W/O SIDE PANELS	139 Kg/EACH 305 LBS/EACH	166 Kg/EACH 367 LBS/EACH

* DENOTES COLOR
 "B" = BLACK
 "W" = WHITE

ABOVE WEIGHTS ARE CABINET THAT INCLUDES SINGLE HINGED FRONT DOOR, SPLIT HINGED REAR DOOR, 1 SET OF PDU BRACKETS AND CASTERS

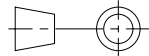
REV	DATE	BY	CHK	APR	DESCRIPTION	ECN	TITLE	ITEM REVISION NAME	DATASET FILE NAME	MATERIAL	DRAWING NUMBER
							FLEXFUSION™ CABINET FAMILY	00460NXB/03	00460NXB_DC/03A	N/A	00460NXB-DC
03A	11/15/22	MEX-JAGC	MCIS	ELE	SEE SHEET 1 FOR REVISIONS	V09002FD/05	 <p>THIRD ANGLE PROJECTION</p>				
02A	8/4/22	MEX-JAGC	BRAP	ELE	SEE SHEET 1 FOR REVISIONS	V09002FD/04					
01B	9/13/2021	MES	BRAP	ELE	SEE SHEET ONE OF 12 FOR REVISIONS	V09002FD/03					
01A	7/27/2021	MES	BRAP	ELE	SEE SHEET ONE OF 12 FOR REVISIONS	V09002FD/02					
00A	1/5/2021	LEE	SSP	ELE	DRAWING RELEASE	V09002FD/00					

D10100DA/20