

> LDM216-251

All-in-one Direct View LED Display User Guide

IMPORTANT: Please read this User Guide to obtain important information on installing and using your product in a safe manner, as well as registering your product for future service. Warranty information contained in this User Guide will describe your limited coverage from ViewSonic® Corporation, which is also found on our web site at <http://www.viewsonic.com> in English, or in specific languages using the Regional selection box in the upper right corner of our website. "Antes de operar su equipo lea cuidadosamente las instrucciones en este manual"

Model No. VS18476
P/N: LDM216-251

Thank you for choosing ViewSonic®

As a world-leading provider of visual solutions, ViewSonic® is dedicated to exceeding the world's expectations for technological evolution, innovation, and simplicity. At ViewSonic®, we believe that our products have the potential to make a positive impact in the world, and we are confident that the ViewSonic® product you have chosen will serve you well.

Once again, thank you for choosing ViewSonic®!

> Safety Precautions

Please read the following **Safety Precautions** before you start using the device.

- Keep this user guide in a safe place for later reference.
- Read all warnings and follow all instructions.
- Ensure there is no direct airflow from air conditioning blowing on the display.
- Do not use the device near water. To reduce the risk of fire or electric shock, do not expose the device to moisture.
- Avoid exposing the device to direct sunlight or other sources of sustained heat.
- Do not install near any heat sources such as radiators, heat registers, stoves, or other devices (including amplifiers) that may increase the temperature of the device to dangerous levels.
- When moving the device, be careful not to drop or bump the device on anything.
- Do not place the device on an uneven or unstable surface. The device may fall over resulting in an injury or a malfunction.
- Do not place any heavy objects on the device or connection cables.
- If smoke, an abnormal noise, or a strange odor is present, immediately turn the device off and call your dealer or ViewSonic®. It is dangerous to continue using the device.
- Do not attempt to circumvent the safety provisions of the polarized or grounding-type plug. A polarized plug has two blades with one wider than the other. A grounding-type plug has two blades and a third grounding prong. The wide blade and the third prong are provided for your safety. If the plug does not fit into your outlet, obtain an adapter and do not attempt to force the plug into the outlet.
- When connecting to a power outlet, DO NOT remove the grounding prong. Please ensure grounding prongs are NEVER REMOVED.
- Protect the power cord from being treaded upon or pinched, particularly at the plug, and at the point where it emerges from the equipment. Ensure that the power outlet is located near the equipment so that it is easily accessible.
- Only use attachments/accessories specified by the manufacturer.
- When a cart is used, use with caution when moving the cart/equipment combination to avoid injury from tipping over.
- Disconnect the power plug from the AC outlet if the device is not being used for a long period of time.



- Place the device in a well-ventilated area.
- Do not cover the surface of the display with any material.
- Do not block the air circulation around the display.
- Keep flammable materials away from the display.
- Refer all servicing to qualified service personnel. Service will be required when the unit has been damaged in any way, such as:
 - » if the power supply cord or plug is damaged;
 - » if liquid is spilled onto or objects fall in the unit;
 - » if the unit is exposed to moisture;
 - » if the unit does not operate normally or has been dropped.
- Do not assemble the display by yourself.
- This panel is an advanced product that contains millions of pixels. You may occasionally see pixel spots when viewing the screen. Since these deactivated pixels are not a defect, the performance and reliability of the product is not affected. For more information, please see page 76.

> Contents







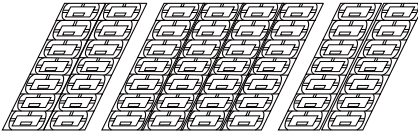
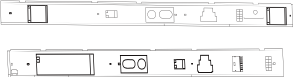
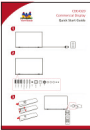
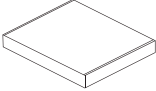

Safety Precautions.....	3
Introduction	8
Package Contents	8
Product Overview	9
Front Panel	9
Rear Panel	9
I/O Control Panel.....	10
Remote Control	11
Installation	14
Wall Mounting.....	14
Installing the Upper and Lower Wall Mount Brackets	14
Installing the Middle Cabinets.....	16
Installing the Left and Right Cabinet	18
Connecting the System Control Box.....	20
Installing the LED Modules	22
Installing System Control Box Covers	23
Making Connections	25
Connecting to External Devices	25
HDMI IN Connection	25
Audio Connection.....	25
Video Output Connection	25
USB and Networking Connections	26
RS-232 Connection	26

Using Your Display.....	27
Powering On/Off your LED Display	27
Home Screen	28
Navigating the Home Screen	29
Remote Control	29
Keyboard and Mouse	29
APP Center.....	30
Input Source	31
Settings.....	32
Settings Menu Tree	33
Network & Internet.....	38
Connected Devices.....	41
Apps & Notifications	42
Display	45
Sound	48
Storage	49
System.....	50
Upgrade.....	52
On-Screen Display (OSD) Menu	53
On-Screen Display (OSD) Menu Tree	54
Menu Options	57
Picture	57
Sound	59
Time.....	61
NetWork	64
Update.....	66
Advanced.....	67
Embedded Applications.....	69
ViewBoard Cast	69
vSweeper	73
Browser	74
WPS Office.....	74

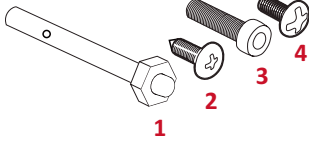
Appendix.....	75
Specifications.....	75
LED Display Stuck Pixel Definition	76
Timing Chart	77
HDMI (PC).....	77
HDMI (Video).....	78
Supported Media Formats.....	79
Troubleshooting	81
Maintenance.....	83
General Precautions	83
Initial Operation	83
Front Panel Cleaning Instructions	83
Cabinet Cleaning Instructions	83
Regular Use	84
Vacuum Suction Tool.....	85
LED Module Disassembly	87
RS-232 Protocol.....	89
RS-232 Hardware Specification	89
RS-232 Communication Setting.....	89
Command Table	90
Regulatory and Service Information	91
Compliance Information.....	91
FCC Compliance Statement.....	91
IC Warning Statement	92
Country Code Statement.....	92
IC Radiation Exposure Statement.....	93
CE Conformity for European Countries	93
Declaration of RoHS2 Compliance.....	94
European Union Regulatory Conformance	94
Indian Restriction of Hazardous Substances	95
Product Disposal at End of Product Life	95
Copyright Information	96
Customer Service	97
Limited Warranty	98
Mexico Limited Warranty.....	101

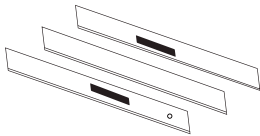
> Introduction

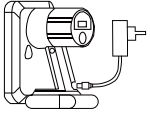
Package Contents

Item	Quantity	Note
Cabinet Sections		8 sections total
System Control Box (Left and Right sides)		2 sides
Quick Start Guide		1
LED Modules		128 modules The quantity of spare LED modules will vary by country.
Remote Control		1
Screws		48 x M6x50mm Expansion (1) 48 x TA6x30mm (2) 32 x M6x16mm (3) 18 x KM3x6mm (4)
Hex Tool		1
System Control Box Covers (Left, Middle, and Right sides)		3
Wall Mounting Brackets		4
Vacuum Suction Tool		1
Anti-Static Gloves		2 pairs
USB-A to USB-B Cable (5m)		1

NOTE:

- This product is packed in an air transport box.
- Due to the size and weight, it is recommended that two or more people handle it.
- The base stand is an optional accessory and will be sold separately.

Product Overview

Front Panel

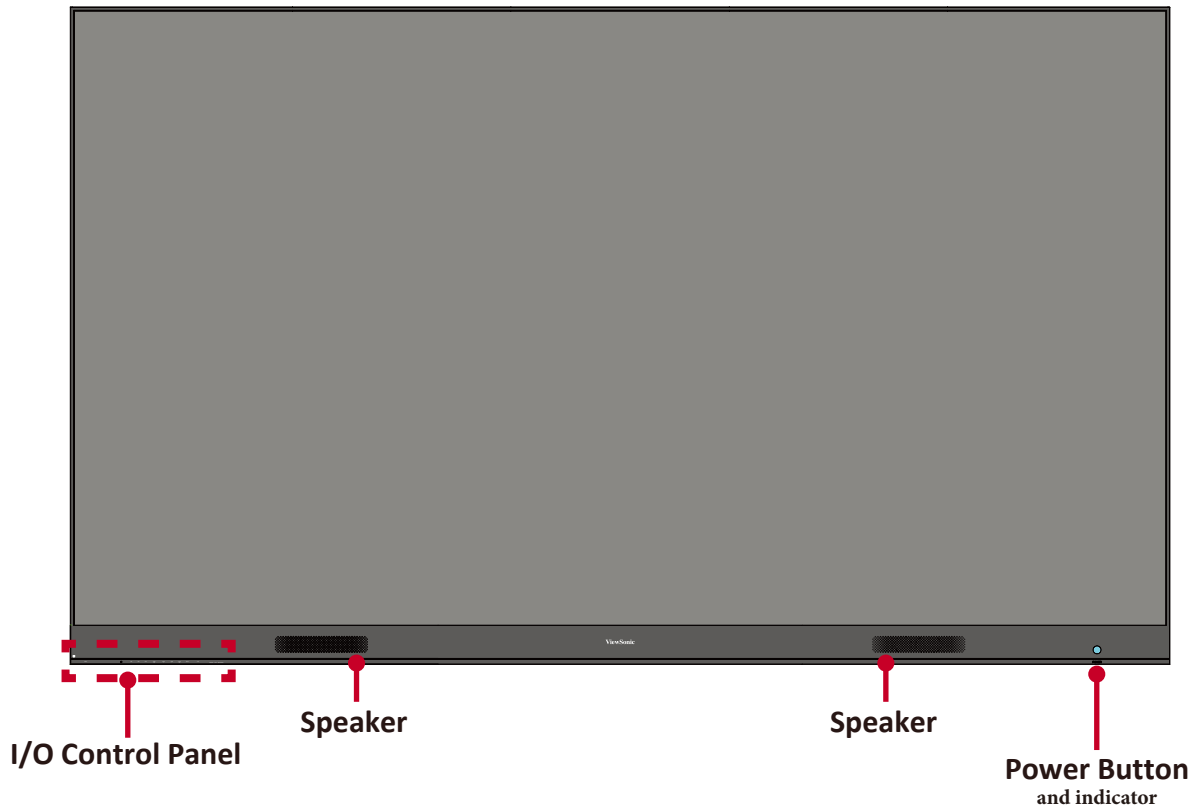



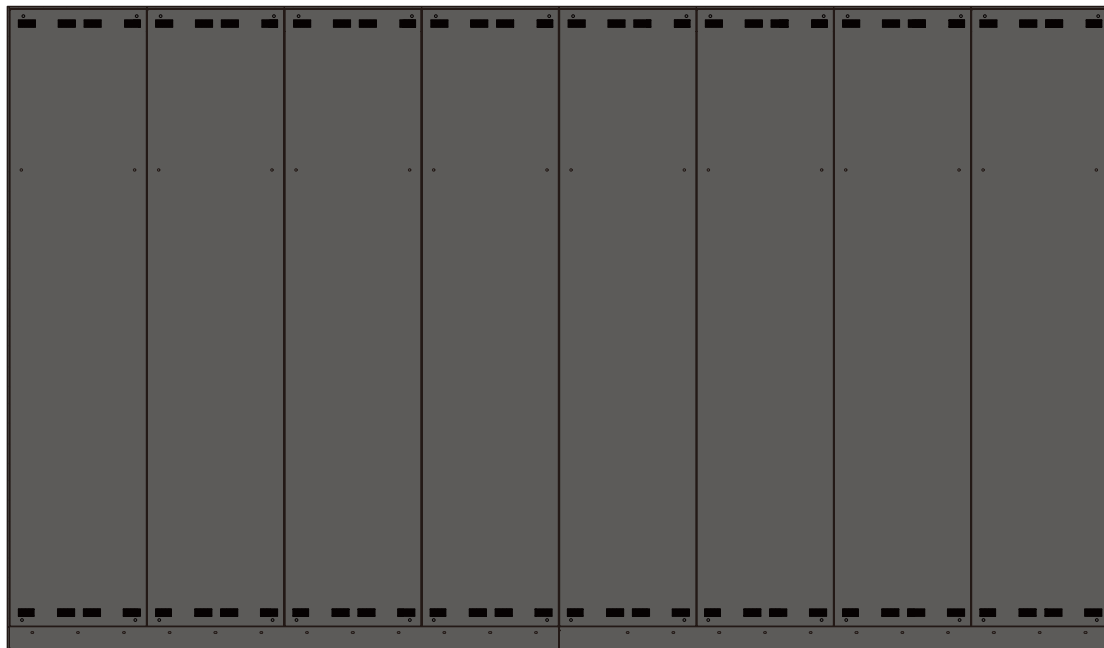



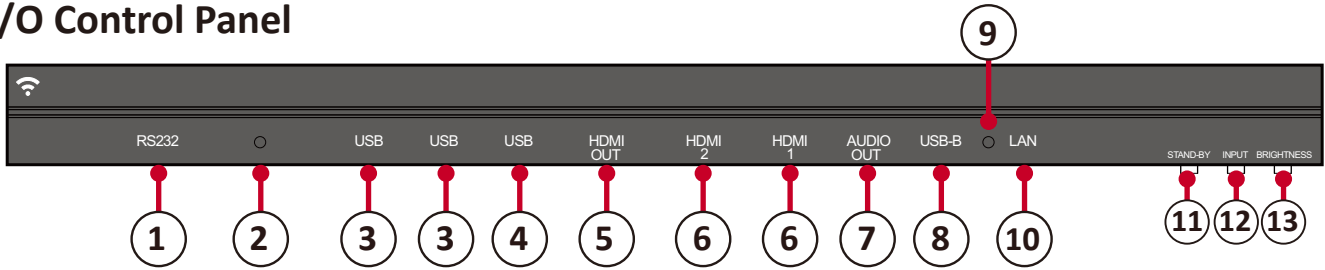

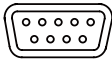



Rear Panel



I/O Control Panel



Number	Item	Port	Description
1		RS-232	Serial control port.
2		Ambient Light Sensor	Detects ambient light and adjusts brightness levels automatically.
3	 USB	USB 2.0	USB Reader (5V/0.5A)
4	 USB	USB 3.0	USB Reader. (5V/1A)
5		HDMI Out	Extend content out to another display device.
6		HDMI In	High definition input; connect to PC with HDMI output, set-top box, or other video device.
7		Audio Out	Audio output to an external speaker.
8		USB-B	Maintenance port for external PC connection.
9		IR Receiver	Receiver for the Remote Control.
10		LAN	Standard RJ45 (10M/100M/1000M) Internet connection interface.
11		Stand-by	Press to enter Stand-by mode.
12		Input Select	Press to cycle through available input sources.
13		Brightness	Press to cycle through brightness levels.

Locking the Control Panel

When the administrator does not want others to use the control panel, it can be locked by pressing 1168+OK on the remote control.

Remote Control

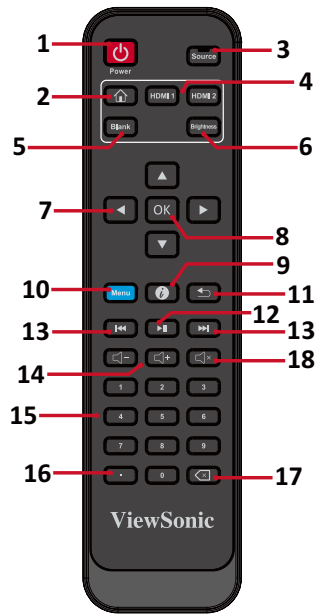

Number	Icon	Item	Description
1		Power	Power On/Off
2		Home	Back to Home Screen
3		Source	Input source selection
4		HDMI 1/2	Change to HDMI 1/2 input source
5		Blank	Switch to a blank, black screen
6		Brightness	Adjust the brightness level
7		▲/▼/◀/▶	Directional buttons
8		OK	Confirm the selection
9		i	Enter the Information page
10		Menu	Enter the Settings menu
11		Return	Return to previous
12		Play/Pause	Play/Pause content
13		Forwards/Backwards	Move content forwards/backwards
14		Volume Up/Down	Increase/decrease the volume level
15		Numbers	Numeric input buttons
16		.	Input key for a dot
17		Backspace/Clear	Delete key for text input
18		Mute	Mute/Unmute

Inserting Remote Control Batteries

The remote control is powered by two 1.5v "AAA" batteries.

To insert batteries into the remote control:

1. Remove the cover on the rear of the remote control.
2. Insert two "AAA" batteries, ensuring the "+" symbol on the battery matches the "+" on the battery post.
3. Replace the cover by aligning it with the slot on the remote control and snapping the latch shut.

WARNING: There is a risk of explosion if batteries are installed with incorrect polarity.

NOTE:

- It is recommended that you do not mix battery types.
- Avoid exposure to heat or steam.
- Do not allow water or other liquids to splash on the remote control. If the remote control becomes wet, wipe it dry immediately.
- Always dispose of old batteries in an environmentally friendly way. Contact your local government for more information on how to dispose of batteries safely.

Locking the Remote Control

When the administrator does not want others to control the remote control, it can be locked by pressing 1169+OK on the remote control.

Remote Control Receiver Range

The operating range of the remote control is shown here. It has an effective range of 20 feet (6 meters), 30° degrees left and right. Ensure there is nothing obstructing the remote control's signal to the receiver.

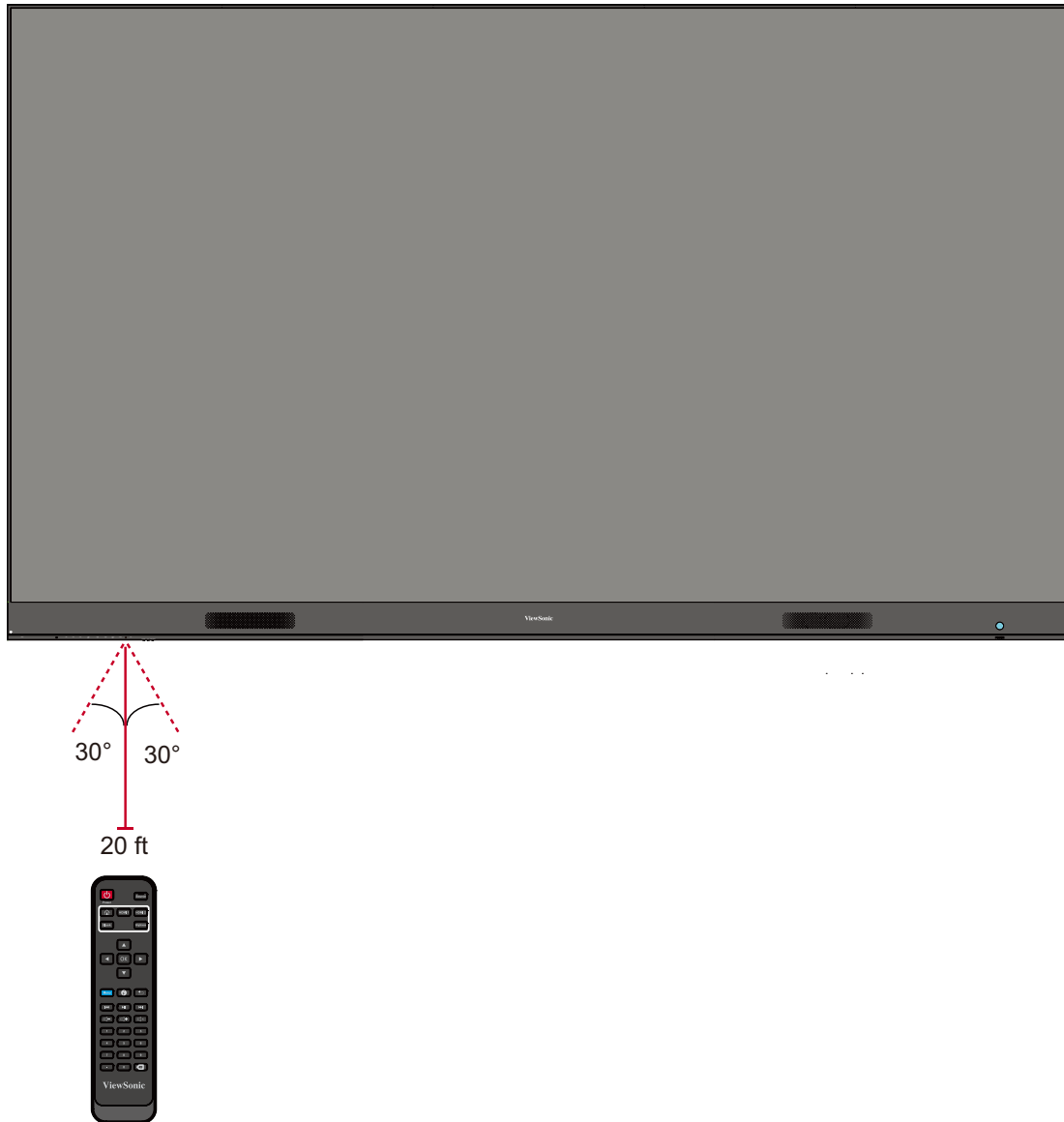

> Installation

Before Installing

- ! Maintain an adequate air gap between the back of the display and any wall for proper ventilation.
- ! Ensure there is no direct airflow from air conditioning or heating vents blowing on the display.
- ! Avoid installing the display in places with high humidity.
- ! Due to high power usage, always use power cords specifically designed for this product.

Wall Mounting

Installing the Upper and Lower Wall Mount Brackets

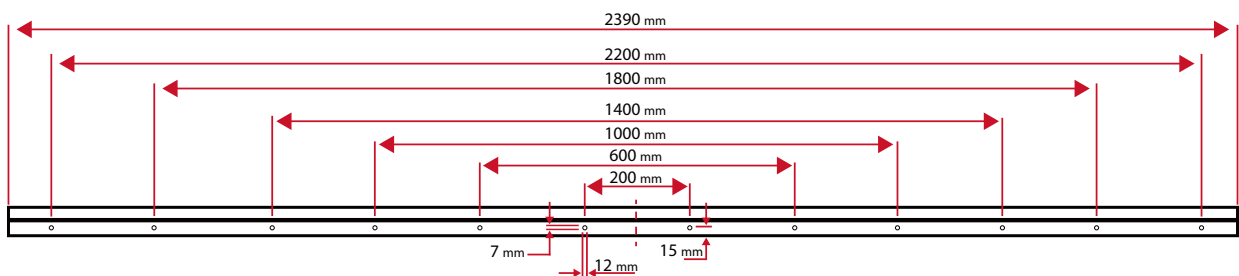

1. Ensure the wall area and size is an appropriate installation site.

NOTE: The height of the Upper *Wall Mount Brackets* must not be less than 129.92" (3.3 meters) from the ground.

2. Using the *Wall Mount Bracket* (pictured above) as a guide, mark each of the holes and pre-drill each.
3. Install the first Upper *Wall Mount Bracket* with the provided screws (M6x50mm Expansion for masonry; TA6x30mm for load bearing wood).
4. Repeat **Step 2**, ensuring the second Upper *Wall Mount Bracket* is level with the first upper bracket.

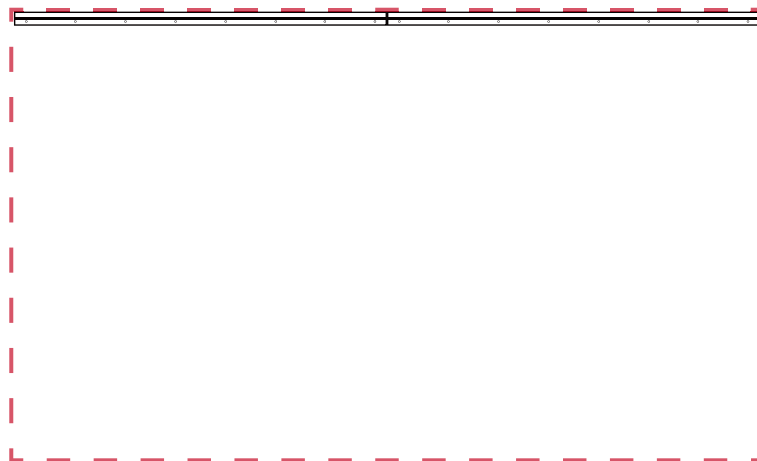

5. Install the Lower *Wall Mount Brackets* in the same manner as the *Upper Wall Mount Brackets*. The distance between the Upper and Lower *Wall Mount Brackets* is 103.94" (2640 mm).

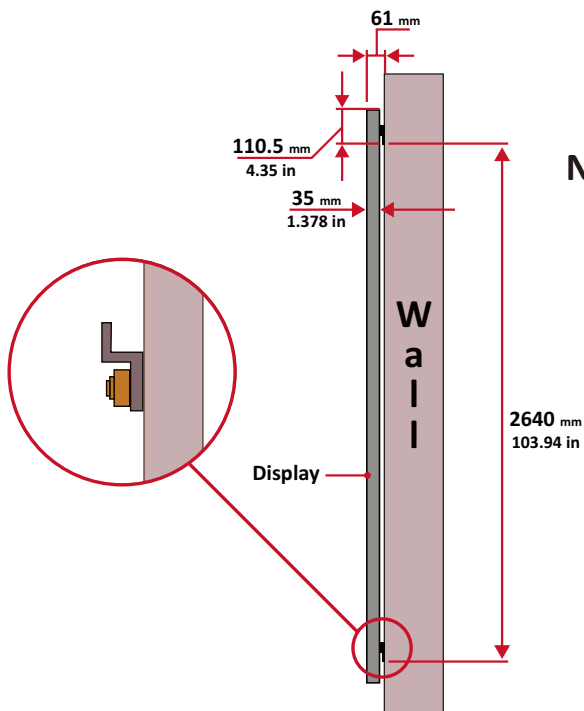

NOTE: You can also install the *Upper Wall Mount Brackets*, hang the screen, and then install the *Lower Wall Mount Brackets* for a more precise fit.

! Ensure the wall can safely support 749.57 lbs. (340 kg).

6. After installing both Upper and Lower *Wall Mount Brackets*, the installation wall should look like:

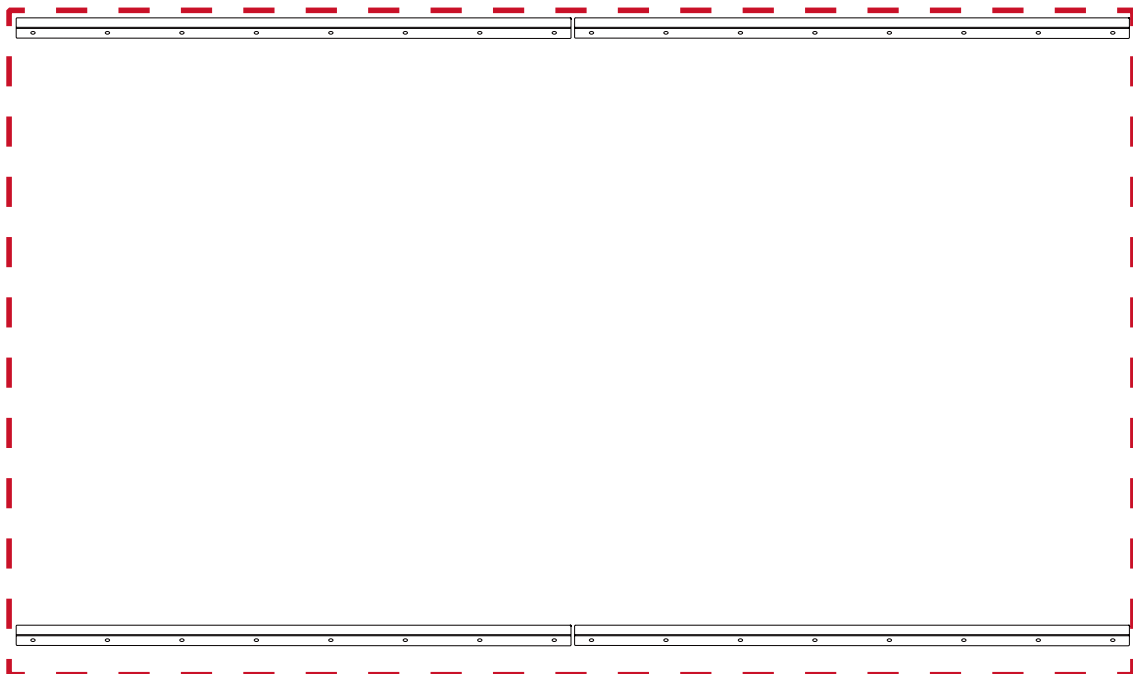

Installing the Middle Cabinets

1. Ensure the *Mounting Brackets* on the rear of the six (6) *Middle Cabinets* are positioned at the top and bottom mounting positions as shown below:

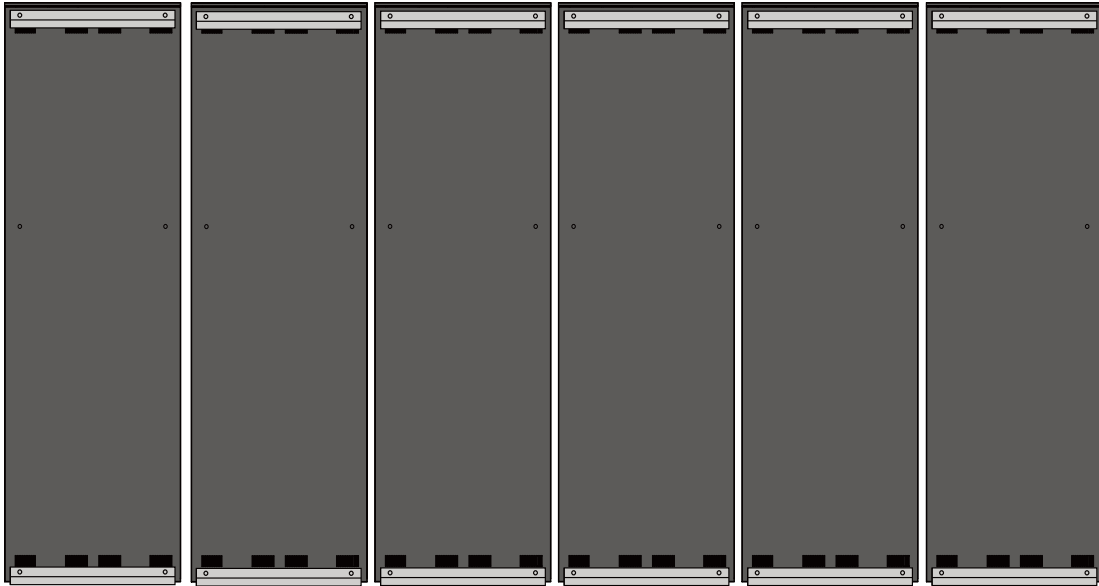

2. Carefully lift each *Middle Cabinet* up onto the *Upper Wall Mount Brackets*.

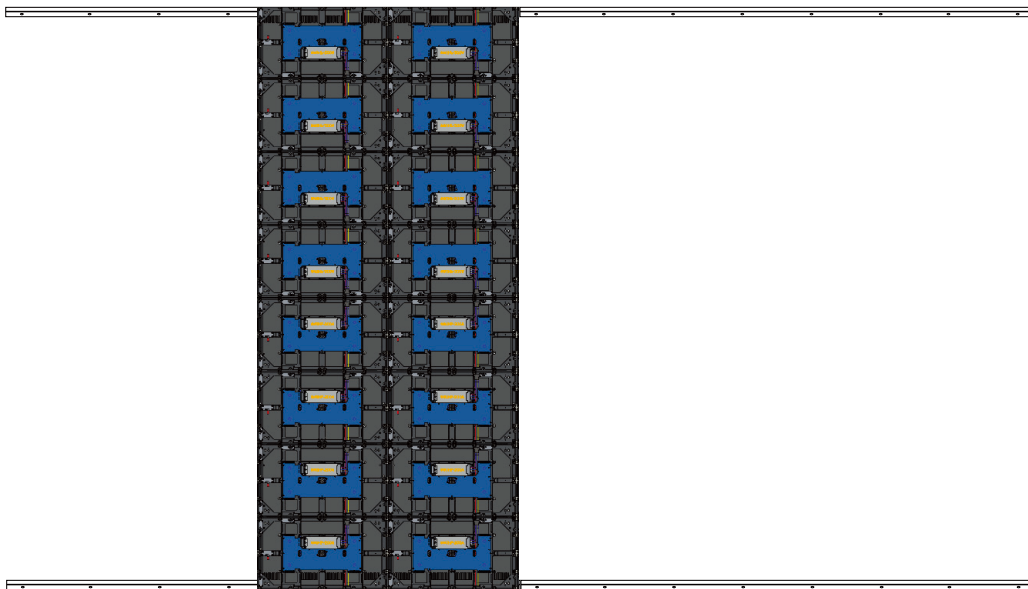

3. Ensure the *Mounting Brackets* sit securely on the *Wall Mount Brackets* as shown below.

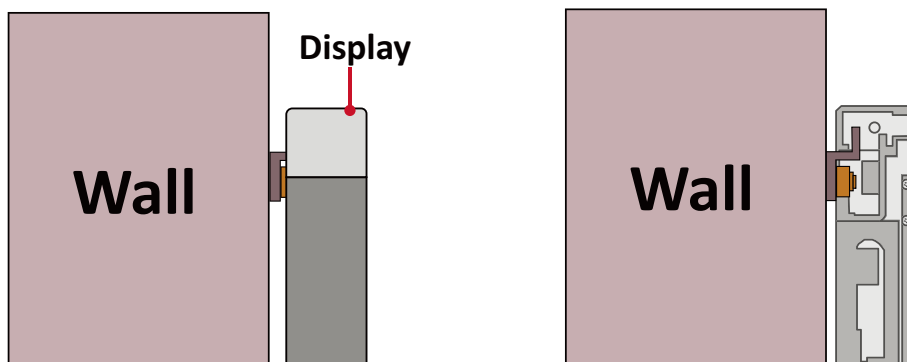

4. Push each *Locking Bolt* and lock each *Hook* with the hex tool to securely connect each cabinet together.

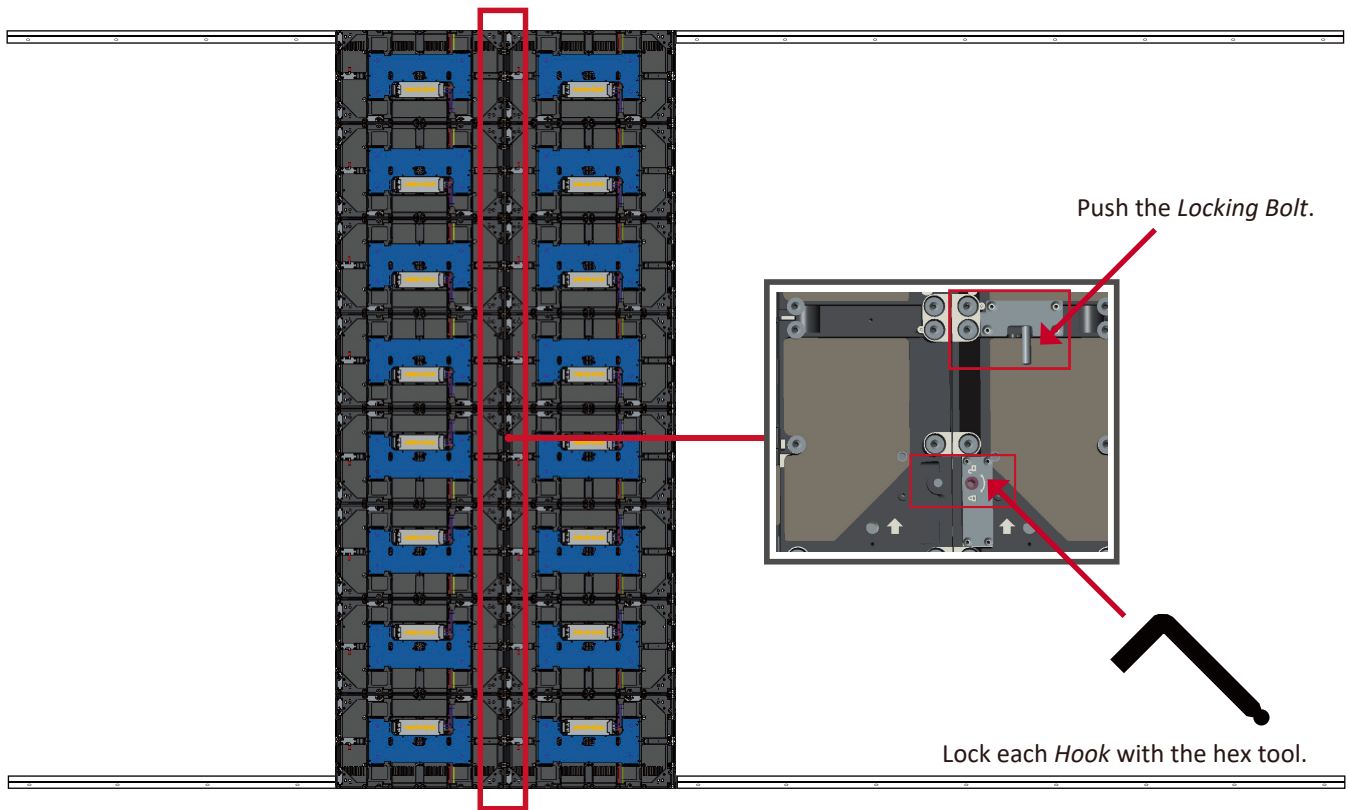

NOTE: There are eight (8) *Locking Bolts* and 16 *Hooks* between each cabinet.

5. Lift the remaining *Middle Cabinet* up onto the *Upper Wall Mount Brackets*, ensuring the *Mounting Brackets* sit securely on the *Wall Mount Brackets*.

6. Repeat Step 4, securing the cabinets together with each *Locking Bolt* and *Hook*.

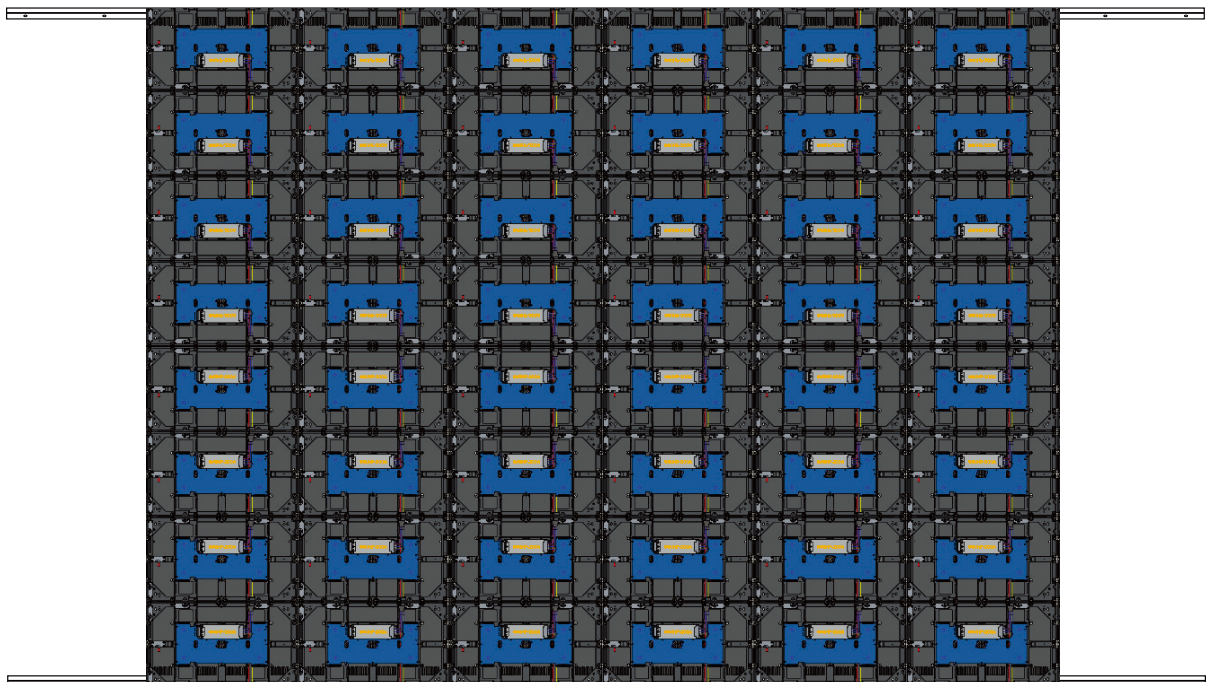

Installing the Left and Right Cabinet

1. Ensure the *Mounting Brackets* on the rear of the *Left and Right Cabinet* are positioned at the top and bottom mounting positions as shown below:

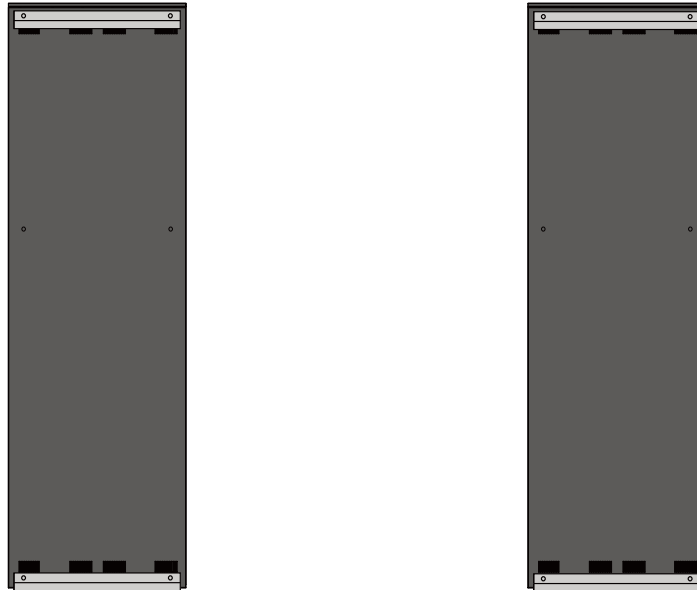

2. Carefully lift the *Left and Right Cabinet* up onto the *Upper Wall Mount Brackets*, ensuring the *Mounting Brackets* sit securely on the *Wall Mount Brackets*.

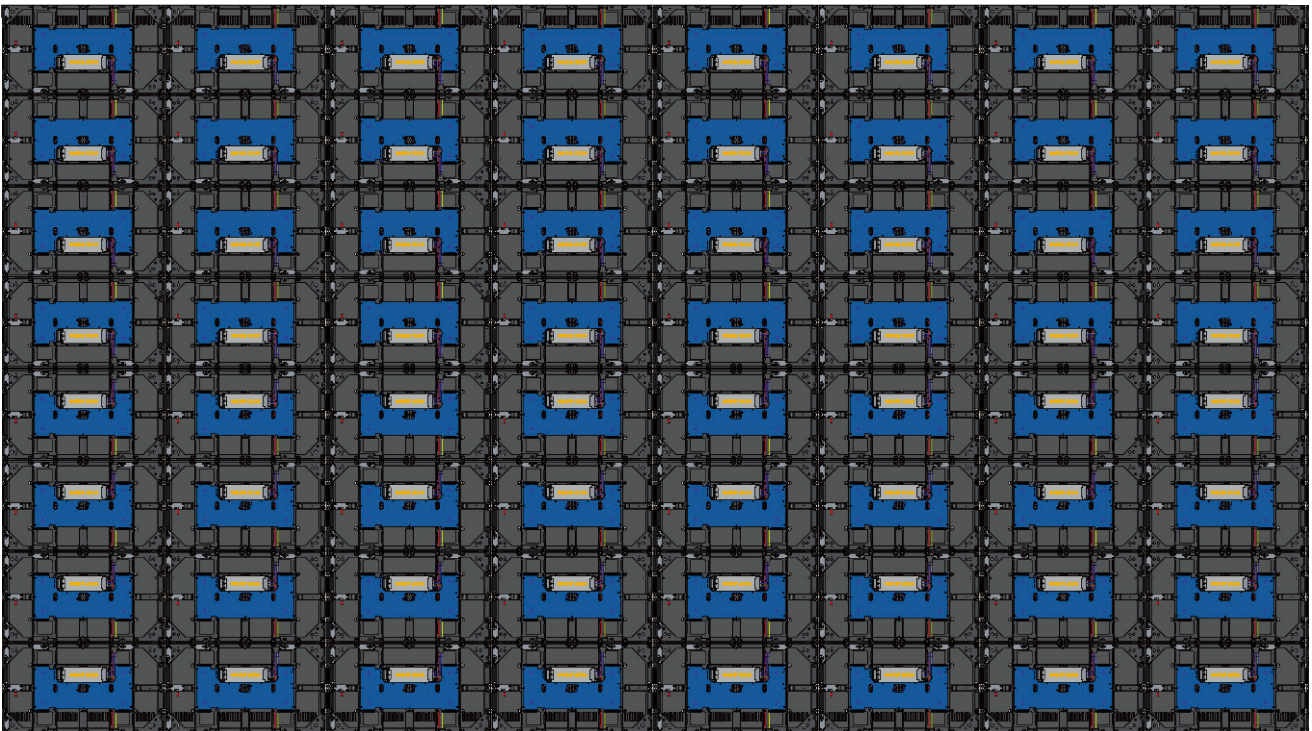

3. Adjust the *Left or Right Cabinet* so that they fit seamlessly with the *Middle Cabinets*.

4. Push each *Locking Bolt* and lock each *Hook* with the hex tool to securely connect the *Left* and *Right Cabinets*.

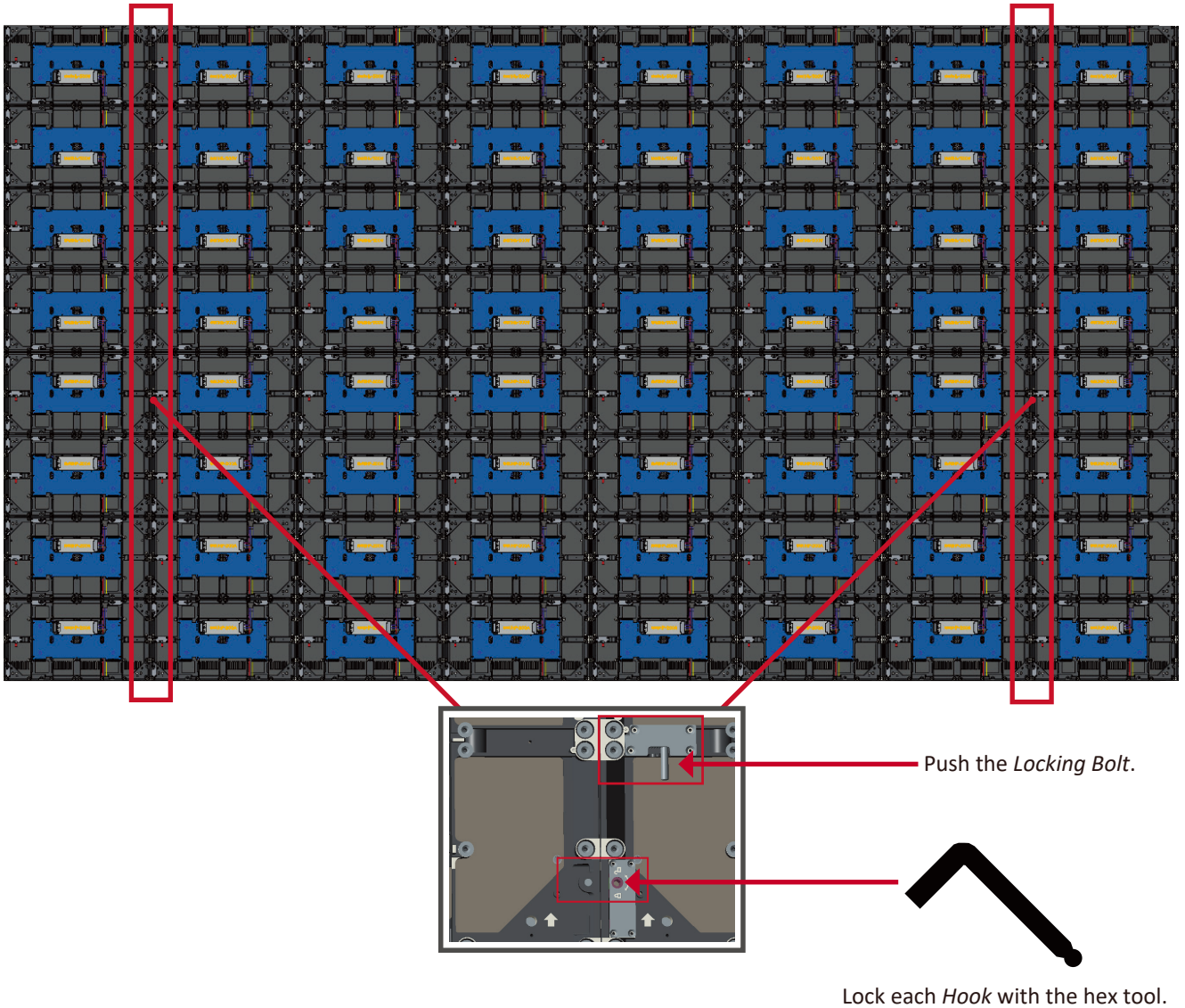

NOTE: There are eight (8) *Locking Bolts* and 16 *Hooks* between each cabinet.

Connecting the System Control Box

1. Carefully unfold the *System Control Box* panel. Ensure the main system control board is on the left.

NOTE: Use caution as the *System Control Box* panel will be separated into two pieces, however the wires are connected.

2. Align the holes of the *Cabinet* with the *System Control Box* to attach.

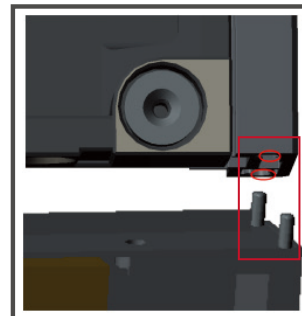
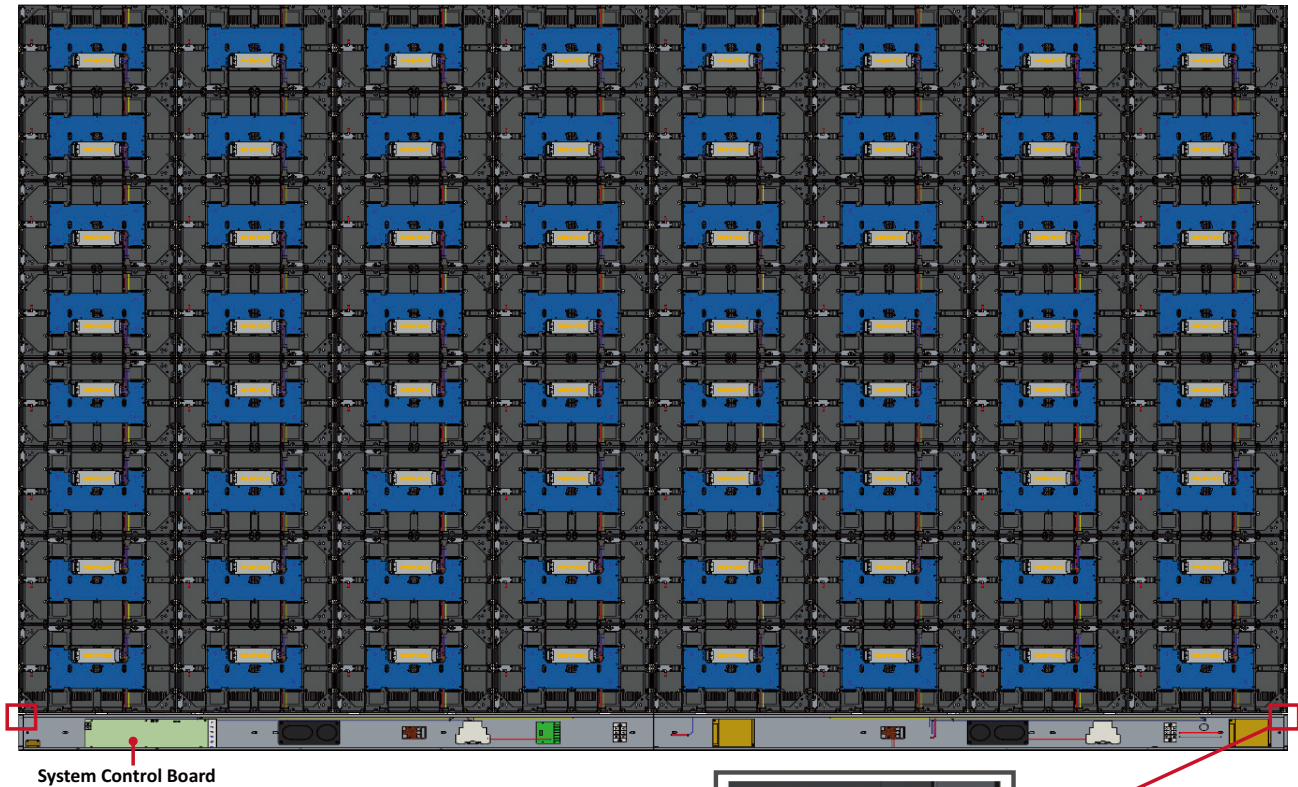

3. Further secure the *System Control Box* to the *Cabinets* with the 32 provided screws (M6x16mm).



4. Connect the Network and Power cables of the *Cabinets* to the *System Control Box*.

NOTE: There are four (4) Network and eight (8) Power cables to connect.

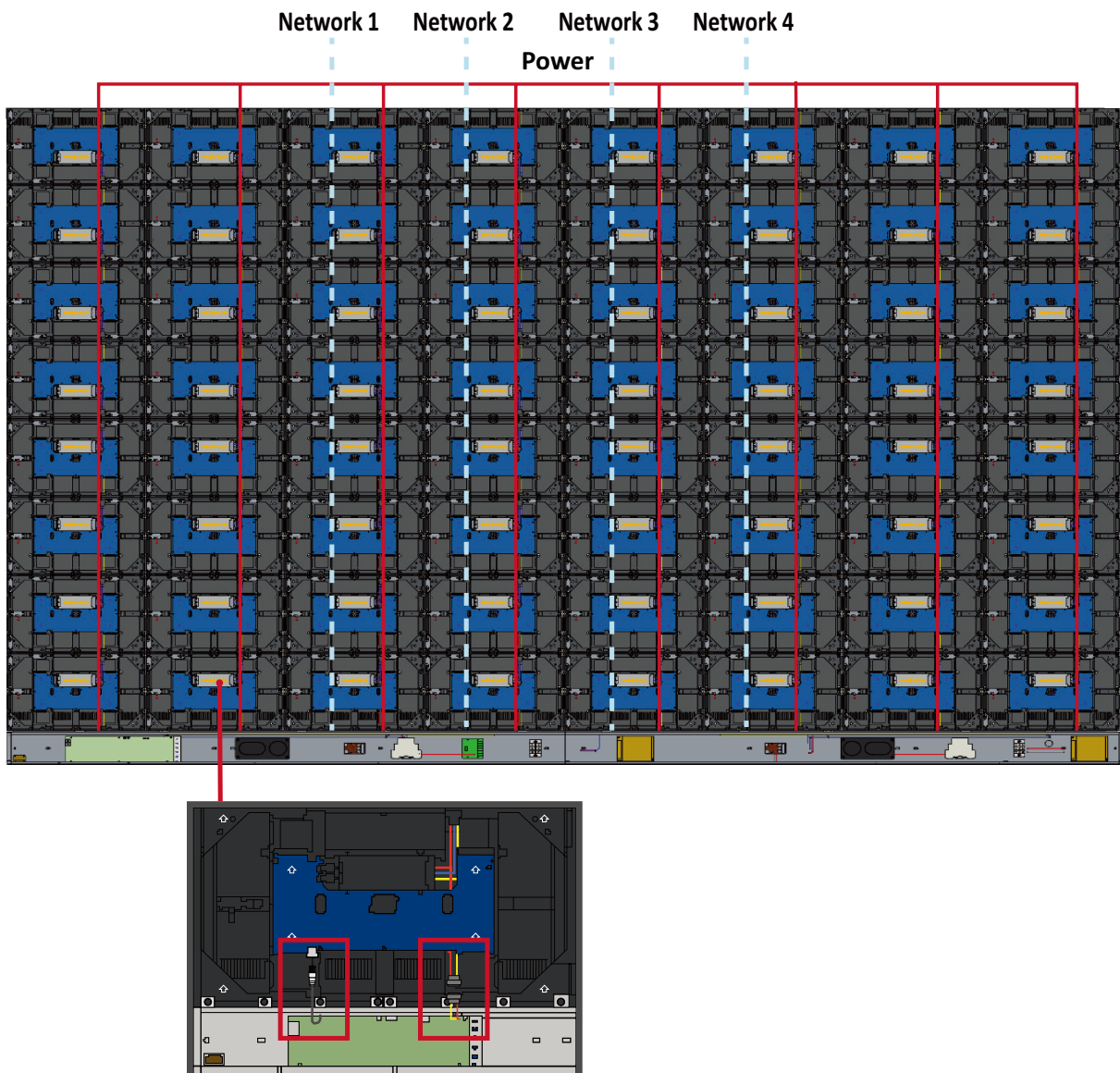

Installing the LED Modules

Install each *LED Module* onto the *Cabinets*, being sure to match the corresponding numbers on the *Module* to the *Cabinet*.

! Please wear Anti-Static Gloves before installing the LED modules.



Ensure each *Module* is flush and that there is little to no gap between each.

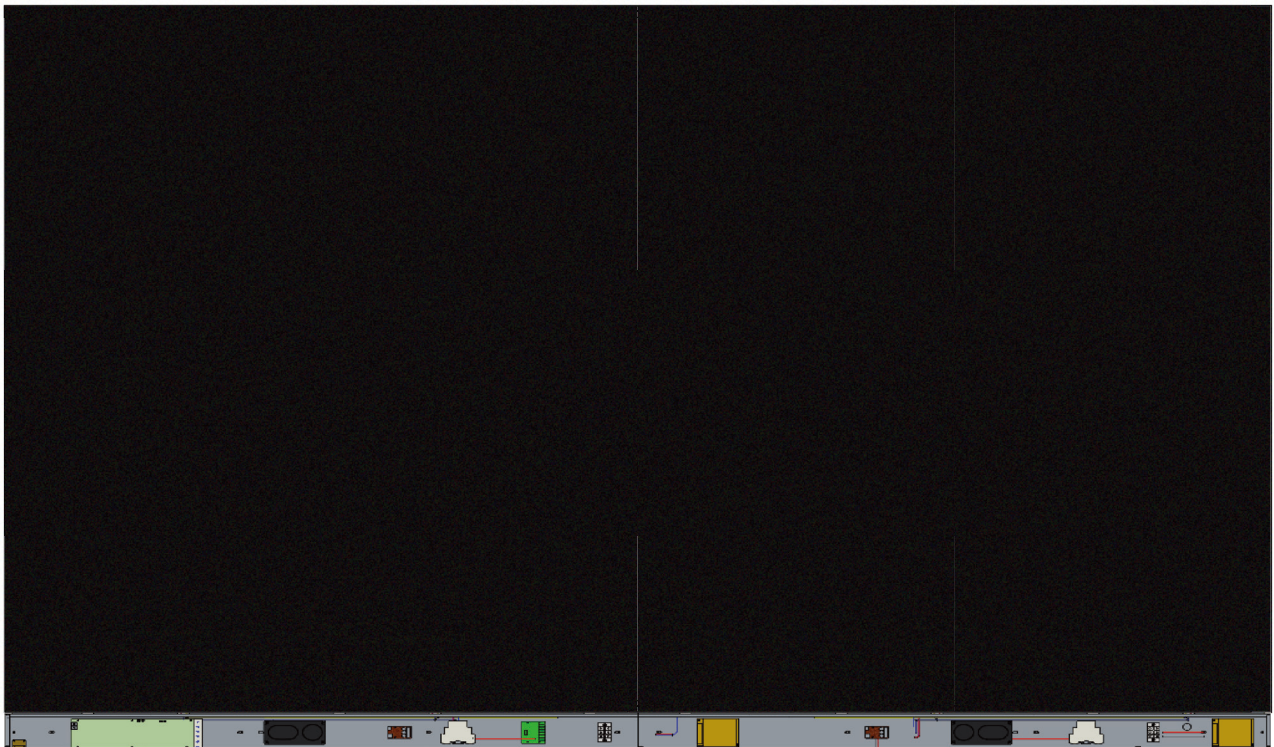

Installing System Control Box Covers

There are three (3) System Control Box Covers: Left, Middle, and Right.



1. Begin by installing the *Right Cover* onto the *System Control Box*.

NOTE: Ensure the **Power Button** cable is connected to the *System Control Box* Power cable before securing the *Cover*.

2. After connecting the **Power Button** cable, ensure the *Right Cover* is properly aligned with the *System Control Box*; then secure it with the 18 provided screws (KM3x6mm).



3. Repeat the above steps for the *Middle* and *Left Cover*.



4. Your display is now ready for use.

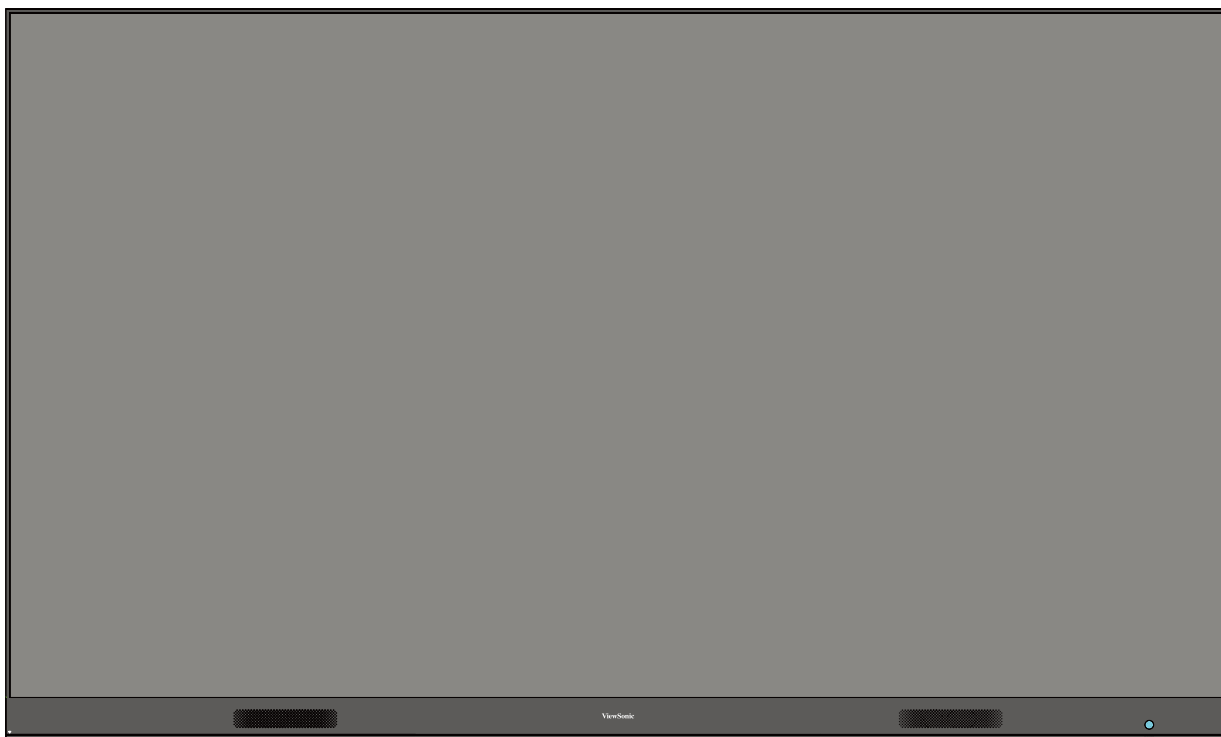

NOTE: An installation video is available at:

<https://www.youtube.com/watch?v=cYmOUypjvWU&t=4s>

> Making Connections

Connecting to External Devices

HDMI IN Connection

Media Player Connection

Connect an HDMI cable from your external device to an **HDMI IN** port on the LED display.

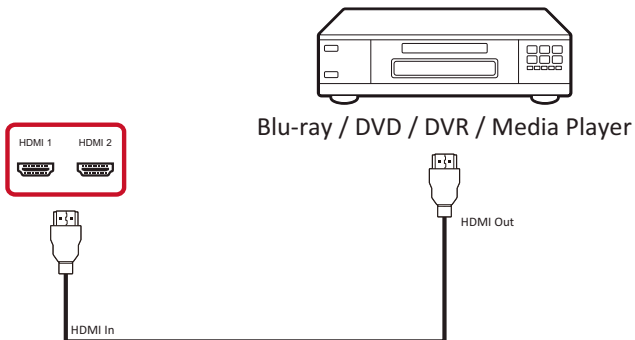

PC Connection

Connect an HDMI cable from your PC to an **HDMI IN** port on the LED display.

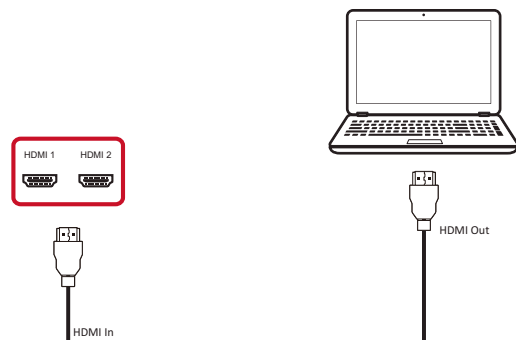

Audio Connection

Connect an audio cable from your external audio device to the **Audio Out** port on the LED display.

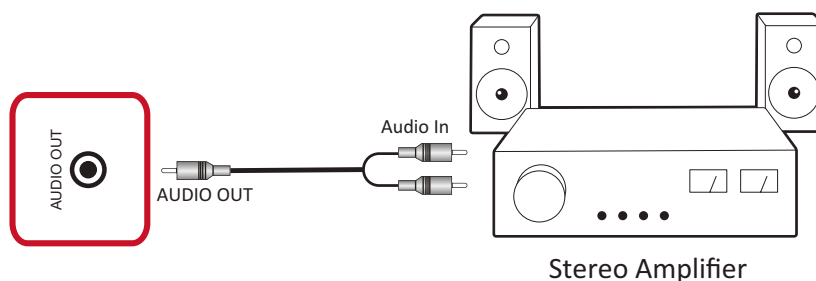

Video Output Connection

To output video via an external display device, connect an HDMI cable to the **HDMI IN** port of your external display device, and the other end to the **HDMI OUT** port of your LED display.

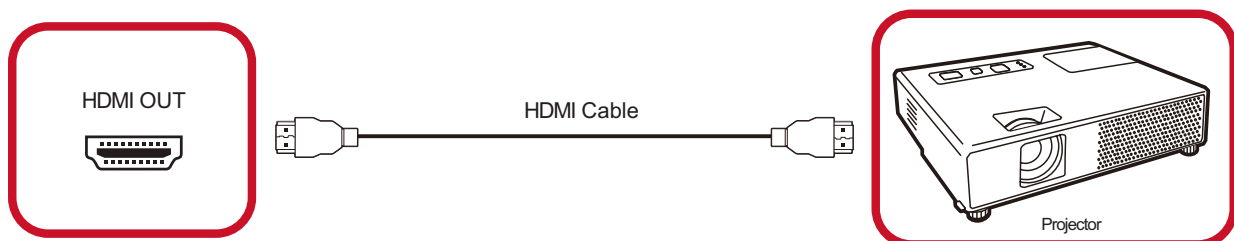

USB and Networking Connections

Just like any PC, it is easy to connect various USB devices and other peripherals to your LED display.

USB (Type A / Type B)

- USB Type A

Plug the USB device, cable, or storage drive into the **USB Type A** port.

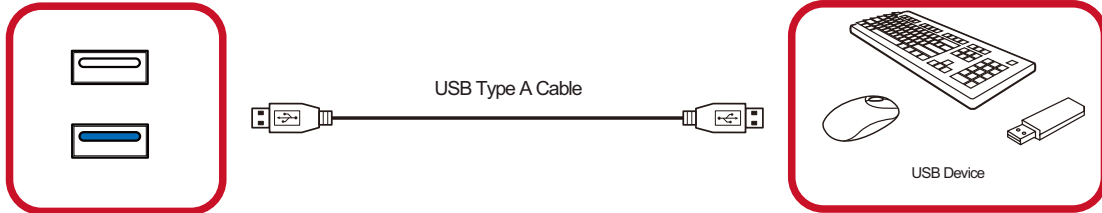

- USB Type B

Connect your PC with the LED display for debugging purposes via the **USB Type B** port on the LED display.

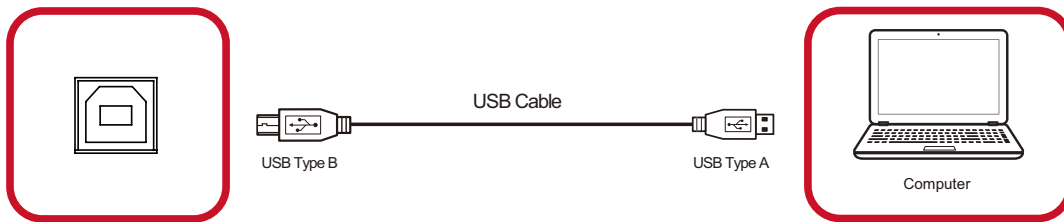

Networking and Modem cables

Plug the network cable into the **LAN** port.

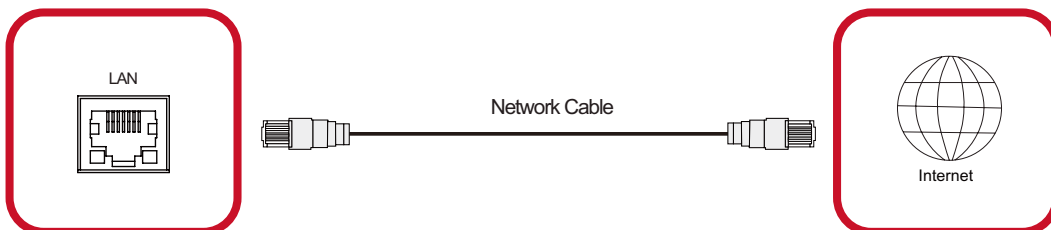

RS-232 Connection

When you use a RS-232 serial cable to connect your LED display to an external computer and control system certain functions can be controlled remotely such as: Power On/Off, Volume adjustment, Input select, Brightness, and more.

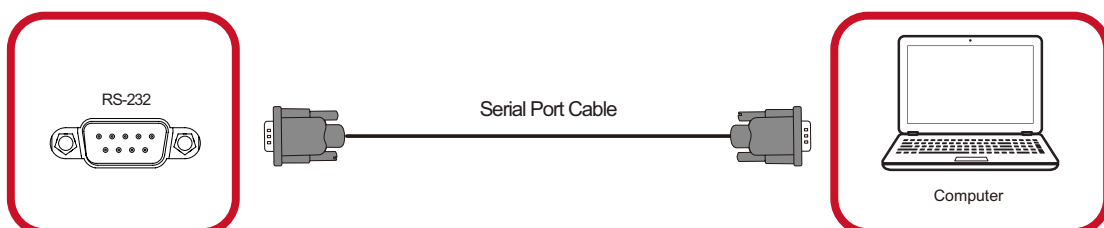

> Using Your Display

Powering On/Off your LED Display

1. Ensure the power cord is connected and plugged into a power outlet.

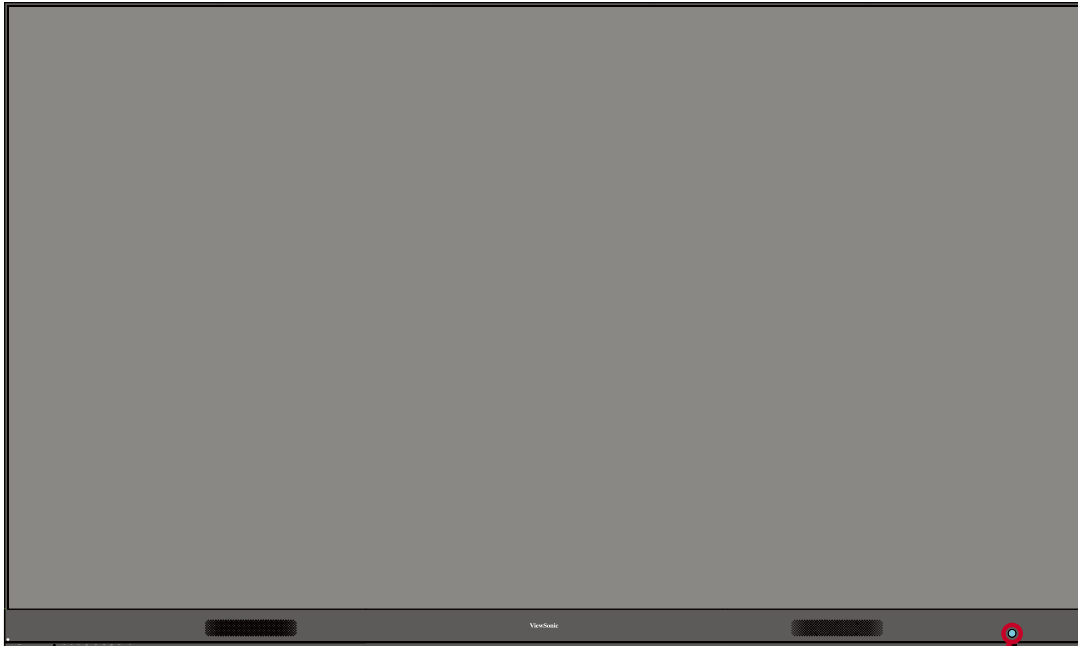

The **⏻ Power** button is located on the front of the unit.

2. Press the **⏻ Power** button to turn on the LED display.
3. To turn the LED display off, press the **⏻ Power** button again.

Home Screen

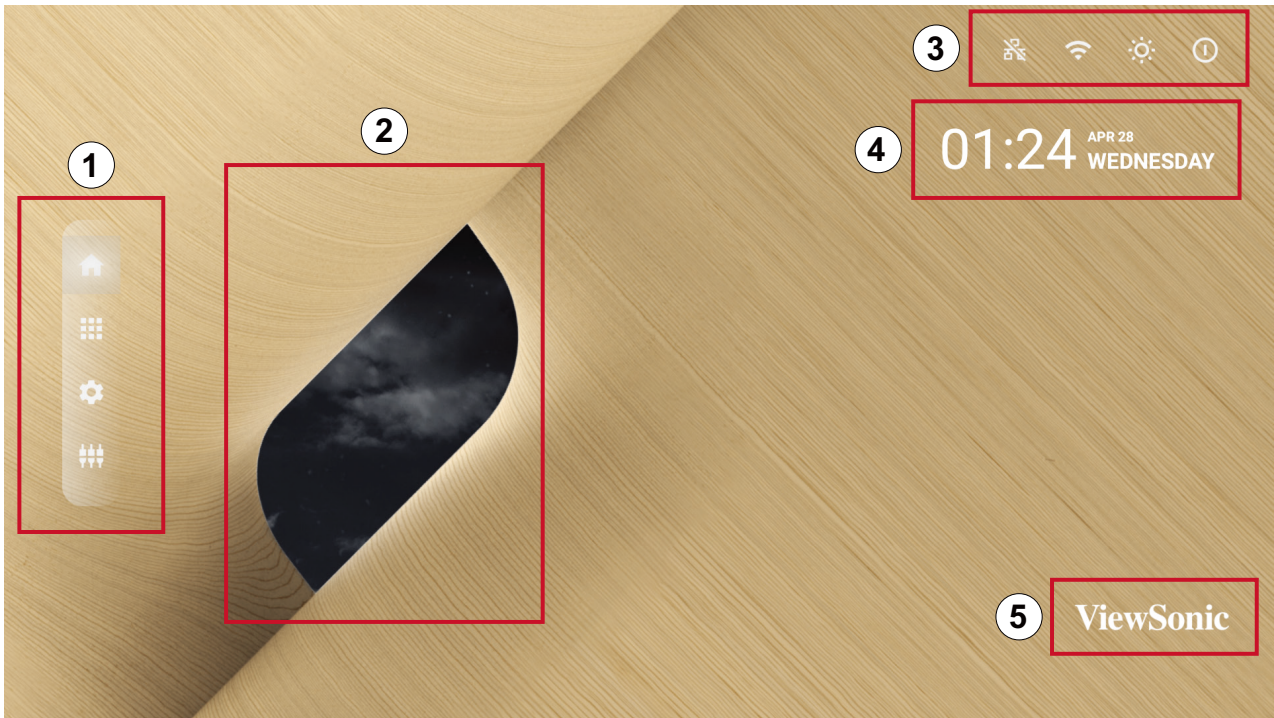

Number	Item	Description
1	Main Menu	Access the Home Screen, APP Center, Settings, and Input Source.
2	Time of Day Indicator	The sky will change over the day between morning, noon, afternoon, and night.
3	Quick Access	Quick access to LAN, Wi-Fi, Brightness, and Power. NOTE: Only supported by keyboard and mouse.
4	Date & Time	Automatic time adjustment, time zone selection, and 24-hour format can all be adjusted on page 51. The Date & Time can also be hidden from the Home Screen under: Settings > Display > Launcher Settings
5	ViewSonic Logo	The logo can be hidden from the Home Screen under: Settings > Display > Launcher Settings

Navigating the Home Screen

Remote Control

The remote control can be used to easily navigate the Home Screen. When using the remote control, ensure it is kept within the IR receiver range as shown below:

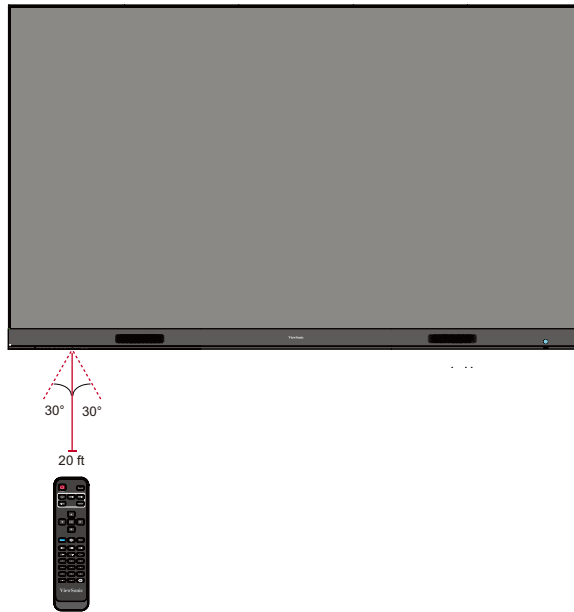

Keyboard and Mouse

When connected to the USB Type-A port of the display, a keyboard and mouse can also be used to navigate the Home Screen.

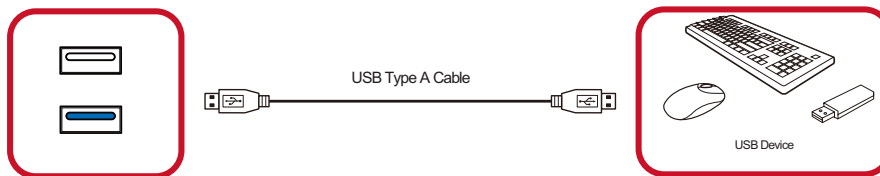

The mouse pointer will appear as an orange dot on the display when used:

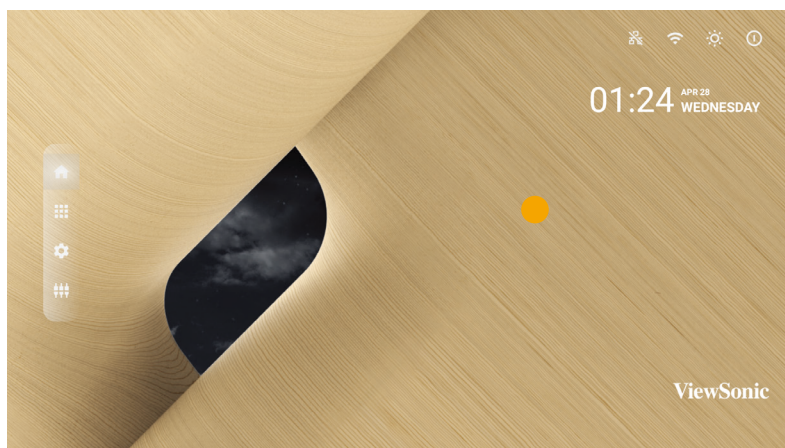







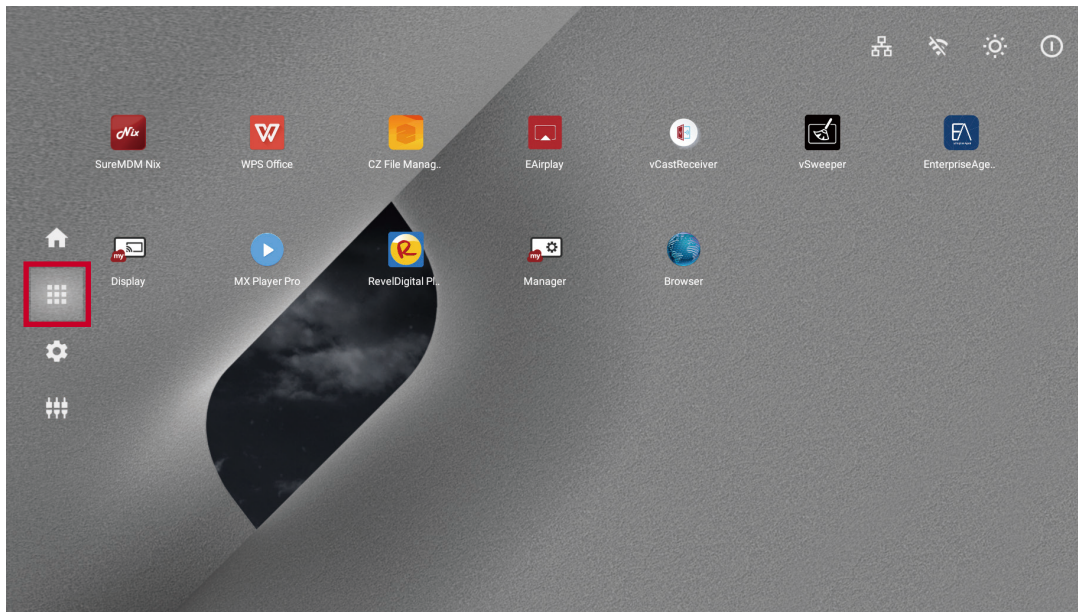



- The left mouse button will confirm actions.
- The right mouse button will go back to the previous layer.
- Keyboard shortcuts and hot keys are also supported, including: audio adjustment, mute, and back to the Home Screen.

APP Center

Installed applications will be in the APP Center.



Icon	Name	Description
	Browser	Web browser
	Display	Wirelessly mirror your desktop
	EAirplay	AirPlay mirroring
	EnterpriseAgent	Device management
	File Manager	File explorer
	Manager	Remote device management
	Revel Digital Signage	Manage digital signage
	SureMDM Nix	Secure, monitor, and manage devices
	WPS Office	Create documents, spreadsheets, and presentations
	vCastReceiver	Receive casted content from devices
	vSweeper	Clear up storage space

NOTE: Preloaded applications are subject to change without notice.

Input Source

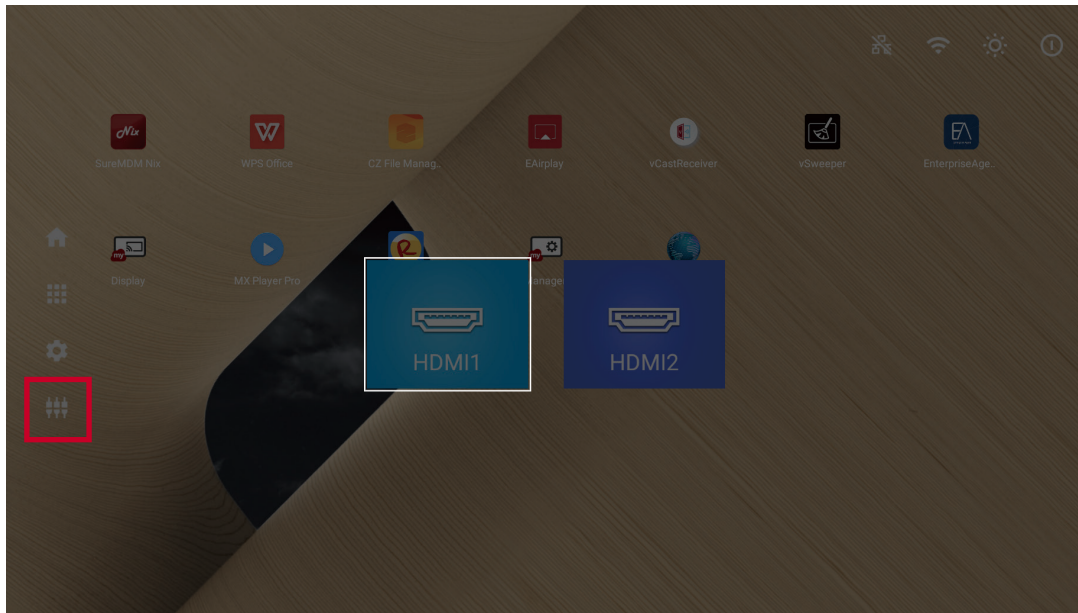

The display supports two input sources: **HDMI 1** and **HDMI 2**.

NOTE: Both input sources support HDMI 2.0.

Settings

Adjust and view the display's settings.

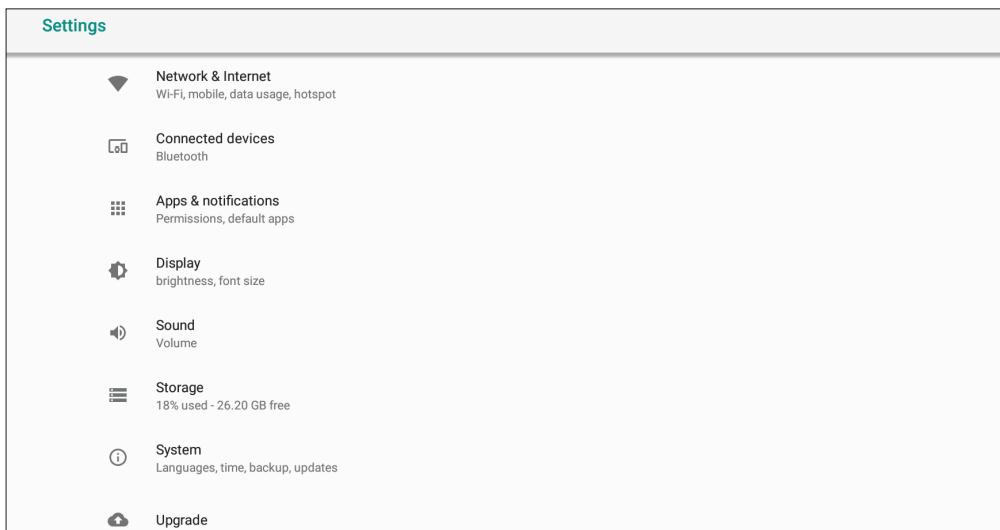

Menu	Description
Network & Internet	View and adjust Wi-Fi, Data Usage, Ethernet, Potable Hotspot, and VPN
Connected Devices	View and adjust Connected Devices
Apps & Notifications	View and adjust App Info., Notifications, App Permissions, Default Apps, and Special App Access
Display	View and adjust Brightness Level, Ambient Light Sensor, Font Size, Startup & Shutdown, Input Setting, and Launcher Settings
Sound	View and adjust Media Volume
Storage	View and adjust Device Storage
System	View and adjust Languages & Input, Date & Time, Reset, and About Device
Upgrade	View and adjust OTA Upgrade and Local Update

Settings Menu Tree

Main Menu	Sub-menu	Menu Option			
Network & Internet	Wi-Fi	Wi-Fi	On		
			Off		
		Wi-Fi List	Add Network		
		Wi-Fi Preference	Open Network Notification		On
					Off
			Keep Wi-Fi on During Sleep		
		Advanced			
	Data Usage	Wi-Fi Data Usage			
		Network Restrictions	Meter Wi-Fi Network	On	
				Off	
	Ethernet	Ethernet	On		
			Off		
		Ethernet IP Mode			
		Ethernet Details			
	Portable Hotspot	Portable Wi-Fi Hotspot	On		
Off					
Set up Wi-Fi Hotspot					
VPN					
Connected Devices	Connected Devices	On			
		Off			

Main Menu	Sub-menu	Menu Option	
Apps & Notifications	App Info.	Installed Apps	Disable
			Force Stop
	Notifications	Allow Notifications Dots	On
			Off
		On the Lock Screen	Don't Show Notifications at All
			Show All Notification's Content
	App Permissions	Body Sensors	
		Calendar	
		Camera	
		Contacts	
		Location	
		Microphone	
		Phone	
		SMS	
		Storage	
	Default Apps	Assist & Voice Input	
		Browser	
		Home	
		Opening Links	

Main Menu	Sub-menu	Menu Option			
Apps & Notifications	Special App Access	Battery Optimization			
		Device Admin Apps			
		Do No Disturb Access			
		Display Over other Apps			
		VR Helper Services			
		Modify System Settings			
		Notification Access			
		Picture-in-Picture			
		Premium SMS Access			
		Unrestricted Data Access			
		Usage Access			
		Install Unknown Apps			
Display	Brightness Level	(-/+ , 1~8)			
	Ambient Light Sensor	On			
		Off			
	Font Size	(-/+ , 1~4)			
	Other Display Settings	Display Settings	Custom Resolution	W: 800~1920	H: 600~1080
			Custom DPI	(-/+ , 100~240)	
			Custom Wallpaper		
Boot Logo Settings			Video Logo		

Main Menu	Sub-menu	Menu Option			
Display	Startup & Shutdown	Last Shutdown Channel			
		Default Startup Channel	Home		
			HDMI 1		
			HDMI 2		
			APP (Display)		
			APP (vCastReceiver)		
		Standby Mode	Hibernate		
			Sleep		
		Splash Screen	ViewSonic		
			Black		
			Blue		
		Input Setting	Input Alias	HDMI 1	Display
				Hide	
	Signal Source Detect		HDMI 2	Display	
				Hide	
	Launcher Settings	ViewSonic Logo	On		
			Off		
		Date & Time	On		
			Off		
		Theme			
	Sound	Media Volume	(-/+ , 0~100)		
Storage	Device Storage	Internal Shared Storage	Storage Manager	On	
				Off	
		Portable Storage	Photos & Videos		
			Music & Audio		
			Games		
	Movie & TV				

Main Menu	Sub-menu	Menu Option		
System	Language & Input	Languages		
		Virtual Keyboard	Remote Controller Input Method	
			Manage Keyboards	
		Physical Keyboard	Hi Keyboard	
			Hi Keypad	
			Keyboard Assistance	
			Gestures	
		Advanced	Preferred Engine	
			Language	
			Speech Rate	
	Pitch			
	Date & Time	Automatic Date & Time	On	
			Off	
		Select Time Zone		
		Use 24-hour Format	On	
	Off			
	Reset	Network Settings Reset		
		Reset App Preferences		
		Factory Data Reset		
	About Device	Status		
Legal Information				
Model				
Kernel Version				
Build Number				
Total Time				
Upgrade	OTA Upgrade	OTA Cloud Server		
	Local Update	sda1		
		SDcard		

Network & Internet

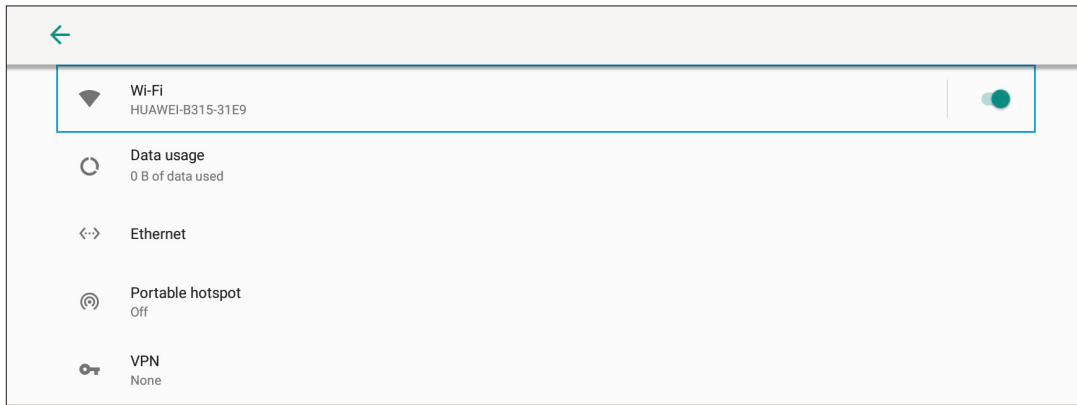

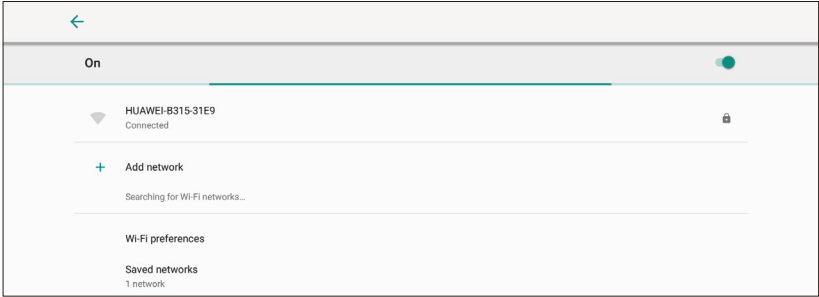
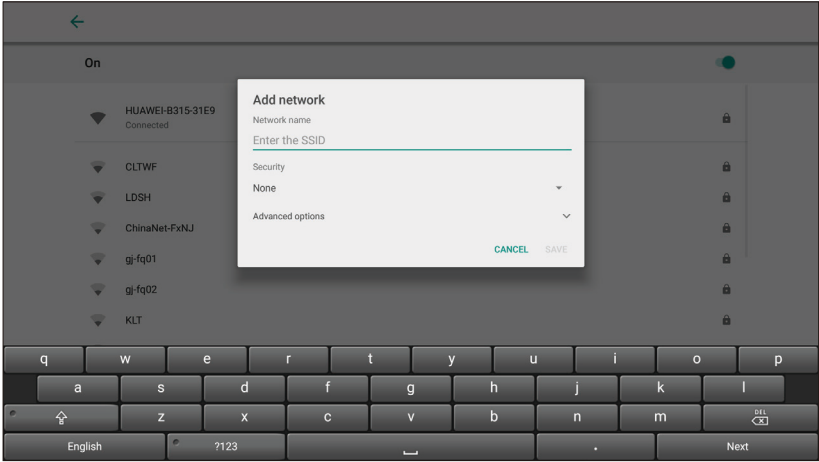
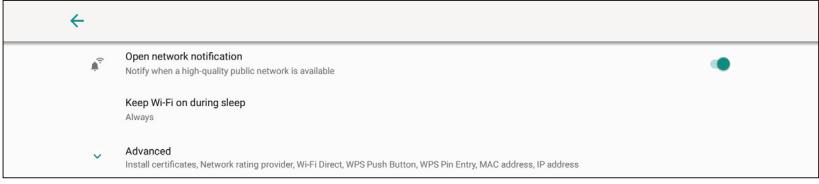
Sub-menu	Description
<p>Wi-Fi</p>	<p>Select Wi-Fi to enter the Wi-Fi selection interface. Then select the desired Wi-Fi network and enter the password.</p>  <p>You can select Add Network in the Wi-Fi selection screen to manually add a Wi-Fi network.</p>  <p>Select Wi-Fi Preferences to view Wi-Fi usage preferences, Wi-Fi connection tips, etc.</p> 

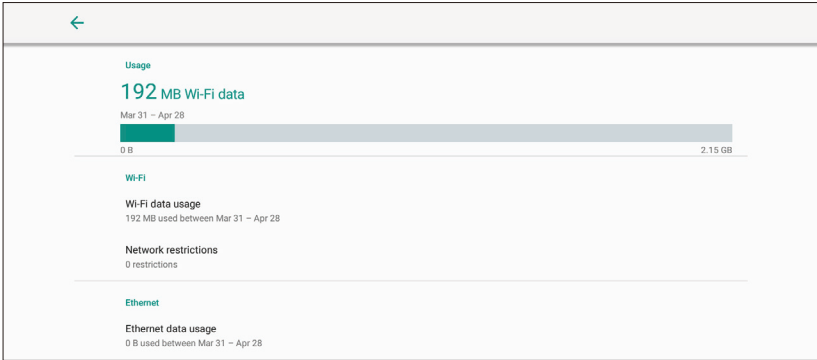
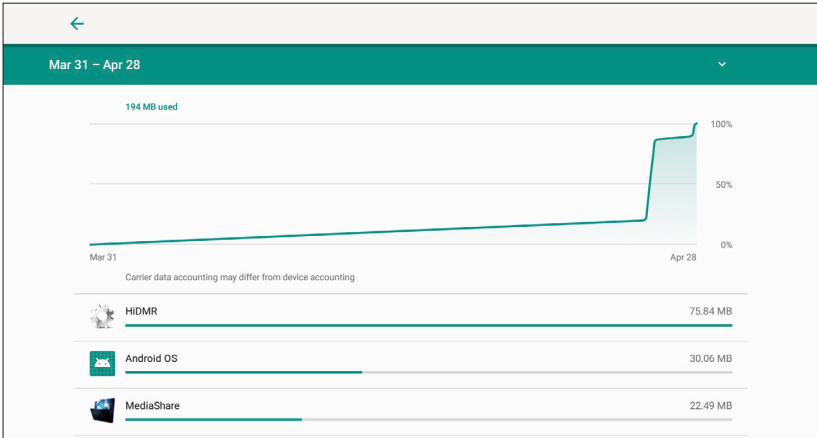
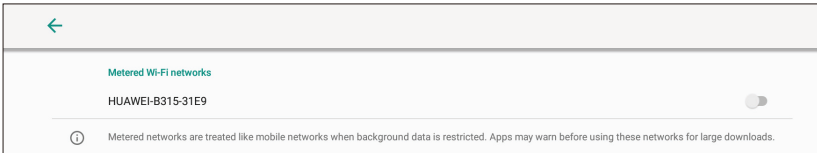
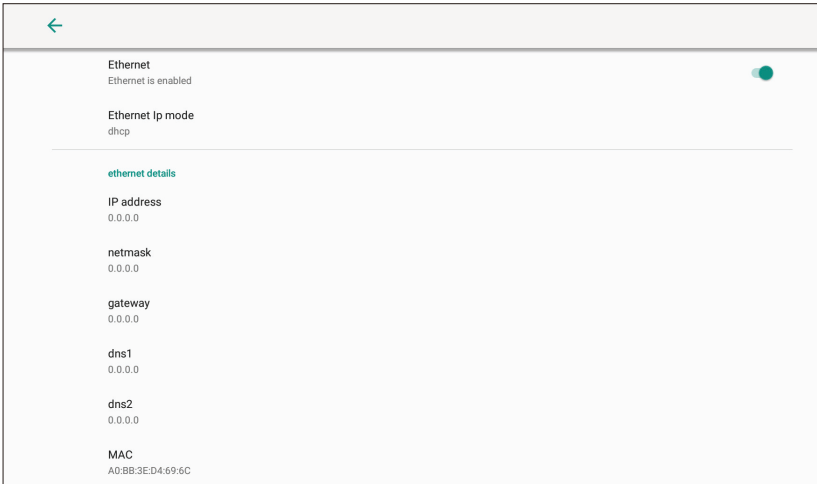
Sub-menu	Description
<p>Data Usage</p>	<p>Select Data Usage to review data usage and network restrictions.</p>  <p>Specific App's traffic can be reviewed as well in Wi-Fi Data Usage.</p>  <p>Restrictions can be placed on specific network traffic under Network Restrictions.</p> 
<p>Ethernet</p>	<p>Select Ethernet to enable/disable Ethernet, review DNS, and IP mode.</p> 

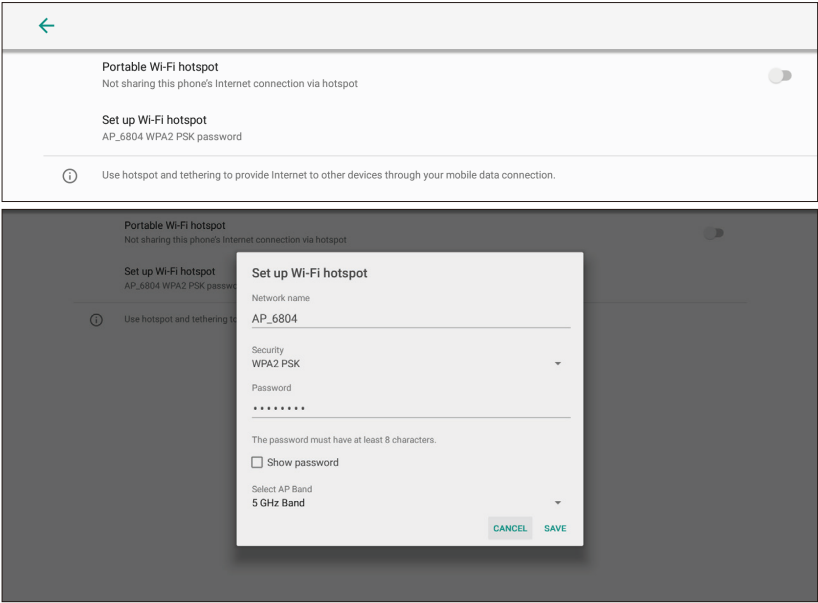
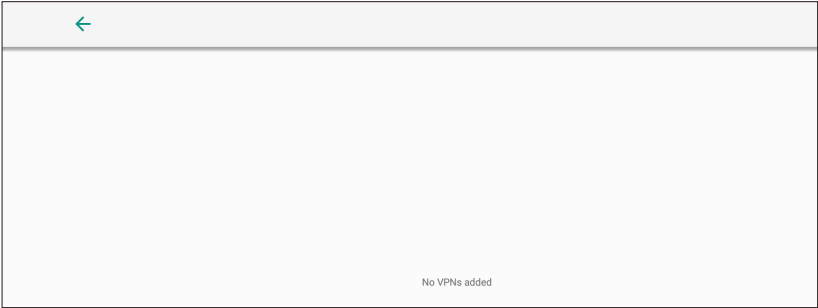
Sub-menu	Description
<p style="text-align: center;">Portable Hotspot</p>	<p>Enable/disable Portable Wi-Fi Hotspot under Portable Hotspot.</p> 
<p style="text-align: center;">VPN</p>	<p>Review and add VPNs.</p> 

Connected Devices





Enable/disable device connection, review connected devices, and search and connect to other devices.

Apps & Notifications

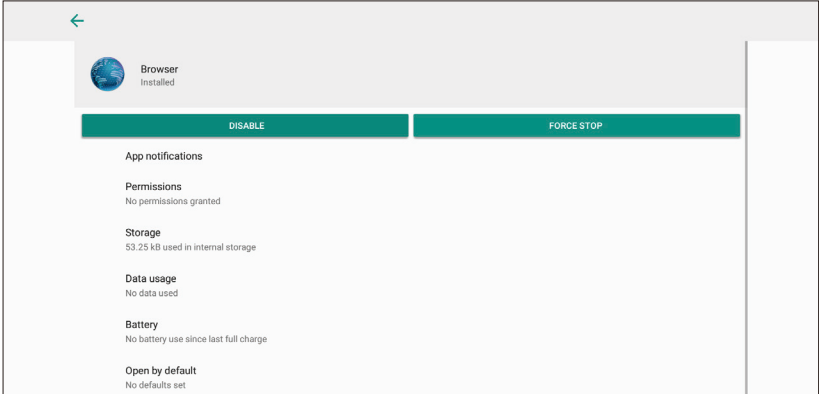

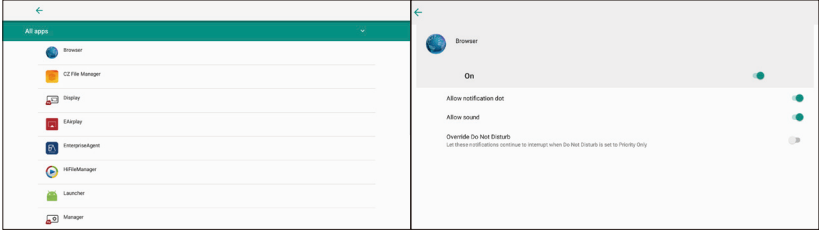
Sub-menu	Description
<p style="text-align: center;">App Info.</p>	<p>Select App Info to view installed applications and their detailed information.</p>  <p>You can also disable the app, review notifications and permissions, and adjust further settings.</p> 

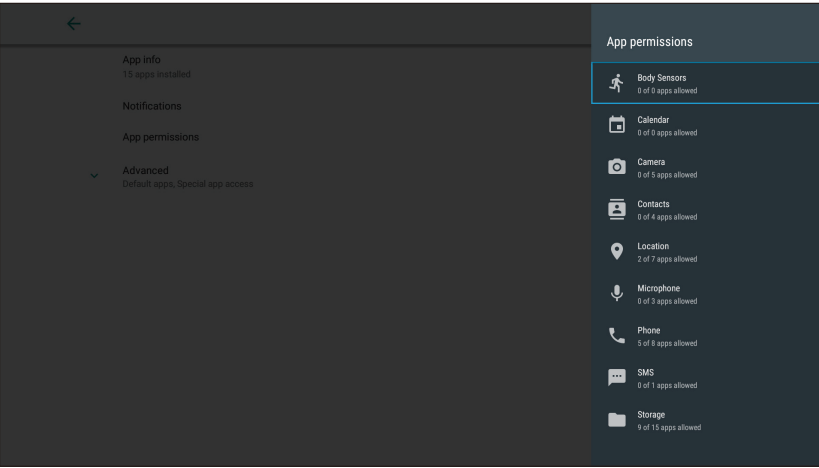
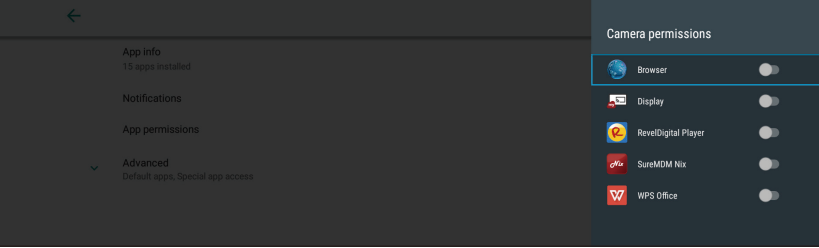
Sub-menu	Description
<p style="text-align: center;">Notifications</p>	 <p>Under Notifications, you can adjust each applications notification settings.</p>  <p>You can also allow/disallow notification dots and notifications on the lock screen.</p> 
<p style="text-align: center;">App Permissions</p>	<p>Select App Permissions to manage various application permissions.</p>  

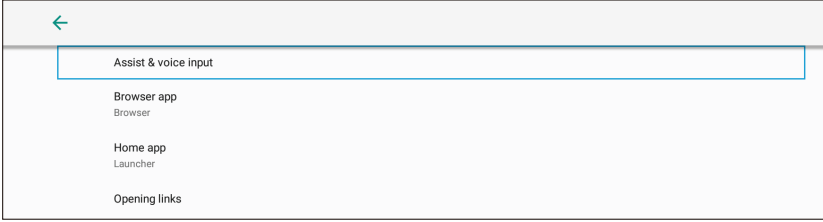
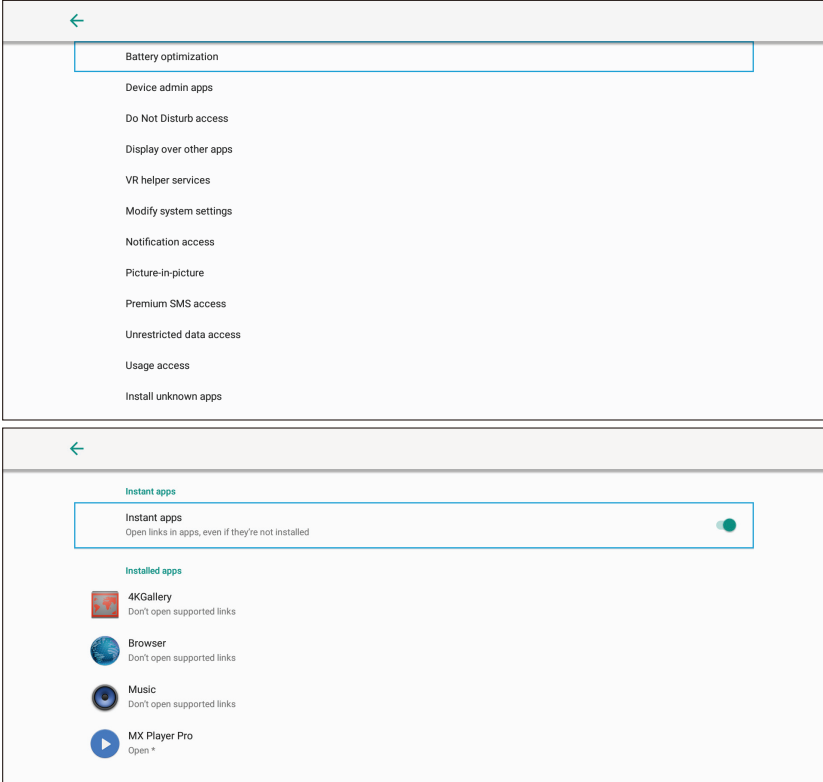
Sub-menu	Description
<p style="text-align: center;">Default Apps</p>	<p>Select your default applications.</p> 
<p style="text-align: center;">Special App Access</p>	<p>Manage additional application settings.</p> 

Display

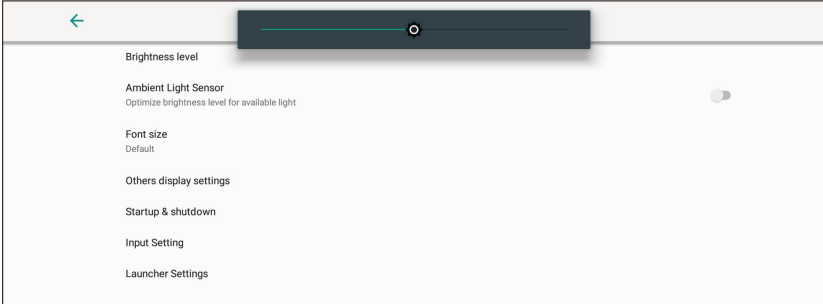
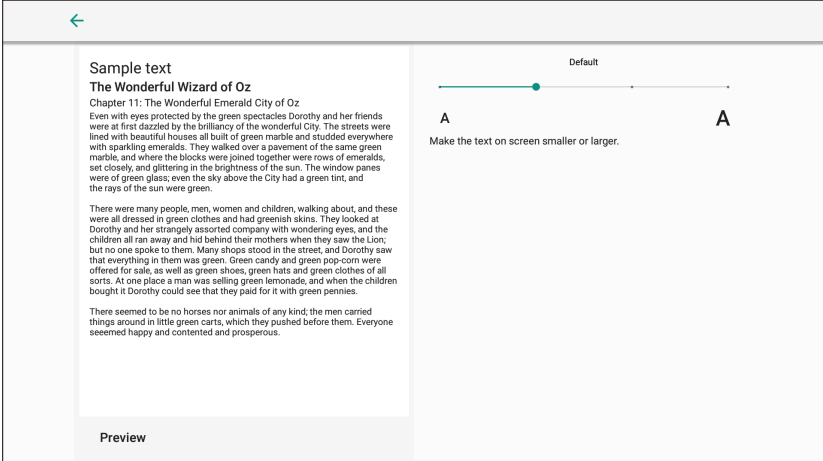

Sub-menu	Description
<p>Brightness Level</p>	<p>Adjust the brightness level by eight (8) levels.</p> 
<p>Ambient Light Sensor</p>	<p>Detects ambient light and adjusts brightness levels automatically.</p>
<p>Font Size</p>	<p>Preview and adjust the font size on the display.</p> 
<p>Others Display Settings</p>	<p>Adjust the Resolution, DPI, wallpaper and other display settings.</p>

Sub-menu	Description
<p style="text-align: center;">Startup & Shutdown</p>	<div data-bbox="592 188 1418 497" style="border: 1px solid black; padding: 10px;"> <p>Startup & shutdown Option</p> <p>Startup channel</p> <p> <input checked="" type="radio"/> Last shutdown channel <input checked="" type="radio"/> Default startup channel HOME ▾ </p> <hr/> <p>Standby Mode</p> <p> <input type="radio"/> Hibernate <input checked="" type="radio"/> Sleep </p> <hr/> <p>Splash screen</p> <p>Black ▾</p> </div> <p><u>Startup Channel</u></p> <p>Last Shutdown Channel: Start in the channel that was last used before the previous shutdown.</p> <p>Default Startup Channel: Select a specific startup channel (Home, HDMI 1/2, APP(Display), APP(vCastReceiver)).</p> <p><u>Standby Mode</u></p> <p>Hibernate: Power off the screen only.</p> <p>Sleep: Power down the display to minimal power consumption (0.5W).</p> <p><u>Splash Screen</u></p> <p>Change the boot screen to black, blue, or the ViewSonic logo.</p>
<p style="text-align: center;">Input Setting</p>	<div data-bbox="592 1099 1418 1370" style="border: 1px solid black; padding: 10px;"> <p>Input Alias Switch</p> <p>HDMI1 <input checked="" type="radio"/> display <input type="radio"/> hide</p> <hr/> <p>HDMI2 <input checked="" type="radio"/> display <input type="radio"/> hide</p> <hr/> <p>Signal Source Detect</p> <p>HDMI <input checked="" type="radio"/> Enable <input type="radio"/> Disable</p> </div> <p><u>Input Alias Switch</u></p> <p>Display or hide HDMI 1 or HDMI 2 input source.</p> <p><u>Signal Source Detect</u></p> <p>Enable or disable HDMI input detection.</p>

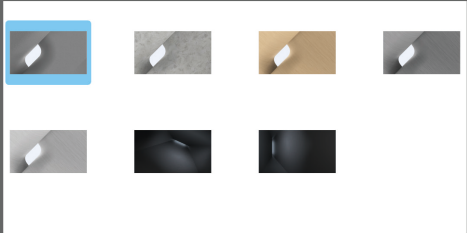
Sub-menu	Description
<p>Launcher Settings</p>	<div data-bbox="592 185 1418 380"> <p>Launcher Settings</p> <p>ViewSonic Logo <input checked="" type="checkbox"/></p> <p>Date & Time <input checked="" type="checkbox"/></p> <p>Theme</p> </div> <p><u>ViewSonic Logo</u> Display or hide the ViewSonic logo on the Home Screen.</p> <p><u>Date & Time</u> Display or hide the date and time on the Home Screen.</p> <p><u>Theme</u> Choose from seven (7) included themes for the Home Screen.</p> <div data-bbox="592 719 1418 1084"> <p>Launcher Settings</p> <p>ViewSonic Logo <input checked="" type="checkbox"/></p> <p>Date & Time <input checked="" type="checkbox"/></p> <p>Theme</p>  </div>

Sound

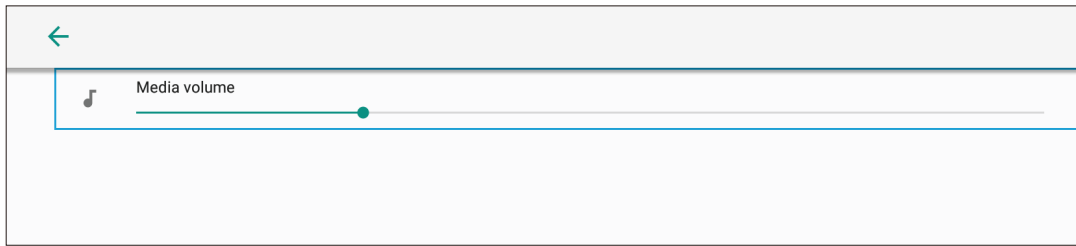

Sub-menu	Description
Media Volume	Adjust the volume level of the display.

Storage

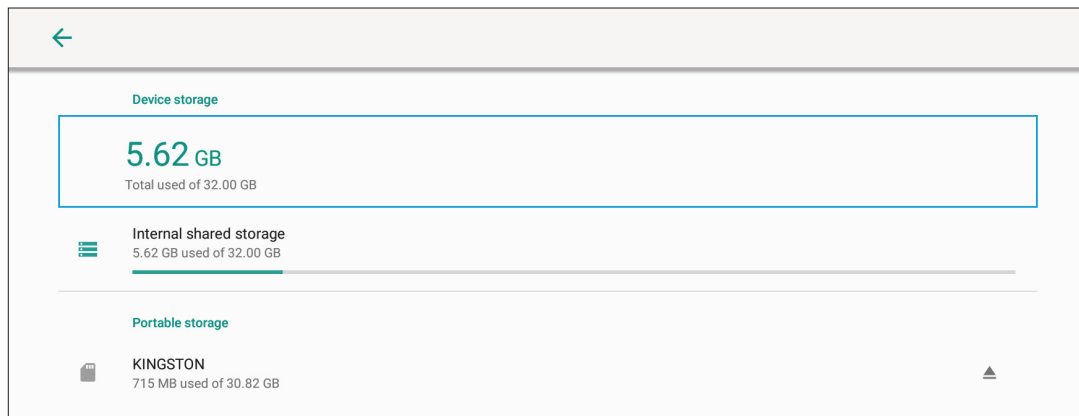

Sub-menu	Description
Device Storage	Total internal storage used.
Internal Shared Storage	Internal storage allocation.
Portable Storage	External storage device details.

System

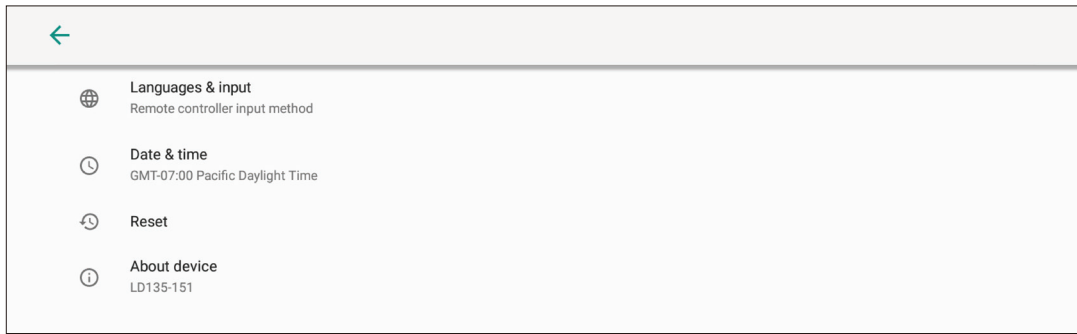

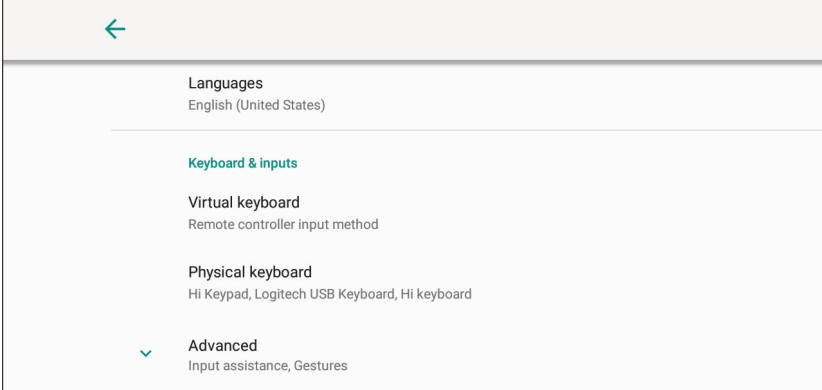
Sub-menu	Description
<p>Languages & Input</p>	 <p><u>Languages</u> Language selection.</p> <p><u>Virtual Keyboard</u> Select your input method.</p> <p><u>Physical Keyboard</u> Bluetooth and physical keyboard input settings.</p> <p><u>Advanced</u> Adjust Input Assistance, Gestures, Pointer Speed, and Text-to-Speech output.</p>

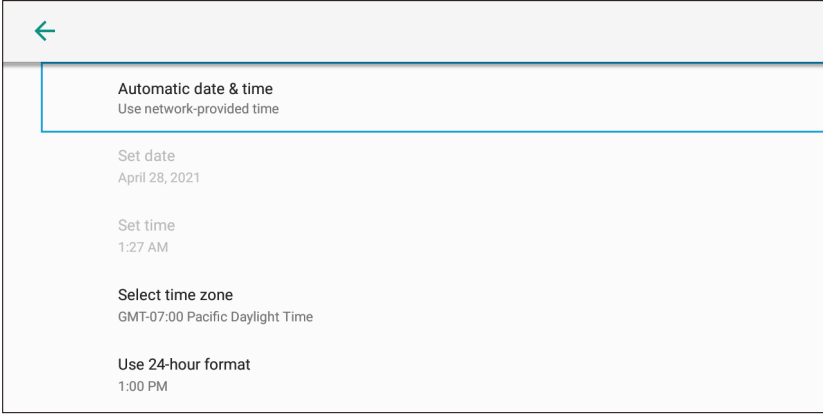
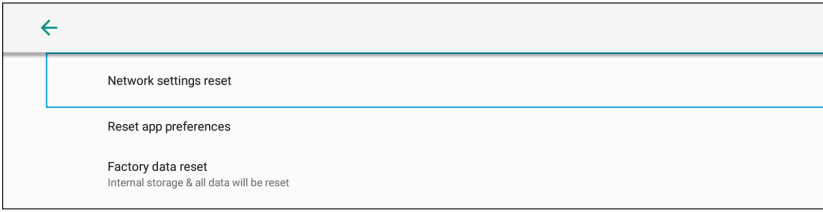
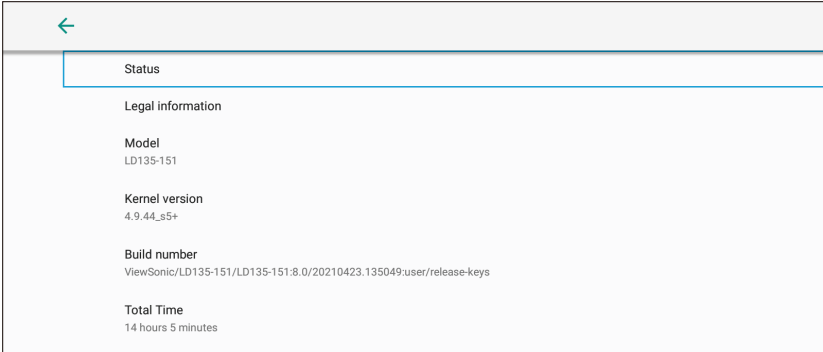
Sub-menu	Description
<p style="text-align: center;">Date & Time</p>	 <p><u>Automatic Date & Time</u> Enable or disable automatic time adjustment.</p> <p><u>Select Time Zone</u> Choose your appropriate time zone.</p> <p><u>Use 24-hour Format</u> Enable or disable 24-hour time format.</p>
<p style="text-align: center;">Reset</p>	 <p><u>Network Settings Reset</u> Reset current network settings.</p> <p><u>Reset App Preferences</u> Reset current app preferences.</p> <p><u>Factory Data Reset</u> Restore the display to default factory settings.</p>
<p style="text-align: center;">About Device</p>	<p>View information about the display.</p> 

Upgrade

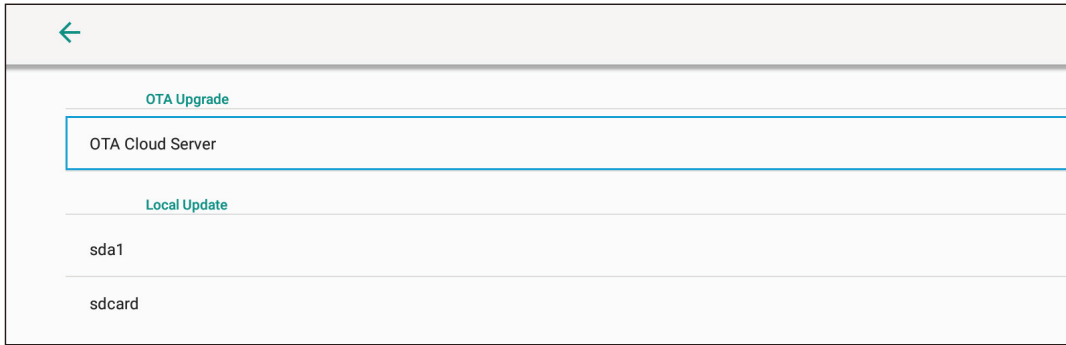

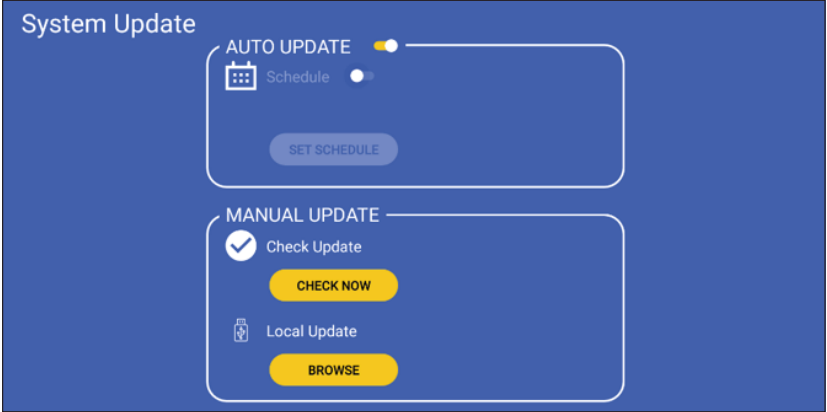
Sub-menu	Description
<p>OTA Upgrade</p>	 <p><u>Auto Update</u> Automatically apply updates as they become available or schedule the default update date and choose “Hibernate” as the Standby Mode, and the system will automatically update the schedule after shutdown.</p> <p><u>Manual Update</u> Check Update: The system will check for the latest FW automatically. If a new FW version is found, confirm the new FW is needed and then manually run the update. Local Update: Plug in a USB drive with the FW update in .zip format and run the .zip file to update the FW.</p>

On-Screen Display (OSD) Menu

Use the On-Screen Display (OSD) Menu to adjust settings.

NOTE: The OSD Menu is only available when there is an active input source, e.g. HDMI.



To open and operate the OSD Menu:

1. Press the **MENU** button on the remote control.
2. Press **▼/▲/◀/▶** on the remote control to select menu items or adjust values.
3. Press **OK** to confirm your selection.
4. Press the **RETURN** button to go back to the previous menu level.
5. Press the **MENU** button to exit the OSD Menu.

On-Screen Display (OSD) Menu Tree

Main Menu	Sub-menu	Menu Option	
Picture	Picture Mode	Mode	Standard
			Vivid
			Soft
			User
		Brightness	(-/+ , 0~100)
	Advanced	Color Temp	Standard
			Cool
			Warm
		Noise Reduction	Off
			Low
			Middle
			High
		PC Mode	PC
			Video
Auto			
Picture Reset			
Sound	Sound Mode	Sound Mode	Standard
			News
			Music
			Movie
			Sports
			User
		EQ_120Hz	(-/+ , 0~100)
		EQ_500Hz	(-/+ , 0~100)
		EQ_1.5KHz	(-/+ , 0~100)
		EQ_5KHz	(-/+ , 0~100)
		EQ_10KHz	(-/+ , 0~100)
	Advanced	Balance	(-/+ , -50~50)
		Audio Reset	

Main Menu	Sub-menu	Menu Option		
Time	Time Setup	Time Setting	Date Picker	
		Shutdown Time	Repeat: Off/Once/Every day/ Workday	
			Time	
		Power ON Time	Repeat: Off/Once/Every day/ Workday	
			Time	
			Source	HDMI 1 HDMI 2
		Sleep Timer	Off/1/10/20/30/60/90/120/ 180/240 min	
		Power Saving	Off/1/3/5/10 min	
		Time Sync	Network Time	
			Off	
Time Zone	Shanghai/Calcutta/Harare/Karachi/ Brazzaville/Beirut/Jerusalem/Tehran/ Baghdad/Ulaanbaatar/Damascus/ Sydney/Paris/Rome/London/Dubai/ Tokyo/US-PT			
NetWork	Ethernet Setting	Ethernet Switch	Off	
			On	
		Connection Mode	DHCP IP	
			Static IP	
	Network Status			
	WiFi Setting	WiFi Switch	Off	
			On	
		WiFi List	Scan WiFi List	
Add WiFi network				
Network Staus				
Update	Local Update	SD Card		

Main Menu	Sub-menu	Menu Option		
Advanced	Language	Menu Language	English	
			Français	
			Español	
			Deutsch	
			Русский	
			Dutch	
			繁體中文	
			简体中文	
			Turkish	
	Arabic			
	Restore		Restore Setting	
			Restore Default	
	About System		CPU	
			GPU	
			Memory	
Device Space				
OS Version				
Software Version				

Menu Options

Picture

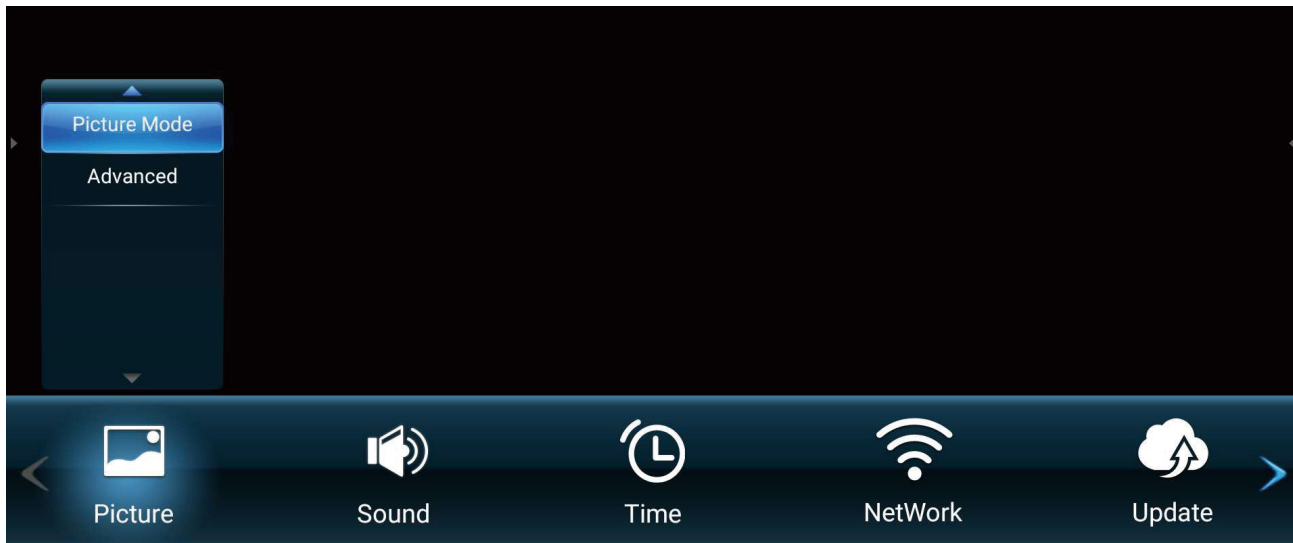

1. Press **MENU** on the remote control to display the OSD Menu.
2. Then press **OK** or use **▼/▲/◀/▶** on the remote control to select the **Picture** menu.
3. Press **▼/▲** to select the menu option. Then press **OK** to display its sub-menu, or press **◀/▶** to adjust/select the setting.

NOTE: Some sub-menu options may have another sub-menu layer.

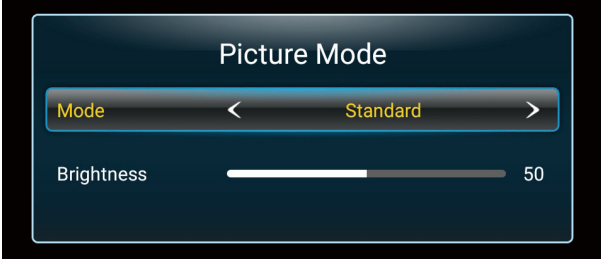
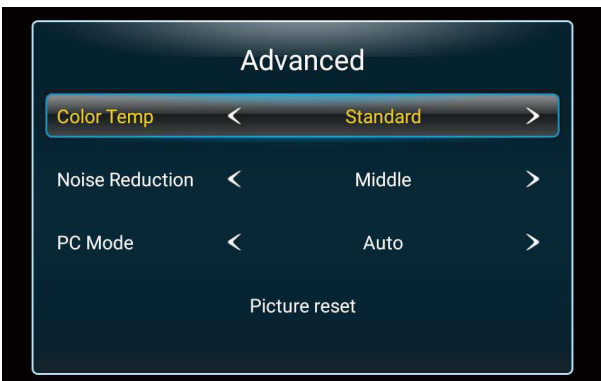
Menu Option	Description
Picture Mode	 <p><u>Standard</u> For normal indoor ambient light intensity.</p> <p><u>Vivid</u> Higher brightness level. For bright, indoor areas.</p> <p><u>Soft</u> For dark environments. Lower brightness level.</p> <p><u>User</u> Custom user setting.</p> <p><u>Brightness</u> Adjust the black levels of the screen image.</p>
Advanced	 <p><u>Color Temp</u></p> <ul style="list-style-type: none"> • Standard: Default standard. • Cool: Set the color temperature to 7500K. • Warm: Set the color temperature to 5000K. <p><u>Noise Reduction</u> Reduce image noise and distortion. Not available for HDMI input.</p> <p><u>PC Mode</u></p> <ul style="list-style-type: none"> • Auto: Automatically detect input source. • PC: Set the input source to PC. • Video: Set the input source to Video. <p><u>Picture Reset</u> Restore the settings to default.</p>

Sound

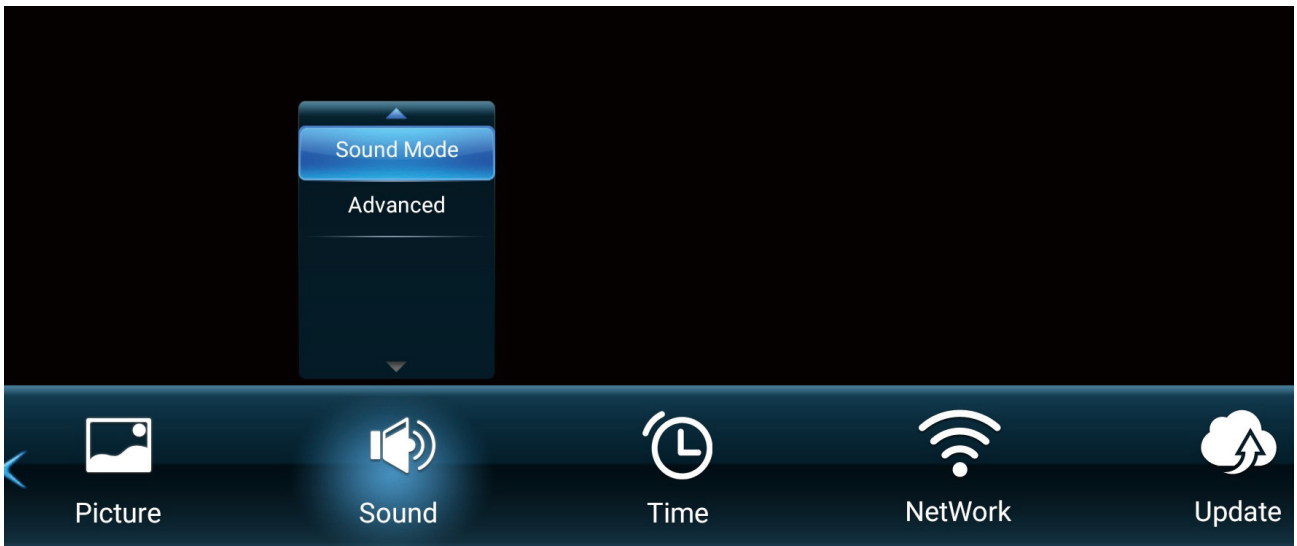

1. Press **MENU** on the remote control to display the OSD Menu.
2. Then press **OK** or use **▼/▲/◀/▶** on the remote control to select the **Sound** menu.
3. Press **▼/▲** to select the menu option. Then press **OK** to display its sub-menu, or press **◀/▶** to adjust/select the setting.

NOTE: Some sub-menu options may have another sub-menu layer.

Menu Option	Description
Sound Mode	<div data-bbox="644 188 1248 705" data-label="Image"> <p>The screenshot shows the 'Sound Mode' menu with a title bar. Below the title bar is a slider for 'Sound Mode' set to 'Standard'. Below that are five EQ sliders, each labeled with a frequency and a value of 50: EQ_120Hz, EQ_500HZ, EQ_1.5KHZ, EQ_5KHZ, and EQ_10KHZ.</p> </div> <p><u>Standard</u> Balanced sound quality and effects. Ensures a natural sound presentation.</p> <p><u>News</u> Reduce the bass and treble, improve voice clarity.</p> <p><u>Music</u> Vibrant treble and stronger bass.</p> <p><u>Movie</u> Enhance the sense of space.</p> <p><u>Sports</u> Enhanced focus on dialogue and speech.</p> <p><u>User</u> Customize the audio equalizer.</p>
Advanced	<div data-bbox="644 1344 1248 1630" data-label="Image"> <p>The screenshot shows the 'Advanced' menu with a title bar. Below the title bar is a slider for 'Balance' set to 0. Below the slider is the text 'Audio reset'.</p> </div> <p><u>Balance</u> Adjust the audio balance from -50~50.</p> <p><u>Audio Reset</u> Restore the settings to default.</p>

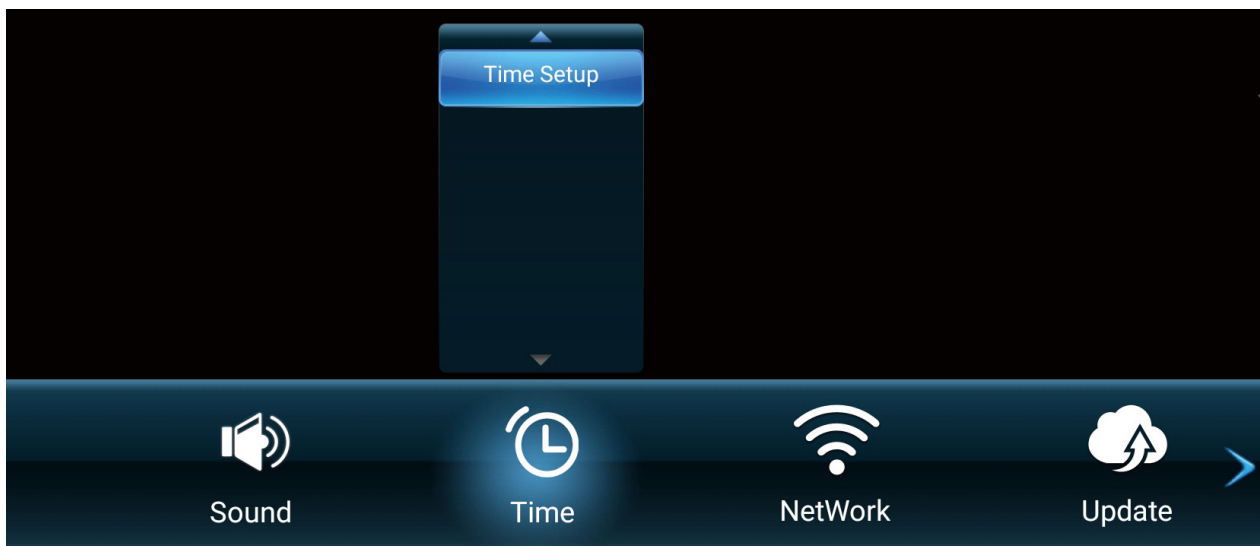

Time

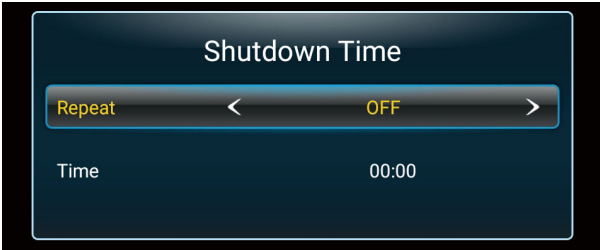

1. Press **MENU** on the remote control to display the OSD Menu.
2. Then press **OK** or use **▼/▲/◀/▶** on the remote control to select the **Time** menu.
3. Press **▼/▲** to select the menu option. Then press **OK** to display its sub-menu, or press **◀/▶** to adjust/select the setting.

NOTE: Some sub-menu options may have another sub-menu layer.

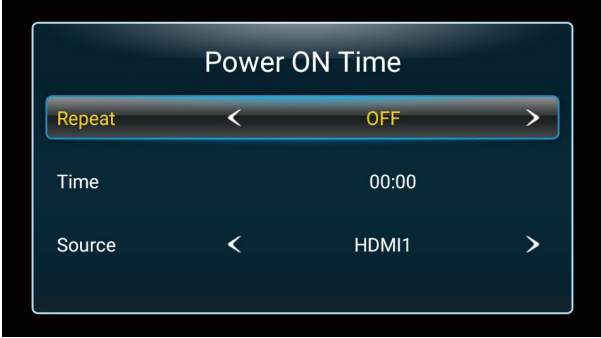
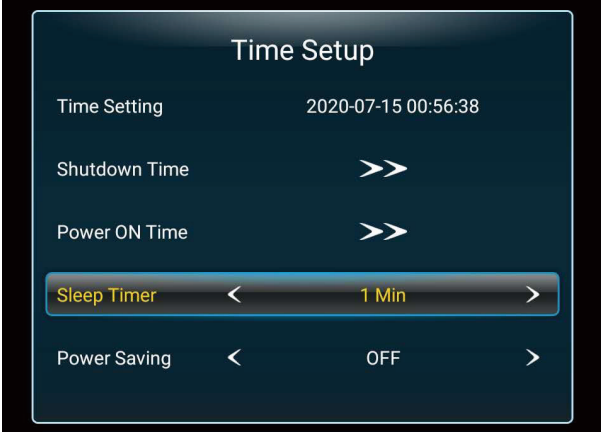
Menu Option	Description
Time Setting	 <p>Set the time and date.</p>
Shutdown Time	 <p>Schedule a shutdown time and frequency.</p>

Menu Option	Description
Power ON Time	 <p>Schedule a power on time and frequency and tie to the input source.</p>
Sleep Timer	 <p>Set a specific time for the display to enter stand-by mode.</p>
Power Saving	 <p>Set a specific time for the display to enter stand-by mode after no input source is detected.</p>

Menu Option	Description
<p>Time Sync</p>	<div data-bbox="644 188 1248 613" data-label="Image"> <p>The screenshot shows a 'Time Setup' menu with the following options: 'Power ON Time' with a right arrow, 'Sleep Timer' with left and right arrows and 'OFF' in the center, 'Power Saving' with left and right arrows and 'OFF' in the center, and 'Time Sync' with left and right arrows and 'OFF' in the center. The 'Time Sync' option is highlighted with a blue bar at the bottom.</p> </div> <p>Toggle network synchronization On or Off.</p>
<p>Time Zone</p>	<div data-bbox="644 694 1248 1128" data-label="Image"> <p>The screenshot shows a 'Time Setup' menu with the following options: 'Power ON Time' with a right arrow, 'Sleep Timer' with left and right arrows and 'OFF' in the center, 'Power Saving' with left and right arrows and 'OFF' in the center, and 'Time Sync' with left and right arrows and 'network Time' in the center. The 'Time Zone' option is highlighted with a blue bar at the bottom, showing 'Paris' as the selected value.</p> </div> <p>Select the appropriate time zone for your area.</p>

NetWork

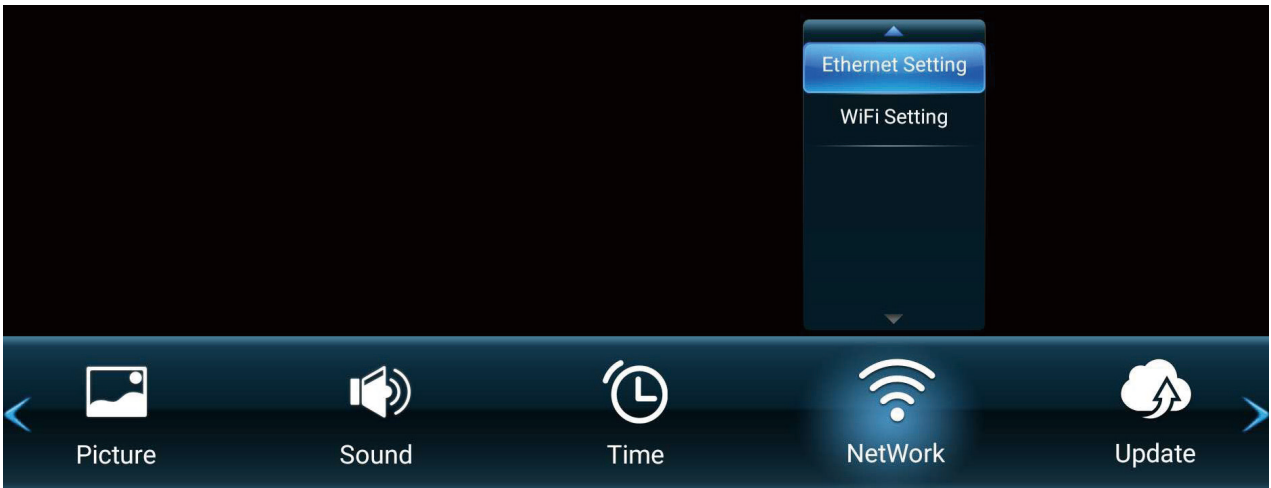

1. Press **MENU** on the remote control to display the OSD Menu.
2. Then press **OK** or use **▼/▲/◀/▶** on the remote control to select the **NetWork** menu.
3. Press **▼/▲** to select the menu option. Then press **OK** to display its sub-menu, or press **◀/▶** to adjust/select the setting.

NOTE: Some sub-menu options may have another sub-menu layer.

Menu Option	Description
<p>Ethernet Setting</p>	<div data-bbox="644 1093 1248 1411" data-label="Image"> </div> <p><u>Ethernet Switch</u> Toggle the wired network connection On or Off.</p> <p><u>Connection Mode</u> Select the network connection method, DHCP IP or Static IP.</p> <div data-bbox="730 1608 1161 1899" data-label="Image"> </div> <p>NOTE: If Manual IP is selected, you need to configure the IP, Netmask, Gateway, and DNS.</p> <p><u>Network Status</u> View the network connection status.</p>

Menu Option	Description
WiFi Setting	<div data-bbox="644 188 1248 504" data-label="Image"> </div> <p data-bbox="485 517 651 551"><u>WiFi Switch</u></p> <p data-bbox="485 557 1011 591">Toggle the WiFi connection On or Off.</p> <p data-bbox="485 613 606 647"><u>WiFi List</u></p> <p data-bbox="485 654 1214 687">View the available Wi-Fi networks, or add manually.</p> <p data-bbox="485 710 703 743"><u>Network Status</u></p> <p data-bbox="485 750 1002 784">View the network connection status.</p> <div data-bbox="697 801 1193 1162" data-label="Image"> </div>

Update

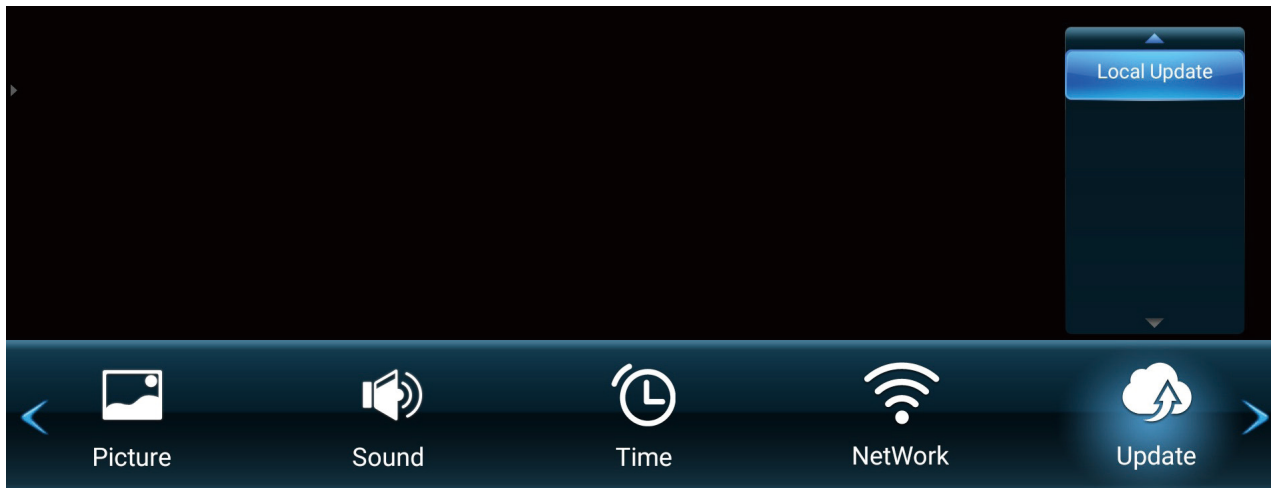

1. Press **MENU** on the remote control to display the OSD Menu.
2. Then press **OK** or use **▼/▲/◀/▶** on the remote control to select the **Update** menu.
3. Press **▼/▲** to select the menu option. Then press **OK** to display its sub-menu.

Menu Option	Description
Local Update	Update the display by using the update file on an SD Card or USB flash drive.

Advanced

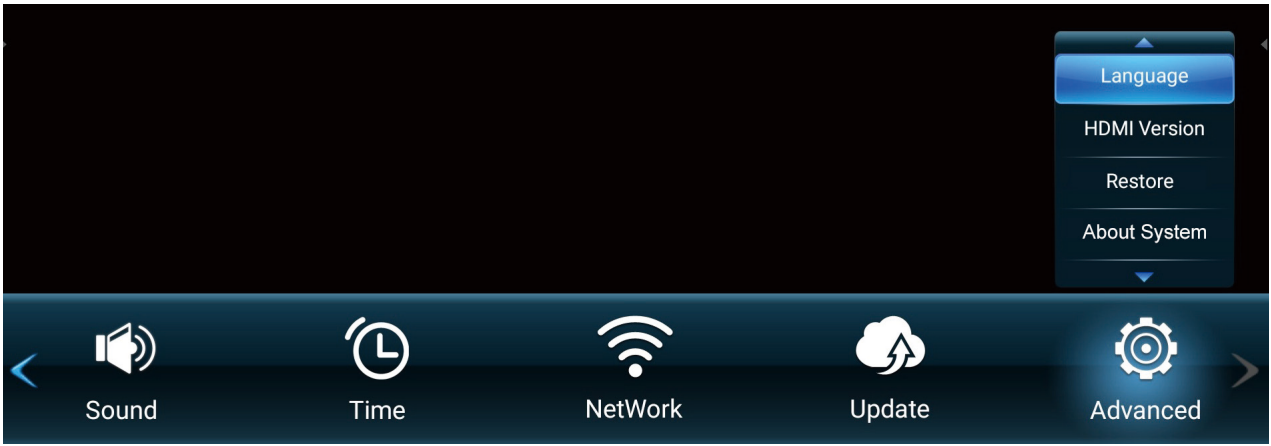

1. Press **MENU** on the remote control to display the OSD Menu.
2. Then press **OK** or use **▼/▲/◀/▶** on the remote control to select the **Advanced** menu.
3. Press **▼/▲** to select the menu option. Then press **OK** to display its sub-menu, or press **◀/▶** to adjust/select the setting.

NOTE: Some sub-menu options may have another sub-menu layer.

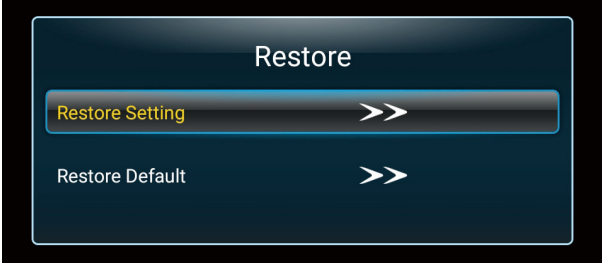
Menu Option	Description
Language	 <p><u>Menu Language</u> Set the OSD Menu language.</p>
Restore	 <p><u>Restore Setting</u> Reset the OSD settings.</p> <p><u>Restore Default</u> Restore to factory default settings.</p> <p>NOTE: All settings will be reset to default, including any additional APPs installed by the user.</p>

Menu Option	Description
About System	<div data-bbox="644 188 1248 705" data-label="Image"> <p>The screenshot shows a dark-themed window titled 'About System'. It lists the following information:</p> <ul style="list-style-type: none"> CPU: 4 Core GPU: 2 Core Memory: 3.74 G Device Space: 24.77 G OS Version: 8.0.0 Software Version: VS_V811_LD216-251_20200831 </div> <p data-bbox="483 719 1382 840">View system information such as: CPU core count, GPU core count, Memory used, Storage Space remaining, OS version, and Software version.</p>

> Embedded Applications

ViewBoard Cast

Working with ViewBoard® Cast software, the vCastReceiver app, will allow the LED display to receive vCastSender screen sharing (Windows/Mac/Chrome) and mobile (iOS/Android) users' screens, photos, videos, annotations, and camera(s).

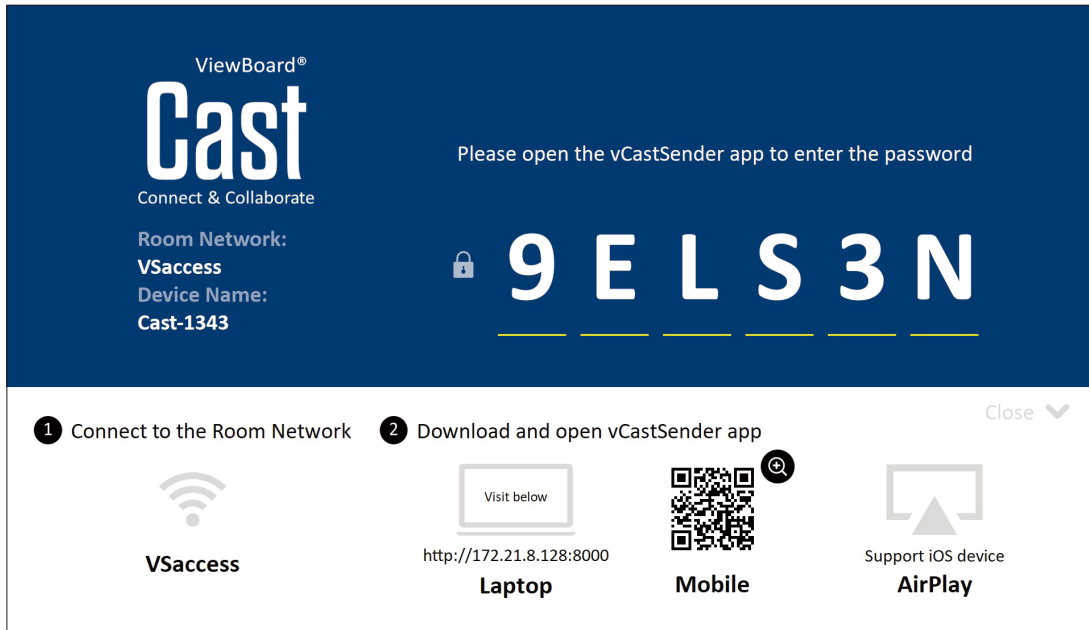

Network Information

- ViewBoard® Cast software, laptops, and mobile devices can be connected to the same subnet and across the subnet as long as it can communicate between the two.
- Connected devices will show up under “Device List” on the same subnet connection.
- If the device does not show up under “Device List”, users will need to key-in the on-screen PIN-code.

ViewBoard Cast is a wireless peer to peer data communication, therefore the following port settings are required:

Ports:

- CP: 56789, 25123, 8121, and 8000
- UDP: 48689 and 25123

Port and DNS activation:

- Port: 8001
- DNS: h1.ee-share.com

Cast Sender from Windows-based Devices, Macbook, and Chrome devices.

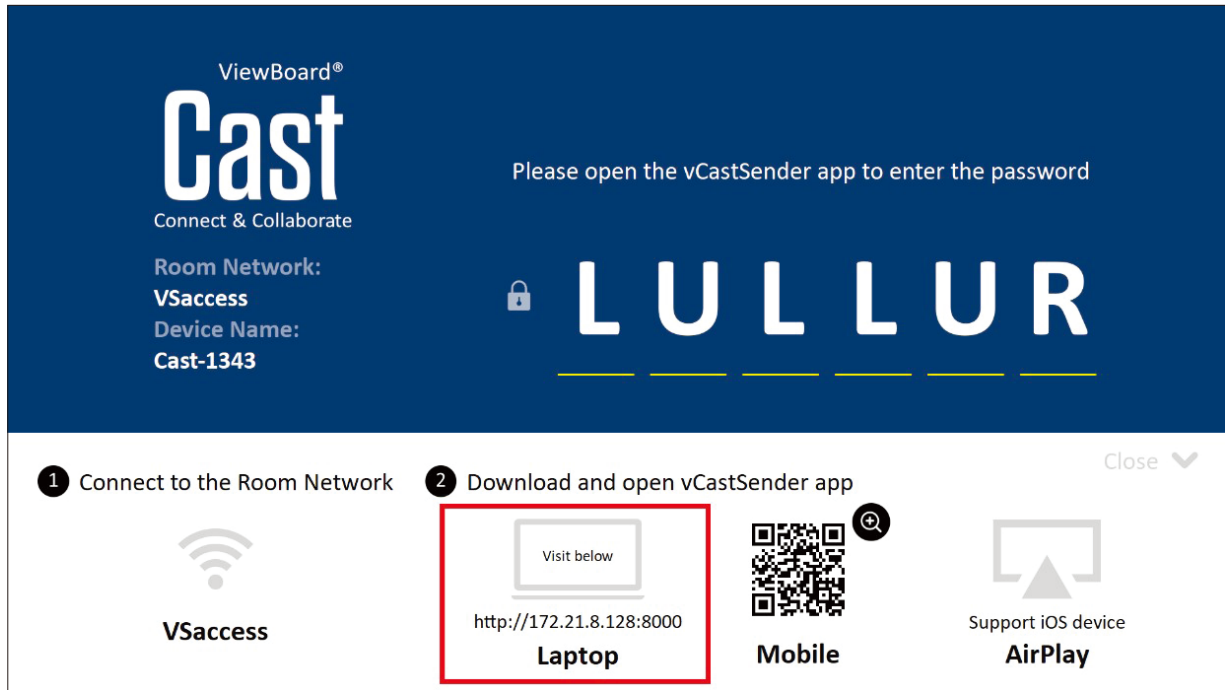

Mac, Windows, Chrome Devices:

1. Make sure your device is connected to the same network as the display.
2. Open a web browser and enter the address that is shown on the display to download the application.
3. Launch the application and click the connect icon next to the Device Name.

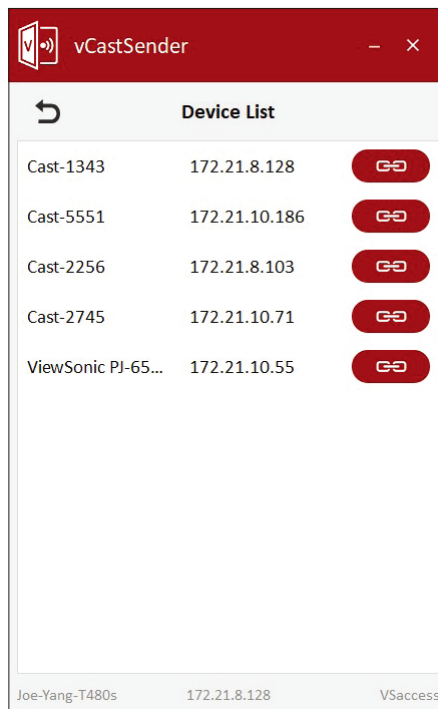

NOTE: If the device is not listed, click **Connect with PIN-Code** and input the pin-code displayed on the display.

Cast Sender from Mobile Devices: iOS-based (iPhone, iPad) and Android OS based phone/tablet.

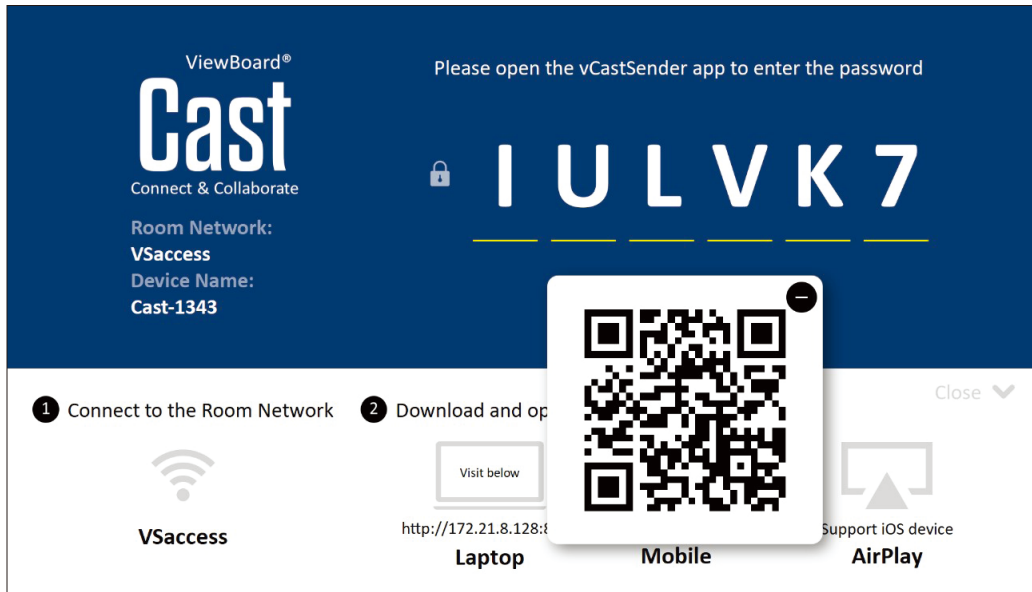

Android/iOS:

1. Make sure your device is connected to the same network as the display.
2. Scan the QR Code that is shown on the display to download the client application directly from the server, or download from the Google Play Store or the Apple Store.
3. Launch the application and select the correct Device Name and input the pin to connect. You can also directly input the pin-code displayed on the display to connect.





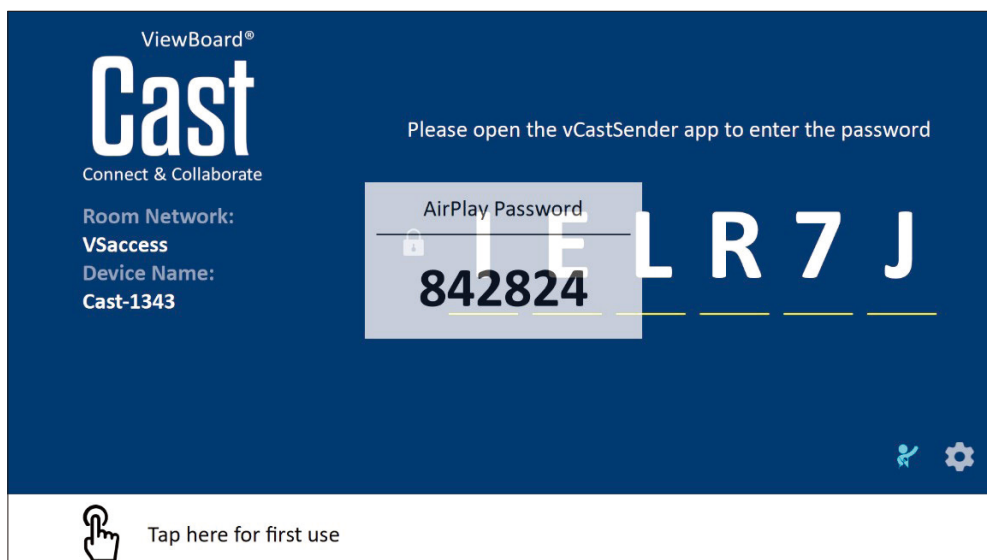

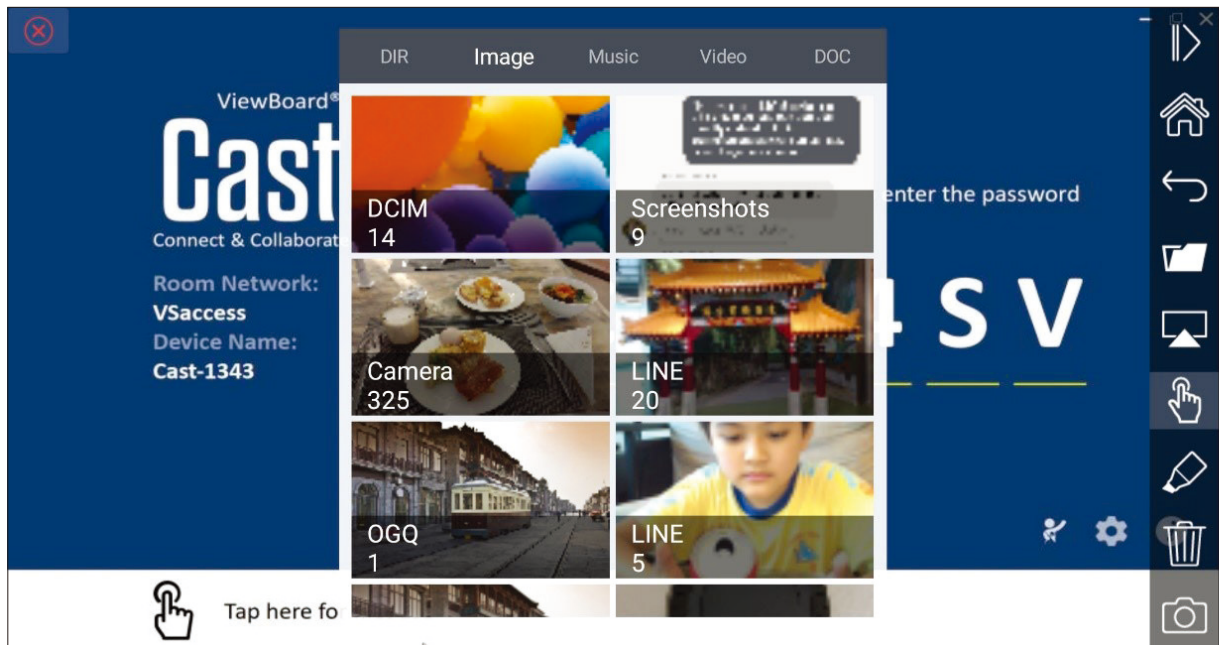

Apple AirPlay®:

1. Make sure your device is connected to the same network as the display.
2. Directly open AirPlay and select the Device Name to connect.
3. Another “AirPlay Password” will be generated on-screen for the connection.



Cast Out from a Mobile Device that Supports Annotation



Item	Description
 Toggle	Click to hide or display tool bar
 Home	Click to return to the Home interface
 Return	Click to return to previous operation interface
 Folder	Click to view or open the mobile device's internal file
 Screen sharing	Click to share screen (Android 5.0 and above supported)
 Touch	Click to change to touch mode
 Pen	Click to make annotations, and to change color and thickness
 Clear	Click to clear everything on the screen
 Camera	Click to use the camera and send the image to the ViewBoard

vSweeper

Remove unnecessary data and unwanted files.

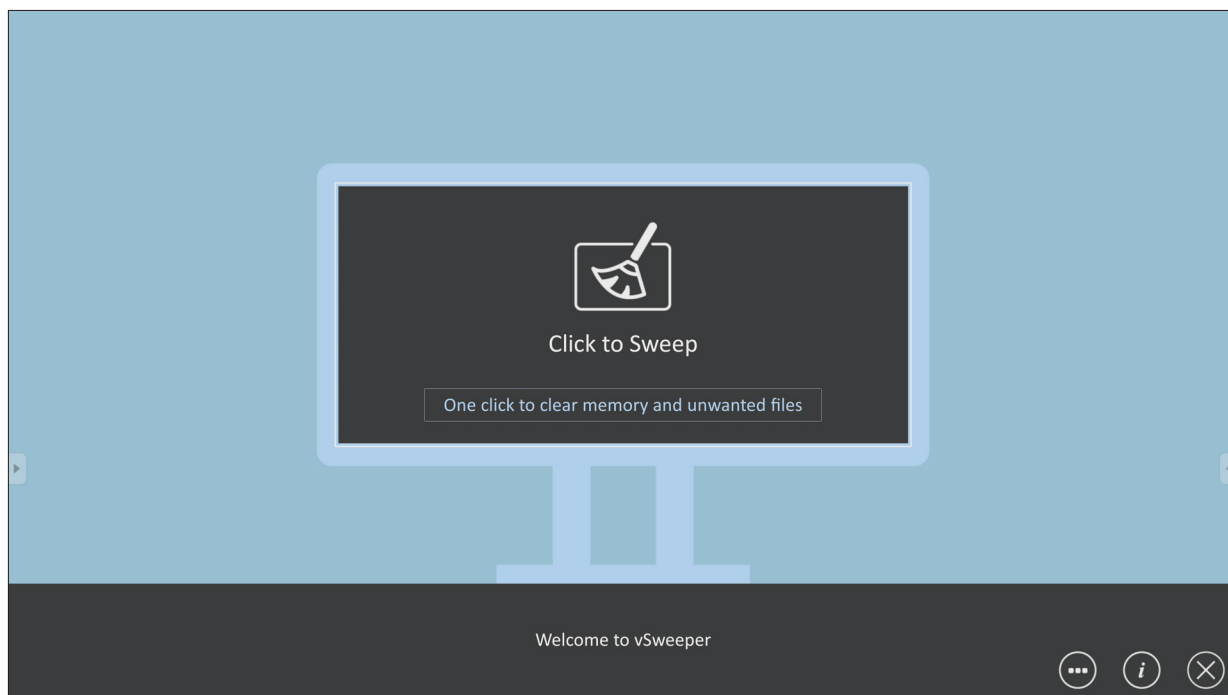

Advanced Settings can also be customized to the user's needs.



Browser

Web browser for surfing the Internet.

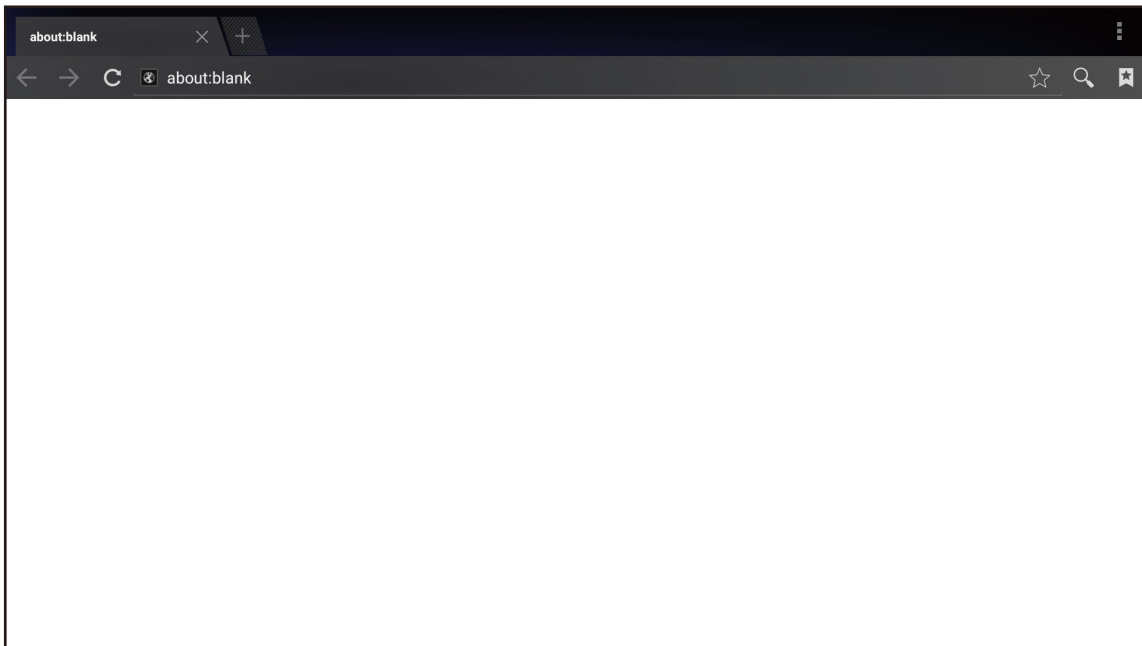

WPS Office

Create, edit, and view Documents, Memos, Presentations, and Spreadsheets.

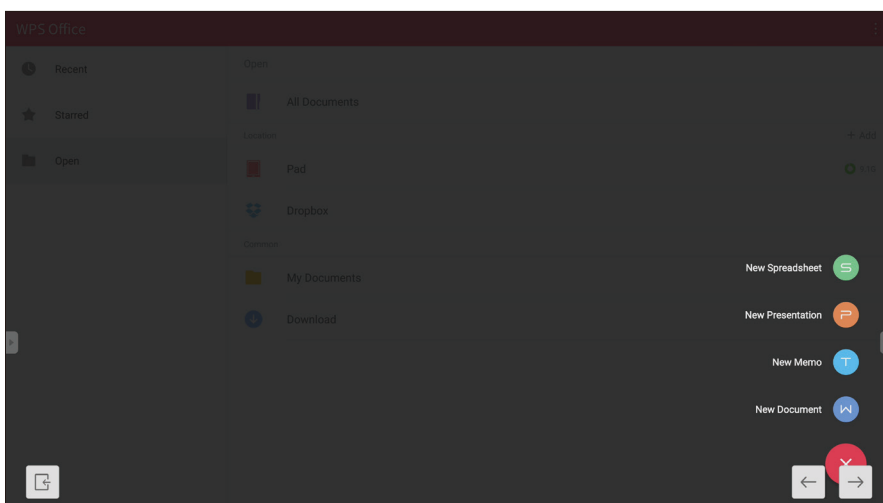
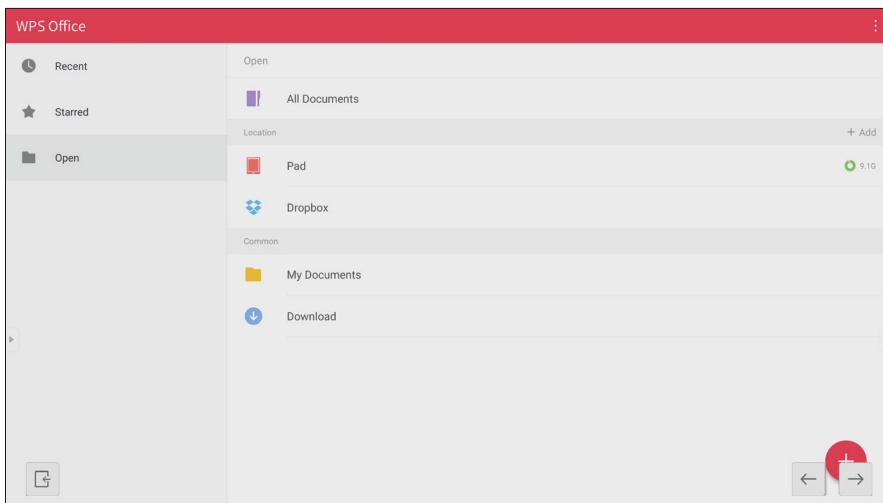

> Appendix

Specifications

Item	Category	Specifications
Model		LDM216-251
LED Screen	Type	Direct View LED Display
	Size	216"
	Active Size	188.98" (H) x 106.3" (V) 4800 mm (H) x 2700 mm(V)
	Pitch Size	2.5 mm
	Resolution	FHD, 1920 x 1080
	Refresh Frequency	3840Hz
	Contrast Ratio	6000:1 (Typical)
	Brightness	100-600 cd/m2 (8 levels of adjustments)
	LED Lifespan	100,000 hours
Input Signal		2 x HDMI (1920 x 1080 @ 60Hz, HDCP 1.4) 1 x LAN (RJ45) 1 x USB Type A (3.0) 2 x USB Type A (2.0)
Output Signal		1 x HDMI (1080p @ 60Hz) 1 x Audio Out (3.5 mm) 1 x USB Type B (for debug) 1 x USB Type A (Power)[5V/1A x 1; 5V/0.5A x 2]
Speaker Output		5W x 2 Stereo
RS-232		RS-232 Serial Control
Power	Voltage	100-120V/30A ~ 50/60Hz
		220-240V/15A ~ 50Hz (vary by country)
Operating Conditions	Temperature	32° F to 104° F (0° C to 40° C)
	Humidity	20%~80% non-condensing
	Altitude	≤ 6,562 ft (2,000 m)
Storage Conditions	Temperature	-4° F to 140° F (-20° C to 60° C)
	Humidity	10%~90% non-condensing
	Altitude	≤ 6,562 ft (2,000 m)
Physical Dimensions (W x H x D)	w/o Wall Mount	4820.95 x 2818.45 x 35 mm (189.8" x 110.96" x 1.38")
	w/ Wall Mount	4820.95 x 2818.45 x 56 mm (189.8" x 110.96" x 2.2")
Weight	Physical	340 kg (749.57 lb)
Power Consumption	On	3,430W (Normal) 4,900W (Max)
	Sleep	<0.5W
	Off	<0W

NOTE: Product specifications are subject to change without notice.

LED Display Stuck Pixel Definition

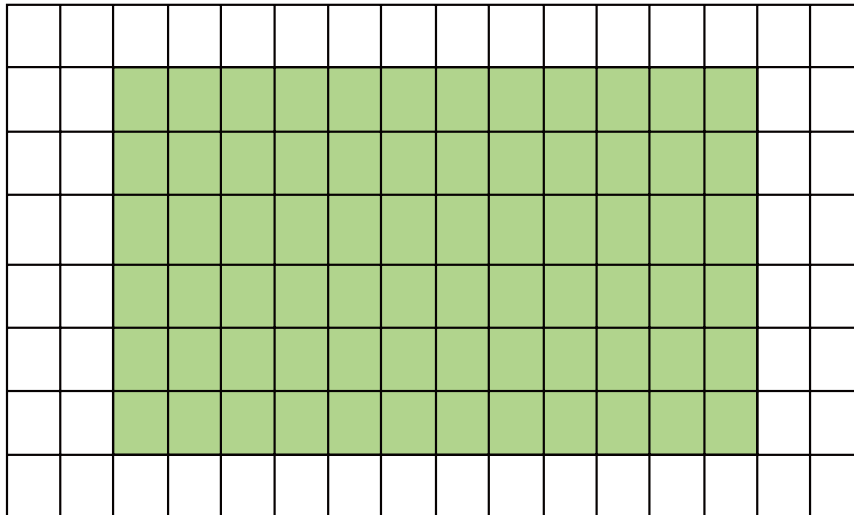

Item	Acceptance Criteria
Stuck Pixel (whole display)	≤ 60 stuck pixels
Stuck Pixel (as marked in green)	≤ 18 stuck pixels
Stuck Pixel (Single Module)	≤ 5 stuck pixels

Timing Chart

HDMI (PC)

Resolution	Refresh Rate (Hz)
640 x 480	60, 72, 75
720 x 400	70, 85
800 x 600	56, 60, 72, 75
832 x 624	75
1024 x 768	60, 70, 75
1152 x 864	60, 70, 75
1152 x 870	75
1280 x 720	60
1280 x 960	60
1280 x 1024	60, 75
1360 x 768	85
1440 x 900	60
1680 x 1050	60
1600 x 1200	60, 70, 75
1920 x 1080	60
1920 x 1200	60

HDMI (Video)

Video	Resolution	Refresh Rate (Hz)
480i	720 x 480	60
	1440 x 480	60
576i	720 x 576	50
	1440 x 576	50
480p	720 x 480	60
576p	720 x 576	50
	1440 x 576	50
720p	1280 x 720	60
1080i	1920 x 1080	50, 60
1080p	1920 x 1080	24, 25, 30, 50, 60

NOTE:

- The computer text quality is optimal in HD 1080 mode (1920 x 1080, 60Hz).
- Your computer display screen might appear different depending on the manufacturer and your operating system.
- Consult your computer's instructional manual on how to connect to an external display.
- If a vertical and horizontal frequency-select mode exists, select 60Hz (vertical) and 67.5KHz(horizontal). In some cases, abnormal signals (such as stripes) might appear on the screen when the computer power is turned off (or if the computer is disconnected). If this is the case, press the [INPUT SOURCE] button to enter the video mode and supply an active signal.
- The display timings conform to VESA and CTA standards.
- For 4:3 content, the screen will display them in the center of the screen and maintain a 4:3 aspect ratio.
- The optimal vertical frequency for each mode is 60Hz.

Supported Media Formats

Multimedia Codec Formats

Type	File Type	Codec	Ability
Photo	PNG		Max Resolution: 8000 × 8000 Min Resolution : 4 x 4
	JPEG/JPG		Max Resolution: 8000 × 8000 Min Resolution : 4 x 4 ¹
Video	.3gp	H.263	Max Resolution: 1920 x 1080 30 Audio: AMR_NB
		MPEG-4	Max Resolution: 1920 x 1080 30 Audio: AMR_NB
	.avi	MPEG-2/4	Max Resolution: 1920 x 1080 30 Audio: MPEG_Audio_Layer3
		MJPEG	Max Resolution: 1920 x 1080 30 Audio: MPEG_Audio_Layer3
	.flv	H.264	Max Resolution: 1920 x 1080 30 Audio: AAC 2.0
	.mkv	H.264	Max Resolution: 1920 x 1080 30 Audio: AAC 2.0
		H.265	Max Resolution: 1920 x 1080 30 Audio: AAC 2.0
	.mp4	H.264	Max Resolution: 3840 x 2160 30 Audio: MPEG_Audio_Layer3
		H.265	Max Resolution: 3840 x 2160 30 Audio: MPEG_Audio_Layer3
		MPEG-4	Max Resolution: 1920 x 1080 30 Audio: MPEG_Audio_Layer3
	.vob	MPEG-2	Max Resolution: 1920 x 1080 30 Audio: PCM
	.mpg/.mpeg	MPEG-2	Max Resolution: 1920 x 1080 30 Audio: MPEG_Audio_Layer3

1 Progressive support 4000 × 4000; baseline support 8000 x 8000.

Type	File Type	Codec	Ability
Audio	.aac	GAAC	Sample Rate: 8K~96KHz Bit Rate: 24K~576Kbps
	.ape	Monkey's Audio	Sample Rate: max 48KHz Bit Rate: max 1411Kbps
	.flac	FLAC	Sample Rate: max 192KHz Bit Rate: max 1411Kbps
	.m4a	ALAC	Sample Rate: 8K~96KHz Bit Rate: 24K~576Kbps
	.mp3	MPEG1/2 layer 3	Sample Rate: 8K~48KHz Bit Rate: 32K~320Kbps
	.ogg	Vorbis	Sample Rate: 8K~48KHz Bit Rate: max 256Kbps
	.wav	LPCM	Sample Rate: 8K~192KHz Bit Rate: max 320Kbps

Troubleshooting

Problem or Issue	Possible Solutions
Remote Control is not working	<ol style="list-style-type: none"> 1. Check whether something is obstructing the display's remote control receiver. 2. Check whether the battery polarities in the remote control are installed correctly. 3. Check whether the batteries need to be replaced.
The unit turns off unexpectedly	<ol style="list-style-type: none"> 1. Check whether Sleep mode is enabled. 2. Check if there is a power outage in your area. 3. Turn on the display, provide an active signal, and see if the problem is with the signal or external control system.
The power indicator is off, and there is no response	<ol style="list-style-type: none"> 1. Ensure the power cable is connected and not loose. 2. Check that the power outlet is functioning properly and meets the required electrical requirement.
The display does not recognize the USB storage device	<ol style="list-style-type: none"> 1. Ensure the drive is either formatted for FAT32 or NTFS. 2. If the USB storage device needs external power, connect its power adapter to an electrical outlet.

Video Not Working Properly

Problem or Issue	Possible Solutions
No picture/No sound	<ol style="list-style-type: none"> 1. Check the Power status. 2. Check the signal cable. 3. Use the remote control to ensure the input source setting is the same as the connected device.
Picture is unclear or cuts in and out	<ol style="list-style-type: none"> 1. Check the signal cable. 2. Check if other electronics or different signal types are interrupting the signal. 3. An optional active video cable or optional video extender is required for a long distance source.

Problem or Issue	Possible Solutions
Poor picture	<ol style="list-style-type: none"> 1. Adjust chroma and/or brightness settings in the menu. 2. Check the signal cable. 3. Use the display's native resolution for the source.

Audio Not Working Properly

Problem or Issue	Possible Solutions
No sound	<ol style="list-style-type: none"> 1. Press the Mute/Unmute button. 2. Adjust the volume. 3. Check the audio cable connection (if used). 4. If using a computer digital video with embedded audio, ensure the computer speakers are set to external speakers.
One speaker only	<ol style="list-style-type: none"> 1. Adjust the sound balance in the menu. 2. Check the left and right sound control panel settings of the computer or media player source. 3. Check the audio cable connection (if used). 4. Ensure the content has two audio channels and not mono.

Maintenance

General Precautions

- The LED lights used in the modules are susceptible to ESD (Electrostatic discharge). To prevent damage to the LED lights, do not touch them with bare hands or with conductive materials when handling.
- It is recommended to regularly inspect all installed components.
- Do not bring objects close to the ventilation holes of the display. Burns or personal injuries may occur if any body parts are brought too close.
- Be sure to power off and disconnect all cables before moving the display. Moving the display with its cables attached may damage the cables and thus cause fire or electric shock.
- Power off and disconnect the power plug from the wall outlet as a safety precaution before performing any type of cleaning or maintenance.

Initial Operation

- If a new screen has been stowed for less than three (3) months, it can be used at normal brightness during its first use.
- If a new screen has been stowed for more than three (3) months, the brightness should be set at 30% for its first use and allowed to operate for two (2) hours continuously. After two (2) hours of use, power off for 30 minutes. The new screen is now ready for normal brightness usage.

Front Panel Cleaning Instructions

- Use cool, compressed air to remove dust when the power is off. If the dust cannot be removed, the LED module should be replaced.
- Do not scratch and do not put pressure on the panel surface with fingers or any abrasive object.
- Do not use volatile substances such as sprays, solvents, or thinners.

Cabinet Cleaning Instructions

- Do not allow water or detergent to come into contact with the surface of the display. If water or moisture gets inside the unit, a system malfunction or electrical shock may occur.
- Do not scratch and do not put pressure on the cabinet with any abrasive objects of any kind.
- Do not use volatile substances such as sprays, solvents, or thinners on the cabinet.
- Do not place anything made from rubber or PVC near the cabinet for any extended periods of time.

Regular Use

- It is recommended to turn on the display at least once a month for more than eight (8) hours. During a wet and rainy season, it is recommended to turn on the display at least once a week.
- Avoid using full white, full red, full blue, or full green content for an extended period to avoid excessive power usage thus affecting the LED lifespan.

Vacuum Suction Tool

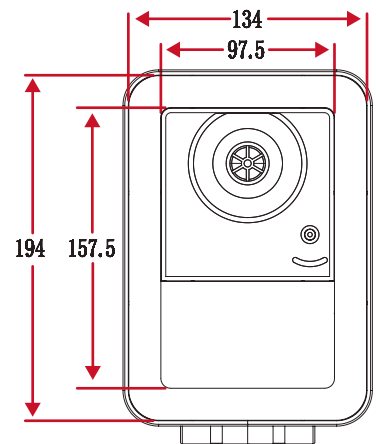
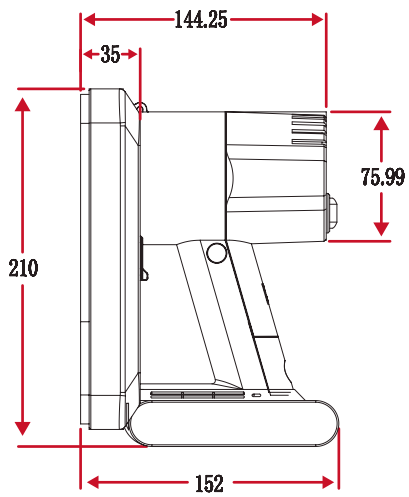
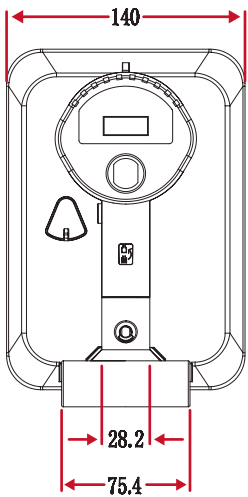
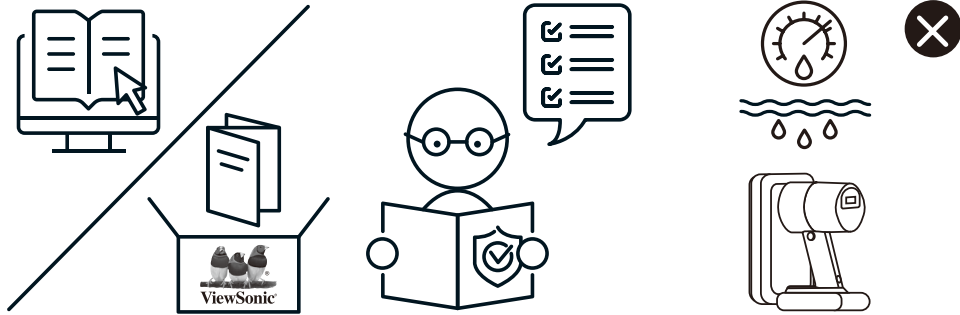

Charging the Battery

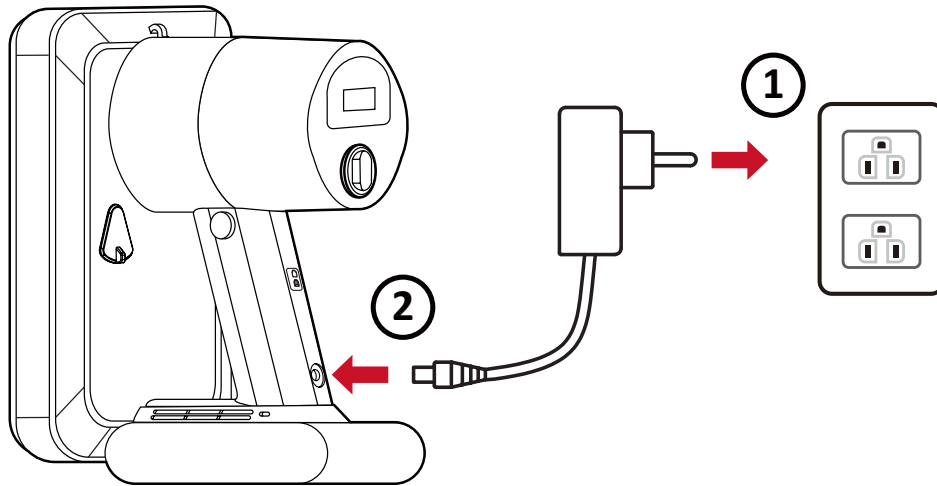

Changing the Battery

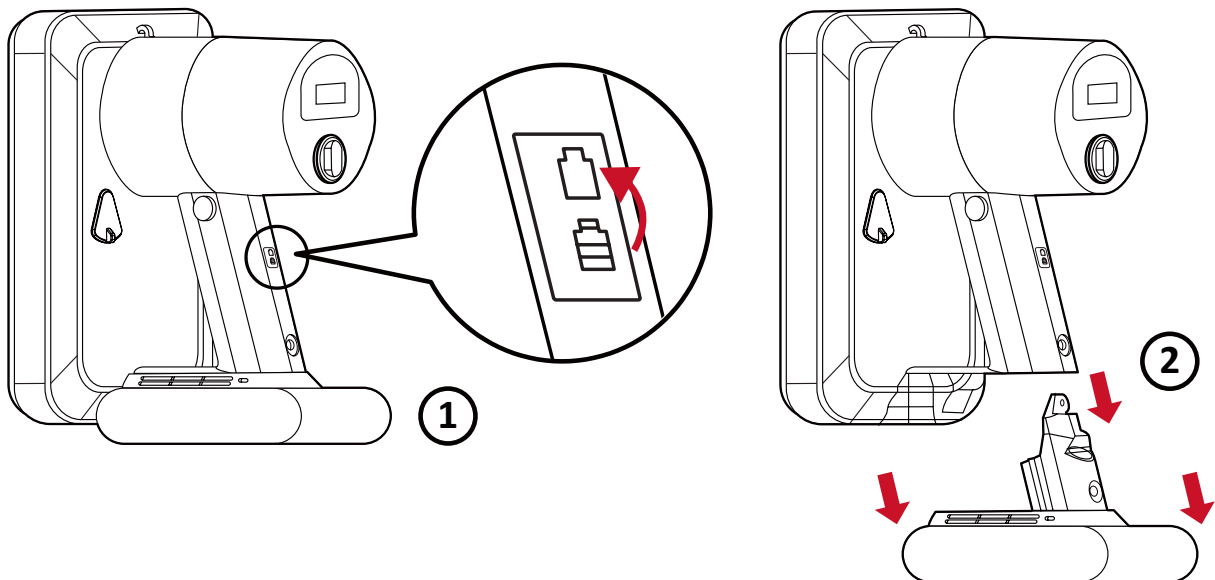

LED Module Disassembly

①

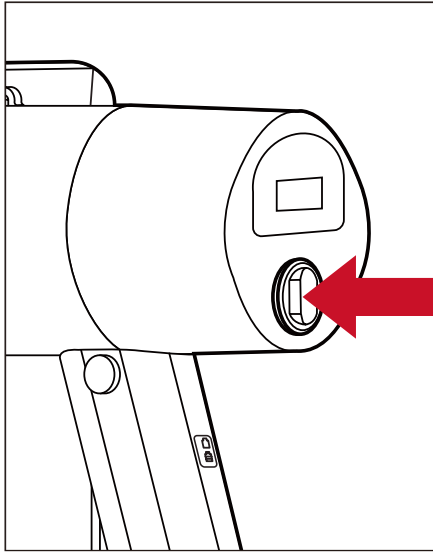

②

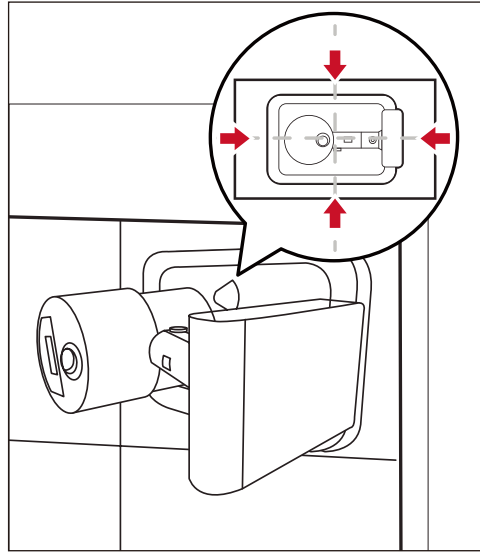

③

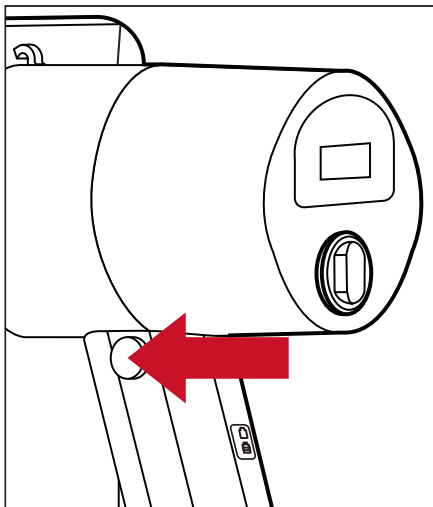

④

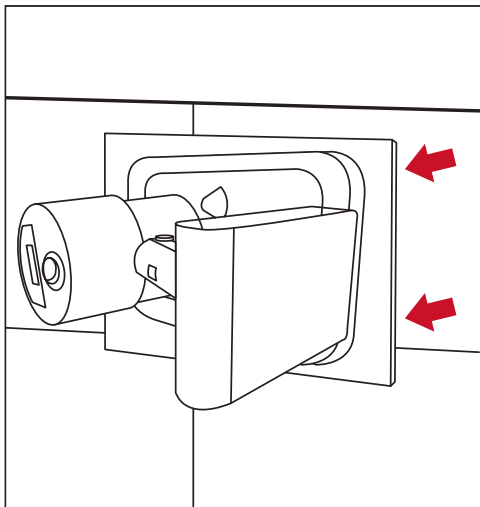

Overview

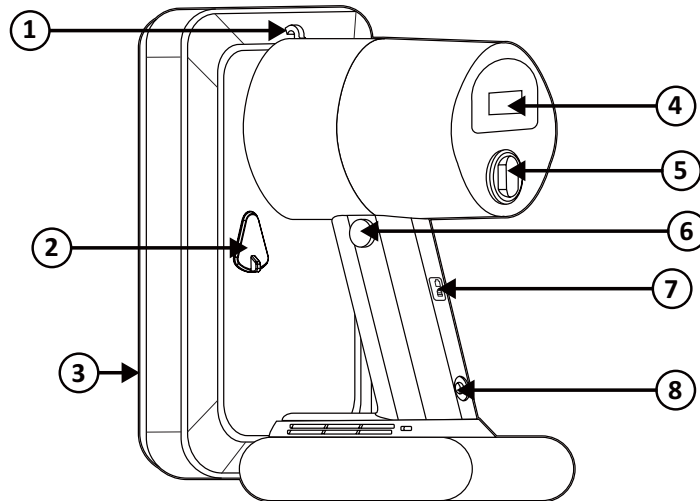

Number	Item	Description
①	Lanyard Ring	Lanyard attachment point.
②	Regulating Valve	Adjust the suction force level. Cover the valve for the strongest suction force.
③	LED Module Contact Silicone	Soft contact surface for LED module removal.
④	Power Display	Battery indicator.
⑤	Power Switch	Turn the device On/Off.
⑥	Start Button	Engage/Disengage the suction force.
⑦	Battery Removal Button	Press to remove the battery.
⑧	Charging Port	Port for battery charging.

Specifications

Item	Description
Model	LD-MK-001
Suction Face Dimension	134 x 194 mm (5.27" x 7.64")
Available Module Size	192 x 192 to 500 x 500 mm (7.56" x 7.56" to 19.69" x 19.69")
Product Dimension	152 x 140 x 210 mm (5.98" x 5.51" x 8.27")
Weight	1.17 kg (2.58 lbs)
Working Duration	17 minutes
Working Temperature	3 to 55° C (37.4 to 131° F)

> RS-232 Protocol

This document describes the hardware interface and software protocols of RS-232 serial communication between the ViewSonic LED Display and computers or control systems.

RS-232 Hardware Specification

ViewSonic RS-232 serial port on the lower left side:

1. Connector type: DB 9-Pin Female
2. Use of straight-through parallel cable for connection
3. Pin Assignment:

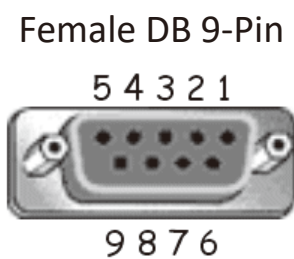

Pin #	Signal	Remark
1	NC	
2	TXD	Output from Display
3	RXD	Input to Display
4	NC	
5	GND	GND
6	NC	
7	NC	
8	NC	
9	NC	
frame	GND	

RS-232 Communication Setting

- Baud Rate Select: 115200bps (fixed)
- Data bits: 8 bits (fixed)
- Parity: None (fixed)
- Stop Bits: 1(fixed)

Command Table

Function	Command Code (Hex)	HEX	Data Range
Power On	21	38 30 31 73 21 30 30 31 0D	
Power Off (Standby)	21	38 30 31 73 21 30 30 30 0D	
Get-Power Status	6C	38 30 31 67 6C 30 30 30 0D	
Input Select: HDMI 1	22	38 30 31 73 22 30 30 34 0D	
Input Select: HDMI 2	22	38 30 31 73 22 30 31 34 0D	
Get-Input Select	6A	38 30 31 67 6A 30 30 30 0D	
Input Select: Home	22	38 30 31 73 22 30 30 41 0D	
Brightness: Down (-1)	24	38 30 31 73 24 39 30 30 0D	
Brightness: Up (+1)	24	38 30 31 73 24 39 30 31 0D	
Volume: Down (-1)	35	38 30 31 73 35 39 30 30 0D	
Volume: Up (+1)	35	38 30 31 73 35 39 30 31 0D	
Get-Volume	66	38 30 31 67 66 30 30 30 0D	
Mute: OFF	36	38 30 31 73 36 30 30 30 0D	
Mute: ON (mute)	36	38 30 31 73 36 30 30 31 0D	
Get-Mute	67	38 30 31 67 67 30 30 30 0D	
Number (0~9)	40	38 30 31 73 40 30 30 3x 0D	x = 0~9
Key Pad: UP	41	38 30 31 73 41 30 30 30 0D	
Key Pad: DOWN	41	38 30 31 73 41 30 30 31 0D	
Key Pad: LEFT	41	38 30 31 73 41 30 30 32 0D	
Key Pad: RIGHT	41	38 30 31 73 41 30 30 33 0D	
Key Pad: ENTER	41	38 30 31 73 41 30 30 34 0D	
Key Pad: INPUT	41	38 30 31 73 41 30 30 35 0D	
Key Pad: MENU	41	38 30 31 73 41 30 30 36 0D	
Key Pad: EXIT	41	38 30 31 73 41 30 30 37 0D	
Get-Operational Hours	31	38 30 31 67 31 30 30 30 0D	

> Regulatory and Service Information

Compliance Information

This section addresses all connected requirements and statements regarding regulations. Confirmed corresponding applications shall refer to nameplate labels and relevant markings on the unit.

FCC Compliance Statement

This device complies with part 15 of FCC Rules. Operation is subject to the following two conditions: (1) this device may not cause harmful interference, and (2) this device must accept any interference received, including interference that may cause undesired operation. This equipment has been tested and found to comply with the limits for a Class B digital device, pursuant to part 15 of the FCC Rules.

These limits are designed to provide reasonable protection against harmful interference in a residential installation. This equipment generates, uses, and can radiate radio frequency energy, and if not installed and used in accordance with the instructions, may cause harmful interference to radio communications. However, there is no guarantee that interference will not occur in a particular installation. If this equipment does cause harmful interference to radio or television reception, which can be determined by turning the equipment off and on, the user is encouraged to try to correct the interference by one or more of the following measures:

- Reorient or relocate the receiving antenna.
- Increase the separation between the equipment and receiver.
- Connect the equipment into an outlet on a circuit different from that to which the receiver is connected.
- Consult the dealer or an experienced radio/TV technician for help.

The antenna(s) used for this transmitter must not be collocated or operating in conjunction with any other antenna or transmitter.

The device was tested and complies to measurement standards and procedures specified in FCC CFR Title 47 Part 15 Subpart C.

FCC Radiation Exposure Statement

This equipment complies with FCC radiation exposure limits set forth for an uncontrolled environment. End users must follow the specific operating instructions for satisfying RF exposure compliance.

This transmitter must not be co-located or operating in conjunction with any other antenna or transmitter. This equipment should be installed and operated with a minimum distance of 20 centimeters between the radiator and your body.

The users manual or instruction manual for an intentional or unintentional radiator shall caution the user that changes or modifications not expressly approved by the party responsible for compliance could void the user's authority to operate the equipment.

Warning: You are cautioned that changes or modifications not expressly approved by the party responsible for compliance could void your authority to operate the equipment.

IC Warning Statement

This device complies with Industry Canada license- exempt RSS standard(s). Operation is subject to the following two conditions: (1) this device may not cause interference, and (2) this device must accept any interference, including interference that may cause undesired operation of the device.

Le présent appareil est conforme aux CNR d'Industrie Canada applicables aux appareils radio exempts de licence. L'exploitation est autorisée aux deux conditions suivantes : (1) l'appareil ne doit pas produire de brouillage, et (2) l'utilisateur de l'appareil doit accepter tout brouillage radioélectrique subi, même si le brouillage est susceptible d'en compromettre le fonctionnement.

Country Code Statement

For product available in the USA/Canada market, only channel 1~11 can be operated. Selection of other channels is not possible.

Pour les produits disponibles aux États-Unis/Canada du marché, seul le canal 1 à 11 peuvent être exploités. Sélection d'autres canaux n'est pas possible.

IC Radiation Exposure Statement

This equipment complied with IC RSS-102 radiation exposure limits set forth for an uncontrolled environment. This equipment should be installed and operated with minimum distance 20cm between the radiator & your body. The device for the band 5150-5825 MHz is only for indoor usage to reduce potential for harmful interference to co-channel mobile satellite systems.

Cet équipement est conforme aux limites d'exposition aux rayonnements IC établies pour un environnement non contrôlé. Cet équipement doit être installé et utilisé avec un minimum de 20cm de distance entre la source de rayonnement et votre corps. Les dispositifs fonctionnant dans la bande 5150-5825 MHz sont réservés uniquement pour une utilisation à l'intérieur afin de réduire les risques de brouillage préjudiciable aux systèmes de satellites mobiles utilisant les mêmes canaux.

CE Conformity for European Countries

 The device complies with the EMC Directive 2014/30/EU and Low Voltage Directive 2014/35/EU.

The following information is only for EU-member states:

The mark shown to the right is in compliance with the Waste Electrical and Electronic Equipment Directive 2012/19/EU (WEEE). The mark indicates the requirement NOT to dispose of the equipment as unsorted municipal waste, but use the return and collection systems according to local law.



Declaration of RoHS2 Compliance

This product has been designed and manufactured in compliance with Directive 2011/65/EU of the European Parliament and the Council on restriction of the use of certain hazardous substances in electrical and electronic equipment (RoHS2 Directive) and is deemed to comply with the maximum concentration values issued by the European Technical Adaptation Committee (TAC) as shown below:

Substance	Proposed Maximum Concentration	Actual Concentration
Lead (Pb)	0.1%	< 0.1%
Mercury (Hg)	0.1%	< 0.1%
Cadmium (Cd)	0.01%	< 0.01%
Hexavalent Chromium (Cr6 ⁺)	0.1%	< 0.1%
Polybrominated biphenyls (PBB)	0.1%	< 0.1%
Polybrominated diphenyl ethers (PBDE)	0.1%	< 0.1%
Bis (2-ethylhexyl) phthalate (DEHP)	0.1%	< 0.1%
Butyl benzyl phthalate (BBP)	0.1%	< 0.1%
Dibutyl phthalate (DBP)	0.1%	< 0.1%
Diisobutyl phthalate (DIBP)	0.1%	< 0.1%

Certain components of products as stated above are exempted under the Annex III of the RoHS2 Directives as noted below:

- Copper alloy containing up to 4% lead by weight.
- Lead in high melting temperature type solders (i.e. lead-based alloys containing 85% by weight or more lead).
- Electrical and electronic components containing lead in a glass or ceramic other than dielectric ceramic in capacitors, e.g. piezoelectronic devices, or in a glass or ceramic matrix compound.
- Lead in dielectric ceramic in capacitors for a rated voltage of 125V AC or 250V DC or higher.

European Union Regulatory Conformance

The equipment complies with the RF Exposure Requirement 2014/53/EU, Council Recommendation of 16 April 2014 on the limitation of exposure of the general public to electromagnetic fields (0-300 GHz). This equipment meets the following conformance standards: EN301489-1, EN301489-17, EN62368-1, EN300328.

We, hereby, declare that this Wi-Fi radio is in compliance with the essential requirements and other relevant provisions of Directive 2014/53/EU.

Indian Restriction of Hazardous Substances

Restriction on Hazardous Substances statement (India). This product complies with the “India E-waste Rule 2011” and prohibits use of lead, mercury, hexavalent chromium, polybrominated biphenyls or polybrominated diphenyl ethers in concentrations exceeding 0.1 weight % and 0.01 weight % for cadmium, except for the exemptions set in Schedule 2 of the Rule.

Product Disposal at End of Product Life

ViewSonic® respects the environment and is committed to working and living green. Thank you for being part of Smarter, Greener Computing. Please visit the ViewSonic® website to learn more.

USA & Canada:

<http://www.viewsonic.com/company/green/recycle-program/>

Europe:

<http://www.viewsoniceurope.com/eu/support/call-desk/>

Taiwan:

<https://recycle.epa.gov.tw/>

Copyright Information

Copyright© ViewSonic® Corporation, 2021. All rights reserved.

Macintosh and Power Macintosh are registered trademarks of Apple Inc.

Microsoft, Windows, and the Windows logo are registered trademarks of Microsoft Corporation in the United States and other countries.

ViewSonic®, the three birds logo, OnView, ViewMatch, and ViewMeter are registered trademarks of ViewSonic® Corporation.

VESA is a registered trademark of the Video Electronics Standards Association. DPMS, DisplayPort, and DDC are trademarks of VESA.

CTA is a registered trademark of the Consumer Technology Association Standards.

Disclaimer: ViewSonic® Corporation shall not be liable for technical or editorial errors or omissions contained herein; nor for incidental or consequential damages resulting from furnishing this material, or the performance or use of this product.

In the interest of continuing product improvement, ViewSonic® Corporation reserves the right to change product specifications without notice. Information in this document may change without notice.

No part of this document may be copied, reproduced, or transmitted by any means, for any purpose without prior written permission from ViewSonic® Corporation.

Customer Service

For technical support or product service, see the table below or contact your reseller.

NOTE: You will need the product's serial number.

Country/ Region	Website	Country/ Region	Website
Asia Pacific & Africa			
Australia	www.viewsonic.com/au/	Bangladesh	www.viewsonic.com/bd/
中国 (China)	www.viewsonic.com.cn	香港 (繁體中文)	www.viewsonic.com/hk/
Hong Kong (English)	www.viewsonic.com/hk-en/	India	www.viewsonic.com/in/
Indonesia	www.viewsonic.com/id/	Israel	www.viewsonic.com/il/
日本 (Japan)	www.viewsonic.com/jp/	Korea	www.viewsonic.com/kr/
Malaysia	www.viewsonic.com/my/	Middle East	www.viewsonic.com/me/
Myanmar	www.viewsonic.com/mm/	Nepal	www.viewsonic.com/np/
New Zealand	www.viewsonic.com/nz/	Pakistan	www.viewsonic.com/pk/
Philippines	www.viewsonic.com/ph/	Singapore	www.viewsonic.com/sg/
臺灣 (Taiwan)	www.viewsonic.com/tw/	ประเทศไทย	www.viewsonic.com/th/
Việt Nam	www.viewsonic.com/vn/	South Africa & Mauritius	www.viewsonic.com/za/
Americas			
United States	www.viewsonic.com/us	Canada	www.viewsonic.com/us
Latin America	www.viewsonic.com/la		
Europe			
Europe	www.viewsonic.com/eu/	France	www.viewsonic.com/fr/
Deutschland	www.viewsonic.com/de/	Қазақстан	www.viewsonic.com/kz/
Россия	www.viewsonic.com/ru/	España	www.viewsonic.com/es/
Türkiye	www.viewsonic.com/tr/	Україна	www.viewsonic.com/ua/
United Kingdom	www.viewsonic.com/uk/		

Limited Warranty

ViewSonic® Commercial Display

What the warranty covers:

ViewSonic® warrants its products to be free from defects in material and workmanship during the warranty period. If a product proves to be defective in material or workmanship during the warranty period, ViewSonic® will, at its sole option, and as your sole remedy, repair or replace the product with a similar product. Replacement Product or parts may include remanufactured or refurbished parts or components. The repair or replacement unit or parts or components will be covered by the balance of the time remaining on the customer's original limited warranty and the warranty period will not be extended. ViewSonic® provides no warranty for any third-party software whether included with the product or installed by the customer, installation of any unauthorized hardware parts or components (e.g. Projector Lamps). (Please refer to: "What the warranty excludes and does not cover" section).

Who the warranty protects:

This warranty is valid only for the first consumer purchaser.

What the warranty excludes and does not cover:

- Any product on which the serial number has been defaced, modified, or removed.
- Damage, deterioration, or malfunction resulting from:
 - » Accident, misuse, neglect, fire, water, lightning, or other acts of nature, unauthorized product modification, or failure to follow instructions supplied with the product.
 - » Repair or attempted repair by anyone not authorized by ViewSonic®.
 - » Damage to or loss of any programs, data, or removable storage media.
 - » Normal wear and tear.
 - » Removal or installation of the product.
- Software or data loss occurring during repair or replacement.
- Any damage of the product due to shipment.
- Causes external to the product, such as electric power fluctuations or failure.
- Use of supplies or parts not meeting ViewSonic's specifications.
- Failure of owner to perform periodic product maintenance as stated in the User Guide.
- Any other cause which does not relate to a product defect.

- Damage caused by static (non-moving) images displayed for lengthy periods of time (also referred to as image burn-in).
- Software - Any third-party software included with the product or installed by the customer.
- Hardware/Accessories/Parts/Components – Installation of any unauthorized hardware, accessories, consumable parts or components (e.g. Projector Lamps).
- Damage to, or abuse of, the coating on the surface of the display through inappropriate cleaning as described in the product User Guide.
- Removal, installation, and set-up service charges, including wall-mounting of the product.

How to get service:

- For information about receiving service under warranty, contact ViewSonic® Customer Support (Please refer to the “Customer Service” page). You will need to provide your product’s serial number.
- To obtain warranty service, you will be required to provide: (a) the original dated sales slip, (b) your name, (c) your address, (d) a description of the problem, and (e) the serial number of the product.
- Take or ship the product, freight prepaid, in the original container to an authorized ViewSonic® service center or ViewSonic®.
- For additional information or the name of the nearest ViewSonic® service center, contact ViewSonic®.

Limitation of implied warranties:

There are no warranties, express or implied, which extend beyond the description contained herein including the implied warranty of merchantability and fitness for a particular purpose.

Exclusion of damages:

ViewSonic's liability is limited to the cost of repair or replacement of the product. ViewSonic® shall not be liable for:

- Damage to other property caused by any defects in the product, damages based upon inconvenience, loss of use of the product, loss of time, loss of profits, loss of business opportunity, loss of goodwill, interference with business relationships, or other commercial loss, even if advised of the possibility of such damages.
- Any other damages, whether incidental, consequential or otherwise.
- Any claim against the customer by any other party.
- Repair or attempted repair by anyone not authorized by ViewSonic®.

Effect of state law:

This warranty gives you specific legal rights, and you may also have other rights which vary from state to state. Some states do not allow limitations on implied warranties and/or do not allow the exclusion of incidental or consequential damages, so the above limitations and exclusions may not apply to you.

Sales outside the U.S.A. and Canada:

For warranty information and service on ViewSonic® products sold outside of the U.S.A. and Canada, contact ViewSonic® or your local ViewSonic® dealer.

The warranty period for this product in mainland China (Hong Kong, Macao, and Taiwan Excluded) is subject to the terms and conditions of the Maintenance Guarantee Card.

For users in Europe and Russia, full details of warranty provided can be found at: <http://www.viewsonic.com/eu/> under "Support/Warranty Information".

Mexico Limited Warranty

ViewSonic® Commercial Display

What the warranty covers:

ViewSonic® warrants its products to be free from defects in material and workmanship, under normal use, during the warranty period. If a product proves to be defective in material or workmanship during the warranty period, ViewSonic® will, at its sole option, repair or replace the product with a like product. Replacement product or parts may include remanufactured or refurbished parts or components & accessories.

Who the warranty protects:

This warranty is valid only for the first consumer purchaser.

What the warranty excludes and does not cover:

- Any product on which the serial number has been defaced, modified or removed.
- Damage, deterioration, or malfunction resulting from:
 - » Accident, misuse, neglect, fire, water, lightning, or other acts of nature, unauthorized product modification, unauthorized attempted repair, or failure to follow instructions supplied with the product.
 - » Causes external to the product, such as electrical power fluctuations or failure.
 - » Use of supplies or parts not meeting ViewSonic®'s specifications.
 - » Normal wear and tear.
 - » Any other cause which does not relate to a product defect.
- Any product exhibiting a condition commonly known as “image burn-in” which results when a static image is displayed on the product for an extended period of time.
- Removal, installation, insurance, and set-up service charges.

How to get service:

For information about receiving service under warranty, contact ViewSonic® Customer Support (Please refer to the attached “Customer Service” page). You will need to provide your product’s serial number, so please record the product information in the space provided below on your purchase for your future use. Please retain your receipt of proof of purchase to support your warranty claim.

For Your Records

Product Name: _____ Model Number: _____
Document Number: _____ Serial Number: _____
Purchase Date: _____ Extended Warranty Purchase? _____(Y/N)
If so, what date does warranty expire? _____

- To obtain warranty service, you will be required to provide (a) the original dated sales slip, (b) your name, (c) your address, (d) a description of the problem, and (e) the serial number of the product.
- Take or ship the product, in the original container packaging, to an authorized ViewSonic® service center.
- Round trip transportation costs for in-warranty products will be paid by ViewSonic®.

Limitation of implied warranties:

There are no warranties, express or implied, which extend beyond the description contained herein including the implied warranty of merchantability and fitness for a particular purpose.

Exclusion of damages:

ViewSonic®’s liability is limited to the cost of repair or replacement of the product. ViewSonic® shall not be liable for:

- Damage to other property caused by any defects in the product, damages based upon inconvenience, loss of use of the product, loss of time, loss of profits, loss of business opportunity, loss of goodwill, interference with business relationships, or other commercial loss, even if advised of the possibility of such damages.
- Any other damages, whether incidental, consequential or otherwise.
- Any claim against the customer by any other party.
- Repair or attempted repair by anyone not authorized by ViewSonic®.

Contact Information for Sales & Authorized Service (Centro Autorizado de Servicio) within Mexico:	
Name, address, of manufacturer and importers: México, Av. de la Palma #8 Piso 2 Despacho 203, Corporativo Interpalmas, Col. San Fernando Huixquilucan, Estado de México Tel: (55) 3605-1099 http://www.viewsonic.com/la/soporte/index.htm	
NÚMERO GRATIS DE ASISTENCIA TÉCNICA PARA TODO MÉXICO: 001.866.823.2004	
Hermosillo: Distribuciones y Servicios Computacionales SA de CV. Calle Juarez 284 local 2 Col. Bugambilias C.P: 83140 Tel: 01-66-22-14-9005 E-Mail: disc2@hmo.megared.net.mx	Villahermosa: Compumantenimientos Garantizados, S.A. de C.V. AV. GREGORIO MENDEZ #1504 COL, FLORIDA C.P. 86040 Tel: 01 (993) 3 52 00 47 / 3522074 / 3 52 20 09 E-Mail: compumantenimientos@prodigy.net.mx
Puebla, Pue. (Matriz): RENTA Y DATOS, S.A. DE C.V. Domicilio: 29 SUR 721 COL. LA PAZ 72160 PUEBLA, PUE. Tel: 01(52).222.891.55.77 CON 10 LINEAS E-Mail: datos@puebla.megared.net.mx	Veracruz, Ver.: CONEXION Y DESARROLLO, S.A DE C.V. Av. Americas # 419 ENTRE PINZÓN Y ALVARADO Fracc. Reforma C.P. 91919 Tel: 01-22-91-00-31-67 E-Mail: gacosta@qplus.com.mx
Chihuahua: Soluciones Globales en Computación C. Magisterio # 3321 Col. Magisterial Chihuahua, Chih. Tel: 4136954 E-Mail: Cefeo@soluglobales.com	Cuernavaca: Compusupport de Cuernavaca SA de CV Francisco Leyva # 178 Col. Miguel Hidalgo C.P. 62040, Cuernavaca Morelos Tel: 01 777 3180579 / 01 777 3124014 E-Mail: aquevedo@compusupportcva.com
Distrito Federal: QPLUS, S.A. de C.V. Av. Coyoacán 931 Col. Del Valle 03100, México, D.F. Tel: 01(52)55-50-00-27-35 E-Mail : gacosta@qplus.com.mx	Guadalajara, Jal.: SERVICRECE, S.A. de C.V. Av. Niños Héroes # 2281 Col. Arcos Sur, Sector Juárez 44170, Guadalajara, Jalisco Tel: 01(52)33-36-15-15-43 E-Mail: mmiranda@servicrece.com
Guerrero Acapulco: GS Computación (Grupo Sesicomp) Progreso #6-A, Colo Centro 39300 Acapulco, Guerrero Tel: 744-48-32627	Monterrey: Global Product Services Mar Caribe # 1987, Esquina con Golfo Pérsico Fracc. Bernardo Reyes, CP 64280 Monterrey N.L. México Tel: 8129-5103 E-Mail: aydeem@gps1.com.mx
MERIDA: ELECTROSER Av Reforma No. 403Gx39 y 41 Mérida, Yucatán, México CP97000 Tel: (52) 999-925-1916 E-Mail: rrrb@sureste.com	Oaxaca, Oax.: CENTRO DE DISTRIBUCION Y SERVICIO, S.A. de C.V. Murguía # 708 P.A., Col. Centro, 68000, Oaxaca Tel: 01(52)95-15-15-22-22 Fax: 01(52)95-15-13-67-00 E-Mail: gpotai2001@hotmail.com
Tijuana: STD Av Ferrocarril Sonora #3780 L-C Col 20 de Noviembr Tijuana, Mexico	FOR USA SUPPORT: ViewSonic® Corporation 381 Brea Canyon Road, Walnut, CA. 91789 USA Tel: 800-688-6688 E-Mail: http://www.viewsonic.com



ViewSonic®