

ZQ610 & ZQ620

Mobile Printers



User Guide



ZEBRA

P1098271-03EN

Contents

Proprietary Statements	6
Document Conventions	8
Introduction to the ZQ610 & ZQ620 Printers	9
Unpacking and Inspection.....	10
Reporting Damage.....	10
ZQ610 & ZQ620 Technology.....	11
PowerPrecision+ (PP+) Battery 	11
Printing Technology.....	12
QR Code	13
Made for iPhone (MFi)	13
Near Field Communication (NFC).....	13
Color LCD Display	14
ZQ6 Overview	15
Getting Ready to Print	17
Battery.....	17
Removing the Battery	17
Removing the Battery Tape Insulator.....	18
Installing the Battery	19
Battery Safety	20
Charger Safety.....	20
Smart Charger-2 (SC2) Single Battery Charger	21
Charging Status Indicators.....	21
Battery Health Indicator	21

SC2 Dimensions	22
Model UCLI72-4 Quad Charger	22
AC Power Adapter	24
Ethernet and Charging Cradles	25
LED Status Indicator	26
Printer Operation with Cradle.....	28
1-Slot Battery Charger	29
Charging Status Indicators.....	29
3-Slot Battery Charger	30
Loading the Media in the ZQ6 Printers	31
Loading Media Procedure.....	31
Loading Media in Peel-off Mode	33
ZQ6 Healthcare Printers	34
Operator Controls	36
Standard Control Panel.....	36
Normal Boot-up LED Behavior.....	37
Sleep Mode LED Behavior.....	37
Shutdown Behavior.....	37
Power LED Ring Behavior	38
LCD Control Panel	39
Status Bar Icons.....	40
Home Menu Screen	42
Home Screen Icons and Parameters.....	44
Alert Messages	45
Buttons.....	46
Power-Up Sequences	46
Runtime Sequences without LED Flashes.....	46
Sleep Mode.....	47
Adaptive Print Performance	48
Draft Mode	48
Verify the Printer is Working.....	49
Printing a Configuration Label.....	49
Connecting the Printer	50
Cable Communication.....	51
RS-232C Communications	51
USB Communications.....	51

Providing Strain Relief for Communications Cable	52
Zebra Setup Utilities.....	53
Zebra Android Printer Setup Utility (for Link-OS Printers).....	53
Wireless Communications with Bluetooth	54
Bluetooth Networking Overview	54
Bluetooth Security Modes	55
Bluetooth Minimum Security Modes	56
WLAN Overview	57
Setting Up the Software	58
Designing Labels	58
Using Pre-Printed Receipt Media.....	60
Black Mark Dimensions (Receipt Media)	60
Label Areas	60
Label Design Examples	61
Keep-Out Areas	62
Near Field Communication (NFC).....	63
NFC Use Cases	64
Wearing the Printer	65
Swivel Belt Clip	65
Adjustable Shoulder Strap	66
Soft Case	67
Hand Strap.....	68
Preventive Maintenance	69
Extending Battery Life.....	69
General Cleaning Instructions.....	69
LCD Control Panel Indicators	72
Troubleshooting Topics	73
Troubleshooting Tests	75
Printing a Configuration Label.....	75
Communications Diagnostics.....	75
Specifications	80
Printing Specifications.....	80
Memory and Communications Specifications	80
Label Specifications	81
CPCL Font and Bar Code Specifications and Commands.....	82
ZPL Font and Bar Code Specifications and Commands.....	83

Communication Ports.....	84
Physical, Environmental and Electrical Specifications.....	85
ZQ620 Dimensions	86
ZQ620 Mounting Hole Dimensions	87
ZQ610 Dimensions	88
ZQ610 Mounting Hole Dimensions	89
ZQ6 Accessories.....	90
Appendix A.....	92
Interface Cables (RS-232 Cables).....	92
USB Cables	93
Appendix B.....	94
Media Supplies	94
Appendix C.....	94
Maintenance Supplies.....	94
Appendix D.....	95
Appendix E.....	115
Appendix F.....	116
Battery Disposal.....	116
Product Disposal.....	116
Appendix G.....	117
Alert Messages	117
Appendix H.....	120
Using Zebra.com.....	120
Appendix I.....	122
Product Support	122

Copyright

© 2017 ZIH Corp and/or its affiliates. All rights reserved. ZEBRA and the stylized Zebra head are trademarks of ZIH Corp., registered in many jurisdictions worldwide. All other trademarks are the property of their respective owners.

COPYRIGHTS AND TRADEMARKS: For complete copyright and trademark information, go to www.zebra.com/copyright

WARRANTY: For complete warranty information, go to www.zebra.com/warranty

END USER LICENSE AGREEMENT: For complete EULA information, go to www.zebra.com/eula

Terms of Use

Proprietary Statement: This manual contains proprietary information of Zebra Technologies Corporation and its subsidiaries ("Zebra Technologies"). It is intended solely for the information and use of parties operating and maintaining the equipment described herein. Such proprietary information may not be used, reproduced, or disclosed to any other parties for any other purpose without the express, written permission of Zebra Technologies.

Product Improvements: Continuous improvement of products is a policy of Zebra Technologies. All specifications and designs are subject to change without notice.
Liability Disclaimer: Zebra Technologies takes steps to ensure that its published Engineering specifications and manuals are correct; however, errors do occur. Zebra Technologies reserves the right to correct any such errors and disclaims liability resulting therefrom.

Limitation of Liability: In no event shall Zebra Technologies or anyone else involved in the creation, production, or delivery of the accompanying product (including hardware and software) be liable for any damages whatsoever (including, without limitation, consequential damages including loss of business profits, business interruption, or loss of business information) arising out of the use of, the results of use of, or inability to use such product, even if Zebra Technologies has been advised of the possibility of such damages. Some jurisdictions do not allow the exclusion or limitation of incidental or consequential damages, so the above limitation or exclusion may not apply to you.

Monotype®, Intellifont® and UFST® are trademarks of Monotype Imaging, Inc. registered in the United States Patent and Trademark Office and may be registered in certain jurisdictions. Andy™, CG Palacio™, CG Century Schoolbook™, CG Triumvirate™, CG Times™, Monotype Kai™, Monotype Mincho™ and Monotype Sung™ are trademarks of Monotype Imaging, Inc. and may be registered in some jurisdictions. HY Gothic Hangu™ is a trademark of Hanyang Systems, Inc. Angsana™ is a trademark of Unity Progress Company (UPC) Limited. Andale®, Arial®, Book Antiqua®, Corsiva®, Gill Sans®, Sorts® and Times New Roman® are trademarks of The Monotype Corporation registered in the United States Patent and Trademark Office and may be registered in certain jurisdictions. Century Gothic™, Bookman Old Style™ and Century Schoolbook™ are trademarks of The Monotype Corporation and may be registered in certain jurisdictions. HGGothicB is a trademark of the Ricoh company, Ltd. and may be registered in some jurisdictions.

Univers™ is a trademark of Heidelberger Druckmaschinen AG, which may be registered in certain jurisdictions, exclusively licensed through Linotype Library GmbH, a wholly owned subsidiary of Heidelberger Druckmaschinen AG.

Futura® is a trademark of Bauer Types SA registered in the United States Patent and Trademark Office and may be registered in some jurisdictions.

TrueType® is a trademark of Apple Computer, Inc. registered in the United States Patent and Trademark Office and may be registered in certain jurisdictions.

All other product names are the property of their respective owners.

“Made for iPod”, “Made for iPhone”, and “Made for iPad” mean that an electronic accessory has been designed to connect specifically to iPod, iPhone, or iPad, respectively, and has been certified by the developer to meet Apple performance standards. Apple is not responsible for the operation of this device or its compliance with safety and regulatory standards. Please note that the use of this accessory with iPod, iPhone, or iPad may affect wireless performance.

Bluetooth® is a registered trademark of the Bluetooth SIG.

© 1996–2009, QNX Software Systems GmbH & Co. KG. All rights reserved. Published under license by QNX Software Systems Co.

All other brand names, product names, or trademarks belong to their respective holders.
©2017 ZIH Corp.

Works with:



Windows

Made for



iPod iPhone iPad

Certified by:



Document Conventions

The following graphic icons are used throughout the documentation set. These icons and their associated meanings are described below.



Caution • Warns you of the potential for electrostatic discharge.



Caution • Warns you of a potential electric shock situation.



Caution • Warns you of a situation where excessive heat could cause a burn



Caution • Advises you that failure to take or avoid a specific action could result in physical harm to you.



Caution • Advises you that failure to take or avoid a specific action could result in physical harm to the hardware.



Important • Advises you of information that is essential to complete a task.



Note • Indicates neutral or positive information that emphasizes or supplements important points of the main text.

Introduction to the ZQ610 & ZQ620 Printers

Thank you for choosing our Zebra® ZQ610 and ZQ620 Mobile Printers. You will find these rugged printers will become a productive and efficient addition to your workplace thanks to their innovative design and state of the art features. Zebra Technologies is the leader in industrial printers with world-class support for all of your bar code printers, software, and supplies. This user's guide gives you the information you will need to operate the ZQ610 and ZQ620 printers. They use some of the latest technologies such as an 802.11ac/Bluetooth 4.1 dual radio, a smart battery with PowerPrecision+ functionality, Near Field Communication (NFC), a color LCD display and Made for iPhone® (MFi). MFi printers provide Apple co-processor (MFi) support which allows an Apple device such as an iPhone or iPad® to authenticate and connect over Bluetooth®.



These printers use CPCL, ZPL and EPL programming languages. To create and print labels using these languages, refer to the Programming Guide for CPCL (p/n P1073699-001), ZPL (p/n P1012728-010) and EPL (p/n 14245L-002). See Appendix H for instructions on how to access manuals on zebra.com.

ZQ610 & ZQ620 Software Utilities:

- ZebraNet Bridge Enterprise™: printer configuration, fleet management
- Zebra Setup Utility: single printer configuration, quick setup
- Zebra Mobile Setup Utility: Android-based setup tool
- ZebraDesigner Pro v2: label design
- Zebra Designer Drivers: Windows® driver
- OPOS Driver: Windows driver
- Multiplatform SDK
- Zebra Downloader
- Printer Profile Manager Enterprise (PPME)
(These utilities can be found on the Zebra website at <http://www.zebra.com/us/en/support-downloads.html>. See Appendix G.)

Unpacking and Inspection

- Check all exterior surfaces for damage.
- Open the media cover (refer to “Loading the Media” in the Getting Ready to Print section) and inspect the media compartment for damage.

In case shipping is required, save the carton and all packing material.



Reporting Damage

If you discover shipping damage:

- Immediately notify and file a damage report with the shipping company. Zebra Technologies Corporation is not responsible for any damage incurred during shipment of the printer and will not cover the repair of this damage under its warranty policy.
- Keep the carton and all packing material for inspection.
- Notify your authorized Zebra re-seller.

ZQ610 & ZQ620 Technology

The ZQ610 and ZQ620 printers use several technologies made popular in other Zebra Mobile Printer product lines, as well as newer, state-of-the-art technologies.

PowerPrecision+ (PP+) Battery

The ZQ6 printers use a 2-cell Li-Ion battery pack with integrated intelligence and data storage capability meeting PowerPrecision+ (PP+) functionality. This intelligent battery has the integrated technology required to collect the detailed realtime battery metrics needed to maximize useful battery life and ensure every battery is healthy and able to hold a full charge. In addition, technology inside the batteries tracks and maintains the metrics required to provide real-time visibility into more meaningful battery statistics, such as total cycle usage of the battery, whether the battery is old and should be retired or how long a battery will take to fully charge.

Operating Temperature	Charging Temperature	Storage Temperature
-20°C to +60°C (-4°F to 140°F)	0°C to +40°C (32°F to 104°F)	-25°C to +60°C (-13°F to 140°F)
0°C to +50°C (32°F to 122°F) for Healthcare models		



Important • The printers will only function properly using genuine Zebra smart battery packs. To achieve the best fast charging results, charge batteries at room temperature with the device powered off. Ideal charging conditions are within temperatures from 5°C to 40°C (41°F to 104°F).

The device always performs battery charging in a safe and intelligent manner. At higher temperatures, the device may for small periods of time alternately enable and disable battery charging to keep the battery at acceptable temperatures. Under abnormal temperatures the device will indicate when charging is unable to be initiated via its LED and a notification that appears on the display.

The smart battery's health has three states: GOOD, REPLACE, and POOR. The battery health factor determines whether or not the printer can operate and what is communicated to the user via the display.

# of Charge Cycles	Health	Power-up Message
<300	GOOD	None
≥300 but <550	REPLACE	"Battery Diminished Consider Replacing" *
≥550 but <600	REPLACE	"Warning-Battery Is Past Useful Life" *
≥600	POOR	"Replace Battery Shutting Down" **

*** Warning accompanied by one long beep.**

**** Warning will flash on and off accompanied by beeping at a rate of once per second. After 30 seconds the printer will shut down.**



Note • Power down the printer before removing the battery to minimize the risk of corruption.

Printing Technology

The ZQ610 and ZQ620 printers use the Direct Thermal method to print human readable text, graphics and barcodes. It incorporates a sophisticated print engine for optimal printing under all operational conditions. Direct thermal printing uses heat to cause a chemical reaction on specially treated media. This reaction creates a dark mark wherever a heated element on the printhead comes in contact with the media. Since the printing elements are arranged

very densely at 203 d.p.i. (dots per inch) horizontal and 200 d.p.i. vertical, highly legible characters and graphic elements may be created a row at a time as the media is advanced past the printhead. This technology has the advantage of simplicity, as there is no requirement for consumable supplies such as ink or toner. However, since the media is sensitive to heat, it will gradually lose legibility over long periods of time, especially if exposed to environments with relatively high temperatures or in direct sunlight.

QR Code

The QR barcode includes human readable text URL, for example www.zebra.com/zq620-info, which links the user to printer information and short videos on topics such as buying supplies, features overview, loading media, printing a configuration report, cleaning instructions, and accessory information.

Figure 1 • QR Code (ZQ620 Shown).



Made for iPhone (MFi)

ZQ610 and ZQ620 printers support communication with Apple devices running iOS 10 or later over a standalone Bluetooth 4.1 radio and the BT4.1 radio included with the 802.11ac (dual) radio.



Near Field Communication (NFC)

The ZQ6 printers support a passive NFC tag which complies with the “Android Standard Tag format” since Android devices are the most common found on the market today. The NFC tag is programmed from the factory and supports Bluetooth pairing to enable a tablet, smartphone or terminal to automatically pair with the printer via a Bluetooth connection (within the bounds of the security profile being used).

The NFC tag also supports app launching whereby an app developed either by Zebra or a third party will launch on a NFC-enabled smartphone, tablet or terminal. Similarly, the NFC tag enables launching to a web support page via a tablet, smartphone or terminal.

Color LCD Display

The ZQ610 and ZQ620 printers feature a color, non-touch LCD display which supports a 288x240 pixel viewable area. The user will be able to view the display in both room light and night time conditions. The display is capable of displaying colored text as well as color images. In order to save power, the display will dim after a configurable timeout.

ZQ6 Overview

Figure 2 • Overview of Features (ZQ620 Shown).

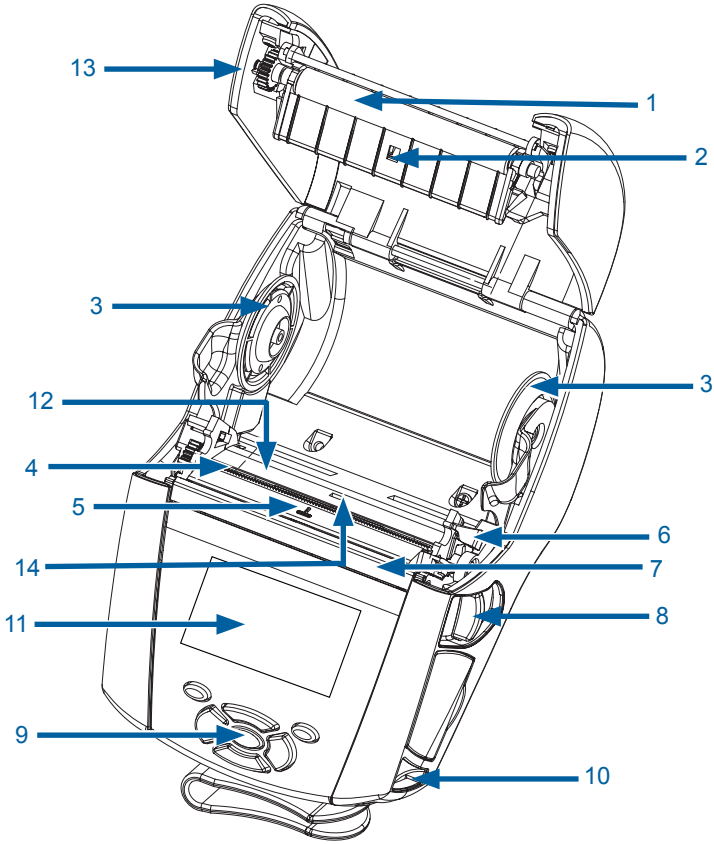

- | | |
|--------------------------------------|----------------------------|
| 1. Platen Roller | 18. Battery |
| 2. Black Bar Sensor | 19. USB/RS-232 Comm Ports |
| 3. Media Support Disks | 20. MAC Address Label |
| 4. Tear Bar | 21. Docking Contacts |
| 5. Label Presence Sensor | 22. DC Input |
| 6. Peeler Lever | 23. NFC (Print Touch Icon) |
| 7. Peeler Bail | |
| 8. Latch Release Lever | |
| 9. Key Pad | |
| 10. Strap Post | |
| 11. Color LCD | |
| 12. Printhead | |
| 13. Media Cover | |
| 14. Gap Sensor | |
| 15. Power Button (w/ Power Ring LED) | |
| 16. Feed Button | |
| 17. Belt Clip | |

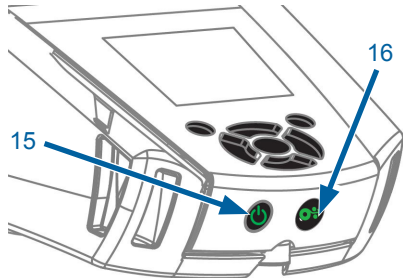

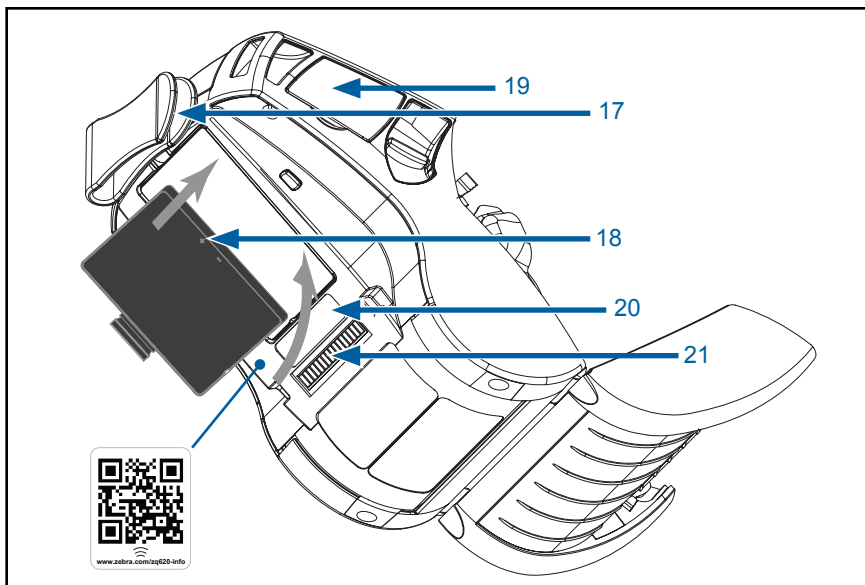

Note • Scanning the QR code with a smartphone will provide printer-specific information at www.zebra.com/zq610-info and www.zebra.com/zq620-info.



Note • Tapping the Zebra Print Touch™ icon with a Near Field Communication (NFC) enabled smartphone will provide instant access to printer-specific information. For more information about NFC and Zebra products, go to <http://www.zebra.com/nfc>. Bluetooth pairing applications via NFC is also possible. Please see Zebra Multi-platform SDK for more information.

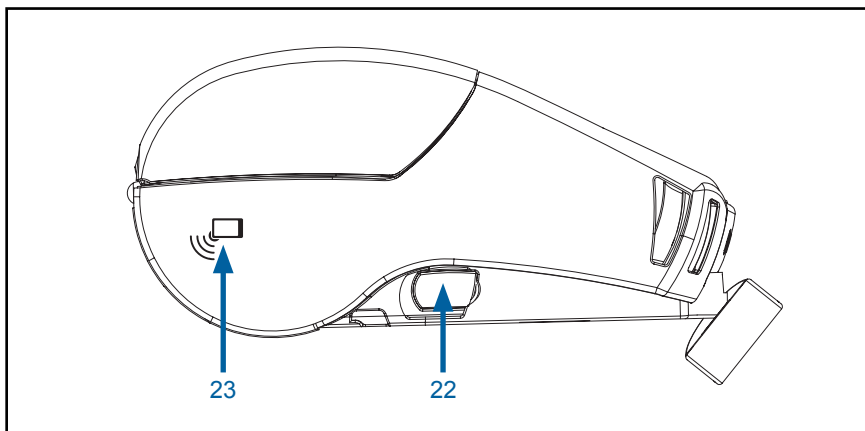

Getting Ready to Print

Battery

Installing/Removing Battery & Battery Tape Insulator



Important • Batteries are shipped in sleep mode to preserve their maximum capacity while in storage prior to initial use. Plug in the AC adapter (see page 24) or insert the battery into the 1-Slot Battery Charger (see page 29) or 3-Slot Battery Charger (see page 30), Smart Charger 2 (see page 21) or Quad Charger (see page 22) to wake it up before using for the first time.

Removing the Battery

1. If a belt clip is present on the bottom of the printer, rotate it such that it provides clearance for the battery.

2. Depress the latch on the battery pack (where indicated).

3. Rotate the pack away from the battery well. Lift the battery up and out of the printer.



Removing the Battery Tape Insulator

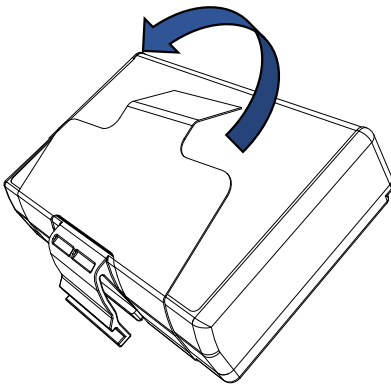

1. Pull up on the tape insulator tab located on the bottom of the battery pack.

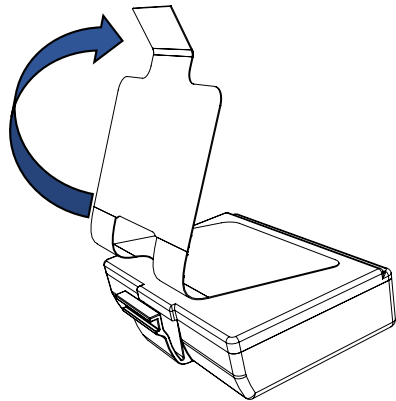

2. Peel back the tape insulator and remove it from the top of the battery pack. Discard upon removal.



Caution • Battery can explode, leak or catch fire if improperly charged or exposed to high temperature. Do not disassemble, crush, puncture, short external contacts or dispose in fire or water. Charge on a Zebra approved Lithium-Ion charger only.

Installing the Battery

1. Locate the battery compartment on the bottom of the printer (where indicated).



2. Swivel the belt clip (if present) to access the battery compartment.

3. Insert the battery into the printer as shown. (It is not possible to insert the pack in the incorrect orientation.)



4. Rock the battery into the compartment as shown until it locks in place.



Battery Safety



Caution • Avoid accidental short circuiting of any battery. Allowing battery terminals to contact conductive material will create a short circuit which could cause burns and other injuries or could start a fire.



Important • Always refer to the Important Safety Information data sheet shipped with each printer and the Technical Bulletin shipped with each battery pack. These documents detail procedures to ensure maximum reliability and safety while using this printer.



Important • Always dispose of used batteries properly. Refer to Appendix E for more battery recycling information.



Caution • Use of any charger not approved specifically by Zebra for use with its batteries could cause damage to the battery pack or the printer and will void the warranty.



Caution • Do not incinerate, disassemble, short circuit, or expose to temperatures higher than 65°C (149°F).

Charger Safety



Do not place any charger in locations where liquids or metallic objects may be dropped into the charging bays.

Smart Charger-2 (SC2) Single Battery Charger (p/n P1031365-063 with US Type-A Line Cord)

The Smart Charger-2 (SC2) is a charging system for use with the 2-cell and 4-cell lithium-ion smart batteries used in the ZQ6 printers.

Charging Status Indicators

The SC2 uses a LED indicator to indicate the charge state in either Green, Yellow, or Amber as detailed below.

DC Power Input	Indicator	Battery Status
Present	Green	Battery not present
Present	Green	Fully charged
Present	Yellow	Charging
Present	Amber	Fault
Present	Off	Present and Battery Health = POOR

There will also be a battery charging graphic to indicate that this LED is the charging status indicator . Charge time for all batteries is 2 hours.

Battery Health Indicator

The SC2 features a tri-color (Yellow/Green/Amber) LED to indicate the health of the battery pack. An evaluation of the battery health begins upon insertion of the battery in the charger and results in the appropriate LED being illuminated as shown below. The LED will remain illuminated as long as input power is applied.

Battery	Indicator	Health Status
None or non-smart	Off	
Smart battery present	Green	GOOD
Smart battery present	Yellow	CAPACITY DIMINISHED
Smart battery present	Flashing yellow	PAST USEFUL LIFE
Smart battery present	Amber	UNUSABLE-REPLACE (discard per Instructions in Appendix E)



Note • For detailed information on the SC2, refer to the Smart Charger 2 User Guide (p/n P1040985-001).

Figure 3 • Smart Charger-2 (SC2)

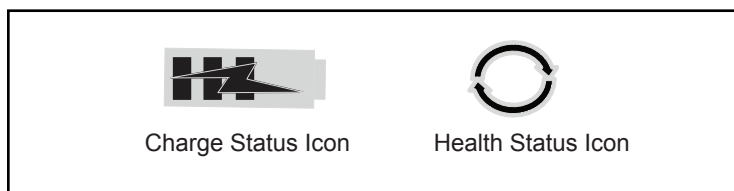
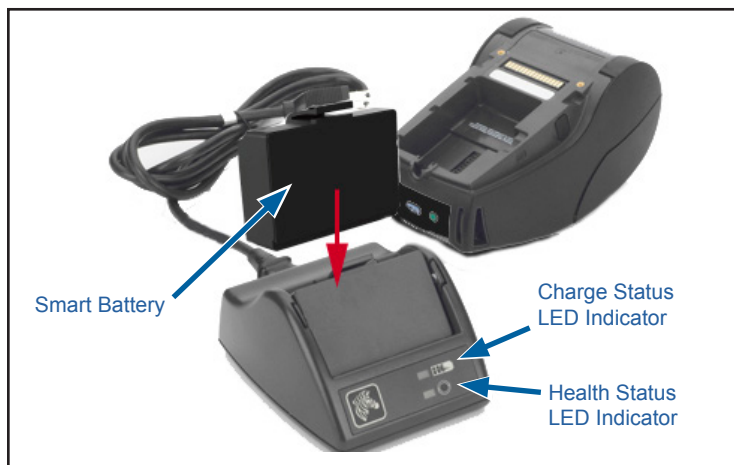

SC2 Dimensions

Height	Width	Length
65.1 mm (2.56 in.)	101.5 mm (4 in.)	120.9 mm (4.75 in.)

Model UCLI72-4 Quad Charger (AC18177-5 with US Type-A Line Cord)

The UCLI72-4 Quad Charger is designed to charge up to four (4) ZQ6 battery packs simultaneously. Batteries must be removed from the printer to be charged in the Quad Charger.

1. Ensure that the charger has been installed properly per the Quad Charger instruction manual. Ensure that the power indicator on the front panel is on.
2. Plug a battery pack into any one of the four charging bays as shown in Figure 4, noting the orientation of the battery pack. Slide the battery pack into the charging bay until it stops and then rock the battery pack back until it snaps into place. The amber indicator directly under the battery being charged will turn on if the battery is properly inserted.

The indicators under the battery will allow you to monitor the charging process per the table below:

Amber	Green	Battery Status
On	Off	Charging
On	Flashing	80% charged (O.K. to use)
Off	On	Completely Charged
Flashing	Off	Fault-Replace Battery



Important • A fault condition is caused by a problem with the battery. The charger may indicate a fault because the battery is too hot or cold to charge reliably. Try to charge the battery again when it returns to the room’s ambient temperature. If the amber indicator starts flashing on the second attempt, the battery should be discarded. Always dispose of batteries in a proper manner as described in Appendix F.

Figure 4 • Quad Charger

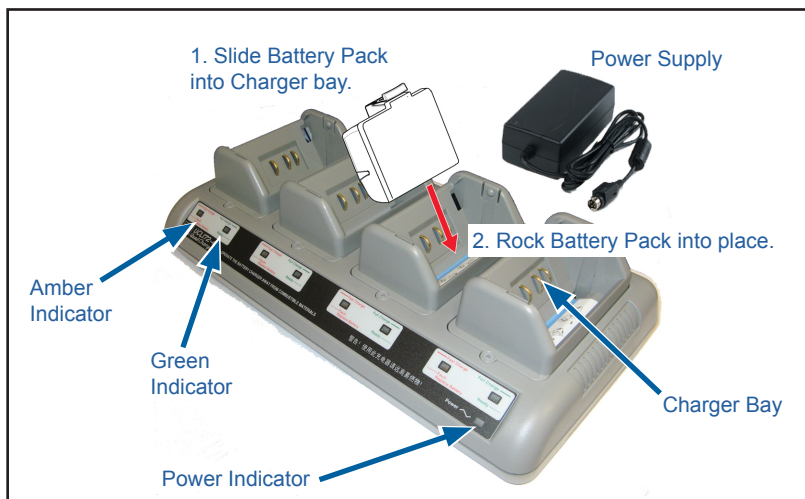

Battery packs which are only partially discharged will take less time to reach their charged state. Batteries which have reached 80% of their charge capacity may be used, however, it is recommended that you allow the batteries to reach a full charge to maintain maximum battery life.



Note • The UCLI72-4 Quad Charger has a safety feature which stops charging a battery after six hours regardless of its charge state. If not fully charged, it might be indicative of a battery that needs to be replaced.



Important • Use care when installing the UCLI72-4 Quad Charger so that you do not block the ventilating slots on the top and bottom covers. Ensure that the charger is plugged into a power source which will not accidentally be turned off if you will be charging batteries overnight.

AC Power Adapter

(p/n P1031365-024 with US Type-A Line Cord) (p/n P1065668-008 with US Type-A Line Cord for Healthcare Only)

Figure 5 • AC Power Adapter Charging

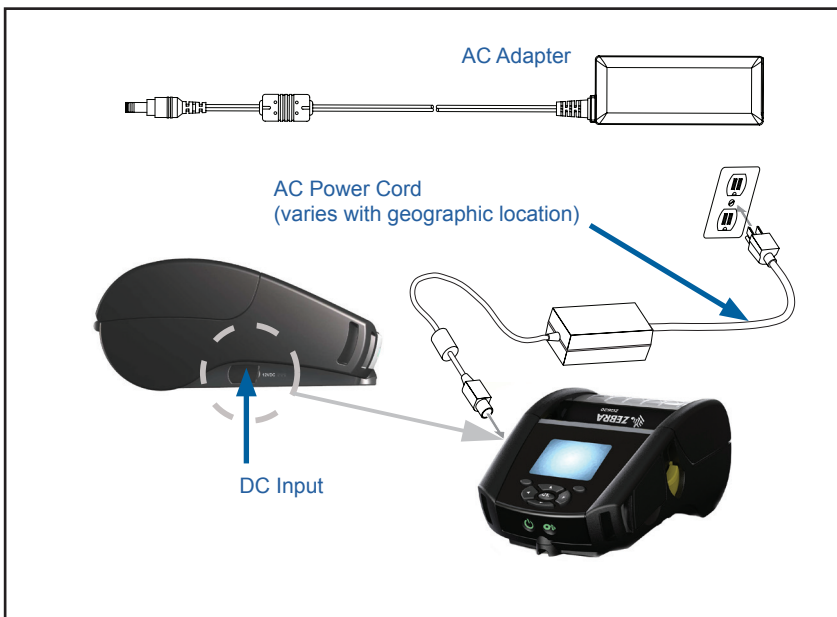

- Open the protective cover on the printer to expose the DC input charger jack.
- Connect the appropriate AC power cord for your location to the adapter and then plug the power cord into an AC receptacle.
- Plug the barrel plug from the AC adapter into the charger jack on the printer.
- The printer will power up and begin charging. The printer can be left on or turned off at this point. Charging will continue in either state.



Important • While it's possible to charge the battery when using the printer, charge times will increase under this condition.

Ethernet and Charging Cradles

The cradle is an expansion base intended for use with the ZQ6 printers. There is a four bay cradle (EC4) or a single bay option (EC) for use with the ZQ610 and ZQ620, as shown on pages 29 and 30. The EC/EC4 cradles provide charging power to the docked printer as well as providing a standard 10/100 Mb/s Ethernet port for communication to the printer. Both cradles also supply battery charging power to the docked printer and act as a supplementary power source.

They feature two LED's to indicate the status of the cradle: Solid green to indicate when power is provided to the input of the cradle; and blinking green to indicate Ethernet activity. The cradles allow the user to dock the printer easily and remove it with the push of a button. The printer will remain operable while docked, i.e. display is viewable, charge LED status is viewable, and printer controls and data entry are available. The printer will still print while docked and the user will be able to replace the media as well.

LED Status Indicator

LED Status	Indication
Solid Green	Power On
Blinking Green	Ethernet Activity



Note • Remove the “Docking Cradle Access” label on the bottom of the printers before docking the printer in the cradle.



Note • Clean the docking contacts with a Zebra cleaning pen to remove any residue left behind by the label.

Figure 6 • 4-Bay Ethernet Cradle



Height	Width	Length
66.7 mm (2.62 in.)	579.9 mm (22.83 in.)	150.57 mm (5.93 in.)



Note • The ZQ610 and ZQ620 extended capacity battery is not compatible with the EC and EC4 cradles.

Figure 7 • Single Bay Ethernet Cradle



Cradle	Height	Width	Length
Single Bay Cradle	66.7 mm (2.62 in.)	171.28 mm (6.74 in.)	150.57 mm (5.93 in.)

Printer Operation with Cradle

- ZQ6 printers will charge when placed in their supported cradles.
- Docking the printer in the cradle will automatically turn the printer on to ensure it is available to be managed remotely.
- When the printer detects input power from the cradle, and the presence of a live Ethernet link, it will automatically connect to the Ethernet network.
- For printers with an 802.11 radio, this interface will be turned off when the Ethernet link is active. It will turn back on if the Ethernet link is no longer active.
- For printers with a Bluetooth radio, this interface will remain active while the printer is in the cradle.
- The serial and USB ports will remain active while the printer is in the cradle.
- The DC input barrel jack connector (see Figure 5) cannot be used while the printer is in the cradle. The DC barrel jack should be plugged directly into the cradle instead.



Note • The printer provides over voltage protection such that no damage occurs when voltages from 0-36V are applied at the DC Power jack. Upon application of voltage greater than 36V, the DC line fuse will permanently open to reduce fire hazard. The battery is only charged when 12VDC is applied using the Zebra AC adapter.

1-Slot Battery Charger (p/n SAC-MPP-1BCHGUS1-01SA with US Type-A Line Cord)

Use Case: Home Office/Small Business

The 1-Slot Battery Charger provides the user with a single, spare battery charging solution. Similar to the 3-Slot Battery Charger, the single charger will charge a 2-cell battery from empty to fully charged in less than four (4) hours and a 4-cell battery within six (6) hours.

Figure 8 • 1-Slot Battery Charger

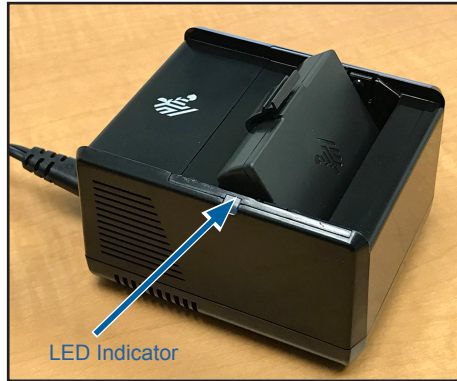

Charging Status Indicators

Both the 3-slot and 1-slot battery chargers use an LED indicator located next to each slot to indicate the charge state in either green, red, or amber as detailed below.

Mode	Charging Indication	Description
Charge Fault	● ○ ● ○	Fast blinking red
Charging (Healthy)	●	Solid amber
Charge Done (Healthy)	●	Solid green
Charging (Unhealthy)	●	Solid red
Charging Done (Unhealthy)	●	Solid red
Best Battery (Charging)	● ✨	Alternates between solid and bright bursts of amber
Best Battery (Charge Done)	● ✨	Alternates between solid and bright bursts of green

3-Slot Battery Charger

(p/n SAC-MPP-3BCHGUS1-01) Dual 3-Slot Battery Charger (p/n SAC-MPP-6BCHUS1-01) w/ US Type-A Line Cord

Use Case: Settlement Room

The 3-Slot Battery Charger is a charging system for use with the 2-cell lithium-ion batteries used in the ZQ6 printers. The 3-slot charger is capable of charging three 2-cell batteries simultaneously from empty to full in less than four (4) hours and 4-cell batteries within six (6) hours. It can either be used as a standalone charger or mounted on a 5-slot share cradle.

Figure 9 • 3-Slot Battery Charger



Note • For detailed information on the 1-Slot, 3-Slot Battery Charger and 3-Slot Dual Pack Charger, refer to the P1096323-101, P1096767-101 and P1097966-101 Quick Start Guides at <https://www.zebra.com/us/en/support-downloads.html>

Loading the Media in the ZQ6 Printers

You can operate ZQ6 printers in one of two different modes: Tear-Off or Peel-Off. Tear-Off mode allows you to tear off each label (or a strip of labels) after it is printed. In Peel-Off mode, the backing material is peeled away from the label as it is printed. When printing batches, after you remove the label, the next one is printed.

Loading Media Procedure

1. Open the printer (Refer to Figure 10).
- Press the Media Cover Button on the side of the printer as shown in “1” below. The Media Cover will open automatically.
 - Rotate the Media Cover back completely as shown in “2”, exposing the media compartment and adjustable media supports.

Figure 10 • Opening the Printer

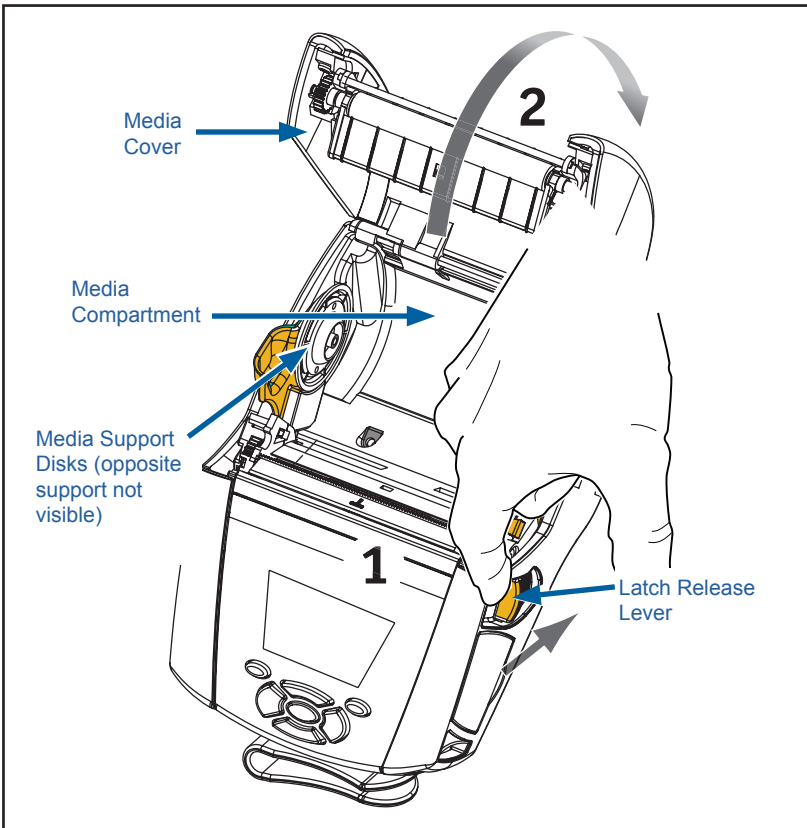

2. Pull the media supports apart as shown in Figure 11 below. Insert the roll of media (in the orientation shown) between the supports and let the supports secure the media in place. The supports will adjust themselves to the width of the media, and the media roll should be able to spin freely on the supports.

Figure 11 • Loading Media

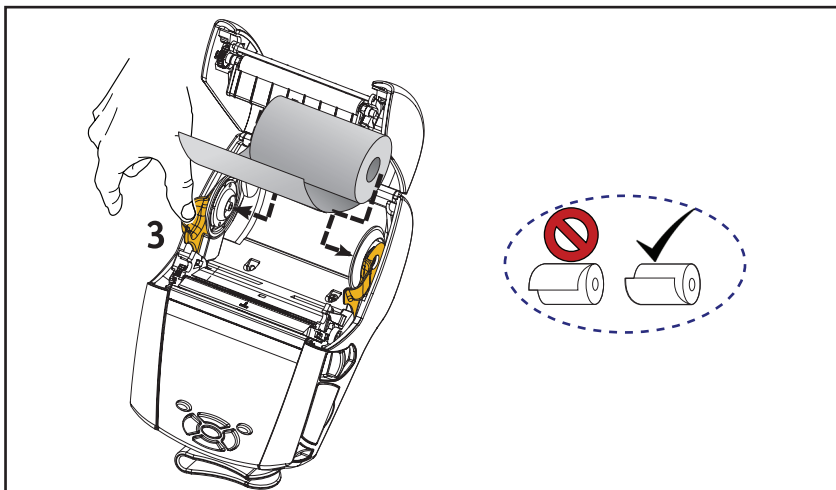

3. If you plan to use the printer in tear-off mode, close the media covers shown below.

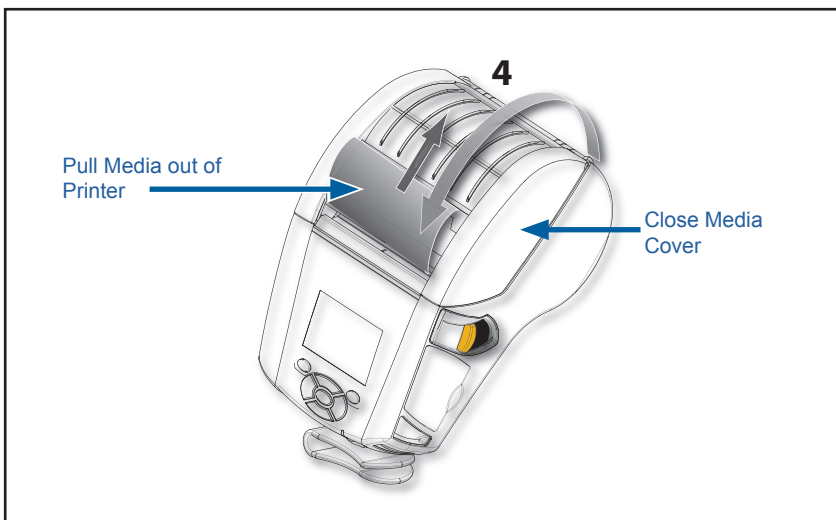

Note • Please refer to the Programming Guide (P1012728-010) for information on changing the setting to adjust the media feed length via a Set-Get-Do (SGD).

Loading Media in Peel-off Mode

- If you plan to use the printer in the peel-off mode, peel a few labels off of the media and load the media as previously described.
- Push the peeler lever forward to release the peeler bail into the “up” position as shown at “3” and “4” in Figure 12.
- Close the media cover to lock the peeler bail in place. The media will feed between the peeler bail and platen.

Figure 12 • Activating Peeler Bar (ZQ620 Shown)

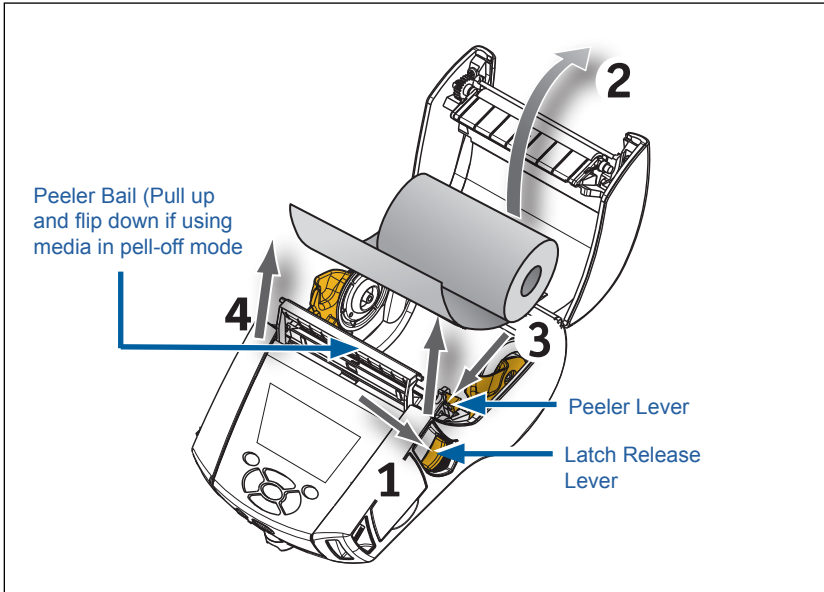

- Turn on the printer or press the Feed button on the front of the printer if the printer is already on. The printer will advance the media to the next label, if printing labels. If you are printing on journal media, the printer will advance a short strip of media.

To disengage the peeler bail, first open the media cover as previously described. The peeler bail will automatically return to the Up position. Press straight down on the peeler bail to lock it in place in its original home position.

ZQ6 Healthcare Printers

The ZQ6 Healthcare 2” and 3” printers are designed to meet the specific and unique needs of the healthcare environment. The healthcare application is based on the ZQ610 and ZQ620 printers primarily for barcode label printing, but also retaining the ZQ6’s ability to print receipts.

The ZQ610 and ZQ620 Healthcare printers also offer a few key enhancements to these existing printers:

- Provide printers with distinctive white and blue healthcare colors and performance plastics that can also be disinfected with the most common cleaners used in hospitals.
- Leverage the technology advancements made on the ZQ6 platform, i.e. new LCD display, 802.11ac/BT4.1 dual radio, NFC, QR code.

Figure 13 • ZQ620 Healthcare Printer



Since the ZQ610 and ZQ620 Healthcare printers are based on the ZQ610 and ZQ620 platform, they are designed to be direct thermal printers which support variable print widths. They will provide a print experience compatible to the ZQ610 and ZQ620, specifically in the following areas:

- They will support the same barcodes, barcode quality, and visual print quality.
- They will offer equal wireless performance in terms of range, reliability, and speed.
- They will be compatible with all ZQ6 accessories, but they do have a separate IEC60601 AC adapter exclusive to Healthcare printers.

The ZQ6 Healthcare printers are designed and tested to withstand constant cleaning for the life of the printer.



Important • For detailed information on cleaning the Healthcare printers, refer to the Guide to Disinfecting and Cleaning Zebra Healthcare Printers (p/n P1066640-001) at <https://www.zebra.com/us/en/support-downloads.html>

Operator Controls

The ZQ6 printers come equipped with a keypad control panel and a color LCD graphical user interface. The standard control panel is illustrated in Figure 14. The LCD interface allows easy display and selection of many printer functions as detailed on following pages.

Standard Control Panel

The standard control panel has multiple control buttons and two multipurpose indicators.

- The Power Button turns the printer on and off.
- The Media Feed Button advances a length of media which is determined by the type of media being used. Label media will be advanced to the next gap or bar sense marker. Journal (plain) media will be advanced by a length determined by the printer's software.
- Four Way Navigation Buttons allow the user to scroll between functions on the LCD user space. (The Navigation Buttons do not apply to the Status Bar and Navigation Bar.)
- Enter Button allows the user to select the desired function highlighted on the LCD interface and is indicated by the word "OK".
- Two software defined function keys allow the user to select a function listed on the navigation bar.

Figure 14 • Control Panel



Power Button

Press to turn unit on. There will be approximately a 20 second boot up time. Press for 3 sec. to turn unit off

Feed Button

Press to advance a blank label or a software-determined length of journal media.

Normal Boot-up LED Behavior

1. Press Power (on/off) button to turn the printer on.
2. When Power button is released, the power ring will blink as the printer boots up.
3. When the boot-up sequence is complete, the power ring will stop blinking and remain steadily lit. The color of the power ring depends on the charge status.

Sleep Mode LED Behavior

1. Pressing the Power Button for less than three (3) seconds will put the printer in sleep mode.
2. During Sleep Mode, the Power LED will slowly pulse either Green, Amber or Red depending upon whether or not the printer is charging successfully.

Shutdown Behavior

1. Press the Power Button for approximately three (3) seconds to turn the printer off.
2. The “Shutting Down” alert message will appear on the LCD prior to the printer shutting down.



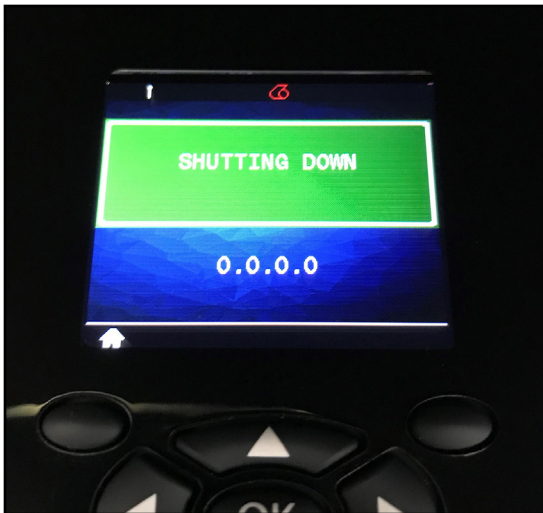





Figure 15 • Printer Shutdown



Power LED Ring Behavior

The Power Button is surrounded by a three-color (green, amber, red) LED ring. The Power LED Ring will:

- Blink once per 2 seconds green/amber/red during boot-up.
- Display solid green when the printer is fully charged while On or Off.
- Pulsing green to indicate Sleep Mode and not charging.
- Solid amber to indicate charging while On or Off.
- Pulsing amber to indicate charging while in sleep mode.
- Solid red to indicate an unhealthy charging or charged battery when not in sleep mode (either On or Off).
- A charge fault will flash red twice per second.
- Pulsing red to indicate unhealthy charging or charged battery when in sleep mode.

	Blink green/amber/red during boot-up
	Power On/Charged Battery
	Pulse green Sleep Mode/Not Charging
	Power On/Battery Charging
	Charging in Sleep Mode
	Charging/Charge Complete (Unhealthy)
	Charging/Charge Complete (Unhealthy/Sleep Mode)
	Charge Fault

LCD Control Panel

The color LCD control panel allows the user to view the status of the ZQ6 printers and have access to various printer alerts and messages. It also has multi-directional keys which allow navigation and selection of menu options affecting printer functions. These keys allow scrolling through the various options and settings. The “OK” button allows selection of the option or function displayed on the screen.

The top of the screen has a row of status icons, or a Status Bar, which indicate the state of various printer functions. The Status Bar is located above the Status Screen shown below along with a Navigation Bar. The Status Screen is the default display and is shown at power up. When navigating the menus, the printer will automatically return to this screen when the user is done navigating after an appropriate delay.

Figure 16 • LCD Control Panel

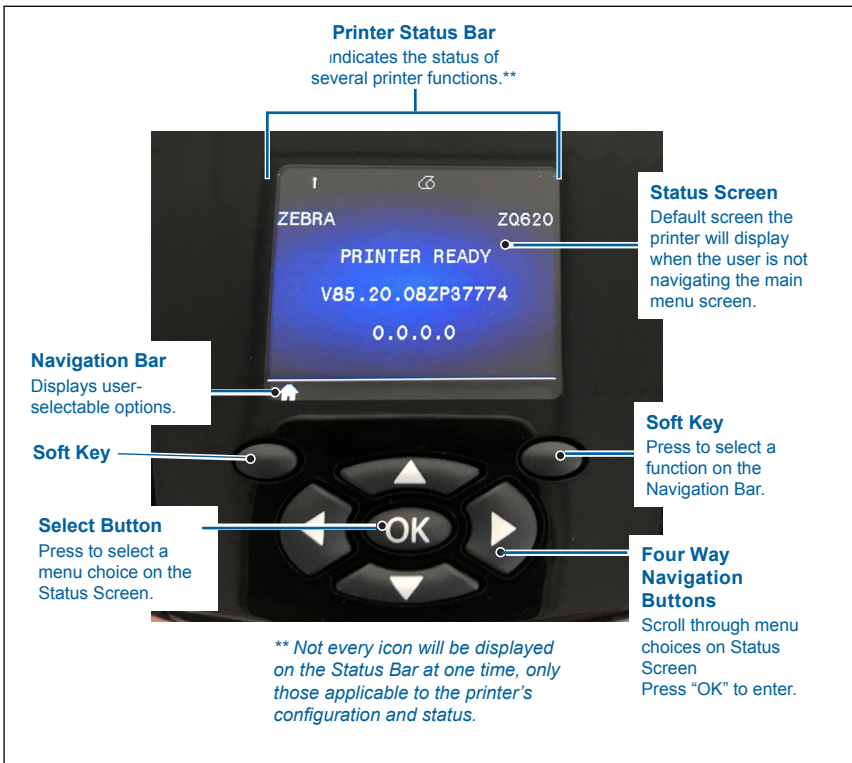

Status Bar Icons



Indicates Bluetooth® connection status. The icon will blink to show that the printer is receiving label data via Bluetooth, and is **solid blue** when link is established. This icon appears only on printers with the Bluetooth wireless option installed.



Indicates that the printer is connected to a radio network via 802.11 protocols. The antenna icon will blink with no parentheses when looking for an access point. One set of solid parentheses with blinking antenna indicates WLAN is associated and attempting authentication. Two sets of solid parentheses and solid antenna indicate the printer is successfully connected to the WLAN.

The icon and two parentheses will blink to show the printer is receiving printer data via WLAN. The four (4) bars  indicate the strength of the WLAN connection to the access point. These icons appear only with the 802.11 radio installed, i.e. one **solid yellow** bar, two **solid green** bars, three **solid green** bars and four **solid green** bars.



The Ethernet icon will **blink green** when the printer is receiving label data via the Ethernet connection and **solid green** when connected. It will not be displayed on the status bar when the Ethernet is inactive. This icon appears only when the Ethernet option is installed and the printer is docked in Ethernet cradle.



The Data icon indicates data being sent to the printer, i.e. the icon will **blink green** when there is a label data transmission via the serial or USB ports. It will be **solid green** when the parser is locked.



The Media Out icon will **blink red** when there is no media in the printer and will appear solid white when there is media in the printer.



The Head Latch icon indicates if the media cover is closed or not properly latched. It will appear unlocked and **blinking red** if open and will not appear if the cover is closed.



The Error icon will be displayed and **blink red** if an error condition exists. The icon will not be displayed if no printer error exists. Since there are separate icons for Media Out and Head Latch Open, these two alerts do not apply to the Error icon.



The Battery Charge Level icon indicates the reported state of charge from the battery pack. In a non-charging state, four (4) **solid green** bars indicates the battery level is greater than 80%. Three (3) **solid green** bars indicates if the battery level is less than or equal to 80% but greater than 60%. Two (2) **solid yellow** bars indicates if the level is less than or equal to 60% but greater than 40%. One (1) **solid red** bar indicates if the battery level is less than or equal to 40% but greater than 20%. And zero (0) bars (**solid red** battery outline) indicates if the level is less than or equal to 20%.

While the battery is charging, a lightning bolt will appear in the battery icon  to indicate that charging is taking place. When the battery is charging and fully charged, four **blinking green** bars will be displayed. When the battery is charging and the level is greater than 80%, the battery icon will alternate between four bars and three **blinking green** bars. When the battery is charging and the level is less than or equal to 80% but greater than 60%, the icon will alternate between three bars and two **blinking yellow** bars. When the battery is charging and the level is less than or equal to 60% but greater than 40%, the icon will alternate between two bars and one **blinking red** bar. When the battery is charging and the level is less than or equal to 40% the icon will alternate between one bar and zero **blinking red** bars.

Home Menu Screen

The printer's control panel includes a display where the user can view the printer's status or change its operating parameters. After the printer completes the power-up sequence, it moves to the Idle Display screen (Figure 17). This screen includes the printer's current status, information such as firmware version and IP address, and a Home menu shortcut.

Press the left soft key to go to the Home Menu screen which displays graphical parameter options including Settings, Tools, Network, Battery, Language, Sensors, Ports, and Bluetooth (as shown in Figure 17). These options allow the user to view the printer's status or change its operating parameters.

Figure 17 • Home Menu Screen

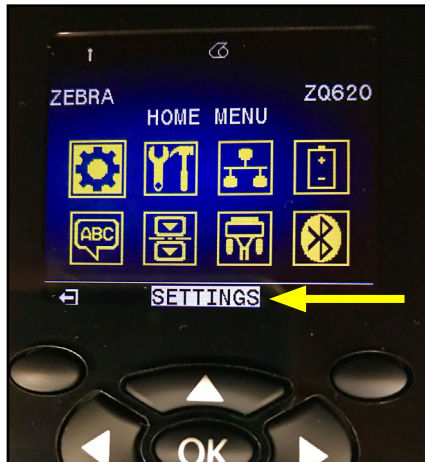

The user can scroll between icons using the four-way arrow buttons. When an icon is highlighted (i.e. Settings), its text description will be displayed in the middle of the navigation bar (see arrow in Figure 17), and can be selected by pressing the "OK" button. This will take the user to the first screen (i.e Darkness) under that parameter, which gives the user status information specific to that option (see Figure 18). In order to navigate to the next screen, click on the right arrow button.

Figure 18 • Parameter Menu Screen Example

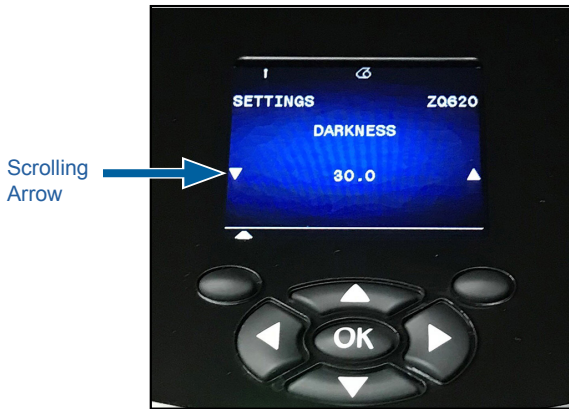





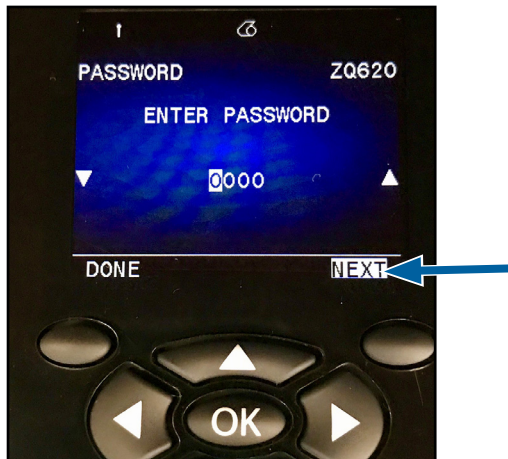



Some parameter settings like the Darkness setting above have a scroll option to view multiple setting choices. This option is identifiable by the presence of up and down scrolling arrows located on either side of the display (see Figure 18). Press the up and down arrows on the keypad to scroll through a menu's options. In some cases, further actions will appear on the right side of the status screen (see arrow in Figure 19). Press the right soft key to initiate said action.

Figure 19 • Scrolling Menu



Click on the left soft key to exit the screen and again to return to the Home Menu screen to choose a different parameter.

Home Screen Icons and Parameters

Icon	Parameter
	See Settings menu in Appendix D
	See Tools menu in Appendix D
	See Network menu in Appendix D
	See Battery menu in Appendix D
	See Language menu in Appendix D
	See Sensors menu in Appendix D
	See Ports menu in Appendix D
	See Bluetooth menu in Appendix D

Alert Messages

The ZQ6 printers will also display various blinking alerts, such as “Media Out”, “Media Cover Open”, or “Battery Low”. These alerts are broken up into Errors, Warnings and Info with different color mapping used to differentiate one from the other (see table below).

	INFO	WARNING	ERROR
Foreground Color (Text)	White	Black	White
Background Color	Green	Yellow	Red

Figure 20 • Error Alert Message









The user can respond to actions by pressing one of the soft keys to indicate that an action has been taken to address the alert in question. Once the condition causing the alert has been addressed (i.e. loading media), the alert message will be cleared. (See Appendix G for a complete list of alerts for the ZQ6 printers.)

Buttons

The user has the ability to use the ZQ6's multi-button interface to run the following power-up and runtime sequences.

Power-Up Sequences

Seq. #	Function	Keys	Button
1	Two Key Report	Hold down Feed button while pressing power button	 
2	Revert to Factory WML	Hold down the UP and DOWN arrows while pressing power button	 
3	Forced Download	Hold down both soft keys while pressing power button	 
4	Turn printer On or Off or to enter Sleep Mode	Power button	



Note • A user would need to revert to factory WML if some features were turned off in the custom WML and there is a need to get to the “full” menu. Also, if a change was made that caused the WML system to lock up, the user can reboot and restore functionality temporarily in order to fix the mistake.



Note • A forced download is when the printer is powered up in a mode wherein it is running only the code that allows for firmware downloads to happen.

Runtime Sequences without LED Flashes

Seq. #	Function	Keys	Button
1	Media Feed	Feed	
2	Wake, if in Sleep Mode	Any button	

Sleep Mode

The Sleep Mode feature is a way the printer conserves battery life whereby the printer will automatically go into a “sleep” state after twenty (20) minutes of inactivity. When the printer is in this state there will be no content displayed on the LCD in addition to no backlight. The printer will indicate Sleep Mode by a slow blinking green LED ring around the Power Button.

If the Power Button is pressed for less than three (3) seconds, then the printer will go into sleep mode. The printer will indicate this on the LCD in the form of a “Sleeping” Info Alert (see Figure 21), which disappears when the display turns off.

Figure 21 • Sleep Mode Info Message



When the printer is in sleep mode, the green LED ring around the power button will pulse approximately once every three seconds. Pressing any button on the printer will wake the printer from sleep mode. Other power management features of the ZQ6 printers include “wake on Bluetooth” and “wake on WiFi” whereby the printer exits sleep mode due to data exchanged via Bluetooth 4.1 or a network message received over WiFi. The printer will not enter sleep mode when docked in an Ethernet cradle.

To enable or disable Sleep Mode, send the `power.sleep.enable` command to the printer using Zebra Setup Utilities (ZSU) and set it to either “on” or “off”. (The default setting is “on”.) To set the time after which the printer will enter Sleep Mode, send the `power.sleep.timeout` (in seconds) to the printer using the ZSU.

Adaptive Print Performance

The ZQ6 printers use PSPT PrintSmart Gen 2 technology which adapts to your print conditions such that print quality is not sacrificed. When the printer sees environmental conditions such as state of charge, battery health, cold temperature extremes, or high density printing, the printer will adjust print performance to preserve battery function and allow printing to continue. This may affect the speed and sound of printing but not the print quality.

Draft Mode

The user can configure the printer to print in Draft Mode via SGD command `media.draft_mode` (default is “off”), which optimizes the printer for text-only printing. While in Draft Mode, print speed increases from 4 inches per second (ips) to 5 ips with approximately a 22% reduction in optical density.



Note • For an explanation and a list of all SGD commands, please refer to the *Programming Guide* (p/n P1012728-010) at: <http://www.zebra.com/us/en/support-downloads.html>

Verify the Printer is Working

Before you connect the printer to your computer or portable data terminal, make sure that the printer is in proper working order. You can do this by printing a configuration label using the “two key” method. If you can’t get this label to print, refer to “Troubleshooting”.

Printing a Configuration Label

1. Turn the printer off. Load the media compartment with journal media (media with no black bars or gaps on the back)
2. Press and hold the Feed Button.
3. Press and release the Power button and keep the Feed button pressed. When printing starts, release the Feed button. The unit will print a line of interlocking “x” characters to ensure all elements of the print head are working, print out the version of software loaded in the printer and then print the report.

The report indicates model, serial number, baud rate, and more detailed information on the printer’s configuration and parameter settings. (See the Troubleshooting Section for sample printouts and a further discussion on how to use the configuration label as a diagnostic tool.)

Connecting the Printer

The printer must establish communications with a host terminal which sends the data to be printed. Communications occur in four basic ways:

- ZQ6 printers can communicate by cable via either RS-232C or USB 2.0 protocols. Windows drivers that support printing via Serial, USB and the network are included in the Zebra Designer Driver which can be downloaded from www.zebra.com/drivers.
- By means of a wireless LAN (Local Area Network) per 802.11 specifications. (Optional)
- By means of the Ethernet when docked on the Ethernet cradle.
- By means of a Bluetooth short range radio frequency link.
- WinMobile®, Blackberry®, and Android® devices use standard Bluetooth protocol.
- ZQ6 printers are compatible with iOS devices, therefore printing via Bluetooth to an Apple® device is possible.



Cable Communication



Caution • The printer should be turned off before connecting or disconnecting a communications cable.

The ZQ6 printers can communicate by cable; the specific cable supplied with your printer will vary with the host terminal and your model printer.

RS-232C Communications

The 14-pin serial connector on your communications cable plugs into the serial communications port on the side of the printer. ZQ6 printers also have a USB port.

USB Communications

The small 5-pin connector on the USB cable plugs into the printer. The connectors are keyed to assure correct alignment; do not try to force the cable if it does not plug in.

Figure 22 • Communications Options

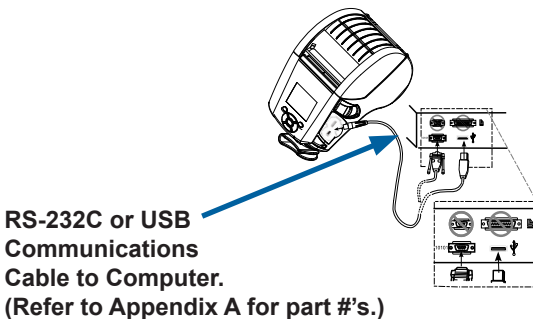
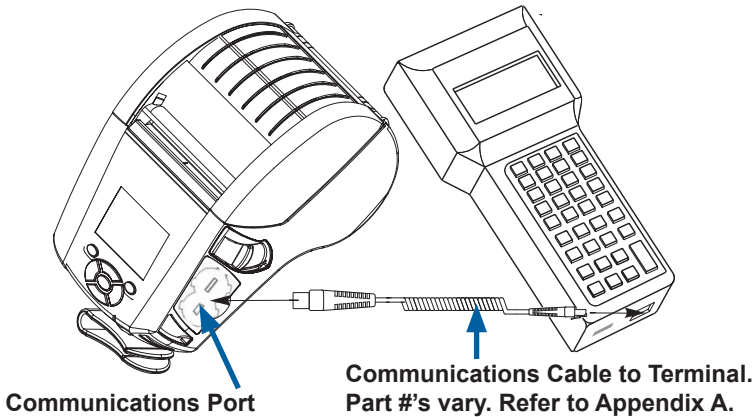

The other end of the cable must be plugged into the host terminal as shown in Figure 22, or to a serial or USB port on a computer. The ZQ6 printers are configured with the USB Open HCI interface driver allowing it to communicate with Windows® based devices.

Zebra Designer Driver uses Windows drivers that support printing via Serial, USB and the network. Other terminals or communications devices may require the installation of special drivers to use the USB connection. Consult the factory for further details.

Providing Strain Relief for Communications Cable

If you are connecting either a USB or RS-232 communications cable to the printer permanently, access the communications port on the side of the printer next to the latch release lever. Plug the connector into the appropriate port and align the plastic locking cap with the cut outs shown below. Rotate the locking cap clockwise to lock the cable in place. (Turn counter clockwise to unlock the cable.) Once locked in place, this provides strain relief for the cable and will prevent the cable from disconnecting from the printer.



Note • Only one cable can be present in the USB/RS-232 communications port at a time for strain relief purposes.

Zebra Setup Utilities

Before you start to configure your printer for use on a Local Area Network (LAN), you will need some basic information which will enable you to establish the network configuration for your printer. Zebra Setup Utilities (ZSU) provides a quick and easy way to configure your printers for a variety of purposes, including setting them up for wireless communications either on a Local Area Network (LAN) or using the international Bluetooth™ communications standard.

Once ZSU has been downloaded to your computer, attach the USB cable to the printer and computer as shown in Figure 22. Refer to Wireless Configuration Guide (p/n P1048352-001) to follow the steps necessary for setting up and configuring your printer via ZSU.

Go to <https://www.zebra.com/us/en/support-downloads.html> to download ZSU and the Wireless Configuration Guide. (See Appendix H for details on navigating zebra.com.)

Zebra Android Printer Setup Utility (for Link-OS Printers)

The ZQ6 printers can also be configured using the Zebra Android Printer Setup Utility. This utility can be downloaded from Google Play to an Android device such as a smartphone or the TC51 or TC56 mobile handheld computers. The Android mobile device can be paired with the printer via Bluetooth or a USB cable and users can quickly navigate the app to perform the following tasks.

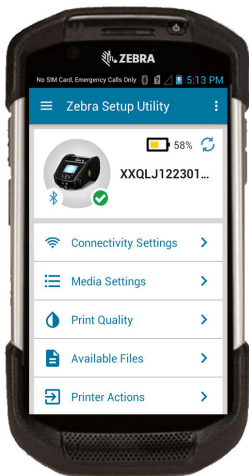

Shows currently connected printer

Displays current printer status:

 = all clear

 = error present

Quick access to Wizards, Printer Actions and Files

Figure 23 • Setup Utility Main Screen

Wireless Communications with Bluetooth

Bluetooth is a worldwide standard for the exchange of data between two devices via radio frequencies. This form of point-to-point communication does not require access points or other infrastructure. Bluetooth radios are relatively low powered to help prevent interference with other devices running at similar radio frequencies. This limits the range of a Bluetooth device to about 10 meters (32 feet). The default for ZQ6 is Class 2, but the range can be set to Class 1 via a SGD (`bluetooth.power_class`) to increase power. Both the printer and the device it communicates with must follow the Bluetooth standard.

Bluetooth Networking Overview

Each Bluetooth enabled ZQ6 printer is identified by a unique Bluetooth Device Address (BDADDR). This address resembles a MAC address whereby the first three bytes are vendor, and the last three bytes are device (e.g. 00:22:58:3C:B8:CB). This address is labeled on the back of the printer via a barcode for ease of pairing. (For the dual radio, the MAC address label only represents WiFi MAC address.) (see page 57.) In order to exchange data, two Bluetooth enabled devices must establish a connection. Bluetooth software is always running in the background, ready to respond to connection requests. One device (known as the client) must request/initiate a connection with another. The second device (the server) then accepts or rejects the connection. A Bluetooth enabled ZQ6 printer will normally act as a follower creating a miniature network with the terminal sometimes referred to as a “piconet”. Discovery identifies Bluetooth devices that are available for pairing whereby the controller device broadcasts a discovery request and devices respond. If a device is not discoverable, the controller cannot pair unless it knows the BDADDR or has previously paired with the device. If both devices support Bluetooth 2.1 or higher they will use Security Level 4 Secure Simple Pairing (SSP), a mandatory security architecture that features two (2) association models: Numeric Comparison and Just Works (no user confirmation).

Bluetooth Security Modes

<p>Security Mode 1</p> <p>If a BT \geq 2.1 device is pairing with a BT \leq 2.0 device, it falls back to BT 2.0 compatibility mode and behaves the same as BT 2.0. If both devices are BT \geq 2.1, Secure Simple Pairing must be used according to the BT spec.</p>	<p>Security Mode 2</p> <p>If a BT \geq 2.1 device is pairing with a BT \leq 2.0 device, it falls back to BT 2.0 compatibility mode and behaves the same as BT 2.0. If both devices are BT \geq 2.1, Secure Simple Pairing must be used according to the BT spec.</p>	<p>Security Mode 3</p> <p>If a BT \geq 2.1 device is pairing with a BT \leq 2.0 device, it falls back to BT 2.0 compatibility mode and behaves the same as BT 2.0. If both devices are BT \geq 2.1, Secure Simple Pairing must be used according to the BT spec.</p>
--------------------------------------------------------------------------------------------------------------------------------------------------------------------------------------------------------------------------------------------------------------------------------------------------------------------	--------------------------------------------------------------------------------------------------------------------------------------------------------------------------------------------------------------------------------------------------------------------------------------------------------------------	--------------------------------------------------------------------------------------------------------------------------------------------------------------------------------------------------------------------------------------------------------------------------------------------------------------------

<p align="center">Security Mode 4: Simple Secure Pairing</p> <p>Simple Secure Pairing: a new security architecture introduced supported in BT \geq 2.1. Service-level enforced, similar to mode 2. Mandatory when both devices are BT \geq 2.1. There are four association models currently supported by mode 4. Security requirements for services must be classified as one of the following: authenticated link key required, unauthenticated link key required, or no security required. SSP improves security through the addition of ECDH public key cryptography for protection against passive eavesdropping and man-in-the-middle (MITM) attacks during pairing.</p>

Numeric Comparison	Just Works
<p>Designed for situation where both devices are capable of displaying a six-digit number and allowing user to enter “yes” or “no” response. During pairing, user enters “yes” if number displayed on both devices matches to complete pairing. Differs from the use of PINs in legacy (BT \leq 2.0) pairing because the number displayed for comparison is not used for subsequent link key generation, so even if it is viewed or captured by an attacker, it could not be used to determine the resulting link or encryption key.</p>	<p>Designed for situation where one (or both) of the pairing devices has neither a display nor keyboard for entering digits (e.g. Bluetooth headset). It performs authentication step 1 in the same manner as as numeric comparison, but the user cannot verify that both values match, so MITM (man-in-the-middle) protection is not provided. This is the only model in SSP that does not provide authenticated link keys.</p>

Each mode, except for Just Works, has Man-In-The-Middle (MITM) protection, meaning no third device can view the data being passed between the two devices involved. The SSP mode is usually negotiated automatically based on the capabilities of both the controller and follower. Lower security modes can be disabled via the `bluetooth.minimum_security_mode` SGD. The `bluetooth.minimum_security_mode` SGD sets the lowest security level at which the printer will establish a Bluetooth connection. The printer will always connect at a higher security level if requested by the controller device. To change the security mode and security settings in the ZQ6 printers, use Zebra Setup Utilities.

Bluetooth Minimum Security Modes

	BT Version of Controller Device (>2.1)
<code>bluetooth.minimum_security_mode=1</code>	Secure Simple Pairing Just Works/Numeric Comparison
<code>bluetooth.minimum_security_mode=2</code>	Secure Simple Pairing Just Works/Numeric Comparison
<code>bluetooth.minimum_security_mode=3</code>	Secure Simple Pairing Numeric Comparison
<code>bluetooth.minimum_security_mode=4</code>	Secure Simple Pairing Numeric Comparison
<code>bluetooth.bluetooth_PIN</code>	Not Used



`bluetooth.minimum_security_mode` **sets the lowest security level at which the printer will establish a Bluetooth connection. The printer will always connect at a higher security level if requested by the controller device.**

The ZQ6 printers also feature bonding for Bluetooth. The printer caches pairing info so devices stay paired through power cycles and disconnects. This eliminates the need to re-pair on every connection establishment.

The `bluetooth.bonding` SGD is on by default.



Note • For detailed information on Bluetooth, please refer to the Bluetooth Wireless User Guide (P1068791-002) at: <http://www.zebra.com/us/en/support-downloads.html>

In addition, the ZQ6 printers support passive Near Field Communication (NFC) technology. Using the “Print Touch” feature located on the side of the printer, end-users can automatically pair with a handheld device that supports NFC technology. The NFC tag has the printer’s BDADDR encoded in a URL on the tag. Simply touching the NFC handheld device to the “Print Touch” icon on the printer will connect and pair the handheld device to the printer.

WLAN Overview

ZQ6 printers are optionally equipped with a Dual Radio that uses the industry standard 802.11 protocols and Bluetooth 4.1. They will have the FCC ID number on the serial number label on the back of the unit.

- ZQ6 Wireless Network Printers with the Zebra 802.11 WLAN radio module can be identified by the text “Wireless Network Printer” on the serial number label on the back of the printer.
- These printers allow communication as a node within a wireless local area network (WLAN). Methods of establishing communications to the printer will vary with each application.

More information and LAN configuration utilities are included in the ZebraNet Bridge Enterprise™ program (version 2.8 and later).

Zebra Setup Utilities (ZSU) and Zebra Mobile Setup Utility can also be used to configure WLAN communications settings. Both ZebraNet Bridge Enterprise and ZSU may be be downloaded from the Zebra Web site.

Figure 24 • BT/WLAN Communications



Setting Up the Software

ZQ6 printers use Zebra's CPCL, ZPL or EPL Programming languages which were designed for mobile printing applications. CPCL and ZPL are fully described in the ZPL Programming Guide (p/n P1012728-010), CPCL Programming Guide (p/n P1073699-001) and ZPL II Programming Guide (p/n 46530L) available on-line at <https://www.zebra.com/us/en/support-downloads.html>. You can also use ZebraDesigner Pro v2, Zebra's Windows® based label creation program which uses a graphical interface to create and edit labels in either language. Refer to Appendix H for tips on downloading the Designer Pro application from Zebra's Web site.

Designing Labels

The following examples provide guidelines for designing labels for the ZQ6 printers, specifically for Gap Media, Black Bar Media and Journal Media. The illustrations for each media type define recommended tolerances, keep-out zones and safe printing zones designed to avoid any vertical registration issues during printing. Dimensions are determined based on product registration capabilities and Zebra-recommended media tolerances.

Figure 25 • Gap Media

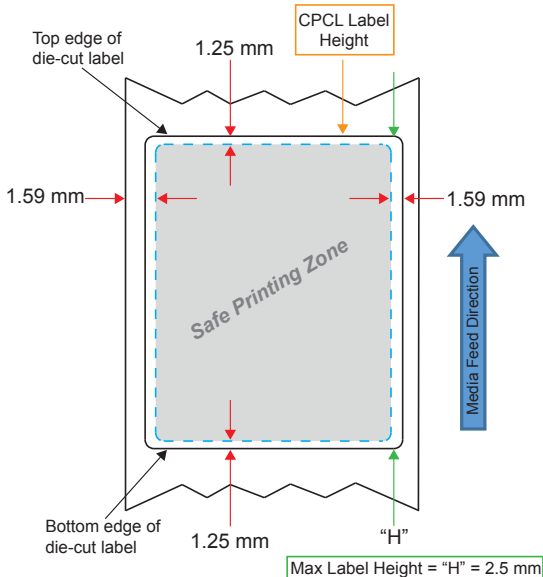

Figure 26 • Journal Media

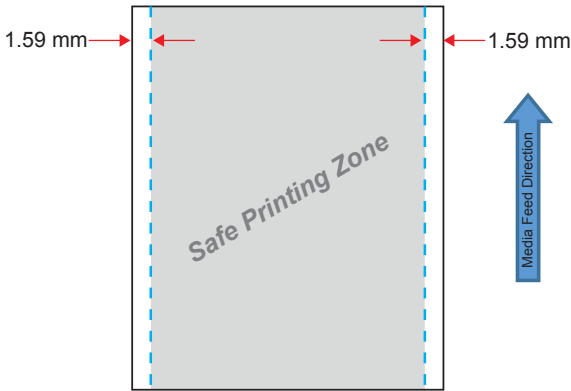
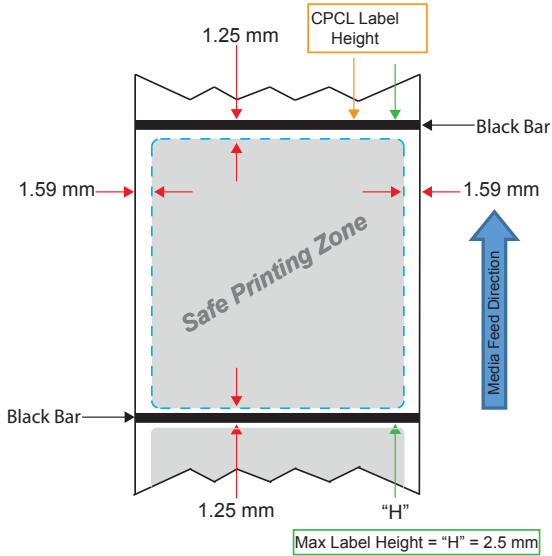

Figure 27 • Black Bar Label Media



Using Pre-Printed Receipt Media

ZQ6 printers support alignment of pre-printed receipts by using the out of paper sensor located near the printhead.

Black Mark Dimensions (Receipt Media)

The reflective media black marks (or black bar/marks) should extend past the centerline of the roll on the front side of the paper.

- Minimum mark width: 0.59 in. (15 mm) perpendicular to the edge of the media, and centered within the width of the roll.
- Mark length: 0.19 - 0.24 in. (4.8 - 6.0 mm) parallel to the edge of the media.

Label Areas

The media/black bar sensor detects the dark, pre-printed bar on the media, so a path in the center of the paper must be kept free of dark, pre-printed graphics.



Note • *Dark, pre-printed graphics refer to any symbols, barcodes, text and/or colored areas that have been applied to the receipt paper rolls before they have ever been used in the printer.*

Figure 28 • Label Areas

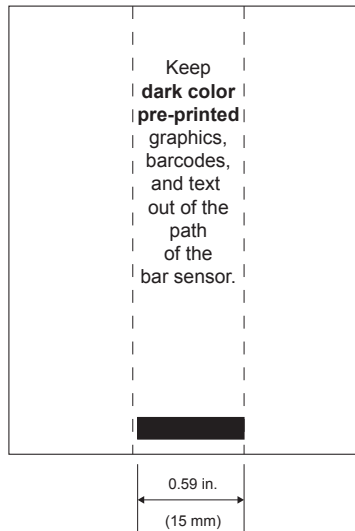

Label Design Examples

This section shows examples of labels with and without problems.

Figure 29 • Label Design Examples

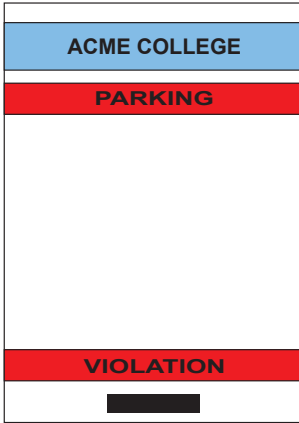

PROBLEM LABEL DESIGN

The dark color, pre-printed text and graphics are in the path of the black bar at the bottom of the receipt.

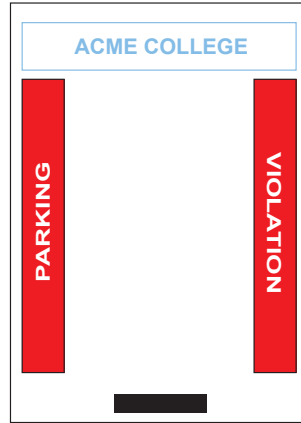

GOOD LABEL DESIGN

The center path to the black bar is free of dark color, pre-printed text and graphics.

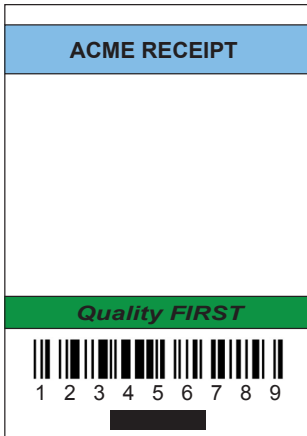

PROBLEM LABEL DESIGN

The dark color, pre-printed text and graphics are in the path of the black bar at the bottom of the receipt.



GOOD LABEL DESIGN

The center path to the black bar is free of dark color, pre-printed text and graphics.



Note • Complete information on using pre-printed receipt paper can be found in the FORM command in the CPCL Programming Guide (P1073699-001) at www.zebra.com/manuals.

Keep-Out Areas

At times, incomplete printing of text and/or graphics appear because minimum margins are not provided during label design. The recommended minimum margins, or “keep out areas” are shown in Figure 30.

Figure 30 • Keep Out Areas

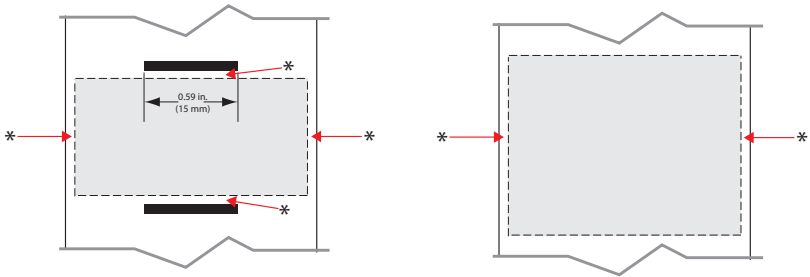

Receipt Paper with Black Bars

* Maintain a minimum “keep out area” of 1/16 in. (1.59 mm) from the two outer edges of the paper roll and from the black bars.

Continuous Receipt Paper (without Black Bars)

* Maintain a minimum “keep out area” of 1/16 in. (1.59 mm) from the two outer edges of the paper roll.



Note • The length of each “continuous” receipt is determined by the data sent to the printer.

Near Field Communication (NFC)

Devices using NFC may be *active* or *passive*. A passive device, such as a ZQ6 Series printer with an NFC tag, contains information that other devices can read but does not read any information itself. An active device, such as a smartphone, can read the information on the printer's NFC tag, but the tag itself does nothing except transmit the info to authorized devices.

Figure 31 • Near Field Communication (NFC) Pairing



NFC Use Cases

- *Bluetooth Pairing* – used to cause a tablet, smart phone or terminal to automatically pair with the printer via a Bluetooth connection, within the bounds of the security profile being used. This shall contain the BT address and serial number of the printer.
- *App launching* – used to cause an app, developed either by Zebra or a third party to be executed on a smart phone, tablet or terminal
- *Web site launching* – used to cause a smart phone, tablet or terminal to display a web site developed by Zebra or a third party developer



Note • Tapping the Zebra Print Touch™ icon  with a Near Field Communication (NFC) enabled smartphone will provide instant access to printer-specific information. For more information about NFC and Zebra products, go to <http://www.zebra.com/nfc>. Bluetooth pairing applications via NFC is also possible. Please see Zebra Multi-platform SDK for more information.

Wearing the Printer

Swivel Belt Clip

The ZQ610 and ZQ620 printers have a plastic swivel belt clip included as a standard feature. (It should be noted that ZQ6 printers with extended capacity battery do not come equipped with a belt clip.) To use: hook the clip over your belt, and ensure that the clip is securely attached to the belt. The belt clip will pivot to allow you to move freely while wearing the printer. In order to install or remove the plastic Belt Clip you will need to remove the battery pack.

Figure 32 • Printer with Belt Clip



Adjustable Shoulder Strap

Refer to Figure 33 if your printer is equipped with the shoulder strap option (p/n P1031365-192).

Figure 33 • Using the Optional Shoulder Strap



1. Insert the end of the shoulder strap behind the post on the front side of the printer and loop it around the post.



2. Insert the hole on the end of the strap over the metal post (circled) to secure.



3. Repeat the same steps on the opposite side of the printer.

Soft Case

ZQ6 printers have soft case options that also allow you to carry the printer from your belt. The ZQ620 is P1031365-029, and the ZQ610 accessory kit is P1031365-044.

Figure 34 • Using the Soft Case



1. Lift up the top flap of the soft case which is secured with Velcro.



2. Slide the printer into the case such that the LCD display is visible through the plastic window.



Note • *The shoulder strap option can be used with the soft case by securing the ends of the shoulder strap on the two metal rings on the soft case.*

Hand Strap

The ZQ6 hand strap accessory (p/n P1031365-027) attaches to the printer's cut-outs to provide the user with a convenient and secure method of carrying the printer.

Figure 35 • Using the Hand Strap



1. Insert the loop on the end of the strap through the cut out on the front of the printer as shown below.



2. Loop the end of the strap back around the cut out and secure it over the button.



3. Repeat this process for the opposite end of the strap.

Preventive Maintenance

Extending Battery Life

- Never expose the battery to direct sunlight or temperatures over 40° C (104° F) when charging.
- Always use a Zebra charger designed specifically for Lithium-Ion batteries. Use of any other kind of charger may damage the battery.
- Use the correct media for your printing requirements. An authorized Zebra re-seller can help you determine the optimum media for your application.
- If you print the same text or graphic on every label, consider using a pre-printed label.
- Choose the correct print darkness, and print speed for your media.
- Use software handshaking (XON/XOFF) whenever possible.
- Remove the battery if the printer won't be used for a day or more and you're not performing a maintenance charge.
- Consider purchasing an extra battery.
- Remember that any rechargeable battery will lose its ability to maintain a charge over time. It can only be recharged a finite number of times before it must be replaced. Always dispose of batteries properly. Refer to Appendix F for more information on battery disposal.

General Cleaning Instructions



Caution • Avoid possible personal injury or damage to the printer. Never insert any pointed or sharp objects into the printer. Always turn off the printer before performing any cleaning procedures. Use care when working near the tear bars as the edges are very sharp.



Warning • The printhead can get very hot after prolonged printing. Allow it to cool off before attempting any cleaning procedures.



Only use a Zebra cleaning pen (not supplied with the printer) or a cotton swab with 90% medical grade alcohol for cleaning the printhead.



Caution • Use only cleaning agents specified in the following tables. Zebra Technologies Corporation will not be responsible for damage caused by any other cleaning materials used on this printer.

ZQ6 Cleaning

Area	Method	Interval
Printhead	Use a Zebra cleaning pen to swab the thin gray line on the printhead, cleaning the print elements from the center to the outside edges of the printhead.	After every five rolls of media (or more often, if needed). When using linerless type media, cleaning is required after every roll of media.
Platen Surface (Linered)	Rotate the platen roller and clean it thoroughly with a fiber-free swab, or lint free, clean, damp cloth lightly moistened with medical grade alcohol (90% pure or better) (Figure 36).	After every five rolls of media (or more often, if needed)
Platen Surface (Linerless)	Rotate platen roller and clean with a fiber-free swab and 1 part liquid soap (Palmolive or Dawn) and 25 parts water. Use pure water to clean after soap/water mixture. (Figure 37)	Clean platen only if there is an issue during printing, i.e. media not releasing from the platen. (*See Note below.)
Scraper (Linerless Units Only)	Use adhesive side of media to clean scraper on linerless units. (Figure 37)	After every five rolls of media (or more often, if needed).
Tear Bar	Clean thoroughly with 90% medical grade alcohol and a cotton swab. (Figure 36)	As needed
Printer Exterior	Water-dampened cloth or 90% medical grade alcohol wipe.	As needed
Printer Interior	Gently brush out printer. Ensure the Bar Sensor and Gap Sensor windows are free of dust. (Figure 36)	As needed
Interior of units with Linerless Platens	Clean thoroughly with 90% medical grade alcohol and a fiber-free swab. (See Figure 37 for specific target areas for interior cleaning.)	After every five rolls of media (or more often, if needed).



Note • This is an emergency procedure only to remove foreign contaminants (oils, dirt) from the platen that can damage the printhead or other printer components. This procedure will shorten or even exhaust the linerless platen's useable life. If the linerless media continues to jam after cleaning and feeding 1 to 2 meters (3 to 5 feet) of media, replace the platen.

Figure 36 • ZQ6 Cleaning (Lined)

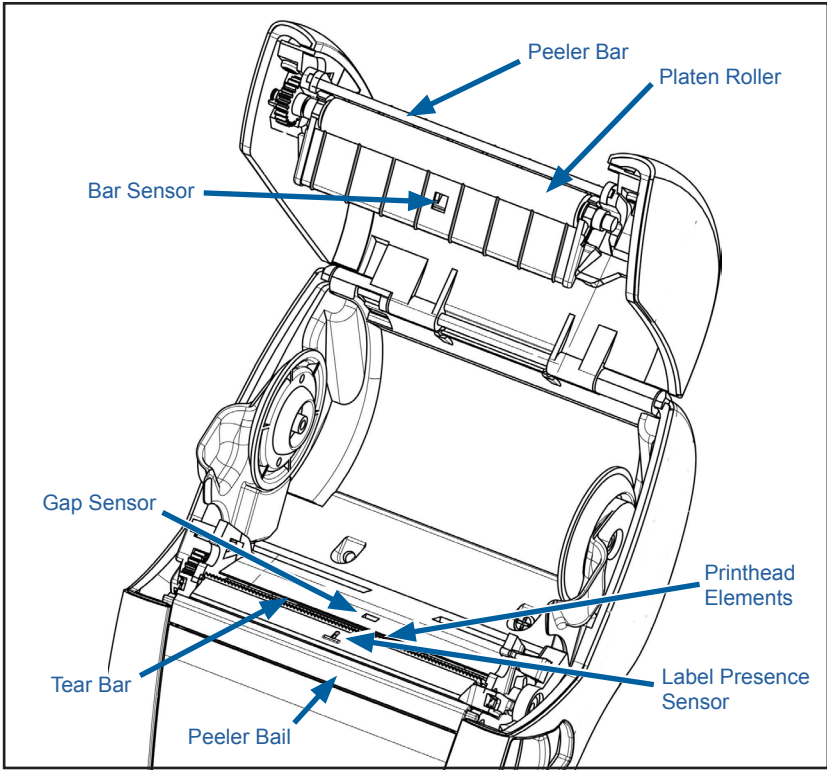
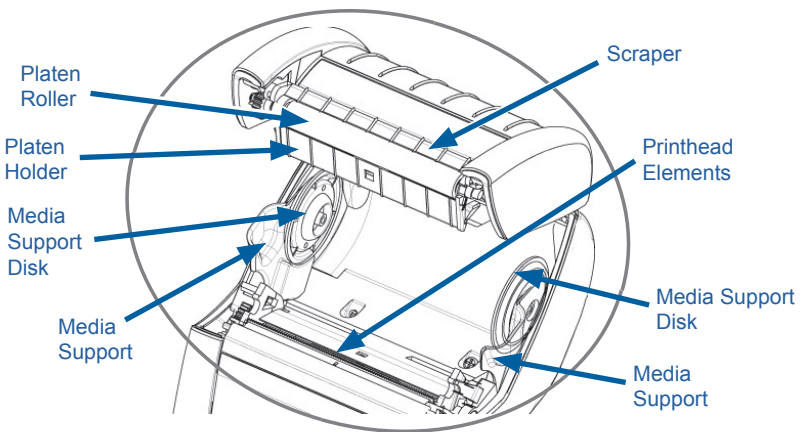

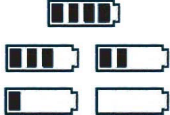
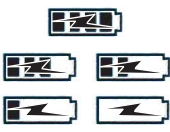





Figure 37 • ZQ6 Cleaning (Linerless)



LCD Control Panel Indicators

The top of the display shows several icons which indicate the status of various printer functions. Check the indicator status, then refer to the Troubleshooting topic referenced in the chart to resolve the problem.

Icon	Status	Indication
	Solid blue	Bluetooth link established
	Not Present	Bluetooth link inactive
	Blinking blue	Connecting or transmitting labels
	Antenna Blinking	Looking for AP
	Antenna Blinking/1 Parenthesis Steady	WLAN Associated & Attempting Authentication
	Antenna and 2 Parentheses Steady	WLAN Associated and Authenticated
	Antenna and 2 Parentheses Blinking	Receiving Data
	Not Present	No Radio Present
	4 Green Bars	>80% charged
	3 Green Bars	60%-80% charged
	2 Yellow Bars	40%-60% charged
	1 Red Bar	20%-40% charged
	0 Bars (Red battery outline)	Low Battery
	4 green Blinking w/ Lightning Bolt	Charging >80% Capacity
	3 green Blinking w/ Lightning Bolt	Charging 60-80% Capacity
	2 yellow Blinking w/ Lightning Bolt	Charging 40-60% Capacity
	1 red Blinking w/ Lightning Bolt	Charging 20-40% Capacity
	0 Bars w/ red Lightning Bolt	Charging <20% Capacity
	Blinking red	Media cover open
	Blinking green	Receiving data
	Solid green	Ethernet Connected
	Not Present	No Ethernet Connection
	Blinking green	Data processing in progress
	Solid green	No data being processed

Icon	Status	Indication
	Blinking red	Out of Media
	Solid white	Media present
	Blinking red	Error exists (excluding Media Out and Head Latch Open)
	Not Present	No error exists
	4 green bars	802.11 signal strength > 75%
	3 green bars	802.11 signal strength <= 75%
	2 green bars	802.11 signal strength <= 50% but >25%
	1 yellow bar	802.11 signal strength <= 25%
	0 Bars	No Signal Strength

Troubleshooting Topics

1. No power:

- Check that battery is installed properly.
- Recharge or replace battery as necessary.



Caution • Always dispose of batteries properly. Refer to Appendix F for more information on proper battery disposal.

2. Media does not feed:

- Be sure media cover is closed and latched.
- Check spindle holding media for any binding.
- Ensure most recently printed label is removed (only in peel mode).
- Ensure label sensor is not blocked.

3. Poor or faded print:

- Clean print head.
- Check quality of media.

4. Partial or missing print:

- Check media alignment.
- Clean print head.
- Ensure media cover is properly closed and latched.

5. Garbled print:

- Check baud rate.

6. No print:

- Check baud rate.
- Replace battery.
- Check cable to terminal.
- Establish RF Link and/or restore LAN associativity.
- Invalid label format or command structure. Place printer in Communications Diagnostic (Hex Dump) Mode to diagnose problem.

7. Reduced battery charge life:

- If battery is older than 1 year old, short charge life may be due to normal aging.
- Check battery health.
- Replace battery.

8. flashing:

- Blinking green Data icon is normal while data is being received.

9. or flashing:

- Check that media is loaded and that the media cover is closed and securely latched.

10. Communication error:

- Check baud rate.
- Replace cable to terminal.

11. Label jam:

- Open head release latch and media cover.
- Remove and reinstall media.

12. Skip Labels:

- Check media for top of form sense mark or label gap.
- Check that the maximum print field has not been exceeded on label.
- Ensure bar or gap sensor is not blocked or malfunctioning.

13. Blank LCD screen:

- Make sure printer is turned on.
- No application loaded or application corrupted: reload program.

14. No NFC Connectivity

- Ensure smartphone is positioned 3 inches (7.62 cm) or closer to the Print Touch icon on the side of the printer.

Troubleshooting Tests

Printing a Configuration Label

To print out a listing of the printer's current configuration follow these steps:

1. Turn the printer off. Load the media compartment with journal media (media with no black bars printed on the back).
2. Press and hold the Feed Button.
3. Press and release the Power button and keep the Feed button pressed. When printing starts, release the Feed button.



Note • The configuration report can also be printed from the Info (Help) menu on the LCD.

Refer to Figures 38 and 38a for sample configuration printouts.

Communications Diagnostics

If there is a problem transferring data between the computer and the printer, try putting the printer in the Communications Diagnostics Mode (also referred to as the “DUMP” mode). The printer will print the ASCII characters and their text representation (or the period ‘.’, if not a printable character) for any data received from the host computer.

To enter Communications Diagnostics Mode:

1. Print a configuration label as described above.
2. At the end of the diagnostics report, the printer will print: “Press FEED key to enter DUMP mode”.
3. Press the FEED key. The printer will print: “Entering DUMP mode”.



Note • If the **FEED** key is not pressed within 3 seconds, the printer will print “DUMP mode not entered” and will resume normal operation.

4. At this point, the printer is in DUMP mode and will print the ASCII hex codes of any data sent to it, and their text representation (or “.” if not a printable character).

Additionally, a file with a “.dmp” extension containing the ASCII information will be created and stored in the printer’s memory. It can be viewed, “cloned” or deleted using the Net Bridge application. (Refer to the ZebraNet Bridge Enterprise documentation for more information.)

To terminate the Communications Diagnostics Mode and re- turn the printer to normal operations:

1. Turn the printer OFF.
2. Wait 5 seconds.
3. Turn the printer ON.

Contacting Technical Support

If the printer fails to print the configuration label, or you encounter problems not covered in the Troubleshooting Guide, contact Zebra Technical Support. Technical Support addresses and phone numbers for your area can be found in Appendix H of this manual.

You will need to supply the following information:

- Model number and type (e.g. ZQ620)
- Unit serial number (Found on the large label on the back of the printer, also found in the configuration label printout.)
- Product Configuration Code (PCC) (15 digit number found on the label on the back of the unit)

Figure 38 • ZQ620 Configuration Label

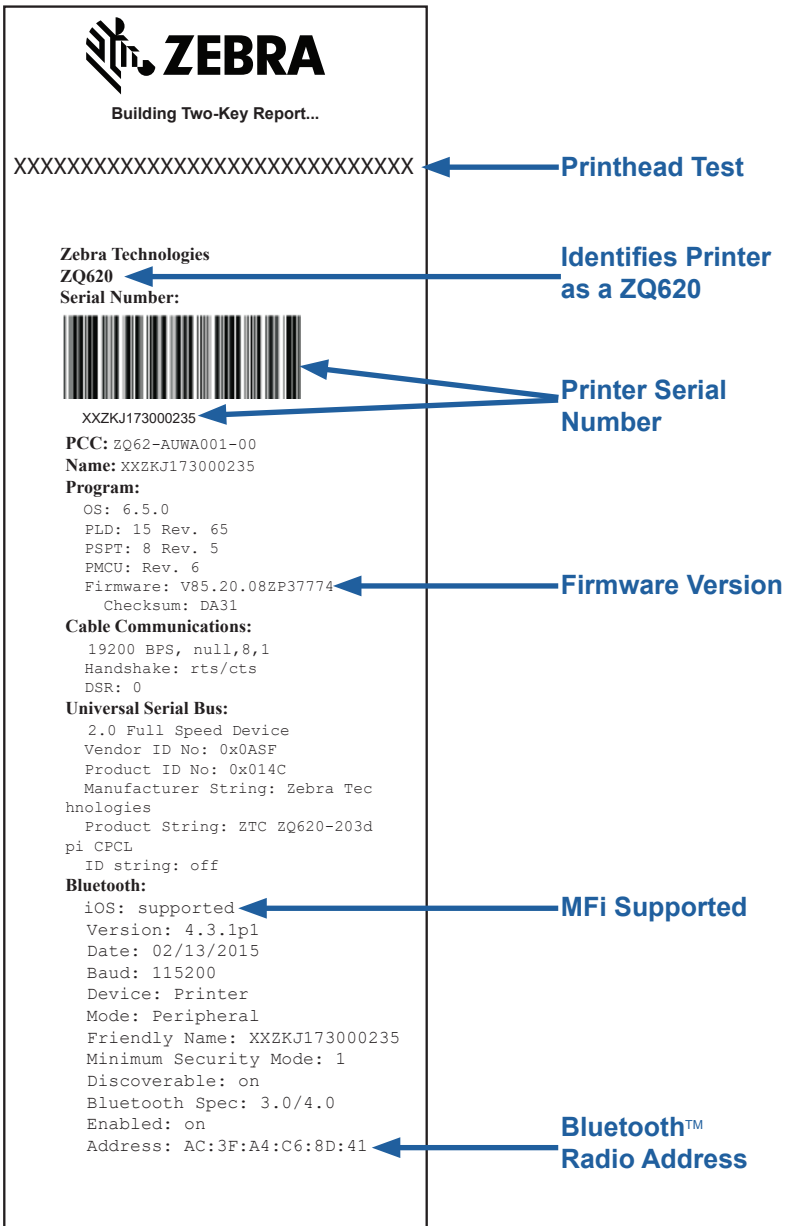

The image shows a Zebra configuration label with various fields and callouts. The Zebra logo and 'Building Two-Key Report...' are at the top. A line of 'XXXXXXXXXXXXXXXXXXXXXXXXXXXXXXXXXXXX' is followed by a callout 'Printhead Test'. Below is 'Zebra Technologies ZQ620' with a callout 'Identifies Printer as a ZQ620'. The 'Serial Number:' field is followed by a barcode and the number 'XXZKJ173000235', with a callout 'Printer Serial Number'. The 'Program:' section includes 'OS: 6.5.0', 'PLD: 15 Rev. 65', 'PSPT: 8 Rev. 5', 'PMCU: Rev. 6', and 'Firmware: V85.20.08ZP37774' with a callout 'Firmware Version'. The 'Cable Communications:' section lists '19200 BPS, null,8,1', 'Handshake: rts/cts', and 'DSR: 0'. The 'Universal Serial Bus:' section lists '2.0 Full Speed Device', 'Vendor ID No: 0x0ASF', 'Product ID No: 0x014C', 'Manufacturer String: Zebra Technologies', 'Product String: ZTC ZQ620-203d', 'pi CPCL', and 'ID string: off'. The 'Bluetooth:' section lists 'iOS: supported' with a callout 'MFi Supported', 'Version: 4.3.1p1', 'Date: 02/13/2015', 'Baud: 115200', 'Device: Printer', 'Mode: Peripheral', 'Friendly Name: XXZKJ173000235', 'Minimum Security Mode: 1', 'Discoverable: on', 'Bluetooth Spec: 3.0/4.0', 'Enabled: on', and 'Address: AC:3F:A4:C6:8D:41' with a callout 'Bluetooth™ Radio Address'.

ZEBRA
Building Two-Key Report...

XXXXXXXXXXXXXXXXXXXXXXXXXXXXXXXXXXXX ← **Printhead Test**

Zebra Technologies
ZQ620 ← **Identifies Printer as a ZQ620**
Serial Number:

 ← **Printer Serial Number**
XXZKJ173000235

PCC: zq62-AUWA001-00
Name: XXZKJ173000235
Program:
OS: 6.5.0
PLD: 15 Rev. 65
PSPT: 8 Rev. 5
PMCU: Rev. 6
Firmware: V85.20.08ZP37774 ← **Firmware Version**
Checksum: DA31

Cable Communications:
19200 BPS, null,8,1
Handshake: rts/cts
DSR: 0

Universal Serial Bus:
2.0 Full Speed Device
Vendor ID No: 0x0ASF
Product ID No: 0x014C
Manufacturer String: Zebra Technologies
Product String: ZTC ZQ620-203d
pi CPCL
ID string: off

Bluetooth:
iOS: supported ← **MFi Supported**
Version: 4.3.1p1
Date: 02/13/2015
Baud: 115200
Device: Printer
Mode: Peripheral
Friendly Name: XXZKJ173000235
Minimum Security Mode: 1
Discoverable: on
Bluetooth Spec: 3.0/4.0
Enabled: on
Address: AC:3F:A4:C6:8D:41 ← **Bluetooth™ Radio Address**

Figure 38a • ZQ620 Configuration Label (cont.)



AC3FA4C68D41

Wireless:
Radio: 802.11 a/b/g/n/ac ← **802.11 ac radio option installed. This section details the radio's network settings**
Region: usa/canada
Country: usa/canada
Enabled: on
MAC Address: ac:3f:a4:C6:8D:40
IP Address: 0.0.0.0
Netmask: 255.255.255.0
Gateway: 0.0.0.0
Operating Mode: infrastructure
International Mode: off
Preamble Length: long
Security: none
Stored ESSID: 125
Associated: no
DHCP: on
DHCP CID type: 1
DHCP CID: ac3fa4c68d40
Power Save: on

Ethernet:
MAC Address: 00:07:4D:7A:7B:26
IP Address: 0.0.0.0 ← **Ethernet Information**
Netmask: 255.255.255.0
Gateway: 0.0.0.0
DHCP: on
DHCP CID type: 1
DHCP CID: 00074D7A7B26

Active Network Information:
Active Network: Unknown
IP Address: 0.0.0.0 ← **Network Information**
Netmask: 255.255.255.0
Gateway: 0.0.0.0
TCP Port: 6101
Alternate TCP Port: 9100
TCP JSON Config Port: 9200
UDP Port: 6101
Remote Server:
Remote Server Port: 10013
TCP: on
UDP: on
LPD: on
DHCP: on
BOOTP: on
FTP: on
HTTP: on
SMTP: on
POP3: on
SNMP: on
TELNET: on
MIRROR: off
UDP Discovery: on
Weblink:
DHCP CID type: 1
DHCP CID: ac3fa4c68d40

Peripherals:
LCD: Installed ← **Peripherals Installed**

```

Power Management:
In-activity Timeout:36000 Secs
Low-battery Timeout:60 Secs
Remote (DTR) pwr-off:Disabled
Voltage      :8.54
Low-bat Warning :6.93(176)
Low-bat Shut-down :6.53(166)
Power On Cycles :23
Battery Health :good
Battery Cycle Count:NA

Memory:
Flash :134217728 Bytes
RAM   :8388608 Bytes

Label:
Width :576 dots, 72 mm
Height:65535 dots, 8191 mm

Sensors: (Adj)
Pres [DAC:128,Thr:60,Cur:0]
Label Removed
Media [91 (576 dots)]
Black Bar [DAC:136,Thr:70,Cur:0
]
Gap [DAC:130,Thr:50,Cur:96]
Temperature :27C (62)
Voltage      :8.0V (255)

Resident Fonts:
Font      Sizes  Chars
-----
0         0- 6   20-FF
1         0     20-80
2         0- 1   20-59
4         0- 7   20-FF
5         0- 3   20-FF
6         0     20-44
7         0- 1   20-FF

File Directory:
File      Size
-----
E:2KEY.TXT      3507
E:TT0003M.TTF  169188
134044672 Bytes Free

Command Language:
CCL Key `!' [21]

ZPL Configuration Information:
Rewind.....Print Mode
Mark.....Media Type
30.0.....Darkness
+00.....Tear Off Adjust
2030.....Label Length
72mm.....Print Width
7Eh.....Control Prefix
2Ch.....Delimiter
00.....Top Position
No Motion..Media Power Up
Feed....Media Head Closed
00.....Left Margin
576.....Dots per row
End ZPL Configuration
Print-head test: OK
End of report

Press FEED key to enter DUMP mode

```

Flash and RAM Memory Installed

Maximum Label Size

Resident Human Readable Fonts Installed

Files loaded in printer memory (includes pre-scaled or scalable fonts)

CPCL and ZPL programming languages are supported

Specifications



Note • Printer specifications are subject to change without notice.

Printing Specifications

Parameter	ZQ620	ZQ610
Print Width	Up to 72 mm (2.91 in.)	Up to 48 mm (1.89 in.)
Print Speed	102 mm (4 in.)/second	Same
	127 mm (5 in.)/second in Draft Mode	
Printhead Burn Line to Tear Edge Distance	5.08 mm (0.20 in.)	4.31 mm (0.17 in.)
Printhead Life	600K inches of paper feed MTBF when using Zebra media.	Same
Print Density	203 dots/in. or better	Same

Memory and Communications Specifications

Parameter	ZQ6 Printers
Flash Memory	512 MB ¹
RAM Memory	256 MB ¹
Standard Communications	RS-232 serial port (14 Pin serial connector) Configurable Baud rate (from 9600 to 115.2 Kbps), parity and data bits. Software (X-ON/X-OFF) or hardware (DTR/STR) communication handshake protocols.
	USB 2.0 Full Speed Interface (12 Mbps)
Wireless Communication Options	1. Dual Radio: 802.11ac with Bluetooth v4.1 (both Classic & BLE) 2. Bluetooth v4.1 (both Classic & BLE)
Real Time Clock (RTC)	Time and date under application control. Refer to ZPL Programming Manual, available at www.zebra.com/manuals for RTC commands.
Ethernet	10 or 100 mps Ethernet auto detect when docked in cradle.

1. Memory configuration on your printer may be ascertained by printing a configuration label as detailed on page 75.

Label Specifications

Parameter	ZQ620	ZQ610
Max Media Width	25.4 to 79.4 mm (1.0 to 3.125 in.)	25.4 to 55.37 mm (1.0 to 2.18 in.)
Max/Min Label Length	12.7 to 812.8 mm (0.5 to 32 in.) maximum	Same
Black Bar Sensor to Printhead Burnline Distance	15.87 mm (0.62 in.) +/- 0.635 mm (0.025 in.)	13.46 mm (0.53 in.)
Media Thickness (except Tag)	2.3 to 6.5 mils (0.05842 to 0.1651 mm)	Same
Max Tag Thickness	2.3 to 5.5 mils (0.05842 to 0.1397 mm)	Same
Max Label Roll Outer Diameter	66.8 mm (2.6 in.)	55.8 mm (2.2 in.)
Inner Core Diameters**	19 mm (0.75 in.) or 35.05 mm (1.38 in.)	Same
Black Mark Location	The reflective media black marks should be centered on media roll	Same
Black Mark Dimensions	Minimum mark width: 12.7 mm (0.5 in.) perpendicular to inside edge of media, centered within the width of the roll. Mark length: 3-11 mm (0.12 to 0.43 in.) parallel to inside edge of media.)	Same



Note • Use Zebra brand direct thermal media that is outside wound. Media may be reflective (black mark) sensing, or transmissive (gap) sensing, die-cut, continuous or linerless. For die-cut labels, use only full auto dies.

**** ZQ6 printers support coreless media which is 19 mm (0.75 in.) in inner diameter.**

CPCL Font and Bar Code Specifications and Commands

Standard Fonts	25 bit-mapped fonts; 1 scalable font (CG Trimvirate Bold Condensed*) *Contains UFST from Agfa Monotype Corporation Downloadable optional bit-mapped & scalable fonts via Net Bridge software.	
Available Optional Fonts	Optional International character sets: Chinese 16 x 16 (trad), 16 x 16 (simplified), 24 x 24 (simplified); Japanese 16 x 16, 24 x 24	
Linear Bar Codes Available	Barcode (CPCL Command)	
	Aztec (AZTEC) Codabar (CODABAR, CODABAR 16) UCC/EAN 128 (UCCEAN128) Code 39 (39, 39C, F39, F39C) Code 93 (93) Code 128 (128) EAN 8, 13, 2 and 5 digit extensions (EAN8, EAN82, EAN85, EAN13, EAN132, and EAN135) EAN-8 Composite (EAN8) EAN-13 Composite (EAN13) Plessey (PLESSEY) Interleaved 2 of 5 (I2OF5) MSI (MSI, MSI10, MSI1110) FIM/POSTNET (FIM) TLC39 (TLC39) UCC Composite A/B/C (128(Auto)) UPCA, 2 and 5 digit extensions (UPCA2 and UPCA5) UPCA Composite (UPCA) UPCE, 2 and 5 digit extensions (UPCE2 and UPCE5) UPCE Composite (UPCE) MaxiCode (MAXICODE) PDF 417 (PDF-417) Datamatrix (using ZPL emulation) (DATAMATRIX) QR Code (QR)	
2-D Bar Codes Available	RSS:	RSS-14 (RSS-Subtype 1) RSS-14 Truncated (RSS-Subtype 2) RSS-14 Stacked (RSS-Subtype 3) RSS-14 Stacked Omnidirectional (RSS-Subtype 4) RSS Limited (RSS-Subtype 5) RSS Expanded (RSS-Subtype 6)
Rotation Angles	0°, 90°, 180°, and 270°	

ZPL Font and Bar Code Specifications and Commands

Standard Fonts	15 bit-mapped fonts; 1 scalable font (CG Trimvirate Bold Condensed*) Downloadable optional bit-mapped & scalable fonts via Net Bridge software.
Available Optional Fonts	Zebra offers font kits covering multiple languages including Simplified and Traditional Chinese, Japanese, Korean, Hebrew/Arabic, and others.
Linear Bar Codes Available 2-D Bar Codes Available	Barcode (CPCL Command)
	Aztec (^B0) Codabar (^BK) Codablock (^BB) Code 11 (^B1) Code 39 (^B3) Code 49 (B4) Code 93 (^BA) Code 128 (^BC) DataMatrix (^BX) EAN-8 (^B8) EAN-13 (^BE) GS1 DataBar Omnidirectional (^BR) Industrial 2 of 5 (^BI) Interleaved 2 of 5 (^B2) ISBT-128 (^BC) LOGMARS (^BL) Micro-PDF417 (^BF) MSI (^BM) PDF-417 (^B7) Planet Code (^B5) Plessey (^BP) Postnet (^BZ) Standard 2 of 5 (^BJ) TLC39 (^BT) UPC/EAN extensions (^BS) UPC-A (^BU) UPC-E (^B9) Maxi Code (^BD) QR Code (^BQ)
Rotation Angles	0°, 90°, 180°, and 270°

Communication Ports

RS-232C

Pin #	Signal Name	Type	Description
1	CTS	input	Clear To Send from host
2	TXD	output	Transmit Data
3	RXD	input	Receive Data
4	DSR	input	Data Set Ready: low to high transition turns printer on, high to low transition turns printer off (if enabled)
5	GND		Ground
6	DTR	output	Data Terminal Ready: set high when printer is on. Switched 5V (300mA max)
7	N/A		Do Not Use
8	RTS	output	Request To Send set high when printer is ready to accept a command or data
9	N/A		Do Not Use
10	N/A		Do Not Use
11	N/A		Do Not Use
12	N/A		Do Not Use
13	N/A		Do Not Use
14	N/A		Do Not Use

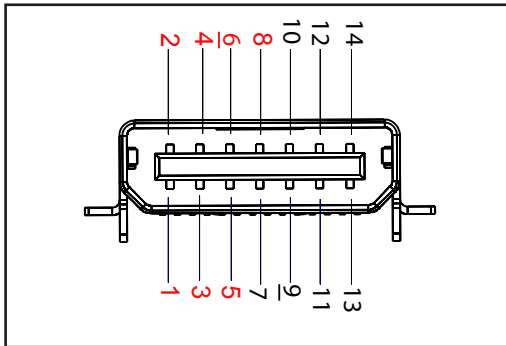

Figure 39 • RS-232C Communication Port

USB

Pin #	Signal Name	Type	Description
1	VBUS	-	USB Bus Power
2	USB-	bi-directional	I/O signals
3	USB+	bi-directional	I/O signals
4	USB_ID	-	Identifies A/B connector
5	Return		Ground

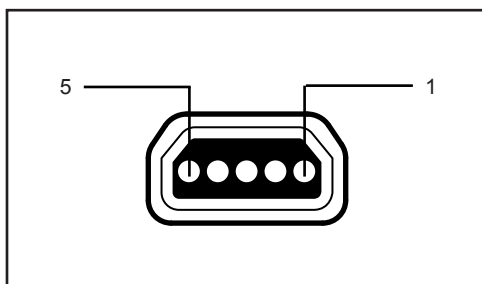

Figure 40 • USB Communication Port

Physical, Environmental and Electrical Specifications

Parameter	ZQ620	ZQ610
Weight w/ battery	1.6 lbs. (0.75 kg)	1.35 lbs. (0.61 kg)
Temperature	Operating: -20 °C to 50 °C (-4 °F to 122 °F) (Healthcare is 0 °C to 50 °C (32 °F to 122 °F))	Operating: -20 °C to 50 °C (-4 °F to 122 °F) (Healthcare is 0 °C to 50 °C (32 °F to 122 °F))
	Storage: -25 °C to 65 °C (-13 °F to 149 °F)	Same
	Charging: 0 °C to 40 °C (32 °F to 104 °F)	Same
Relative Humidity	Operating/Storage: 10% to 90% non-condensing	Same
Battery	Smart Battery (2 or 4 cell) Lithium-Ion, 7.4 VDC (nominal); 2.45 Ahr min.	Same
	4 cell Extended Smart Battery (Optional)	4 cell Extended Smart Battery (Optional)
Intrusion Protection (IP) Rating	IP43 (without optional environmental case) IP54 (with case)	IP43 (without optional environmental case) IP54 (with case)

Figure 41 • ZQ620 Dimensions



Figure 42 • ZQ620 Mounting Hole Dimensions

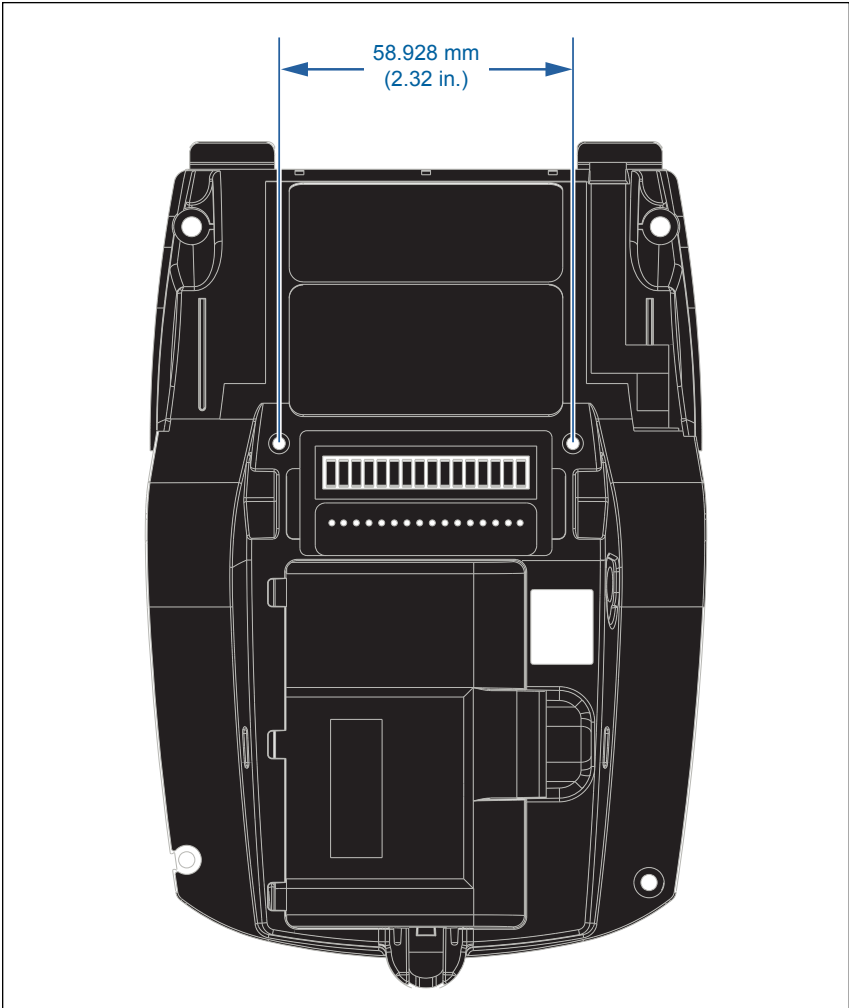

Use two (2) M2.5 x 0.45 screws in the indicated positions above.

Figure 43 • ZQ610 Dimensions



Figure 44 • ZQ610 Mounting Hole Dimensions

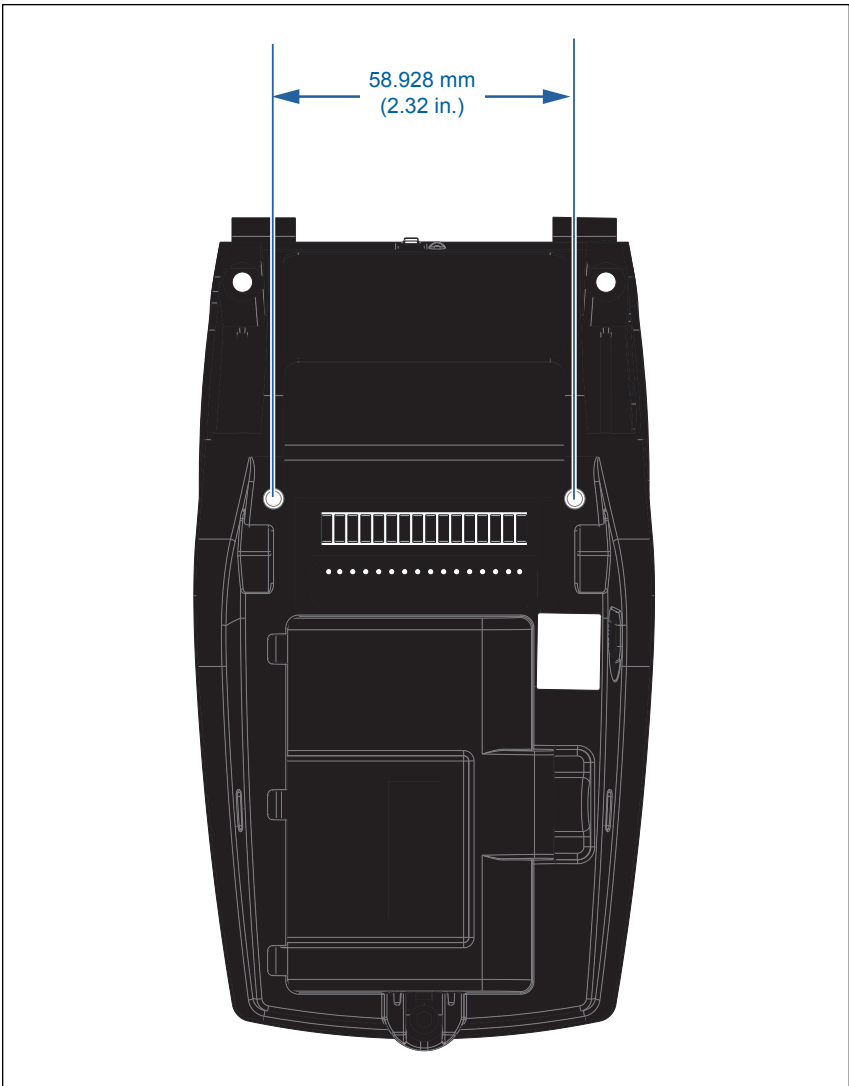

Use two (2) M2.5 x 0.45 screws in the indicated positions above.

ZQ6 Accessories

Part #	Description
P1031365-006	KIT ACC QL _n 220 RUBBER DOOR I/O (15)
P1031365-018	KIT ACC QL _n 320 RUBBER DOOR I/O (15)
P1031365-019	KIT ACC QL _n 220/QL _n 320 RUBBER DOOR DC JACK (15)
P1031365-022	KIT ACC QL _n 220/320 PLATEN GEAR 48P 22T (25)
P1031365-024	KIT ACC MOBILE AC ADAPTER US (type A) cord
P1031365-027	KIT ACC QL _n HAND STRAP
P1031365-028	KIT ACC QL _n BELT CLIP REPLACEMENT (20)
P1031365-029	KIT ACC QL _n 320 SOFT CASE (Includes Shoulder Strap)
P1031365-033	KIT ACC QL _n -EC AC ADAPTER US (type A) CORD (see Sales for other countries)
P1031365-038	KIT ACC QL _n -EC
P1031365-044	KIT ACC QL _n 220 SOFT CASE (Includes Shoulder Strap)
P1031365-045	KIT ACC QL _n -EC4 AC ADAPTER US CORD (see Sales for other countries)
P1031365-050	KIT ACC EC4 WALL MOUNT
P1031365-052	KIT ACC QL _n SERIAL CABLE (with strain relief) QL ADAPTER (female DIN)
P1031365-053	KIT ACC QL _n SERIAL CABLE, 6' (with strain relief) PC-DB9
P1031365-054	KIT ACC QL _n SERIAL CABLE (with strain relief) to MC9000
P1031365-055	KIT ACC QL _n PC-USB CABLE, 6' (with strain relief)
P1031365-056	KIT ACC QL _n SERIAL CABLE (with strain relief) RJ45 to TELZON ADAPTER
P1031365-057	KIT ACC QL _n SERIAL CABLE (with strain relief) to LS2208 Scanner
P1031365-058	KIT ACC QL _n 16 PIN SERIAL CABLE (with strain relief) to MC3000
P1031365-059	KIT ACC QL _n 220/QL _n 320 SPARE BATTERY SMART
P1031365-060	KIT ACC QL _n 11 PIN SERIAL CABLE (with strain relief) to MC3000
P1031365-061	KIT ACC QL _n SERIAL DEX CABLE (with strain relief)
P1031365-062	KIT ACC QL _n SERIAL CABLE (with strain relief) to RJ45
P1031365-063	KIT ACC SC2 Li-ION SMART CHARGER, US (type A) CORD (see Sales for other countries)
P1031365-069	KIT, ACC QL _n 220/320 and ZQ500 SERIES SPARE EXTENDED BATTERY with LED's
P1031365-192	KIT ACC QL _n SERIES SHOULDER STRAP

ZQ6 Accessories cont.

P1031365-104	KIT ACC QL _n SERIAL CABLE (with strain relief) to LS2208 SCANNER EXTENDED
P1024458-002	BELT,CLIP,QLN,HC
AC18177-5	MODEL UCLI72-4 QUAD BATTERY CHARGER (US line cord, see Sales for others)
BTRY-MPP-34MA1-01	3400 mAh BATTERY for ZQ6 and ZQ500 SERIES
BTRY-MPP-34MAHC1-01	3400 mAh BATTERY for ZQ6 HEALTHCARE PRINTER
SAC-MPP-3BCHGUS1-01	3-SLOT BATTERY CHARGER
SAC-MPP-6BCHUS1-01	DUAL 3-Slot BATTERY CHARGER
SAC-MPP-1BCHGUS1-01	1-SLOT BATTERY CHARGER
VAM-MPP-VHCH1-01	VEHICLE ADAPTER
P1065668-008	KIT,ACC,QL _n ,AC ADAPTER,STRAIGHT,30W,HC with US (type A) CORD



Note • Refer to Appendix A for additional information on Data I/O cables.

Interface Cables (RS-232 Cables)

Part Number P1031365-053; DB-9 to 14-Pin Serial

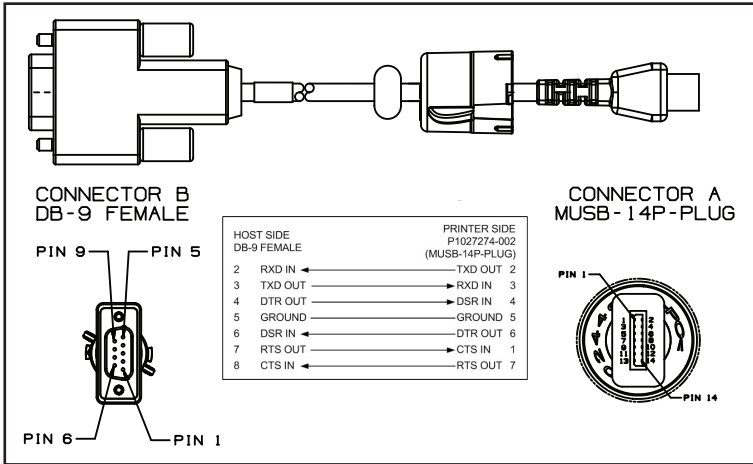

Part Number P1031365-052; 8-Pin DIN to 14-Pin Serial Cable

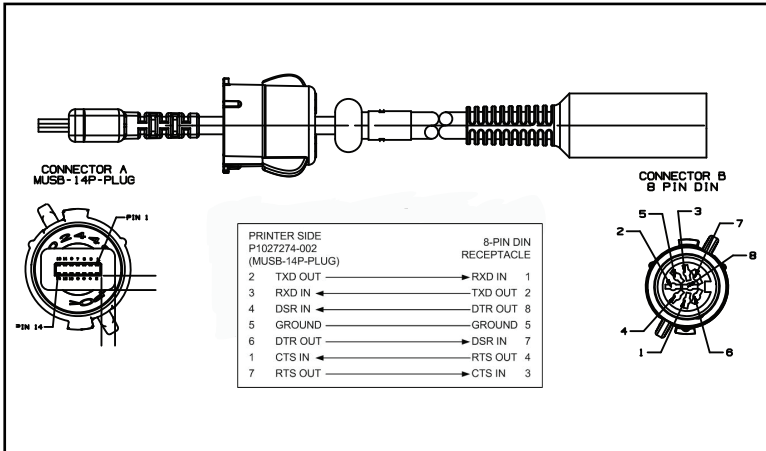

USB Cables

Part Number AT17010-1; USB A to USB Mini B Cable

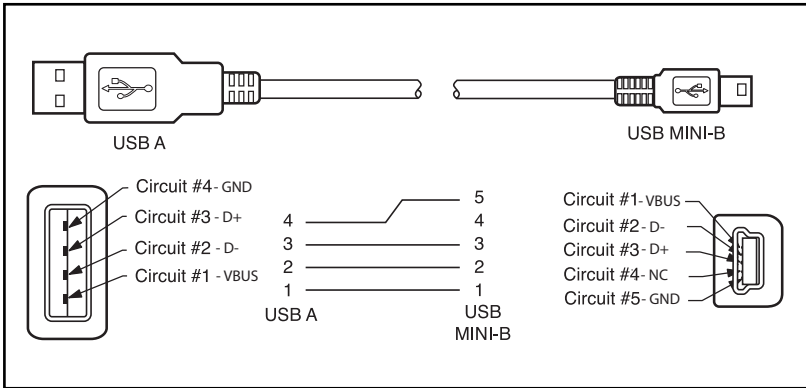

Part Number P1031365-055; 4 Position USB Mini to 4-Pin USB (w/ Strain Relief)

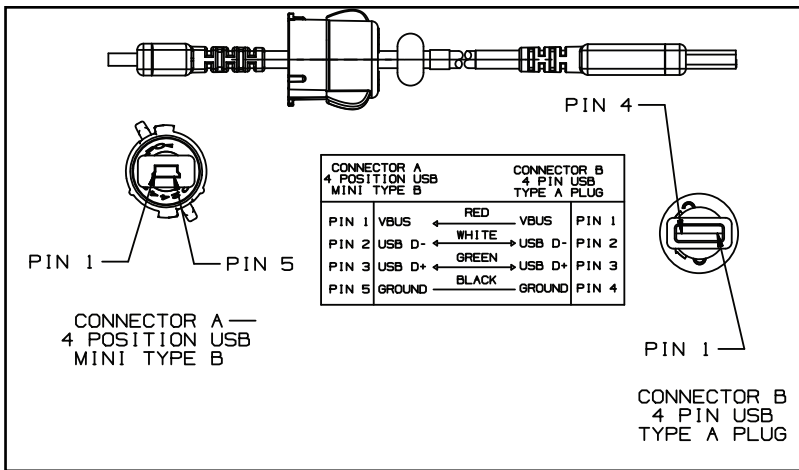

Note • Visit the Zebra website at: www.zebra.com/accessories for a listing of interface cables for all Zebra mobile printers.

Appendix B

Media Supplies

To insure maximum printer life and consistent print quality and performance for your individual application, it is recommended that only media produced by Zebra be used.

Advantages include:

- Consistent quality and reliability of media products.
- Large range of stocked and standard formats.
- In-house custom format design service.
- Large production capacity which services the needs of many large and small media consumers including major retail chains world wide.
- Media products that meet or exceed industry standards.

For more information go the Zebra website (www.zebra.com) and select the Products tab, or refer to the CD included with the printer.

Appendix C

Maintenance Supplies

In addition to using quality media provided by Zebra, it is recommended that the printer be cleaned as prescribed in the maintenance section. The following item is available for this purpose:

- Cleaning Pen (12 pack): p/n 105950-035



SETTINGS Menu

DARKNESS -49
⬆

Set the darkness to the lowest setting that provides good print quality. If you set darkness too high, the label image may print unclearly, bar codes may not scan correctly, or the printhead may wear prematurely.

PRINT SPEED 4.0
⬆

Select the speed for printing a label (given in inches per second). Slower print speeds typically yield better print quality.

MEDIA TYPE MARK
⬆

Select the type of media that you are using.

TEAR OFF 0
⬆

If necessary, adjust the position of the media over the tear-off bar after printing.

PRINT WIDTH 576

Specify the width of the labels being used. The default value is the maximum width for the printer based on the printhead's DPI value.

PRINT MODE REWIND

Select a print mode that is compatible with your printer options.

LABEL TOP 0

LEFT POSITION 0

If necessary, shift the print position horizontally on the label. Positive numbers move the left edge of the image toward the center of the label by the number of dots selected, while negative numbers move the left edge of the image toward the left edge of the label.

REPRINT MODE OFF

When reprint mode is enabled, you can reprint the last label printed either by issuing certain commands or by pressing the DOWN ARROW on the keypad.

LABEL LENGTH MAX 39
⬆

Set the maximum label length to a value that is at least 1.0 in. (25,4 mm) greater than the actual label length plus the interlabel gap. If you set the value to one that is smaller than the label length, the printer assumes that continuous media is loaded, and the printer cannot calibrate.

LANGUAGE ENGLISH
⬇ ▲
⬆

If necessary, change the language that the printer displays.



Note • The selections for this parameter are displayed in the actual language to make it easier to find one that you are able to read.



TOOLS Menu

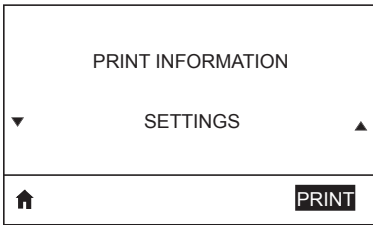

Prints a printer configuration label, sensor profile, barcode information, font information, images, formats, two-key report, and network settings..

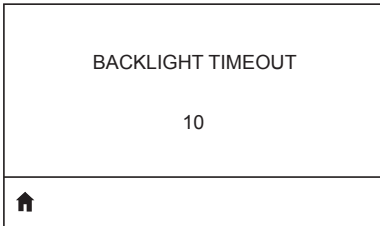

Sets the duration of the LCD backlight in seconds.

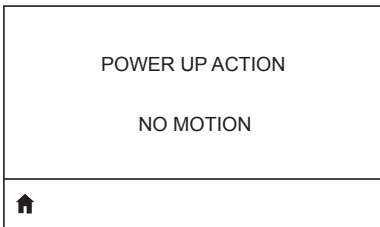

Set the action for the printer to take during the power-up sequence, i.e. no motion, calibrate, etc.

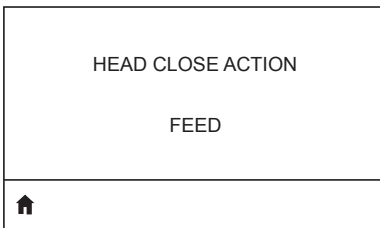

Set the action for the printer to take when you close the printhead, i.e. feed, calibrate, etc.

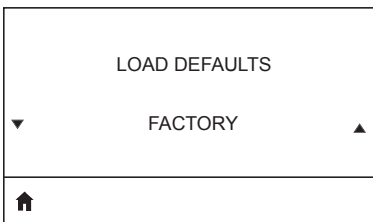

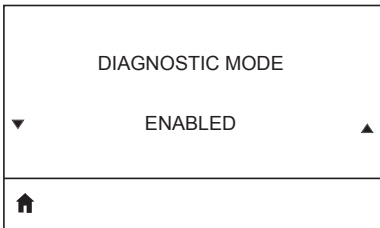
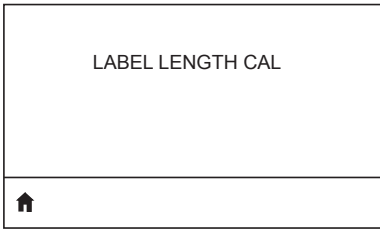

Use this diagnostic tool to cause the printer to output the hexadecimal values for all data received by the printer.

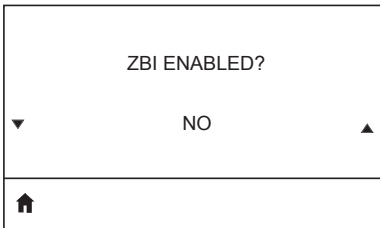

This menu item indicates if the Zebra Basic Interpreter (ZBI 2.0TM.) option is enabled on your printer.

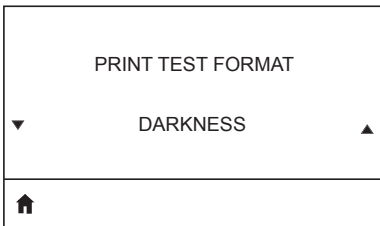
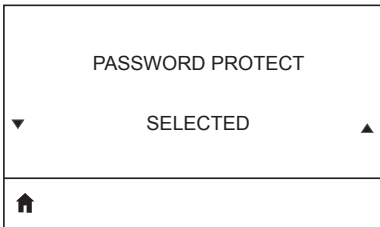

Performs a print test in progressively darker patterns.



NETWORK Menu

ACTIVE PRINT SERVER NONE

Informs the user of the presence of an active server. Only one print server can be installed at a time, therefore the print server installed is the active print server.

PRIMARY NETWORK WIRELESS

Informs the user network being used.

WLAN IP ADDRESS 0.0.0.0

View, and if necessary, change the printer's WLAN IP address.

WLAN SUBNET MASK 255.255.255.0

View, and if necessary, change the WLAN subnet mask.

WLAN GATEWAY 0.0.0.0

View, and if necessary, change the default WLAN gateway.

WLAN IP PROTOCOL ALL



This parameter tells if the user or the server selects the WLAN IP address.

WLAN MAC ADDRESS 00:19:70:7A:20:44



View the WLAN Media Access Control (MAC) address of the wireless print server that is installed in the printer.

ESSID DSF802LESS54



The Extended Service Set Identification (ESSID) is an identifier for your wireless network. This setting, which cannot be modified from the control panel, gives the ESSID for the current wireless configuration.

AP MAC ADDRESS 00:05:9A:3C:78:00



View the AP MAC address associated with the printer.

CHANNEL



View the network channel.

SIGNAL 0



View, and if necessary, change the printer's network signal.

WIRED IP ADDRESS 0.0.0.0



View, and if necessary, change the printer's wired IP address.

WIRED SUBNET MASK 255.255.255.0

View, and if necessary, change the printer's wired subnet mask.

WIRED GATEWAY 0.0.0.0



View, and if necessary, change the wired gateway setting.

WIRED IP PROTOCOL ALL

This parameter tells if the user (permanent) or the server (dynamic) selects the IP address. If a dynamic option is chosen, this parameter tells the method(s) by which the wired or wireless server receives the IP address from the server.

WIRED MAC ADDRESS

00:07:4D:3F:D3:B2



View, and if necessary, change the printer's network signal.

IP PORT

6101



View, and if necessary, change the printer's wired IP address.



IP ALTERNATE PORT

9100





View, and if necessary, change the printer's wired subnet mask.

PRINT INFORMATION

 NETWORK 



RESET NETWORK





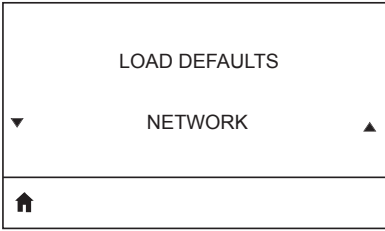
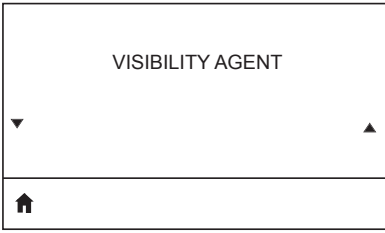

BATTERY Menu



Indicates the current health of the battery, i.e. Good, Past Useful Life, etc.

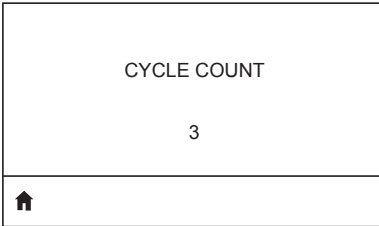

View the current charging cycle count of the battery.

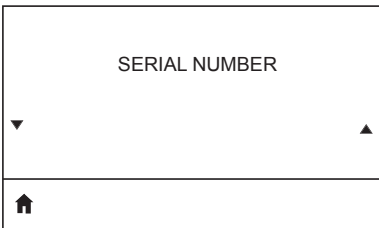

Indicates the serial number of the battery pack.

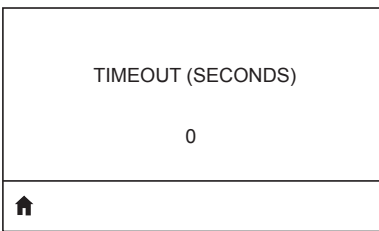

View, and if necessary, change the battery timeout.

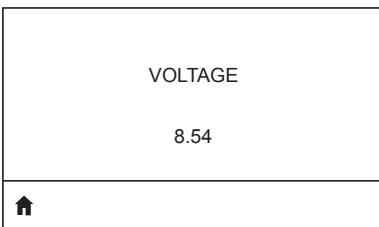

View the current voltage level of the battery pack.

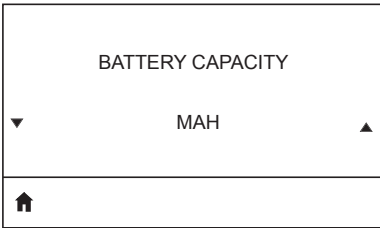
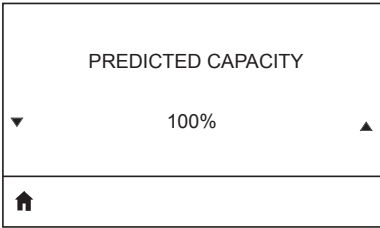
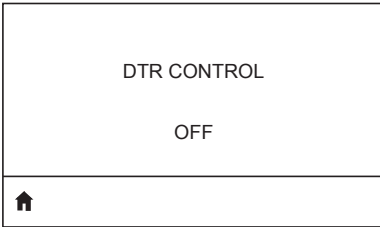
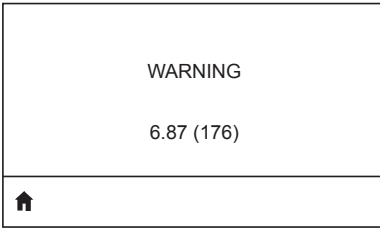

Battery capacity measured in mAH.

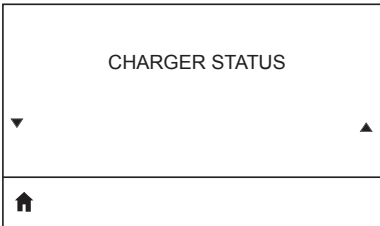

Indicates the presence of a battery charger.

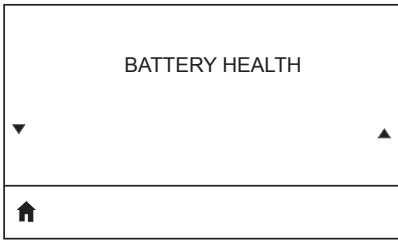



LANGUAGES Menu

LANGUAGE	
▼	ENGLISH ▲
⬆	

If necessary, change the language that the printer displays.



Note • The selections for this parameter are displayed in the actual languages to make it easier to find one that you are able to read.

COMMAND LANGUAGE	
▼	HYBRID_XML_ZPL ▲
⬆	

COMMAND CHAR	
^ (5E)	
⬆	

Set the format command character to match what is used in your label formats.

CONTROL CHAR	
~ (7E)	
⬆	

Set the control prefix character to match what is used in your label formats.

DELIMITER CHAR , (2E)
🏠

Set the delimiter character to match what is used in your label formats.

ZPL MODE ZPL II
🏠

Select the mode that matches what is used in your label formats.

VIRTUAL DEVICE ▼ NONE ▲
🏠



SENSORS Menu

MEDIA STATUS	
▼	OK
▲	
🏠	

Informs the user of the presence or absence of media in the printer.

LABEL LENGTH CAL	
🏠	

TAKE LABEL	
▼	0
▲	
🏠	



Note • This value is set during sensor calibration. Do not change this setting unless you are told to do so by Zebra Technical Support or by an authorized service technician.



PORTS Menu

BAUD RATE 19200
↑

Select the baud value that matches the one being used by the host computer.

DATA BITS 8
↑

Select the data bits value that matches the one being used by the host computer.

PARITY NONE
↑

Select the parity value that matches the one being used by the host computer.

STOP BITS 1
↑

Select the stop bits value that matches the one being used by the host computer.

HOST HANDSHAKE RTS/CTS
↑

Select the handshake protocol that matches the one being used by the host computer.

HALT ON ERROR	
▼	YES ▲
🏠	

Select YES or NO to halt printing upon the occurrence of an error.



BLUETOOTH Menu

BLUETOOTH ADDRESS NO BLUETOOTH RADIO
🏠

View the Bluetooth address for the presence of a BT radio.

MODE PERIPHERAL
🏠

View the mode of the BT radio.

DISCOVERY ON
🏠

View the discovery status, i.e. ON or OFF.

CONNECTED NO
🏠

View the connection status of the BT radio, i.e. YES or NO.

BT SPEC VERSION NO RADIO
🏠

View the Bluetooth spec version.

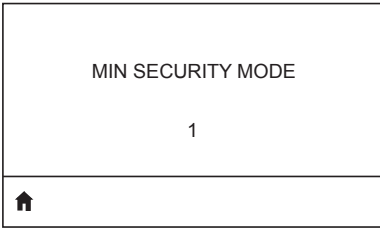

View, and change if necessary, the minimum security mode of the BT radio.

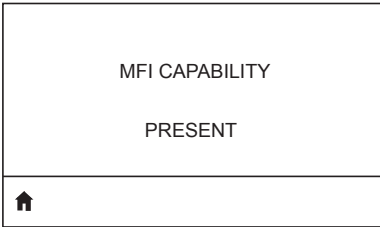

Informs the user of the presence or availability of Made for iPhone (MFi) capability

Appendix E

Serial and PCC Number Locations for ZQ6 Printers

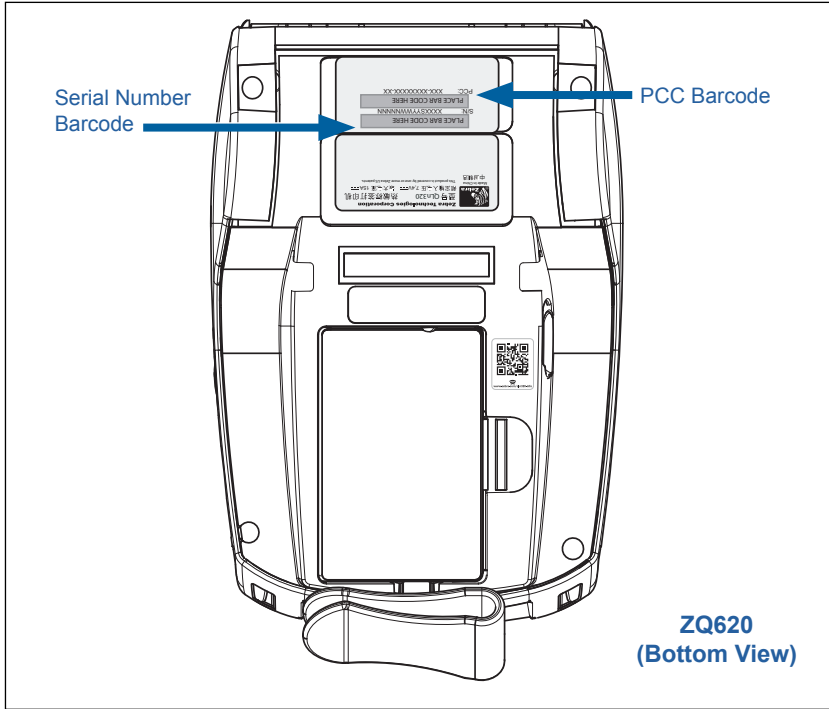

Important • Due to compliance and customs restraints, an integrator may not be able to ship a printer purchased in one country to another country based on the limitations imposed by regional SKUs. The country code identified in the printer SKU determines the area of the world in which the printer can be used.

Battery Disposal



The EPA certified RBRC® Battery Recycling Seal on the Lithium-Ion (Li-Ion) battery supplied with your printer indicates Zebra Technologies Corporation is voluntarily participating in an industry program to collect and recycle these batteries at the end of their useful life, when taken out of service in the United States or Canada. The RBRC program provides a convenient alternative to placing used Li-Ion batteries into the trash or the municipal waste stream, which may be illegal in your area.



Important • When the battery is depleted, insulate the terminals with tape before disposal.

Please call 1-800-8-BATTERY for information on Li-Ion battery recycling and disposal bans/restrictions in your area.

Zebra Technologies Corporation's involvement in this program is part of our commitment to preserving our environment and conserving our natural resources.

Outside North America, please follow local battery recycling guidelines.

Product Disposal



The majority of this printer's components are recyclable. Do not dispose of any printer components in unsorted municipal waste. Please dispose of the battery according to your local regulations, and recycle the other printer components according to your local standards.

For more information, please see our web site at: <http://www.zebra.com/environment>.

Appendix G

Alert Messages

The ZQ6 printers will display the following alert messages to inform the user of various fault conditions that might occur with the ZQ610 and ZQ620.

Message	Type	Color
AckAlertOptionBoardInvalid	WARNING	YELLOW
AckAlertYN1	INFO	GREEN
AckAlertNoUsbDriveFound	WARNING	YELLOW
AckAlertAllFilesPrinted	INFO	GREEN
AckAlertAllFilesStored	INFO	GREEN
AckAlertTooManyUsbHostDevices	WARNING	YELLOW
AckAlertUnsupportedUsbHostDevice	WARNING	YELLOW
AckAlertUnsupportedUsbHostFilesystem	WARNING	YELLOW
AckAlertErrorPrintingFile	ERROR	RED
AckAlertErrorStoringFile	ERROR	RED
AckAlertErrorPrintingFileContinue	ERROR	RED
AckAlertErrorStoringFileContinue	ERROR	RED
AckAlertFirmwareFoundContinue	INFO	GREEN
AckAlertUsbMirrorAutoPrompt	INFO	GREEN
AckAlertUseUsbMemoryDevicePrompt	INFO	GREEN
AckAlertBluetoothPairingPassKey	INFO	GREEN
AckAlertInvalidZplTemplateFile	ERROR	RED
AckAlertCoreDumpPresent	INFO	GREEN
AckAlertInvalidComplianceFile	ERROR	RED
AckAlertHeadElementTestFailed	ERROR	RED
AckAlertUsbPowerError	ERROR	RED
AckAlertFileSystemWriteError	ERROR	RED
AckAlertAvalancheError	ERROR	RED
AckAlertAvalancheTextMessage	INFO	GREEN
AvalanchePerformingUpdate	INFO	GREEN
AvalancheUpdateComplete	INFO	GREEN
BatteryHealthReplace	WARNING	YELLOW
BatteryHealthNearDeath	WARNING	YELLOW
BatteryHealthShutdown	ERROR	RED
BatteryAuthenticationFail	ERROR	RED
BatteryOverTemp	WARNING	YELLOW

Message	Type	Color
BatteryUnderTemp	WARNING	YELLOW
BatteryChargeFault	ERROR	RED
BatteryLow	WARNING	YELLOW
BatteryRemoved	WARNING	YELLOW
BadFirmwareDownload	ERROR	RED
BatchCount	INFO	GREEN
BluetoothPinInvalid	ERROR	RED
BluetoothPairing	INFO	GREEN
BluetoothPairingAccepted	INFO	GREEN
BluetoothPairingRejected	ERROR	RED
BluetoothPairingFailed	ERROR	RED
BluetoothDisplayPasskey	INFO	GREEN
CancelAll	INFO	GREEN
CancelOne	INFO	GREEN
CalibrationMediaInput	INFO	GREEN
CalibrationMediaRunning	INFO	GREEN
CalibrationRibbonRunning	INFO	GREEN
CalibrationRibbonInput	INFO	GREEN
CountryCodeNotSelected	WARNING	YELLOW
CutError	ERROR	RED
DownloadingOptionBoardFirmware	INFO	GREEN
DownloadingFirmware	INFO	GREEN
HeadOpen	ERROR	RED
HeadOverTemp	WARNING	YELLOW
HeadUnderTemp	WARNING	YELLOW
HeadCold	WARNING	YELLOW
HeadAuthenticationFailed	ERROR	RED
HeadThermistorFault	ERROR	RED
HeadIdentificationFailed	ERROR	RED
HeadMaintenanceNeeded	INFO	GREEN
MediaLow	INFO	GREEN
MediaOut	ERROR	RED
MirroringFile	INFO	GREEN
Mirroring	INFO	GREEN
MirroringApplication	INFO	GREEN
MirroringCommands	INFO	GREEN
MirroringFeedback	INFO	GREEN

Message	Type	Color
MirrorProcessingFinished	INFO	GREEN
MotorOverTemp	WARNING	YELLOW
MagCardReaderActive	INFO	GREEN
OutOfMemoryStoringGraphic	ERROR	RED
OutOfMemoryStoringFont	ERROR	RED
OutOfMemoryStoringFormat	ERROR	RED
OutOfMemoryStoringBitmap	ERROR	RED
OperationProgress	INFO	GREEN
OptionalAlertKeyP2	INFO	GREEN
PaperJam	WARNING	YELLOW
PasswordInvalid	ERROR	RED
PauseRequest	WARNING	YELLOW
PrinterError	ERROR	RED
PowerOff	INFO	GREEN
PowerReset	INFO	GREEN
PowerSleep	INFO	GREEN
PowerSupplyError	ERROR	RED
PrintHeadShutdown	WARNING	YELLOW
ReplaceHead	ERROR	RED
RfidError	ERROR	RED
RfidNotPresent	INFO	GREEN
RibbonOut	ERROR	RED
RibbonIn	WARNING	YELLOW
RibbonLow	INFO	GREEN
StartingApplication	INFO	GREEN
WlanLossSignal	WARNING	YELLOW
WlanResumeSignal	INFO	GREEN
WlanInvalidChannels	ERROR	RED
WlanInvalidSecurityMode	ERROR	RED
WmiError	ERROR	RED
WritingFirmwareToFlash	INFO	GREEN

Appendix H

Using Zebra.com

The following examples illustrate the search function on Zebra’s website for finding specific documents and downloads.

Example 1: Find the ZQ6 User Guide.

Go to <http://www.zebra.com/us/en/support-downloads.html>

Type the appropriate printer name in search box.

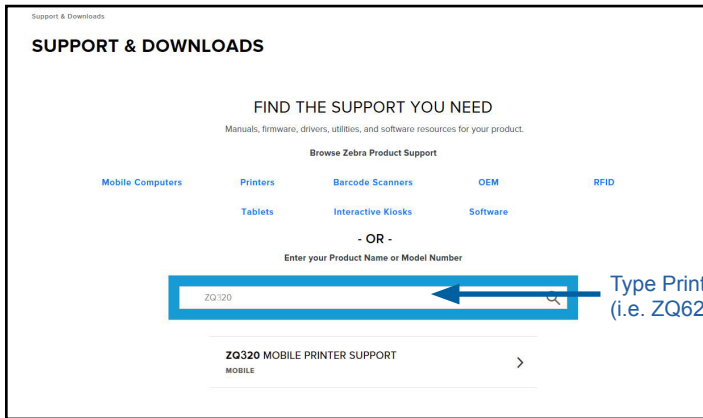

Scroll down on the ZQ6 page below for printer support pages.

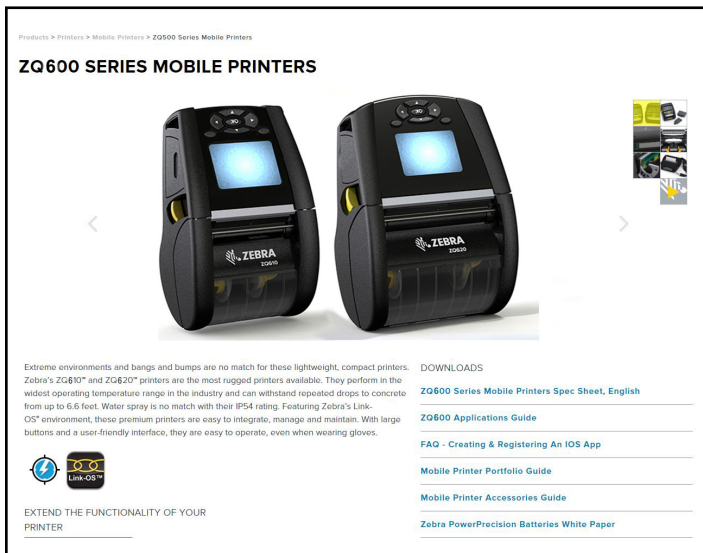

Click on the “Get Support” button for How-To videos, manuals, drivers, firmware and software & utilities.

ZQ610 Mobile Printer
ZEBRA'S MOST RUGGED PREMIUM PRINTER FOR 3" APPLICATIONS
 Optimized for tough environments where a high duty-cycle 3" (Z2mm) receipt or invoice is needed, and can also print labels for medium-duty-cycle applications.

HOW-TO-VIDEOS, MANUALS, AND DRIVERS
[Get Support >](#)

INDUSTRY USE
 Transportation Retail

VIEW THE FULL LIST OF FEATURES
 Select a Language
 English

ZQ500 Series Mobile Printers Spec Sheet, English

PRINT WIDTH 2.8375" min	MEDIA ROLL OUTER DIAMETER 2.075" min
PRINT SPEED Up to 1702mm per second	WEIGHT 1.39 lbs/624.3 kg with battery
DURABILITY IP64-rated for dust and liquid protection with the optional carrier (IP68 carrier drops to concrete multiple times) IP27 / 2m with the (optional carrier) (handheld)	BATTERY CAPACITY PowerProteus Plus 2400 mAh rechargeable Lithium Ion Sealed Battery (14.6V) (9500 mAh extended battery optional)

ZQ620 Mobile Printer
ZEBRA'S MOST RUGGED PREMIUM PRINTER FOR 4" APPLICATIONS
 Optimized for tough environments where a high duty-cycle 4" (104mm) receipt or invoice is needed, and can also print labels for medium-duty-cycle applications.

PRINT WIDTH 4.1" / 105mm	MEDIA ROLL OUTER DIAMETER 2.2475" min
PRINT SPEED Up to 1702mm per second	WEIGHT 2.7260/1.79 kg with battery
DURABILITY IP64-rated for dust and liquid protection (IP68-rated with the optional carrier)	BATTERY CAPACITY PowerProteus Plus 2400 mAh rechargeable Lithium Ion Sealed Battery

Click on the appropriate tab listed below for various help topics.

ZEBRA SOLUTIONS PRODUCTS SERVICES SUPPORT & DOWNLOADS PARTNERS

Support and Downloads > Printers > Mobile Printers

ZQ610 MOBILE PRINTER SUPPORT

Here are support and repair resources for your printer. Please note that product registration is no longer necessary. Retain proof of purchase for warranty confirmation.

Product Info for ZQ610 > [Quick Troubleshooting Guide >](#)

SUPPORT
 Online Tech Support
 Submit Technical Support Issue
 Contact Support

WARRANTY
 Check Warranty & Service Agreement Status
 Warranty Information

REPAIRS
 Find Authorized Repair Partner
 Request a Repair
 Zebra OneCare for Printers

EXTRAS
 Printer Supplies
 Printer Accessories
 Card Printer Software

HOW-TO-VIDEOS **DRIVERS** **FIRMWARE** **SOFTWARE & UTILITIES** **MANUALS** **KNOWLEDGE ARTICLES**

Legend: Unrestricted DemoWare Restricted

Appendix I

Product Support

When calling with a specific problem regarding your printer, please have the following information on hand:

- Model number/type (e.g. ZQ620)
- Unit serial number (refer to Appendix E)
- Product Configuration Code (PCC) (refer to Appendix E)



In the Americas contact:

Regional Headquarters	Technical Support	Customer Service Dept.
Zebra Technologies Corporation 3 Overlook Point Lincolnshire, Illinois 60069 U.S.A. T: +1 847 634 6700 Toll Free: +1 866 230 9494 F: +1 847 913 8766	T: +1 877 275 9327 F: +1 847 913 2578 Hardware: ts1@zebra.com Software: ts3@zebra.com	For printers, parts, media, and ribbon, please call your distributor, or contact us. T: +1 877 275 9327 E: clientcare@zebra.com



In Europe, Africa, the Middle East, and India contact:

Regional Headquarters	Technical Support	Customer Service Dept.
Zebra Technologies Europe Limited Dukes Meadow Millboard Road Bourne End Buckinghamshire SL8 5XF, UK T: +44 (0)1628 556000 F: +44 (0)1628 556001	T: +44 (0) 1628 556039 F: +44 (0) 1628 556003 E: Tseurope@zebra.com	For printers, parts, media, and ribbon, please call your distributor, or contact us. T: +44 (0) 1628 556032 F: +44 (0) 1628 556001 E: cseurope@zebra.com



In the Asia Pacific region contact:

Regional Headquarters	Technical Support	Customer Service Dept.
Zebra Technologies Asia Pacific Pte. Ltd. 71 Robinson Road #05-01/02/03 Parakou Building Singapore 068913 T: +65 6858 0722 F: +65 6885 0838	T: +65 6858 0722 F: +65 6885 0838 E: (China) tschina@zebra.com All other areas: tsasiapacific@zebra.com	For printers, parts, media, and ribbon, please call your distributor, or contact us. T: +65 6858 0722 F: +65 6885 0836 E: (China) order-csr@zebra.com All other areas: csasiapacific@zebra.com

Index

A

Accessories 21–30, 65–68, 90
AC Power Adapter 24
Adaptive Print Performance 48
Alert Messages 45
Appendix A, USB Cables 92
Appendix B, Media Supplies 94
Appendix C, Maintenance Supplies 94
Appendix D, Parameters Menus 95
Appendix E, Serial and PCC 115
Appendix F, Battery Disposal 116
Appendix G, Alert Messages 117
Appendix H, Using Zebra.com 120
Appendix I, Product Support 122

B

Battery, health 21
Battery, installing 17
Battery pack
 Power Precision 11
Battery Safety 20
Belt Clip 65
Black Mark Dimensions 60
Bluetooth 54
Bluetooth, minimum security modes
 56
Bluetooth, networking 54
Bluetooth, security modes 55

C

Cable Communication 51
Charger, battery 20–30
 1-Slot Charger 29
 3-Slot Charger 30
 AC Power Adapter 24
 Ethernet Cradles 25
 Smart Charger 2 21
 UCLI72 Quad Charger 22
Charger Safety 20
Communication Port 84
Communications Diagnostics 75
Configuration Label, sample 77

CPCL Font and Bar Code
 Specifications and Commands
 82
Cradles, Ethernet and Charging 25

D

Designing Labels 58
Dimensions, ZQ610 88
Dimensions, ZQ620 86
Document Conventions 8
Draft Mode 48

E

Ethernet Cradles 25

G

General Cleaning Instructions 69
Getting Ready to Print 17

H

Healthcare Printers 34
Home Menu Screen 42
Home Screen Icons & Parameters 44

I

Installing the Battery 17
Introduction to the ZQ6 Printers 9

L

Label Areas 60
Label Design Examples 61
LCD Control Panel 39, 72

M

Made for iPhone (MFi) 13
Media, loading 31
Mounting Dimensions ZQ610 89
Mounting Dimensions ZQ620 87

N

Near Field Communication (NFC)
 13, 63

P

- Power Save Mode 47
- Power-Up Sequences 46
- Preventive Maintenance 69
- Printer Status Icons 40
- Printing Method
 - Direct Thermal 12
- Programming language
 - CPCL 9

Q

- QR Code 13
- Quad Charger, cycle times 23
- Quad Charger, UCLI72-4 22

R

- RS-232C Communications 51

S

- Shoulder Strap 66
- Sleep Mode 47
- Smart Battery, PowerPrecision+ 11
- Smart Charger-2 (SC2) Single Battery Charger 21
- Soft Case 67
- Specifications, label 81
- Specifications, memory and communications 80
- Specifications, physical, environmental and electrical 85
- Specifications, printing 80
- Status Bar Icons 40

T

- Troubleshooting, tests 75
- Troubleshooting, topics 73

V

- Verify printer is working 49

W

- Wearing the Printer 65
- WLAN, overview 57

Z

- Zebra Setup Utilities 53
- Zebra Setup Utility (Android) 53
- ZPL Font and Bar Code Specifications and Commands 83
- ZQ6 Accessories 90



Zebra Technologies Corporation
3 Overlook Point
Lincolnshire, IL 60069 USA
P: +1 847.634.6700 or F: +1 847.913.8766