

Crestron Flex Small Room Conference System with Jabra® PanaCast® 50 Video Bar and Wall Mounted Control Interface for Zoom Rooms® Software

The UC-B31-Z-WM and UC-B31-Z-WM-INDIA Crestron Flex conferencing system provides a small room video conference solution for use with Zoom Rooms® software. It supports up to three video displays and features a wall mount touch screen, UC bracket assembly, and smart soundbar and camera.

The latest firmware must be loaded onto the touch screen prior to operation. Refer to the touch screen's [product page](#) (resources tab) to download the latest device firmware. The latest UC-B31-Z-WM and UC-B31-Z-WM-INDIA firmware is installed using the auto update feature.

Minimum Requirements:

- A video display (not included) connected to the UC Engine. A second or third display is optional.
- A Zoom Rooms account or activation code (not included).



In the Box

- | | |
|---|-----------------------------------------------------------------------------------------------------------------------------------------------------------------------------------|
| 1 | Wall Mount Touch Screen
10.1 in. Wall Mount Touch Screen (6510814)
Mounting hardware |
| 1 | Smart Soundbar with Camera
Jabra PanaCast 50 video bar for Crestron Flex systems (6512600) or
Jabra PanaCast 50 video bar for Crestron Flex systems, India (6512698) |

UC Bracket Assembly

- | | |
|---|---------------------------------------------------------------------------------------------|
| 1 | UC Bracket Assembly with UC Engine and HDMI® content ingest (UC-BRKT-200-S-Z-ASSY, 6512690) |
| 2 | Anchor, Drywall, Plastic, 3/8 in. x 1/2 in. (9.5 mm x 12.7 mm) (2052565) |
| 1 | Key, Anchor (4529654) |
| 2 | Screw, 8-AB x 1-1/2 in. (38.1 mm), Pan Head, Combo (2052567) |
| 4 | Tie Wrap (2047935) |

Additional Items

- | | |
|---|-----------------------------------------------------|
| 1 | PoE injector (6502429) |
| 2 | Cable, CAT5e, RJ-45 - RJ-45, 7 ft (2.1 m) (6509924) |
| 1 | Cable, DisplayPort™ to HDMI, 6 ft (1.8 m) (6508282) |
| 1 | Cable, HDMI, 20 ft (6.1 m) (6503567) |
| 1 | Cable, HDMI, 6 ft (1.8 m) (6503565) |

Crestron Flex Small Room Conference System with Jabra® PanaCast® 50 Video Bar and Wall Mounted Control Interface for Zoom Rooms® Software



Mount Devices

Mount the UC Bracket Assembly

Mount the UC Bracket Assembly to VESA® compliant display devices, a wall, or other building structure. Anchors and screws are supplied for installation on walls with 3/8 in. (9.5 mm) to 3/4 in. (19 mm) thickness.

CAUTION: Preinstalled screws may protrude from the back of the UC Bracket Assembly. Exercise caution when handling the UC Bracket Assembly to avoid scratching or damaging surfaces.

NOTE: The integrated cable tie wraps are reusable. Avoid damaging the cable tie wraps.

Mount the Soundbar with Camera

Mount the included soundbar with camera according to its included documentation.

Mount the Touch Screen

Mount the included touch screen according to the [TSW-1070 Quick Start](#) (Doc. 8552).

Crestron Flex Small Room Conference System with Jabra® PanaCast® 50 Video Bar and Wall Mounted Control Interface for Zoom Rooms® Software



Connect

Identify the UC Bracket Assembly

The UC Bracket Assembly is available in two models. Identify the model included with your Crestron Flex system. Tap or click the corresponding image below to navigate to the appropriate connection instructions.

UC Bracket Assembly with HD-CONV-USB-200

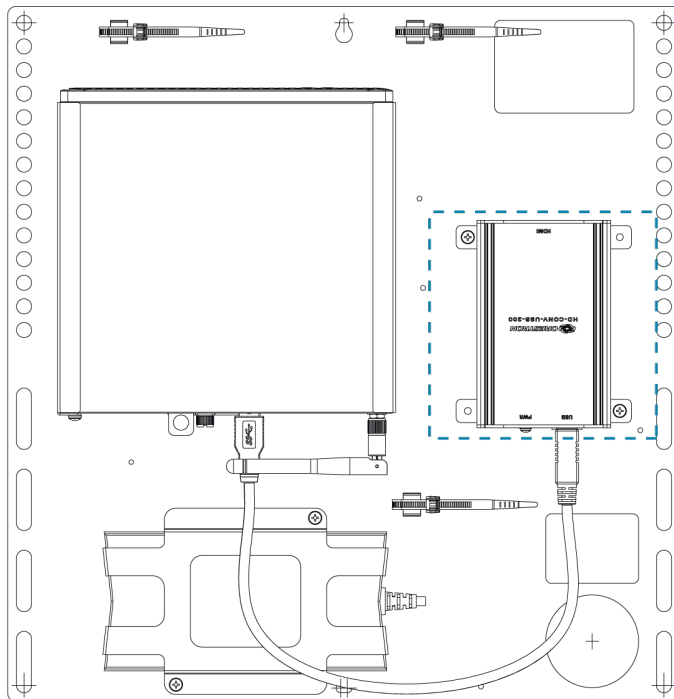

UC Bracket Assembly with HD-CONV-USB-300

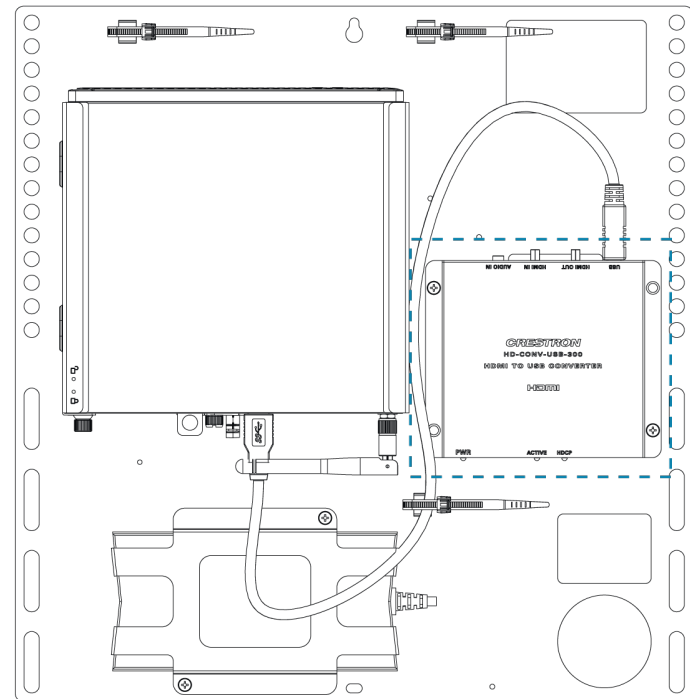

Crestron Flex Small Room Conference System with Jabra® PanaCast® 50 Video Bar and Wall Mounted Control Interface for Zoom Rooms® Software

System Overview

For UC Bracket Assembly with HD-CONV-USB-200

When connections are complete, the system appears as shown below. Refer to [Make Connections](#) for detailed connection instructions.

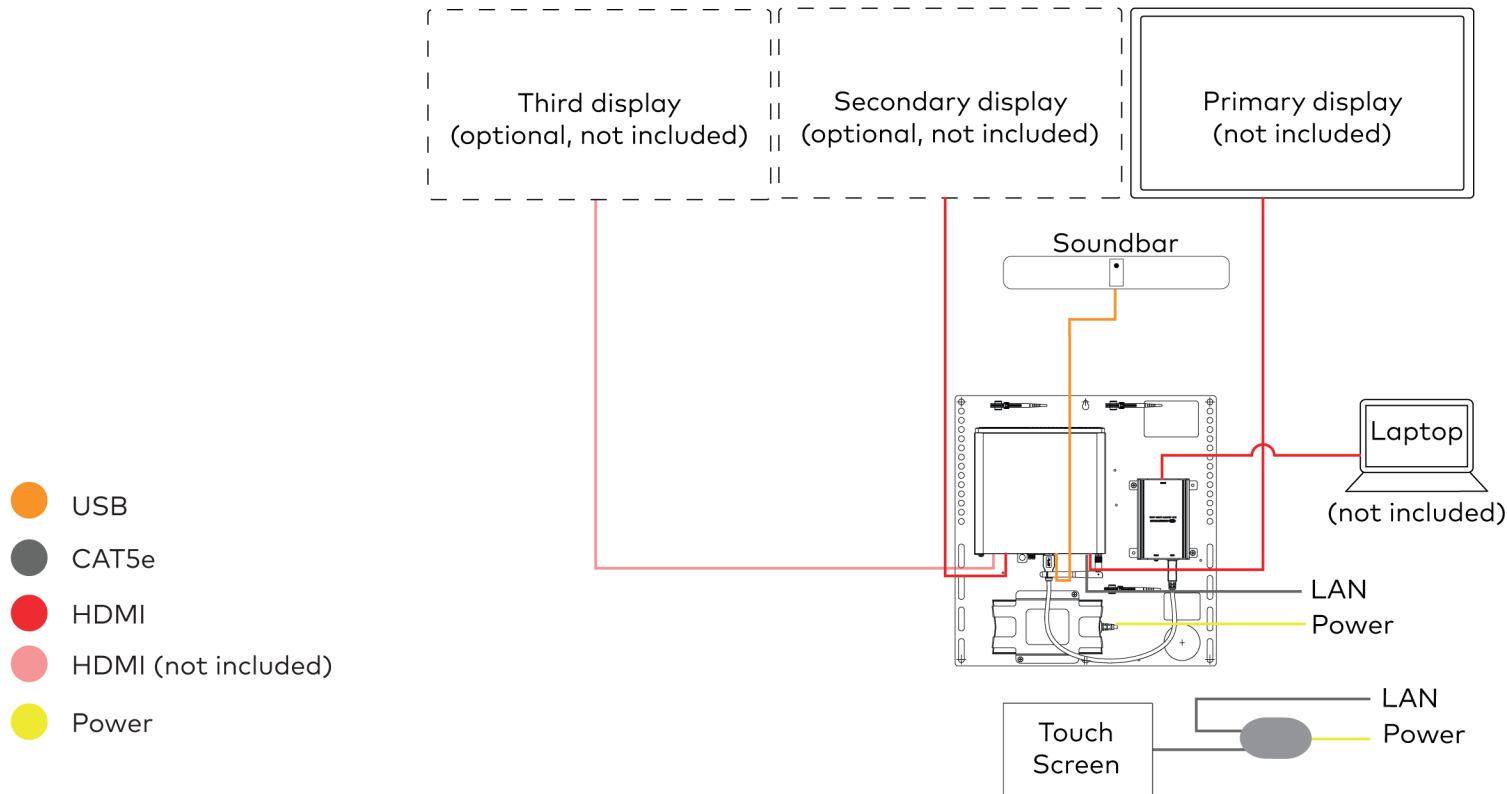

Crestron Flex Small Room Conference System with Jabra® PanaCast® 50 Video Bar and Wall Mounted Control Interface for Zoom Rooms® Software

For UC Bracket Assembly with HD-CONV-USB-300

When connections are complete, the system appears as shown below. Refer to [Make Connections](#) for detailed connection instructions.

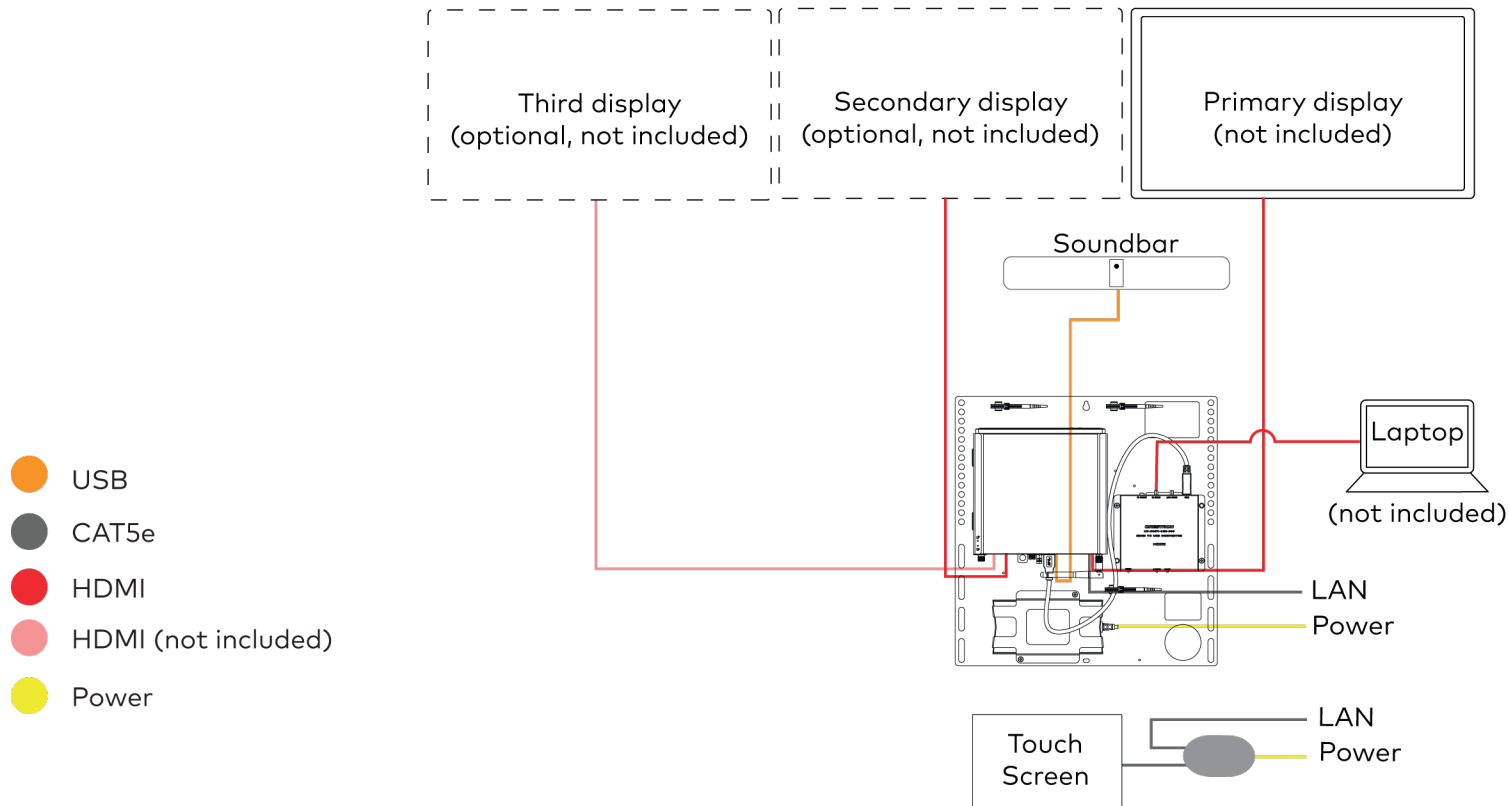

Crestron Flex Small Room Conference System with Jabra® PanaCast® 50 Video Bar and Wall Mounted Control Interface for Zoom Rooms® Software

Make Connections

NOTE: For reference, the UC Bracket Assembly is shown with the HD-CONV-USB-200 in the following connection diagrams. Unless otherwise indicated in this guide, the connections remain the same for the UC Bracket Assembly with HD-CONV-USB-200 and HD-CONV-USB-300.

1. Make UC Engine and touch screen connections as shown in the following illustration.

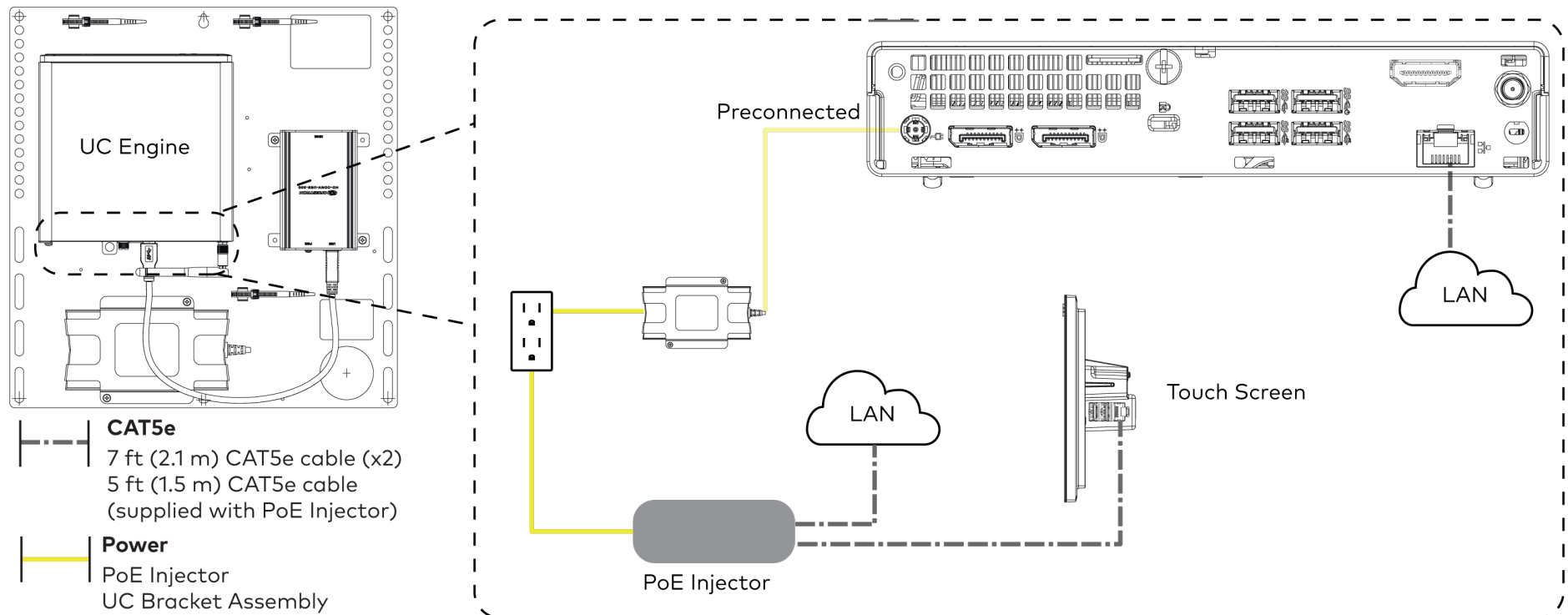

Crestron Flex Small Room Conference System with Jabra® PanaCast® 50 Video Bar and Wall Mounted Control Interface for Zoom Rooms® Software

2. Connect displays to the UC Engine.

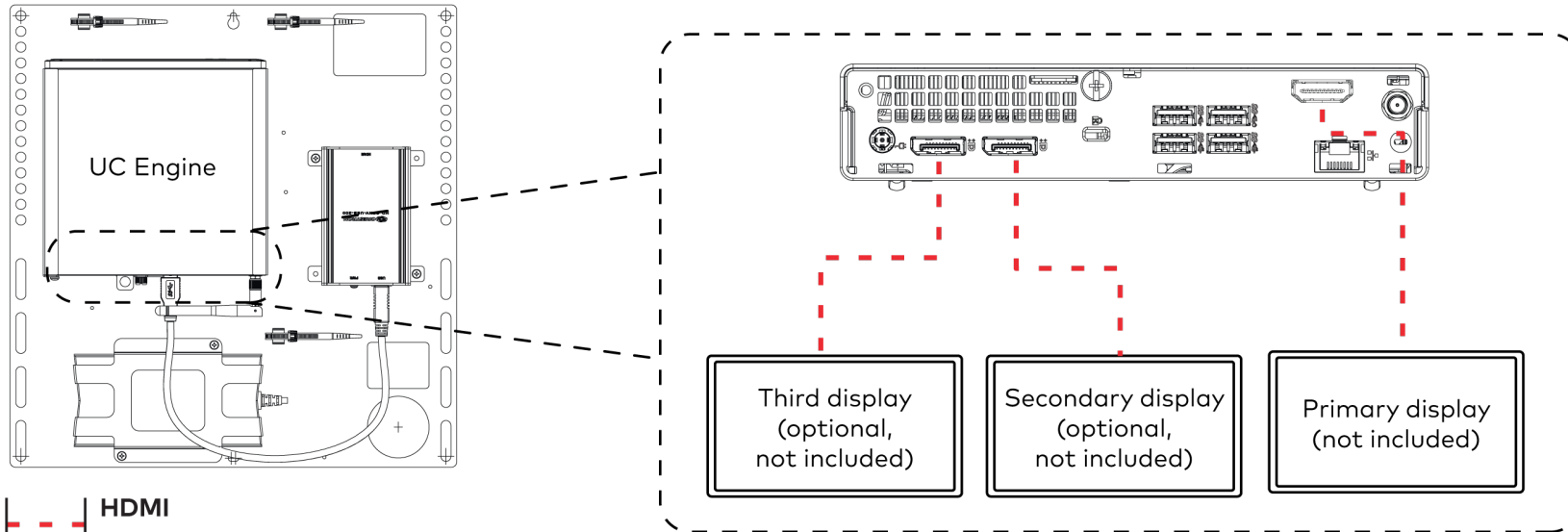

- HDMI**
- Primary: 6 ft (1.8 m) HDMI cable
 - Secondary : 6 ft (1.8 m) DisplayPort to HDMI cable
 - Third: DisplayPort to HDMI cable (not included)

Crestron Flex Small Room Conference System with Jabra® PanaCast® 50 Video Bar and Wall Mounted Control Interface for Zoom Rooms® Software

3. Connect the soundbar to the UC Engine as shown in the image below. Do not connect the soundbar to any of the other USB ports.

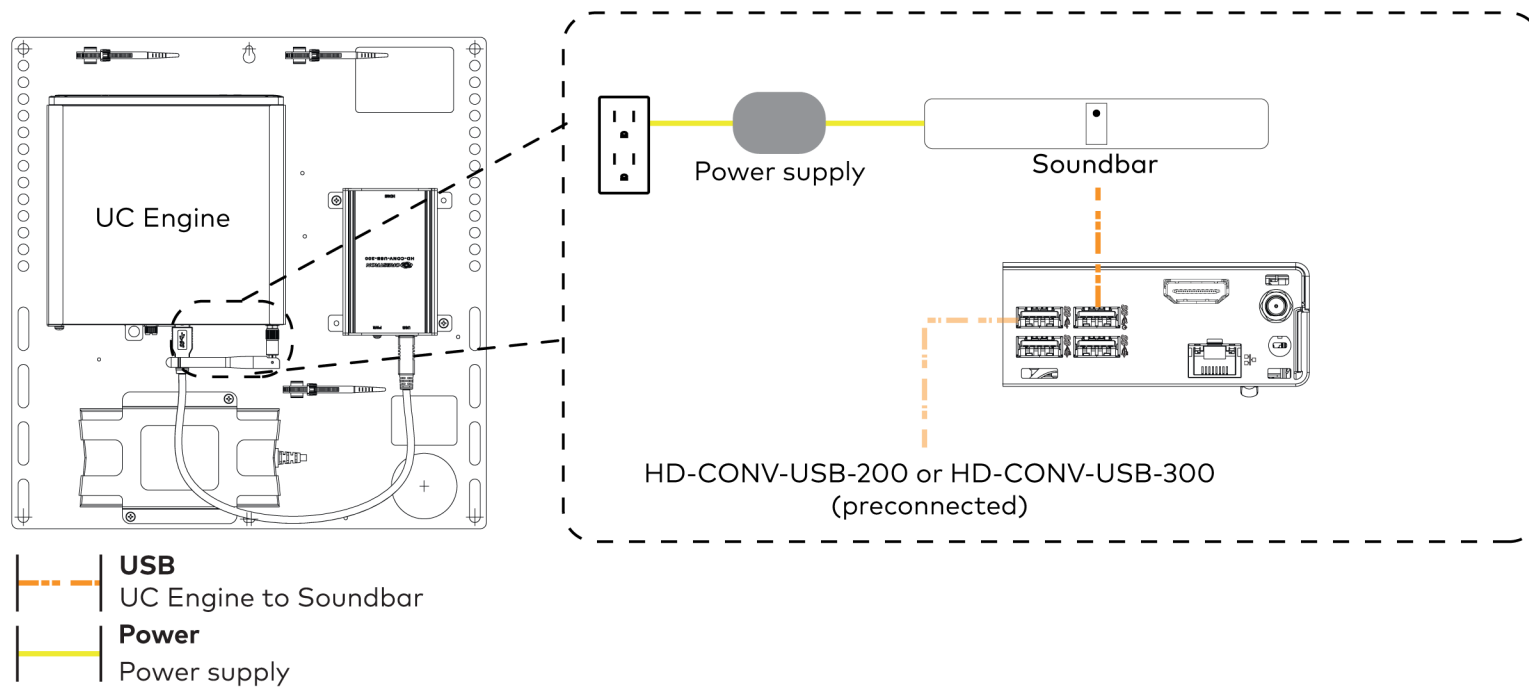

Crestron Flex Small Room Conference System with Jabra® PanaCast® 50 Video Bar and Wall Mounted Control Interface for Zoom Rooms® Software

4. Connect a laptop to the HD-CONV-USB-200 or HD-CONV-USB-300.

UC Bracket Assembly with HD-CONV-USB-200

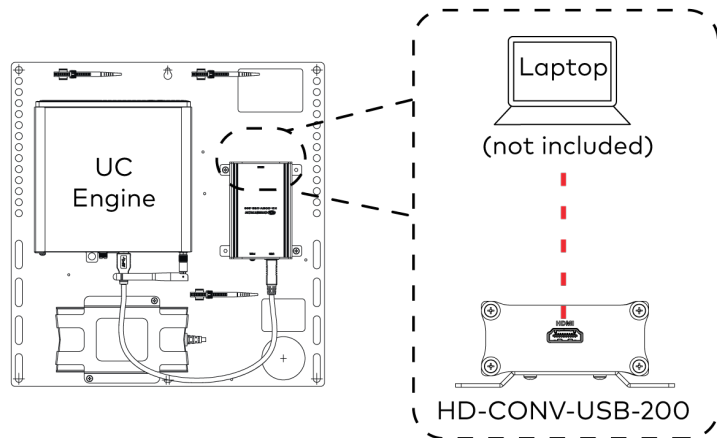

UC Bracket Assembly with HD-CONV-USB-300

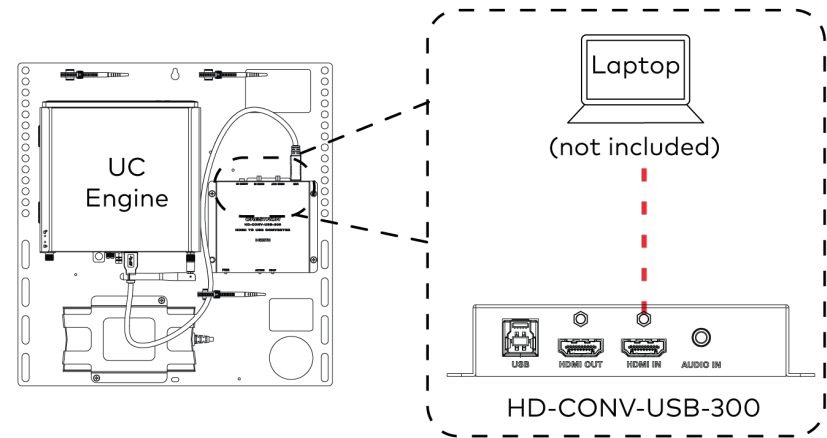

or

 **HDMI**
20 ft (6.1 m) HDMI cable

5. Bundle the cables to the bracket assembly with the integrated cable tie wraps. The cable tie wraps are reusable.

Crestron Flex Small Room Conference System with Jabra® PanaCast® 50 Video Bar and Wall Mounted Control Interface for Zoom Rooms® Software



Configure

Apply Power

Press the power button on the bottom of the UC Engine and apply power to all of the other devices in the system. The connected display device will show a pairing code.

Log In to the Zoom Rooms Service

1. Tap **Touch Here to Enable a Specific Application** on the bottom of the screen. A list of applications is displayed.
2. Tap **Zoom Rooms** and then tap **Confirm**. The touch screen will reboot.
3. Enter the pairing code shown on the display to pair the touch screen with the UC Engine. The Zoom Rooms controller app is displayed.
4. Log in to the Zoom Rooms service with an activation code or Zoom Rooms Credentials (email and password).
 - **Activation Code:**
 - a. Tap **Enter Activation Code**.
 - b. Enter the 16-digit activation code provided by the administrator to activate the Zoom Room that is assigned to the activation code. The Zoom Rooms Conference Room screen is shown on the display.
 - **Sign In:**
 - a. Tap **Sign In**.
 - b. Enter the Zoom Room credentials and tap **Sign In**.
 - c. Select the conference room name from the list and tap **Next**. The Zoom Rooms Conference Room screen is shown on the display.
5. Tap **Settings**. If a password is required, enter the password (the default password is "1234"). The **Settings** screen is displayed.
6. Tap **Microphone** and select the as the source.
7. Tap **Speaker** and select the as the source.
8. Tap **Meet Now** to exit.

Configure the System

Connect a USB keyboard and mouse (sold separately) to a USB port on the UC Engine to configure system features. For detailed information on using Zoom Rooms, refer to the [Zoom Rooms Help Center](#).

Crestron Flex Small Room Conference System with Jabra® PanaCast® 50 Video Bar and Wall Mounted Control Interface for Zoom Rooms® Software



Visit the Product Page

Scan the QR code to visit the product page.

UC-B31-Z-WM



www.crestron.com/model/6512604

UC-B31-Z-WM-INDIA



www.crestron.com/model/6512702

Additional Information

Original Instructions

The U.S. English version of this document is the original instructions. All other languages are a translation of the original instructions.

Crestron product development software is licensed to Crestron dealers and Crestron Service Providers (CSPs) under a limited nonexclusive, nontransferable Software Development Tools License Agreement. Crestron product operating system software is licensed to Crestron dealers, CSPs, and end-users under a separate End-User License Agreement. Both of these Agreements can be found on the Crestron website at www.crestron.com/legal/software_license_agreement.

The product warranty can be found at www.crestron.com/warranty.

The specific patents that cover Crestron products are listed at www.crestron.com/legal/patents.

Certain Crestron products contain open source software. For specific information, visit www.crestron.com/opensource.

Crestron and the Crestron logo are either trademarks or registered trademarks of Crestron Electronics, Inc. in the United States and/or other countries. Jabra and PanaCast are trademarks of GN Audio A/S in the United States and/or other countries. HDMI is either a trademark or registered trademark of HDMI Licensing LLC in the United States and/or other countries. DisplayPort and VESA are either trademarks or registered trademarks of Video Electronics Standards Association in the United States and/or other countries. Zoom Rooms is either a trademark or registered trademark of Zoom Video Communications, Inc. in the United States and/or other countries. Other trademarks, registered trademarks, and trade names may be used in this document to refer to either the entities claiming the marks and names or their products. Crestron disclaims any proprietary interest in the marks and names of others. Crestron is not responsible for errors in typography or photography.

©2023 Crestron Electronics, Inc.

Doc. 9178C

08/06/23