

2

1

THIS COPY IS PROVIDED ON A RESTRICTED BASIS AND IS NOT TO BE USED IN ANY WAY DETRIMENTAL TO THE INTERESTS OF PANDUIT CORP.

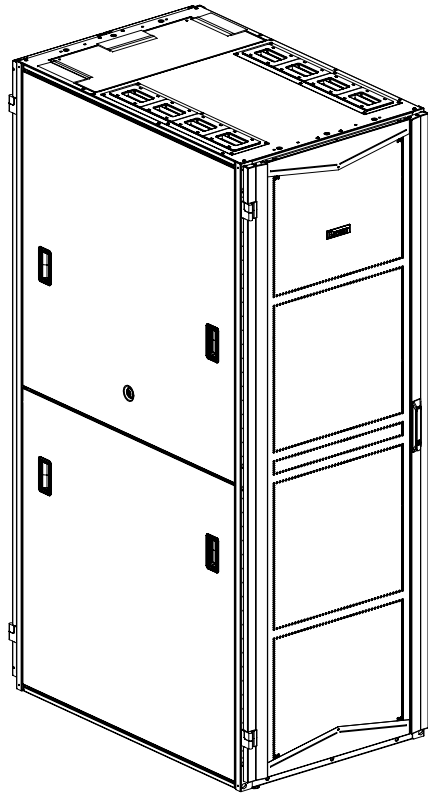

**FLEXFUSION™ CABINET  
WITH BEZELS AND COVERS**

**FLEXFUSION™ CABINET  
WITH BRUSHES**

700mm CABINET SHOWN

**NOTES:**

1. VISIT OUR ON-LINE CATALOG AT [WWW.PANDUIT.COM](http://WWW.PANDUIT.COM) FOR A LIST OF CURRENT PARTS APPLICABLE FOR USE WITH THIS PRODUCT.
2. FACTORY SETTINGS:  
SERVER CONFIGURATION - ALL WIDTHS AND DEPTHS:  
FRONT FACE OF FRONT E-RAILS ARE: 64.0mm ±2.0mm / [2.52in ±0.08in] FROM FRONT FACE OF FRAME.  
FRONT FACE OF REAR E-RAILS ARE: 742mm ±2.0mm / [29.2in ±0.08in] FROM FRONT FACE OF FRONT E-RAILS.  
NETWORK CONFIGURATION - ALL DEPTHS:  
600mm WIDE:  
FRONT FACE OF FRONT E-RAILS ARE: 234.0mm ±2.0mm / [9.2in ±0.08in] FROM FRONT FACE OF FRAME.  
FRONT FACE OF REAR E-RAILS ARE: 572mm ±2.0mm / [22.5in ±0.08in] FROM FRONT FACE OF FRONT E-RAILS.  
700mm & 800mm WIDE:  
FRONT FACE OF FRONT E-RAILS ARE: 177.0mm ±2.0mm / [7.0in ±0.08in] FROM FRONT FACE OF FRAME.  
FRONT FACE OF REAR E-RAILS ARE: 629mm ±2.0mm / [24.8in ±0.08in] FROM FRONT FACE OF FRONT E-RAILS.
3. FOR REAR E-RAIL ADJUSTMENTS  
SEE TABLE ON SHEET 8
4. CAN BE USED WITH ANY 19" EIA STANDARD COMPONENT IN ADDITION TO ALL PANDUIT HORIZONTAL CABLE MANAGEMENT AND PATCH PANEL PRODUCTS
5. EIA UNIVERSAL STANDARD HOLE PROGRESSION ON EQUIPMENT RAILS  
15.88mm, 15.88mm, 12.70mm, 15.88mm, 15.88mm, 12.7mm...ETC.
6. RACK UNIT SPACING NUMERALS ARE CLEARLY PRINTED ON EQUIPMENT MOUNTING RAILS
7. FRONT TO BACK BEAMS ARE NUMBERED AND INDEXED FOR E-RAIL LOCATIONS
8. PARTS SUPPLIED:  
-FRAME  
-E-RAILS  
-TOP CAP  
-LEVELING LEGS
9. FULLY BONDED STRUCTURE WHEN ASSEMBLED PER INSTRUCTIONS
10. SINGLE POINT GROUND LOCATIONS AT TOP AND BOTTOM, BOTH FRONT AND BACK OF CABINET
11. STATIC LOAD RATING: 1588 kg (3500 lbs)
12. ROLLING LOAD RATING: 1134 kg (2500 lbs)
13. PRIMARY DIMENSIONS ARE IN MILLIMETERS

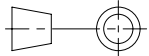
TITLE		<b>FLEXFUSION™ CABINET FAMILY</b>	
		CUSTOMER DRAWING	
ITEM REVISION NAME		<b>00460NXB/02</b>	
DATASET FILE NAME		<b>00460NXB_DC/02A</b>	
		<b>PANDUIT</b>	
		MATERIAL:  <b>N/A</b>	
		DRAWING NUMBER: <b>00460NXB-DC</b>	
		THIRD ANGLE PROJECTION	
DRAWN BY	DATE	CHK	SCALE
LEE	1/5/2021	SSP	NONE
REV		DESCRIPTION	
DATE		ECN	
BY		SHT 1 OF 12	
CHK		A	
APR			

02A	8/4/22	MEX-JAGC	BRAP	ELE	REPLACED 51RU VALUES W/ 52RU, UPDATED NOTE #2	V09002FD/04
01B	9/13/21	MES	BRAP	ELE	UPDATED DIMENSIONS	V09002FD/03
01A	7/27/2021	MES	BRAP	ELE	ADDED WEIGHTS	V09002FD/02
00A	1/5/2021	LEE	SSP	ELE	DRAWING RELEASE	V09002FD/00
REV	DATE	BY	CHK	APR	DESCRIPTION	ECN

2

1

D10.100DA/16

THIS COPY IS PROVIDED ON A RESTRICTED BASIS AND IS NOT TO BE USED IN ANY WAY DETRIMENTAL TO THE INTERESTS OF PANDUIT CORP.

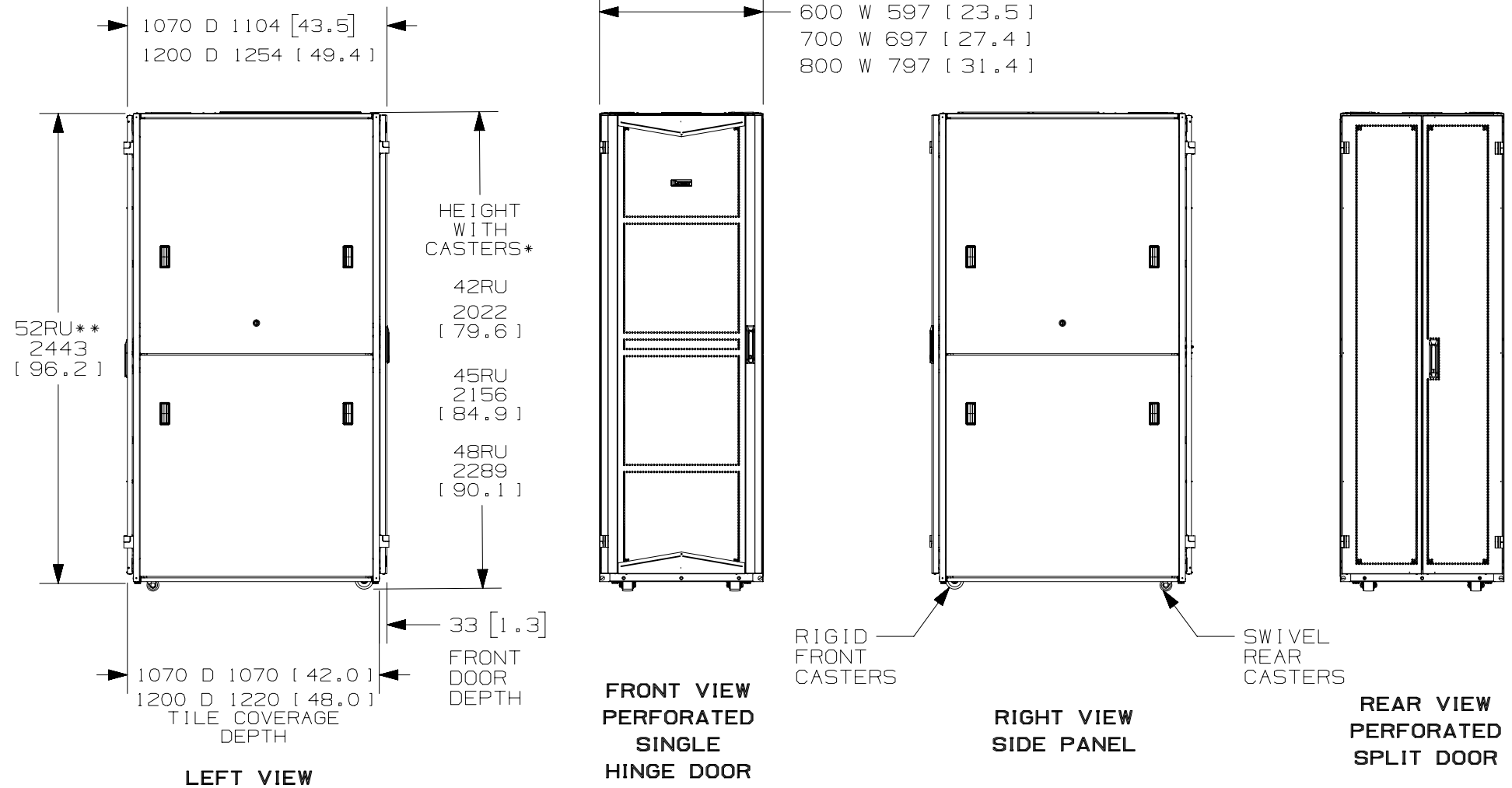

\* HEIGHT WITHOUT CASTERS IS 24mm [0.94] LESS  
 \*\* CASTERS ARE NOT AVAILABLE ON 52RU CABINETS

TITLE		<b>FLEXFUSION™ CABINET FAMILY</b>	
		CUSTOMER DRAWING	
ITEM REVISION NAME		00460NXB/02	
DATASET FILE NAME		00460NXB_DC/02A	
		<b>PANDUIT</b>	
		MATERIAL: N/A	
		DRAWING NUMBER: 00460NXB-DC	
		THIRD ANGLE PROJECTION	
DRAWN BY	DATE	CHK	SCALE
LEE	1/5/2021	SSP	NONE
REV		SHT 2 OF 12	
DATE		SIZE	
		A	

REV	DATE	BY	CHK	APR	DESCRIPTION	ECN
02A	8/4/22	MEX-JAGC	BRAP	ELE	SEE SHEET 1 FOR REVISIONS	V09002FD/04
01B	9/13/2021	MES	BRAP	ELE	SEE SHEET ONE OF 12 FOR REVISIONS	V09002FD/03
01A	7/27/2021	MES	BRAP	ELE	SEE SHEET ONE OF 12 FOR REVISIONS	V09002FD/02
00A	1/5/2021	LEE	SSP	ELE	DRAWING RELEASE	V09002FD/00

D110100DA/16

THIS COPY IS PROVIDED ON A RESTRICTED BASIS AND IS NOT TO BE USED IN ANY WAY DETRIMENTAL TO THE INTERESTS OF PANDUIT CORP.

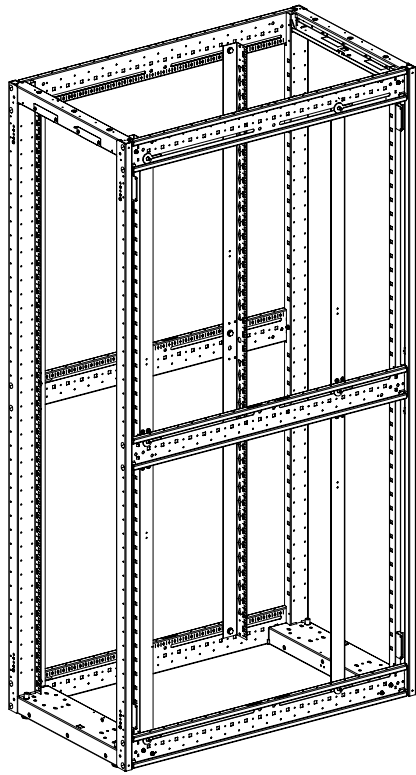

600mm E-RAIL ARRANGEMENT  
NO PASS THRU OPENINGS

PASS THRU COVERS

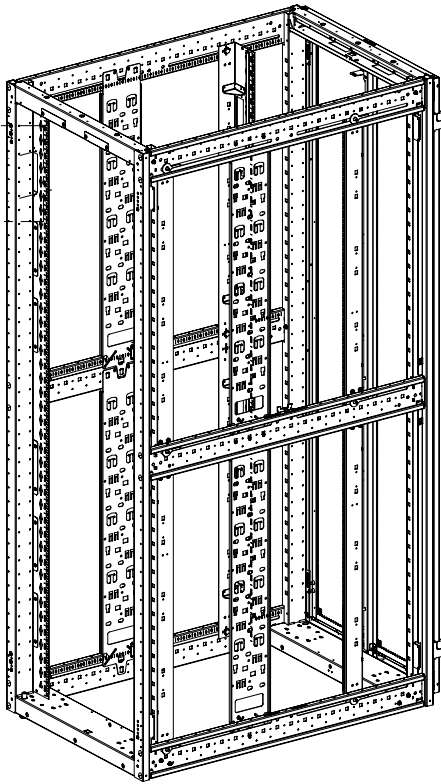

700mm E-RAIL ARRANGEMENT

PASS THRU OPENINGS FOR  
 42RU - 12 PASS THRU OPENINGS  
 45RU - 12 PASS THRU OPENINGS  
 48RU - 16 PASS THRU OPENINGS  
 52RU - 16 PASS THRU OPENINGS  
 122mm X 34mm  
 (4.8) X (1.3) VIEW BL

PASS THRU COVERS

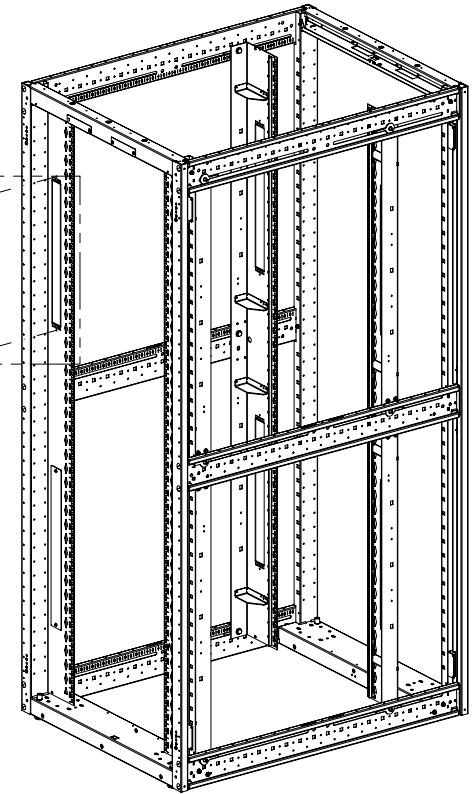

800mm E-RAIL ARRANGEMENT  
 4 PASS THRU OPENINGS  
 FOR ALL RU SIZED CABINETS  
 19" X 1RU

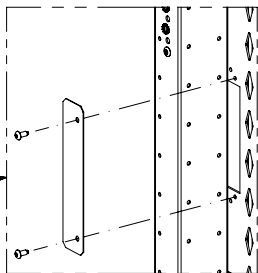

NOTE:  
 \*OPENINGS WILL FIT  
 \*CVPTB1X4 - SOLD SEPARATELY  
 \*PASS THRU OPENING PARTIALLY  
 BLOCKED WHEN E-RAILS ARE  
 IN COMPLETELY FORWARD  
 POSITION

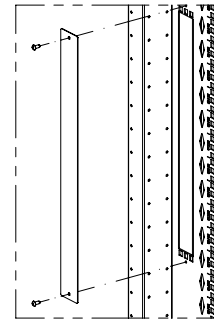

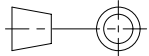
TITLE		<b>FLEXFUSION™ CABINET FAMILY</b>		
		CUSTOMER DRAWING		
ITEM REVISION NAME		00460NXB/02		
DATASET FILE NAME		00460NXB_DC/02A		
		MATERIAL:  N/A		
		DRAWING NUMBER: 00460NXB-DC		
 THIRD ANGLE PROJECTION				
DRAWN BY	DATE	CHK	SCALE	SIZE
LEE	1/5/2021	SSP	NONE	A

REV	DATE	BY	CHK	APR	DESCRIPTION	ECN
02A	8/4/22	MEX-JAGC	BRAP	ELE	SEE SHEET 1 FOR REVISIONS	V09002FD/04
01B	9/13/2021	MES	BRAP	ELE	SEE SHEET ONE OF 12 FOR REVISIONS	V09002FD/03
01A	7/27/2021	MES	BRAP	ELE	SEE SHEET ONE OF 12 FOR REVISIONS	V09002FD/02
00A	1/5/2021	LEE	SSP	ELE	DRAWING RELEASE	V09002FD/00

D110100DA/16

THIS COPY IS PROVIDED ON A RESTRICTED BASIS AND IS NOT TO BE USED IN ANY WAY DETRIMENTAL TO THE INTERESTS OF PANDUIT CORP.

**FRONT DOOR, REAR DOOR,  
AND SIDE PANELS NOT SHOWN**

600mm 118 [ 4.6 ]  
700mm 168 [ 6.6 ]  
800mm 218 [ 8.6 ]

2X 180 [ 7.1 ]

TOP CAP HATCH  
DOOR FOR CABLES  
SEE SHEET 8 FOR  
OPENING SIZE

RACK UNITS ARE  
NUMBERED AND  
INDEXED FOR  
IDENTIFICATION

VERTICAL CABLE  
MANAGEMENT FINGERS  
WITH BEND RADIUS  
CONTROL CAN BE ASSEMBLED  
TO FRONT OR REAR E-RAILS  
BY CUSTOMER

(2) ADJUSTABLE REAR  
EQUIPMENT RAILS

SEE SHEET 8 FOR  
DEFAULT SETTINGS  
AND ADJUSTABILITY  
RANGE TABLE

(2) ADJUSTABLE FRONT  
EQUIPMENT RAILS

SEE SHEET 8 FOR  
DEFAULT SETTINGS  
AND ADJUSTABILITY  
RANGE TABLE

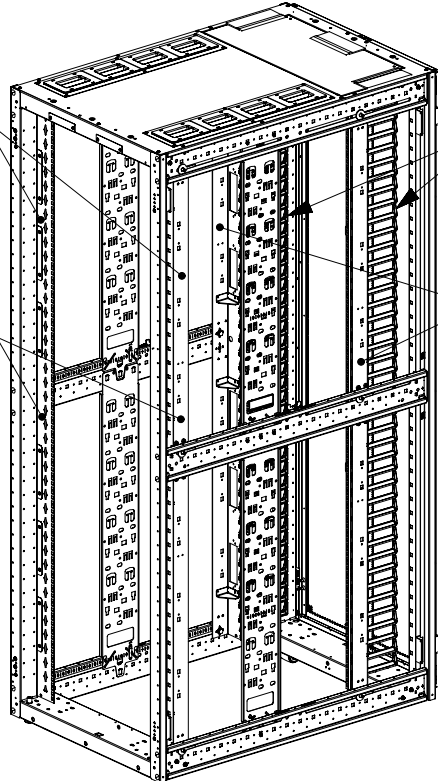

FRONT

REAR

REAR

1070 993 [ 39 ]  
1200 1143 [ 45 ]

SEE SHEET 9 FOR  
BEZELS AND COVERS  
COMPATABILITY TABLE

(6) LOCATIONS FOR 1070mm  
(6) LOCATIONS FOR 1200mm  
TAPPED FOR M10 THREADED ROD

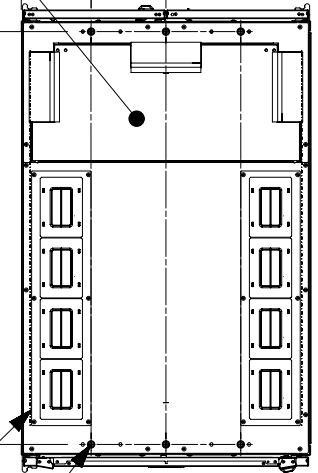

FRONT

TOP VIEW

TOP CAP WITH BEZEL & COVERS OPTION SHOWN  
BRUSH OPTION ALSO AVAILABLE

REV	DATE	BY	CHK	APR	DESCRIPTION	ECN
02A	8/4/22	MEX-JAGC	BRAP	ELE	SEE SHEET 1 FOR REVISIONS	V09002FD/04
01B	9/13/2021	MES	BRAP	ELE	SEE SHEET ONE OF 12 FOR REVISIONS	V09002FD/03
01A	7/27/2021	MES	BRAP	ELE	SEE SHEET ONE OF 12 FOR REVISIONS	V09002FD/02
00A	1/5/2021	LEE	SSP	ELE	DRAWING RELEASE	V09002FD/00

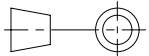
TITLE						FLEXFUSION™ CABINET FAMILY					
CUSTOMER DRAWING						ITEM REVISION NAME					
						00460NXB/02					
DATASET FILE NAME						00460NXB_DC/02A					
MATERIAL:						N/A					
DRAWING NUMBER:						00460NXB-DC					
DRAWN BY		DATE		CHK		SCALE		THIRD ANGLE PROJECTION		DRAWING NUMBER:	
LEE		1/5/2021		SSP		NONE				SHT 4 OF 12	
										SIZE	
										A	

D10100DA/16

THIS COPY IS PROVIDED ON A RESTRICTED BASIS AND IS NOT TO BE USED IN ANY WAY DETRIMENTAL TO THE INTERESTS OF PANDUIT CORP.

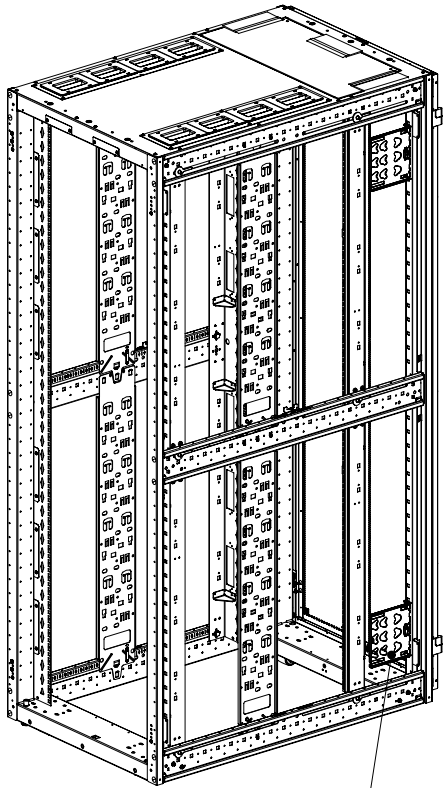

FRONT

(2) STANDARD PDU BRACKETS  
CAN BE INSTALLED ON LEFT, RIGHT OR BOTH SIDES

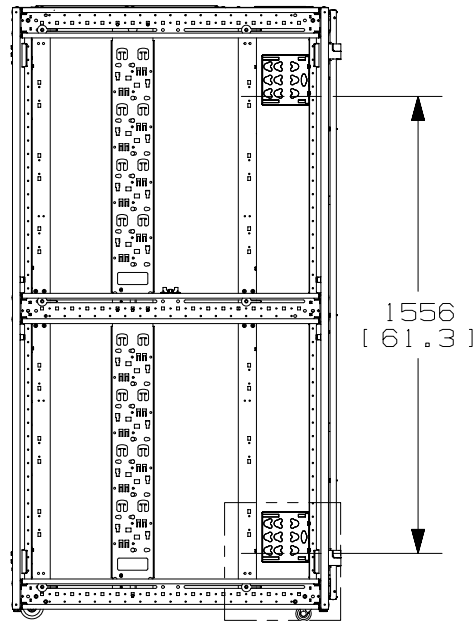

RIGHT SIDE VIEW

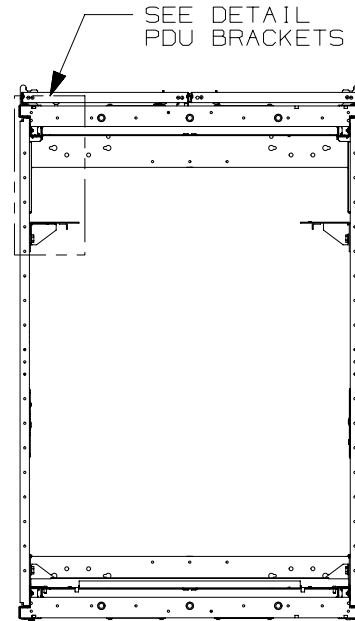

TOP VIEW

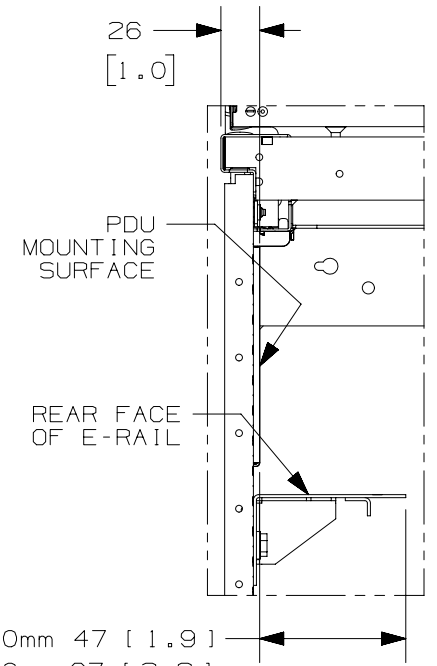

DETAIL

PDU BRACKETS

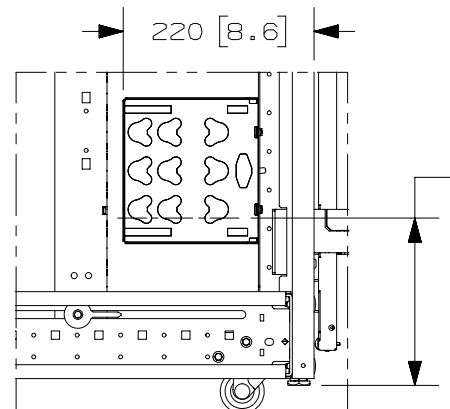

PDU BRACKET DETAIL

- 42RU - 185 [ 7.3 ]
- 45RU - 318 [ 12.5 ]
- 48RU - 452 [ 17.8 ]
- 52RU - 630 [ 24.8 ]

TITLE		<b>FLEXFUSION™ CABINET FAMILY</b>	
		CUSTOMER DRAWING	
ITEM REVISION NAME		<b>00460NXB/02</b>	
DATASET FILE NAME		<b>00460NXB_DC/02A</b>	
		<b>PANDUIT</b>	
		MATERIAL: <b>N/A</b>	
		DRAWING NUMBER: <b>00460NXB-DC</b>	
		THIRD ANGLE PROJECTION	
DRAWN BY	DATE	CHK	SCALE
LEE	1/5/2021	SSP	NONE
REV		DESCRIPTION	
DATE		ECN	
BY		SCALE	
CHK		SIZE	
APR		SHT 5 OF 12	
		<b>A</b>	

02A	8/4/22	MEX-JAGC	BRAP	ELE	SEE SHEET 1 FOR REVISIONS	V09002FD/04
01B	9/13/2021	MES	BRAP	ELE	SEE SHEET ONE OF 12 FOR REVISIONS	V09002FD/03
01A	7/27/2021	MES	BRAP	ELE	SEE SHEET ONE OF 12 FOR REVISIONS	V09002FD/02
00A	1/5/2021	LEE	SSP	ELE	DRAWING RELEASE	V09002FD/00

D10100DA/16

THIS COPY IS PROVIDED ON A RESTRICTED BASIS AND IS NOT TO BE USED IN ANY WAY DETRIMENTAL TO THE INTERESTS OF PANDUIT CORP.

2

1

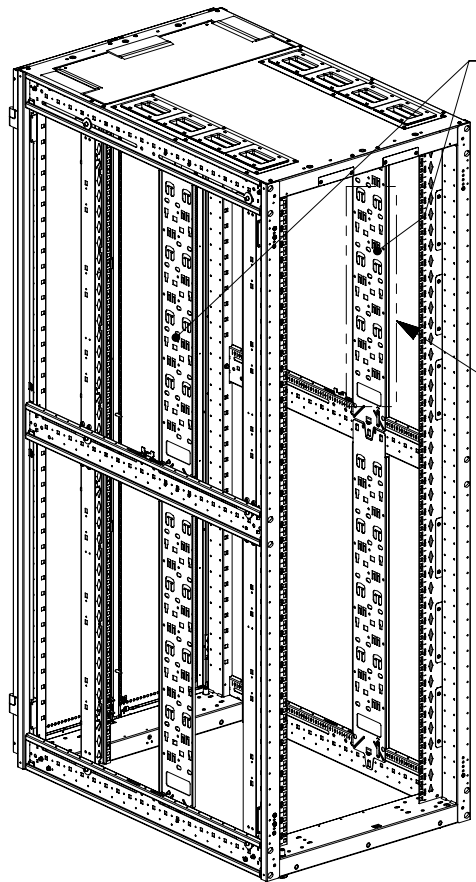

VERTICAL CABLE MANAGEMENT PANEL

CAN BE INSTALLED ON LEFT, RIGHT OR BOTH SIDES

DETAIL A

CUT-OUT FOR FLEX CLIP

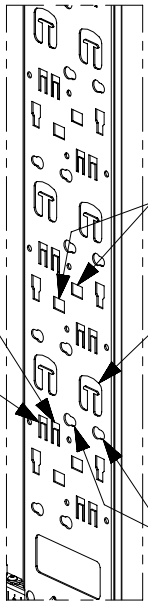
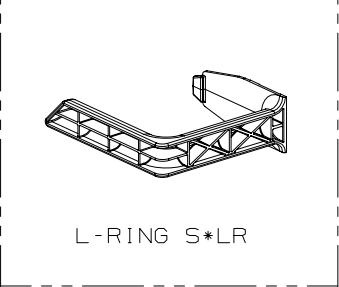
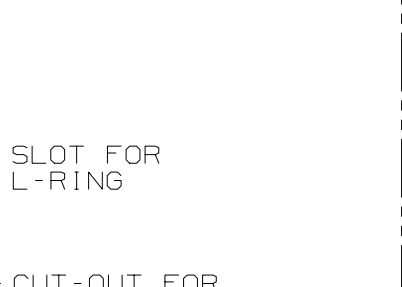
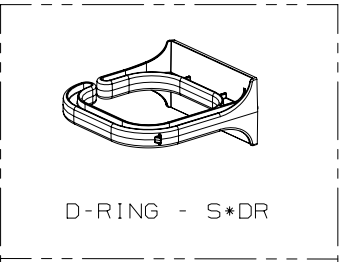
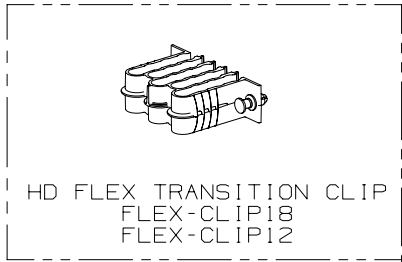

SLOT FOR L-RING

CUT-OUT FOR HOOK & LOOP

SLOT FOR D-RING

OPTIONAL-NOT INCLUDED

FRONT

DETAIL A

VERTICAL CABLE MANAGER PANEL OPTIONS

REAR

REV	DATE	BY	CHK	APR	DESCRIPTION	ECN
02A	8/4/22	MEX-JAGC	BRAP	ELE	SEE SHEET 1 FOR REVISIONS	V09002FD/04
01B	9/13/2021	MES	BRAP	ELE	SEE SHEET ONE OF 12 FOR REVISIONS	V09002FD/03
01A	7/27/2021	MES	BRAP	ELE	SEE SHEET ONE OF 12 FOR REVISIONS	V09002FD/02
00A	1/5/2021	LEE	SSP	ELE	DRAWING RELEASE	V09002FD/00

TITLE							FLEXFUSION™ CABINET FAMILY		
							CUSTOMER DRAWING		
ITEM REVISION NAME							00460NXB/02		<b>PANDUIT</b>
DATASET FILE NAME							00460NXB_DC/02A		
MATERIAL:							N/A		
DRAWING NUMBER:							00460NXB-DC		
DRAWN BY		DATE		CHK		SCALE		THIRD ANGLE PROJECTION	
LEE		1/5/2021		SSP		NONE		SHT 6 OF 12	
							SIZE		A

2

1

D10100DX/16

THIS COPY IS PROVIDED ON A RESTRICTED BASIS AND IS NOT TO BE USED IN ANY WAY DETRIMENTAL TO THE INTERESTS OF PANDUIT CORP.

DESCRIPTION	DIM "A"	DIM "B"	DIM "C"	DIM "D"	DIM "E"	DIM "F"
	LEVELING LEGS		FLOOR MOUNT		FLOOR OPENING	
FLEX FUSION™ 600mm WIDE X 1070mm DEEP	462 (18.2)	1010 (39.8)	390 (15.4)	744 (29.3)	792 (31.2)	553 (21.2)
FLEX FUSION™ 600mm WIDE X 1200mm DEEP	462 (18.2)	1160 (45.7)	390 (15.4)	894 (35.2)	942 (37.1)	553 (21.2)
FLEX FUSION™ 700mm WIDE X 1070mm DEEP	562 (22.1)	1010 (39.8)	490 (19.3)	744 (29.3)	792 (31.2)	653 (25.7)
FLEX FUSION™ 700mm WIDE X 1200mm DEEP	562 (22.1)	1160 (45.7)	490 (19.3)	894 (35.2)	942 (37.1)	653 (25.7)
FLEX FUSION™ 800mm WIDE X 1070mm DEEP	662 (26.1)	1010 (39.8)	590 (23.2)	744 (29.3)	792 (31.2)	753 (29.7)
FLEX FUSION™ 800mm WIDE X 1200mm DEEP	662 (26.1)	1160 (45.7)	590 (23.2)	894 (35.2)	942 (37.1)	753 (29.7)

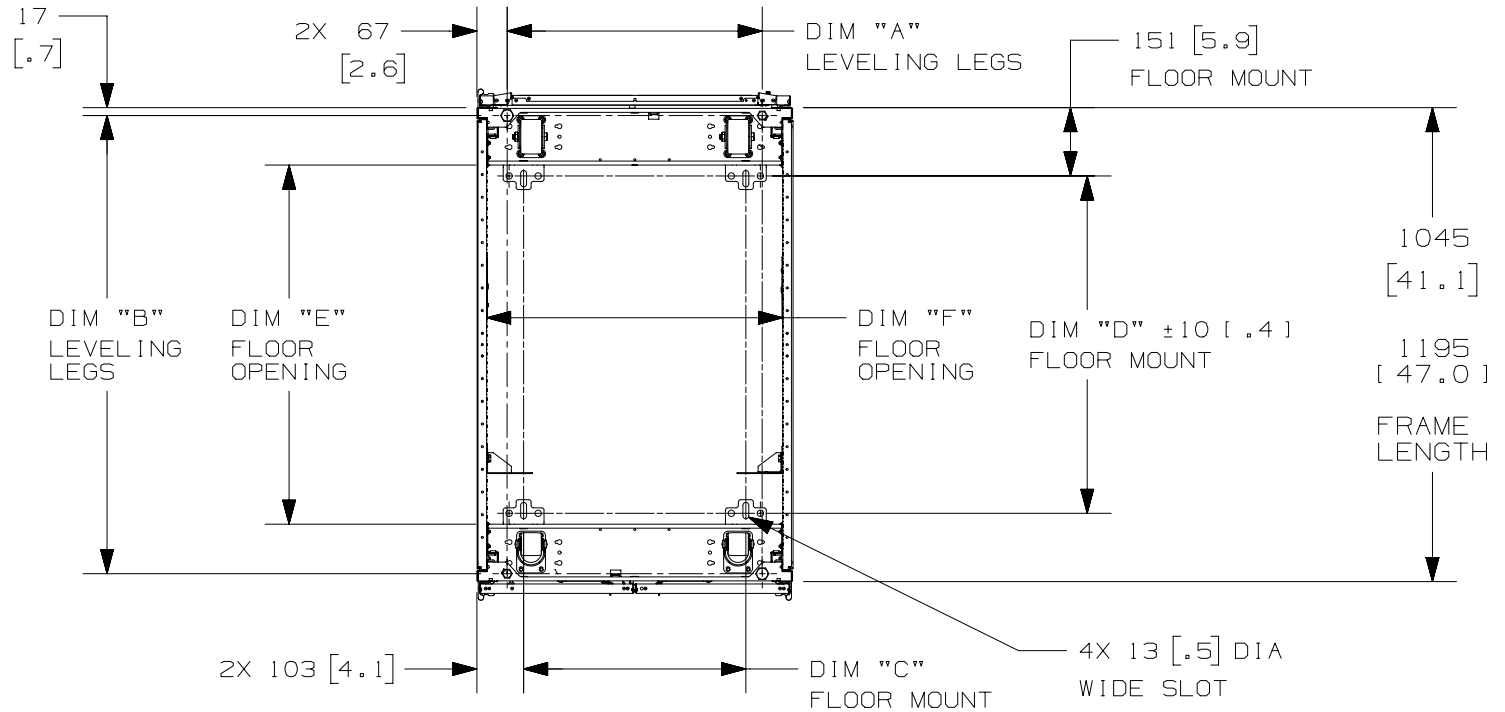

REV	DATE	BY	CHK	APR	DESCRIPTION	ECN
02A	8/4/22	MEX-JAGC	BRAP	ELE	SEE SHEET 1 FOR REVISIONS	V09002FD/04
01B	9/13/2021	MES	BRAP	ELE	SEE SHEET ONE OF 12 FOR REVISIONS	V09002FD/03
01A	7/27/2021	MES	BRAP	ELE	SEE SHEET ONE OF 12 FOR REVISIONS	V09002FD/02
00A	1/5/21	LEE	SSP	ELE	DRAWING RELEASE	V09002FD/00

TITLE

## FLEXFUSION™ CABINET FAMILY

CUSTOMER DRAWING

ITEM REVISION NAME  
**00460NXB/02**

DATASET FILE NAME  
**00460NXB\_DC/02A**

**PANDUIT**

MATERIAL:  
**N/A**

DRAWING NUMBER:  
**00460NXB-DC**

THIRD ANGLE PROJECTION

DRAWN BY <b>LEE</b>	DATE <b>1/5/2021</b>	CHK <b>SSP</b>	SCALE <b>NONE</b>	SHT 7 OF 12	SIZE <b>A</b>
------------------------	-------------------------	-------------------	----------------------	-------------	------------------

D10100DA/16

THIS COPY IS PROVIDED ON A RESTRICTED BASIS AND IS NOT TO BE USED IN ANY WAY DETRIMENTAL TO THE INTERESTS OF PANDUIT CORP.

FRONT AND REAR E-RAIL POSITION RANGE			
WIDTH	DEPTH	FRONT OF FRAME TO FRONT RAIL	FRONT TO REAR RAIL SPAN
600	1070	64mm (2.5")	154mm TO 915mm / (6.1" TO 36.0")
600	1200	64mm (2.5")	154mm TO 1065mm / (6.1" TO 42.0")
700	1070	64mm (2.5")	166mm TO 915mm / (6.5" TO 36.0")
700	1200	64mm (2.5")	166mm TO 1065mm / (6.5" TO 42.0")
800	1070	64mm (2.5")	166mm TO 915mm / (6.5" TO 36.0")
800	1200	64mm (2.5")	166mm TO 1065mm / (6.5" TO 42.0")

NOTE: MAXIMUM E-RAIL SPAN ONLY POSSIBLE IF NO VERTICAL CABLE MANAGEMENT FINGERS OR PDU BRACKETS ARE INSTALLED

B

B

A

A

D110100DA/16

								TITLE <b>FLEXFUSION™ CABINET FAMILY</b>				
								CUSTOMER DRAWING				
								ITEM REVISION NAME <b>00460NXB/02</b>				
								DATASET FILE NAME <b>00460NXB_DC/02A</b>				
02A	8/4/22	MEX-JAGC	BRAP	ELE	SEE SHEET 1 FOR REVISIONS	V09002FD/04				MATERIAL: <b>N/A</b>		
01B	9/13/2021	MES	BRAP	ELE	SEE SHEET ONE OF 12 FOR REVISIONS	V09002FD/03				DRAWING NUMBER: <b>00460NXB-DC</b>		
01A	7/27/2021	MES	BRAP	ELE	SEE SHEET ONE OF 12 FOR REVISIONS	V09002FD/02						
00A	1/5/2021	LEE	SSP	ELE	DRAWING RELEASE	V09002FD/00						
REV	DATE	BY	CHK	APR	DESCRIPTION	ECN	DRAWN BY <b>LEE</b>	DATE <b>1/5/2021</b>	CHK <b>SSP</b>	SCALE <b>NONE</b>	SHT 8 OF 12	SIZE <b>A</b>



THIS COPY IS PROVIDED ON A RESTRICTED BASIS AND IS NOT TO BE USED IN ANY WAY DETRIMENTAL TO THE INTERESTS OF PANDUIT CORP.

**TOP CAP BEZELS AND COVERS COMPATABILITY - 600, 700 & 800**

DEPTH	# OF CABLE OPENINGS	SIZE OF CABLE OPENING	COMPATIBLE WITH COOL BOOT-SOLD SEPARATELY
1070	8	83mm [ 3.3 ] X 120mm [ 4.7 ]	CTGN3X5
1200	10	83mm [ 3.3 ] X 120mm [ 4.7 ]	CTGN3X5

**TOP CAP BRUSH COMPATABILITY - 600, 700 & 800**

DEPTH	# OF CABLE OPENINGS	SIZE OF CABLE OPENING	REPLACEMENT BRUSH KIT
1070	2	87mm [ 3.4 ] X 600mm [ 23.6 ]	XG-TCBS1B or XG-TCBS1W
1200	2	87mm [ 3.4 ] X 750mm [ 29.5 ]	XG-TCBS2B or XG-TCBS2W

**TOP CAP HATCH BRUSH OPENING - 600, 700 & 800**

DEPTH	# OF HATCH BRUSH OPENINGS	HATCH BRUSH OPENING
1070 OR 1200	3	(1) 170 [ 6.7 ] X 59 [ 2.3 ] (2) 169 [ 6.7 ] X 56 [ 2.2 ]

**TOP CAP HATCH OPENING - 1070 & 1200 DEPTH**

WIDTH	REAR SIDE HATCH OPENING
600	284mm X 548mm ( 11.2 X 23.0 )
700	284mm X 648mm ( 11.2 X 25.5 )
800	284mm X 748mm ( 11.2 X 29.5 )

REV	DATE	BY	CHK	APR	DESCRIPTION	ECN
02A	8/4/22	MEX-JAGC	BRAP	ELE	SEE SHEET 1 FOR REVISIONS	V09002FD/04
01B	9/13/2021	MES	BRAP	ELE	SEE SHEET ONE OF 12 FOR REVISIONS	V09002FD/03
01A	7/27/2021	MES	BRAP	ELE	SEE SHEET ONE OF 12 FOR REVISIONS	V09002FD/02
00A	1/5/2021	LEE	SSP	ELE	DRAWING RELEASE	V09002FD/00

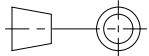
TITLE		<b>FLEXFUSION™ CABINET FAMILY</b>	
		CUSTOMER DRAWING	
ITEM REVISION NAME		00460NXB/02	
DATASET FILE NAME		00460NXB_DC/02A	
		<b>PANDUIT</b>	
		MATERIAL:  N/A	
		DRAWING NUMBER: 00460NXB-DC	
		THIRD ANGLE PROJECTION	
DRAWN BY	DATE	CHK	SCALE
LEE	1/5/2021	SSP	NONE
SHT 9 OF 12			A

D10100DA/16

THIS COPY IS PROVIDED ON A RESTRICTED BASIS AND IS NOT TO BE USED IN ANY WAY DETRIMENTAL TO THE INTERESTS OF PANDUIT CORP.

PART NO.	DESCRIPTION	CABINET WEIGHT FULLY UNPACKAGED	CABINET WEIGHT SHIPPING WEIGHT
XG64212*	FLEXFUSION™ CABINET 600mm X 42RU X 1070mm DEEP W/SIDE PANELS	125 Kg/EACH 276 LBS/EACH	145 Kg/EACH 320 LBS/EACH
XG64219*	FLEXFUSION™ CABINET 600mm X 42RU X 1070mm DEEP W/O SIDE PANELS	89 Kg/EACH 196 LBS/EACH	109 Kg/EACH 240 LBS/EACH
XG64512*	FLEXFUSION™ CABINET 600mm X 45RU X 1070mm DEEP W/SIDE PANELS	132 Kg/EACH 292 LBS/EACH	152 Kg/EACH 336 LBS/EACH
XG64519*	FLEXFUSION™ CABINET 600mm X 45RU X 1070mm DEEP W/O SIDE PANELS	93 Kg/EACH 206 LBS/EACH	113 Kg/EACH 250 LBS/EACH
XG64812*	FLEXFUSION™ CABINET 600mm X 48RU X 1070mm DEEP W/SIDE PANELS	138 Kg/EACH 304 LBS/EACH	158 Kg/EACH 348 LBS/EACH
XG64819*	FLEXFUSION™ CABINET 600mm X 48RU X 1070mm DEEP W/O SIDE PANELS	96 Kg/EACH 213 LBS/EACH	116 Kg/EACH 257 LBS/EACH
XG65212*	FLEXFUSION™ CABINET 600mm X 52RU X 1070mm DEEP W/SIDE PANELS	147 Kg/EACH 323 LBS/EACH	167 Kg/EACH 368 LBS/EACH
XG65219*	FLEXFUSION™ CABINET 600mm X 52RU X 1070mm DEEP W/O SIDE PANELS	102 Kg/EACH 224 LBS/EACH	122 Kg/EACH 269 LBS/EACH
XG64222*	FLEXFUSION™ CABINET 600mm X 42RU X 1200mm DEEP W/SIDE PANELS	133 Kg/EACH 292 LBS/EACH	153 Kg/EACH 337 LBS/EACH
XG64229*	FLEXFUSION™ CABINET 600mm X 42RU X 1200mm DEEP W/O SIDE PANELS	91 Kg/EACH 201 LBS/EACH	112 Kg/EACH 246 LBS/EACH
XG64522*	FLEXFUSION™ CABINET 600mm X 45RU X 1200mm DEEP W/SIDE PANELS	142 Kg/EACH 313 LBS/EACH	162 Kg/EACH 358 LBS/EACH
XG64529*	FLEXFUSION™ CABINET 600mm X 45RU X 1200mm DEEP W/O SIDE PANELS	98 Kg/EACH 216 LBS/EACH	118 Kg/EACH 261 LBS/EACH
XG64822*	FLEXFUSION™ CABINET 600mm X 48RU X 1200mm DEEP W/SIDE PANELS	148 Kg/EACH 326 LBS/EACH	168 Kg/EACH 371 LBS/EACH
XG64829*	FLEXFUSION™ CABINET 600mm X 48RU X 1200mm DEEP W/O SIDE PANELS	101 Kg/EACH 223 LBS/EACH	122 Kg/EACH 268 LBS/EACH
XG65222*	FLEXFUSION™ CABINET 600mm X 52RU X 1200mm DEEP W/SIDE PANELS	157 Kg/EACH 346 LBS/EACH	177 Kg/EACH 391 LBS/EACH
XG65229*	FLEXFUSION™ CABINET 600mm X 52RU X 1200mm DEEP W/O SIDE PANELS	106 Kg/EACH 235 LBS/EACH	127 Kg/EACH 280 LBS/EACH

\* DENOTES COLOR  
 "B" = BLACK  
 "W" = WHITE

ABOVE WEIGHTS ARE CABINET THAT INCLUDES SINGLE HINGED FRONT DOOR, SPLIT HINGED REAR DOOR, 1 SET OF PDU BRACKETS AND CASTERS

REV	DATE	BY	CHK	APR	DESCRIPTION	ECN	TITLE	CONTROL DRAWING	MATERIAL	DRAWING NUMBER	SIZE
							FLEXFUSION™ CABINET FAMILY				
							ITEM REVISION NAME	00460NXB/02	<b>PANDUIT</b>	N/A	A
							DATASET FILE NAME	00460NXB_DC/02A			
02A	8/4/22	MEX-JAGC	BRAP	ELE	SEE SHEET 1 FOR REVISIONS	V09002FD/04					
01B	9/13/2021	MES	BRAP	ELE	SEE SHEET ONE OF 12 FOR REVISIONS	V09002FD/03					
01A	7/27/2021	MES	BRAP	ELE	SEE SHEET ONE OF 12 FOR REVISIONS	V09002FD/02					
00A	1/5/2021	LEE	SSP	ELE	DRAWING RELEASE	V09002FD/00				00460NXB-DC	
							THIRD ANGLE PROJECTION				
							DRAWN BY	DATE	CHK	SCALE	
							LEE	1/5/2021	SSP	NONE	
										SHT 10 OF 12	A

D10100DA/20

THIS COPY IS PROVIDED ON A RESTRICTED BASIS AND IS NOT TO BE USED IN ANY WAY DETRIMENTAL TO THE INTERESTS OF PANDUIT CORP.

PART NO.	DESCRIPTION	CABINET WEIGHT FULLY UNPACKAGED	CABINET WEIGHT SHIPPING WEIGHT
XG74212*	FLEXFUSION™ CABINET 700mm X 42RU X 1070mm DEEP W/SIDE PANELS	143 Kg/EACH 315 LBS/EACH	166 Kg/EACH 367 LBS/EACH
XG74219*	FLEXFUSION™ CABINET 700mm X 42RU X 1070mm DEEP W/O SIDE PANELS	106 Kg/EACH 234 LBS/EACH	130 Kg/EACH 286 LBS/EACH
XG74512*	FLEXFUSION™ CABINET 700mm X 45RU X 1070mm DEEP W/SIDE PANELS	151 Kg/EACH 332 LBS/EACH	174 Kg/EACH 384 LBS/EACH
XG74519*	FLEXFUSION™ CABINET 700mm X 45RU X 1070mm DEEP W/O SIDE PANELS	112 Kg/EACH 246 LBS/EACH	135 Kg/EACH 298 LBS/EACH
XG74812*	FLEXFUSION™ CABINET 700mm X 48RU X 1070mm DEEP W/SIDE PANELS	157 Kg/EACH 346 LBS/EACH	181 Kg/EACH 398 LBS/EACH
XG74819*	FLEXFUSION™ CABINET 700mm X 48RU X 1070mm DEEP W/O SIDE PANELS	116 Kg/EACH 255 LBS/EACH	139 Kg/EACH 307 LBS/EACH
XG75212*	FLEXFUSION™ CABINET 700mm X 52RU X 1070mm DEEP W/SIDE PANELS	167 Kg/EACH 368 LBS/EACH	192 Kg/EACH 421 LBS/EACH
XG75219*	FLEXFUSION™ CABINET 700mm X 52RU X 1070mm DEEP W/O SIDE PANELS	122 Kg/EACH 270 LBS/EACH	147 Kg/EACH 323 LBS/EACH
XG74222*	FLEXFUSION™ CABINET 700mm X 42RU X 1200mm DEEP W/SIDE PANELS	153 Kg/EACH 338 LBS/EACH	181 Kg/EACH 399 LBS/EACH
XG74229*	FLEXFUSION™ CABINET 700mm X 42RU X 1200mm DEEP W/O SIDE PANELS	112 Kg/EACH 248 LBS/EACH	140 Kg/EACH 309 LBS/EACH
XG74522*	FLEXFUSION™ CABINET 700mm X 45RU X 1200mm DEEP W/SIDE PANELS	161 Kg/EACH 354 LBS/EACH	188 Kg/EACH 415 LBS/EACH
XG74529*	FLEXFUSION™ CABINET 700mm X 45RU X 1200mm DEEP W/O SIDE PANELS	117 Kg/EACH 257 LBS/EACH	144 Kg/EACH 318 LBS/EACH
XG74822*	FLEXFUSION™ CABINET 700mm X 48RU X 1200mm DEEP W/SIDE PANELS	167 Kg/EACH 369 LBS/EACH	195 Kg/EACH 430 LBS/EACH
XG74829*	FLEXFUSION™ CABINET 700mm X 48RU X 1200mm DEEP W/O SIDE PANELS	121 Kg/EACH 266 LBS/EACH	148 Kg/EACH 327 LBS/EACH
XG75222*	FLEXFUSION™ CABINET 700mm X 52RU X 1200mm DEEP W/SIDE PANELS	177 Kg/EACH 392 LBS/EACH	206 Kg/EACH 453 LBS/EACH
XG75229*	FLEXFUSION™ CABINET 700mm X 52RU X 1200mm DEEP W/O SIDE PANELS	127 Kg/EACH 280 LBS/EACH	156 Kg/EACH 343 LBS/EACH

\* DENOTES COLOR  
 "B" = BLACK  
 "W" = WHITE

ABOVE WEIGHTS ARE CABINET THAT INCLUDES SINGLE HINGED FRONT DOOR, SPLIT HINGED REAR DOOR, 1 SET OF PDU BRACKETS AND CASTERS

REV	DATE	BY	CHK	APR	DESCRIPTION	ECN
02A	8/4/22	MEX-JAGC	BRAP	ELE	SEE SHEET 1 FOR REVISIONS	V09002FD/04
01B	9/13/2021	MES	BRAP	ELE	SEE SHEET ONE OF 12 FOR REVISIONS	V09002FD/03
01A	7/27/2021	MES	BRAP	ELE	SEE SHEET ONE OF 12 FOR REVISIONS	V09002FD/02
00A	1/5/2021	LEE	SSP	ELE	DRAWING RELEASE	V09002FD/00

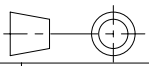
TITLE		<b>FLEXFUSION™ CABINET FAMILY</b>		
		CONTROL DRAWING		
ITEM REVISION NAME		00460NXB/02		
DATASET FILE NAME		00460NXB_DC/02A		
		<b>PANDUIT</b>		
		MATERIAL:  N/A		
		DRAWING NUMBER: 00460NXB-DC		
		THIRD ANGLE PROJECTION		
DRAWN BY	DATE	CHK	SCALE	SIZE
LEE	1/5/2021	SSP	NONE	A

D10100DA/20

THIS COPY IS PROVIDED ON A RESTRICTED BASIS AND IS NOT TO BE USED IN ANY WAY DETRIMENTAL TO THE INTERESTS OF PANDUIT CORP.

PART NO.	DESCRIPTION	CABINET WEIGHT FULLY UNPACKAGED	CABINET WEIGHT SHIPPING WEIGHT
XG84212*	FLEXFUSION™ CABINET 800mm X 42RU X 1070mm DEEP W/SIDE PANELS	153 Kg/EACH 338 LBS/EACH	177 Kg/EACH 390 LBS/EACH
XG84219*	FLEXFUSION™ CABINET 800mm X 42RU X 1070mm DEEP W/O SIDE PANELS	117 Kg/EACH 257 LBS/EACH	140 Kg/EACH 309 LBS/EACH
XG84512*	FLEXFUSION™ CABINET 800mm X 45RU X 1070mm DEEP W/SIDE PANELS	160 Kg/EACH 353 LBS/EACH	184 Kg/EACH 405 LBS/EACH
XG84519*	FLEXFUSION™ CABINET 800mm X 45RU X 1070mm DEEP W/O SIDE PANELS	121 Kg/EACH 267 LBS/EACH	145 Kg/EACH 319 LBS/EACH
XG84812*	FLEXFUSION™ CABINET 800mm X 48RU X 1070mm DEEP W/SIDE PANELS	167 Kg/EACH 369 LBS/EACH	191 Kg/EACH 421 LBS/EACH
XG84819*	FLEXFUSION™ CABINET 800mm X 48RU X 1070mm DEEP W/O SIDE PANELS	126 Kg/EACH 278 LBS/EACH	150 Kg/EACH 330 LBS/EACH
XG85212*	FLEXFUSION™ CABINET 800mm X 52RU X 1070mm DEEP W/SIDE PANELS	178 Kg/EACH 393 LBS/EACH	202 Kg/EACH 446 LBS/EACH
XG85219*	FLEXFUSION™ CABINET 800mm X 52RU X 1070mm DEEP W/O SIDE PANELS	134 Kg/EACH 294 LBS/EACH	157 Kg/EACH 347 LBS/EACH
XG84222*	FLEXFUSION™ CABINET 800mm X 42RU X 1200mm DEEP W/SIDE PANELS	163 Kg/EACH 359 LBS/EACH	190 Kg/EACH 420 LBS/EACH
XG84229*	FLEXFUSION™ CABINET 800mm X 42RU X 1200mm DEEP W/O SIDE PANELS	122 Kg/EACH 268 LBS/EACH	149 Kg/EACH 329 LBS/EACH
XG84522*	FLEXFUSION™ CABINET 800mm X 45RU X 1200mm DEEP W/SIDE PANELS	170 Kg/EACH 375 LBS/EACH	198 Kg/EACH 436 LBS/EACH
XG84529*	FLEXFUSION™ CABINET 800mm X 45RU X 1200mm DEEP W/O SIDE PANELS	126 Kg/EACH 278 LBS/EACH	154 Kg/EACH 339 LBS/EACH
XG84822*	FLEXFUSION™ CABINET 800mm X 48RU X 1200mm DEEP W/SIDE PANELS	178 Kg/EACH 392 LBS/EACH	205 Kg/EACH 453 LBS/EACH
XG84829*	FLEXFUSION™ CABINET 800mm X 48RU X 1200mm DEEP W/O SIDE PANELS	131 Kg/EACH 289 LBS/EACH	159 Kg/EACH 350 LBS/EACH
XG85222*	FLEXFUSION™ CABINET 800mm X 52RU X 1200mm DEEP W/SIDE PANELS	189 Kg/EACH 416 LBS/EACH	217 Kg/EACH 478 LBS/EACH
XG85229*	FLEXFUSION™ CABINET 800mm X 52RU X 1200mm DEEP W/O SIDE PANELS	139 Kg/EACH 305 LBS/EACH	166 Kg/EACH 367 LBS/EACH

\* DENOTES COLOR  
 "B" = BLACK  
 "W" = WHITE

ABOVE WEIGHTS ARE CABINET THAT INCLUDES SINGLE HINGED FRONT DOOR, SPLIT HINGED REAR DOOR, 1 SET OF PDU BRACKETS AND CASTERS

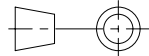
REV	DATE	BY	CHK	APR	DESCRIPTION	ECN	TITLE	DRAWING NUMBER:				
							FLEXFUSION™ CABINET FAMILY	00460NXB-DC				
							CONTROL DRAWING	00460NXB-DC				
							ITEM REVISION NAME	00460NXB/02				
							DATASET FILE NAME	00460NXB_DC/02A				
02A	8/4/22	MEX-JAGC	BRAP	ELE	SEE SHEET 1 FOR REVISIONS	V09002FD/04		MATERIAL:				
01B	9/13/2021	MES	BRAP	ELE	SEE SHEET ONE OF 12 FOR REVISIONS	V09002FD/03		N/A				
01A	7/27/2021	MES	BRAP	ELE	SEE SHEET ONE OF 12 FOR REVISIONS	V09002FD/02		DRAWING NUMBER:				
00A	1/5/2021	LEE	SSP	ELE	DRAWING RELEASE	V09002FD/00		00460NXB-DC				
								THIRD ANGLE PROJECTION				
							DRAWN BY	DATE	CHK	SCALE	SHT 12 OF 12	SIZE
							LEE	1/5/2021	SSP	NONE		A

D110100DA/20