

# EC50/EC55

Enterprise Computer

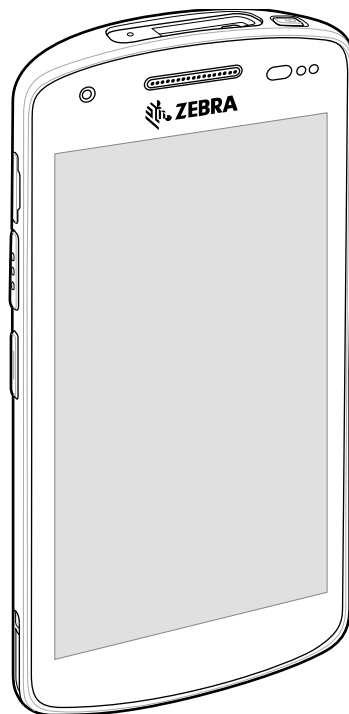

## Product Reference Guide for Android™ 10

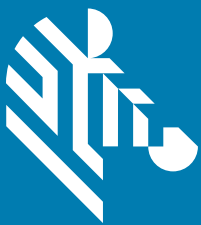

**ZEBRA**

ZEBRA and the stylized Zebra head are trademarks of Zebra Technologies Corporation, registered in many jurisdictions worldwide. Google, Android, Google Play and other marks are trademarks of Google LLC. All other trademarks are the property of their respective owners.  
© 2020 Zebra Technologies Corporation and/or its affiliates. All rights reserved.

For further information regarding legal and proprietary statements, go to:

COPYRIGHTS: [www.zebra.com/copyright](http://www.zebra.com/copyright)

WARRANTY: [www.zebra.com/warranty](http://www.zebra.com/warranty)

END USER LICENSE AGREEMENT: [www.zebra.com/eula](http://www.zebra.com/eula)

## Terms of Use

### Proprietary Statement

This manual contains proprietary information of Zebra Technologies Corporation and its subsidiaries (“Zebra Technologies”). It is intended solely for the information and use of parties operating and maintaining the equipment described herein. Such proprietary information may not be used, reproduced, or disclosed to any other parties for any other purpose without the express, written permission of Zebra Technologies.

### Product Improvements

Continuous improvement of products is a policy of Zebra Technologies. All specifications and designs are subject to change without notice.

### Liability Disclaimer

Zebra Technologies takes steps to ensure that its published Engineering specifications and manuals are correct; however, errors do occur. Zebra Technologies reserves the right to correct any such errors and disclaims liability resulting therefrom.

### Limitation of Liability

In no event shall Zebra Technologies or anyone else involved in the creation, production, or delivery of the accompanying product (including hardware and software) be liable for any damages whatsoever (including, without limitation, consequential damages including loss of business profits, business interruption, or loss of business information) arising out of the use of, the results of use of, or inability to use such product, even if Zebra Technologies has been advised of the possibility of such damages. Some jurisdictions do not allow the exclusion or limitation of incidental or consequential damages, so the above limitation or exclusion may not apply to you.

## Revision History

Changes to the original guide are listed below:

Change	Date	Description
-01 Rev A	9/2020	Initial release.
-02EN Rev A	11/2021	Fix description of GSM Restricted Mode.

# Contents

<b>About This Guide</b> .....	<b>12</b>
Configurations with Extended Battery .....	12
Configurations with Standard Battery.....	14
Notational Conventions .....	16
Icon Conventions .....	17
Service Information .....	17
Determining Software Versions.....	17
Determining the Serial Number.....	18
<b>Getting Started</b> .....	<b>19</b>
Unpacking the Device .....	19
Device Features .....	19
Setting Up the Device .....	22
Installing or Replacing a microSD Card.....	22
Installing or Replacing the SIM Card .....	23
Device Charging.....	24
Charging Indicators .....	25
Charging Temperature .....	25
<b>Using the Device</b> .....	<b>26</b>
Home Screen .....	26
Setting Home Screen Rotation .....	27
Status Bar.....	27
Notification Icons.....	28
Status Icons .....	29
Managing Notifications .....	30
Opening the Quick Access Panel.....	31
Quick Access Panel Icons.....	31
Editing Icons on the Quick Settings Bar .....	32
Battery Management.....	32

Checking Battery Status .....	32
Monitoring Battery Usage .....	33
Low Battery Notification .....	33
Interactive Sensor Technology .....	33
Waking the Device .....	33
USB Communication .....	34
Transferring Files .....	34
Transferring Photos .....	34
Disconnect from the Host Computer .....	35
<b>Settings .....</b>	<b>36</b>
Accessing Settings .....	36
Display Settings .....	36
Setting the Screen Brightness Manually .....	36
Setting the Screen Brightness Automatically .....	36
Setting Night Light .....	36
Setting Screen Rotation .....	37
Setting Screen Timeout .....	37
Lock Screen Display .....	37
Setting Font Size .....	38
Notification LED Brightness Level .....	38
Touch Panel Mode .....	38
Setting the Date and Time .....	39
General Sound Setting .....	39
Sound Options .....	39
Setting Wake-Up Sources .....	40
Remapping a Button .....	40
Remappable Keys .....	41
Keyboards .....	42
Keyboard Configuration .....	42
Enabling Keyboards .....	42
Switching Between Keyboards .....	42
Using the Android and Gboard Keyboards .....	42
Edit Text .....	42
Entering Numbers, Symbols, and Special Characters .....	43
Using the Enterprise Keyboard .....	43
Numeric Tab .....	43
Alpha Tab .....	43
Additional Character Tab .....	43
Scan Tab .....	43
Language Usage .....	43
Changing the Language Setting .....	44

Adding Words to the Dictionary .....	44
Notifications.....	44
Setting App Notifications .....	44
Viewing Notification Settings for All Apps .....	45
Controlling Lock Screen Notifications .....	45
Blink Light.....	45
<b>Applications .....</b>	<b>46</b>
Accessing Apps.....	49
Switching Between Recent Apps.....	49
Battery Manager.....	49
Opening Battery Manager .....	49
Battery Manager Information .....	50
Camera .....	52
Taking Photos.....	52
Recording Videos .....	53
Camera Settings.....	54
DataWedge Demonstration.....	55
Scanner Selection .....	55
PTT Express Voice Client .....	56
PTT Express User Interface .....	56
PTT Audible Indicators .....	57
PTT Notification Icons .....	57
Enabling PTT Communication.....	57
Selecting a Talk Group.....	58
PTT Communication.....	58
RxLogger.....	59
RxLogger Configuration.....	59
Configuration File .....	59
Enabling Logging.....	59
Disabling Logging .....	59
Extracting Log Files .....	59
Backing Up .....	59
RxLogger Utility .....	60
Initiating the Main Chat Head.....	60
Removing the Main Chat Head .....	60
Viewing Logs.....	60
Removing a Sub Chat Head Icon.....	60
Backing Up In Overlay View.....	60
Sound Recorder .....	60

<b>Data Capture .....</b>	<b>62</b>
Imaging .....	62
Digital Camera .....	62
Linear Imager .....	63
Operational Modes .....	63
RS507/RS507x Hands-Free Imager .....	64
RS5100 Ring Scanner .....	64
RS6000 Bluetooth Ring Scanner .....	64
Scanning Considerations .....	65
Scanning with Internal Imager.....	65
Scanning with Internal Camera.....	66
Scanning with RS6000 Bluetooth Ring Scanner.....	67
Scanning with RS5100 Ring Scanner.....	69
Scanning with RS507/RS507X Hands-Free Imager .....	70
Pairing the Bluetooth Ring Scanner.....	72
Pairing Using Near Field Communication.....	72
Pairing in HID Mode Using Near Field Communication .....	73
Pairing Using Simple Serial Interface.....	74
Pairing Using Bluetooth Human Interface Device .....	74
DataWedge .....	75
Enabling DataWedge.....	75
Disabling DataWedge.....	76
Supported Decoders.....	76
<b>Wireless .....</b>	<b>79</b>
Wireless Local Area Networks .....	79
Connecting to a Wi-Fi Network.....	80
Removing a Wi-Fi Network.....	80
WLAN Configuration .....	80
Configuring a Secure Wi-Fi Network .....	80
Manually Adding a Wi-Fi Network .....	81
Configuring for a Proxy Server .....	82
Configuring the Device to Use a Static IP Address .....	83
Wi-Fi Preferences.....	83
Additional Wi-Fi Settings .....	83
Wi-Fi Direct.....	84
Wireless Wide Area Networks.....	85
Sharing the Mobile Data Connection.....	85
Enabling USB Tethering.....	85
Enabling Bluetooth Tethering.....	85
Enabling Wi-Fi Hotspot .....	86

## Contents

Configuring the Wi-Fi Hotspot .....	86
Data Usage.....	86
Setting Data Usage Warning.....	87
Setting Data Limit.....	87
Cellular Network Settings .....	87
Data When Roaming.....	87
Setting Preferred Network Type.....	88
Using Search for MicroCell .....	88
Configuring the Access Point Name .....	88
Locking the SIM Card.....	88
Bluetooth.....	89
Adaptive Frequency Hopping .....	89
Security.....	89
Bluetooth Profiles .....	90
Bluetooth Power States .....	91
Bluetooth Radio Power.....	91
Enabling Bluetooth .....	91
Disabling Bluetooth .....	91
Discovering Bluetooth Device(s) .....	92
Changing the Bluetooth Name .....	92
Connecting to a Bluetooth Device .....	92
Selecting Profiles on the Bluetooth Device.....	92
Unpairing a Bluetooth Device .....	93
Cast.....	93
Near Field Communications.....	93
Reading NFC Cards .....	94
Enterprise NFC Settings.....	94
<b>Calls .....</b>	<b>96</b>
Emergency Calling .....	96
Audio Modes .....	96
Bluetooth Headset.....	96
Wired Headset .....	96
Adjusting Audio Volume .....	97
Making a Call Using the Dialer.....	97
Accessing Dialing Options.....	97
Making a Call Using Contacts .....	97
Using the Dialer .....	98
Using the Contacts App.....	98
Making a Call Using Call History.....	98
Using the Call History List .....	98
Making a Conference Call on GSM.....	98

Making a Call Using a Bluetooth Headset.....	99
Answering Calls .....	99
Call Settings .....	100
<b>Accessories.....</b>	<b>102</b>
Device Charging.....	104
Charging Indicators .....	105
Charging Temperature .....	105
1-Slot Charge Only Cradle.....	106
1-Slot Charge Only Cradle Setup.....	107
Charging with the 1-Slot Charge Only Cradle .....	107
Removing the Insert from the Cup.....	108
1-Slot USB/Ethernet Cradle .....	109
1-Slot USB/Ethernet Cradle Setup.....	111
Ethernet Communication .....	111
Establishing Ethernet Connection .....	111
Ethernet Settings.....	111
Configuring Ethernet Proxy Settings .....	112
Configuring Ethernet Static IP Address.....	112
Charging with the 1-Slot USB/Ethernet Cradle.....	113
Removing the Insert from the Cup.....	113
4-Slot Charge Only Cradle .....	114
4-Slot Charge Only Cradle Setup.....	115
Charging with the 4-Slot Charge Only Cradle .....	115
Removing the Insert from the Cup.....	116
4-Slot Charge Only Locking Cradle.....	117
Setup .....	118
Charging the Device .....	118
Removing the Insert from the Cup.....	119
Manual Release Using a Release Key .....	119
1-Slot Workstation Cradle .....	121
1-Slot Workstation Cradle Features .....	122
Setup .....	124
Ethernet Communication .....	125
Establishing Ethernet Connection .....	125
Ethernet Settings.....	125
Configuring Ethernet Proxy Settings .....	125
Configuring Ethernet Static IP Address.....	126
Scanner Setup.....	126
Bluetooth Device Setup .....	127
Security.....	127
Using the Workstation Cradle .....	127



Changing Monitor Resolution .....	127
Charging the Device .....	127
Removing the Insert from the Cup.....	128
5-Slot Ethernet Cradle.....	129
5-Slot Ethernet Cradle Setup.....	130
Daisy-chaining Ethernet Cradles .....	130
Ethernet Communication .....	131
Ethernet LED Indicators .....	131
Establishing Ethernet Connection .....	131
Ethernet Settings.....	132
Configuring Ethernet Proxy Settings .....	132
Configuring Ethernet Static IP Address.....	132
Charging the Device .....	133
Removing the Insert from the Cup.....	133
Rugged Boot .....	135
Installation .....	135
Hand Strap .....	137
Soft Holster .....	138
Adjusting the Holster .....	138
Tethered Coil.....	139
3.5 mm Audio Adapter .....	141
USB Cable .....	142
USB Communication .....	142
Charging the Device .....	142
Trigger Handle .....	144
Inserting the Device into the Trigger Handle .....	144
Removing the Device from the Trigger Handle .....	145
Vehicle Holder.....	146
Assembling the Mount .....	146
Installing on the Windshield.....	147
Installing the Dash Mount .....	148
Installing the Device .....	148
Removing the Device .....	149
5-Slot Cradle Rack Installation.....	150
Rack Mount Installation.....	154
<b>Application Deployment.....</b>	<b>157</b>
Security .....	157
Secure Certificates.....	157
Installing a Secure Certificate .....	157
Configuring Credential Storage Settings .....	158

Development Tools .....	158
Android Application Development .....	158
Development Workstation .....	158
Enabling Developer Options .....	158
EMDK for Android.....	159
StageNow .....	159
GMS Restricted.....	159
ADB USB Setup .....	159
Enabling USB Debugging.....	159
Application Installation .....	160
Installing Applications Using the USB Connection .....	160
Installing Applications Using the Android Debug Bridge .....	161
Installing Applications Using a microSD Card .....	161
Uninstalling an Application .....	162
Performing a System Update .....	162
Downloading the System Update Package .....	162
Performing a System Update Using microSD Card.....	163
Performing a System Update Using ADB .....	163
Verifying System Update Installation.....	164
Enterprise Reset .....	164
Performing an Enterprise Reset From Device Settings.....	164
Downloading the Enterprise Reset Package .....	164
Performing an Enterprise Reset Using microSD Card .....	164
Performing an Enterprise Reset Using ADB.....	165
Performing a Factory Reset .....	166
Downloading the Factory Reset Package .....	166
Performing a Factory Reset Using microSD Card.....	166
Performing a Factory Reset Using ADB .....	166
Storage.....	167
Random Access Memory .....	168
Viewing Memory.....	168
Internal Storage .....	168
Viewing Internal Storage .....	168
External Storage.....	168
Viewing External Storage.....	168
Formatting a microSD Card .....	168
Formatting a microSD Card as Internal Memory.....	169
Enterprise Folder .....	169
Managing Apps .....	169
App Details .....	169
Managing Downloads.....	170

<b>Maintenance and Troubleshooting</b> .....	<b>171</b>
Maintaining the Device .....	171
Battery Safety Guidelines.....	171
Best Practices for Enterprise Mobile Computing Devices Operating in Hot Environments and Direct Sunlight	172
Cleaning Instructions.....	172
Approved Cleanser Active Ingredients .....	172
Harmful Ingredients .....	173
Device Cleaning Instructions .....	173
Special Cleaning Notes .....	173
Cleaning Materials Required .....	173
Cleaning Frequency .....	174
Cleaning the Device .....	174
Housing .....	174
Display .....	174
Camera and Exit Window.....	174
Cleaning Cradle Connectors .....	174
Troubleshooting .....	175
Resetting the Device .....	175
Performing a Soft Reset.....	175
Performing a Hard Reset .....	175
Troubleshooting the Device.....	175
1-Slot Charge Only Cradle .....	178
1-Slot USB/Ethernet Cradle.....	178
4-Slot Charge Only Cradle .....	179
4-Slot Locking Charge Only Cradle .....	180
1-Slot Workstation Cradle.....	180
<b>Technical Specifications</b> .....	<b>181</b>
Decode Distances .....	181
1-Slot Charge Only Cradle Technical Specifications.....	182
1-Slot USB/Ethernet Cradle Technical Specifications .....	183
1-Slot Workstation Cradle Technical Specifications .....	183
4-Slot Charge Only Cradle .....	184
4-Slot Charge Only Locking Cradle .....	184
5-Slot Ethernet Cradle Technical Specifications .....	185
Trigger Handle Technical Specifications .....	185
USB-C Audio Adapter Technical Specifications .....	186
Vehicle Cradle Technical Specifications.....	186
<b>Index</b> .....	<b>187</b>

# About This Guide

This guide provides information about setting up and using EC50/EC55 touch computers with the Android™ 10 operating system. Some screens shown in this guide may differ from the actual screens shown on the device.

## Configurations with Extended Battery

The following tables cover all extended battery configurations of the device.

**Table 1** Extended Battery WLAN Configurations

Part Number	Radios	Memory	Data Capture Options	Camera	Back Connector	Operating System
EC500K-01B132 -NA	WLAN: 802.11 <i>a/b/g/n/ac/d/h/i/r/k/v<sup>3</sup>/w</i> WPAN: Bluetooth v5.0 Low Energy	3 GB RAM/32 GB Flash	2D imager (SE4100) and integrated NFC	13 MP rear/no front camera	2-PIN	Google™ Mobile Services (GMS) 10.
EC500K-01B242 -NA	WLAN: 802.11 <i>a/b/g/n/ac/d/h/i/r/k/v<sup>3</sup>/w</i> WPAN: Bluetooth v5.0 Low Energy	4 GB RAM/64 GB Flash	2D imager (SE4100) and integrated NFC	13 MP rear/5 MP front	2-PIN	Google™ Mobile Services (GMS) 10.
EC500K-01B243 -NA	WLAN: 802.11 <i>a/b/g/n/ac/d/h/i/r/k/v<sup>3</sup>/w</i> WPAN: Bluetooth v5.0 Low Energy	4 GB RAM/64 GB Flash	2D image (SE4100) and integrated NFC	13 MP rear/5 MP front	8-PIN	Google™ Mobile Services (GMS) 10.
EC500K-01D141 -NA	WLAN: 802.11 <i>a/b/g/n/ac/d/h/i/r/k/v<sup>3</sup>/w</i> WPAN: Bluetooth v5.0 Low Energy	3 GB RAM/32 GB Flash	No Scanner	13 MP rear/5 MP front	No I/O Connector	Google™ Mobile Services (GMS) 10.
EC500K-01B132 -A6 ROW - Excludes China	WLAN: 802.11 <i>a/b/g/n/ac/d/h/i/r/k/v<sup>3</sup>/w</i> WPAN: Bluetooth v5.0 Low Energy	3 GB RAM/32 GB Flash	2D imager (SE4100) and integrated NFC	13 MP rear/no front camera	2-PIN	Google™ Mobile Services (GMS) 10.

<sup>3</sup>Available in Q4 2020

## About This Guide

**Table 1** Extended Battery WLAN Configurations (Continued)

Part Number	Radios	Memory	Data Capture Options	Camera	Back Connector	Operating System
EC500K-01B242-A6 ROW - Excludes China	WLAN: 802.11 <i>a/b/g/n/ac/d/h/i/r/k/v<sup>3</sup>/w</i> WPAN: Bluetooth v5.0 Low Energy	4 GB RAM/64 GB Flash	2D imager (SE4100) and integrated NFC	13 MP rear/5 MP front	2-PIN	Google™ Mobile Services (GMS) 10.
EC500K-01B243-A6 ROW - Excludes China	WLAN: 802.11 <i>a/b/g/n/ac/d/h/i/r/k/v<sup>3</sup>/w</i> WPAN: Bluetooth v5.0 Low Energy	4 GB RAM/64 GB Flash	2D imager (SE4100) and integrated NFC	13 MP rear/5 MP front	8-PIN	Google™ Mobile Services (GMS) 10.
EC500K-01D141-A6 ROW - Excludes China	WLAN: 802.11 <i>a/b/g/n/ac/d/h/i/r/k/v<sup>3</sup>/w</i> WPAN: Bluetooth v5.0 Low Energy	3 GB RAM/32 GB Flash	No Scanner	13 MP rear/5 MP front	No I/O Connector	Google™ Mobile Services (GMS) 10.
<sup>3</sup> Available in Q4 2020						

**Table 2** Extended Battery WWAN Configurations

Part Number	Radios	Memory	Data Capture Options	Camera	Back Connector	Operating System
EC55AK-21D141-NA*	WLAN: 802.11 <i>a/b/g/n/ac/d/h/i/r/k/v<sup>3</sup>/w</i> WPAN: Bluetooth v5.0 Low Energy e-SIM	3 GB RAM/32 GB Flash	No Scanner	13 MP rear/5 MP front	No I/O Connector	Google™ Mobile Services (GMS) 10.
EC55AK-11B132-NA*	WLAN: 802.11 <i>a/b/g/n/ac/d/h/i/r/k/v<sup>3</sup>/w</i> WPAN: Bluetooth v5.0 Low Energy	3 GB RAM/32 GB Flash	2D imager (SE4100) and integrated NFC	13 MP rear/no front camera	2-PIN	Google™ Mobile Services (GMS) 10.
EC55AK-21B242-NA*	WLAN: 802.11 <i>a/b/g/n/ac/d/h/i/r/k/v<sup>3</sup>/w</i> WPAN: Bluetooth v5.0 Low Energy e-SIM	4 GB RAM/64 GB Flash	2D image (SE4100) and integrated NFC	13 MP rear/5 MP front	2-PIN	Google™ Mobile Services (GMS) 10.
EC55AK-21B243-NA*	WLAN: 802.11 <i>a/b/g/n/ac/d/h/i/r/k/v<sup>3</sup>/w</i> WPAN: Bluetooth v5.0 Low Energy e-SIM	4 GB RAM/64 GB Flash	2D image (SE4100) and integrated NFC	13 MP rear/5 MP front	8-PIN	Google™ Mobile Services (GMS) 10.
<sup>3</sup> Available in Q4 2020 *Available Q1 2021						

## About This Guide

**Table 2** Extended Battery WWAN Configurations (Continued)

Part Number	Radios	Memory	Data Capture Options	Camera	Back Connector	Operating System
EC55BK-21D141 -A6 ROW - Excludes China	WLAN: 802.11 <i>a/b/g/n/ac/d/h/i/r/k/v<sup>3</sup>/w</i> WPAN: Bluetooth v5.0 Low Energy e-SIM	3 GB RAM/32 GB Flash	No Scanner	13 MP rear/5 MP front	No I/O Connector	Google™ Mobile Services (GMS) 10.
EC55BK-11B132 -A6 ROW - Excludes China	WLAN: 802.11 <i>a/b/g/n/ac/d/h/i/r/k/v<sup>3</sup>/w</i> WPAN: Bluetooth v5.0 Low Energy	3 GB RAM/32 GB Flash	2D imager (SE4100) and integrated NFC	13 MP rear/no front camera	2-PIN	Google™ Mobile Services (GMS) 10.
EC55BK-21B242 -A6 ROW - Excludes China	WLAN: 802.11 <i>a/b/g/n/ac/d/h/i/r/k/v<sup>3</sup>/w</i> WPAN: Bluetooth v5.0 Low Energy e-SIM	4 GB RAM/64 GB Flash	2D imager (SE4710) and integrated NFC	13 MP rear/5 MP front	2-PIN	Google™ Mobile Services (GMS) 10.
EC55BK-21B243 -A6 ROW - Excludes China	WLAN: 802.11 <i>a/b/g/n/ac/d/h/i/r/k/v<sup>3</sup>/w</i> WPAN: Bluetooth v5.0 Low Energy e-SIM	4 GB RAM/64 GB Flash	2D imager (SE4710) and integrated NFC	13 MP rear/5 MP front	8-PIN	Google™ Mobile Services (GMS) 10.

<sup>3</sup>Available in Q4 2020  
\*Available Q1 2021

## Configurations with Standard Battery

The following tables cover all standard battery configurations of the device.

**Table 3** Standard Battery WLAN Configurations

Part Number	Radios	Memory	Data Capture Options	Camera	Back Connector	Operating System
EC500K-01B112 -NA	WLAN: 802.11 <i>a/b/g/n/ac/d/h/i/r/k/v<sup>3</sup>/w</i> WPAN: Bluetooth v5.0 Low Energy	3 GB RAM/32 GB Flash	2D imager (SE4100) and integrated NFC	13 MP rear/no front camera	2-PIN	Google™ Mobile Services (GMS) 10.
EC500K-01B222 -NA	WLAN: 802.11 <i>a/b/g/n/ac/d/h/i/r/k/v<sup>3</sup>/w</i> WPAN: Bluetooth v5.0 Low Energy	4 GB RAM/64 GB Flash	2D imager (SE4100) and integrated NFC	13 MP rear/5 MP front	2-PIN	Google™ Mobile Services (GMS) 10.
EC500K-01B223 -NA	WLAN: 802.11 <i>a/b/g/n/ac/d/h/i/r/k/v<sup>3</sup>/w</i> WPAN: Bluetooth v5.0 Low Energy	4 GB RAM/64 GB Flash	2D image (SE4100) and integrated NFC	13 MP rear/5 MP front	8-PIN	Google™ Mobile Services (GMS) 10.

<sup>3</sup>Available in Q4 2020

## About This Guide

**Table 3** Standard Battery WLAN Configurations (Continued)

Part Number	Radios	Memory	Data Capture Options	Camera	Back Connector	Operating System
EC500K-01D121-NA	WLAN: 802.11 <i>a/b/g/n/ac/d/h/i/r/k/v<sup>3</sup>/w</i> WPAN: Bluetooth v5.0 Low Energy	3 GB RAM/32 GB Flash	No Scanner	13 MP rear/5 MP front	No I/O Connector	Google™ Mobile Services (GMS) 10.
EC500K-01B112-A6	WLAN: 802.11 <i>a/b/g/n/ac/d/h/i/r/k/v<sup>3</sup>/w</i> WPAN: Bluetooth v5.0 Low Energy	3 GB RAM/32 GB Flash	2D imager (SE4100) and integrated NFC	13 MP rear/no front camera	2-PIN	Android Open Source Project (AOSP) 10 (China only).
EC500K-01B222-A6	WLAN: 802.11 <i>a/b/g/n/ac/d/h/i/r/k/v<sup>3</sup>/w</i> WPAN: Bluetooth v5.0 Low Energy	4 GB RAM/64 GB Flash	2D imager (SE4100) and integrated NFC	13 MP rear/5 MP front	2-PIN	Android Open Source Project (AOSP) 10 (China only).
EC500K-01B223-A6	WLAN: 802.11 <i>a/b/g/n/ac/d/h/i/r/k/v<sup>3</sup>/w</i> WPAN: Bluetooth v5.0 Low Energy	4 GB RAM/64 GB Flash	2D imager (SE4710) and integrated NFC	13 MP rear/5 MP front	8-PIN	Android Open Source Project (AOSP) 10 (China only).
EC500K-01D121-A6	WLAN: 802.11 <i>a/b/g/n/ac/d/h/i/r/k/v<sup>3</sup>/w</i> WPAN: Bluetooth v5.0 Low Energy	3 GB RAM/32 GB Flash	No Scanner	13 MP rear/5 MP front	No I/O Connector	Android Open Source Project (AOSP) 10 (China only).

<sup>3</sup>Available in Q4 2020

**Table 4** Standard Battery WWAN Configurations

Part Number	Radios	Memory	Data Capture Options	Camera	Back Connector	Operating System
EC55AK-21D121-NA	WLAN: 802.11 <i>a/b/g/n/ac/d/h/i/r/k/v<sup>3</sup>/w</i> WPAN: Bluetooth v5.0 Low Energy e-SIM	3 GB RAM/32 GB Flash	No Scanner	13 MP rear/5 MP front	No I/O Connector	Google™ Mobile Services (GMS) 10.
EC55AK-11B112-NA	WLAN: 802.11 <i>a/b/g/n/ac/d/h/i/r/k/v<sup>3</sup>/w</i> WPAN: Bluetooth v5.0 Low Energy	3 GB RAM/32 GB Flash	2D imager (SE4100) and integrated NFC	13 MP rear/no front camera	2-PIN	Google™ Mobile Services (GMS) 10.
EC55AK-21B222-NA	WLAN: 802.11 <i>a/b/g/n/ac/d/h/i/r/k/v<sup>3</sup>/w</i> WPAN: Bluetooth v5.0 Low Energy e-SIM	4 GB RAM/64 GB Flash	2D imager (SE4100) and integrated NFC	13 MP rear/5 MP front	2-PIN	Google™ Mobile Services (GMS) 10.

<sup>3</sup>Available in Q4 2020

**Table 4** Standard Battery WWAN Configurations (Continued)

Part Number	Radios	Memory	Data Capture Options	Camera	Back Connector	Operating System
EC55AK-21B223 -NA	WLAN: 802.11 <i>a/b/g/n/ac/d/h/i/r/k/v<sup>3</sup>/w</i> WPAN: Bluetooth v5.0 Low Energy e-SIM	4 GB RAM/64 GB Flash	2D image (SE4100) and integrated NFC	13 MP rear/5 MP front	8-PIN	Google™ Mobile Services (GMS) 10.
EC55BK-21D121 -A6 ROW - Excludes China	WLAN: 802.11 <i>a/b/g/n/ac/d/h/i/r/k/v<sup>3</sup>/w</i> WPAN: Bluetooth v5.0 Low Energy e-SIM	3 GB RAM/32 GB Flash	No Scanner	13 MP rear/5 MP front	No I/O Connector	Google™ Mobile Services (GMS) 10.
EC55BK-11B112 -A6 ROW - Excludes China	WLAN: 802.11 <i>a/b/g/n/ac/d/h/i/r/k/v<sup>3</sup>/w</i> WPAN: Bluetooth v5.0 Low Energy	3 GB RAM/32 GB Flash	2D imager (SE4100) and integrated NFC	13 MP rear/no front camera	2-PIN	Google™ Mobile Services (GMS) 10.
EC55BK-21B222 -A6 ROW - Excludes China	WLAN: 802.11 <i>a/b/g/n/ac/d/h/i/r/k/v<sup>3</sup>/w</i> WPAN: Bluetooth v5.0 Low Energy e-SIM	4 GB RAM/64 GB Flash	2D imager (SE4100) and integrated NFC	13 MP rear/5 MP front	2-PIN	Google™ Mobile Services (GMS) 10.
EC55BK-21B223 -A6 ROW - Excludes China	WLAN: 802.11 <i>a/b/g/n/ac/d/h/i/r/k/v<sup>3</sup>/w</i> WPAN: Bluetooth v5.0 Low Energy	4 GB RAM/64 GB Flash	2D imager (SE4710) and integrated NFC	13 MP rear/5 MP front	8-PIN	Google™ Mobile Services (GMS) 10.

<sup>3</sup>Available in Q4 2020

## Notational Conventions

Notational conventions are used to highlight important information.

- **Bold** text is used to highlight the following:
  - Dialog box, window and screen names
  - Drop-down list and list box names
  - Check box and radio button names
  - Icons on a screen
  - Key names on a keypad
  - Button names on a screen.
- Bullets (•) indicate:
  - Action items
  - Lists of alternatives
  - Lists of required steps that are not necessarily sequential.



- Sequential lists (for example, those that describe step-by-step procedures) appear as numbered lists.

## Icon Conventions

The following icons are used throughout the document. The icons and their associated meanings are described below.



**NOTE:** The text here indicates information that is supplemental for the user to know and that is not required to complete a task.



**IMPORTANT:** The text here indicates information that is important for the user to know.



**CAUTION:** If the precaution is not heeded, the user could receive minor or moderate injury.



**WARNING:** If danger is not avoided, the user CAN be seriously injured or killed.



**DANGER:** If danger is not avoided, the user WILL be seriously injured or killed.

## Service Information

If you have a problem with your equipment, contact Customer Support for your region. Contact information is available at: [zebra.com/support](http://zebra.com/support).

When contacting support, please have the following information available:

- Serial number of the unit (found on manufacturing label)
- Model number or product name (found on manufacturing label)
- Software type and version number
- IMEI number

Customer Support responds to calls by email or telephone within the time limits set forth in support agreements.

If the problem cannot be solved by Customer Support, the user may need to return the equipment for servicing and will be given specific directions. We are not responsible for any damages incurred during shipment if the approved shipping container is not used. Shipping the units improperly can possibly void the warranty. Remove the SIM card and/or microSD card from the device before shipping for service.

If the device was purchased from a business partner, contact that business partner for support.

## Determining Software Versions

Before contacting Customer Support, determine the current software version on your device.

1. Swipe down from the Status bar with two fingers to open the Quick Access panel, and then touch .
2. Touch **Aboutphone**.
3. Scroll to view the following information:
  - **Battery information**

- **SW components**
- **Legal information**
- **Model & hardware**
- **Android version**
  - **Android security patch level**
  - Baseband version
  - **Kernel version**
  - **Build number**

To determine the device IMEI information (WWAN only), touch **About phone > IMEI**.

- **IMEI** - Displays the IMEI number for the device.
- **IMEI SV** - Displays the IMEI SV number for the device.

## Determining the Serial Number

Before contacting Customer Support, determine the serial number of your device.

Touch **About phone > Model & hardware > Serial number**.

# Getting Started

This section provides information to get the device up and running for the first time.

## Unpacking the Device

To unpack the device:

1. Carefully remove all protective material from the device, and save the shipping container for later storage and shipping.
2. Verify that the following items were received:
  - Touch computer
  - Regulatory Guide.
3. Inspect the equipment for damage. If any equipment is missing or damaged, contact the Customer Support center immediately. See [Service Information](#).
4. Before using the device for the first time, remove the protective shipping film that covers the exit window, touch screen, and rear camera.

## Device Features

Figure 1 Front View

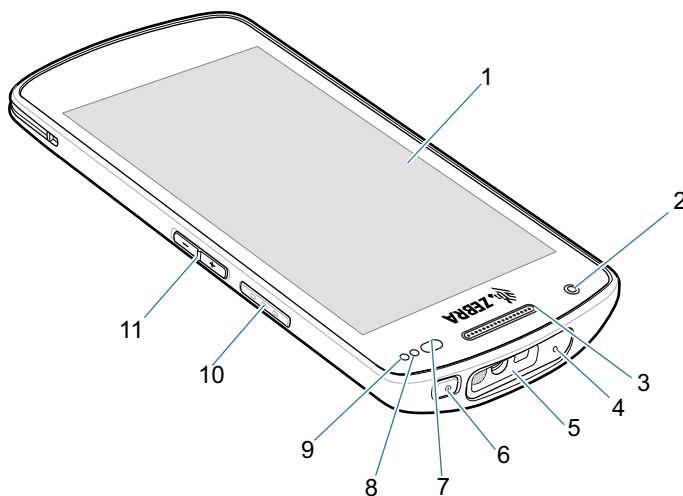

Item	Name	Description
1	Touch screen	Displays all information needed to operate the device.
2	Front camera	Takes photos and videos (available on some models).
3	Receiver	Use for audio playback in Handset mode.
4	Microphone	Use for communications in Speakerphone mode.
5	Exit window	Provides data capture using the imager (available on some models).
6	Power button	Turns the display on and off. Press and hold to reset the device or power off.
7	Proximity/Light sensor	Determines proximity for turning off display when in Handset mode. Determines ambient light for controlling display backlight intensity.
8	Data capture LED	Indicates data capture status.
9	Charging/Notification LED	Indicates battery charging status while charging and application generated notifications.
10	Scan button	Initiates data capture (programmable).
11	Volume Up/Down button	Increases and decreases audio volume (programmable).

**Figure 2** Rear View

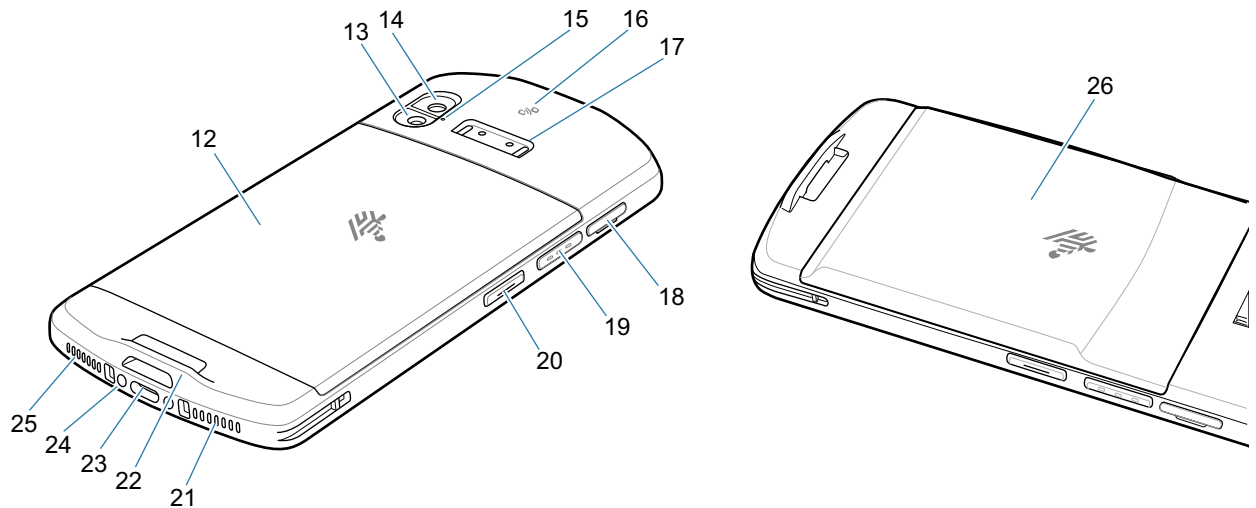

Item	Name	Description
12	Standard battery	Provides standard battery capacity.
13	Camera flash	Provides illumination for the camera.
14	Rear camera	Takes photos and videos.
15	Microphone	Use for noise cancellation.
16	NFC antenna	Provides communication with other NFC-enabled devices.
17	Trigger handle mount	Provides electrical contacts (0, 2, or 8 pins) and mounting for the Trigger Handle.
18	SD/SIM card drawer	Provides access to micro SD card and SIM card.

<sup>1</sup> Pakistan, Qatar

Item	Name	Description
19	Scan button	Initiates data capture (programmable).
20	Programmable Button	Typically used for PTT communications. Where regulatory restrictions exist <sup>1</sup> button is configurable for use with other applications.
21	Microphone	Use for communications in handset mode.
22	Hand strap mount	Provides mounting point for hand strap and tether accessory.
23	USB-C connector	Provides USB host and client communications, and device charging via cables and accessories.
24	Charging connector	Provides device charging via cradles.
25	Speaker	Provides audio output for video and music playback. Provides audio in speakerphone mode.
26	Extended battery	Provides extended battery capacity.
<sup>1</sup> Pakistan, Qatar		

## Setting Up the Device

To start using the device for the first time:

1. Install a micro secure digital (SD) card (optional).
2. Installing a nano SIM card (optional for EC55 only)
3. Charge the device.
4. Power on the device.

## Installing or Replacing a microSD Card

The microSD card slot provides secondary non-volatile storage. For more information, refer to the documentation provided with the card and follow the manufacturer's recommendations for use.



**CAUTION:** Follow proper electrostatic discharge (ESD) precautions to avoid damaging the microSD card. Proper ESD precautions include, but are not limited to, working on an ESD mat and ensuring that the operator is properly grounded.

1. Using your fingernail or a plastic tool, pull out the SD/SIM card drawer.

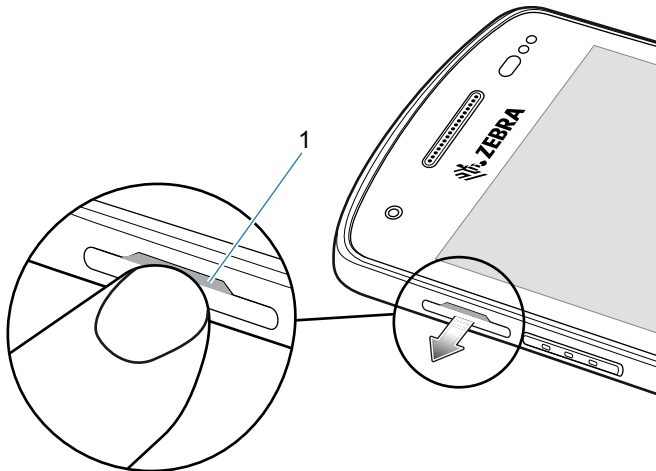

1

Fingernail or plastic tool access to SD/SIM card drawer

2. Remove the SD/SIM card drawer from the device.

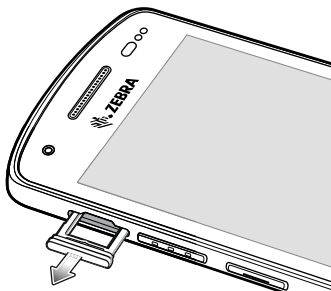

3. Insert or replace the microSD card into the SD/SIM card drawer.

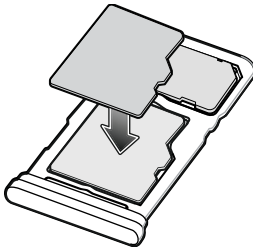

4. Insert the SD/SIM card drawer into the device.

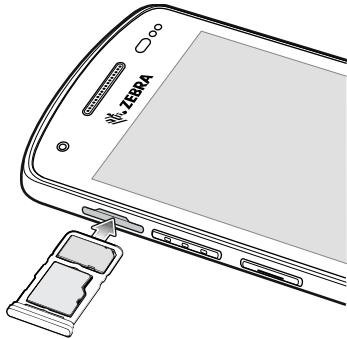

5. Press the SD/SIM card drawer into the device to ensure it is in securely.

## Installing or Replacing the SIM Card



**NOTE:** Only use a nano SIM card. EC55 only.



**CAUTION:** For proper electrostatic discharge (ESD) precautions to avoid damaging the SIM card. Proper ESD precautions include, but not limited to, working on an ESD mat and ensuring that the user is properly grounded.

1. Using your fingernail or a plastic tool, pull out the SD/SIM card drawer.

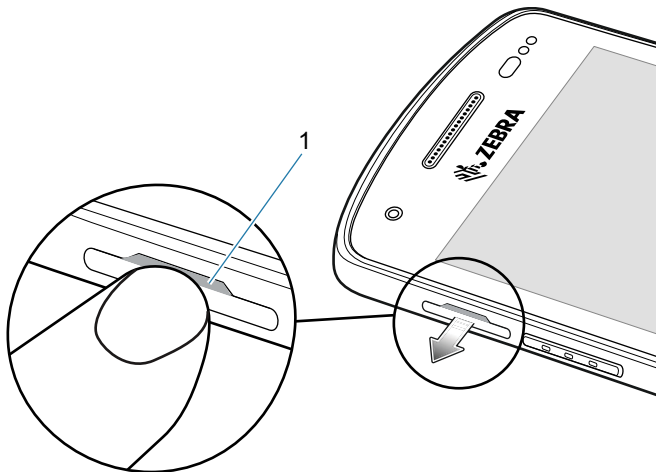

1

Fingernail or plastic tool access to SD/SIM card drawer

2. Remove the SD/SIM card drawer from the device.

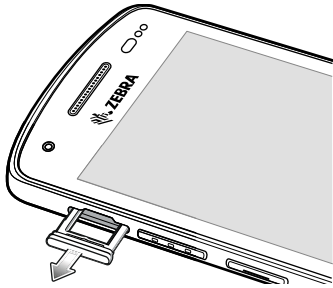

3. Insert the SIM card into the access drawer.

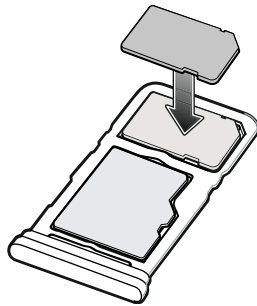

4. Insert the microSD/SIM card access drawer into the device.

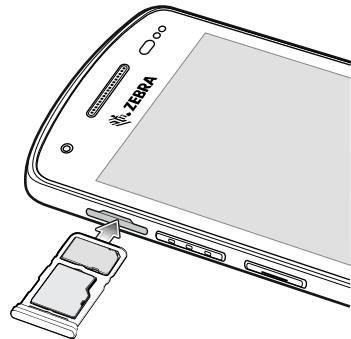

5. Press the SD/SIM card drawer into the device to ensure it is in securely.

## Device Charging

Before using the device for the first time, charge the device until the green Charging/Notification light emitting diode (LED) remains lit. To charge the device use a cable or a cradle with the appropriate power supply.

The device's Charging/Notification LED indicates the status of the device charging. See [Table 1 on page 10](#) for device charging status. When charging the device using a Zebra cradle or power supply, the standard battery charges from fully depleted to 90% in less than two hours. The extended battery charges from fully depleted to 90% in less than three hours.



**NOTE:** In many cases the 90% charge provides plenty of charge for daily use.

To achieve the best fast charging results use only Zebra charging accessories. Charge the device at room temperature.



## Charging Indicators

**Table 5** Charging/Notification LED Charging Indicators

State	Indication
Off	Device is not charging. Device is not inserted correctly in the cradle or connected to a power source. Charger/cradle is not powered.
Slow blinking amber (1 blink every 4 seconds)	Device is charging.
Slow blinking red (1 blink every 4 seconds)	Device is charging but the battery is at end of useful life.
Solid green	Charging complete.
Solid red	Charging complete but the battery is at end of useful life.
Fast blinking amber (2 blinks/second)	Charging error, for example: <ul style="list-style-type: none"> <li>• Temperature is too low or too high.</li> <li>• Charging has gone on too long without completion (typically 8 hours).</li> </ul>
Fast blinking red (2 blinks/second)	Charging error but the battery is at end of useful life., for example: <ul style="list-style-type: none"> <li>• Temperature is too low or too high.</li> <li>• Charging has gone on too long without completion (typically 8 hours).</li> </ul>

## Charging Temperature

Charge batteries in temperatures from 5°C to 40°C (41°F to 104°F). The device or cradle always performs battery charging in a safe and intelligent manner. At higher temperatures (for example: approximately +37°C (+98°F)) the device or cradle may for small periods of time alternately enable and disable battery charging to keep the battery at acceptable temperatures. The device and cradle indicates when charging is disabled due to abnormal temperatures via its LED.

# Using the Device

## Home Screen

Turn on the device to display the Home screen. Depending on how your system administrator configured your device, your Home screen may appear differently than the graphics in this section.

After a suspend or screen time-out, the Home screen displays with the lock slider. Touch the screen and slide up to unlock.

The Home screen provides four additional screens to place widgets and shortcuts. Swipe the screen left or right to view the additional screens.



**NOTE:** By default, AOSP devices do not have the same icons on the Home screen as GMS devices. Icons are shown below for example only.

Home screen icons can be configured by the user and may look different than shown.

**Figure 3** Home Screen

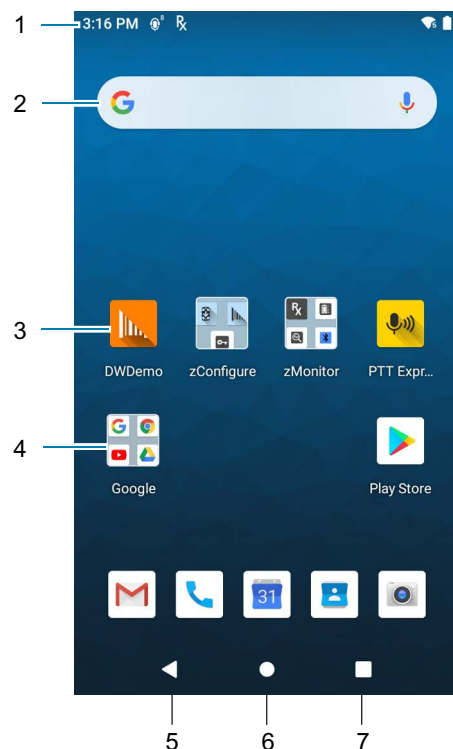

1	Status Bar	Displays the time, status icons (right side), and notification icons (left side). For more information see <a href="#">Notification Icons on page 28</a> and <a href="#">Managing Notifications on page 30</a> .
2	Widgets	Launches stand-alone apps that run on the Home screen.
3	Shortcut Icons	Opens apps installed on the device.
4	Folder	Contains apps.
5	Back	Displays the previous screen.
6	Home	Displays the Home screen.
7	Recent	Displays recently used applications.

## Setting Home Screen Rotation

By default, the Home screen rotation is disabled.

1. Touch and hold anywhere on the Home screen until the options appear.
2. Touch **Home settings**.
3. Touch the **Allow Home screen rotation** switch.
4. Touch the Home button.
5. Rotate the device.

## Status Bar

The Status bar displays the time, notification icons (left side), and status icons (right side).

If there are more notifications than can fit in the Status bar, a dot displays indicating that more notifications exist. Swipe down from the Status bar to open the Notification panel and view all notifications and status.

**Figure 4** Notification and Status Icons

























1	Notification Icons. See <a href="#">Notification Icons on page 28</a> .
2	Status Icons. See <a href="#">Status Icons on page 29</a> .

## Notification Icons

Notification icons indicate app events and messages.























**Table 6** Notification Icons

Icon	Description
	Main battery is low.
	More notifications are available for viewing.
	Data is syncing.
	Indicates an upcoming event. AOSP devices only.
	Indicates an upcoming event. GMS devices only.
	Open Wi-Fi network is available.
	Audio is playing.
	Problem with sign-in or sync has occurred.
	Device is uploading data.
	Animated: the device is downloading data. Static: the download is complete.
	Device is connected to or disconnected from a virtual private network (VPN).
	Preparing internal storage by checking it for errors.
	USB debugging is enabled on the device.
	Call is in progress.
	The mailbox contains one or more voice message.
	Call is on hold.
	Call was missed.
	Wired headset with a boom module is connected to the device.
	Wired headset without a boom module is connected to the device.
	PTT Express Voice client status. See the PTT Express PTT Notification Icons for a complete list.
	Indicates the RxLogger app is running.
	Indicates the Bluetooth scanner is connected to the device.
	Indicates the ring scanner is connected to the device in HID mode.

## Status Icons

Status icons display system information for the device.

**Table 7** Status Icons

Icon	Description
	Alarm is active.
	Main battery is fully charged.
	Main battery is partially drained.
	Main battery charge is low.
	Main battery charge is very low.
	Main battery is charging.
	All sounds, except media and alarms, are muted. Vibrate mode is active.
	Indicates that all sounds except media and alarms are muted.
	Do Not Disturb mode active.
	Airplane Mode is active. All radios are turned off.
	Bluetooth is on.
	The device is connected to a Bluetooth device.
	Connected to a Wi-Fi network. Indicates the Wi-Fi version number.
	Not connected to a Wi-Fi network or no Wi-Fi signal.
	Connected to an Ethernet network.
	Speakerphone enabled.
	Portable Wi-Fi hotspot is active (WWAN only).
	Connected to a 4G LTE/LTE-CA network (WWAN only) <sup>1</sup> .
	Connected to a DC-HSPA, HSDPA, HSPA+, HSUPA, LTE/LTE-CA or WCDMA network (WWAN only) <sup>1</sup> .
	Connected to a 1x-RTT (Sprint), EGDGE, EVDO, EVDV or WCDMA network (WWAN only) <sup>1</sup> .
	Connected to a GPRS network (WWAN only) <sup>1</sup> .
	Connected to a DC - HSPA, HSDPA, HSPA+ or HSUPA network (WWAN only) <sup>1</sup> .

**Table 7** Status Icons (Continued)

Icon	Description
<b>E</b>	Connected to an EDGE network (WWAN only) <sup>1</sup> .
<b>G</b>	Connected to a GPRS network (WWAN only) <sup>1</sup> .
<b>1X</b>	Connected to a 1x-RTT (Verizon) network (WWAN only) <sup>1</sup> .
<b>R</b> ↓↑	Roaming from a network (WWAN only).
	No SIM card installed (WWAN only).

## Managing Notifications

Notification icons report the arrival of new messages, calendar events, alarms, and ongoing events. When a notification occurs, an icon appears in the Status bar with a brief description. See [Notification Icons on page 28](#) for a list of possible notification icons and their description.

- To view a list of all notifications, open the Notification panel by dragging the Status bar down from the top of the screen.

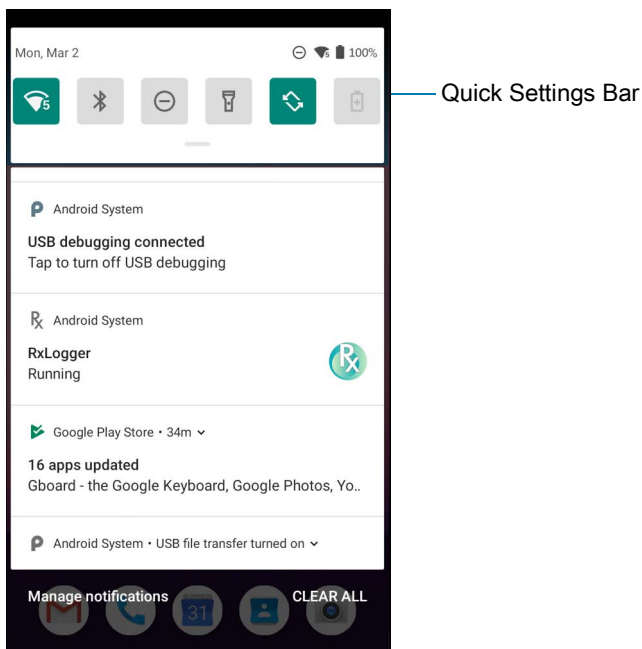

- To respond to a notification, open the Notification panel and then touch a notification. The Notification panel closes and the corresponding app opens.
- To manage recent or frequently used notifications, open the Notification panel and then touch **Manage notifications**. Touch the toggle switch next to an app to turn off all notifications, or touch an app for more notification options.
- To clear all notifications, open the Notification panel and then touch **CLEAR ALL**. All event-based notifications are removed. Ongoing notifications remain in the list.
- To close the Notification panel, swipe the Notification panel up.

## Opening the Quick Access Panel

Use the Quick Access panel to access frequently used settings (for example, Airplane mode). To get to the Quick Access Panel:

- If the device is locked, swipe down once.
- If the device is unlocked, swipe down once with two fingers, or twice with one finger.
- If the Notification panel is open, swipe down from the Quick Settings bar.

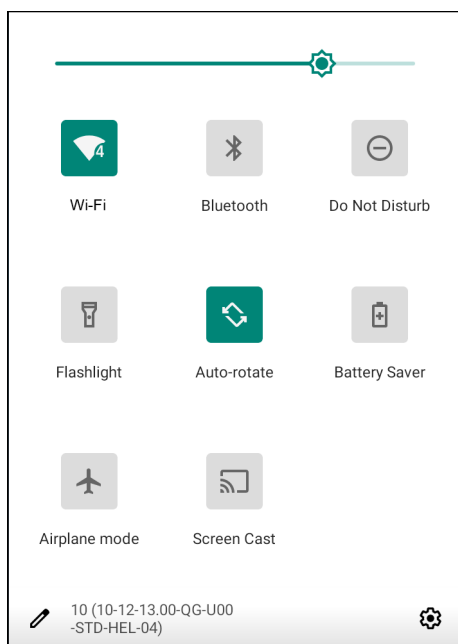

**NOTE:** Not all icons are pictured. Icons may vary.

### Quick Access Panel Icons

- Display brightness - Use the slider to decrease or increase the brightness of the screen.
- Wi-Fi network - Turn Wi-Fi on or off. To open Wi-Fi settings, touch the Wi-Fi network name.
- Bluetooth settings - Turn Bluetooth on or off. To open Bluetooth settings, touch **Bluetooth**.
- Battery saver - Turn Battery saver mode on or off. When Battery saver mode is on the performance of the device is reduced to preserve battery power.
- Invert colors - Invert the display colors.
- Do not disturb - Control how and when to receive notifications.
- Mobile data - Turns cellular radio on or off. To open Mobile data settings, touch and hold (WWAN only).
- Airplane mode - Turn Airplane mode on or off. When Airplane mode is on the device does not connect to Wi-Fi or Bluetooth.
- Auto-rotate - Lock the device's orientation in portrait or landscape mode or set to automatically rotate.
- Flashlight - Turn flashlight on or off. Turn camera flash on or off. On camera only devices without an internal scan engine, the flashlight turns off when an app is opened. This ensures the camera is available for scanning.

- Location - Enable or disable locationing feature.
- Hotspot - Turn on to share the device's mobile data connection with other devices.
- Data Saver - Turn on to prevent some apps from sending or receiving data in the background.
- Night Light - Tint the screen amber to make it easier to look at the screen in dim light. Set Night Light to turn on automatically from sunset to sunrise, or at other times.
- Screen Cast - Share phone content on Chromecast or a television with Google Cast built-in. Touch cast screen to display a list of devices, then touch a device to begin casting.
- Dark Theme - Toggles dark theme on and off. Dark themes reduce the luminance emitted by the screen, while meeting minimum color contrast ratios. It helps improve visual ergonomics by reducing eye strain, adjusting brightness to current lighting conditions, and facilitating screen use in dark environments, while conserving battery power.
- Focus mode - Turn on to pause distracting apps. To open Focus mode settings, touch and hold.
- Bedtime mode - Turn grayscale on and off. Grayscale turns the screen black and white, reducing phone distractions and improving battery life.

### Editing Icons on the Quick Settings Bar

The first several setting tiles from the Quick Access panel become the Quick Settings bar.

Open the Quick Access panel and touch  to edit, add, or remove settings tiles.

## Battery Management

Observe the recommended battery optimization tips for your device.

- Set the screen to turn off after a short period of non-use.
- Reduce screen brightness.
- Turn off all wireless radios when not in use.
- Turn off automatic syncing for Email, Calendar, Contacts, and other apps.
- Minimize use of apps that keep the device from suspending, for example, music and video apps.



**NOTE:** Before checking the battery charge level, remove the device from any AC power source (cradle or cable).

### Checking Battery Status

- Open **Settings** and touch **About phone** > **Battery Information**.

Or, swipe up from the bottom of the screen and touch  to open the **Battery Manager** app. See [Battery Manager on page 49](#).

- **Battery present status** indicates if the battery is present.
- **Battery level** lists the battery charge (as a percentage of fully charged).
- Swipe down with two fingers from the status bar to open the quick access panel.
  - Battery percentage is displayed next to the battery icon.



## Monitoring Battery Usage

The **Battery** screen provides battery charge details and power management options to extend battery life.

1. Go to **Settings**.
2. Touch **Battery**.

Display battery information and power management options for a specific app.

1. Go to **Settings**.
2. Touch **Apps & notifications**.
3. Touch an app.
4. Touch **Advanced > Battery**.

Different apps display different information. Some apps include buttons that open screens with settings to adjust power use. Use the **DISABLE** or **FORCE STOP** buttons to turn off apps that consume too much power.

## Low Battery Notification

When the battery charge level drops below 18%, the device displays a notice to connect the device to power. The user should charge the battery using one of the charging accessories.

When the battery charge drops below 10%, the device displays a notice to connect the device to power. The user must charge the battery using one of the charging accessories.

When the battery charge drops below 4%, the device turns off. The user must charge the battery using one of the charging accessories.

## Interactive Sensor Technology

The device contains sensors that monitor movement, orientation and ambient light.

- Gyroscope - Measures angular rotational velocity to detect rotation of the device.
- Accelerometer - Measures the linear acceleration of movement to detect the orientation of the device.
- Digital Compass - The digital compass or magnetometer provides simple orientation in relation to the Earth's magnetic field. As a result, the device always knows which way is North so it can auto rotate digital maps depending on the physical orientation of the device.
- Light Sensor - Detects ambient light and adjusts the screen brightness.
- Proximity Sensor - Detects the presence of nearby objects without physical contact. The sensor detects when the device close to your face during a call and turns off the screen, preventing unintentional screen touches.

In order to take advantage of these sensors, applications use API commands. Refer to the Google Android Sensor APIs for more information. For information on the Zebra Android EMDK, go to: [techdocs.zebra.com](http://techdocs.zebra.com).

## Waking the Device

The device goes into Suspend mode when you press the Power button or after a period of inactivity (set in the Display settings window).

1. To wake the device from Suspend mode, press the Power button.  
The Lock screen displays.
2. Swipe the screen up to unlock.
  - If the Pattern screen unlock feature is enabled, the Pattern screen appears instead of the Lock screen.
  - If the PIN or Password screen unlock feature is enabled, enter the PIN or password after unlocking the screen.



**NOTE:** If you enter the PIN, password, or pattern incorrectly five times, you must wait 30 seconds before trying again.

If you forget the PIN, password, or pattern contact your system administrator.

## USB Communication

Connect the device to a host computer to transfer files between the device and the host computer.

When connecting the device to a host computer, follow the host computer's instructions for connecting and disconnecting USB devices, to avoid damaging or corrupting files. For information on USB communication accessories available for this device, see [Accessories](#).

## Transferring Files

Use Transfer files to copy files between the device and the host computer.

1. Connect the device to a host computer using a USB accessory.
2. On the device, pull down the Notification panel and touch **Charging this device via USB**.  
By default, **No data transfer** is selected.
3. Touch **File Transfer**.



**NOTE:** After changing the setting to **File Transfer**, and then disconnect the USB cable, the setting reverts back to **No data transfer**. If the USB cable is reconnected, select **File Transfer** again.

4. On the host computer, open a file explorer application.
5. Locate the **device** as a portable device.
6. Open the SD card or the Internal storage folder.
7. Copy files to and from the device or delete files as required.

## Transferring Photos

Use **PTP** to copy photos from the device to the host computer.

1. Connect the device to a host computer using a USB accessory.
2. On the device, pull down the Notification panel and touch **Charging this device via USB**.
3. Touch **PTP**.
4. On the host computer, open a file explorer application.
5. Open the SD card or the Internal storage folder.
6. Copy or delete photos as required.

## Disconnect from the Host Computer



**CAUTION:** Carefully follow the host computer's instructions to unmount the microSD card and disconnect USB devices correctly to avoid losing information.



To disconnect the device from the host computer:

1. On the host computer, unmount the device.
2. Remove the device from the USB accessory.

# Settings

## Accessing Settings

There are multiple ways to access settings on a device.

- Swipe down with two fingers from the top of the Home screen to open the Quick Access panel and touch .
- Double-swipe down from the top of the Home screen to open the Quick Access panel and touch .
- Swipe up from the bottom of the Home screen to open APPS and touch  **Settings**.

## Display Settings

Use Display settings to change the screen brightness, enable night light, change the background image, enable screen rotation, set sleep time, and change font size.

### Setting the Screen Brightness Manually

Manually set the screen brightness using the touchscreen.

1. Swipe down with two fingers from the Status bar to open the Quick Access panel.
2. Slide the icon to adjust the screen brightness level.

### Setting the Screen Brightness Automatically

Automatically adjust the screen brightness using the built-in light sensor.

1. Go to **Settings**.
2. Touch **Display**.
3. If disabled, touch **Adaptive brightness** to automatically adjust the brightness.  
By default, **Adaptive brightness** is enabled. Toggle the switch to disable.
4. Touch the Home button.

### Setting Night Light

The Night Light setting tints the screen amber, making the screen easier to look at in low light.

1. Go to **Settings**.
2. Touch **Display**.

3. Touch **Night Light**.
4. Touch **Schedule**.
5. Select one of the schedule values:
  - None (default)
  - Turns on at custom time
  - Turns on from sunset to sunrise.
6. By default, **Night Light** is disabled. Touch **TURN ON NOW** to enable.
7. Adjust the tint using the **Intensity** slider.
8. Touch the Home button.

## Setting Screen Rotation

By default, screen rotation is enabled.

1. Go to **Settings**.
2. Touch **Display > Advanced**.
3. Touch **Auto-rotate screen**.



**NOTE:** To change the Home screen rotation, see [Setting Home Screen Rotation on page 27](#).

4. Touch the Home button.

## Setting Screen Timeout

Set the screen sleep time.

1. Go to **Settings**.
2. Touch **Display > Advanced > Screen timeout**.
3. Select one of the sleep values.
  - **15 seconds**
  - **30 seconds**
  - **1 minute** (default)
  - **2 minutes**
  - **5 minutes**
  - **10 minutes**
  - **30 minutes**
4. Touch the Home button.

## Lock Screen Display

The lock screen display setting wakes the screen when notifications are received.

1. Go to **Settings**.
2. Touch **Display > Advanced**.

3. Touch **Lock screen display**.
4. In the **When to show** section, enable or disable an option using the switch.
5. Touch the Home button.

## Setting Font Size

Set the size of the font in system apps.

1. Go to **Settings**.
2. Touch **Display > Advanced**.
3. Touch **Font size**.
4. Select one of the font size values.
  - Small
  - Default
  - Large
  - Largest.
5. Touch the Home button.

## Notification LED Brightness Level

Set the brightness of the Notification LED.

1. Go to **Settings**.
2. Touch **Display > Advanced**.
3. Touch **Notification LED Brightness Level**.
4. Use the slider to set the brightness value (default: 15).
5. Touch the Home button.

## Touch Panel Mode

The device display is able to detect touches using a finger, a conductive-tip stylus, or gloved finger.



**NOTE:** A glove can be made of medical latex, leather, cotton, or wool. For optimal performance use a Zebra certified stylus.

1. Go to **Settings**.
2. Touch **Display > Advanced**.
3. Touch **Touch panel mode**.
4. Select:
  - **Finger Only** to use a finger on the screen.
  - **Finger and Stylus** to use a finger or a stylus on the screen.
  - **Finger and Glove** to use a finger or a gloved finger on the screen.
  - **Finger/Glove** to use a finger or a gloved finger on the screen.
5. Touch the Home button.

## Setting the Date and Time

The date and time is automatically synchronized using an NITZ server when the device is connected to a cellular network. You are only required to set the time zone or set the date and time if the wireless LAN does not support Network Time Protocol (NTP) or when not connected to a cellular network.

1. Go to **Settings**.
2. Touch **System > Date & time**.
3. Touch **Use network-provided time** to disable automatic date and time synchronization.
4. Touch **Use network-provided time zone** to disable automatic time zone synchronization.
5. Touch **Update Interval**.
6. Select the interval time to synchronize your device time from the network.
7. Touch **Date**.
8. In the calendar, set today's date.
9. Touch **OK**.
10. Touch **Time**.
11. Touch the green circle, drag to the current hour and then release.
12. Touch the green circle, drag to the current minute and then release.
13. Touch **AM** or **PM**.
14. Touch **OK**.
15. Touch **Time zone**.
16. Select the current time zone from the list.
17. Touch **Use 24-hour format**.
18. Touch the Home button.



## General Sound Setting

Use the **Sound** settings to configure media and alarm volumes.

1. Go to **Settings**.
2. Touch **Sound**.
3. Touch an option to set sounds.

### Sound Options

- **Zebra volume controls**
  - **Ring volume** - Controls the ringtone volume.
  - **Media volume** - Controls the music, games, and media volume.
  - **Alarm volume** - Controls the alarm clock volume.
  - **Notifications volume** - Controls the notification volume.
  - **In call volume** - Controls the volume during a call.
  - **Scanner volume** - Controls the scanner volume.

- **Volume presets**
  -  - Mutes the ring, notifications, and scanner so that the device does not make sounds or vibrate.
  -  - All sounds except media and alarms are silenced and vibrate mode is active.
  -  - Enables all sounds at the user defined levels.
- **Vibrate for calls** - Switch on or off.
- **Do Not Disturb** - Mutes some or all sounds and vibrations.
- **Shortcut to prevent ringing** - Select how the shortcut method prevents ringing.
- **Phone ringtone** - Select a sound to play when the phone rings.
- **Default notification sound** - Select a sound to play for all system notifications.
- **Default alarm sound** - Select a sound to play for alarms.
- **Other sounds and vibrations**
  - **Dial pad tones** - Play a sound when pressing keys on dial pad (default - disabled).
  - **Screen locking sounds** - Play a sound when locking and unlocking the screen (default – enabled).
  - **Charging sounds and vibration** - Plays a sound and vibrates when power is applied to the device (default - enabled).
  - **Touch sounds** - Play a sound when making screen selections (default – enabled).
  - **Touch vibration** - Vibrate the device when making screen selections (default – enabled).
- **Wireless Emergency alerts** - Touch to configure emergency broadcast settings and notifications.

## Setting Wake-Up Sources

By default the device wakes from suspend mode when the user presses the **Power** button. The device can be configured to wake when the user presses the **PTT** or **Scan** buttons on the left side of the device.

1. Go to **Settings**.
2. Touch **Wake-Up Sources**.
  - **LEFT\_TRIGGER\_2** - PTT button.
  - **REAR\_BUTTON** - Optional Trigger Handle scan button.
  - **RIGHT\_TRIGGER\_1** - Right scan button.
  - **SCAN** - Left scan button.
  - **VOLUMEDOWN**
  - **VOLUMEUP**
3. Touch a checkbox. A check appears in the checkbox.
4. Touch the Home button.

## Remapping a Button

Buttons on the device can be programmed to perform different functions or as shortcuts to installed apps. For a list of key names and descriptions, refer to: [techdocs.zebra.com](http://techdocs.zebra.com).





**NOTE:** It is not recommended to remap the scan button.

1. Go to **Settings**.
2. Touch **Key Programmer**. A list of programmable buttons displays.
3. Select the button to remap.
4. Touch the **BUTTON REMAPPING** tab or the **SHORTCUT** tab that lists the available functions and applications.
5. Touch a function or application shortcut to map to the button.



**NOTE:** If you select an application shortcut, the application icon appears next to the button on the Key Programmer screen.

6. Touch the Home button.

## Remappable Keys

Figure 5 Key Positions

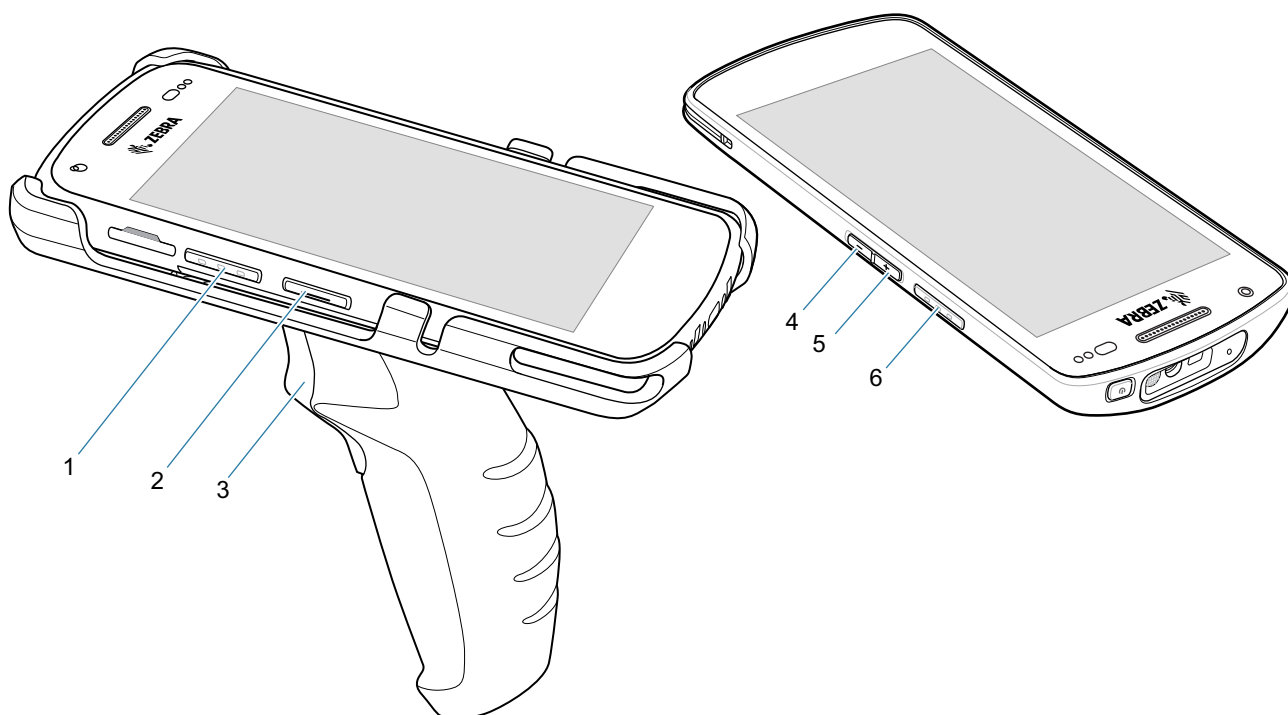

Table 8 Front View Features

Number	Button	Description
1	SCAN	Left scan button.
2	LEFT_TRIGGER_2	Typically used for PTT communications. Where regulatory restrictions exist <sup>1</sup> button is configurable for use with other applications.
3	REAR_BUTTON	Requires Trigger Handle. Programmable trigger button that is available when the Trigger Handle is installed on the device.

<sup>1</sup> Pakistan, Qatar

**Table 8** Front View Features (Continued)

Number	Button	Description
4	VOLUMEDOWN	Volume down button.
5	VOLUMEUP	Volume up button.
6	RIGHT_TRIGGER_1	Right scan button.
<sup>1</sup> Pakistan, Qatar		

## Keyboards

The device provides multiple keyboard options.

- Android Keyboard - AOSP devices only
- Gboard - GMS devices only
- Enterprise Keyboard - Not pre-installed on the device. Contact Zebra Support for more information.





**NOTE:** By default the Enterprise and Virtual Keyboards are disabled.

## Keyboard Configuration

### Enabling Keyboards

1. Go to **Settings**.
2. Touch **System > Languages & input > Virtual keyboard > Manage keyboards**.
3. Touch a keyboard to enable.

### Switching Between Keyboards

- To switch between keyboards, touch in a text box to display the current keyboard.
  - On the Gboard keyboard, touch and hold  (GMS devices only).
  - On the Android keyboard, touch and hold  (AOSP devices only).
  - On the Enterprise keyboard, touch . Only available with Mobility DNA Enterprise License. Not pre-installed on the device. Contact Zebra Support for more information.



**NOTE:** By default the Gboard is enabled. All other virtual keyboards are disabled.

## Using the Android and Gboard Keyboards

Use the Android or Gboard keyboards to enter text in a text field.

To configure the keyboard settings, touch and hold , (comma) and then select **Android keyboard settings**.

### Edit Text

Edit entered text and use menu commands to cut, copy, and paste text within or across apps. Some apps do not support editing some or all of the text they display; others may offer their own way to select text.

## Entering Numbers, Symbols, and Special Characters

1. Enter numbers and symbols.
  - Touch and hold one of the top-row keys until a menu appears then select a number or special character.
  - Touch the Shift key once for a single capital letter. Touch the Shift key twice to lock in uppercase. Touch the Shift key a third time to unlock Capslock.
  - Touch **?123** to switch to the numbers and symbols keyboard.
  - Touch the **=\<** key on the numbers and symbols keyboard to view additional symbols.
2. Enter special characters.
  - Touch and hold a number or symbol key to open a menu of additional symbols. A larger version of the key displays briefly over the keyboard.

## Using the Enterprise Keyboard



**NOTE:** Only available with Mobility DNA Enterprise License.

The Enterprise Keyboard contains multiple keyboard types.

- Numeric
- Alpha
- Special characters
- Data capture.

### Numeric Tab

The numeric keyboard is labeled **123**. The keys displayed vary on the app being used. For example, an arrow displays in **Contacts**, however **Done** displays in **Email** account setup.

### Alpha Tab

The alpha keyboard is labeled using the language code. For English, the alpha keyboard is labeled **EN**.

### Additional Character Tab

The additional characters keyboard is labeled **#\*/**.

Touch 😊 to enter emoji icons in a text message.

Touch **ABC** to return to the Symbols keyboard.

### Scan Tab

The Scan tab provides an easy data capture feature for scanning barcodes.

## Language Usage

Use the **Language & input** settings to change the device's language, including words added to the dictionary.

## Changing the Language Setting

1. Go to **Settings**.
2. Touch **System > Languages & input**.
3. Touch **Languages**. A list of available languages displays.
4. If the desired language is not listed, touch **Add a language** and select a language from the list.
5. Touch and hold  to the right of the desired language, then drag it to the top of the list.
6. The operating system text changes to the selected language.

## Adding Words to the Dictionary

1. Go to **Settings**.
2. Touch **System > Languages & input > Advanced > Personal dictionary**.
3. If prompted, select the language where this word or phrase is stored.
4. Touch **+** to add a new word or phrase to the dictionary.
5. Enter the word or phrase.
6. In the **Shortcut** text box, enter a shortcut for the word or phrase.
7. Touch the Home button.

## Notifications

### Setting App Notifications

To set notification settings for a specific app:

1. Go to **Settings**.
2. Touch **Apps & notifications > SEE ALL XX APPS**. The **App info** screen displays.
3. Select an app.
4. Touch **Notifications**.

Options vary depending on the app selected.

5. Select an available option:

**Show notifications** - Select to turn all notifications from this app on (default) or off.

Touch a notification category to display additional options.

- **Alerting** - Allow notifications from this app to make sound or vibrate the device.
  - **Pop on screen** - Allow notifications from this app to pop notifications on the screen.
- **Silent** - Do not allow notifications from this app to make sound or vibrate.
  - **Minimize** - In the Notification panel, collapse notifications to one line.
- **Advanced** - Touch for additional options.
  - **Sound** - Select a sound to play for notifications from this app.
  - **Vibrate** - Allow notifications from this app to vibrate the device.
  - **Blink light** - Allow notifications from this app the light the Notification LED blue.

- **Show notification dot** - Allow notifications from this app to add a notification dot to the app icon.
- **Override Do Not Disturb** - Allow these notifications to interrupt when Do Not Disturb is enabled.

### Advanced

- **Allow notification dot** - Do not allow this app to add a notification dot to the app icon.
- **Additional settings in the app** - Open the app settings.

## Viewing Notification Settings for All Apps

To view the notification settings for all apps:

1. Go to **Settings**.
2. Touch **Apps & Notifications**.
3. Scroll down to **Notifications** to view how many apps have notifications turned off.
4. To set or view notifications settings for a specific app, see [Setting App Notifications on page 44](#).

## Controlling Lock Screen Notifications

To control whether notifications can be seen when the device is locked:

1. Go to **Settings**.
2. Touch **Apps & notifications > Notifications**.
3. Touch **Notifications on lockscreen** and select one of the following:
  - **Show alerting and silent notifications** (default)
  - **Show alerting notifications only**
  - **Don't show notifications**.

## Blink Light

The Notification LED lights blue when an app, such as email and VoIP, generates a programmable notification or to indicate when the device is connected to a Bluetooth device. By default, LED notifications are enabled.

To change the notification setting:









1. Go to **Settings**.
2. Touch **Apps & notifications > Notifications > Advanced**.
3. Touch **Blink light** to toggle the notification on or off.

# Applications















The **APPS** screen displays icons for all installed apps. See [Application Deployment](#) for information on installing and uninstalling apps. For information on standard Android apps, go to the Google Play [Apps store](#).

The following table describes the apps installed on the device.















**Table 9** Apps

Icon	Description
	<b>Battery Manager</b> - Displays battery information, including charge level, status, health and wear level.
	<b>Bluetooth Pairing Utility</b> – Use to pair a Zebra Bluetooth scanner with the device by scanning a barcode.
	<b>Calculator</b> - Provides the basic and scientific arithmetic functions.
	<b>Calendar</b> - Use to manage events and appointments. GMS/GMS-Restricted only.
	<b>Calendar</b> - Use to manage events and appointments. AOSP only.
	<b>Camera</b> - Take photos or record videos. For more information, see <a href="#">Camera on page 52</a> .
	<b>Chrome</b> - Use to access the Internet or intranet. GMS/GMS-Restricted only.
	<b>Chromium</b> - Use to access the Internet or intranet. AOSP only.
	<b>Clock</b> - Use to schedule alarms for appointments or as a wake-up.

**Table 9** Apps (Continued)





Icon	Description
	<b>Contacts</b> - Use to manage contact information.
	<b>Cradle Demo</b> - Provides a way to demonstrate features of the locking cradle.
	<b>DataWedge</b> - Enables data capture using the imager. For more information, see <a href="#">DataWedge Demonstration on page 55</a> .
	<b>DisplayLink Presenter</b> - Use to present the device screen onto a connected monitor.
	<b>Drive</b> - Upload photos, videos, documents, and other files to personal storage site. GMS/GMS-Restricted only.
	<b>Duo</b> - A one-to-one video calling app. GMS/GMS-Restricted only.
	<b>DWDemo</b> - Provides a way to demonstrate the data capture features using the imager. For more information, see <a href="#">DataWedge Demonstration on page 55</a> .
	<b>Email</b> - Use to send and receive email. AOSP only.
	<b>Files</b> - Organize and manage files on the device.
	<b>Gallery</b> - Use to view photos stored on the microSD card. AOSP only.
	<b>Gmail</b> - Use to send and receive email using a Google email account. GMS/GMS-Restricted only.
	<b>Google</b> - Launches Google™ search app. GMS/GMS-Restricted only.
	<b>Keep Notes</b> - Use to create, edit, and share notes. GMS/GMS-Restricted only.
	<b>License Manager</b> - Use to manage software licenses on the device.

**Table 9** Apps (Continued)

Icon	Description
	<b>Maps</b> - Use to see your location on a map (with public transit, traffic, or satellite overlays). Search for any business or place of interest. Provides turn-by-turn navigation with voice guidance, traffic-avoidance, and alternate routes, for drivers, cyclists, walkers, and users of public transportation. GMS/GMS-Restricted only.
	<b>Messages</b> - Send SMS and MMS messages. WAN devices only. GMS/GMS-Restricted only.
	<b>Messaging</b> - Send SMS and MMS messages. WAN devices only.
	<b>Music</b> - Play music stored on the microSD card. AOSP only.
	<b>Phone</b> - Use to dial a phone number when used with some Voice over IP (VoIP) clients (VoIP telephony ready only). WAN devices only.
	<b>Photos</b> - Use to sync photos with Google account. GMS/GMS-Restricted only.
	<b>Play Movies &amp; TV</b> - View movies and video on your device. GMS/GMS-Restricted only.
	<b>Play Store</b> - Download music, movies, books, and Android apps and games from the Google Play Store. GMS/GMS-Restricted only.
	<b>RxLogger</b> - Use to diagnose device and app issues. For more information, see <a href="#">RxLogger on page 59</a> .
	<b>Search</b> - Use to search the Web. Requires an Internet connection. AOSP only.
	<b>Settings</b> - Use to configure the device.
	<b>Sound Recorder</b> - Use to record audio. For more information, see <a href="#">Sound Recorder on page 60</a> .
	<b>StageNow</b> - Allows the device to stage a device for initial use by initiating the deployment of settings, firmware, and software.
	<b>VoD</b> - The Video on Device basic app provides a how-to video for proper device cleaning. For Video on Device licensing information, go to <a href="http://learning.zebra.com">learning.zebra.com</a> .



**Table 9** Apps (Continued)

Icon	Description
	<b>Worry Free Wifi Analyzer</b> - A diagnostic intelligent app. Use to diagnose surrounding area and display network stats, such as coverage hole detection, or AP in vicinity. Refer to the Worry Free Wi-Fi Analyzer Administrator Guide for Android.
	<b>YouTube</b> - Use to view videos on the YouTube™ web site. GMS/GMS-Restricted only.
	<b>YT Music</b> - Use to listen to music. GMS/GMS-Restricted only.
	<b>Zebra Bluetooth Settings</b> - Use to configure Bluetooth logging.
	<b>Zebra Data Services</b> - Use to enable or disable Zebra Data Services. Some options are set by the system administrator.

## Accessing Apps

All apps installed on the device are accessed using the **APPS** window.

1. On the Home screen, swipe up from the bottom of the screen.
2. Slide the **APPS** window up or down to view more app icons.
3. Touch an icon to open the app.

## Switching Between Recent Apps

Use the Recent button to switch between recently used apps.

1. Touch Recent button.  
A window appears on the screen with icons of recently used apps.
2. Slide the apps displayed up and down to view all recently used apps.
3. Swipe left or right to remove app from the list and force close the app.
4. Touch an icon to open an app or touch Back button to return to the current screen.

## Battery Manager

The **Battery Manager** provides detailed information about the battery.



### Opening Battery Manager

To open the Battery Manager app, swipe up from the bottom of the Home screen, and then touch .

## Battery Manager Information

The Battery Manager displays detailed information about battery charging, health, and status.

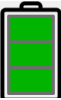
**Table 10** Battery Icon Description

Battery Icon	Description
	Battery charge level is between 85% and 100%.
	Battery charge level is between 19% and 84%.
	Battery charge level is between 0% and 18%.

- **Level** - The current battery charge level as a percentage. Displays -% when level is unknown.
- **Wear** - The health of the battery in graphical form. When the wear level exceeds 80%, the bar color changes to red.
- **Health** - The health of the battery. If a critical error occurs,  appears. Touch to view the error description.
  - **Decommission** - The battery is past its useful life and should be replaced. See system administrator.
  - **Good** - The battery is good.
  - **Charge error** - An error occurred while charging. See system administrator.
  - **Over Current** - An over-current condition occurred. See system administrator.
  - **Dead** - The battery has no charge. Replace the battery.
  - **Over Voltage** - An over-voltage condition occurred. See system administrator.
  - **Below Temperature** - The battery temperature is below the operating temperature. See system administrator.
  - **Failure Detected** - A failure has been detected in the battery. See system administrator.
  - **Unknown** - See system administrator.
- **Charge Status**
  - **Not charging** - The device is not connected to AC power.
  - **Charging-AC** - The device is connected to AC power and charging, or is fast charging via USB.
  - **Charging-USB** - The device is connected to a host computer with a USB cable and charging.
  - **Discharging** - The battery is discharging.
  - **Full** - That the battery is fully charged.
  - **Unknown** - The battery status is unknown.
- **Time until Full** - The amount of time until the battery is fully charged.
- **Time since charging** - The amount of time since the device began charging.

- **Time until empty** - The amount of time until the battery is empty.
- **Advanced info** - Touch to view additional battery information.
  - **Battery present status - Indicates that the battery is present.**
  - **Battery level** - The battery charge level as a percentage of scale.
  - **Battery scale** - The battery scale level used to determine battery level (100).
  - **Battery voltage** - The current battery voltage in millivolts.
  - **Battery temperature** - The current battery temperature in degrees Centigrade.
  - **Battery technology** - The type of battery.
  - **Battery current** - The average current into or out of the battery over the last second in mAh.
  - **Battery manufacture date** - The date of manufacture.
  - **Battery serial number** - The battery serial number. The number matches the serial number printed on the battery label.
  - **Battery part number** - The battery part number.
  - **Battery decommission status** - Indicates if the battery is past its life span.
    - **Battery Good** - The battery is in good health.
    - **Decommissioned Battery** - The battery is past its useful life and should be replaced.
  - **Base cumulative charge** - Cumulative charge using Zebra charging equipment only.
  - **App version** - The application version number.

## Camera



**NOTE:** The device saves photos and videos on the microSD card, if installed and the storage path is changed manually. By default, or if a microSD card is not installed, the device saves photos and videos on the internal storage.



**NOTE:** On camera only devices without an internal scan engine, the back camera is used for barcode scanning.

When the front camera is used by an app, such as for indoor locationing, the back camera becomes disabled and cannot be used for barcode scanning.

This section provides information for taking photos and recording videos using the integrated digital cameras.



## Taking Photos

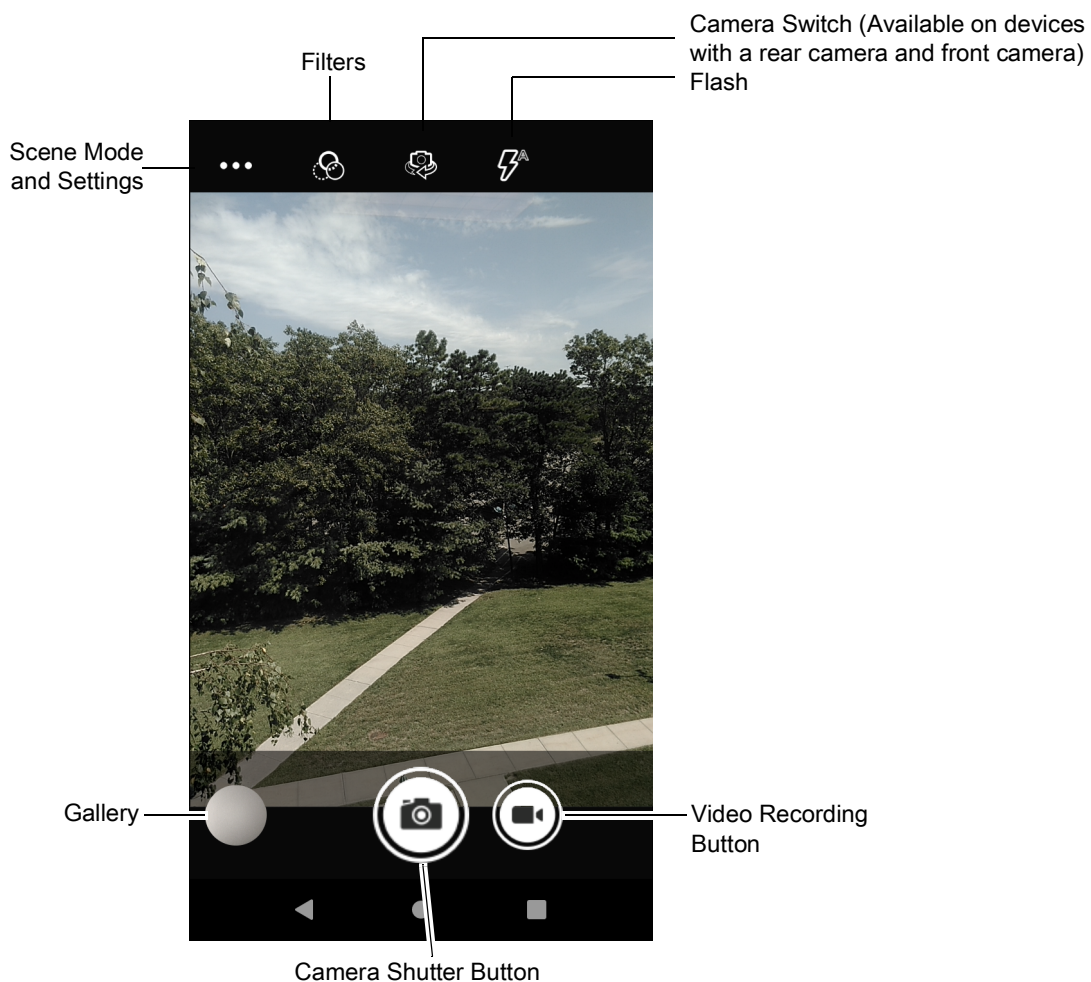

**NOTE:** See [Photo Settings on page 62](#) for camera setting descriptions.

1. Swipe up from the bottom of the Home screen and touch **Camera**.



2. If necessary, touch the Camera Mode icon and touch .
3. To switch between the rear camera and front camera, touch .

4. Frame the subject on the screen.
5. To zoom in or out, press two fingers on the display and pinch or expand fingers. The zoom controls appear on the screen.
6. Touch an area on the screen to focus. The focus circle appears. The two bars turn green when in focus.
7. Touch .
 

The camera takes a photo and a shutter sound plays.

The photo momentarily displays as a thumbnail in the lower left corner.

## Recording Videos

1. Swipe up from the bottom of the Home screen and touch **Camera**.
2. Touch the camera mode menu and touch .

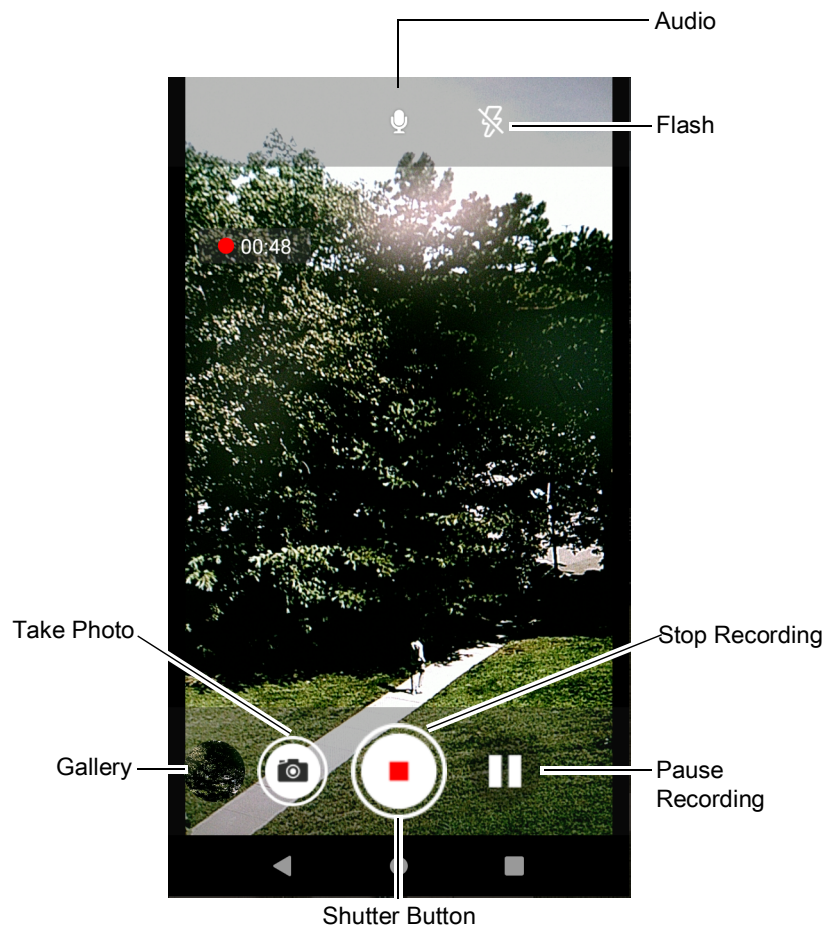

3. Point the camera and frame the scene.
4. To zoom in or out, press two fingers on the display and pinch or expand fingers. The zoom controls appear on the screen.
5. Touch  to start recording.
 

The video time remaining appears in the top left of the screen.
6. Touch  to end the recording.
 

The video momentarily displays as a thumbnail in the lower left corner.

## Camera Settings

In Photo mode, photo settings appear on screen. Touch **☰** > **⚙** to display the photo settings options.

- **General** - These settings apply to both the still camera and video camera.
  - **GPS location** - Turn On or Off (default).
  - **Face Detection** - Select to turn face detection Off (default) or On.
  - **Storage** – Set the location to store the photo to: Phone or SD Card.
- **Still Camera** - These settings apply only to the still camera.
  - **Countdown timer** - Select **Off** (default), **2 seconds**, **5 seconds** or **10 seconds**.
  - **Continuous Shot** - Select to take a series of photos quickly while holding the capture button. Off (default) or On.
  - **Picture size** - The size (in pixels) of the photo to: **13M pixels** (default), **8M pixels**, **5M pixels**, **3M pixels**, **HD1080**, **2M pixels**, **HD720**, **1M pixels**, or **WVGA**.
  - **Picture quality** - Set the picture quality setting to: **Low**, **Standard**, or **High** (default).
  - **Redeye reduction** - Helps eliminate redeye effect. Options: Disabled (default), or Enable.
  - **Exposure** - Set the exposure settings to: **-2**, **-1.5**, **-1**, **-0.5**, **0** (default), **+0.5**, **+1**, **+1.5**, **+2**.
  - **White balance** - Select how the camera adjusts colors in different kinds of light, to achieve the most natural-looking colors:
    - **Incandescent** - Adjust the white balance for incandescent lighting.
    - **Fluorescent** - Adjust the white balance for florescent lighting.
    - **Auto** - Adjust the white balance automatically (default).
    - **Daylight** - Adjust the white balance for daylight.
    - **Cloudy** - Adjust the white balance for a cloudy environment.
  - **Shutter Sound** - Select to play a shutter sound when taking a photo. Options: Disable or Enable (default).
  - **Picture Format** - All still images are saved in JPEG format.
- **Video Camera** - These settings apply only to the video camera.
  - **Video quality** - Set video quality to: **4k UHD**, **HD 1080p** (default), **HD 720p**, **SD 480p**, **VGA**, **CIF**, or **QVGA**.
  - **Video duration** - Set to: **30 seconds (MMS)**, **10 minutes**, **30 minutes** (default), or **no limit**.
  - **Image Stabilization** - Set to reduce blurry videos due to device movement. Options: On or Off (default).
  - **Noise Reduction** - **Off** (default), **Fast**, **High Quality**
  - **Video Encoder** - Set the video encoder to: **MPEG4**, **H264** (default), **H265**.
  - **Audio Encoder** - Set the audio encoder to: **AMRNB**, or **AAC** (default).
  - **Video Rotation** - Set the rotation of the video to: **0** (default), **90**, **180**, or **270**.
  - **Time Lapse** - Set the time lapse interval to: **Off** (default), or a time between **0.5 seconds** and **24 hours**.
- **System**
  - **Restore default** - Select to restore all settings to the default values.

- **Version Info** - Displays the software version of the camera app.









## DataWedge Demonstration

Use **DataWedge Demonstration** to demonstrate data capture functionality. To configure DataWedge, refer to [techdocs.zebra.com/datawedge/](http://techdocs.zebra.com/datawedge/).



**NOTE:** DataWedge is disabled on the Home screen. To enable DataWedge on the Home screen, go to the DataWedge **Launcher** profile and enable Barcode input option.

**Table 11** DataWedge Demonstration Icons

	Icon	Description
Illumination		Imager illumination is on. Touch to turn illumination off.
		Imager illumination is off. Touch to turn illumination on.
Data Capture		The data capture function is through the internal imager.
		A Bluetooth scanner is connected.
		A Bluetooth scanner is not connected.
		The data capture function is through the rear camera.
Scan Mode		Imager is in picklist mode. Touch to change to normal scan mode.
		Imager is in normal scan mode. Touch to change to picklist mode.
Menu		Opens a menu to view the application information or to set the application DataWedge profile.

## Scanner Selection

To select a scanner, touch  > **Settings** > **Scanner selection**.

See the Data Capture section for more information.

Press the programmable button or touch the yellow scan button to capture data. The data appears in the text field below the yellow button.

## PTT Express Voice Client



**NOTE:** Requires a PTT Express License. Not available in all countries.

PTT Express Voice Client enables Push-To-Talk (PTT) communication between disparate enterprise devices. Leveraging existing Wireless Local Area Network (WLAN) infrastructure, PTT Express delivers simple PTT communication without requiring a voice communication server.

- **Group Call:** Press and hold the PTT (Talk) button to start communicating with other voice client users.
- **Private Response:** Double-press the PTT button to respond to the originator of the last broadcast or to make a Private Response.

## PTT Express User Interface

**Figure 6** PTT Express Default User Interface

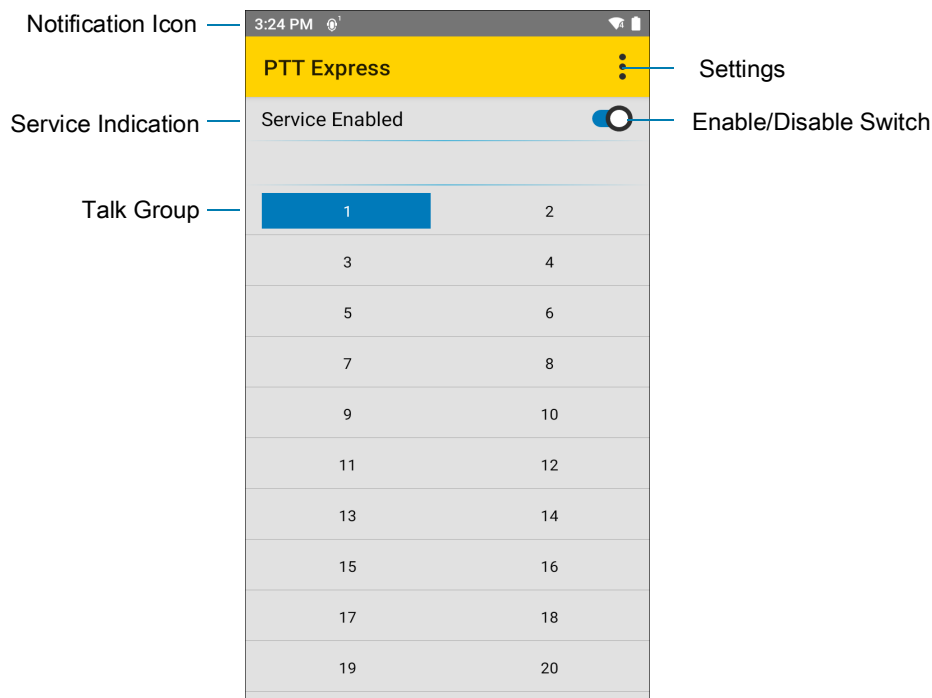

**Table 12** PTT Express Default User Interface Descriptions

Item	Description
Notification Icon	Indicates the current state of the PTT Express client.
Service Indication	Indicates the status of the PTT Express client. Options: <b>Service Enabled</b> , <b>Service Disabled</b> or <b>Service Unavailable</b> .
Talk Groups	Lists all 32 Talk Groups available for PTT communication.
Settings	Opens the PTT Express Settings screen.
Enable/Disable Switch	Turns the PTT service on and off.



## PTT Audible Indicators







The following tones provide helpful cues when using the voice client.

- **Talk Tone:** Double chirp. Plays when the Talk button is depressed. This is a prompt for you to start talking.
- **Access Tone:** Single beep. Plays when another user just finished a broadcast or response. You can now initiate a Group Broadcast or Private Response.
- **Busy Tone:** Continuous tone. Plays when the Talk button is depressed and another user is already communicating on the same talkgroup. Plays after the maximum allowed talk time is reached (60 seconds).
- **Network Tone:**
  - Three increasing pitch beeps. Plays when PTT Express acquires the WLAN connection and the service is enabled.
  - Three decreasing pitch beeps. Plays when PTT Express loses the WLAN connection or the service is disabled.

## PTT Notification Icons

Notification icons indicate the current state of the PTT Express Voice client.

**Table 13** PTT Express Icon Descriptions

Status Icon	Description
	The PTT Express Voice client is disabled.
	The PTT Express Voice client is enabled but not connected to a WLAN.
	The PTT Express Voice client is enabled, connected to a WLAN, and listening on the Talk Group indicated by the number next to the icon.
	The PTT Express Voice client is enabled, connected to a WLAN, and communicating on the Talk Group indicated by the number next to the icon.
	The PTT Express Voice client is enabled, connected to a WLAN, and in a private response.
	The PTT Express Voice client is enabled and muted.
	The PTT Express Voice client is enabled but it is not able to communicate due to a VoIP telephony call in progress.

## Enabling PTT Communication

1. Swipe up from the bottom of the Home screen and touch .
2. Slide the **Enable/Disable Switch** to the **ON** position. The button changes to **ON**.

## Selecting a Talk Group

One of 32 Talk Groups can be selected by PTT Express users. However, only one talk group may be enabled at a time on the device. Touch one of the 32 Talk Groups. The selected Talk Group is highlighted.

## PTT Communication



**NOTE:** This section describes the default PTT Express client configuration. Refer to the PTT Express V1.2 User Guide for detailed information on using the client.

PTT communication may be established as a Group Call. When PTT Express is enabled, the PTT button on the left side of the device is assigned for PTT communication. When the Wired Headset is used, Group Calls can also be initiated using the headset Talk button.



**NOTE:** When using a wired headset, use only Zebra wired headsets with a PTT button.

**Figure 7** PTT Button

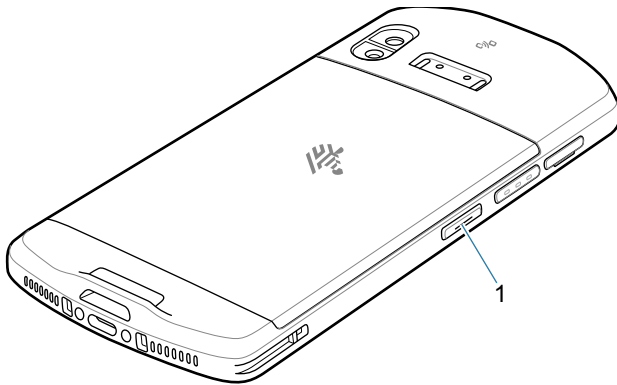

1	PTT button
---	------------

## RxLogger

RxLogger is a comprehensive diagnostic tool that provides application and system metrics, and diagnoses device and application issues. RxLogger logs the following information: CPU load, memory load, memory snapshots, battery consumption, power states, wireless logging, cellular logging, TCP dumps, Bluetooth logging, GPS logging, logcat, FTP push/pull, ANR dumps, etc. All generated logs and files are saved onto flash storage on the device (internal or external).

### RxLogger Configuration

RxLogger is built with an extensible plug-in architecture and comes packaged with a number of plug-ins already built-in. For information on configuring RxLogger, refer to [techdocs.zebra.com/rxlogger/](http://techdocs.zebra.com/rxlogger/).

To open the configuration screen, from the RxLogger home screen touch **Settings**.

### Configuration File

RxLogger configuration can be set using an XML file. The `config.xml` configuration file is located on the microSD card in the `RxLogger\config` folder. Copy the file from the device to a host computer using a USB connection. Edit the configuration file and then replace the XML file on the device. There is no need to stop and restart the RxLogger service since the file change is automatically detected.

### Enabling Logging

To enable logging:

1. Swipe the screen up and select .
2. Touch **Start**.
3. Touch the Home button.

### Disabling Logging

To disable logging:

1. Swipe the screen up and select .
2. Touch **Stop**.
3. Touch the Home button.

### Extracting Log Files

1. Connect the device to a host computer using an USB connection.
2. Using a file explorer, navigate to the `RxLogger` folder.
3. Copy the file from the device to the host computer.
4. Disconnect the device from the host computer.

### Backing Up

RxLogger Utility allows the user to make a zip file of the `RxLogger` folder in the device, which by default contains all the RxLogger logs stored in the device.

To save the backup data, touch  > **BackupNow**.

### RxLogger Utility

RxLogger Utility is a data monitoring application for viewing logs in the device while RxLogger is running. Logs and RxLogger Utility features are accessed using Main Chat Head.

#### Initiating the Main Chat Head

To initiate the Main Chat Head:

1. Open **RxLogger**.
2. Touch  > **Toggle Chat Head**. The Main Chat Head icon appears on the screen.
3. Touch and drag the Main Chat head icon to move it around the screen.

#### Removing the Main Chat Head

To remove the Main Chat Head icon:

1. Touch and drag the icon. A circle with an X appears.
2. Move the icon over the circle and then release.

#### Viewing Logs

To view logs:

1. Touch the Main Chat Head icon. The RxLogger Utility screen appears.
2. Touch a log to open it. The user can open many logs with each displaying a new sub Chat Head.
3. If necessary, scroll left or right to view additional Sub Chat Head icons.
4. Touch a Sub Chat Head to display the log contents.

#### Removing a Sub Chat Head Icon

To remove a sub chat Head icon, press and hold the icon until it disappears.

#### Backing Up In Overlay View

RxLogger Utility allows the user to make a zip file of the **RxLogger** folder in the device, which by default contains all the RxLogger logs stored in the device.

The Backup icon is always available in Overlay View.

1. Touch . The Backup dialog box appears.
2. Touch **Yes** to create the back up.

### Sound Recorder

Use **Sound Recorder** to record audio messages.

Recordings are saved on the microSD card (if installed) or the internal storage, and are available in the Music application (AOSP devices) or the Play Music application (GMS devices).

Touch  to open options menu.

- **File type** - Select the file type for the recording file.
  - **AMR**
  - **3GPP**
  - **AAC**
  - **WAV**
  - **AMR-WB**
  - **AMR-WB-3GPP**.
- **Storage location** - Select the location for the recording file.
  - **Phone storage**
  - **SD card**

# Data Capture

The device supports data capture using:

- Internal linear imager
- Integrated camera
- RS507/RS507x Hands-free imager
- RS5100 Bluetooth Ring Scanner
- RS6000 Bluetooth Ring Scanner

## Imaging

The imager uses imaging technology to take a picture of a barcode, stores the resulting image in its memory, and executes state-of-the-art software decoding algorithms to extract the bar code data from the image. With a 2D imager, the device has the following features:

- Omnidirectional reading of a variety of bar code symbologies, including the most popular linear, postal, PDF417, Digimarc, and 2D matrix code types.
- Advanced intuitive laser aiming cross-hair and dot aiming for easy point-and-shoot operation.

## Digital Camera



**NOTE:** The integrated camera is intended for light-duty barcode scanning. For heavy-duty scanning, 100 or more scans per day, use the 2D imager.

The device with an integrated camera based barcode scanning solution has the following features:

- Omnidirectional reading of a variety of barcode symbologies, including the most popular linear, postal, QR, PDF417, Digimarc, and 2D matrix code types.
- Cross-hair reticle for easy point-and-shoot operation.
- Picklist mode to decode a particular barcode from many in the field of view.

The solution uses the advanced camera technology to take a digital picture of a barcode, and executes state-of-the-art software decoding algorithms to extract the data from the image.

On camera only devices without an internal scan engine, the back camera is used for barcode scanning. When the front camera is used by an app, such as for indoor locationing, the back camera becomes disabled and cannot be used for barcode scanning.

## Linear Imager

The device with an integrated linear imager has the following features:

- Reading a variety of bar code symbologies, including the most popular 1-D code types.
- Intuitive aiming for easy point-and-shoot operation.

The imager uses imaging technology to take a picture of a bar code, stores the resulting image in its memory, and executes state-of-the-art software decoding algorithms to extract the bar code data from the image.

## Operational Modes

The device with an integrated imager supports two modes of operation, listed below. Activate each mode by pressing the Scan button.

- **Decode Mode:** In this mode, the device attempts to locate and decode enabled barcodes within its field of view. The imager remains in this mode as long as the user holds the scan button, or until it decodes a barcode.



**NOTE:** To enable Pick List Mode, configure in DataWedge or set in an application using a API command.

- **Pick List Mode:** This mode allows the user to selectively decode a barcode when more than one barcode is in the device's field of view. To accomplish this, move the aiming crosshair or dot over the required barcode to decode only this barcode. This feature is ideal for pick lists containing multiple barcodes and manufacturing or transport labels containing more than one barcode type (either 1D or 2D).



**NOTE:** To enable Basic MultiBarcode Mode, configure in DataWedge or set in an application using a API command.

- **Basic MultiBarcode Mode:** In this mode, the device attempts to locate and decode a specific number of unique barcodes within its field of view. The device remains in this mode as long as the user holds the scan button, or until it decodes all the barcodes. Available on integrated SE4100 imagers only.
  - The device attempts to scan the programmed number of unique barcodes (from 2 through 10).
  - If there are duplicate barcodes (same symbology type and data), only one of the duplicate barcodes is decoded and the remainder are ignored. If the label has two duplicate barcodes plus another two different barcodes, a maximum of three barcodes will be decoded from that label; one will be ignored as a duplicate.
  - Barcodes can be of multiple symbology types and still be acquired together. For example, if the specified quantity for a Basic MultiBarcode scan is four, two barcodes can be symbology type Code 128 and the other two can be symbology type Code 39.
  - If the specified number of unique barcodes is not initially in view of the device, the device will not decode any data until the device is moved to capture the additional barcode(s) or time out occurs. If the device field of view contains a number of barcodes greater than the specified quantity, the device randomly decodes barcode(s) until the specified number of unique barcodes is reached. For example, if the count is set to two and eight barcodes are in the field of view, the device decodes the first two unique barcodes it sees, returning the data in random order.
  - Basic MultiBarcode Mode does not support concatenated barcodes.

## RS507/RS507x Hands-Free Imager

The RS507 and RS507x Hands-free Imagers are wearable barcode scan solutions for both 1D and 2D bar code symbologies. The scanner supports Bluetooth Human Interface Device (HID) connection to the device.

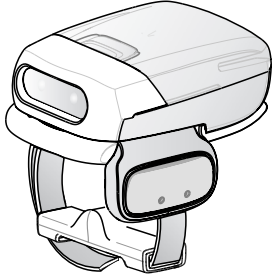

Refer to the RS507/RS507x Hands-free Imager Product Reference Guide for more information.

## RS5100 Ring Scanner

The RS5100 Ring Scanner is a wearable barcode scan solution for both 1D and 2D bar code symbologies. The scanner supports Bluetooth Human Interface Device (HID) connection to the device.

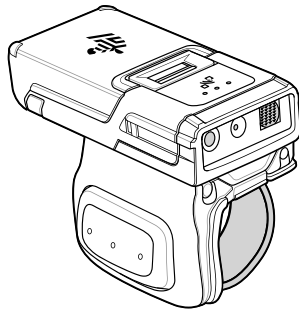

Refer to the RS5100 Ring Scanner Product Reference Guide for more information.

## RS6000 Bluetooth Ring Scanner

The RS6000 Bluetooth Ring Scanner is a wearable bar code scan solution for both 1D and 2D bar code symbologies.

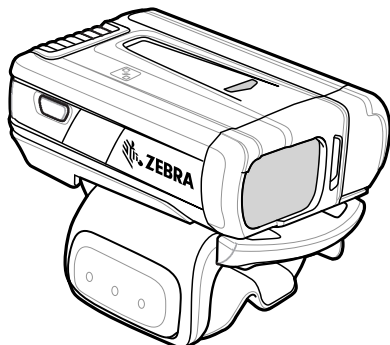

Refer to the RS6000 Bluetooth Ring Scanner Product Reference Guide for more information.



## Scanning Considerations

Typically, scanning is a simple matter of aim, scan, and decode, with a few quick trial efforts to master it. However, consider the following to optimize scanning performance:

- **Range:** Scanners decode best over a particular working range — minimum and maximum distances from the barcode. This range varies according to barcode density and scanning device optics. Scan within range for quick and constant decodes; scanning too close or too far away prevents decodes. Move the scanner closer and further away to find the right working range for the barcodes being scanned.
- **Angle:** Scanning angle is important for quick decodes. When the illumination/flash reflects directly back into the imager, the specular reflection can blind/saturate the imager. To avoid this, scan the barcode so that the beam does not bounce directly back. Do not scan at too sharp an angle; the scanner needs to collect scattered reflections from the scan to make a successful decode. Practice quickly shows what tolerances to work within.
- Hold the device farther away for larger symbols.
- Move the device closer for symbols with bars that are close together.



**NOTE:** Scanning procedures depend on the app and device configuration. An app may use different scanning procedures from the one listed above.

## Scanning with Internal Imager

To read a barcode, a scan-enabled app is required. The device contains the DataWedge app that allows the user to enable the imager, decode the barcode data, and display the barcode content.

To scan with the internal imager:

1. Ensure that an app is open on the device and a text field is in focus (text cursor in text field).
2. Point the exit window on the top of the device at a barcode.

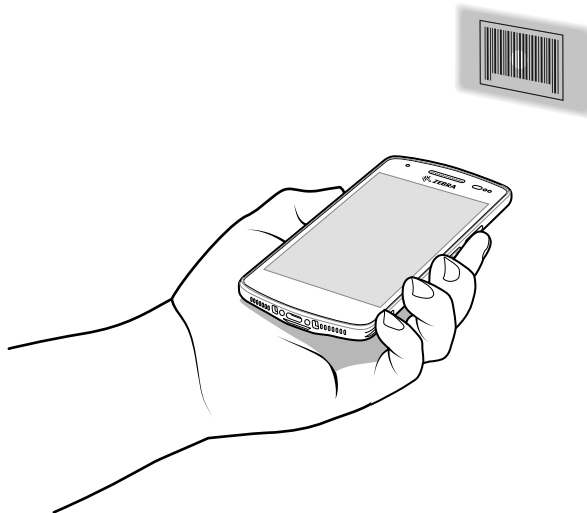

3. Press and hold the scan button.  
The green aiming dot with white illumination turns on to assist in aiming.



**NOTE:** When the device is in Picklist mode, the imager does not decode the barcode until the crosshair or aiming dot touches the barcode.

4. Ensure the barcode is within the area formed by the white illumination. The green aiming dot increases visibility in bright lighting conditions.

**Figure 8** Aiming Pattern

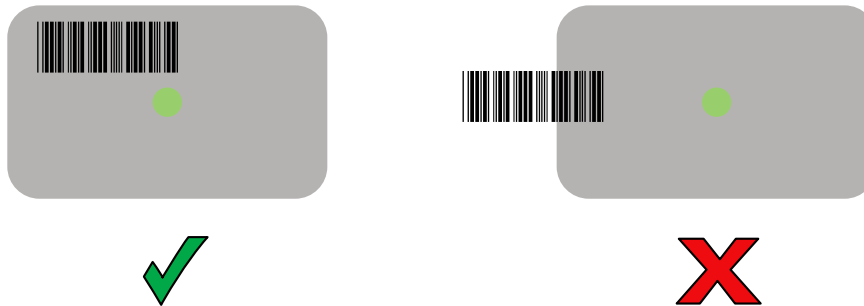

**Figure 9** Pick List Mode with Multiple Barcodes

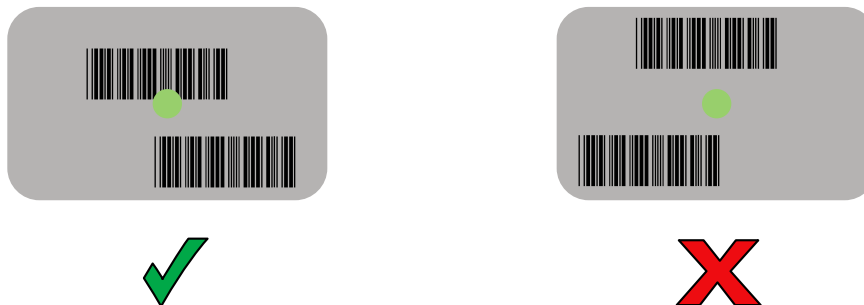

5. The Data Capture LED lights green and a beep sounds, by default, to indicate the barcode was decoded successfully.
6. Release the scan button.



**NOTE:** Imager decoding usually occurs instantaneously. The device repeats the steps required to take a digital picture (image) of a poor or difficult barcode as long as the scan button remains pressed.

7. The barcode content data displays in the text field.

## Scanning with Internal Camera



**NOTE:** The integrated camera is intended for light-duty barcode scanning. For heavy-duty scanning, 100 or more scans per day, use the 2D imager.

To read a barcode, a scan-enabled app is required. The device contains the DataWedge app that allows the user to enable the imager, decode the barcode data, and display the barcode content.

When capturing barcode data in poor lighting, turn on Illumination mode in the DataWedge application.

To scan with the internal camera:

1. Ensure that an app is open on the device and a text field is in focus (text cursor in text field).
2. Point the camera exit window on the back of the device at a barcode.

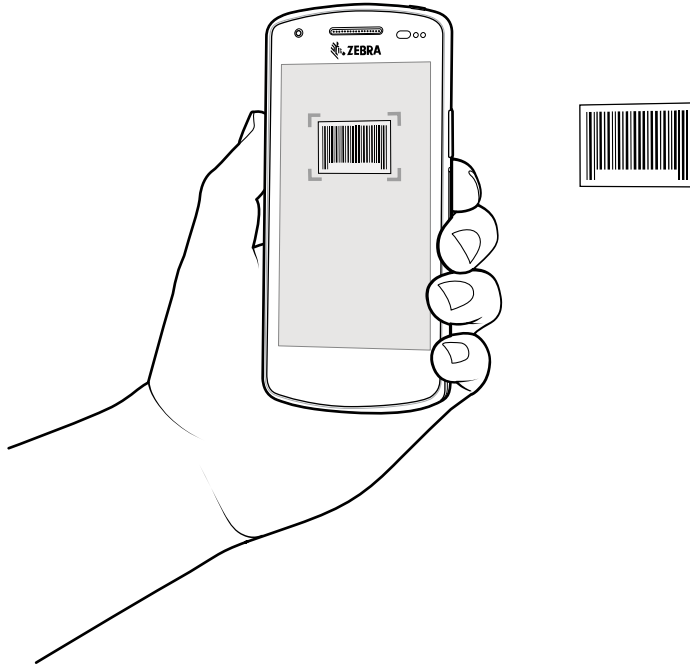

3. Press and hold the scan button. By default, a preview window appears on the screen.
4. If Picklist mode is enabled, move the device until the bar code is centered under the red target on the screen.
5. Move the device until the barcode is visible on the screen.
6. The Decode LED lights green, a beep sounds and the device vibrates, by default, to indicate the bar code was decoded successfully.
7. The captured data appears in the text field.

## Scanning with RS6000 Bluetooth Ring Scanner

To read a barcode, a scan-enabled app is required. Devices that contain the Zebra DataWedge app allows you to enable the scanner to decode barcode data and display the barcode content.

To scan with the RS6000:

1. Pair the RS6000 with the device. See [Pairing Using Bluetooth Human Interface Device](#) for more information.
2. Ensure that an app is open on the device and a text field is in focus (text cursor in text field).

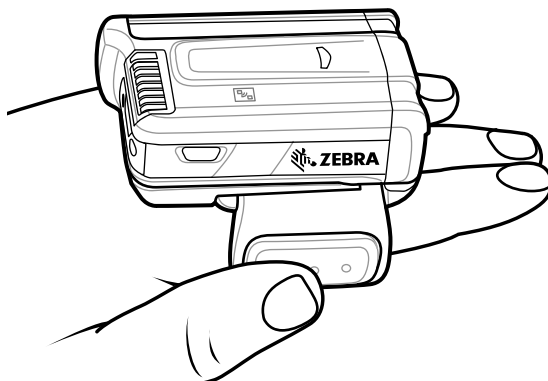

### 3. Press and hold the trigger.

The red laser aiming pattern turns on to assist in aiming. Ensure the barcode is within the area formed by the cross-hairs in the aiming pattern. The aiming dot increases visibility in bright lighting conditions.

The RS6000 LEDs light green and a beep sounds to indicate the barcode was decoded successfully. When the RS6000 is in Pick List mode, the RS6000 does not decode the barcode until the center of the crosshair touches the barcode.

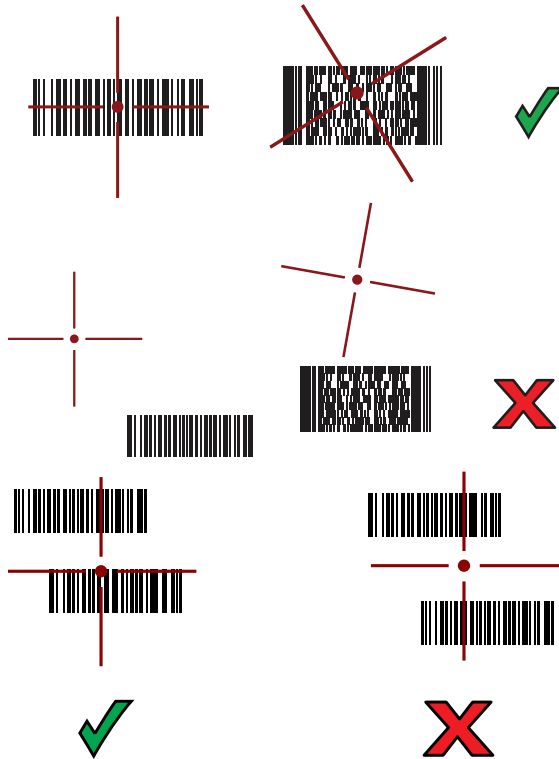

### 4. The captured data appears in the text field.

## Scanning with RS5100 Ring Scanner

To read a barcode, a scan-enabled app is required. The device contains the DataWedge app that allows you to enable the scanner to decode barcode data and display the barcode content.

To scan with the RS5100:

1. Pair the RS5100 with the device. See [Pairing Using Simple Serial Interface](#) or [Pairing Using Bluetooth Human Interface Device](#) for more information.
2. Ensure that an app is open on the device and a text field is in focus (text cursor in text field).
3. Point the RS5100 at a barcode.

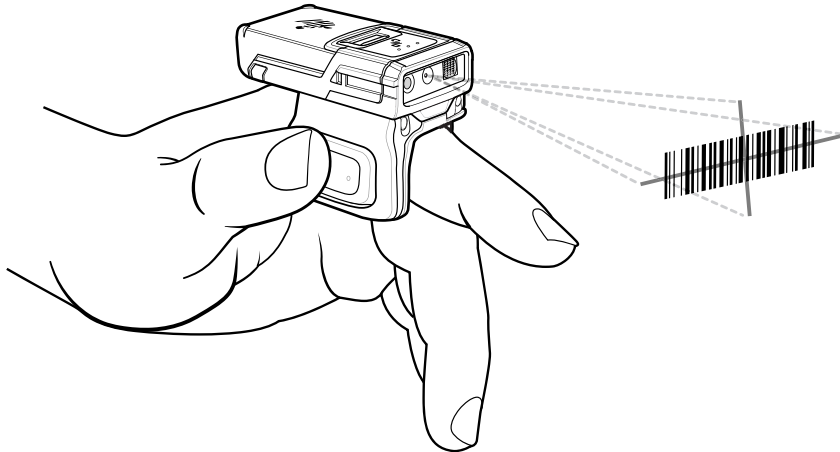

4. Press and hold the trigger.

The red laser aiming pattern turns on to assist in aiming. Ensure the barcode is within the area formed by the cross-hairs in the aiming pattern. The aiming dot increases visibility in bright lighting conditions.

The RS5100 LEDs light green and a beep sounds to indicate the barcode was decoded successfully. When the RS5100 is in Pick List mode, the RS5100 does not decode the barcode until the center of the crosshair touches the barcode.

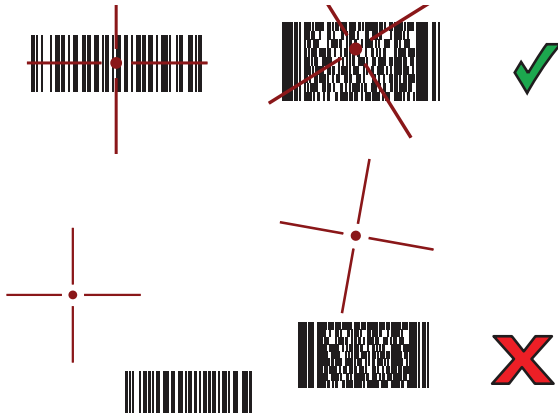



5. The captured data appears in the text field.

## Scanning with RS507/RS507X Hands-Free Imager

To read a barcode, a scan-enabled app is required. The device contains the DataWedge app that allows you to enable the scanner to decode barcode data and display the barcode content.

To scan with the RS507/RS507X:

1. Pair the RS507/RS507X with the device. See [Pairing Using Simple Serial Interface](#) or [Pairing Using Bluetooth Human Interface Device](#) for more information.
2. Ensure that an app is open on the device and a text field is in focus (text cursor in text field).
3. Point the RS507/RS507X at a barcode.

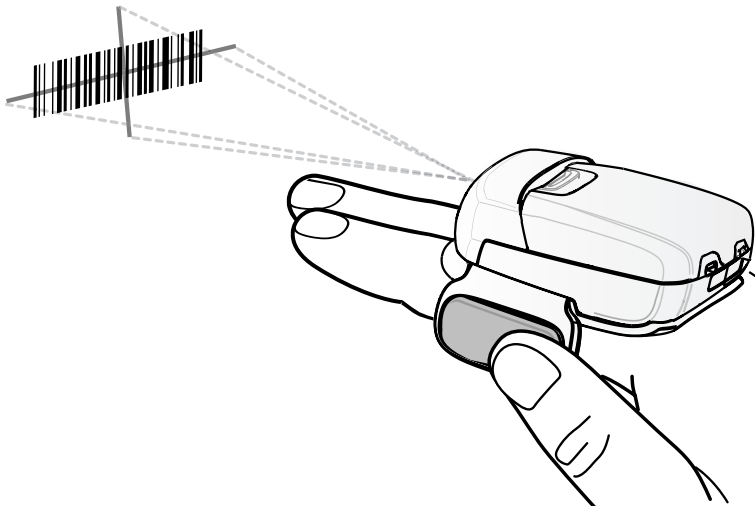

4. Press and hold the trigger.

The red laser aiming pattern turns on to assist in aiming. Ensure the barcode is within the area formed by the cross-hairs in the aiming pattern. The aiming dot increases visibility in bright lighting conditions.

The RS507/RS507X LEDs light green and a beep sounds to indicate the barcode was decoded successfully. When the RS507/RS507X is in Pick List mode, the RS507/RS507X does not decode the barcode until the center of the crosshair touches the barcode.

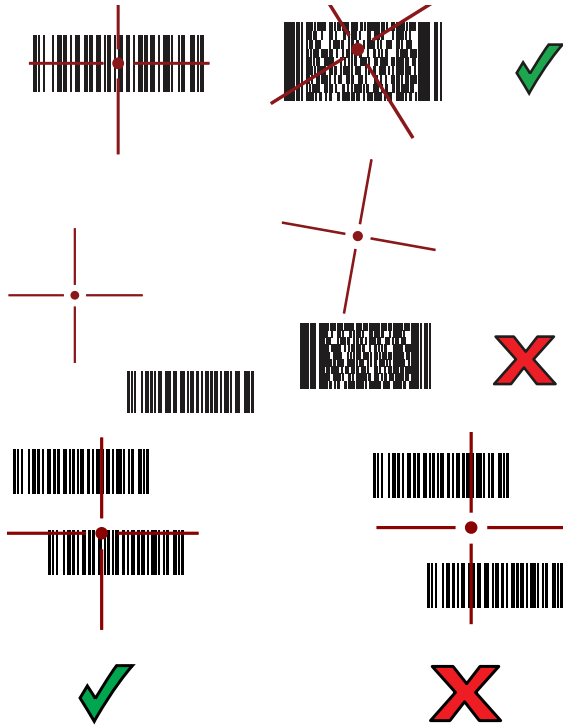

5. The captured data appears in the text field.

## Pairing the Bluetooth Ring Scanner

To connect the RS507/RS507X, RS5100, or RS6000 Bluetooth Ring Scanner to the device, use one of the following methods:

- Near Field Communication (NFC) (RS5100 and RS6000 only)
- Simple Serial Interface (SSI)
- Bluetooth Human Interface Device (HID) Mode



**NOTE:** When establishing a connection, a pairing confirmation prompt may appear on devices without a Mobility DNA Enterprise License.

## Pairing Using Near Field Communication

The device provides the ability to pair the RS5100 or RS6000 using NFC.



**NOTE:** RS5100 and RS6000 Only.

To pair using NFC:

1. Ensure that the RS5100 or RS6000 is in SSI mode. Refer to the RS5100 or RS6000 User Guide for more information.
2. Ensure that NFC is enabled on the device.
3. Align the NFC icon on the RS6000 with the NFC antenna on the device.

The RS5100 or RS6000 Status LED blinks blue indicating that the RS5100 or RS6000 is attempting to establish connection with the device. When connection is established, the Status LED turns off and the RS5100 or RS6000 emits a single string of low/high beeps.

A notification appears on the device screen and the  icon appears in the Status bar.

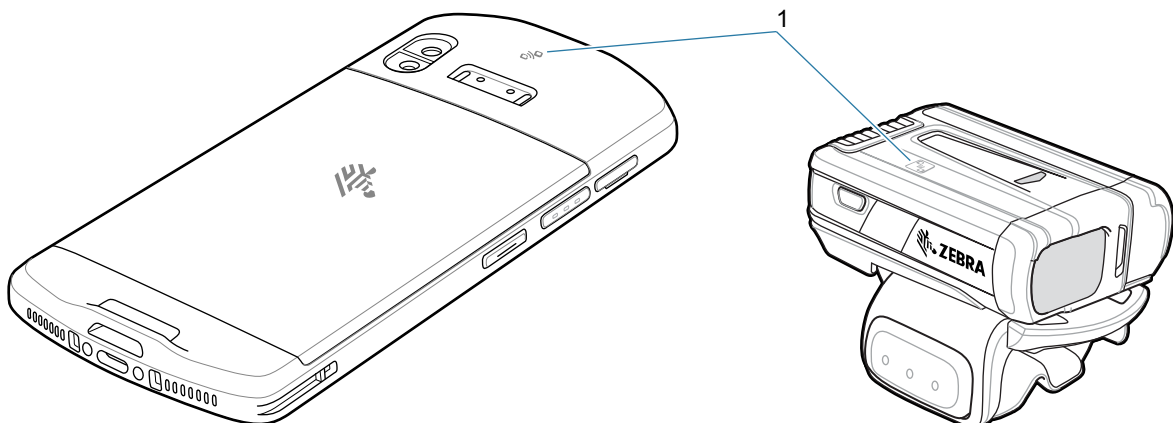

1	NFC antenna
---	-------------



## Pairing in HID Mode Using Near Field Communication

The device provides the ability to pair the RS5100 or RS6000 in HID mode using NFC.



**NOTE:** RS5100 or RS6000 Only.

To pair in HID mode using NFC:

1. Ensure that NFC is enabled on the device.
2. Ensure that Bluetooth is enabled on the device.
3. Place the RS5100 or RS6000 in Human Interface Device (HID) mode. If the RS5100 or RS6000 is already in HID mode, skip to step 4.
  - a. Remove the battery from the RS5100 or RS6000.
  - b. Press and hold the Restore key.
  - c. Install the battery onto the RS5100 or RS6000.
  - d. Keep holding the Restore key for about five seconds until a chirp is heard and the Scan LEDs flash green.
  - e. Scan the barcode below to place the RS5100 or RS6000 in HID mode.

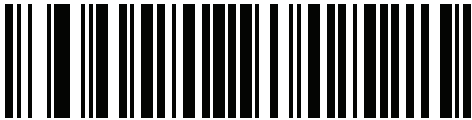

4. Remove the battery from the RS5100 or RS6000.
5. Re-install the battery into the RS5100 or RS6000.
6. Align the NFC icon on the RS5100 or RS6000 with the NFC antenna on the device.

The RS5100 or RS6000 Status LED blinks blue indicating that the RS5100 or RS6000 is attempting to establish connection with the device. When connection is established, the Status LED turns off and the RS6000 emits a single string of low/high beeps.

A notification appears on the device screen and the **A** icon appears in the Status bar.

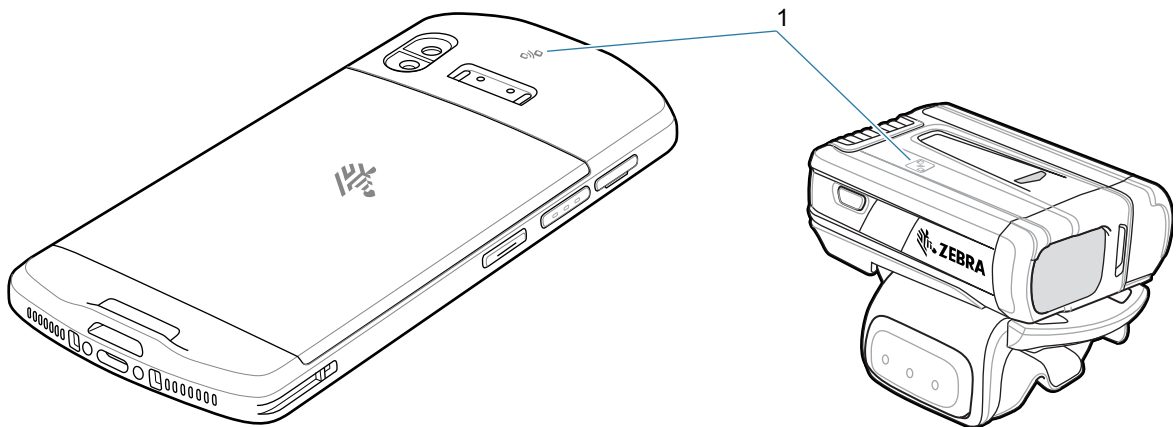

1	NFC antenna
---	-------------

## Pairing Using Simple Serial Interface

To pair the Bluetooth Scanner with the device using SSI.

1. Swipe up from the bottom of the Home screen and touch .

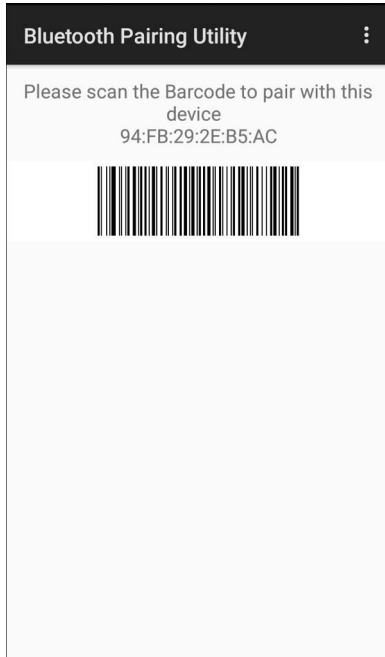

2. Using the Bluetooth Scanner, scan the barcode on the screen.

The Ring Scanner emits a string of high/low/high/low beeps. The Scan LED flashes green indicating that the Ring Scanner is attempting to establish connection with the device. When connection is established, the Scan LED turns off and the Ring Scanner emits one string of low/high beeps.

A notification appears on the Notification panel and the  icon appears in the Status bar.

## Pairing Using Bluetooth Human Interface Device

To pair the Ring Scanner with the device using Human Interface Device (HID):

1. Ensure that Bluetooth is enabled on both devices.
2. Ensure that the Bluetooth device to discover is in discoverable mode.
3. Ensure that the two devices are within 10 meters (32.8 feet) of one another.
4. Place the Ring Scanner in HID mode. If the Ring Scanner is already in HID mode, skip to step 5.
  - a. Remove the battery from the Ring Scanner.
  - b. Press and hold the Restore key.
  - c. Install the battery onto the Ring Scanner.
  - d. Keep holding the Restore key for about five seconds until a chirp is heard and the Scan LEDs flash green.
  - e. Scan the barcode below to place the Ring Scanner in HID mode.

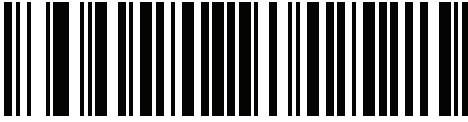
**Figure 10** RS507 Bluetooth HID Barcode**Figure 11** RS6000 Bluetooth HID Barcode

5. Remove the battery from the Ring Scanner.
6. Re-install the battery into the Ring Scanner.
7. Go to **Settings**.
8. Touch **Bluetooth**.
9. Touch **Pair new device**. The device begins searching for discoverable Bluetooth devices in the area and displays them under **Available devices**.
10. Scroll through the list and select Ring Scanner.

The device connects to the Ring Scanner and **Connected** appears below the device name. The Bluetooth device is added to the **Paired devices** list and a trusted (“paired”) connection is established.

A notification appears on Notification panel and the **A** icon appears in the Status bar.

## DataWedge

DataWedge is a utility that adds advanced barcode scanning capability to any application without writing code. It runs in the background and handles the interface to built-in barcode scanners. The captured barcode data is converted to keystrokes and sent to the target application as if it was typed on the keypad. DataWedge allows any app on the device to get data from input sources such as a barcode scanner, MSR, RFID, voice, or serial port and manipulate the data based on options or rules.

Configure DataWedge to:

- Provide data capture services from any app.
- Use a particular scanner, reader or other peripheral device.
- Properly format and transmit data to a specific app.

To configure DataWedge refer to [techdocs.zebra.com/datawedge/](http://techdocs.zebra.com/datawedge/).

## Enabling DataWedge

Datawedge is enabled by default on this device. Re-enable DataWedge on the device from the DataWedge app.

1. Swipe up from the bottom of the Home screen and touch .
2. Touch **⋮** > **Settings**.
3. Touch the **DataWedge enabled** checkbox. A blue checkmark appears in the checkbox indicating that DataWedge is enabled.
4. Touch the Home button.

## Disabling DataWedge

1. Touch .
2. Touch **Settings**.
3. Touch **DataWedge enabled**.

The blue check disappears from the checkbox indicating that DataWedge is disabled.

## Supported Decoders



**NOTE:** DataWedge supports the decoders listed below but not all are validated on this device.

**Table 14** Supported Decoders

Decoders	Camera	Internal Imager SE4100	RS5100	RS6000	RS507/RS507X
Australian Postal	O	O	O	O	O
Aztec	X	X	X	X	X
Canadian Postal	O	--	O	O	--
Chinese 2 of 5	O	O	O	O	O
Codabar	X	X	X	X	X
Code 11	O	O	O	O	O
Code 128	X	X	X	X	X
Code 39	X	X	X	X	X
Code 93	O	X	O	O	O
Composite AB	O	O	O	O	O
Composite C	O	O	O	O	O
Discrete 2 of 5	O	O	O	O	O
Datamatrix	X	X	X	X	X
Dutch Postal	O	--	O	O	O
DotCode	X	O	O	O	O
EAN13	X	X	X	X	X

**Table 14** Supported Decoders (Continued)

Decoders	Camera	Internal Imager SE4100	RS5100	RS6000	RS507/RS507X
EAN8	X	X	X	X	X
Grid Matrix	O	O	O	O	O
GS1 DataBar	X	X	X	X	X
GS1 DataBar Expanded	X	X	X	X	X
GS1 DataBar Limited	O	X	O	O	O
GS1 Datamatrix	O	O	O	O	--
GS1 QRCode	O	--	O	O	--
HAN XIN	O	O	O	O	--
Interleaved 2 of 5	O	X	O	O	O
Japanese Postal	O	O	O	O	O
Korean 3 of 5	O	O	O	O	O
MAIL MARK	X	O	X	X	--
Matrix 2 of 5	O	O	O	O	O
Maxicode	X	O	X	X	X
MicroPDF	O	O	O	O	O
MicroQR	O	X	O	O	O
MSI	O	O	O	O	O
PDF417	X	X	X	X	X
QR Code	X	X	X	X	X
Decoder Signature	O	--	O	O	O
TLC 39	O	O	O	O	O
Trioptic 39	O	O	O	O	O
UK Postal	O	O	O	O	O
UPCA	X	X	X	X	X
UPCE0	X	X	X	X	X
UPCE1	O	O	O	O	O
US4state	O	--	O	O	O

**Table 14** Supported Decoders (Continued)

Decoders	Camera	Internal Imager SE4100	RS5100	RS6000	RS507/RS507X
US4state FICS	O	--	O	O	O
US Planet	O	O	O	O	O
US Postnet	O	O	O	O	O

Key

X = Enabled

O = Disabled

-- = Not Supported

Touch the Back button to return to the previous screen.

# Wireless

This section provides information on the following wireless features:

- Wireless Wide Area Network (WWAN)
- Wireless Local Area Network (WLAN)
- Bluetooth
- Cast
- Near Field Communications (NFC)

## Wireless Local Area Networks

Wireless local area networks (WLANs) allow the device to communicate wirelessly inside a building. Before using the device on a WLAN, the facility must be set up with the required hardware to run the WLAN (sometimes known as infrastructure). The infrastructure and the device must both be properly configured to enable this communication.

Refer to the documentation provided with the infrastructure (access points (APs), access ports, switches, Radius servers, etc.) for instructions on how to set up the infrastructure.

Once the infrastructure is set up to enforce the chosen WLAN security scheme, use the **Wireless & networks** settings configure the device to match the security scheme.

The device supports the following WLAN security options:

- Open
- Wireless Equivalent Privacy (WEP)
- Wi-Fi Protected Access (WPA)/WPA2 Personal (PSK)
- WPA/WPA2/WPA3 Enterprise (EAP)
  - Protected Extensible Authentication Protocol (PEAP) - with MSCHAPV2 and GTC authentication.
  - Transport Layer Security (TLS)
  - Tunneled Transport Layer Security (TTLS) - with Password Authentication Protocol (PAP), MSCHAP and MSCHAPv2 authentication
  - Password (PWD)
  - Lightweight Extensible Authentication Protocol (LEAP).

The **Status** bar displays icons that indicate Wi-Fi network availability and Wi-Fi status.



**NOTE:** To extend the life of the battery, turn off Wi-Fi when not in use.

## Connecting to a Wi-Fi Network

To connect to a Wi-Fi network:

1. Go to **Settings**.
2. Touch **Wi-Fi** to open the **Wi-Fi** screen. The device searches for WLANs in the area and lists them.
3. Scroll through the list and select the desired WLAN network.
4. For open networks, touch profile once or press and hold and then select **Connect** or for secure networks enter the required password or other credentials then touch **Connect**. See the system administrator for more information.

The device obtains a network address and other required information from the network using the dynamic host configuration protocol (DHCP) protocol. To configure the device with a fixed internet protocol (IP) address, see [Configuring the Device to Use a Static IP Address on page 1](#).

5. In the Wi-Fi setting field, **Connected** appears indicating that the device is connected to the WLAN.

## Removing a Wi-Fi Network

To remove a remembered or connected network:

1. Go to **Settings**.
2. Touch **Network & Internet > W-Fi**.
3. Scroll down to the bottom of the list and touch **Saved networks**.
4. Touch the name of the network.
5. Touch **FORGET**.
6. Touch the Home button.

## WLAN Configuration

This section provides information on configuring Wi-Fi settings.

### Configuring a Secure Wi-Fi Network

1. Go to **Settings**.
2. Touch **Network & Internet > Wi-Fi**.
3. Slide the switch to the **ON** position.
4. The device searches for WLANs in the area and lists them on the screen.
5. Scroll through the list and select the desired WLAN network.
6. Touch the desired network. If the network security is **Open**, the device automatically connects to the network. For all other network security a dialog box appears.
7. If the network security is WPA/WPA2-Personal, or WEP, enter the required password and then touch **Connect**.
8. If the network security is WPA/WPA2/WPA3 Enterprise:



- Touch the **EAP method** drop-down list and select one of the following:
  - **PEAP**
  - **TLS**
  - **TTLS**
  - **PWD**
  - **LEAP**.
- Touch the **Phase 2 authentication** drop-down list and select an authentication method.
- If required, touch **CA certificate** and select a Certification Authority (CA) certificate. Note: Certificates are installed using the **Security** settings.
- If required, touch **User certificate** and select a user certificate. Note: User certificates are installed using the Security settings.
- If required, in the **Identity** text box, enter the username credentials.
- If desired, in the **Anonymous identity** text box, enter an anonymous identity username.
- If required, in the **Password** text box, enter the password for then given identity.



**NOTE:** By default, the network Proxy is set to **None** and the IP settings is set to **DHCP**. See Configuring for a Proxy Server for setting connection to a proxy server and see Configuring the Device to Use a Static IP Address for setting the device to use a static IP address.

9. Touch **Connect**.
10. Touch the Home button.

## Manually Adding a Wi-Fi Network

Manually add a Wi-Fi network if the network does not broadcast its name (SSID) or to add a Wi-Fi network when out of range.

1. Go to **Settings**.
2. Touch **Network & Internet > Wi-Fi**.
3. Slide the Wi-Fi switch to the **On** position.
4. Scroll to the bottom of the list and select **Add network**.
5. In the **Network name** text box, enter the name of the Wi-Fi network.
6. In the **Security** drop-down list, set the type of security to:
  - **None**
  - **WEP**
  - **WPA/WPA2-Personal**
  - **WPA/WPA2/WPA3-Enterprise**
7. If the network security is **None** , touch **Save**.
8. If the network security is **WEP**, or **WPA/WPA2-Personal**, enter the required password and then touch **Save**.
9. If the network security is **WPA/WPA2/WPA3-Enterprise**:
  - Touch the **EAP method** drop-down list and select one of the following:
    - **PEAP**

- **TLS**
- **TTLS**
- **PWD**
- **LEAP.**
- Touch the **Phase 2 authentication** drop-down list and select an authentication method.
- If required, touch **CA certificate** and select a Certification Authority (CA) certificate. Note: Certificates are installed using the **Security** settings.
- If required, touch **User certificate** and select a user certificate. Note: User certificates are installed using the **Security** settings.
- If required, in the **Identity** text box, enter the username credentials.
- If desired, in the **Anonymous identity** text box, enter an anonymous identity username.
- If required, in the **Password** text box, enter the password for the given identity.



**NOTE:** By default, the network Proxy is set to **None** and the IP settings is set to **DHCP**. See [Configuring for a Proxy Server on page 1](#) for setting connection to a proxy server and see [Configuring the Device to Use a Static IP Address on page 1](#) for setting the device to use a static IP address.

10. Touch **Save**. To connect to the saved network, touch and hold on the saved network and select **Connect to network**.

11. Touch the Home button.

## Configuring for a Proxy Server

A proxy server is a server that acts as an intermediary for requests from clients seeking resources from other servers. A client connects to the proxy server and requests some service, such as a file, connection, web page, or other resource, available from a different server. The proxy server evaluates the request according to its filtering rules. For example, it may filter traffic by IP address or protocol. If the request is validated by the filter, the proxy provides the resource by connecting to the relevant server and requesting the service on behalf of the client.

It is important for enterprise customers to be able to set up secure computing environments within their companies, making proxy configuration essential. Proxy configuration acts as a security barrier ensuring that the proxy server monitors all traffic between the Internet and the intranet. This is normally an integral part of security enforcement in corporate firewalls within intranets.

1. Go to **Settings**.
2. Touch **Network & Internet > Wi-Fi**.
3. Slide the Wi-Fi switch to the **On** position.
4. In the network dialog box, select and touch a network.
5. Touch **Advanced options**.
6. Touch **Proxy** and select **Manual**.
7. In the **Proxy hostname** text box, enter the address of the proxy server.
8. In the **Proxy port** text box, enter the port number for the proxy server.
9. In the **Bypass proxy for** text box, enter addresses for web sites that are not required to go through the proxy server. Use a comma “,” between addresses. Do not use spaces or carriage returns between addresses.
10. Touch **Connect**.

11. Touch the Home button.

## Configuring the Device to Use a Static IP Address

By default, the device is configured to use Dynamic Host Configuration Protocol (DHCP) to assign an Internet protocol (IP) address when connecting to a wireless network.

1. Go to **Settings**.
2. Touch **Network & Internet > Wi-Fi**.
3. Slide the Wi-Fi switch to the **On** position.
4. In the network dialog box, select and touch a network.
5. Touch **Advanced options**.
6. Touch **IP settings** and select **Static**.
7. In the **IP address** text box, enter an IP address for the device.
8. If required, in the **Gateway** text box, enter a gateway address for the device.
9. If required, in the **Network prefix length** text box, enter the prefix length.
10. If required, in the **DNS 1** text box, enter a Domain Name System (DNS) address.
11. If required, in the **DNS 2** text box, enter a DNS address.
12. Touch **Connect**.
13. Touch the Home button.

## Wi-Fi Preferences

Use the **Wi-Fi preferences** to configure advanced Wi-Fi settings. From the Wi-Fi screen scroll down to the bottom of the screen and touch **Wi-Fi preferences**.

- **Turn on Wi-Fi automatically** - When enabled, Wi-Fi automatically turns back on when near high quality saved networks.
- **Open network notification** - When enabled, notifies the user when an open network is available.
- **Advanced** - Touch to expand options.
  - **Additional settings** - See Additional Settings.
  - **Install Certificates** - Touch to install certificates.
  - **Network rating provider** - Disabled (AOSP devices). To help determine what constitutes a good Wi-Fi network, Android supports external Network rating providers that provide information about the quality of open Wi-Fi networks. Select one of the providers listed or **None**. If none are available or selected, the Connect to open networks feature is disabled.
  - **Wi-Fi Direct** - Displays a list of devices available for a direct Wi-Fi connection.
  - **MAC address** - Displays the Media Access Control (MAC) address of the device when connecting to Wi-Fi networks.
  - **IP address** - Displays the IP address of the device when connecting to Wi-Fi networks.

## Additional Wi-Fi Settings



**NOTE:** Additional Wi-Fi settings are for the device, not for a specific wireless network.

Use the **Additional Settings** to configure additional Wi-Fi settings. To view the additional Wi-Fi settings, scroll to the bottom of the **Wi-Fi** screen and touch **Wi-Fi Preferences > Advanced > Additional settings**.

- **Regulatory**
  - **Country Selection** - Displays the acquired country code if 802.11d is enabled, else it displays the currently selected country code.
  - **Region code** - Displays the current region code.
- **Band and Channel Selection**
  - **Wi-Fi frequency band** - Set the frequency band to: **Auto** (default), **5 GHz only** or **2.4 GHz only**.
  - **Available channels (2.4 GHz)** - Touch to display the **Available channels** menu. Select specific channels and touch **OK**.
  - **Available channels (5 GHz)** - Touch to display the **Available channels** menu. Select specific channels and touch **OK**.
- **Logging**
  - **Advanced Logging** – Touch to enable advanced logging or change the log directory.
  - **Wireless logs** - Use to capture Wi-Fi log files.
    - **Fusion Logger** - Touch to open the **Fusion Logger** application. This application maintains a history of high level WLAN events which helps to understand the status of connectivity.
    - **Fusion Status** - Touch to display live status of WLAN state. Also provides information about the device and connected profile.
- **About**
  - **Version** - Displays the current Fusion information.

## Wi-Fi Direct

Wi-Fi Direct devices can connect to each other without having to go through an access point. Wi-Fi Direct devices establish their own ad-hoc network when required, letting you see which devices are available and choose which one you want to connect to.

1. Go to **Settings**.
2. Touch **Wi-Fi > Wi-Fi preferences > Advanced > Wi-Fi Direct**. The device begins searching for another Wi-Fi Direct device.
3. Under **Peer devices**, touch the other device name.
4. On the other device, select **Accept**.

**Connected** appears on the device. On both devices, in their respective Wi-Fi Direct screens, the other device name appears in the list.

## Wireless Wide Area Networks



**NOTE:** EC55 only.

Use Wireless wide area networks (WWANs) to access data over a cellular network. This section provides information on:

- Sharing a data connection
- Monitoring data usage
- Changing Cellular Network settings

## Sharing the Mobile Data Connection

The **Tethering & Portable Hotspot** settings allows sharing the mobile data connection with a single computer via USB tethering or Bluetooth tethering. Share the data connection with up to eight devices at once, by turning it into a portable Wi-Fi hotspot. While the device is sharing its data connection, an icon displays at the top of the screen and a corresponding message appears in the notification list.

### Enabling USB Tethering



**NOTE:** USB tethering is not supported on computers running Mac OS. If the computer is running Windows or a recent version of Linux (such as Ubuntu), follow these instructions without any special preparation. If running a version of Windows that precedes Windows 7, or some other operating system, you may need to prepare the computer to establish a network connection via USB.

1. Connect the device to a host computer with the USB cable.
2. The notification **Charging this device via USB** appears in the Notifications panel.
3. Go to **Settings**.
4. Touch **Network & Internet**.
5. Touch **Hotspot & tethering**.
6. Touch the **USB tethering** switch to enable.

The host computer is now sharing the device's data connection.

To stop sharing the data connection, touch the **USB tethering** switch again or disconnect the USB cable.

### Enabling Bluetooth Tethering

Use Bluetooth tethering to share the data connection with a host computer.

Configure the host computer to obtain its network connection using Bluetooth. For more information, see the host computer's documentation.

1. Pair the device with the host computer.
2. Go to **Settings**.
3. Touch **Networking & Internet**.
4. Touch **Hotspot & tethering**.
5. Touch the **Bluetooth tethering** switch to enable.

The host computer is now sharing the device's data connection.

To stop sharing the data connection, touch the **Bluetooth tethering** switch again.

### Enabling Wi-Fi Hotspot

To enable the Wi-Fi Hotspot:

1. Go to **Settings**.
2. Touch **Network & Internet**.

3. Touch **Hotspot & tethering**.
4. Touch **Wi-Fi hotspot**.
5. Toggle the switch to enable.

After a moment, the device starts broadcasting its Wi-Fi network name (SSID). Connect to it with up to eight computers or other devices. The Hotspot (📶) icon appears in the Status bar.

To stop sharing the data connection, touch the toggle switch again.

## Configuring the Wi-Fi Hotspot

1. Go to **Settings**.
2. Touch **Network & Internet**.
3. Touch **Hotspot & tethering**.
4. Touch **Wi-Fi hotspot**.
5. In the **Hotspot name** text field, edit the name for the hotspot.
6. Touch **Security** and select a security method from the drop-down list.
  - **WPA2-Personal**
    - a. Touch **Hotspot password**.
    - b. Enter a password.
    - c. Touch **OK**.
  - **None** - If **None** is selected in the Security option, a password is not required.
7. Touch **Advanced**.
8. If desired, touch **Turn off hotspot automatically** to turn off Wi-Fi Hotspot when no devices are connected.
9. In the **AP Band** drop-down list, select **2.4 GHz Band** or **5.0 GHz Band**.

## Data Usage

Data usage refers to the amount of data uploaded or downloaded by the device during a given period. Depending on the wireless plan, you may be charged additional fees when your data usage exceeds your plan's limit.

To monitor your data usage:

1. Go to **Settings**.
2. Touch **Network & internet > Mobile network > Data usage**.



**CAUTION:** The usage displayed on the data usage settings screen is measured by your device. Your carrier's data usage accounting may differ. Usage in excess of your carrier plan's data limits can result in steep overage charges. The feature described here can help you track your usage, but is not guaranteed to prevent additional charges.

Data usage settings allow:

- Enable Data Saver.
- Set the data usage warning level.
- Set a data usage limit.

- View or restrict data usage by app.
- Identify mobile hotspots and restrict background downloads that may result in extra charges.

By default, the data usage settings screen displays the mobile data settings. That is, the data network or networks provided by your carrier.

### Setting Data Usage Warning

To set a warning alert when the device has used a certain amount of mobile data:

1. Go to **Settings**.
2. Touch **Network & internet > Mobile network > Data usage > **.
3. If necessary, touch **Set data warning** to enable it.
4. Touch **Data warning**.
5. Enter a number. To switch between megabytes (MB) and gigabytes (GB), touch the down arrow.
6. Touch **SET**.

When the usage reaches the set level, a notification appears.

### Setting Data Limit

1. Go to **Settings**.
2. Touch **Network & internet > Mobile network > Data usage > **.
3. Touch **Set data limit**.
4. Touch **OK**.
5. Touch **Data limit**.
6. Enter a number. To switch between megabytes (MB) and gigabytes (GB), touch the down arrow.
7. Touch **Set**.

When the limit is reached, data automatically turns off and a notification appears.

## Cellular Network Settings

Cellular network settings applies to WWAN devices only.

### Data When Roaming

Roaming is disabled by default to prevent the device from transmitting data over other carriers' mobile networks when leaving an area that is covered by the carrier's networks. This is useful for controlling expenses if the service plan does not include data roaming.

#### Enabling Data on GSM Devices

1. Go to **Settings**.
2. Touch **Network & Internet > Mobile network**.
3. Touch **Roaming**.

The switch moves to the on position.

## Setting Preferred Network Type

Change the network operating mode.

1. Go to **Settings**.
2. In the **Preferred network type** dialog box, select a mode to set as default:
  - **Automatic (LWG)**
  - **LTE only**
  - **3G Only**
  - **2G Only**

## Using Search for MicroCell

A MicroCell acts like a mini cell tower in a building or residence and connects to an existing broadband Internet service. It improves cell signal performance for voice calls, texts, and cellular data applications like picture messaging and Web surfing.

1. Go to **Settings**.
2. Touch **Network & Internet > Mobile network**.
3. Touch **Search for MicroCell**.

## Configuring the Access Point Name



**NOTE:** Many service provider Access Point Name (APN) data are pre-configured in the device. The APN information for all other service providers must be obtained from the wireless service provider.

To use the data on a network, configure the APN information.

1. Go to **Settings**.
2. Touch **Network & Internet > Mobile network > Advanced**.
3. Touch **Access Point Names**.
4. Touch an APN name in the list to edit an existing APN or touch **+** to create a new APN.
5. Touch each APN setting and enter the appropriate data obtained from the wireless service provider.
6. When finished, touch **⋮ > Save**.
7. Touch the radio button next to the APN name to start using it.
8. Touch the Home button.

## Locking the SIM Card

Locking the SIM card requires the user to enter a PIN every time the device is turned on. If the correct PIN is not entered, only emergency calls can be made.

1. Go to **Settings**.
2. Touch **Security > SIM card lock**.
3. Touch **Lock SIM card**.
4. Enter the PIN associated with the card. Touch **OK**.
5. Reset the device.



## Bluetooth

Bluetooth devices can communicate without wires, using frequency-hopping spread spectrum (FHSS) radio frequency (RF) to transmit and receive data in the 2.4 GHz Industry Scientific and Medical (ISM) band (802.15.1). Bluetooth wireless technology is specifically designed for short-range (10 m (32.8 ft)) communication and low power consumption.

Devices with Bluetooth capabilities can exchange information (for example, files, appointments, and tasks) with other Bluetooth enabled devices such as printers, access points, and other mobile devices.

The device supports Bluetooth Low Energy. Bluetooth Low Energy is targeted at applications in the healthcare, fitness, security, and home entertainment industries. It provides reduced power consumption and cost while maintaining standard Bluetooth range.

## Adaptive Frequency Hopping

Adaptive Frequency Hopping (AFH) is a method of avoiding fixed frequency interferers, and can be used with Bluetooth voice. All devices in the piconet (Bluetooth network) must be AFH-capable in order for AFH to work. There is no AFH when connecting and discovering devices. Avoid making Bluetooth connections and discoveries during critical 802.11b communications. AFH for Bluetooth consists of four main sections:

- Channel Classification - A method of detecting an interference on a channel-by-channel basis, or pre-defined channel mask.
- Link Management - Coordinates and distributes the AFH information to the rest of the Bluetooth network.
- Hop Sequence Modification - Avoids interference by selectively reducing the number of hopping channels.
- Channel Maintenance - A method for periodically re-evaluating the channels.

When AFH is enabled, the Bluetooth radio “hops around” (instead of through) the 802.11b high-rate channels. AFH coexistence allows enterprise devices to operate in any infrastructure.

The Bluetooth radio in this device operates as a Class 2 device power class. The maximum output power is 2.5 mW and the expected range is 10 m (32.8 ft). A definition of ranges based on power class is difficult to obtain due to power and device differences, and whether in open space or closed office space.



**NOTE:** It is not recommended to perform Bluetooth wireless technology inquiry when high rate 802.11b operation is required.

## Security

The current Bluetooth specification defines security at the link level. Application-level security is not specified. This allows application developers to define security mechanisms tailored to their specific need. Link-level security occurs between devices, not users, while application-level security can be implemented on a per-user basis. The Bluetooth specification defines security algorithms and procedures required to authenticate devices, and if needed, encrypt the data flowing on the link between the devices. Device authentication is a mandatory feature of Bluetooth while link encryption is optional.

Pairing of Bluetooth devices is accomplished by creating an initialization key used to authenticate the devices and create a link key for them. Entering a common personal identification number (PIN) in the devices being paired generates the initialization key. The PIN is never sent over the air. By default, the Bluetooth stack responds with no key when a key is requested (it is up to user to respond to the key request event). Authentication of Bluetooth devices is based-upon a challenge-response transaction. Bluetooth allows for a PIN or passkey used to create other 128-bit keys used for security and encryption. The encryption key is derived from the link key used to authenticate the pairing devices. Also worthy of note is the limited range and fast frequency hopping of the Bluetooth radios that makes long-distance eavesdropping difficult.

Recommendations are:

- Perform pairing in a secure environment
- Keep PIN codes private and do not store the PIN codes in the device
- Implement application-level security.

## Bluetooth Profiles

The device supports the Bluetooth services listed.

**Table 15** Bluetooth Profiles

Profile	Description
Service Discovery Protocol (SDP)	Handles the search for known and specific services as well as general services.
Serial Port Profile (SPP)	Allows use of RFCOMM protocol to emulate serial cable connection between two Bluetooth peer devices. For example, connecting the device to a printer.
Object Push Profile (OPP)	Allows the device to push and pull objects to and from a push server.
Advanced Audio Distribution Profile (A2DP)	Allows the device to stream stereo-quality audio to a wireless headset or wireless stereo speakers.
Audio/Video Remote Control Profile (AVRCP)	Allows the device to control A/V equipment to which a user has access. It may be used in concert with A2DP.
Personal Area Network (PAN)	Allows the use of Bluetooth Network Encapsulation Protocol to provide L3 networking capabilities over a Bluetooth link. Only PANU role is supported.
Human Interface Device Profile (HID)	Allows Bluetooth keyboards, pointing devices, gaming devices and remote monitoring devices to connect to the device.
Headset Profile (HSP)	Allows a hands-free device, such as a Bluetooth headset, to place and receive calls on the device.
Hands-Free Profile (HFP)	Allows car hands-free kits to communicate with the device in the car.
Phone Book Access Profile (PBAP)	Allows exchange of Phone Book Objects between a car kit and a mobile device to allow the car kit to display the name of the incoming caller; allow the car kit to download the phone book so you can initiate a call from the car display.

**Table 15** Bluetooth Profiles (Continued)

Profile	Description
Out of Band (OOB)	Allows exchange of information used in the pairing process. Pairing is completed using the Bluetooth radio, but requires information from the OOB mechanism. Using OOB with NFC enables pairing when devices simply get close, rather than requiring a lengthy discovery process.
Symbol Serial Interface (SSI)	Allows for communication with Bluetooth Imager.
Generic Attribute Profile (GATT)	Provides profile discovery and description services for Bluetooth Low Energy protocol. It defines how attributes are grouped together into sets to form services.
Dial Up Networking (DUN)	Provides a standard to access the Internet and other dial-up services over Bluetooth.
Generic Access Profile (GAP)	Use for device discovery and authentication.
Object EXchange (OBEX)	Facilitates the exchange of binary objects between devices.

## Bluetooth Power States

The Bluetooth radio is off by default.

- Suspend - When the device goes into suspend mode, the Bluetooth radio stays on.
- Airplane Mode - When the device is placed in Airplane Mode, the Bluetooth radio turns off. When Airplane mode is disabled, the Bluetooth radio returns to the prior state. When in Airplane Mode, the Bluetooth radio can be turned back on if desired.

## Bluetooth Radio Power

Turn off the Bluetooth radio to save power or if entering an area with radio restrictions (for example, an airplane). When the radio is off, other Bluetooth devices cannot see or connect to the device. Turn on the Bluetooth radio to exchange information with other Bluetooth devices (within range). Communicate only with Bluetooth radios in close proximity.



**NOTE:** To achieve the best battery life, turn off radios when not in use.

### Enabling Bluetooth

1. Swipe down from the Status bar to open the Notification panel.
2. Touch  to turn Bluetooth on.
3. Touch the Home button.

### Disabling Bluetooth

1. Swipe down from the Status bar to open the Notification panel.
2. Touch  to turn Bluetooth off.
3. Touch the Home button.

## Discovering Bluetooth Device(s)

The device can receive information from discovered devices without pairing. However, once paired, the device and a paired device exchange information automatically when the Bluetooth radio is on.

1. Ensure that Bluetooth is enabled on both devices.
2. Ensure that the Bluetooth device to discover is in discoverable mode.
3. Ensure that the two devices are within 10 meters (32.8 feet) of one another.
4. Swipe down from the Status bar to open the Quick Access panel.
5. Touch and hold **Bluetooth**.
6. Touch **Pair new device**. The device begins searching for discoverable Bluetooth devices in the area and displays them under **Available devices**.
7. Scroll through the list and select a device. The Bluetooth pairing request dialog box appears.
8. Touch **Pair** on both devices.
9. The Bluetooth device is added to the **Paired devices** list and a trusted (“paired”) connection is established.

## Changing the Bluetooth Name

By default, the device has a generic Bluetooth name that is visible to other devices when connected.

1. Go to **Settings**.
2. Touch **Connected devices > Connection preferences > Bluetooth**.
3. If Bluetooth is not on, move the switch to turn Bluetooth on.
4. Touch **Device name**.
5. Enter a name and touch **RENAME**.
6. Touch the Home button.

## Connecting to a Bluetooth Device

Once paired, connect to a Bluetooth device.

1. Go to **Settings**.
2. Touch **Connected devices > Connection preferences > Bluetooth**.
3. In the list, touch the unconnected Bluetooth device.

When connected, **Connected** appears below the device name.

## Selecting Profiles on the Bluetooth Device

Some Bluetooth devices have multiple profiles.

1. Go to **Settings**.
2. Touch **Connected devices > Connection preferences > Bluetooth**.
3. In the **Paired Devices** list, touch  next to the device name.
4. Turn on or off a profile to allow the device to use that profile.
5. Touch the Home button.

## Unpairing a Bluetooth Device

Unpairing a Bluetooth device erases all pairing information.

1. Go to **Settings**.
2. Touch **Connected devices > Connection preferences > Bluetooth**.
3. In the **Paired Devices** list, touch  next to the device name.
4. Touch **FORGET**.
5. Touch the Home button.

## Cast

Use **Cast** to mirror the device screen on a Miracast enabled wireless display.

1. Go to **Settings**.
2. Touch **Connected devices > Connection preferences > Cast**.
3. Touch  > **Enable wireless display**.  
The device searches for nearby Miracast devices and lists them.
4. Touch a device to begin casting.
5. Touch the Home button.

## Near Field Communications

NFC/HF RFID is a short-range wireless connectivity technology standard that enables secure transaction between a reader and a contactless smartcard. The technology is based on ISO/IEC 14443 type A and B (proximity) ISO/IEC 15693 (vicinity) standards, using the HF 13.56 MHz unlicensed band.

The device supports the following operating modes:

- Reader mode
- Peer-to-Peer communication
- Card Emulation mode.

Using NFC, the device can:

- Read contactless cards such as contactless tickets, ID cards and ePassport.
- Read and write information to contactless cards such as SmartPosters and tickets, as well as devices with NFC interface such as vending machines.
- Read information from supported medical sensors.
- Pair with supported Bluetooth devices such as printers , ring scanners (ex. RS6000), and headsets (ex. HS3100).
- Exchange data with another NFC device.
- Emulate contactless card such as payment,ticket, or SmartPoster.

The device NFC antenna is positioned to read NFC cards from the top of the device while the device is being held.

## Reading NFC Cards

Read contactless cards using NFC.

**Figure 12** Reading Cards

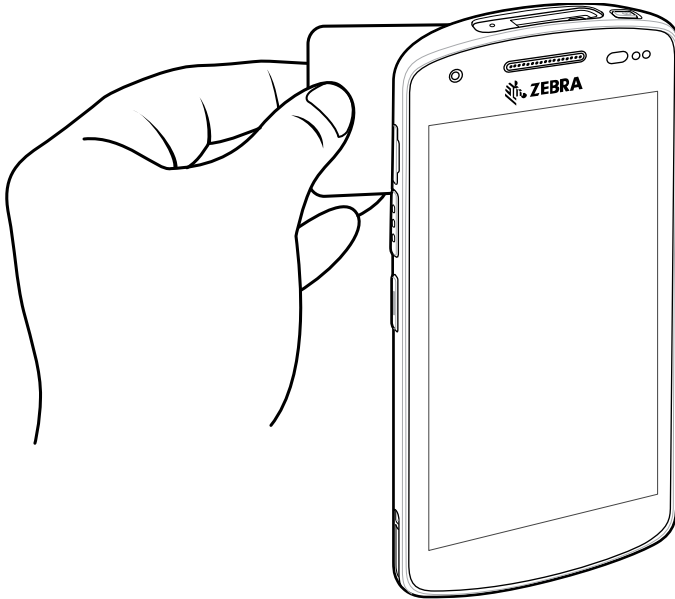

1. Launch an NFC enabled application.
2. Hold device as shown.
3. Move the device close to the NFC card until it detects the card.
4. Hold the card steadily until the transaction is complete (usually indicated by the application).

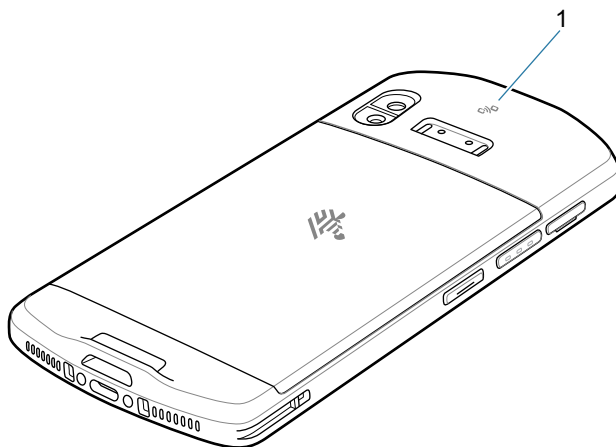

1	NFC Antenna
---	-------------

## Enterprise NFC Settings

Improve NFC performance or increase battery life by selecting which NFC features to use on the device.

- **Card Detection Mode** - Select a card detection mode.

- **Low** - Increases battery life by lowering the NFC detection speed.
- **Hybrid** - Provides a balance between NFC detection speed and battery life (default).
- **Standard** - Provides the best NFC detection speed, but reduces battery life.
- **Supported Card Technology** - Select an option to detect only one NFC tag type, increasing battery life, but reducing detection speed.
  - **All (Default)** - Detects all NFC tag types. This provides the best detection speed, but reduces battery life.
  - **ISO 14443 Type A/B**
  - **FeliCa**
  - **ISO15693**
- **Other NFC settings available with Zebra administrator tools (CSP)** - Allows configuration of additional Enterprise NFC Settings through staging tools and Mobile Device Management (MDM) solutions with an MX version that supports the Enterprise NFC Settings Configuration Service Provider (CSP). For more information on using the Enterprise NFC Settings CSP, refer to: [techdocs.zebra.com](https://techdocs.zebra.com).

# Calls



**NOTE:** This section applies to WWAN devices only.

Make a phone call from the **Phone** app, the **Contacts** app, or other apps or widgets that display contact information.

## Emergency Calling

The service provider programs one or more emergency phone numbers, such as 911 or 999, that the user can call under any circumstances, even when the phone is locked, a SIM card is not inserted or the phone is not activated. The service provider can program additional emergency numbers into the SIM card. However, the SIM card must be inserted in the device in order to use the numbers stored on it. See the service provider for additional information.



Emergency numbers vary by country. The phone's pre-programmed emergency number(s) may not work in all locations, and sometimes an emergency call cannot be placed due to network, environmental, or interference issues.

## Audio Modes

The device offers three audio modes for use during phone calls.

- Handset Mode - Switch audio to the receiver at the top front of the device to use the device as a handset. This is the default mode.
- Speaker Mode - Use the device as a speakerphone.
- Headset Mode - Connect a Bluetooth or wired headset to automatically switch audio to the headset.

## Bluetooth Headset

Use a Bluetooth headset for audio communication when using an audio-enabled app. See [Bluetooth on page 100](#) for information on connecting a Bluetooth headset to the device. Set the volume appropriately before putting on the headset. When a Bluetooth headset is connected, the speakerphone is muted.

## Wired Headset

Use a wired headset and audio adapter for audio communication when using an audio-enabled app. Set the volume appropriately before putting on the headset. When a wired headset is connected, the speakerphone is muted.













To end a call using the wired headset, press and hold the headset button until the call ends.

## Adjusting Audio Volume



- Use the volume buttons to adjust the phone volume.
  - Ring and notification volumes when not in a call.
  - Conversation volume during a call.

## Making a Call Using the Dialer

Use the dialer tab to dial phone numbers.

1. On the Home screen touch .
2. Touch .
3. Touch the keys to enter the phone number.
4. Touch  below the dialer to initiate the call.
  -  - Send audio to the speakerphone.
  -  - Mute the call.
  -  - Display the dial pad.
  -  - Place the call on hold (not available on all services).
  -  - Create a conference call.
  -  - Increase audio level.
5. Touch  to end the call.

If using a Bluetooth headset, additional audio options are available. Touch the audio icon to open the audio menu.

-  - Audio is routed to the Bluetooth headset.
-  - Audio is routed to the speakerphone.
-  - Audio is routed to the earpiece.

## Accessing Dialing Options

The dialer provides options to save the dialed number to contacts, send an SMS, or insert pauses and wait into the dial string.

- Enter at least one digit in the dialer, then touch .
  - **Add 2–sec pause** - Pause the dialing of the next number for two seconds. Multiple pauses are added sequentially.
  - **Add wait** - Wait for confirmation to send the rest of the digits.





## Making a Call Using Contacts

There are two ways to make a call using contacts:



- Using the Dialer

- Using the Contacts app.

## Using the Dialer

1. On the Home screen touch .
2. Touch the  tab.
3. Touch the contact.
4. Touch  to initiate the call.
5. Touch  to end the call.



## Using the Contacts App

1. Touch .
2. Touch a contact name.
3. Touch  to initiate the call.





## Making a Call Using Call History

Call History is a list of all the calls placed, received, or missed. It provides a convenient way to redial a number, return a call, or add a number to Contacts.

Arrow icons beside a call indicate the type of call. Multiple arrows indicate multiple calls.

-  - Missed incoming call
-  - Received incoming call
-  - Outgoing call.

## Using the Call History List



1. On the Home screen touch .
2. Touch the  tab.
3. Touch  next to the contact to initiate the call.
4. Touch the contact to perform other functions.
5. Touch  to end the call.



## Making a Conference Call on GSM



Create a conference phone session with multiple people.











**NOTE:** Conference Calling and the number of conference calls allowed may not be available on all services. Please check with the service provider for Conference Calling availability.

1. On the Home screen touch .
2. Touch .
3. Touch the keys to enter the phone number.

4. Touch  below the dialer to initiate the call.
5. When the call connects, touch .
 

The first call is placed on hold.
6. Touch .
7. Touch the keys to enter the second phone number.
8. Touch  below the dialer to initiate the call.
 

When the call connects, the first call is placed on hold and the second call is active.
9. Touch  to create a conference call with three people.
10. Touch  to add another call.
 

The conference is placed on hold.
11. Touch .
12. Touch the keys to enter another phone number.
13. Touch  below the dialer to initiate the call.
14. Touch  icon to add the third call to the conference.
15. Touch **Manage conference call** to view all callers.
  -  - Remove a caller from the conference
  -  - Speak privately with one party during a conference call
  -  - Include all parties again.

## Making a Call Using a Bluetooth Headset

To make a call using a Bluetooth headset:



1. Pair the Bluetooth headset with the device.
2. Press the Call button on the Bluetooth headset.
3. Press the Call button on the Bluetooth headset to end the call.

## Answering Calls

When receiving a phone call, the **Incoming Call** screen displays the caller ID and any additional information about the caller that is in the **Contacts** app.

- Touch **ANSWER** to answer the call or **DECLINE** to send the caller to voice mail.

If the screen lock is enabled, the user can answer the call without unlocking the device.

- When a call arrives:
  - Touch  and slide up to answer the call.
  - Touch  and slide down to send the call to voice mail.
  - Touch  to open a list of quick text responses. Touch one to send it to the caller immediately.

When the calls ends, the device remains locked.

If using a Bluetooth headset when a call arrives, touch the Call button on the Bluetooth headset to answer the call. To end the call press the headset Call button.

All incoming calls are recorded in the Phone app Call log tab. If you miss a call, you receive a notification. To silence the ringer before answering the call, press the volume down button on the side of device.

## Call Settings



**NOTE:** Not all options are available for all configurations

To modify phone call settings, on the Home screen touch  >  > **Settings**.

- **Display options**
  - **Sort by** - Set to **First name** or **Last name**.
  - **Name format** - Set to **First name first** or **Last name first**.
- **Sounds and vibrations** - Touch to edit the general sound settings for the device.
- **Quick responses** - Touch to edit quick responses to use instead of answering a call.
- **Speed dial settings** - Set speed dial contact shortcuts.
- **Calls**
  - **Calling accounts**
    - **SIP accounts** - Choose to receive Internet calls for accounts added to the device, view or change SIP accounts, or add an Internet calling account.
    - **Use SIP calling** - Set to **For all calls** or **Only for SIP calls** (default).
    - **Receive incoming calls** - Enable to allow incoming calls (default - disabled).
  - **Fixed Dialing Numbers** - Set to only allow the phone to dial the phone number(s) or area code(s) specified in a Fixed Dialing list.
  - **Call forwarding** - Set to forward incoming calls to a different phone number.



**NOTE:** Call Forwarding may not be available on all networks. Check with the service provider for availability.

- **Call barring** - Set to block certain types of incoming or outgoing calls.
- **Additional settings**
  - **Caller ID** - Set caller ID to reveal the identity of the person making an outgoing call. Options: **Network default** (default), **Hide number**, **Show number**.
  - **Call waiting** - Set to be notified of an incoming call while on a call.
- **Blocked numbers** - Set to block calls and texts from certain phone numbers. Touch ADD A NUMBER to block a phone number.
- **Voicemail** - Configure voicemail settings.
  - **Notifications** - Configure voicemail notification settings.
    - **Alerting** - Touch to receive sound and vibration notifications when a voicemail is received. Use toggle switches to enable or disable **Pop on screen**, **Blink light**, **Show notification dot**, and **Override Do Not Disturb**.

- **Silent** - Touch to silence sound and vibration notifications when a voicemail is received. Use toggle switches to enable or disable **Minimize**, **Show notification dot**, and **Override Do Not Disturb**.
- **Sound** - Select a sound to play for notifications from this app.
- **Vibrate** - Allow notifications from this app to vibrate the device.
- **Blink light** - Allow notifications from this app the light the Notification LED blue.
- **Show notification dot** - Allow notifications from this app to add a notification dot to the app icon.
- **Override Do Not Disturb** - Allow these notifications to interrupt when Do Not**Advanced Settings**
  - **Service** - Set the service provider or other provider for voicemail service.
  - **Setup** - Select to update the phone number used to access voicemail.
- **Accessibility**
  - **Hearing aids** - Select to enable hearing air compatibility.
  - **RTT settings** - Configure Real-time text (RTT) settings.
    - **Real-time text (RTT) call** - Select to allow messaging during a call.
    - **Set RTT visibility** - Set to **Visible during calls** (default) or **Always visible**.

# Accessories

This section provides information for using the accessories for the device.

This following table lists the accessories available for the device.

**Table 16** Accessories

Accessory	Part Number	Description
<b>Cradles</b>		
1-Slot Charge Only Cradle	CRD-EC5X-1SCU-01	Provides device charging only. Requires USB-C cable (CBL-TC5X-USBC2A-01) and power supply (PWR-WUA5V12W0xx).
1-Slot USB/Ethernet Cradle	CRD-EC5X-1SCUE-01	Provides device charging and communication. Requires power supply (PWR-BGA12V50W0WW) and DC line cord (CBL-DC-388A1-01).
4-Slot Charge Only Cradle	CRD-EC5X-4SCO-01	Charges up to four devices. Requires power supply (PWR-BGA12V108W0WW), DC line cord (CBL-DC-381A1-01), and country-specific AC line cord.
4-Slot Charge Only Locking Cradle	CRD-EC5X-4SCOL-01	Charges up to four devices. Requires power supply (PWR-BGA12V108W0WW), DC line cord (CBL-DC-381A1-01), and country-specific AC line cord.
1-Slot Workstation Cradle	CRD-EC5X-1SWS-01	Provides device charging and provides Ethernet communication for up to five devices. Requires power supply (PWR-BGA12V108W0WW), DC line cord (CBL-DC-381A1-01), and country-specific AC line cord.
5-Slot Ethernet Cradle	CRD-EC5X-SE5ET-01	Provides up to five device charging, Ethernet Communication, and two Ethernet ports. Requires power supply (PWR-BGA12V108W0WW) and DC line cord (CBL-DC-381A1-01).
<b>Batteries and Chargers</b>		
PowerPrecision Standard Battery	BTRY-EC5X-ST1-01	Replacement standard battery (single pack).

## Accessories

**Table 16** Accessories (Continued)

Accessory	Part Number	Description
PowerPrecision Extended Battery	BTRY-EC5X-EX1-01	Extended battery (single pack). Requires extended battery door (KT-EC5X-EXBTYD1-01).
<b>Vehicle Solutions</b>		
Vehicle Holder	CRD-EC5X-VCH1-01	Provides mounting solution for the device in a vehicle.
<b>Charge and Communication Cables</b>		
USB-C Communication and Charge Cable	CBL-TC5X-USBC2A-01	Provides UBC-A to USB-C communication and power to the device.
<b>Audio Accessories</b>		
USB-C Digital Audio Adapter	ADP-USBC-35MM1-01	Plugs into the device and provides audio to a wired headset with collared 3.5 mm plug.
HS2100 Rugged Wired Headset	HS2100-OTH	Rugged Corded Headset. Includes HS2100 Boom Module and HSX100 OTH Headband Module.
HS2100 3.5 mm Headset Cable	CBL-HS2100-3MS1-01	Plugs into the HS2100 headset and provides a collared 3.5 mm plug. Requires USB-C Digital Audio Adapter (ADP-USBC-35MM1-01).
<b>Miscellaneous</b>		
Rugged Boot	SG-EC5X-BOOT1-01	Provides additional protection for the device.
Trigger Handle	TRG-EC5X-SNP1-01	Adds gun-style handle with a scanner trigger for comfortable and productive scanning.
Coiled Tether	SG-EC5X-TCLIP1-01	Secures the device to a garment.
Screen Protector	SG-EC5X-SCRNPT1-01	Add additional screen protection.
<b>Carrying Solutions</b>		
Soft Holster	SG-EC5X-HLSTR1-01	Use to hold the device on hip. Accepts device with Trigger Handle
Hand Strap	SG-EC5X-HSTRP1-01	Replacement hand strap with hand strap mounting clip (3-pack).
<b>Power Supplies</b>		
Power Supply	PWR-BGA12V50W0WW	Provides power to the 1-Slot USB/Ethernet cradle and 4-Slot Spare Battery Charger. Requires AC line cord.
Power Supply	PWR-BGA12V108W0WW	Provides power to the 4-Slot Charge Only Cradle with battery Charger, 5-Slot Charge Only cradle and the 5-Slot Ethernet Cradle. Requires DC Line Cord, p/n 50-16002-029R and country specific three wire grounded AC line cord sold separately.
Power Supply	PWR-WUA5V12W0US	Provides 12 VDC, 2.5 A power to the USB cable. Includes plug adapter for use in the United States.

**Table 16** Accessories (Continued)

Accessory	Part Number	Description
Power Supply	PWR-WUA5V12W0EU	Provides 12 VDC, 2.5 A power to the USB cable. Includes plug adapter for use in the European Union.
Power Supply	PWR-WUA5V12W0GB	Provides 12 VDC, 2.5 A power to the USB cable. Includes plug adapter for use in the United Kingdom.
Power Supply	PWR-WUA5V12W0AU	Provides 12 VDC, 2.5 A power to the USB cable. Includes plug adapter for use in Australia.
Power Supply	PWR-WUA5V12W0CN	Provides 12 VDC, 2.5 A power to the USB cable. Includes plug adapter for use in China.
Power Supply	PWR-WUA5V12W0IN	Provides 12 VDC, 2.5 A power to the USB cable. Includes plug adapter for use in India.
Power Supply	PWR-WUA5V12W0KR	Provides 12 VDC, 2.5 A power to the USB cable. Includes plug adapter for use in Korea.
Power Supply	PWR-WUA5V12W0BR	Provides 12 VDC, 2.5 A power to the USB cable. Includes plug adapter for use in Brazil.
DC Line Cord	CBL-DC-381A1-01	Provides power from the power supply (PWR-BGA12V108W0WW) to the 4-Slot Charge Only Cradle with Battery Charger, 5-Slot Charge Only Cradle and 5-Slot Ethernet Cradle.
DC Line Cord	CBL-DC-388A1-01	Provides power from the power supply (PWR-BGA12V50W0WW) to the 1-Slot USB/Charge Only Cradle and 4-Slot Battery Charger.
US AC Line Cord	23844-00-00R	Provide power to power supplies.

## Device Charging

Before using the device for the first time, charge the device until the green Charging/Notification light emitting diode (LED) remains lit. To charge the device use a cable or a cradle with the appropriate power supply.

The device's Charging/Notification LED indicates the status of the device charging. See [Table 1 on page 10](#) for device charging status. When charging the device using a Zebra cradle or power supply, the standard battery charges from fully depleted to 90% in less than two hours. The extended battery charges from fully depleted to 90% in less than three hours.



**NOTE:** In many cases the 90% charge provides plenty of charge for daily use.

To achieve the best fast charging results use only Zebra charging accessories. Charge the device at room temperature.



## Charging Indicators

**Table 17** Charging/Notification LED Charging Indicators

State	Indication
Off	Device is not charging. Device is not inserted correctly in the cradle or connected to a power source. Charger/cradle is not powered.
Slow blinking amber (1 blink every 4 seconds)	Device is charging.
Slow blinking red (1 blink every 4 seconds)	Device is charging but the battery is at end of useful life.
Solid green	Charging complete.
Solid red	Charging complete but the battery is at end of useful life.
Fast blinking amber (2 blinks/second)	Charging error, for example: <ul style="list-style-type: none"> <li>• Temperature is too low or too high.</li> <li>• Charging has gone on too long without completion (typically 8 hours).</li> </ul>
Fast blinking red (2 blinks/second)	Charging error but the battery is at end of useful life., for example: <ul style="list-style-type: none"> <li>• Temperature is too low or too high.</li> <li>• Charging has gone on too long without completion (typically 8 hours).</li> </ul>

## Charging Temperature

Charge batteries in temperatures from 5°C to 40°C (41°F to 104°F). The device or cradle always performs battery charging in a safe and intelligent manner. At higher temperatures (for example: approximately +37°C (+98°F)) the device or cradle may for small periods of time alternately enable and disable battery charging to keep the battery at acceptable temperatures. The device and cradle indicates when charging is disabled due to abnormal temperatures via its LED.

## 1-Slot Charge Only Cradle



**CAUTION:** Ensure that you follow the guidelines for battery safety described in [Battery Safety Guidelines](#) on page 171.

The 1-Slot Charge Only Cradle:

- Provides 5 VDC power for operating the device.
- Charges the device's battery.

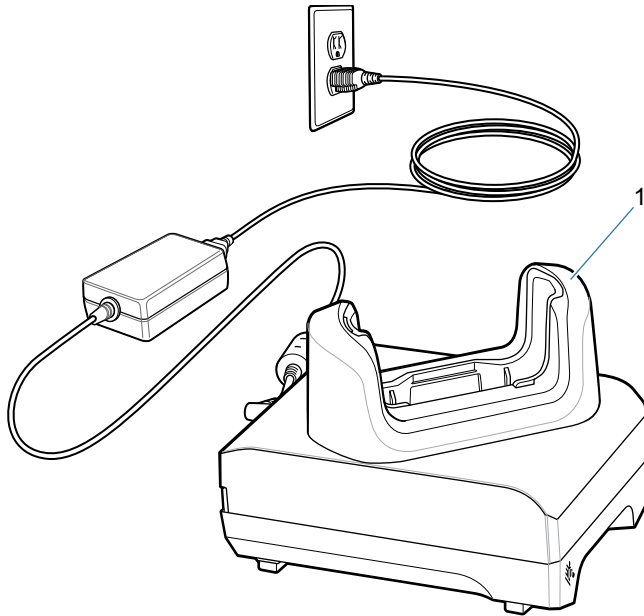

1	Charging slot
---	---------------

## 1-Slot Charge Only Cradle Setup

The 1-Slot Charge Only Cradle provides device charging.

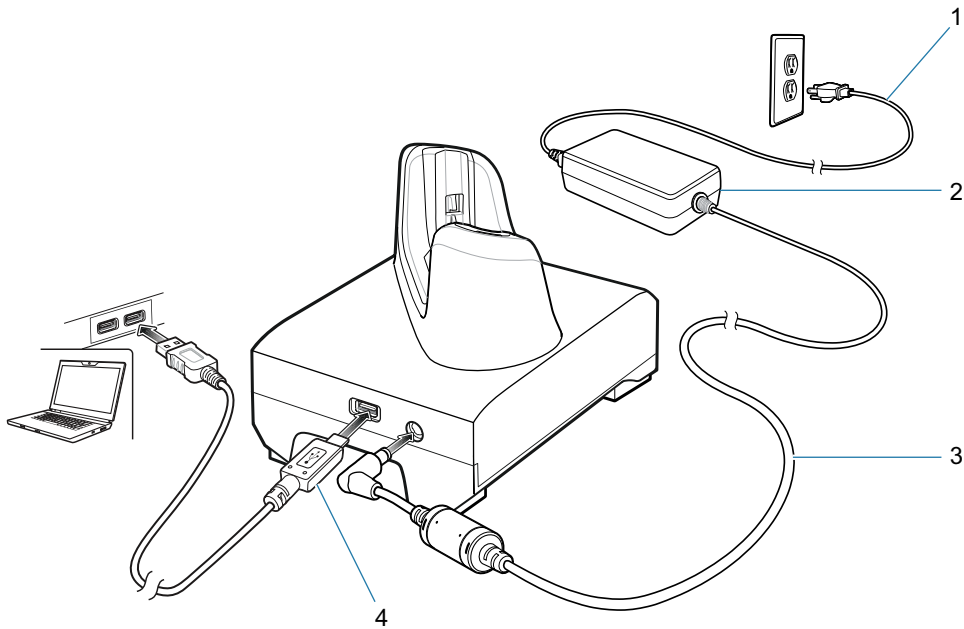

1	AC line cord
2	Power supply
3	DC line cord
4	USB cable

## Charging with the 1-Slot Charge Only Cradle

To charge a device:

1. Insert the device into the slot to begin charging.

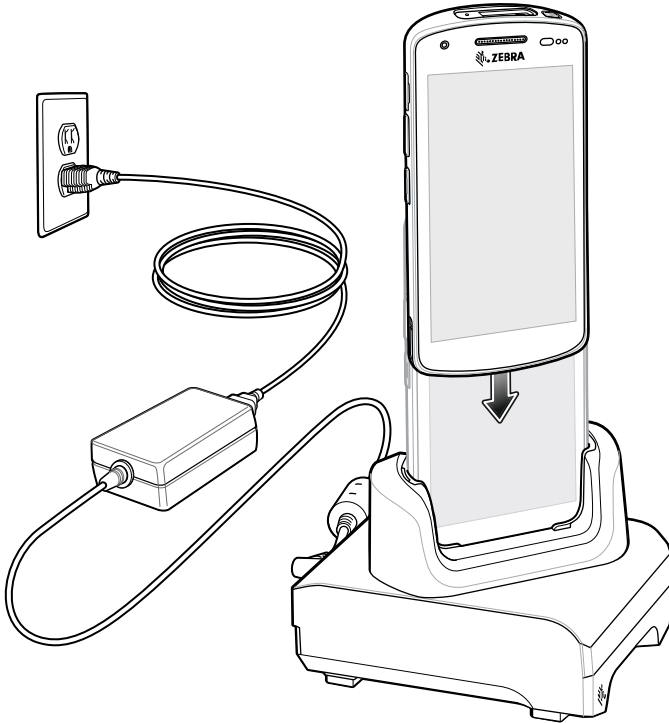

2. Ensure the device is seated properly.

## Removing the Insert from the Cup

Each cradle cup has an insert that must be removed prior to inserting a device with a rugged boot or extended battery. Remove the insert and then insert the device into the cup.

**Figure 13** Remove Insert from Cup

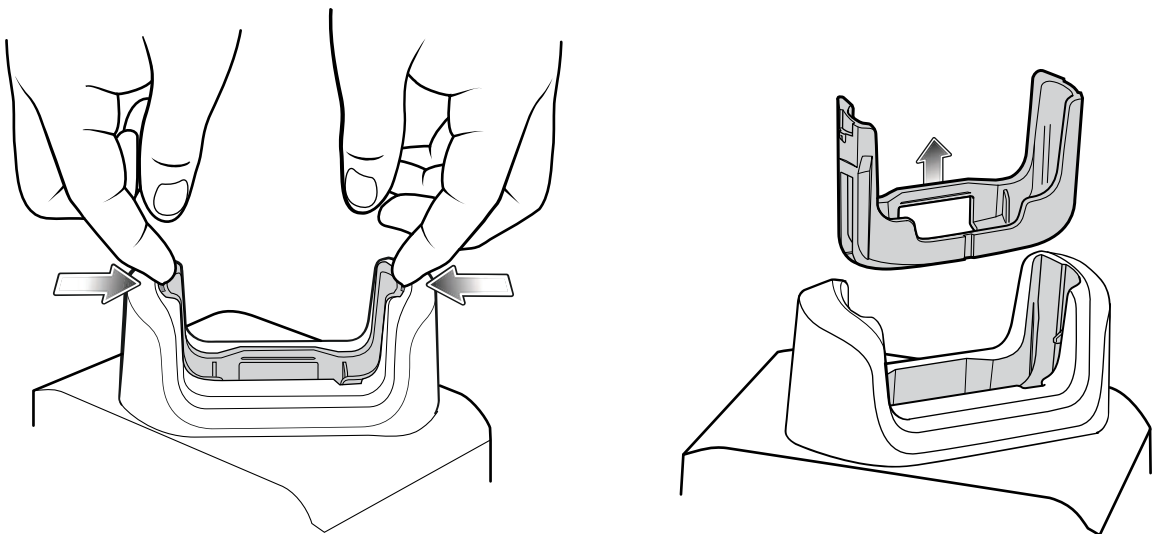

## 1-Slot USB/Ethernet Cradle



**CAUTION:** Ensure that you follow the guidelines for battery safety described in [Battery Safety Guidelines](#) on page 171.

The 1-Slot Ethernet Charge Cradle:

- Provides 5 VDC power for operating the device.
- Charges the device's battery.
- Provides USB communication with host computer.
- Provides Ethernet communication.

**Figure 14** Front View

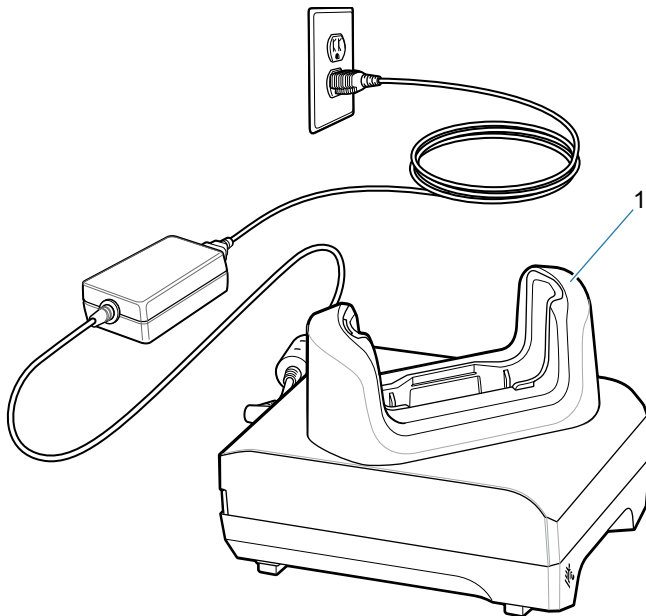

1	Charging slot
---	---------------

**Figure 15** Back View

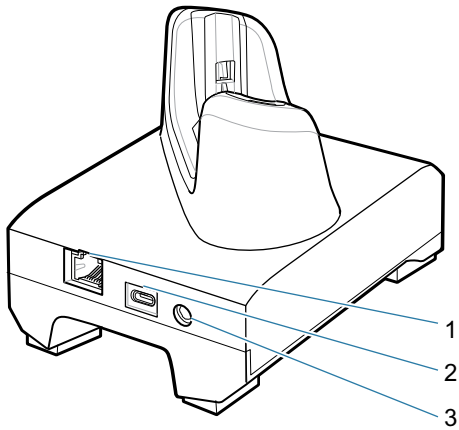

1	RJ-45 port
2	USB-C port
3	DC power port

## 1-Slot USB/Ethernet Cradle Setup

The 1-Slot USB/Ethernet Cradle provides device charging and communication.

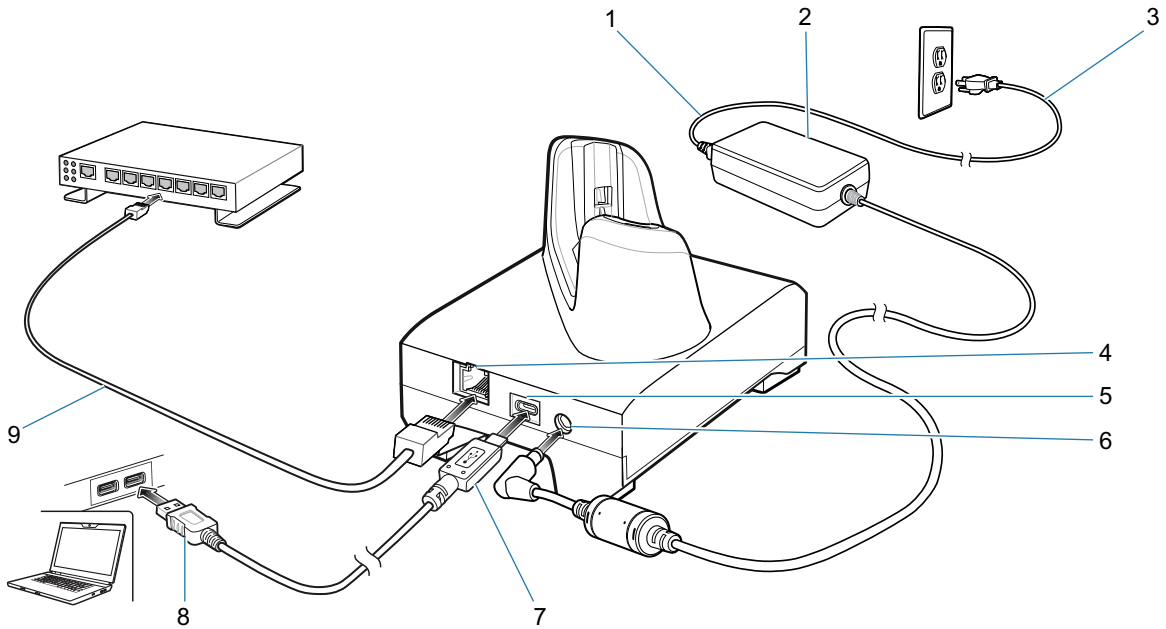

1	DC line cord
2	Power supply
3	AC Line cord
4	RJ-45 port
5	USB-C port
6	DC power port
7	USB-C connector
8	USB A connector
9	Ethernet cable

## Ethernet Communication

### Establishing Ethernet Connection

1. Go to **Settings**.
2. Touch **Network & internet > Ethernet**.
3. Slide the Ethernet switch to the **ON** position.
4. Insert the device into a slot.  
The **↔** icon appears in the Status bar.
5. Touch **Eth0** to view Ethernet connection details.

### Ethernet Settings

The following settings can be configured when using Ethernet communication:

- Proxy Settings
- Static IP.

## Configuring Ethernet Proxy Settings

The device includes Ethernet cradle drivers. After inserting the device, configure the Ethernet connection:

1. Go to **Settings**.
2. Touch **Network & internet > Ethernet**.
3. Slide the switch to the **ON** position.
4. Place the device into the Ethernet cradle slot.
5. Touch and hold **eth0** until the menu appears.
6. Touch **Modify Proxy**.
7. Touch the **Proxy** drop-down list and select **Manual**.
8. In the **Proxy hostname** field, enter the proxy server address.
9. In the **Proxy port** field, enter the proxy server port number.



**NOTE:** When entering proxy addresses in the Bypass proxy for field, do not use spaces or carriage returns between addresses.

10. In the **Bypass proxy for** text box, enter addresses for web sites that do not require to go through the proxy server. Use the separator “|” between addresses.
11. Touch **MODIFY**.
12. Touch the Home button.

## Configuring Ethernet Static IP Address

The device includes Ethernet cradle drivers. After inserting the device, configure the Ethernet connection:

1. Go to **Settings**.
2. Touch **Network & internet > Ethernet**.
3. Slide the switch to the **ON** position.
4. Place the device into the Ethernet cradle slot.
5. Touch **eth0**.
6. Touch **Disconnect**.
7. Touch **eth0**.
8. Touch the IP settings drop-down list and select **Static**.
9. In the **IP** address field, enter the proxy server address.
10. If required, in the **Gateway** field, enter a gateway address for the device.
11. If required, in the **Netmask** field, enter the network mask address
12. If required, in the **DNS** address fields, enter a Domain Name System (DNS) addresses.
13. Touch **CONNECT**.
14. Touch the Home button.



## Charging with the 1-Slot USB/Ethernet Cradle

To charge a device:

1. Insert the device into the slot to begin charging.

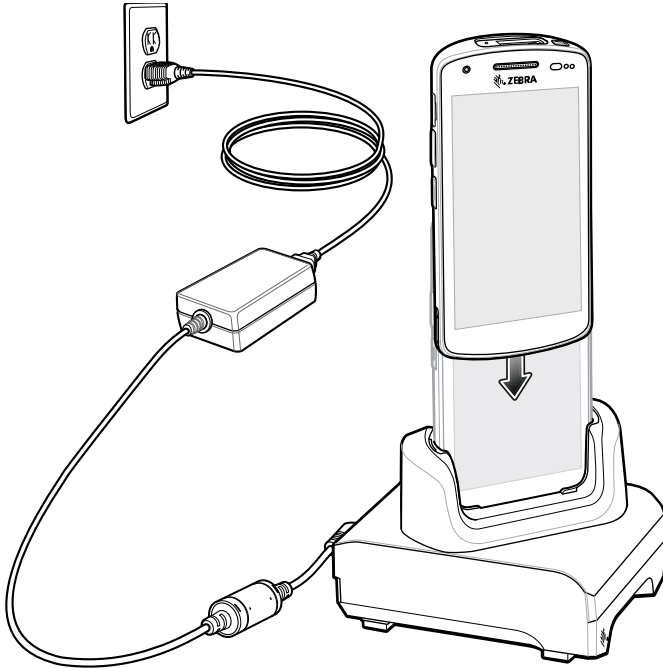

2. Ensure the device is seated properly.

## Removing the Insert from the Cup

Each cradle cup has an insert that must be removed prior to inserting a device with a rugged boot or extended battery. Remove the insert and then insert the device into the cup.

**Figure 16** Remove Insert from Cup

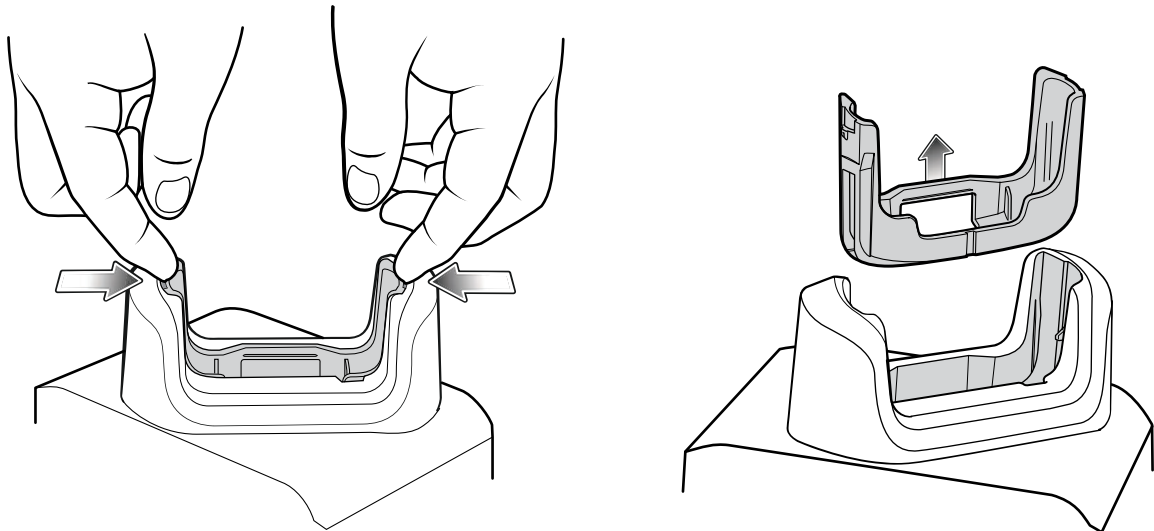

## 4-Slot Charge Only Cradle



**CAUTION:** Ensure that you follow the guidelines for battery safety described in [Battery Safety Guidelines](#) on page 171.

The 4-Slot Charge Only Cradle:

- Provides 4 VDC power for operating the device.
- Simultaneously charges up to four devices.

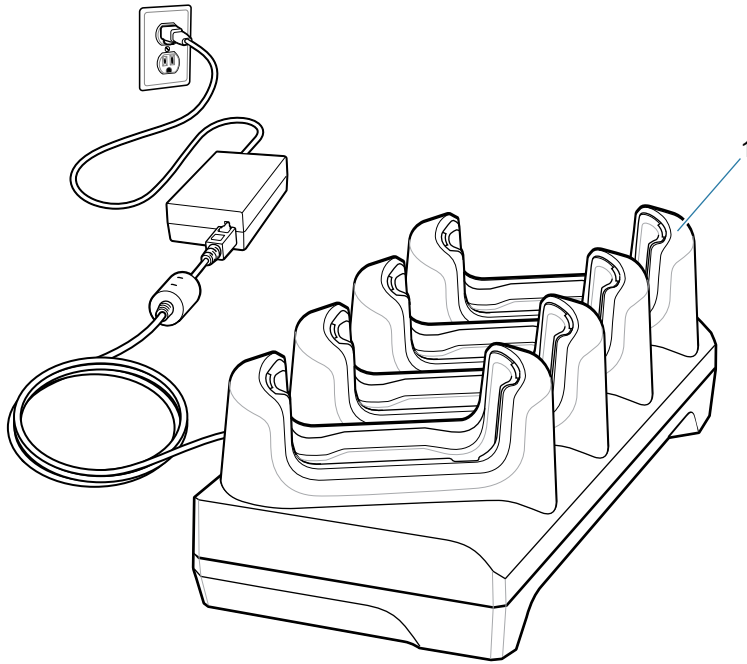

1	Charging slot
---	---------------

## 4-Slot Charge Only Cradle Setup

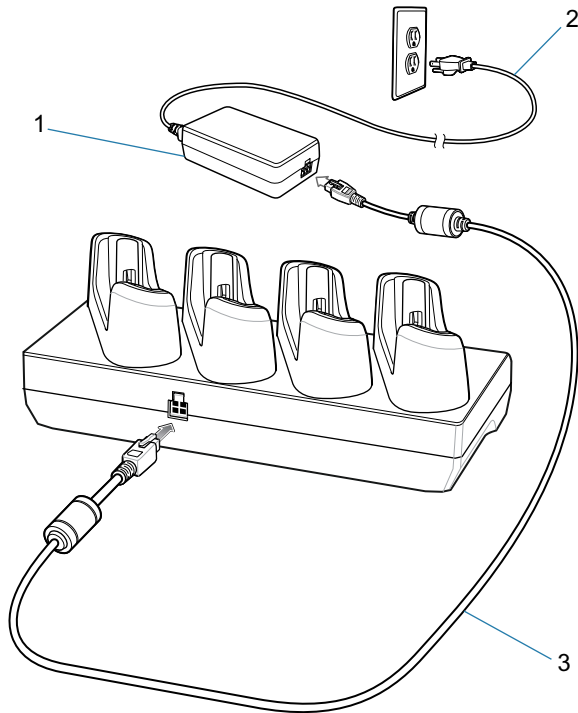

1	Power supply
2	AC Line cord
3	DC Line cord

## Charging with the 4-Slot Charge Only Cradle

To charge a device:

1. Insert the device into a slot to begin charging.

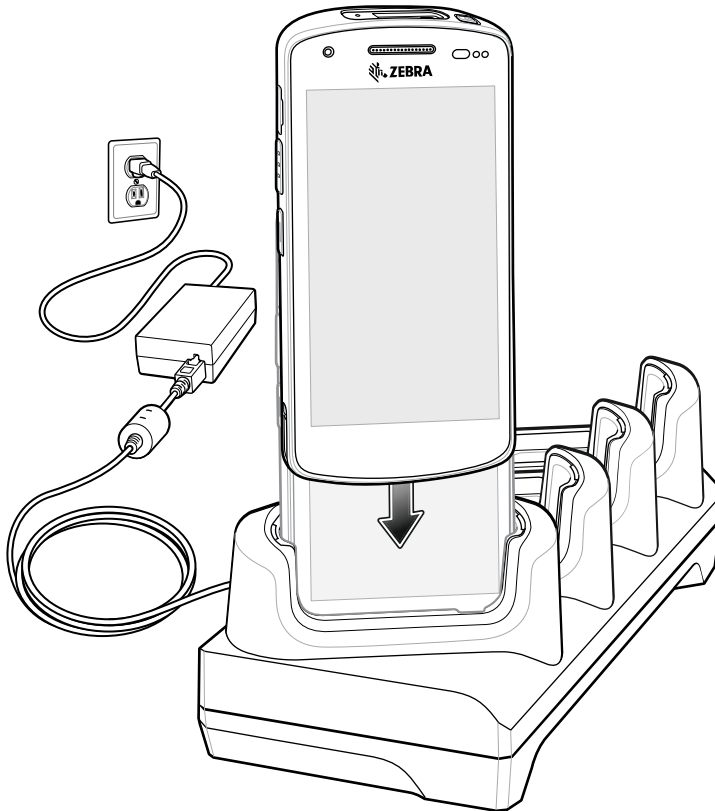

2. Ensure the device is seated properly.

## Removing the Insert from the Cup

Each cradle cup has an insert that must be removed prior to inserting a device with a rugged boot or extended battery. Remove the insert and then insert the device into the cup.

**Figure 17** Remove Insert from Cup

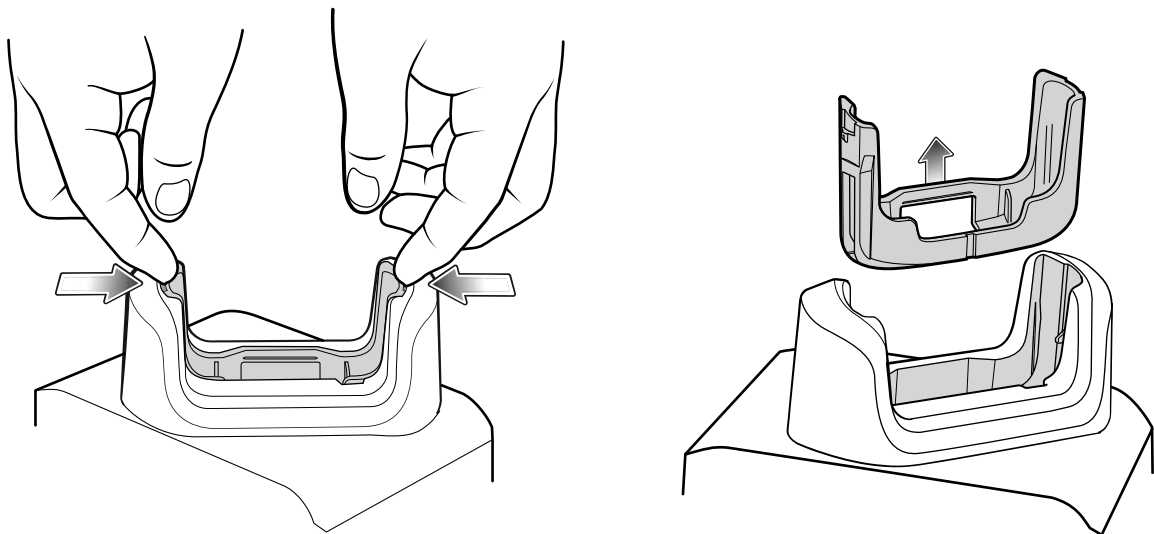

## 4-Slot Charge Only Locking Cradle



**NOTE:** Controlling the locking cradle is done through a software API. For more information, go to [techdocs.zebra.com](http://techdocs.zebra.com).

The 4-Slot Locking Charge Only Cradle:

- Provides 5 VDC for operating the cradle.
- Simultaneously charges up to four devices.
- Each slot contains an Indicator LED Insert with RGB LEDs.

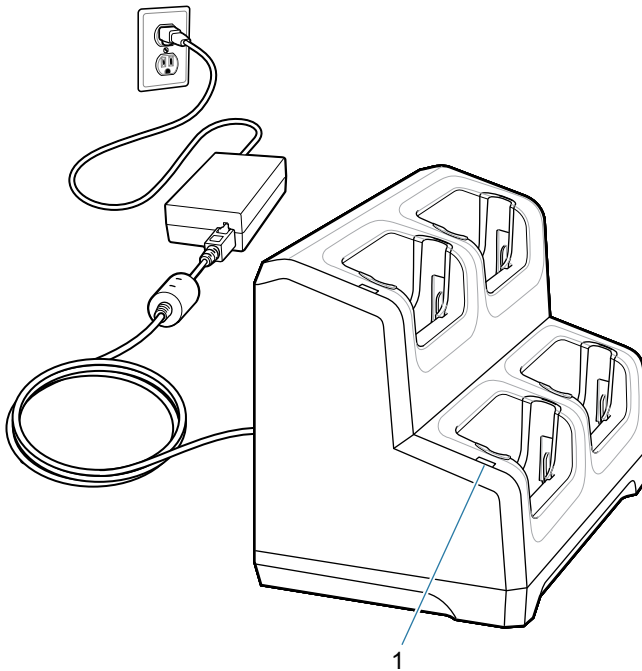

Item	Name	Description
1	Power LED	Indicates that power is applied to each cradle slot.

## Setup

**Figure 18** 4-Slot Locking Charge Only Cradle

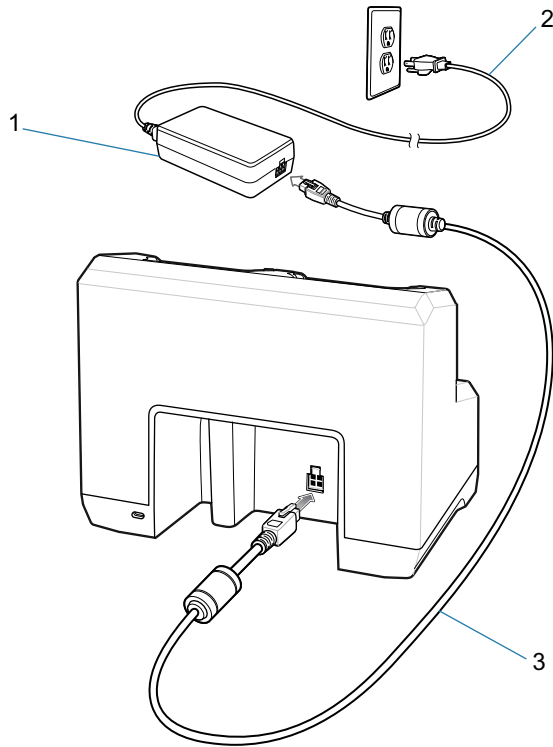

1	Power supply
2	AC Line cord
3	DC Line cord

## Charging the Device

To charge a device:

1. Insert the device into a slot to begin charging.

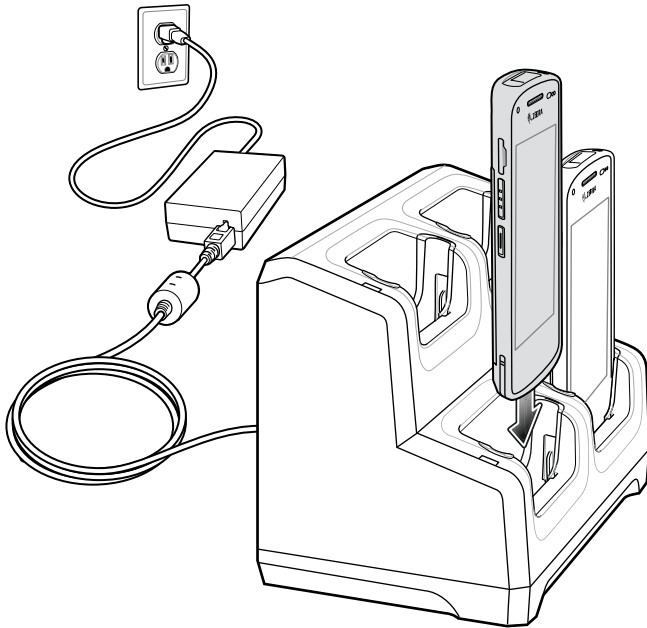

2. Ensure the device is seated properly.

## Removing the Insert from the Cup

Each cradle cup has an insert that must be removed prior to inserting a device with a rugged boot or extended battery. Remove the insert and then insert the device into the cup.

**Figure 19** Remove Insert from Cup

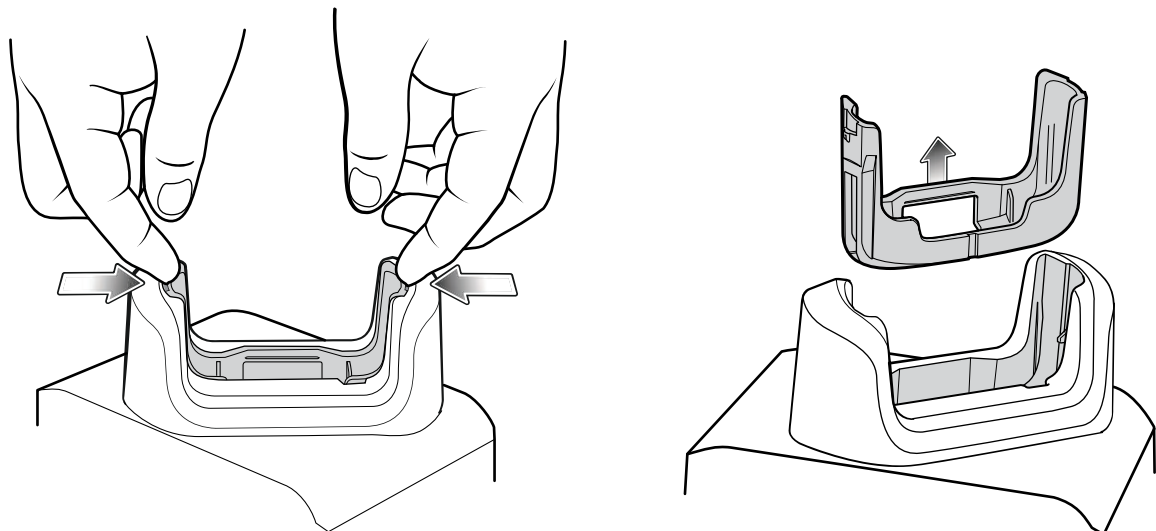

## Manual Release Using a Release Key

The 4-Slot Locking Charge Only Cradle contains a locking mechanism that locks the device inside the cradle when docked. If the device fails to unlock during normal operation, use a release key (KT-MC18-CKEY-20) to unlock the device.



**CAUTION:** Do not use any tool to unlock the cradle other than the tools described below. Failure to comply could result in damage to the cradle and void the warranty.

To release a locked device:

1. Insert the release key straight into the slot as shown below.
2. While pressing the release key all the way into the slot, remove the device from the cradle.

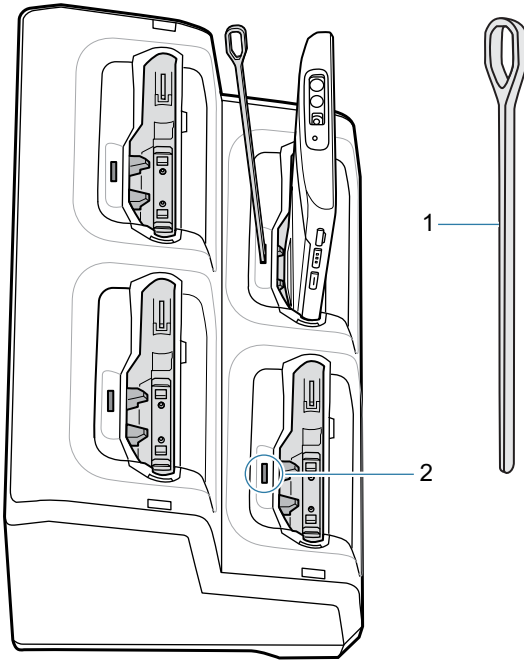

1	Release key
2	Release key slot



## 1-Slot Workstation Cradle



**CAUTION:** Ensure that you follow the guidelines for battery safety described in [Battery Safety Guidelines on page 171](#).

The 1-Slot Workstation Cradle is an enhanced single-slot charging cradle with additional ports for HDMI, Ethernet, and four USB ports that enable a device to be used as a workstation computer when connected to a HDMI monitor, keyboard and mouse.

The workstation cradle provides:

- 5 VDC power for operating the device.
- Three 0.5 A USB ports for USB devices (keyboard, mouse, USB scanner, etc.).
- One 1.5 A USB port for a USB device or for charging a personal mobile device.
- One HDMI port for connection to a monitor.



**NOTE:** If the user also wants audio support, they need to use a monitor that has speakers (audio through the HDMI connection).

If the user also wants to support a touch monitor, they need to use a monitor that supports touch inputs and connect the feature to one of the USB ports of the cradle.

- One Ethernet port for connection to a wired Ethernet network.

## 1-Slot Workstation Cradle Features

Figure 20 Front Left View

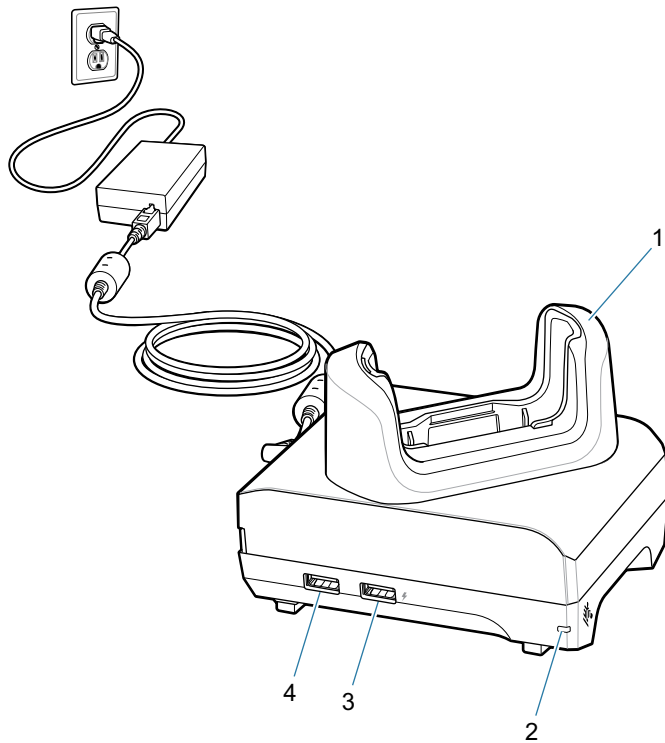

Item	Name	Description
1	Charging slot	Holds the device during charging.
2	Power LED	Indicates that power is applied to the cradle.
3	1.5 A USB port	USB Type A port for mouse or keyboard, or personal mobile device.
4	0.5 A USB port	USB Type A port for mouse or keyboard.

**Figure 21** Rear Right View

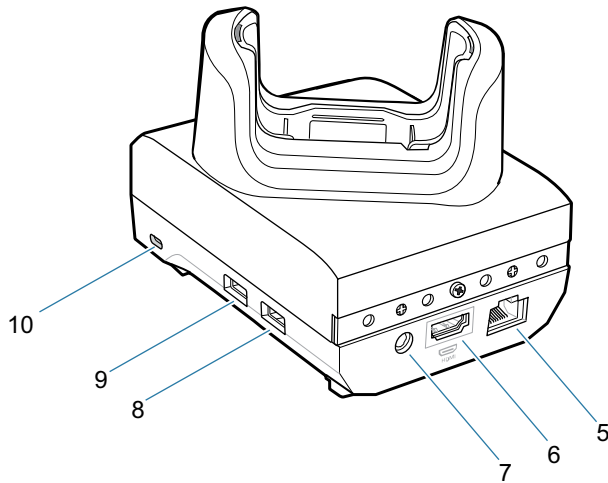

Item	Name	Description
5	Ethernet port	Connects to an Ethernet network.
6	HDMI port	Connects to monitor.
7	Power port	Provides power to the cradle.
8	USB Type A port	Connection for mouse or keyboard.
9	USB Type A port	Connection for mouse or keyboard.
10	Kensington slot	Connecting point for Kensington locking system to secure cradle.

## Setup

Figure 22 Workstation Cradle Setup

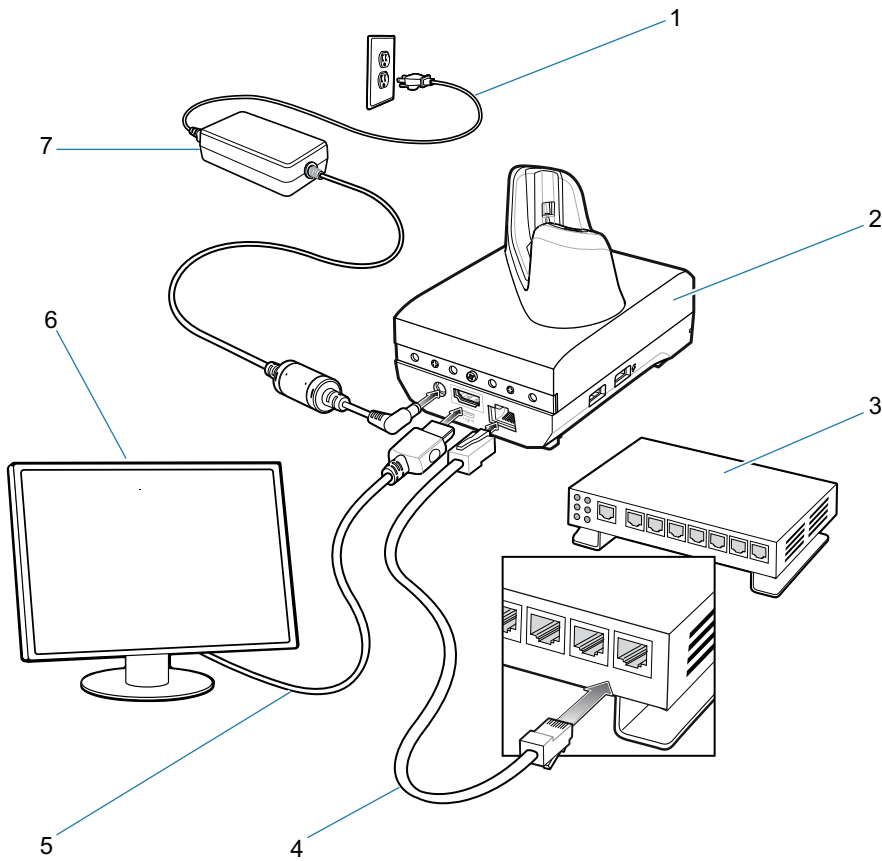

1	AC line cord
2	Cradle
3	Ethernet switch
4	Ethernet cable
5	HDMI cable
6	Monitor
7	Power supply

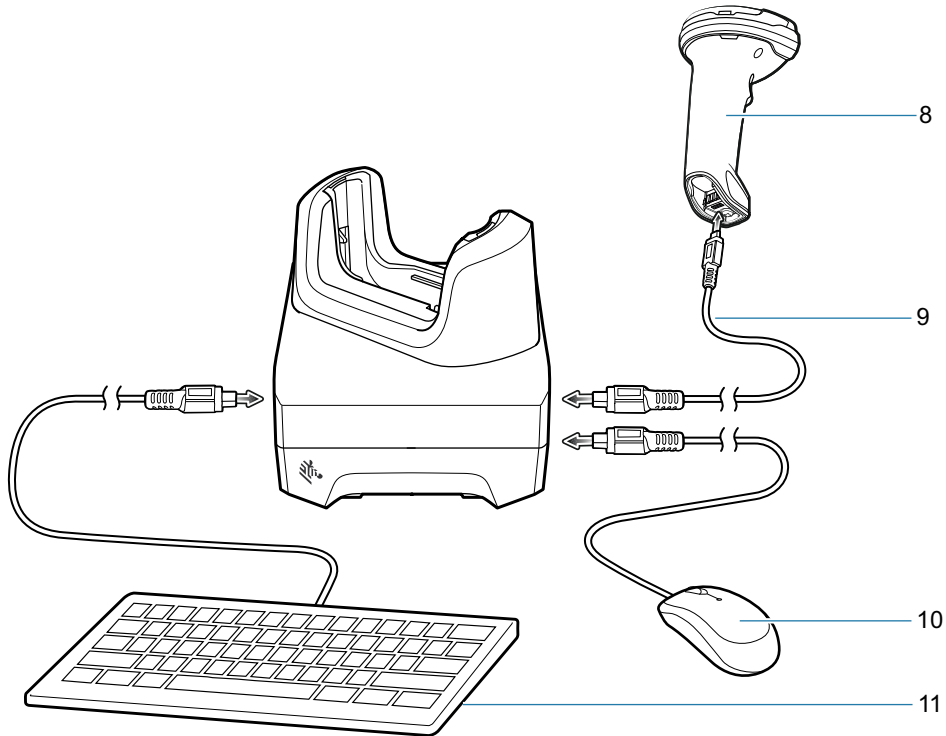

8	USB scanner
9	USB cable
10	USB mouse
11	USB keyboard

## Ethernet Communication

### Establishing Ethernet Connection

1. Go to **Settings**.
2. Touch **Network & internet > Ethernet**.
3. Slide the Ethernet switch to the **ON** position.
4. Insert the device into a slot.  
The **↔** icon appears in the Status bar.
5. Touch **Eth0** to view Ethernet connection details.

### Ethernet Settings

The following settings can be configured when using Ethernet communication:

- Proxy Settings
- Static IP.

### Configuring Ethernet Proxy Settings

The device includes Ethernet cradle drivers. After inserting the device, configure the Ethernet connection:

1. Go to **Settings**.
2. Touch **Network & internet > Ethernet**.
3. Slide the switch to the **ON** position.
4. Place the device into the Ethernet cradle slot.
5. Touch and hold **eth0** until the menu appears.
6. Touch **Modify Proxy**.
7. Touch the **Proxy** drop-down list and select **Manual**.
8. In the **Proxy hostname** field, enter the proxy server address.
9. In the **Proxy port** field, enter the proxy server port number.



**NOTE:** When entering proxy addresses in the Bypass proxy for field, do not use spaces or carriage returns between addresses.

10. In the **Bypass proxy for** text box, enter addresses for web sites that do not require to go through the proxy server. Use the separator “|” between addresses.
11. Touch **MODIFY**.
12. Touch the Home button.

## Configuring Ethernet Static IP Address

The device includes Ethernet cradle drivers. After inserting the device, configure the Ethernet connection:

1. Go to **Settings**.
2. Touch **Network & internet > Ethernet**.
3. Slide the switch to the **ON** position.
4. Place the device into the Ethernet cradle slot.
5. Touch **eth0**.
6. Touch **Disconnect**.
7. Touch **eth0**.
8. Touch the IP settings drop-down list and select **Static**.
9. In the **IP** address field, enter the proxy server address.
10. If required, in the **Gateway** field, enter a gateway address for the device.
11. If required, in the **Netmask** field, enter the network mask address
12. If required, in the **DNS** address fields, enter a Domain Name System (DNS) addresses.
13. Touch **CONNECT**.
14. Touch the Home button.

## Scanner Setup

The workstation cradle only supports a USB scanner in Human Interface Device (HID) mode. Refer to the scanner Product Reference Guide for information on configuring the scanner to HID mode.

## Bluetooth Device Setup

Bluetooth devices such as keyboard and mouse can be connected to the device. Follow Bluetooth instructions in the device User Guide for connecting these peripherals to the device.

## Security

The cradle provides a Kensington Slot to secure the cradle using a Kensington locking cable.

**Figure 23** Securing Cradle with Kensington Lock

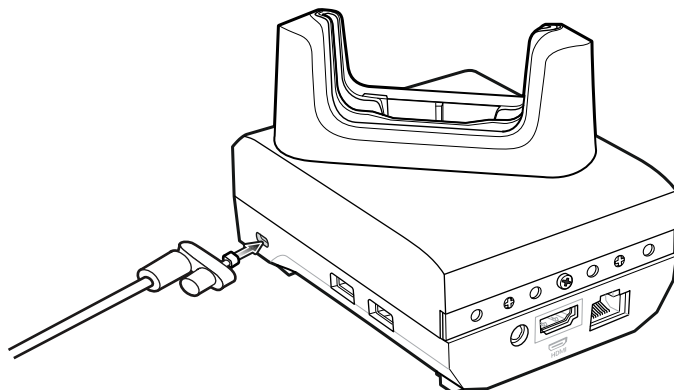

## Using the Workstation Cradle

Turn on the device.

1. Insert the device into the cradle.

The device screen automatically rotates and mirrors on the connected monitor.

## Changing Monitor Resolution

Screen resolution is automatically detected by the device when placed in the cradle. To manually change the external monitor screen resolution:

1. Go to **Settings > Display > External screen resolution**.
2. Select the a resolution for the attached monitor.
3. Insert the device into the cradle.

## Charging the Device

To charge a device:

1. Insert the device into the slot to begin charging.

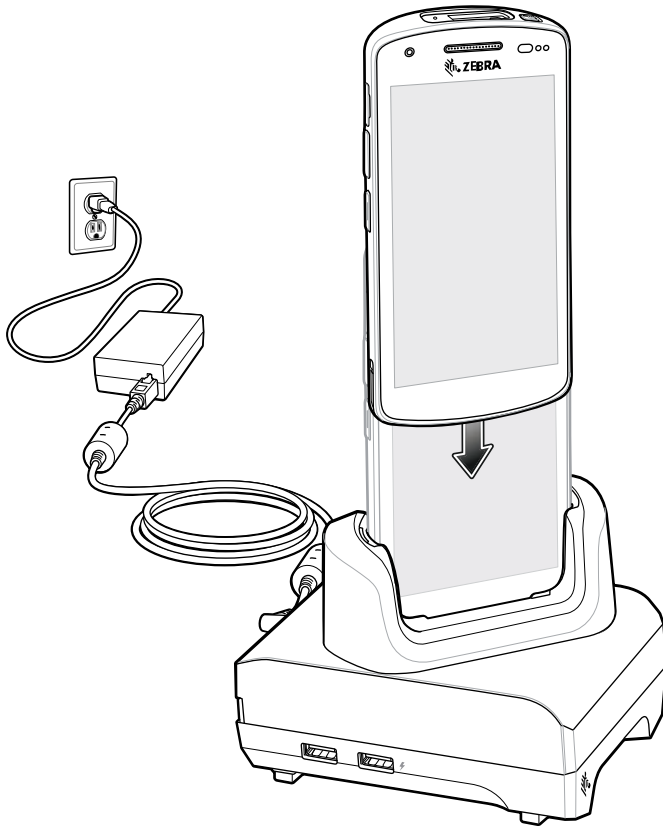

2. Ensure the device is seated properly.

## Removing the Insert from the Cup

Each cradle cup has an insert that must be removed prior to inserting a device with a rugged boot or extended battery. Remove the insert and then insert the device into the cup.

**Figure 24** Remove Insert from Cup

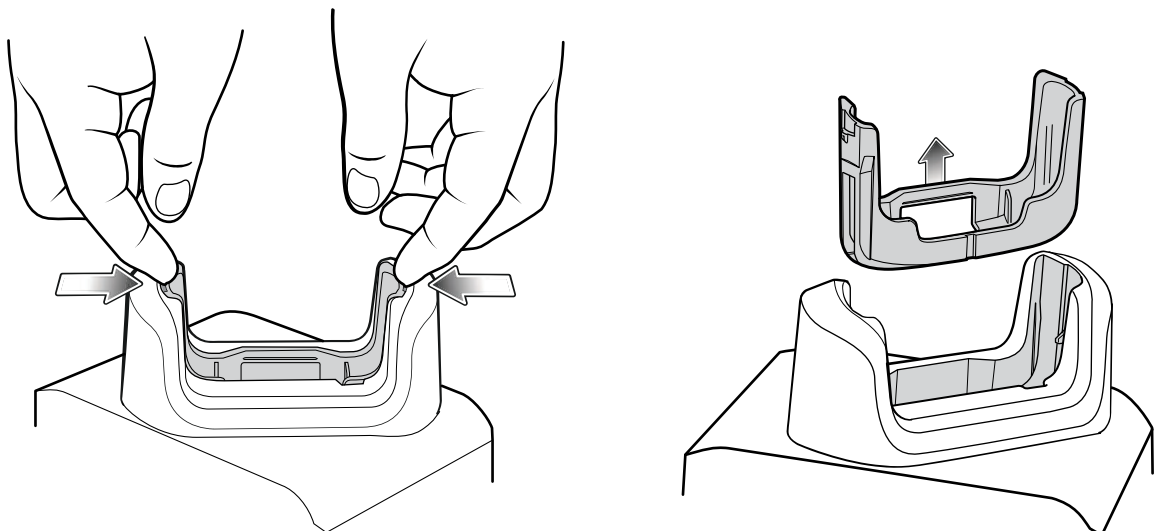



## 5-Slot Ethernet Cradle



**CAUTION:** Ensure that you follow the guidelines for battery safety described in [Battery Safety Guidelines](#) on page 190.

The 5-Slot Ethernet Cradle:

- Provides 5 VDC power for operating the device.
- Connects the device (up to five) to an Ethernet network.
- Simultaneously charges up to five devices.

**Figure 25** 5-Slot Ethernet Cradle

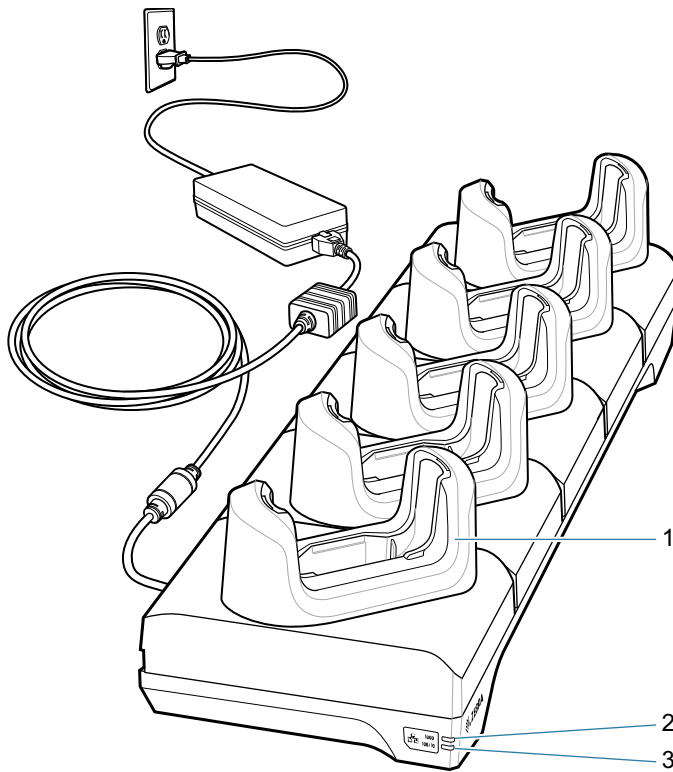

Item	Name	Description
1	Charging slot	Holds the device during charging.
2	1000 LED	Indicates 1 Gbps transfer rate.
3	100/10 LED	Indicates 100 or 10 Mbps transfer rate.

## 5-Slot Ethernet Cradle Setup

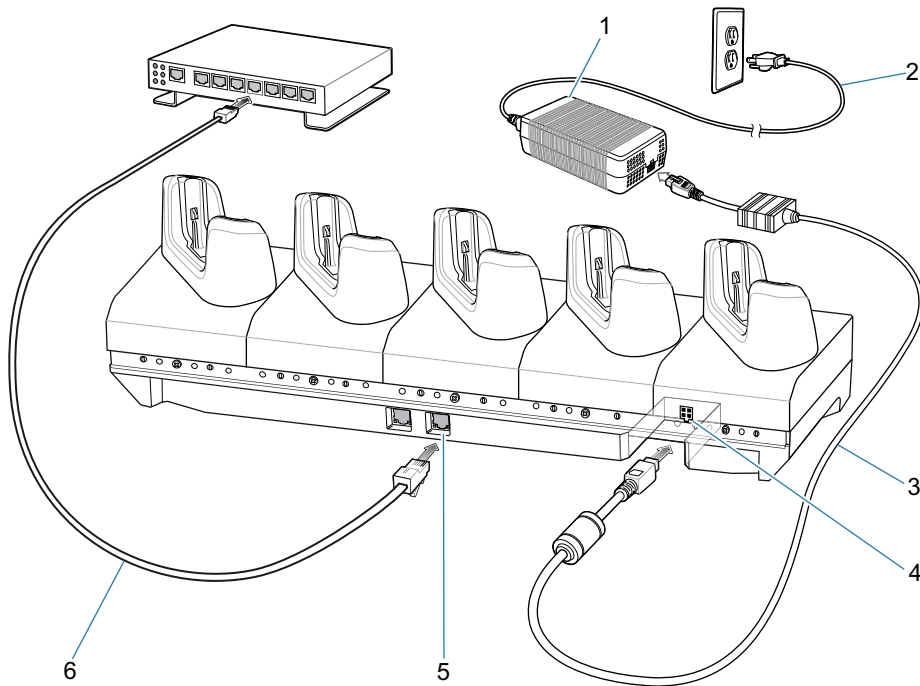

1	Power Supply
2	AC Line Cord
3	DC Line Cord
4	DC Power Port
5	RJ-45 Port
6	Ethernet Cable

## Daisy-chaining Ethernet Cradles

Daisy-chain up to ten 5-Slot Ethernet cradles to connect several cradles to an Ethernet network. Use either a straight or crossover cable. Daisy-chaining should not be attempted when the main Ethernet connection to the first cradle is 10 Mbps as throughput issues will almost certainly result.

To daisy-chain 5-Slot Ethernet cradles:

1. Connect power to each 5-Slot Ethernet cradle.
2. Connect an Ethernet cable to one of the ports on the switch and the other end to the to Primary Port of the first cradle.
3. Connect an Ethernet cable to the Secondary port of the first cradle.

4. Connect the other end of the Ethernet cable to the Primary port of the next 5-Slot Ethernet cradle.

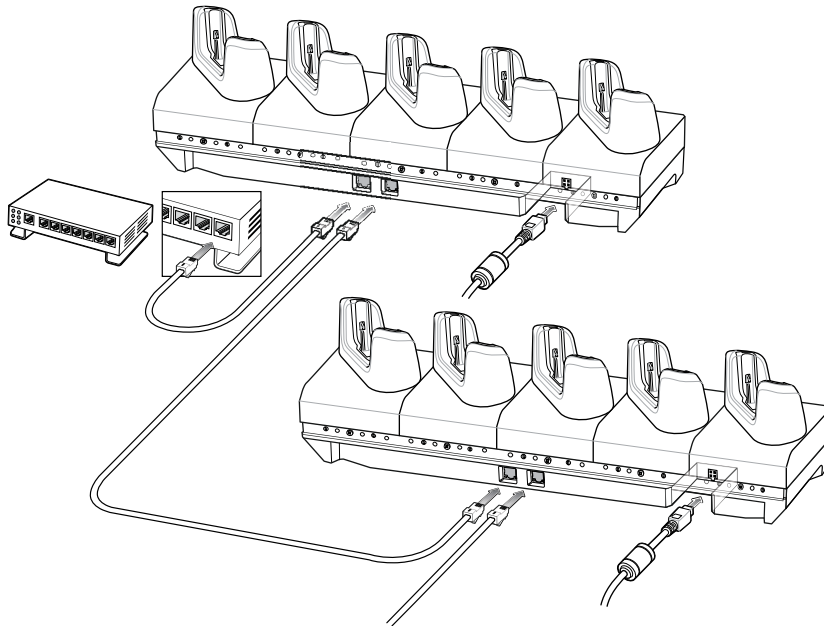

1	Primary Port
2	Secondary Port
3	To Switch
4	To Power Supply
5	To Next Cradle
6	To Power Supply

5. Connect additional cradles as described in step 3 and 4.

## Ethernet Communication

### Ethernet LED Indicators

There are two green LEDs on the side of the cradle. These green LEDs light and blink to indicate the data transfer rate.

**Table 18** LED Data Rate Indicators

Data Rate	1000 LED	100/10 LED
1 Gbps	On/Blink	Off
100 Mbps	Off	On/Blink
10 Mbps	Off	On/Blink

### Establishing Ethernet Connection

1. Go to **Settings**.
2. Touch **Network & internet > Ethernet**.

3. Slide the Ethernet switch to the **ON** position.
4. Insert the device into a slot.  
The  icon appears in the Status bar.
5. Touch **Eth0** to view Ethernet connection details.

## Ethernet Settings

The following settings can be configured when using Ethernet communication:

- Proxy Settings
- Static IP.

## Configuring Ethernet Proxy Settings

The device includes Ethernet cradle drivers. After inserting the device, configure the Ethernet connection:

1. Go to **Settings**.
2. Touch **Network & internet > Ethernet**.
3. Slide the switch to the **ON** position.
4. Place the device into the Ethernet cradle slot.
5. Touch and hold **eth0** until the menu appears.
6. Touch **Modify Proxy**.
7. Touch the **Proxy** drop-down list and select **Manual**.
8. In the **Proxy hostname** field, enter the proxy server address.
9. In the **Proxy port** field, enter the proxy server port number.



**NOTE:** When entering proxy addresses in the Bypass proxy for field, do not use spaces or carriage returns between addresses.

10. In the **Bypass proxy for** text box, enter addresses for web sites that do not require to go through the proxy server. Use the separator “|” between addresses.
11. Touch **MODIFY**.
12. Touch the Home button.

## Configuring Ethernet Static IP Address

The device includes Ethernet cradle drivers. After inserting the device, configure the Ethernet connection:

1. Go to **Settings**.
2. Touch **Network & internet > Ethernet**.
3. Slide the switch to the **ON** position.
4. Place the device into the Ethernet cradle slot.
5. Touch **eth0**.
6. Touch **Disconnect**.
7. Touch **eth0**.
8. Touch the IP settings drop-down list and select **Static**.
9. In the **IP** address field, enter the proxy server address.

10. If required, in the **Gateway** field, enter a gateway address for the device.
11. If required, in the **Netmask** field, enter the network mask address
12. If required, in the **DNS** address fields, enter a Domain Name System (DNS) addresses.
13. Touch **CONNECT**.
14. Touch the Home button.

### Charging the Device

To charge a device:

1. Insert the device into the slot to begin charging.

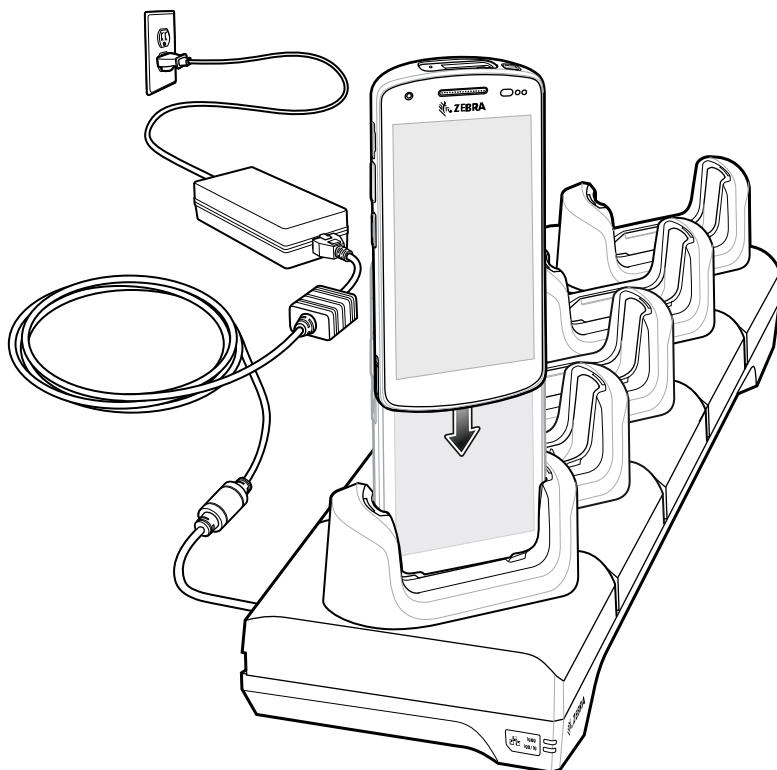

2. Ensure the device is seated properly.

### Removing the Insert from the Cup

Each cradle cup has an insert that must be removed prior to inserting a device with a rugged boot or extended battery. Remove the insert and then insert the device into the cup.

**Figure 26** Remove Insert from Cup

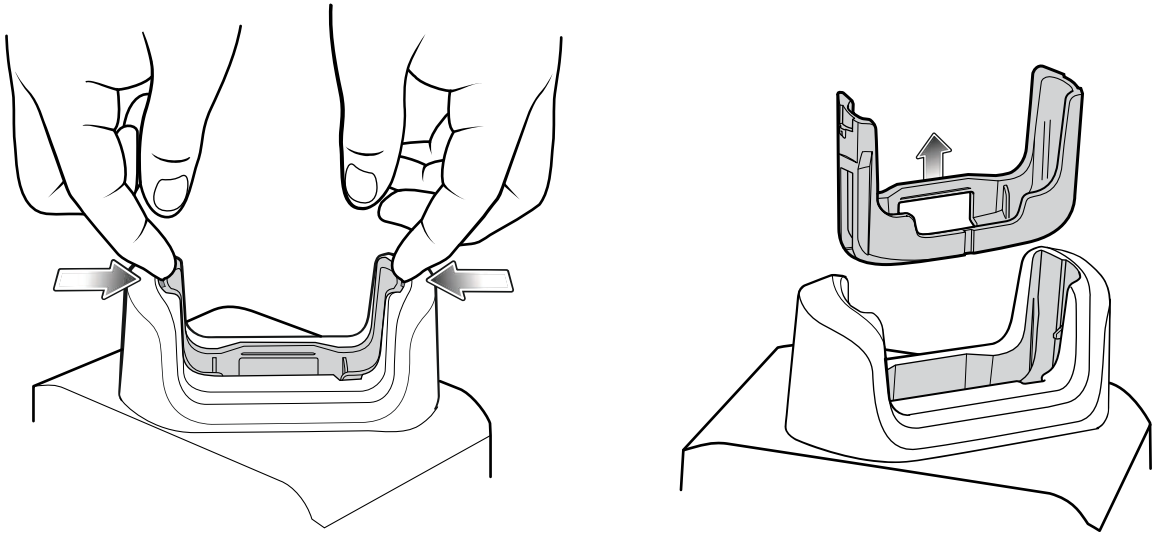

## Rugged Boot

The Rugged Boot provides additional protection for the device.

### Installation

To install the Rugged Boot:

1. Remove the rubber insert from plastic shell.

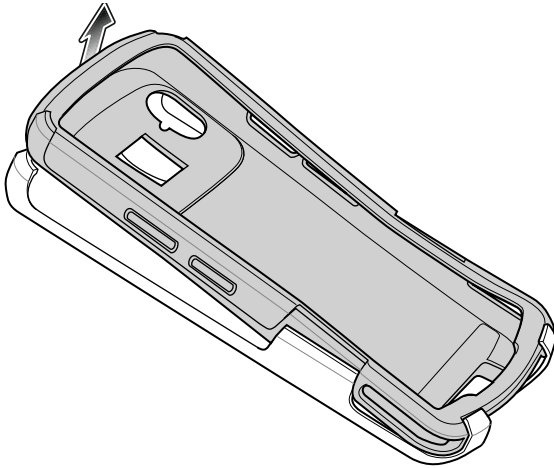

2. Insert the bottom of the device into the bottom of the boot.
3. Lift the top of the Rugged Boot over the top of the device.

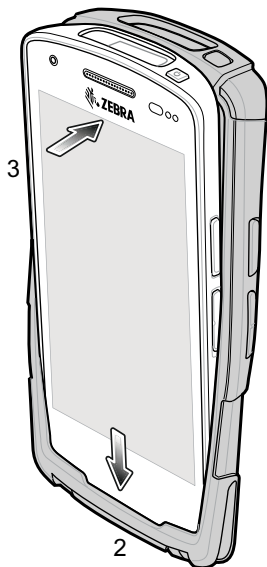

4. Insert the bottom of the device with rubber insert into the bottom of the plastic shell.

5. Push the top of the device with rubber insert into the top of the plastic shell.

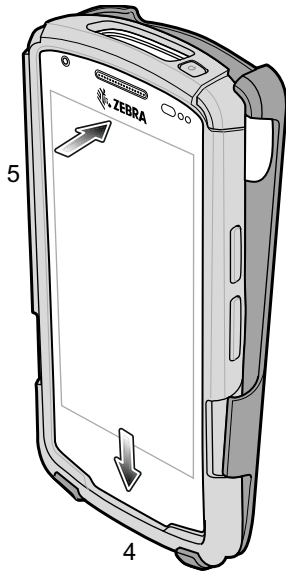



## Hand Strap



**NOTE:** Requires rugged boot.

The hand strap provides securing when holding the device.

To install the hand strap on the device:

1. Feed the top and bottom ends of the hand strap through the slots at the top and bottom of the rugged boot.

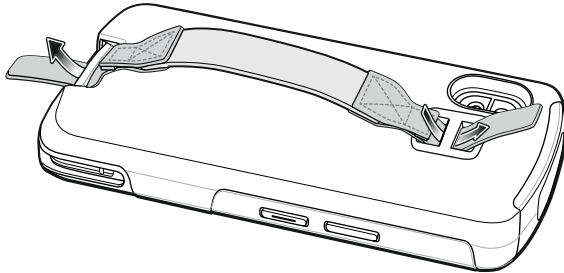

2. Pull the ends of the hand strap through the slots.
3. Press the hook material against the loop material on both ends of the hand strap.

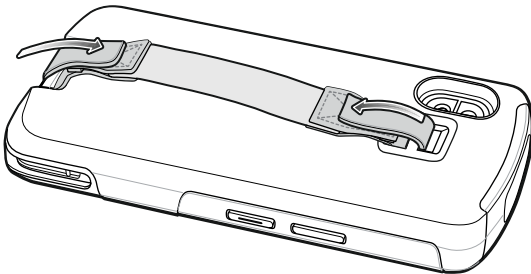

4. Place hand between device and hand strap and adjust hand strap as necessary.

When adjusting the hand strap, do not pull the loop material too far through the slots.

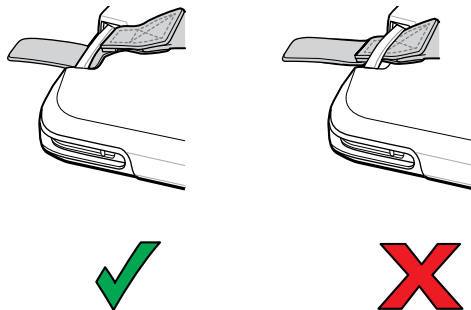

## Soft Holster

Use the soft holster to securely hold the device on a belt for easy access. The holster has an adjustable belt for securing the device or trigger handle.

### Adjusting the Holster

The holster has an adjustable belt that securely holds the device or Trigger Handle. Pull the belt tight to secure the device. Loosen the belt for a device with the extended battery.

- Insert the device into the holster with the device exit window facing down and the display against the body.

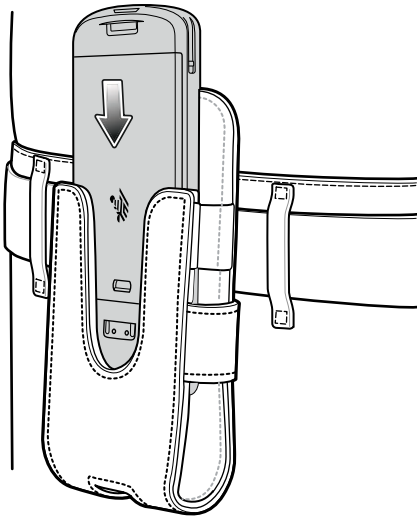

- Insert the Trigger Handle into the holster with the device exit window facing down.

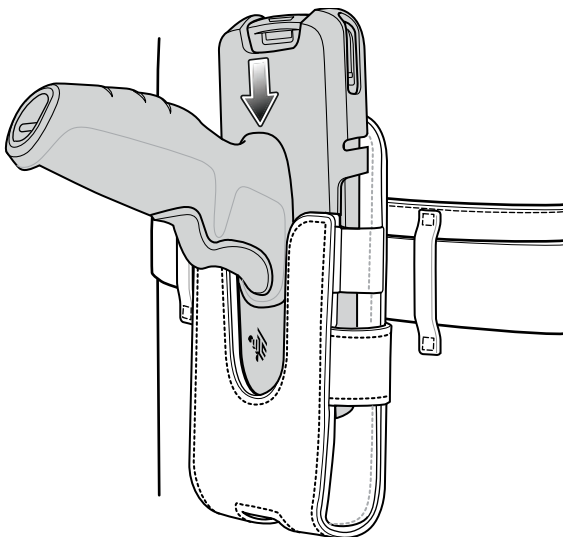

## Tethered Coil

Use the tethered coil to tether the device to a garment.

1. Feed the fabric end of the tethered coil through the slot on the bottom of the device.

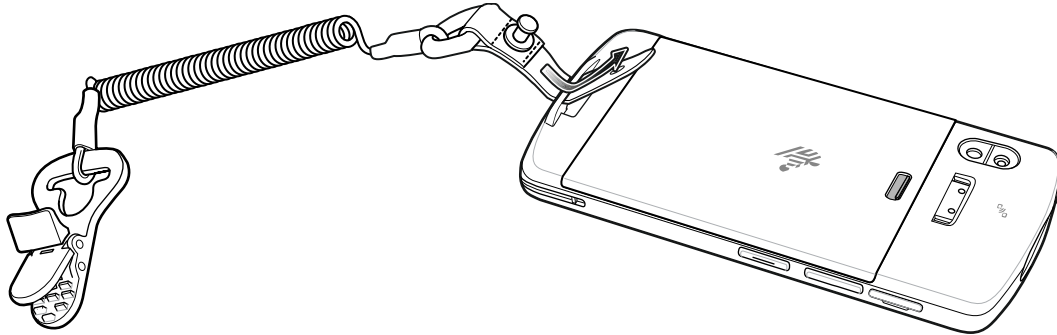

2. Push the metal stud through the hole on the end of the fabric.

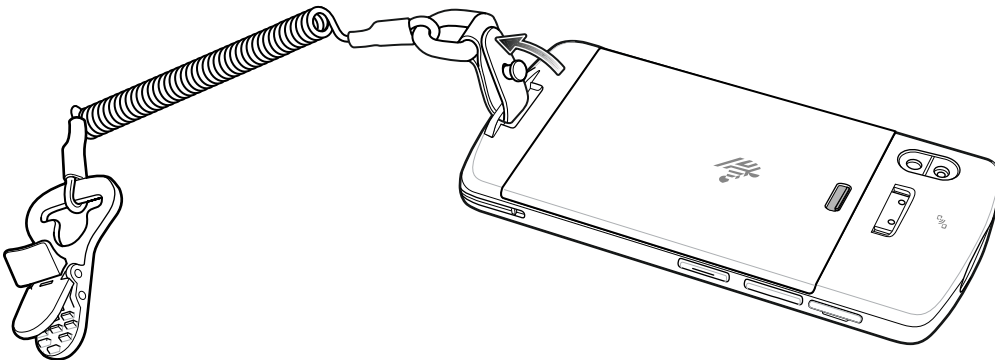

3. Attach the clip to a garment.

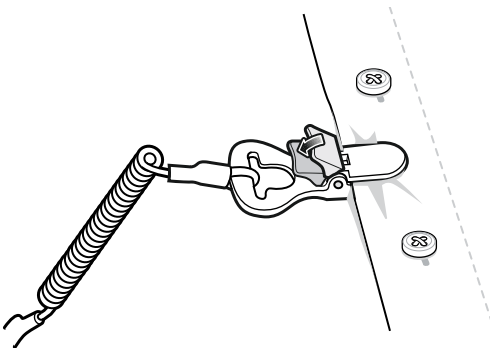

4. When the device is not in use, insert the device into the soft holster with the device exit window facing down and the display against the body.

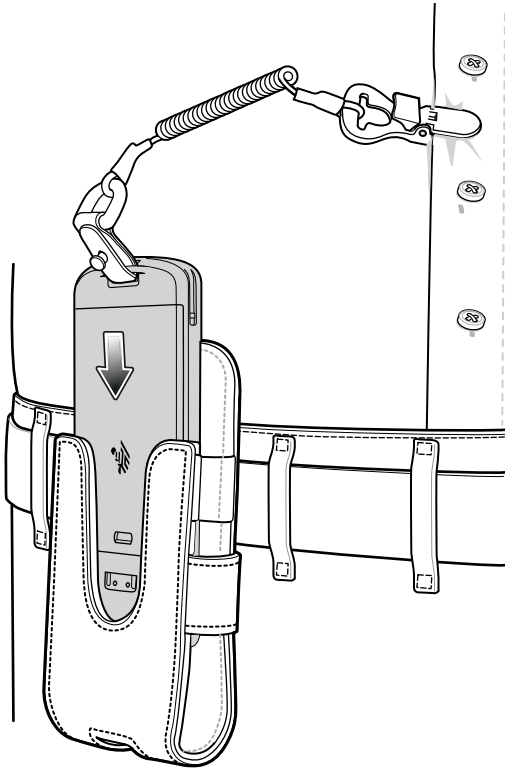

## 3.5 mm Audio Adapter

The 3.5 mm Audio Adapter connects a wired headset with a collared 3.5 mm plug. If using the 3.5 mm Audio Adapter with a mono headset (for example, HS2100), then audio only plays in the left channel. To combine the channels when playing audio, go to **Settings > Accessibility** and select **Mono audio**.

1. Connect the USB-C plug of the 3.5 mm Audio Adapter to the USB connector on the bottom of the device.

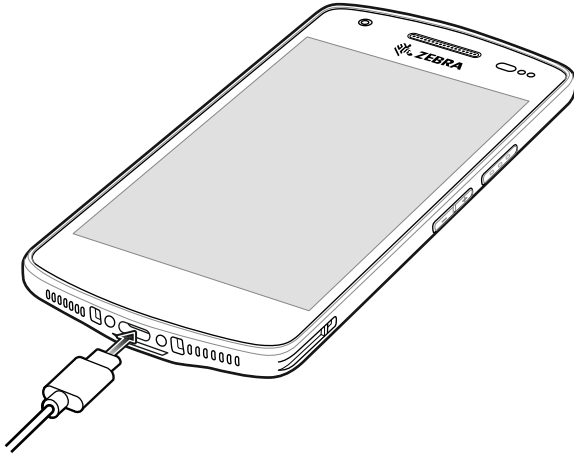

2. Connect the 3.5 mm connector plug of the headset into the 3.5 mm Audio Adapter.

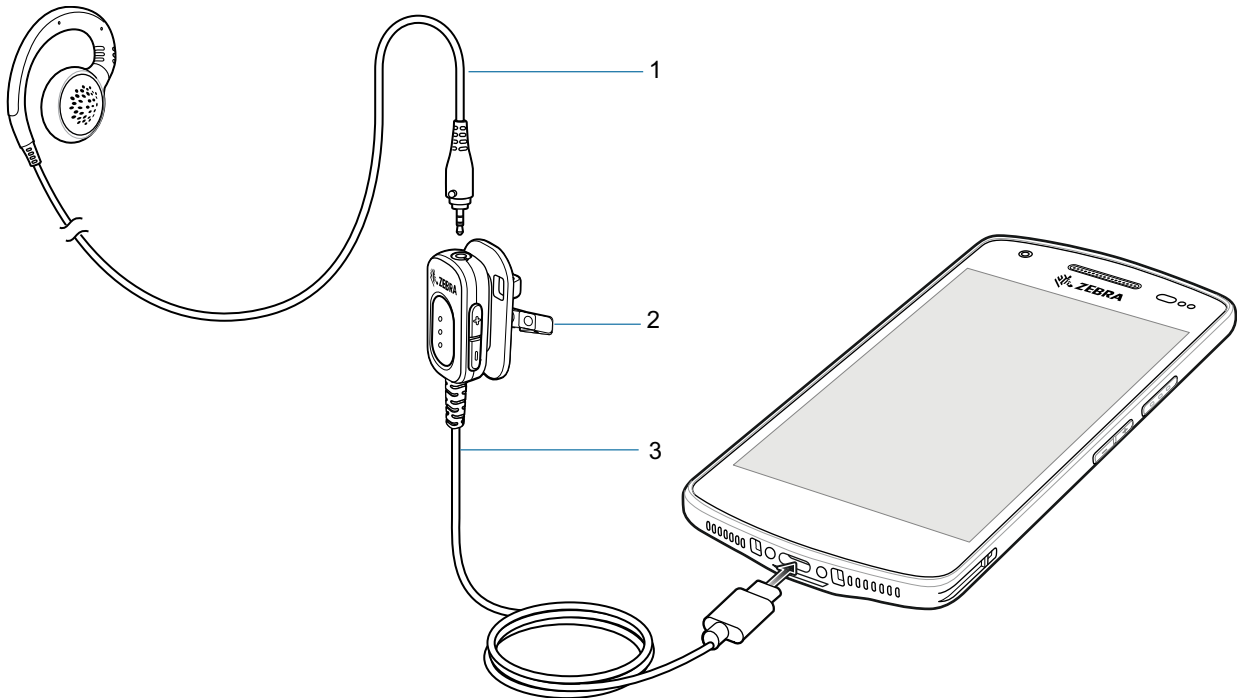

1	3.5 mm wired headset
2	Clip
3	3.5 mm audio adapter

3. Use the clip to secure the adapter to clothing.

## USB Cable

The USB cable plugs into the bottom of the device. When attached to the device the cable allows charging, transferring data to a host computer, and connecting USB peripherals.

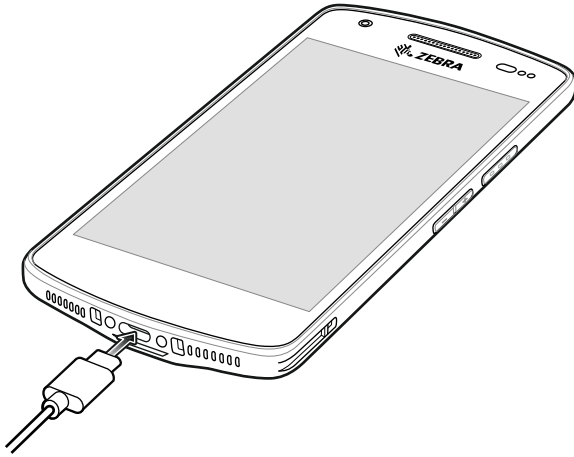

## USB Communication

To connect the device to a host computer:

1. Connect the USB cable to the device.
2. Connect the USB connector of the cable to a host computer.

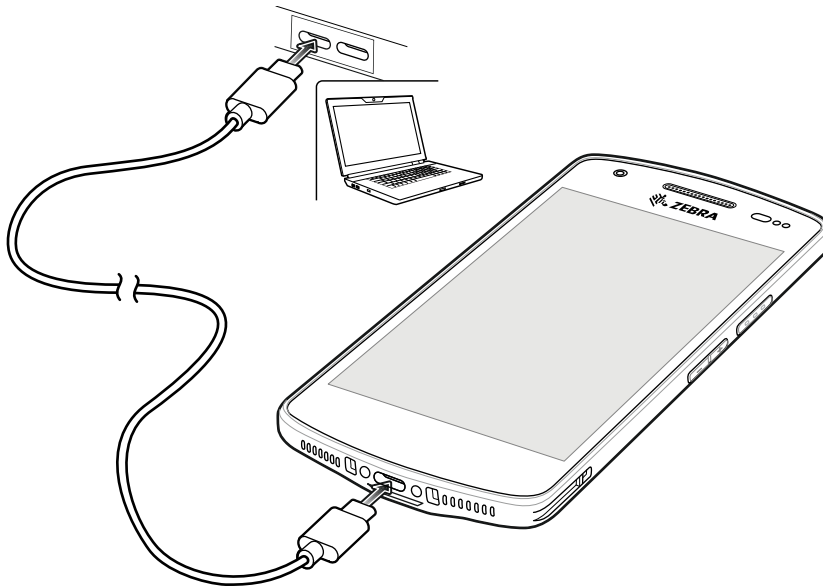

## Charging the Device

To charge the device using the USB cable:

1. Connect the USB cable to the device.
2. Connect the USB connector of the power supply.

3. Plug to power supply into an power outlet.

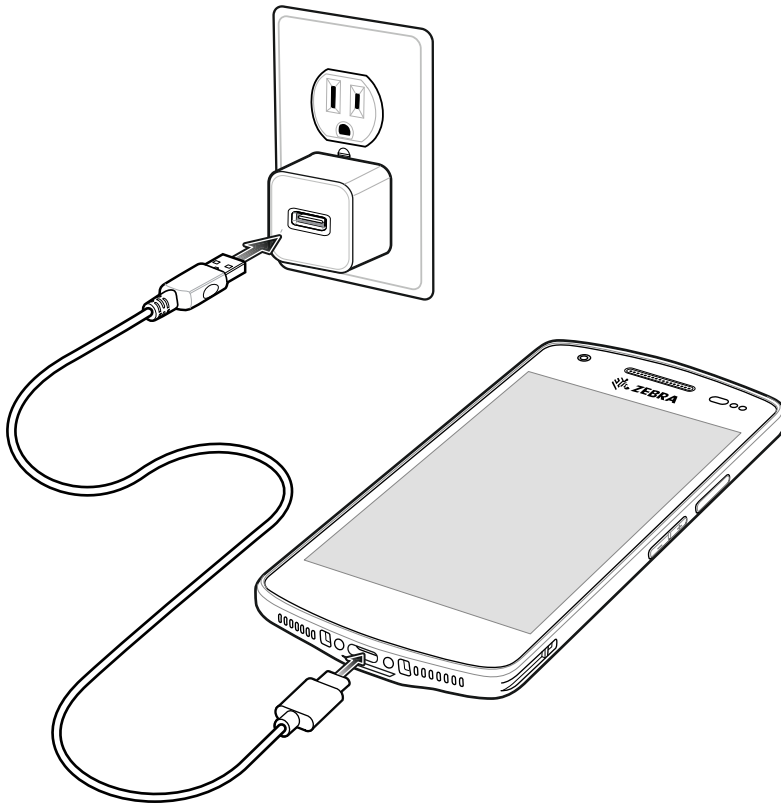

## Trigger Handle

The Trigger Handle adds a gun-style handle with a scanning trigger to the device. It increases comfort when using the device in scan-intensive applications for extended periods of time.

**Figure 27** Trigger Handle

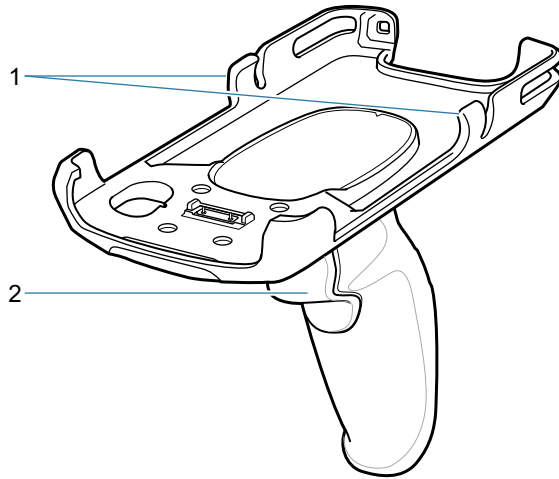

1	Release tabs
2	Trigger

### Inserting the Device into the Trigger Handle

To install the device onto the Trigger handle:

1. Align and insert the top of the device into the front of the Trigger Handle.





2. Rotate the device down and press down until it snaps into place.



## Removing the Device from the Trigger Handle

To remove the device from the Trigger Handle:

1. Press Trigger Handle release latches.

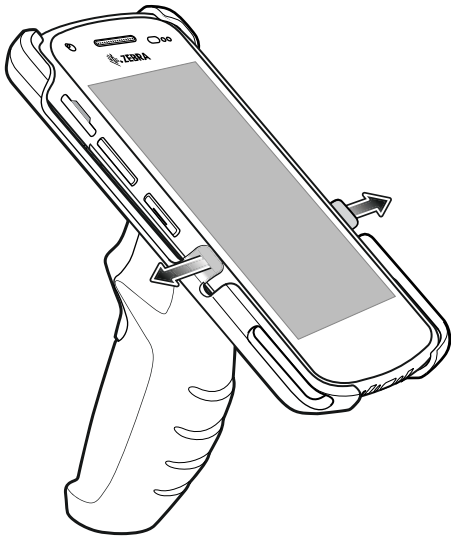

2. Rotate the bottom of the device up.

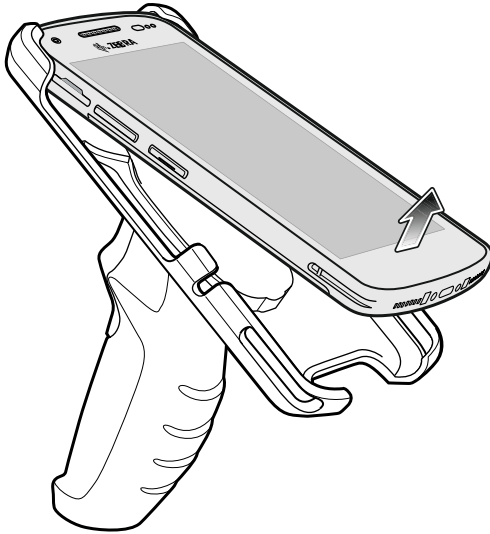

## Vehicle Holder

Install the vehicle holder on a surface of your vehicle that is flat and free of dirt and oil. Clean the mounting surface with a glass cleaner and a clean cotton cloth. Install the vehicle holder on the windshield or other flat car surface using the supplied disc.

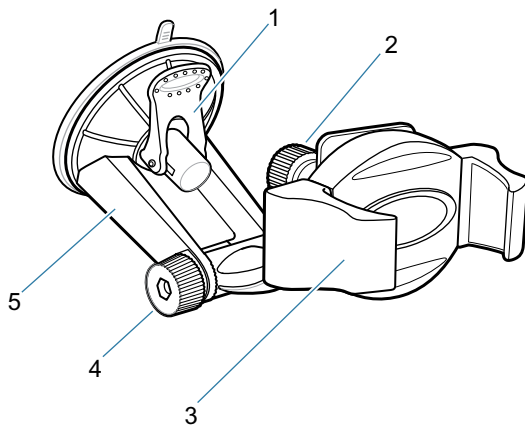

1	Mount Lever
2	Holder Knob
3	Holder
4	Mount Knob
5	Mount

## Assembling the Mount

1. Remove all parts from plastic bags.

2. Secure the mount to the holder with four M4 screws as shown.

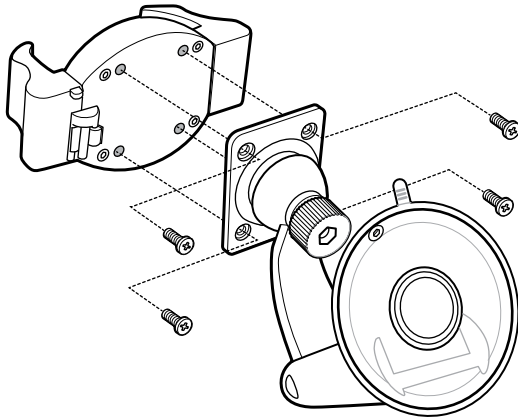

## Installing on the Windshield

To install the vehicle holder on the windshield:

1. Fix the suction cup mount to the selected area with the suction lever facing up.

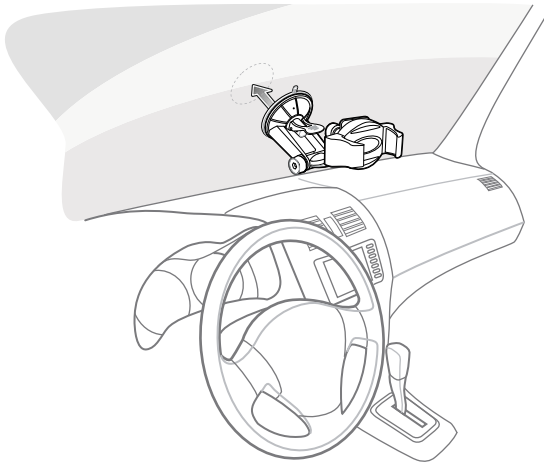

2. Push the lever towards the base to create a vacuum between the suction cup and the windshield.

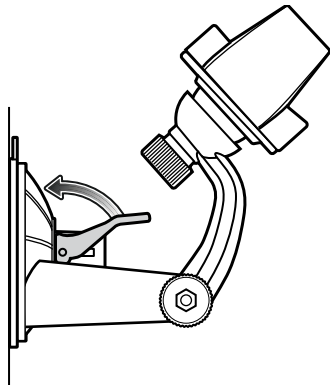

3. Make sure that the suction bond is strong enough before installing the device.

## Installing the Dash Mount

To install the cradle on the dashboard:

1. Install the disc using the instructions provided with the disc.
2. Remove protective plastic from top of disc.
3. Fix the suction cup mount to the disc with the suction lever facing you.

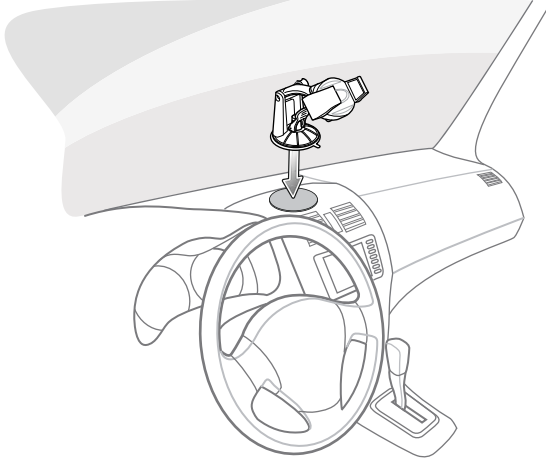

4. Push the lever towards the base to create a vacuum between the suction cup and the disc.
5. Make sure that the suction bond is strong enough before installing the device.

## Installing the Device

To install the device into the vehicle holder:



**NOTE:** The vehicle holder accommodates the device with or without the Boot.

Do not leave the device in direct sunlight for a long period of time as it may cause the device to exceed proper operating temperature.

1. Place one side of device into the vehicle holder and push to expand the holder.

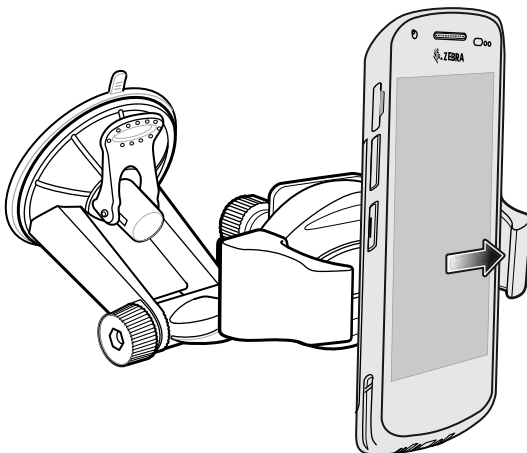

2. Rotate the other side of the device into the holder and gently release to collapse the holder and secure the device.

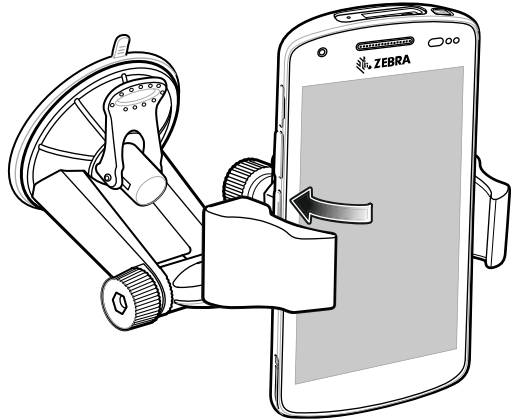

3. Loosen the mount and holder knobs and adjust the device for best viewing.
4. Tighten the knobs to lock the holder and mount in place.

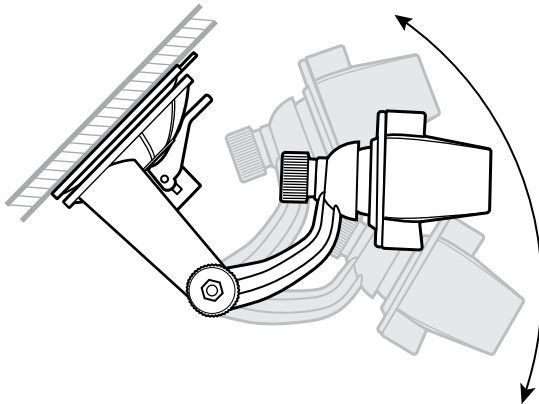

### Removing the Device

To remove the device from the cradle:

1. Push the device to one side of the holder to expand the holder.
2. Rotate the device out of the holder.

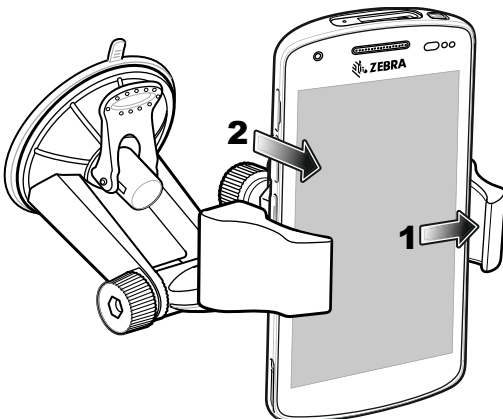

## 5-Slot Cradle Rack Installation



**NOTE:** 5-Slot Ethernet Cradle Only

Use the Rack/Wall Mount Bracket to mount a 5-slot cradle on a rack. When installing on a rack, first assemble the bracket and cradles/chargers and then install the assembly on the rack.



**NOTE:** Ensure tie wrap buckle is on side of power supply. Tie wrap buckle on top of power supply interferes with top tray.

1. Place the power supply in bottom tray.
2. Connect AC line cord to power supply.
3. Connect DC line cord to power supply.
4. Secure power supply and cables to bottom tray with tie wraps.
5. Route cables through cable slots.

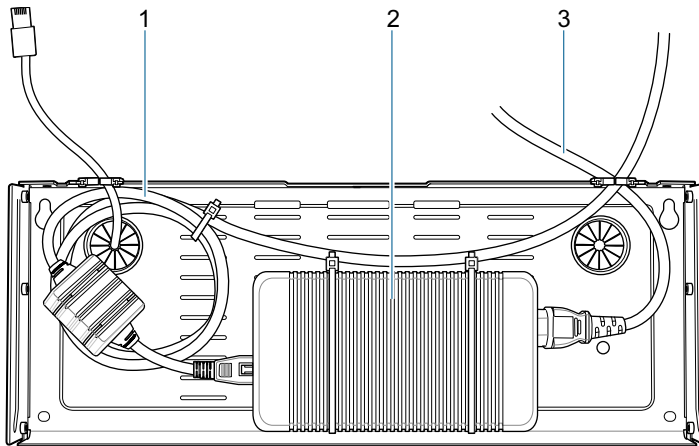

1	DC line cord
2	Power supply
3	AC line cord

6. Secure four M2.5 studs to top tray as shown.

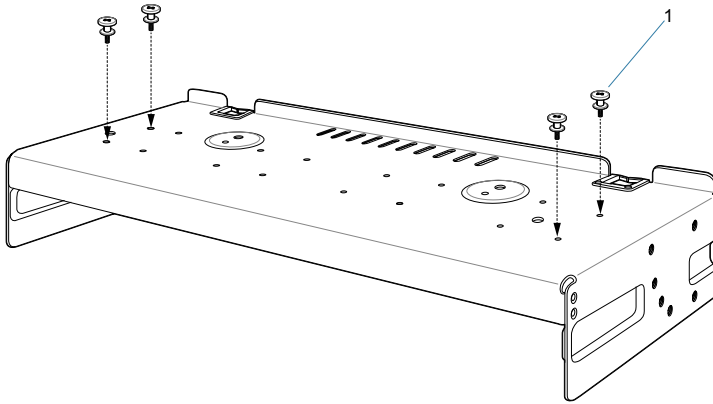

1	Studs (4)
---	-----------

7. Align and install 5-Slot cradle onto studs of top tray.

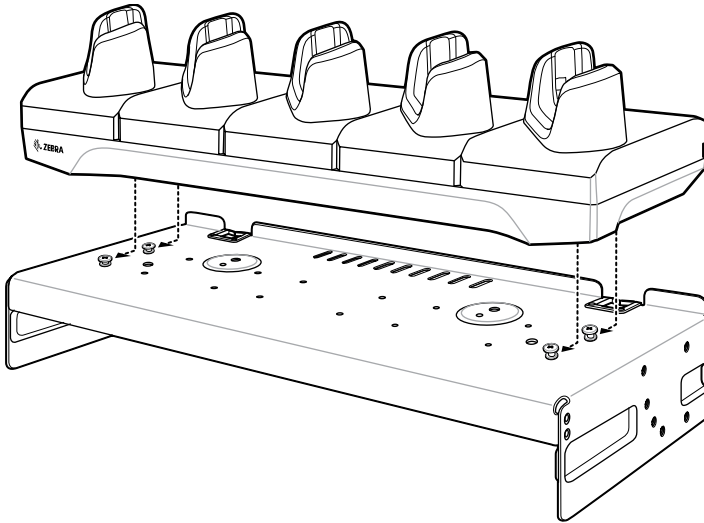

8. Secure cradle to top tray with two M2.5 safety screws.

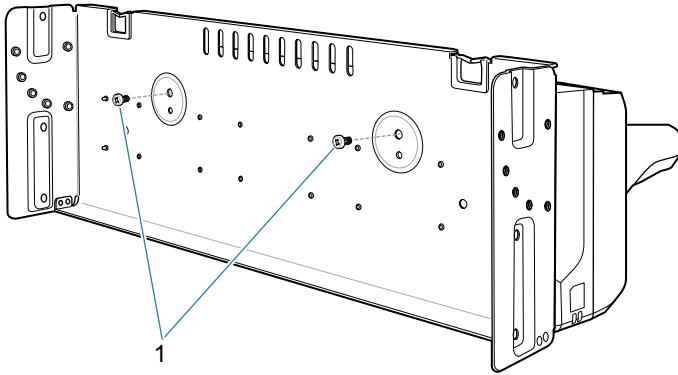

1	Safety screws (2)
---	-------------------

9. Slide top tray onto bottom tray.

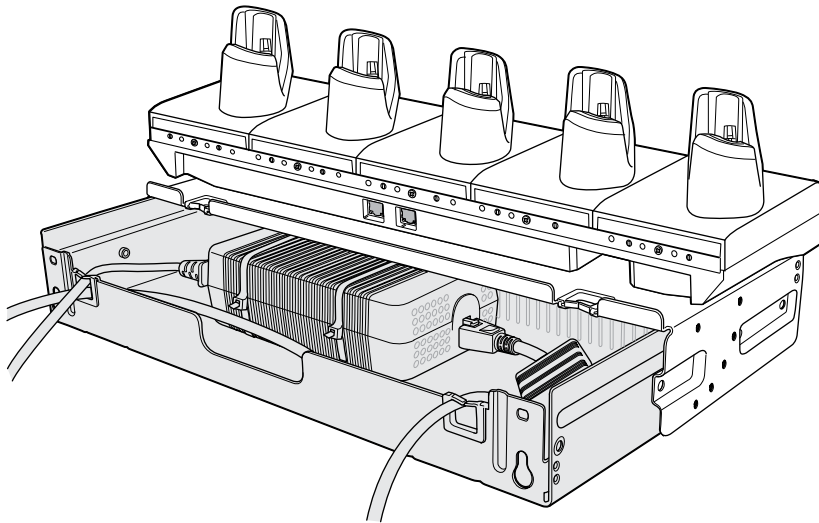

10. Connect cables to cradle.

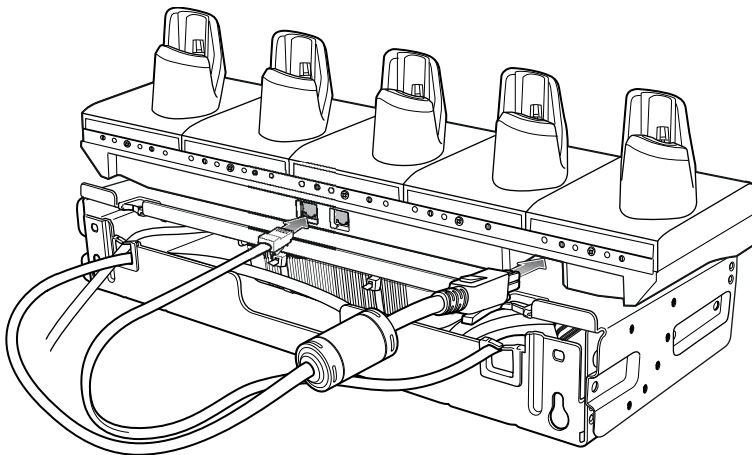



11. Secure top tray to bottom tray with four M5 screws (two on each side).

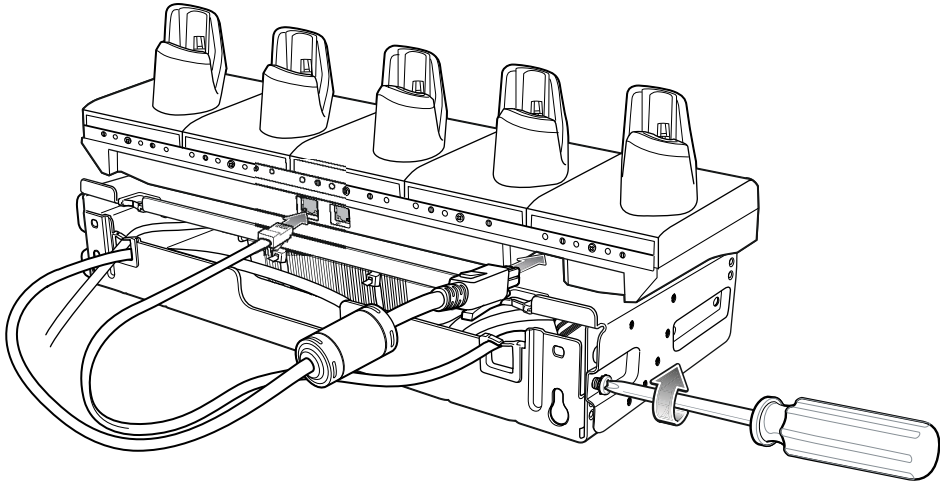

See [Rack Mount Installation on page 154](#) for installing the bracket assembly onto a rack.

## Rack Mount Installation



**NOTE:** Use screws provided with rack system. Refer to rack user documentation for instructions.

1. Secure mounting brackets to both sides of top tray with four M5 screws (two on each side).

- For 5-Slot cradles, position the flange for horizontal installation.

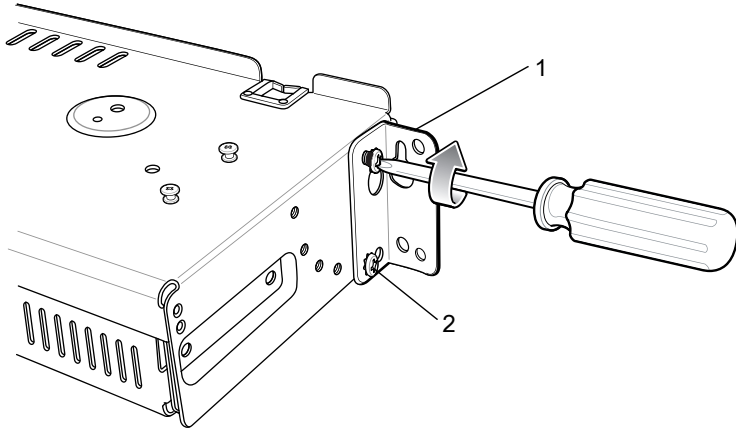

1	Flange
2	Fifth screw hole

- For 4-Slot Battery Chargers, position the flange for 25° installation.

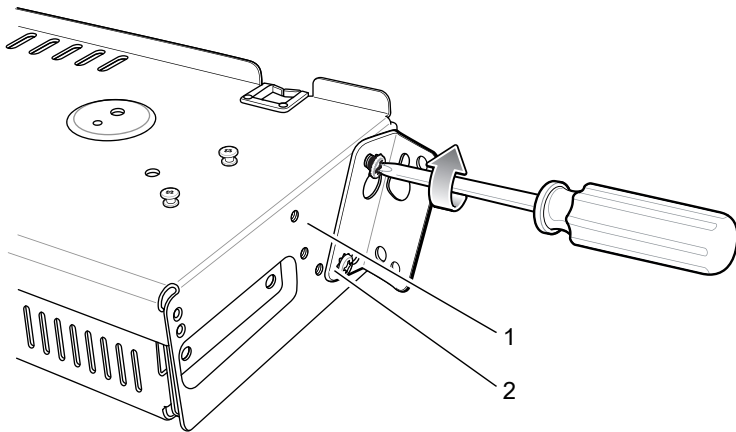

1	Top screw hole
2	Flange



**CAUTION:** Install mounting bracket with 5-Slot cradle at a maximum height of four feet from ground. Install mounting bracket with 4-Slot Battery Charger at a maximum height of three feet from ground.



**NOTE:** Distance between two horizontal mounted brackets should be at least 14" apart (from top of one flange to the top of the next flange).

Distance between a horizontal mounted bracket and a 25° mounted bracket should be at least 16.25" apart (from top of one flange to the top of the next flange).

There should be enough clearance (2.75") between the top of the device and the bottom of the mounting bracket above.

2. Install two rack system screws for top of mounting brackets. The screw heads should protrude half way from the rail.

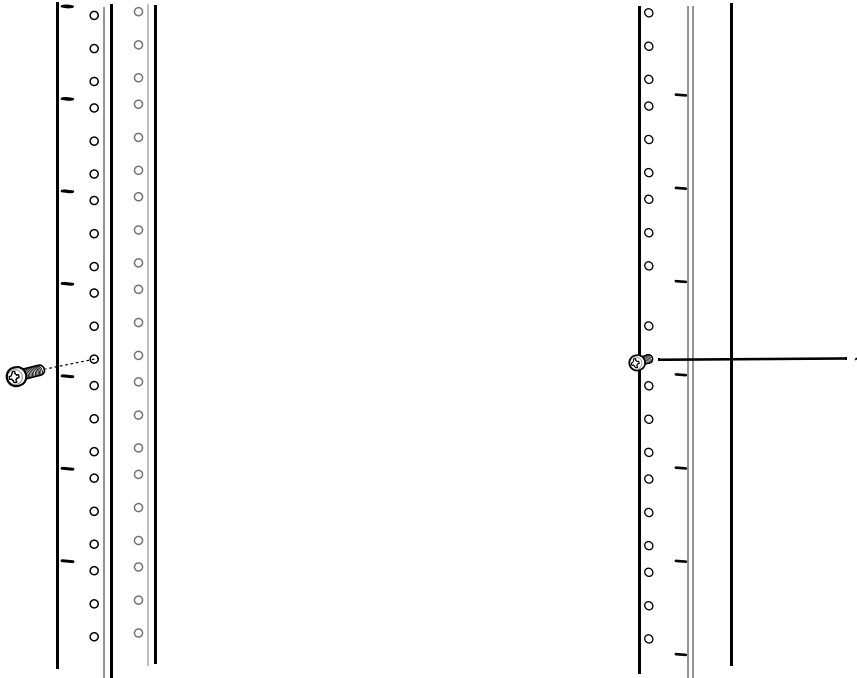

1	Rack screws
---	-------------

3. Align the mounting bracket's top mounting key holes with the screws.

4. Place the brackets on the screws.

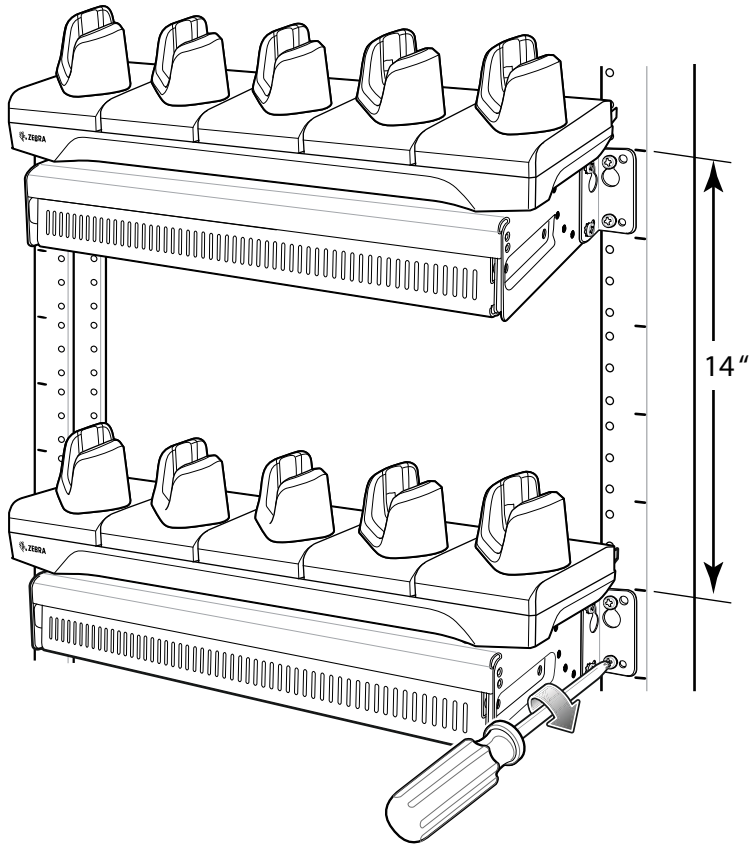

5. Secure the top screws.
6. Install bottom screws and tighten screws.
7. Route cables and connect to power source.



**CAUTION:** Installer should ensure that all building codes are followed when connecting the power supplies to an AC power source.

While installing the brackets, power supplies and cables:

- Use tie wraps to secure cables to the bracket and rails.
- Coil cables wherever possible.
- Route power cables along the rails.
- Route inter-cradle cables to the side rails and then from the rails to the bracket.

# Application Deployment

## Security

The device implements a set of security policies that determine whether an application is allowed to run and, if allowed, with what level of trust. To develop an application, you must know the security configuration of the device, and how to sign an application with the appropriate certificate to allow the application to run (and to run with the needed level of trust).



**NOTE:** Ensure the date is set correctly before installing certificates or when accessing secure web sites.

## Secure Certificates

If the VPN or Wi-Fi networks rely on secure certificates, obtain the certificates and store them in the device's secure credential storage, before configuring access to the VPN or Wi-Fi networks.

If downloading the certificates from a web site, set a password for the credential storage. The device supports X.509 certificates saved in PKCS#12 key store files with a .p12 extension (if key store has a .pfx or other extension, change to .p12).

The device also installs any accompanying private key or certificate authority certificates contained in the key store.

## Installing a Secure Certificate

To install a secure certificate:

1. Copy the certificate from the host computer to the root of the device's internal memory. See [USB Communication on page 34](#) for information about connecting the device to a host computer and copying files.
2. Go to **Settings**.
3. Touch **Security > Encryption & credentials**.
4. Touch **Install from storage**.
5. Navigate to the location of the certificate file.
6. Touch the filename of the certificate to install.
7. If prompted, enter the password for credential storage. If a password has not been set for the credential storage, enter a password for it twice and then touch **OK**.
8. If prompted, enter the certificate's password and touch **OK**.

9. Enter a name for the certificate and in the Credential use drop-down, select **VPN and apps** or **Wi-Fi**.
10. Touch **OK**.

The certificate can now be used when connecting to a secure network. For security, the certificate is deleted from the microSD card or internal memory.

### Configuring Credential Storage Settings

1. Go to **Settings**.
2. Touch **Security > Encryption & credentials**.
  - **Trusted credentials** - Touch to display the trusted system credentials.
  - **User credentials** - Touch to display user credentials.
  - **Install from storage** - Touch to install a secure certificate from the microSD card or internal storage.
  - **Clear credentials** - Deletes all secure certificates and related credentials.

## Development Tools

Development tools for Android include Android Studio, EMDK for Android, and StageNow.

### Android Application Development

#### Development Workstation

Android development tools are available at [developer.android.com](http://developer.android.com).

To start developing applications for the device, download Android Studio. Development can take place on a Microsoft® Windows®, Mac® OS X®, or Linux® operating system.

Applications are written in Java or Kotlin, but compiled and executed in the Dalvik virtual machine. Once the Java code is compiled cleanly, the developer tools make sure the application is packaged properly, including the AndroidManifest.xml file.

Android Studio contains a full featured IDE as well as SDK components required to develop Android applications.

#### Enabling Developer Options

The **Developer options** screen sets development related settings. By default, the Developer Options are hidden.

1. Go to **Settings**.
2. Touch **About phone**.
3. Scroll down to **Build number**.
4. Tap **Build number** seven times. The message **You are now a developer!** appears.
5. Touch the Back button.
6. Touch **System > Advanced > Developer options**.
7. Slide the **USB debugging** switch to the **ON** position.

### EMDK for Android

EMDK for Android provides developers with tools to create business applications for enterprise mobile devices. It is designed for use with Google's Android Studio and includes Android class libraries such as Barcode, sample applications with source code, and the associated documentation.

EMDK for Android allows applications to take full advantage of the capabilities that Zebra devices have to offer. It embeds Profile Manager technology within Android Studio IDE, providing a GUI-based development tool designed specifically for Zebra devices. This allows fewer lines of code, resulting in reduced development time, effort, and errors.

For more information go to: [techdocs.zebra.com](http://techdocs.zebra.com).

### StageNow

StageNow is Zebra's next-generation Android Staging Solution built on the MX platform. It allows quick and easy creation of device profiles, and can deploy to devices simply by scanning a barcode, reading a tag, or playing an audio file.

The StageNow Staging Solution includes the following components:

- The StageNow Workstation tool installs on the staging workstation (host computer) and lets the administrator easily create staging profiles for configuring device components, and perform other staging actions such as checking the condition of a target device to determine suitability for software upgrades or other activities. The StageNow Workstation stores profiles and other created content for later use.
- The StageNow Client resides on the device and provides a user interface for the staging operator to initiate staging. The operator uses one or more of the desired staging methods (print and scan a barcode, read an NFC tag or play an audio file) to deliver staging material to the device.

For more information go to: [techdocs.zebra.com](http://techdocs.zebra.com).

### GMS Restricted

GMS Restricted mode deactivates Google Mobile Services (GMS). All GMS apps are disabled on the device and communication with Google (analytics data collection and location services) is disabled.

Use StageNow to disable or enable GMS Restricted mode. After a device is in GMS Restricted mode, enable and disable individual GMS apps and services using StageNow. To ensure GMS Restricted mode persists after an Enterprise Reset, use the Persist Manager option in StageNow. For more information on StageNow, refer to [techdocs.zebra.com](http://techdocs.zebra.com).

### ADB USB Setup

To use the ADB, install the USB driver. This assumes that the development SDK has been installed on the host computer. Go to [developer.android.com/sdk/index.html](http://developer.android.com/sdk/index.html) for details on setting up the development SDK.

ADB driver for Windows and Linux are available on the Zebra Support Central web site at [zebra.com/support](http://zebra.com/support). Download the ADB and USB Driver Setup package. Follow the instructions with the package to install the ADB and USB drivers for Windows and Linux.

### Enabling USB Debugging

By default, USB debugging is disabled.

1. Go to **Settings**.
2. Touch **About phone**.
3. Scroll down to **Build number**.
4. Tap **Build number** seven times. The message **You are now a developer!** appears.
5. Touch the Back button.
6. Touch **System > Advanced > Developer options**.
7. Slide the **USB debugging** switch to the **ON** position.
8. Touch **OK**.
9. Connect the device to the host computer using the Rugged Charge/USB Cable.  
The **Allow USB debugging?** dialog box appears on the device.
10. On the device, touch **OK**.
11. On the host computer, navigate to the **platform-tools** folder.
12. Type **adb devices**.  
The following displays:  
**List of devices attached**  
XXXXXXXXXXXXXXXXX device (where XXXXXXXXXXXXXXXXXXXX is the device number).



**NOTE:** If device number does not appear, ensure that ADB drivers are installed properly.

13. Touch the Home button.

## Application Installation

After an application is developed, install the application onto the device using one of the following methods:

- USB connection, see [Installing Applications Using the USB Connection on page 160](#).
- Android Debug Bridge, see [Installing Applications Using the Android Debug Bridge on page 161](#).
- microSD Card, see [Installing Applications Using a microSD Card on page 161](#).
- Mobile device management (MDM) platforms that have application provisioning. Refer to the MDM software documentation for details.

### Installing Applications Using the USB Connection



**CAUTION:** When connecting the device to a host computer and mounting the microSD card, follow the host computer's instructions for connecting and disconnecting USB devices, to avoid damaging or corrupting files.

1. Connect the device to a host computer using a USB-C cable or insert the device into the 1-Slot USB/Ethernet Cradle.
2. Pull down the Notification panel and touch **Charging this device via USB**.
3. Touch **File Transfer**.
4. On the host computer, open a file manager application.



5. On the host computer, copy the application .apk file from the host computer to the device.



**CAUTION:** Carefully follow the host computer's instructions to unmount the microSD card and disconnect USB devices correctly to avoid losing information.

6. Disconnect the device from the host computer.
7. Swipe the screen up and select  to view files on the microSD card or Internal Storage.
8. Locate the application .apk file.
9. Touch the application file.
10. Touch **Continue** to install the app or **Cancel** to stop the installation.
11. To confirm installation and accept what the application affects, touch **Install** otherwise touch **Cancel**.
12. Touch **Open** to open the application or **Done** to exit the installation process. The application appears in the App list.

### Installing Applications Using the Android Debug Bridge

Use ADB commands to install application onto the device.



**CAUTION:** When connecting the device to a host computer and mounting its microSD card, follow the host computer's instructions for connecting and disconnecting USB devices, to avoid damaging or corrupting files.

1. Ensure that the ADB drivers are installed on the host computer. See [ADB USB Setup on page 159](#).
2. Connect the device to a host computer using USB. See [USB Communication on page 34](#).
3. Go to **Settings**.
4. Touch **System > Advanced > Developer options**.
5. Slide the switch to the **ON** position.
6. Touch **USB Debugging**. A check appears in the check box. The **Allow USB debugging?** dialog box appears.
7. Touch **OK**.
8. On the host computer, open a command prompt window and use the adb command:  

```
adb install <application>
```



where: <application> = the path and filename of the apk file.
9. Disconnect the device from the host computer. See [USB Communication on page 34](#).

### Installing Applications Using a microSD Card



**CAUTION:** When connecting the device to a host computer and mounting its microSD card, follow the host computer's instructions for connecting and disconnecting USB devices, to avoid damaging or corrupting files.

1. Copy the apk file to the root of the microSD card.
  - Copy the apk file to a microSD card using a host computer (see [USB Communication](#) for more information), and then installing the microSD card into the device (see [Replacing the microSD Card](#) for more information).

- Connect the device with a microSD card already installed to the host computer, and copy apk file to the microSD card. See USB Communication for more information. Disconnect the device from the host computer.
2. Connect the device to a host computer using USB. See USB Communication.
  3. Copy the application APK file from the host computer to the microSD card.
  4. Remove the microSD card from the host computer.
  5. Using your fingernail or a plastic tool, pull out the SD/SIM card drawer.
  6. Remove the SD/SIM card drawer from the device.
  7. Insert the microSD card into the SD/SIM card drawer.
  8. Insert the SD/SIM card drawer into the device.
  9. Press the SD/SIM card drawer into the device to ensure it is in securely.
  10. Swipe the screen up and select  to view files on the microSD card.
  11. Touch  > **SD card**.
  12. Locate the application .apk file.
  13. Touch the application file.
  14. Touch **Continue** to install the app or **Cancel** to stop the installation.
  15. To confirm installation and accept what the application affects, touch **Install** otherwise touch **Cancel**.
  16. Touch **Open** to open the application or **Done** to exit the installation process. The application appears in the App list.

### Uninstalling an Application

1. Go to **Settings**.
2. Touch **Apps & notifications**.
3. Touch **See all apps** to view all apps in the list.
4. Scroll through the list to the app.
5. Touch the app. The **App info** screen appears.
6. Touch **Uninstall**.
7. Touch **OK** to confirm.

### Performing a System Update

System Update packages can contain either partial or complete updates for the operating system. Zebra distributes the System Update packages on the Zebra Support & Downloads web site. Perform a system update using either a microSD card or using ADB.

### Downloading the System Update Package

1. Go to the Zebra Support & Downloads web site, [zebra.com/support](https://zebra.com/support).
2. Download the appropriate System Update package to a host computer.

## Performing a System Update Using microSD Card

1. Copy the System Update zip file to the root of the microSD card.
  - Copy the zip file to a microSD card using a host computer (see USB Communication for more information), and then installing the microSD card into the device (see Replacing the microSD Card for more information).
  - Connect the device with a microSD card already installed to the host computer, and copy zip file to the microSD card. See USB Communication for more information. Disconnect the device from the host computer.
2. Press and hold the Power button until the menu appears.
3. Touch **Restart**.
4. Press and hold the PTT button until the device vibrates. The System Recovery screen appears.
5. Press the Volume Up and Volume Down buttons to navigate to **Apply upgrade from SD card**.
6. Press the Power button.
7. Press the Volume Up and Volume Down buttons to navigate to **Full OTA Package** or **Diff OTA Package**.
8. Press the Power button.
9. Press the Volume Up and Volume Down buttons to navigate to the System Update file.
10. Press the Power button. The System Update installs and then the device returns to the Recovery screen.
11. Press the Power button to reboot the device.

## Performing a System Update Using ADB

1. Connect the device to a host computer using a USB-C cable or by inserting the device into the 1-Slot USB/Ethernet Cradle.
2. Go to **Settings**.
3. Touch **System > Advanced > Developer options**.
4. Slide the switch to the **ON** position.
5. Touch **USB Debugging**. A check appears in the check box. The **Allow USB debugging?** dialog box appears.
6. Touch **OK**.
7. On the host computer, open a command prompt window and use the adb command:
 

```
adb devices
```

The following displays:

```
List of devices attached
XXXXXXXXXXXXXXXXX device (where XXXXXXXXXXXXXXXXXXXX is the device number).
```



**NOTE:** If device number does not appear, ensure that ADB drivers are installed properly.

8. Type:
 

```
adb reboot recovery
```

9. Press Enter. The System Recovery screen appears on the device.
10. Press the Volume Up and Volume Down buttons to navigate to **Apply upgrade from ADB**.
11. Press the Power button.
12. Use the Volume Up and Volume Down buttons to navigate to **Full OTA Package** or **Diff OTA Package**.
13. Press the Power button.
14. On the host computer command prompt window type:  

```
adb sideload <file>
```

where: <file> = the path and filename of the zip file.
15. Press Enter. The System Update installs (progress appears as percentage in the Command Prompt window) and then the System Recovery screen appears on the device.
16. Press the Power button to reboot the device.

### Verifying System Update Installation

1. Go to **Settings**.
2. Touch **About phone**.
3. Scroll down to **Build number**.
4. Ensure that the build number matches the new system update package file number.

### Enterprise Reset

An Enterprise Reset erases all user data in the `/data` partition, including data in the primary storage locations (`/sdcard` and emulated storage).

Before performing an Enterprise Reset, provision all necessary configuration files and restore after the reset.

Perform Enterprise Reset from the device settings, using a microSD card, or using ADB.

### Performing an Enterprise Reset From Device Settings

1. Go to **Settings**.
2. Touch **System > Reset options > Erase all data (enterprise reset)**.
3. Touch **Erase all data** twice to confirm the Enterprise Reset.

### Downloading the Enterprise Reset Package

1. Go to the Zebra Support & Downloads web site, [zebra.com/support](https://zebra.com/support).
2. Download the Enterprise Reset file to a host computer.

### Performing an Enterprise Reset Using microSD Card

1. Copy the Enterprise Reset zip file to the root of the microSD card.
  - Copy the zip file to a microSD card using a host computer (see USB Communication for more information) and then installing the microSD card into the device (see Replacing the microSD Card for more information).

- Connect the device with a microSD card already installed to the host computer and copy zip file to the microSD card. See USB Communication for more information. Disconnect the device from the host computer.
2. Press and hold the Power button until the menu appears.
3. Touch **Restart**.
4. Press and hold the PTT button until the device vibrates. The System Recovery screen appears.
5. Press the Volume Up and Volume Down buttons to navigate to **Apply upgrade from SD card**.
6. Press the Power button.
7. Press the Volume Up and Volume Down buttons to navigate to **Full OTA Package**.
8. Press the Power button.
9. Press the Volume Up and Volume Down buttons to navigate to the Enterprise Reset file.
10. Press the Power button. The Enterprise Reset occurs and then the device returns to the Recovery screen.
11. Press the Power button to reboot the device.

### Performing an Enterprise Reset Using ADB

1. Connect the device to a host computer using a USB-C cable or insert the device into the 1-Slot USB/Ethernet Cradle.
2. Connect the cable or cradle to the host computer.
3. Go to **Settings**.
4. Touch **System > Advanced > Developer options**.
5. Slide the switch to the **ON** position.
6. Touch **USB Debugging**. A check appears in the check box. The **Allow USB debugging?** dialog box appears.
7. Touch **OK**.
8. On the host computer, open a command prompt window and type:  
`adb devices.`  
The following displays:  
**List of devices attached**  
`XXXXXXXXXXXXXXXX device (where XXXXXXXXXXXXXXXXXXXX is the device number).`



**NOTE:** If device number does not appear, ensure that ADB drivers are installed properly.

9. Type:  
`adb reboot recovery`
10. Press Enter. The System Recovery screen appears on the device.
11. Press the Volume Up and Volume Down buttons to navigate to **Apply upgrade from ADB**.
12. Press the Power button.
13. Press the Volume Up and Volume Down buttons to navigate to **Full OTA Package**.
14. Press the Power button.

15. On the host computer command prompt window type:

```
adb sideload <file>
```

where: <file> = the path and filename of the zip file.

16. Press Enter. The Enterprise Reset package installs and then the System Recovery screen appears on the device.

17. Press the Power button to reboot the device.

## Performing a Factory Reset

A Factory Reset erases all data in the /data and /enterprise partitions in internal storage and clears all device settings. A Factory Reset returns the device to the last installed operating system image. To revert to a previous operating system version, re-install that operating system image. See [Performing a System Update](#) for more information.

### Downloading the Factory Reset Package

To download the Factory Reset package:

1. Go to the Zebra Support & Downloads web site, [zebra.com/support](http://zebra.com/support).
2. Download the appropriate Factory Reset file to a host computer.

### Performing a Factory Reset Using microSD Card

1. Copy the Factory Reset zip file to the root of the microSD card.
  - Copy the zip file to a microSD card using a host computer (see USB Communication for more information) and then installing the microSD card into the device (see Replacing the microSD Card for more information).
  - Connect the device with a microSD card already installed to the host computer and copy zip file to the microSD card. See USB Communication for more information. Disconnect the device from the host computer.
2. Press and hold the Power button until the menu appears.
3. Touch **Restart**.
4. Press and hold the PTT button until the device vibrates. The System Recovery screen appears.
5. Press the Volume Up and Volume Down buttons to navigate to **Apply upgrade from SD card**.
6. Press the Power button.
7. Use the Volume Up and Volume Down buttons to navigate to **Full OTA Package**.
8. Press the Power button.
9. Use the Volume Up and Volume Down buttons to navigate to the Factory Reset file.
10. Press the Power button. The Factory Reset occurs and then the device returns to the Recovery screen.
11. Press the Power button to reboot the device.

### Performing a Factory Reset Using ADB

To perform an Factory Reset using ADB:

1. Connect the device to a host computer using a USB-C cable or insert the device into the 1-Slot USB/Ethernet Cradle.
2. Connect the cable or cradle to the host computer.
3. Go to **Settings**.
4. Touch **System > Advanced > Developer options**.
5. Slide the switch to the **ON** position.
6. Touch **USB Debugging**. A check appears in the check box. The **Allow USB debugging?** dialog box appears.
7. Touch **OK**.
8. On the host computer, open a command prompt window and type:  
`adb devices`.  
The following displays:  
**List of devices attached**  
XXXXXXXXXXXXXXXXX device (where XXXXXXXXXXXXXXXXXXXX is the device number).



**NOTE:** If device number does not appear, ensure that ADB drivers are installed properly.

9. Type:  
`adb reboot recovery`
10. Press Enter. The System Recovery screen appears on the device.
11. Press the Volume Up and Volume Down buttons to navigate to **Apply upgrade from ADB**.
12. Press the Power button.
13. Press the Volume Up and Volume Down buttons to navigate to **Full OTA Package**.
14. Press the Power button.
15. On the host computer command prompt window type:  
`adb sideload <file>`  
where: <file> = the path and filename of the zip file.
16. Press Enter. The Factory Reset package installs and then the System Recovery screen appears on the device.
17. Press the Power button to reboot the device.

## Storage

The device contains the following types of file storage:

- Random Access Memory (RAM)
- Internal storage
- External storage (microSD card)
- Enterprise folder.

## Random Access Memory

Executing programs use RAM to store data. Data stored in RAM is lost upon a reset. The operating system manages how applications use RAM. It only allows applications and component processes and services to use RAM when required. It may cache recently used processes in RAM, so they restart more quickly when opened again, but it will erase the cache if it needs the RAM for new activities.

The screen displays the amount of used and free RAM.

- **Performance** - Indicates memory performance.
- **Total memory** - Indicates the total amount of RAM available.
- **Average used (%)** - Indicates the average amount of memory (as a percentage) used during the period of time selected (default - 3 hours).
- **Free** - Indicates the total amount of unused RAM.
- **Memory used by apps** - Touch to view RAM usage by individual apps.

### Viewing Memory

1. Go to **Settings**.
2. Touch **System > Advanced > Developer options > Memory**.

## Internal Storage

The device has internal storage. The internal storage content can be viewed and files copied to and from when the device is connected to a host computer. Some applications are designed to be stored on the internal storage rather than in internal memory.

### Viewing Internal Storage

1. Go to **Settings**.
2. Touch **Storage**.

If the device has removable storage installed, touch **Internal shared storage** to display a the amount of internal storage used by apps, photos, videos, audio and other files.

## External Storage

The device can have a removable microSD card. The microSD card content can be viewed and files copied to and from when the device is connected to a host computer.

### Viewing External Storage

1. Go to **Settings**.
2. Touch **Storage**.

Portable storage displays the total amount of space on the installed and the amount used.

To unmount the microSD card, touch .

Touch **SD card** to view the contents of the card.

### Formatting a microSD Card

1. Touch **SD card**.



2. Touch **⋮** > **Storage settings**.
3. Touch **Format**.
4. Touch **ERASE & FORMAT**.
5. Touch **DONE**.

### Formatting a microSD Card as Internal Memory

You can format a microSD card as internal memory to increase the actual amount of the device's internal memory. Once formatted, the microSD card can only be read by this device.

1. Touch **SD card**.
2. Touch **⋮** > **Storage settings**.
3. Touch **Format as internal**.
4. Touch **ERASE & FORMAT**.
5. Touch **DONE**.

### Enterprise Folder

The Enterprise folder (within internal flash) is a super-persistent storage that is persistent after a reset and an Enterprise Reset. The Enterprise folder is erased during a Factory Reset. The Enterprise folder is used for deployment and device-unique data. The Enterprise folder is approximately 128 MB (formatted). Applications can persist data after an Enterprise Reset by saving data to the enterprise/user folder. The folder is ext4 formatted and is only accessible from a host computer using ADB or from an MDM.

## Managing Apps

Apps use two kinds of memory: storage memory and RAM. Apps use storage memory for themselves and any files, settings, and other data they use. They also use RAM when they are running.

1. Go to **Settings**.
2. Touch **Apps & notifications**.
3. Touch **See all XX apps** to view all apps on the device.
4. Touch **⋮** > **Show system** to include system processes in the list.
5. Touch an app, process, or service in the list to open a screen with details about it and, depending on the item, to change its settings, permissions, notifications and to force stop or uninstall it.

### App Details



Apps have different kinds of information and controls.

- **Force stop** - Stop an app.
- **Disable** - Disable an app.
- **Uninstall** - Remove the app and all of its data and settings from the device. See [Uninstalling an Application on page 162](#) for information about uninstalling apps.
- **Notifications** - Set the app notification settings.
- **Permissions** - Lists the areas on the device that the app has access to.
- **Storage & cache** - Lists how much information is stored, and includes buttons for clearing it.

- **Mobile data & Wi-Fi** - Provides information about data consumed by an app.
- **Advanced**
  - **Screen time** - Displays the amount of time the app has displayed on the screen.
  - **Battery** - Lists the amount of computing power used by the app.
  - **Open by default** - If you have configured an app to launch certain file types by default, you can clear that setting here.
  - **Display over other apps** - allows an app to display on top of other apps.
  - **App details** - Provides a link to additional app details on the Play store.
  - **Additional settings in the app** - Opens settings in the app.
  - **Modify system settings** - Allows an app to modify the system settings.

## Managing Downloads

Files and apps downloaded using the Browser or Email are stored on the microSD card or Internal storage in the Download directory. Use the Downloads app to view, open, or delete downloaded items.

1. Swipe the screen up and touch .
2. Touch  > **Downloads**.
3. Touch and hold an item, select items to delete and touch . The item is deleted from the device.

# Maintenance and Troubleshooting

## Maintaining the Device

For trouble-free service, observe the following tips when using the device:

- To avoid scratching the screen, use a Zebra approved capacitive compatible stylus intended for use with a touch-sensitive screen. Never use an actual pen or pencil or other sharp object on the surface of the device screen.
- The touch-sensitive screen of the device is glass. Do not drop the device or subject it to strong impact.
- Protect the device from temperature extremes. Do not leave it on the dashboard of a car on a hot day, and keep it away from heat sources.
- Do not store the device in any location that is dusty, damp, or wet.
- Use a soft lens cloth to clean the device. If the surface of the device screen becomes soiled, clean it with a soft cloth moistened with an approved cleanser. For a list of approved cleansers, see Approved Cleanser Active Ingredients.

## Battery Safety Guidelines

- The area in which the units are charged should be clear of debris and combustible materials or chemicals. Particular care should be taken where the device is charged in a non commercial environment.
- Follow battery usage, storage, and charging guidelines found in this guide.
- Improper battery use may result in a fire, explosion, or other hazard.
- To charge the mobile device battery, the ambient battery and charger temperatures must be between 5°C to 40°C (41°F to 104°F).
- Do not use incompatible batteries and chargers, including non-Zebra batteries and chargers. Use of an incompatible battery or charger may present a risk of fire, explosion, leakage, or other hazard. If you have any questions about the compatibility of a battery or a charger, contact the Global Customer Support Center.
- For devices that utilize a USB port as a charging source, the device shall only be connected to products that bear the USB-IF logo or have completed the USB-IF compliance program.
- Do not disassemble or open, crush, bend or deform, puncture, or shred the battery.
- Severe impact from dropping any battery-operated device on a hard surface could cause the battery to overheat.
- Do not short circuit a battery or allow metallic or conductive objects to contact the battery terminals.

- Do not modify or remanufacture, attempt to insert foreign objects into the battery, immerse or expose to water or other liquids, or expose to fire, explosion, or other hazard.
- Do not leave or store the equipment in or near areas that might get very hot, such as in a parked vehicle or near a radiator or other heat source. Do not place battery into a microwave oven or dryer.
- Battery usage by children should be supervised.
- Please follow local regulations to properly dispose of used rechargeable batteries.
- Do not dispose of batteries in fire.
- In the event of a battery leak, do not allow the liquid to come in contact with the skin or eyes. If contact has been made, wash the affected area with water for 15 minutes, and seek medical advice.
- If you suspect damage to your equipment or battery, contact Customer Support to arrange for inspection.

## Best Practices for Enterprise Mobile Computing Devices Operating in Hot Environments and Direct Sunlight

Exceeding the operating temperature by external hot environments will cause the device's thermal sensor to notify the user of a shutdown of the WAN modem or shutdown the device until the device's temperature returns to the operational temperature range.

- Avoid direct sunlight to the device - The easiest way to prevent overheating is to keep the device out of direct sunlight. The device absorbs light and heat from the sun and retains it, getting hotter the longer it remains in sunlight and heat.
- Avoid leaving the device in a vehicle on a hot day or hot surface - Similar to leaving the device out in direct sunlight, the device will also absorb the thermal energy from a hot surface or when left on the dashboard of a vehicle or seat, getting warmer the longer it remains on the hot surface or inside the hot vehicle.
- Turn off unused apps on the device. Open, unused apps running in the background can cause the device to work harder, which in turn may cause it to heat up. This will also improve your mobile computer device's battery life performance.
- Avoid turning your screen brightness up - Just the same as running background apps, turning your brightness up will force your battery to work harder and create more heat. Minimizing your screen brightness may extend operating the mobile computer device in hot environments.

## Cleaning Instructions



**CAUTION:** Always wear eye protection.

Read warning label on alcohol product before using.

If you have to use any other solution for medical reasons please contact the Global Customer Support Center for more information.



**WARNING:** Avoid exposing this product to contact with hot oil or other flammable liquids. If such exposure occurs, unplug the device and clean the product immediately in accordance with these guidelines.

## Approved Cleanser Active Ingredients

100% of the active ingredients in any cleaner must consist of one or some combination of the following: isopropyl alcohol, or mild dish soap.



**IMPORTANT:** Use pre-moistened wipes and do not allow liquid cleaner to pool.

Approved cleaners include:

- Purell Ethanol Wipes
- 409 Glass Cleaner
- Windex Blue

### Harmful Ingredients

The following chemicals are known to damage the plastics on the device and should not come in contact with the device: acetone; ketones; ethers; aromatic and chlorinated hydrocarbons; aqueous or alcoholic alkaline solutions; ethanolamine; toluene; trichloroethylene; benzene; carbolic acid and TB-lysoform.

Many vinyl gloves contain phthalate additives, which are often not recommended for medical use and are known to be harmful to the housing of the device.

Cleaners that are not approved include:

- Clorox Disinfecting Wipes
- Hydrogen Peroxide Cleaners
- Bleach Products.

### Device Cleaning Instructions

Do not apply liquid directly to the device. Dampen a soft cloth or use pre-moistened wipes. Do not wrap the device in the cloth or wipe, instead gently wipe the unit. Be careful not to let liquid pool around the display window or other places. Before use, allow the unit to air dry.



**NOTE:** For thorough cleaning, it is recommended to first remove all accessory attachments, such as hand straps or cradle cups, from the mobile device and to clean them separately.

### Special Cleaning Notes

Do not handle the device while wearing vinyl gloves containing phthalates. Remove vinyl gloves and wash hands to eliminate any residue left from the gloves.

If products containing any of the harmful ingredients listed above are used prior to handling the device, such as a hand sanitizer that contains ethanolamine, hands must be completely dry before handling the device to prevent damage to the device.



**IMPORTANT:** If the battery connectors are exposed to cleaning agents, thoroughly wipe off as much of the chemical as possible and clean with an alcohol wipe. It is also recommended to install the battery in the terminal prior to cleaning and disinfecting the device to help minimize buildup on the connectors.

When using cleaning/disinfectant agents on the device, it is important to follow the directions prescribed by the cleaning/disinfectant agent manufacturer.

### Cleaning Materials Required

- Alcohol wipes
- Lens tissue

- Cotton-tipped applicators
- Isopropyl alcohol
- Can of compressed air with a tube.

### Cleaning Frequency

The cleaning frequency is at the customer's discretion due to the varied environments in which the mobile devices are used and may be cleaned as frequently as required. When dirt is visible, it is recommended to clean the mobile device to avoid build up of particles which make the device more difficult to clean later on.

For consistency and optimum image capture, it is recommended to clean the camera window periodically especially when used in environments prone to dirt or dust.

## Cleaning the Device

### Housing

Thoroughly wipe the housing, including all buttons and triggers, using an approved alcohol wipe.

### Display

The display can be wiped down with an approved alcohol wipe, but care should be taken not to allow any pooling of liquid around the edges of the display. Immediately dry the display with a soft, non-abrasive cloth to prevent streaking.

### Camera and Exit Window

Wipe the camera and exit window periodically with a lens tissue or other material suitable for cleaning optical material such as eyeglasses.

## Cleaning Cradle Connectors

1. Remove the DC power cable from the cradle.
2. Dip the cotton portion of the cotton-tipped applicator in isopropyl alcohol.
3. Rub the cotton portion of the cotton-tipped applicator along the pins of the connector. Slowly move the applicator back-and-forth from one side of the connector to the other. Do not leave any cotton residue on the connector.
4. All sides of the connector should also be rubbed with the cotton-tipped applicator.
5. Remove any lint left by the cotton-tipped applicator.
6. If grease and other dirt can be found on other areas of the cradle, use a lint-free cloth and alcohol to remove.
7. Allow at least 10 to 30 minutes (depending on ambient temperature and humidity) for the alcohol to air dry before applying power to cradle.

If the temperature is low and humidity is high, longer drying time is required. Warm temperature and low humidity requires less drying time.



**CAUTION:** After cleaning the cradle connectors with bleach-based chemicals, follow the Cleaning Cradle Connectors instructions to remove bleach from the connectors.

## Troubleshooting

### Resetting the Device

There are two reset functions, soft reset and hard reset.

#### Performing a Soft Reset

Perform a soft reset if applications stop responding.

1. Press and hold the Power button until the menu appears.
2. Touch **Restart**.
3. The device reboots.

#### Performing a Hard Reset



**CAUTION:** Performing a hard reset with a microSD card installed in the device may cause damage or data corruption to the microSD card.

Perform a hard reset if the device stops responding.

1. Simultaneously press the Power, left Scan, and Volume Up buttons for at least four seconds.
2. When the screen turns off, release the buttons.
3. The device reboots.

### Troubleshooting the Device

**Table 19** Troubleshooting the Device

Problem	Cause	Solution
After installing the battery, the device does not boot up.	Power button was not pressed.	Press the Power button.
When pressing the power button the device does not turn on.	Battery not charged.	Charge or replace the battery in the device.
	Battery not installed properly.	Install the battery properly.
	System crash.	Perform a reset.
When pressing the power button the device does not turn on but two LEDs blink.	Battery charge is at a level where data is maintained but battery should be re-charged.	Charge or replace the battery in the device.

**Table 19** Troubleshooting the Device (Continued)

Problem	Cause	Solution
Battery did not charge.	Battery failed.	Replace battery. If the device still does not operate, perform a reset.
	Device removed from cradle while battery was charging.	Insert device in cradle. See <a href="#">Device Charging on page 104</a> .
	Extreme battery temperature.	Battery does not charge if ambient temperature is below 5°C to 40°C (41°F to 104°F).
Cannot see characters on display.	Device not powered on.	Press the <b>Power</b> button.
During data communication with a host computer, no data transmitted, or transmitted data was incomplete.	Device removed from cradle or disconnected from host computer during communication.	Replace the device in the cradle, or reattach the communication cable and re-transmit.
	Incorrect cable configuration.	See the system administrator.
	Communication software was incorrectly installed or configured.	Perform setup.
During data communication over Wi-Fi, no data transmitted, or transmitted data was incomplete.	Wi-Fi radio is not on.	Turn on the Wi-Fi radio.
	You moved out of range of an access point.	Move closer to an access point.
During data communication over Bluetooth, no data transmitted, or transmitted data was incomplete.	Bluetooth radio is not on.	Turn on the Bluetooth radio.
	You moved out of range of another Bluetooth device.	Move within 10 meters (32.8 feet) of the other device.
During data communication over mobile data, no data transmitted, or transmitted data was incomplete.	Mobile data is not on.	Turn on mobile data. If it is already on, turn it off and on again.
	You moved out of the coverage area.	Move into a coverage area.
No sound.	Volume setting is low or turned off.	Adjust the volume.
Device shuts off.	Device is inactive.	The display turns off after a period of inactivity. Set this period to 15 seconds, 30 seconds, 1, 2, 5, 10 or 30 minutes.
	Battery is depleted.	Replace the battery.



**Table 19** Troubleshooting the Device (Continued)

Problem	Cause	Solution
Tapping the window buttons or icons does not activate the corresponding feature.	The device is not responding.	Reboot the device.
A message appears stating that the device memory is full.	Too many files stored on the device.	Delete unused memos and records. If necessary, save these records on the host computer (or use an SD card for additional memory).
	Too many applications installed on the device.	Remove user-installed applications on the device to recover memory. Select <b>Settings &gt; Apps &amp; notifications</b> . Select the app in the list and select <b>UNINSTALL</b> .
The device does not decode with reading bar code.	Scanning application is not loaded.	Load a scanning application on the device or enable DataWedge. See the system administrator.
	Unreadable bar code.	Ensure the symbol is not defaced.
	Distance between exit window and bar code is incorrect.	Place the device within proper scanning range.
	Device is not programmed for the bar code.	Program the device to accept the type of bar code being scanned. Refer to the EMDK or DataWedge application.
	Device is not programmed to generate a beep.	If the device does not beep on a good decode, set the application to generate a beep on good decode.
	Battery is low.	If the scanner stops emitting a laser beam upon a trigger press, check the battery level. When the battery is low, the scanner shuts off before the device low battery condition notification. Note: If the scanner is still not reading symbols, contact the distributor or the Global Customer Support Center.
Device cannot find any Bluetooth devices nearby.	Too far from other Bluetooth devices.	Move closer to the other Bluetooth device(s), within a range of 10 meters (32.8 feet).
	The Bluetooth device(s) nearby are not turned on.	Turn on the Bluetooth device(s) to find.
	The Bluetooth device(s) are not in discoverable mode.	Set the Bluetooth device(s) to discoverable mode. If needed, refer to the device's user documentation for help.
Cannot unlock device.	User enters incorrect password.	If the user enters an incorrect password five times, the user is requested to wait for 30 seconds when using a PIN, Pattern or Password.
Multi-User mode is causing undefined behavior.	Multi-User mode is not supported by the Mobility DNA Enterprise License.	Perform a soft or hard reset on the device.

## 1-Slot Charge Only Cradle

**Table 20** Troubleshooting the 1-Slot Charge Only Cradle

Symptom	Possible Cause	Action
LEDs do not light when device is inserted.	Cradle is not receiving power.	Ensure the power cable is connected securely to both the cradle and to AC power.
	Device is not seated firmly in the cradle.	Remove and re-insert the device into the cradle, ensuring it is firmly seated.
Device battery is not charging.	Device was removed from cradle or cradle was unplugged from AC power too soon.	Ensure cradle is receiving power. Ensure device is seated correctly. Confirm main battery is charging. The standard battery charges from fully depleted to 90% in approximately three hours. The extended battery charges from fully depleted to 90% in approximately four hours.
	Battery is faulty.	Verify that other batteries charge properly. If so, replace the faulty battery.
	The device is not fully seated in the cradle.	Remove and re-insert the device into the cradle, ensuring it is firmly seated.
	Extreme battery temperature.	Battery does not charge if ambient temperature is below 5°C (41°F) or above 40°C (104°F).

## 1-Slot USB/Ethernet Cradle

**Table 21** Troubleshooting the 1-Slot Charge Only Cradle

Symptom	Possible Cause	Action
LEDs do not light when device is inserted.	Cradle is not receiving power.	Ensure the power cable is connected securely to both the cradle and to AC power.
	Device is not seated firmly in the cradle.	Remove and re-insert the device into the cradle, ensuring it is firmly seated.
Device battery is not charging.	Device was removed from cradle or cradle was unplugged from AC power too soon.	Ensure cradle is receiving power. Ensure device is seated correctly. Confirm main battery is charging. The standard battery charges from fully depleted to 90% in approximately three hours. The extended battery charges from fully depleted to 90% in approximately four hours.
	Battery is faulty.	Verify that other batteries charge properly. If so, replace the faulty battery.
	The device is not fully seated in the cradle.	Remove and re-insert the device into the cradle, ensuring it is firmly seated.
	Extreme battery temperature.	Battery does not charge if ambient temperature is below 5°C (41°F) or above 40°C (104°F).

**Table 21** Troubleshooting the 1-Slot Charge Only Cradle (Continued)



Symptom	Possible Cause	Action
During communication, no data transmits, or transmitted data was incomplete.	Device removed from cradle during communications.	Replace device in cradle and retransmit.
	Incorrect cable configuration.	Ensure that the correct cable configuration.
	Device has no active connection.	An icon is visible in the status bar if a connection is currently active.

## 4-Slot Charge Only Cradle

**Table 22** Troubleshooting the 5-Slot Charge Only Cradle

Problem	Cause	Solution
Battery is not charging.	Device removed from the cradle too soon.	Replace the device in the cradle. The standard battery charges from fully depleted to 90% in approximately three hours. The extended battery charges from fully depleted to 90% in approximately four hours.
	Battery is faulty.	Verify that other batteries charge properly. If so, replace the faulty battery.
	Device is not inserted correctly in the cradle.	Remove the device and reinsert it correctly. Verify charging is active. Touch  > <b>System</b> > <b>About phone</b> > <b>Status</b> to view battery status.
	Ambient temperature of the cradle is too warm.	Move the cradle to an area where the ambient temperature is between 5°C (41°F) and 40°C (104°F).

## 4-Slot Locking Charge Only Cradle

Problem	Cause	Solution
Cradle is not locking.	Device is not inserted correctly in the cradle.	Remove the device and reinsert it correctly. Verify charging is active. Touch  > <b>System</b> > <b>About phone</b> > <b>Battery Information</b> to view battery status.
	Device has no active connection.	An icon is visible in the status bar if a connection is currently active.
Battery is not charging.	Device removed from the cradle too soon.	Replace the device in the cradle. The battery fully charges in approximately five hours.
	Battery is faulty.	Verify that other batteries charge properly. If so, replace the faulty battery.
	Device is not inserted correctly in the cradle.	Remove the device and reinsert it correctly. Verify charging is active. Touch  > <b>System</b> > <b>About phone</b> > <b>Battery Information</b> to view battery status.
	Ambient temperature of the cradle is too warm.	Move the cradle to an area where the ambient temperature is between -10 °C (+14 °F) and +60 °C (+140 °F).

## 1-Slot Workstation Cradle

**Table 23** Troubleshooting

Problem	Cause	Solution
External monitor not detected.	The device is powered off when placed in the cradle and then turns on.	Remove the device from the cradle and re-insert. The device will then detect the monitor.
Display does not change orientation quickly.	It takes a little time for the device to recognize the monitor.	Wait for screen to re-orientate.
Device does not switch to landscape mode.	Device not detecting monitor.	Remove the device from the cradle and re-insert.
	Display setting not set properly.	Go to <b>Settings</b> > <b>Display</b> > <b>When device detects external monitor</b> . Ensure <b>Rotate screen orientation</b> is selected.
Peripheral not detected.	Bad cable connection.	Remove cable and re-connect.

# Technical Specifications

For device technical specifications, go to [www.zebra.com](http://www.zebra.com).

**Table 24** Data Capture Supported Symbologies

Item	Description
1D Bar Codes	Chinese 2 of 5, Codabar, Code 11, Code 128, Code 39, Code 93, Discrete 2 of 5, EAN-13, EAN-8, Interleaved 2 of 5, MSI, UPCA, UPCE, UPCE1, ISBN/Bookland, ISSN, Coupon Code, Matrix 2 of 5
2D Bar Codes	Australian Post, Aztec Code, Canada Postal, Composite AB, Composite C, DataMatrix, Dutch Postal, GS1 DataBar, GS1 Expanded, GS1 Limited, GS1 Datamatrix, Han Xin, Japan Postal, Maxicode, Micro PDF, Micro QR Code, PDF-417, QR Code, TLC-39, PDF-417, UK Postal, US4state, US4State FICS, US Planet, US Postnet

## Decode Distances

The table below lists the typical distances for selected bar code densities. The minimum element width (or “symbol density”) is the width in mils of the narrowest element (bar or space) in the symbol.

**Table 25** SE4100 Decode Distances

Symbol Density/ Bar Code Type	Typical Working Ranges	
	Near	Far
5 mil Code 39	2.4 in. 6.1 cm	9.5 in. 24.1 cm
5 mil Code 128	2.8 in. 7.1 cm	9.0 in. 22.9 cm
6.67 mil PDF417	2.4 in. 6.1 cm	8.0 in. 20.3 cm
10 mil Data Matrix	2.9 in. 7.4 cm	9.0 in. 22.9 cm
100% UPCA	1.8 in. 4.6 cm*	19.5 in. 49.5 cm

**Table 25** SE4100 Decode Distances (Continued)

Symbol Density/ Bar Code Type	Typical Working Ranges	
	Near	Far
15 mil QR Code	1.2 in. 3.05 cm*	12.0 in. 30.5 cm
20 mil QR Code	1.2 in. 3.05 cm*	14.0 in. 35.6 cm
20 mil Code 39	2.0 in. 5.08 cm*	26.0 in. 66.0 cm
<p>*Limited by width of bar code in field of view.                      Notes: Photographic quality bar code at 15° tilt pitch angle under 30 fcd ambient illumination.                      Distances measured from front edge of scan engine chassis.</p>		

## 1-Slot Charge Only Cradle Technical Specifications

**Table 26** 1-Slot Charge Only Cradle Technical Specifications

Item	Description
Dimensions	Height: 9.27 cm (3.65 in.) Width: 9.75 cm (3.84 in.) Depth: 13.2 cm (5.20 in.)
Weight	474 g (16.7 oz.)
Input Voltage	12 VDC
Power Consumption	up to 20 watts
Operating Temperature	0°C to 40°C (32°F to 104°F)
Storage Temperature	-40°C to 70°C (-40°F to 158°F)
Charging Temperature	0°C to 40°C (32°F to 104°F)
Humidity	5% to 95% non-condensing
Drop	76.2 cm (30.0 in.) drops to concrete, two drops per side (12 drops total) at room temperature.
Electrostatic Discharge (ESD)	+/- 15 kV air +/- 8 kV contact +/- 8 kV indirect discharge

## 1-Slot USB/Ethernet Cradle Technical Specifications

**Table 27** 1-Slot USB/Ethernet Cradle Technical Specifications

Item	Description
Dimensions	Height: 9.27 cm (3.65 in.) Width: 9.75 cm (3.84 in.) Depth: 13.2 cm (5.20 in.)
Weight	474 g (16.7 oz.)
Input Voltage	12 VDC
Power Consumption	up to 43 watts
Operating Temperature	0°C to 40°C (32°F to 104°F)
Storage Temperature	-40°C to 70°C (-40°F to 158°F)
Charging Temperature	0°C to 40°C (32°F to 104°F)
Humidity	5% to 95% non-condensing
Drop	76.2 cm (30.0 in.) drops to concrete, two drops per side (12 drops total) at room temperature.
Electrostatic Discharge (ESD)	+/- 15 kV air +/- 8 kV contact +/- 8 kV indirect discharge

## 1-Slot Workstation Cradle Technical Specifications

**Table 28** 1-Slot USB/Ethernet Cradle Technical Specifications

Item	Description
Dimensions	Height: 10.2 cm (4.02 in.) Width: 9.75 cm (3.84 in.) Depth: 13.2 cm (5.20 in.)
Weight	465 g (16.4 oz.)
Input Voltage	12 VDC
Power Consumption	up to 43 watts
Operating Temperature	0°C to 40°C (32°F to 104°F)
Storage Temperature	-40°C to 70°C (-40°F to 158°F)
Charging Temperature	0°C to 40°C (32°F to 104°F)
Humidity	5% to 95% non-condensing
Drop	76.2 cm (30.0 in.) drops to concrete, two drops per side (12 drops total) at room temperature.
Electrostatic Discharge (ESD)	+/- 15 kV air +/- 8 kV contact +/- 8 kV indirect discharge

## 4-Slot Charge Only Cradle

**Table 29** 4-Slot Charge Only Cradle with Battery Charger Technical Specifications

Item	Description
Dimensions	Height: 8.65 cm (3.41 in.) Width: 10.8 cm (4.25 in.) Depth: 24.5 cm (9.65 in.)
Weight	666 g (23.5 oz.)
Input Voltage	12 VDC
Power Consumption	up to 95 watts
Operating Temperature	0°C to 40°C (32°F to 104°F)
Storage Temperature	-40°C to 70°C (-40°F to 158°F)
Charging Temperature	0°C to 40°C (32°F to 104°F)
Humidity	0% to 95% non-condensing
Drop	76.2 cm (30.0 in.) drops to vinyl tiled concrete at room temperature.
Electrostatic Discharge (ESD)	+/- 15 kV air +/- 8 kV contact +/- 8 kV indirect discharge

## 4-Slot Charge Only Locking Cradle

**Table 30** 5-Slot Charge Only Cradle Technical Specifications

Item	Description
Dimensions	Height: 17.19 cm (6.77 in.) Width: 21.7 cm (8.54 in.) Depth: 14.0 cm (5.51 in.)
Weight	1440 g (50.8 oz.)
Input Voltage	12 VDC
Power Consumption	up to 95 watts
Operating Temperature	0°C to 40°C (32°F to 104°F)
Storage Temperature	-40°C to 70°C (-40°F to 158°F)
Charging Temperature	0°C to 40°C (32°F to 104°F)
Humidity	0% to 95% non-condensing
Drop	76.2 cm (30.0 in.) drops to vinyl tiled concrete at room temperature.
Electrostatic Discharge (ESD)	+/- 15 kV air +/- 8 kV contact +/- 8 kV indirect discharge



## 5-Slot Ethernet Cradle Technical Specifications

**Table 31** 5-Slot Ethernet Cradle Technical Specifications

Item	Description
Dimensions	Height: 11.1 cm (4.37 in.) Width: 48.9 cm (19.25 in.) Depth: 13.3 cm (5.24 in.)
Weight	2040 g (71.96 oz.)
Input Voltage	12 VDC
Power Consumption	up to 70 watts
Operating Temperature	0°C to 50°C (32°F to 122°F)
Storage Temperature	-40°C to 70°C (-40°F to 158°F)
Charging Temperature	0°C to 40°C (32°F to 104°F)
Humidity	5% to 95% non-condensing
Drop	76.2 cm (30.0 in.) drops to concrete, two drops per side (12 drops total) at room temperature.
Electrostatic Discharge (ESD)	+/- 15 kV air +/- 8 kV contact +/- 8 kV indirect discharge

## Trigger Handle Technical Specifications

**Table 32** Trigger Handle Technical Specifications

Item	Description
Dimensions	Height: 13.1 cm (5.16 in.) Width: 8.1 cm (3.19 in.) Depth: 15.8 cm (6.22 in.)
Weight	114 g (4.0 oz.)
Operating Temperature	-10°C to 40°C (14°F to 104°F)
Storage Temperature	-40°C to 70°C (-40°F to 158°F)
Humidity	10% to 95% non-condensing
Drop	1.2 m (4 feet) drops to plywood, two drops per side (12 drops total) over operating temperature range of device and cable.
Electrostatic Discharge (ESD)	+/- 15 kV air +/- 8 kV contact +/- 8 kV indirect discharge

## USB-C Audio Adapter Technical Specifications

**Table 33** USB-C Audio Adapter Technical Specifications

Item	Description
Length	91.4 cm +/- 7.6 cm (36 in. +/- 3 in.)
Input Voltage	5.0 VDC via USB-C interface on device
Compliance	Android USB-C audio compliant
Buttons	Volume up, Volume down, and Zebra PTT buttons.
3.5 mm headset compatibility	Compatible with CTIA wired 3.5 mm 4-pin audio headsets Compatible with HDST-35MM-PTVP-01 with PTT collar headset Compatible with HS2100 3.5 mm to 3.5 mm cables
Operating Temperature	0°C to 40°C (32°F to 104°F)
Storage Temperature	-40°C to 70°C (-40°F to 158°F)
Humidity	10% to 95% non-condensing
Electrostatic Discharge (ESD)	+/- 15 kV air +/- 8 kV contact +/- 8 kV indirect discharge

## Vehicle Cradle Technical Specifications

**Table 34** Vehicle Cradle Technical Specifications

Item	Description
Dimensions	Height: 16.4 cm (6.46 in.) Width: 10.7 cm (4.21 in.)
Operating Temperature	-25°C to 60°C (-13°F to 140°F)
Storage Temperature	-40°C to 85°C (-40°F to 185°F)
Humidity	10% to 95% non-condensing

# Index

## Numerics

1-slot USB/charge only cradle kit	102
4-slot charge only cradle with battery charger kit	102
5-slot charge only cradle kit	102
5-slot Ethernet cradle kit	102

## A

adaptive frequency hopping	89
adjust volume	97
ambient display setting	37
apn	88
approved cleanser	172
apps	
accessing	49
camera	52
datawedge demonstration	55
PTT Express	56
RxLogger	59
RxLogger Utility	60
sound recorder	60
audio modes	96

## B

barcode scanning	
digital camera	62
battery	102, 103
low battery notification	33
monitor usage	33
battery charging	24, 104
battery management	32
battery level	32
battery present status	32
battery optimization	32
battery safety guidelines	171
bluetooth	79, 89
change name	92
PIN	90
power states	91
profiles	90

security	89
Bluetooth call	99

## C

call forwarding	100
call waiting	100
caller ID	100
camera	20, 46, 52
photo settings	54
recording videos	53
taking photos	52
camera settings	54
cast	93
change bluetooth name	92
cleaning	172, 173
camera and exit window	174
cradle connectors	174
display	174
frequency	174
housing	174
instructions	172
materials	173
cleaning instructions	173
conference call	98
Configurations	12
cradle	
connector cleaning	174

## D

data capture	
digital camera	62
datawedge	75
decoders	76
disabling	76
enable	75
datawedge demonstration	55
DC line cord	104
decoders	76
digital camera	62
barcode scanning	62

data capture	62
disconnect host computer	35
display settings	36

## E

EAP	79
edit apn	88
emergency calling	96

## F

file transfer	34
fixed dialing numbers	100
font size	38

## G

general sound setting	39
-----------------------	----

## H

hand strap	103
handset mode	96
hands-free imager	64
hard reset	175
harmful ingredients	173
headset mode	96
home screen	26
rotation	27

## I

install microSD card	22
interactive sensor technology	33

## K

keyboards	42
additional character tab	43
alpha tab	43
configuration	42
editing text	42
numeric tab	43

## L

light sensor	20
linear imager	63
lock screen notifications	45
low battery notification	33

## M

maintenance	
-------------	--

battery safety guidelines	171
clean camera and exit window	174
clean cradle connectors	174
clean display	174
clean housing	174
cleaning frequency	174
cleaning instructions	172
cleaning materials required	173
device cleaning instructions	173
harmful ingredients	173
maintaining the device	171
special cleaning notes	173
managing notifications	30
messaging	48
microSD card	22
monitor battery usage	33

## N

near field communication	79
near field communications	93
NFC	93
notational conventions	16
notification icons	28
notifications	
lock screen	45
managing	30

## P

pairing	
RS507/RS6000 hands-free imager	72
using Bluetooth HID (RS507/RS6000)	74
using simple serial interface(RS507/RS6000)	74
photo transfer	34
photos	
camera settings	54
taking	52
picklist	63
power supply	103
PTT Express	
audible indicators	57
enabling communication	57
group calls	58
notification icons	57
talk groups	58
user interface	56
Voice Client	56
PTT-Express	
PTT communication	58

## Q

quick access panel	31
quick settings	

edit icons	32	trigger handle	103
		troubleshooting	175
<b>R</b>		<b>U</b>	
remove wi-fi	80	USB	34
resetting the device	175	using a wired headset	96
resetting	175	using the dialer	97
RS507		<b>V</b>	
scanning	69, 70	videos	
RS507 scanning	69, 70	recording	53
RS507/RS6000		voicemail setup	100
pairing	72	<b>W</b>	
pairing using Bluetooth HID	74	WEP	79
pairing using simple serial interface	74	Wi-Fi direct	84
RS6000		wired headset	96
scanning	67	wireless local area network	79
RS6000 scanning	67	wireless wide area network	79
RxLogger	59	WLAN	79
configuration	59	WPA	79
configuration file	59	WWAN	79
disable logging	59		
enable logging	59		
extract log files	59		
RxLogger Utility	60		
<b>S</b>			
scanning	65, 66		
considerations	65		
RS507	69, 70		
RS6000	67		
screen font size	38		
security	79		
setting			
camera	54		
settings	36		
accessing	36		
ambient display	37		
camera photos	54		
display	36		
general sound	39		
SMS	48		
soft holster	103		
soft reset	175		
software version	18		
software versions	17		
sound recorder	60		
speaker	21		
speaker mode	96		
status bar	27		
symbolologies	181		
<b>T</b>			
transferring files using USB	34		

