



# Maintenance and Service Guide

## SUMMARY

This guide provides information about spare parts, removal and replacement of parts, security, backing up, and more.

© Copyright 2021 HP Development Company, L.P.

AMD is a trademark of Advanced Micro Devices, Inc. Bluetooth is a trademark owned by its proprietor and used by HP Inc. under license. Chrome, Chromebook, Chrome OS, Google, and Google Drive are trademarks of Google LLC. Intel, Celeron, and vPro are trademarks of Intel Corporation or its subsidiaries in the U.S. and/or other countries. SDHC, SDXC, and microSD are trademarks or registered trademarks of SD-3C LLC. USB Type-C and USB-C are registered trademarks of USB Implementers Forum. DisplayPort™ and the DisplayPort™ logo are trademarks owned by the Video Electronics Standards Association (VESA®) in the United States and other countries.

The information contained herein is subject to change without notice. The only warranties for HP products and services are set forth in the express warranty statements accompanying such products and services. Nothing herein should be construed as constituting an additional warranty. HP shall not be liable for technical or editorial errors or omissions contained herein.

First Edition: February 2021

Document Part Number: M45076-001

## Product notice

This guide describes features that are common to most models. Some features may not be available on your computer.

To access the latest user guides, go to <http://www.hp.com/support>, and follow the instructions to find your product. Then select **Manuals**.

## Software terms

By installing, copying, downloading, or otherwise using any software product preinstalled on this computer, you agree to be bound by the terms of the HP End User License Agreement (EULA). If you do not accept these license terms, your sole remedy is to return the entire unused product (hardware and software) within 14 days for a full refund subject to the refund policy of your seller.

For any further information or to request a full refund of the price of the computer, please contact your seller.

## Safety warning notice

Reduce the possibility of heat-related injuries or of overheating the computer by following the practices described.

---

 **WARNING!** To reduce the possibility of heat-related injuries or of overheating the computer, do not place the computer directly on your lap or obstruct the computer air vents. Use the computer only on a hard, flat surface. Do not allow another hard surface, such as an adjoining optional printer, or a soft surface, such as pillows or rugs or clothing, to block airflow. Also, do not allow the AC adapter to come into contact with the skin or a soft surface, such as pillows or rugs or clothing, during operation. The computer and the AC adapter comply with the user-accessible surface temperature limits defined by applicable safety standards.

---



---

# Table of contents

|  |           |
|--|-----------|
| <b>1 Product description .....</b>   | <b>1</b>  |
| <b>2 Components .....</b>  | <b>3</b>  |
| Right .....  | 3         |
| Left .....   | 4         |
| Display .....  | 5         |
| Touchpad .....   | 6         |
| Special keys .....   | 7         |
| Bottom .....   | 8         |
| <b>3 Illustrated parts catalog .....</b>                                   | <b>9</b>  |
| Computer major components .....  | 9         |
| Display assembly subcomponents .....                                       | 13        |
| Cables .....   | 15        |
| Miscellaneous parts .....  | 16        |
| <b>4 Removal and replacement procedures preliminary requirements .....</b> | <b>17</b> |
| Tools required .....   | 17        |
| Service considerations .....   | 18        |
| Plastic parts .....  | 18        |
| Cables and connectors .....  | 18        |
| Drive handling .....   | 18        |
| Electrostatic discharge information .....                                  | 19        |
| Generating static electricity .....  | 19        |
| Preventing electrostatic damage to equipment .....                         | 20        |
| Personal grounding methods and equipment .....                             | 20        |
| Grounding the work area .....  | 20        |
| Recommended materials and equipment .....                                  | 21        |
| Cleaning your computer .....   | 22        |
| Enabling HP Easy Clean (select products only) .....                        | 22        |
| Removing dirt and debris from your computer .....                          | 22        |

|   |           |
|---|-----------|
| Cleaning your computer with a disinfectant .....  | 23        |
| Caring for wood veneer (select products only) .....                                     | 24        |
| Packaging and transporting guidelines .....   | 24        |
| Accessing support information .....   | 24        |
| <b>5 Removal and replacement procedures for authorized service provider parts .....</b> | <b>27</b> |
| Component replacement procedures .....  | 28        |
| Preparation for disassembly .....   | 29        |
| Top cover/keyboard .....  | 29        |
| Touchpad cable .....  | 32        |
| Touchpad .....  | 33        |
| Battery .....   | 34        |
| WLAN module .....   | 35        |
| Speakers .....  | 37        |
| Connector board cables .....  | 37        |
| Connector board .....   | 38        |
| System board .....  | 39        |
| Heat sink .....   | 41        |
| 29.6 cm (11.6 in) display assembly .....  | 43        |
| <b>6 Backing up, resetting, and recovering .....</b>                                    | <b>51</b> |
| Backing up .....  | 51        |
| Resetting .....   | 51        |
| Recovering .....  | 52        |
| Installing the Chromebook Recovery Utility .....  | 52        |
| Creating recovery media .....   | 52        |
| Recovering the Chrome operating system .....  | 52        |
| Setting up your computer after a reset or recovery .....                                | 52        |
| Erase and reformat the recovery media .....   | 52        |
| Specifications .....  | 54        |
| Computer specifications .....   | 54        |
| 29.5 cm (11.6 in) display specifications .....  | 54        |
| <b>7 Specifications .....</b>   | <b>57</b> |
| Computer specifications .....   | 57        |
| 29.6 cm (11.6 in) display specifications .....  | 58        |
| <b>8 Statement of memory volatility .....</b>   | <b>59</b> |
| Current BIOS steps .....  | 59        |
| Nonvolatile memory usage .....  | 61        |

|   |           |
|---|-----------|
| Questions and answers .....                           | 63        |
| Using HP Sure Start (select products only) .....      | 65        |
| <b>9 Power cord set requirements .....</b>            | <b>67</b> |
| Requirements for all countries .....                  | 67        |
| Requirements for specific countries and regions ..... | 67        |
| <b>10 Recycling .....</b>                             | <b>71</b> |
| <b>Index .....</b>                                    | <b>73</b> |





# 1 Product description

This table provides detailed product information.

**Table 1-1** Product components and their descriptions

| Category          | Description  |
|-------------------|--|
| Product Name      | HP Chromebook® 11 G9 Education Edition   |
| Processors        | Intel™ Celeron® N5100 1.10 GHz processor (quad core, 2933 MHz front side bus (FSB), 6 W)<br>Intel Celeron N4500 1.10 GHz processor (dual core, 2933 MHz FSB, 6 W)  |
| Chipset           | Intel integrated soldered-on-circuit (SoC)   |
| Display           | <ul style="list-style-type: none"><li>• 29.6 cm (11.6 in), liquid crystal display (LCD), high definition (HD) (1368 × 768), antiglare, white light-emitting diode (WLED), UWVA, 50% CG, eDP 1.2 without PSR, slim touchscreen display panel; typical brightness: 220 nits</li><li>• 29.6 cm (11.6 in), LCD, HD (1368 × 768), antiglare, WLED, UWVA, 50% CG, eDP, slim non-touchscreen display panel; typical brightness: 220 nits</li><li>• 29.6 cm (11.6 in), LCD, HD (1368 × 768), antiglare, WLED, SVA, 45% CG, eDP, slim non-touchscreen display panel; typical brightness: 220 nits</li></ul> |
| Memory            | On-board (nonupgradeable) system memory supporting 4 GB and 8 GB<br>Support for 2933 LPDDR4X 0.6v IC FBGA200 system memory   |
| Media card reader | microSD™ media reader slot<br>Supports microSD, SDHC™, SDXC™<br>Push-push insertion/removal<br>On-board (nonupgradeable) support for 32 GB or 64 GB MO-276 MMC v5.0  |
| Multimedia card   | On-board (nonupgradeable) for 64 GB MO-276 MMC v5.0  |
| Networking        | Intel Wi-Fi 6 AX201 ax 2×2 + Bluetooth® 5.0 MU-MIMO M.22230 non-vPro® 160MHz MIPI+BRI WW with 2 antennas   |
| Storage           | On-board (nonupgradeable) support for embedded MultiMedia Controller (eMMC) 32 GB MO-276 MMC v5.0  |
| Audio and video   | Integrated dual speakers<br>Integrated HP HD camera<br>720p by 30 frames per second  |
| Ports             | Audio-out (headphone)/audio-in (microphone) combo jack<br>USB Type-A ports (2)   |

**Table 1-1** Product components and their descriptions (continued)

| Category                  | Description   |
|---------------------------|---|
|                           | USB Type-C® power connector and SuperSpeed port (1)   |
| Keyboard/pointing devices | <b>Keyboard:</b> Integrated, spill-resistant keyboard<br><b>Touchpad</b>  |
| Power requirements        | <b>Battery:</b> 2 cell, 47 WHr, HP Long Life<br><b>Smart AC adapter:</b> 45 W, non-PFC, standard, USB Type-C, straight<br><b>Power cord:</b> C5, 1.0 m (3.3 ft) |
| Security                  | Titan C security chip<br>Nano security cable lock   |
| Operating system          | Google® Chrome™   |
| Serviceability            | <b>End user replaceable part:</b> AC adapter  |

## 2 Components

This is the Components chapter from the user guide.

### Right

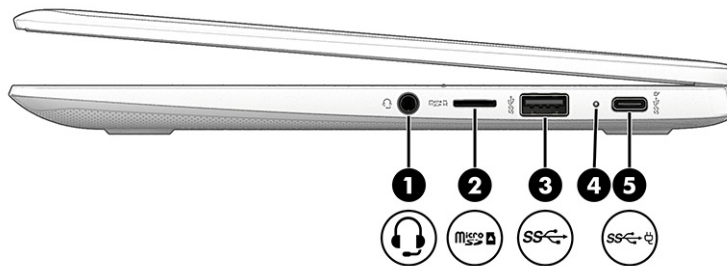

Use the illustration and table to identify the components on the right side of the computer.



**Table 2-1** Right-side components and their descriptions

| Component  | Description  |
|--|--|
| (1)  Audio-out (headphone)/Audio-in (microphone) combo jack | Connects optional powered stereo speakers, headphones, earbuds, a headset, or a television audio cable. Also connects an optional headset microphone. This jack does not support optional standalone microphones.<br><br><b>WARNING!</b> To reduce the risk of personal injury, adjust the volume before putting on headphones, earbuds, or a headset. For additional safety information, see the <i>Regulatory, Safety, and Environmental Notices</i> .<br><br><b>NOTE:</b> When a device is connected to the jack, the computer speakers are disabled. |

**Table 2-1** Right-side components and their descriptions (continued)



| Component   | Description  |
|---|--|
| (2)  microSD™ memory card reader                       | Reads optional memory cards that store, manage, share, or access information.<br><br>To insert a card: <ol style="list-style-type: none"> <li>1. Hold the card label-side up, with the connectors facing the computer.</li> <li>2. Insert the card into the memory card reader, and then press in on the card until it is firmly seated.</li> </ol> To remove a card: <ul style="list-style-type: none"> <li>▲ Press in on the card, and then remove it from the memory card reader.</li> </ul>  |
| (3)  USB SuperSpeed port                               | Connects a USB device, provides high-speed data transfer, and (for select products) charges small devices (such as a smartphone) when the computer is on or in Sleep mode.<br><br><b>NOTE:</b> Use a standard USB Type-A charging cable or cable adapter (purchased separately) when charging a small external device.   |
| (4) Battery light   | When AC power is connected: <ul style="list-style-type: none"> <li>• White: The battery is fully charged.</li> <li>• Amber: The battery charge is from 0 to 99 percent.</li> <li>• Off: The battery is not charging.</li> </ul> When AC power is disconnected (battery not charging): <ul style="list-style-type: none"> <li>• Blinking white: The battery has reached a low battery level. When the battery has reached a critical battery level, the battery light blinks rapidly.</li> <li>• Off: The battery is not charging.</li> </ul> |
| (5)  USB Type-C® power connector and SuperSpeed port | Connects an AC adapter that has a USB Type-C connector, supplying power to the computer and, if needed, charging the computer battery.<br><br>– and –<br><br>Connects a USB device, provides high-speed data transfer, and (for select products) charges small devices (such as a smartphone) when the computer is on or in Sleep mode.<br><br><b>NOTE:</b> Use a standard USB Type-C charging cable or cable adapter (purchased separately) when charging a small external device.  |

## Left

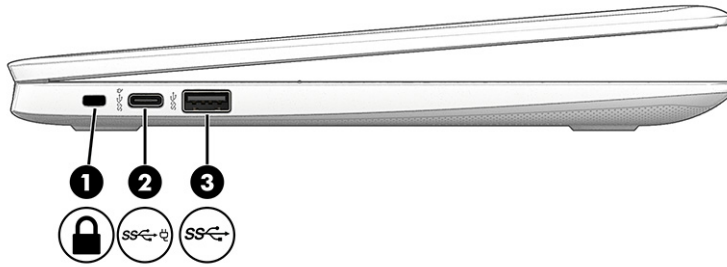
Use the illustration and table to identify the components on the left side of the computer.

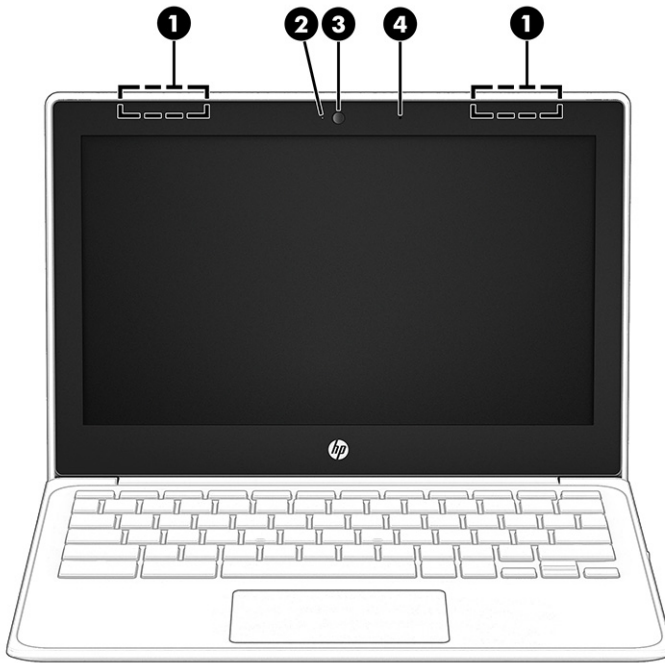

**Table 2-2** Left-side components and their descriptions

| Component   | Description  |
|---|--|
| (1)    | <p>Security cable slot</p> <p>Attaches an optional security cable to the computer.</p> <p><b>NOTE:</b> The security cable is designed to act as a deterrent, but it might not prevent the computer from being mishandled or stolen.</p>  |
| (2)    | <p>USB Type-C power connector and SuperSpeed port</p> <p>Connects an AC adapter that has a USB Type-C connector, supplying power to the computer and, if needed, charging the computer battery.</p> <p>– and –</p> <p>Connects a USB device, provides high-speed data transfer, and (for select products) charges small devices (such as a smartphone) when the computer is on or in Sleep mode.</p> <p><b>NOTE:</b> Use a standard USB Type-C charging cable or cable adapter (purchased separately) when charging a small external device.</p> |
| (3)  | <p>USB SuperSpeed port</p> <p>Connects a USB device, provides high-speed data transfer, and (for select products) charges small devices (such as a smartphone) when the computer is on or in Sleep mode.</p> <p><b>NOTE:</b> Use a standard USB Type-A charging cable or cable adapter (purchased separately) when charging a small external device.</p>   |

## Display

Use the illustration and table to identify the components on the display.



**Table 2-3** Display components and their descriptions

| Component                | Description   |
|--------------------------|---|
| (1) WLAN antennas*       | Send and receive wireless signals to communicate with wireless local area networks (WLANs).   |
| (2) Camera light         | On (white): The camera is in use.<br>Off: The camera is turned off by the software.   |
| (3) Camera               | Allows you to video chat, record video, and record still images.<br><b>NOTE:</b> Camera functions vary depending on the camera hardware and software installed on your product. |
| (4) Internal microphones | Record sound.   |

\*The antennas are not visible from the outside of the computer. For optimal transmission, keep the areas immediately around the antennas free from obstructions.

For wireless regulatory notices, see the section of the *Regulatory, Safety, and Environmental Notices* that applies to your country or region.

## Touchpad

The touchpad settings and components are described here.

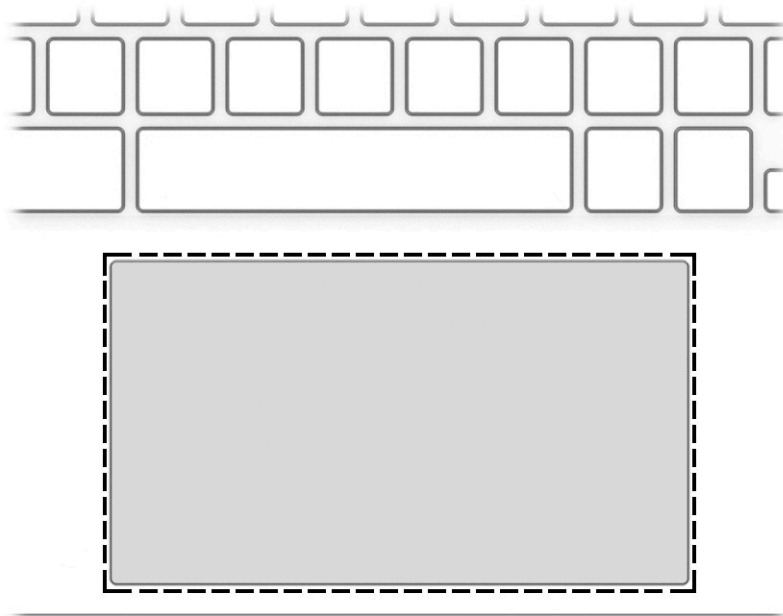
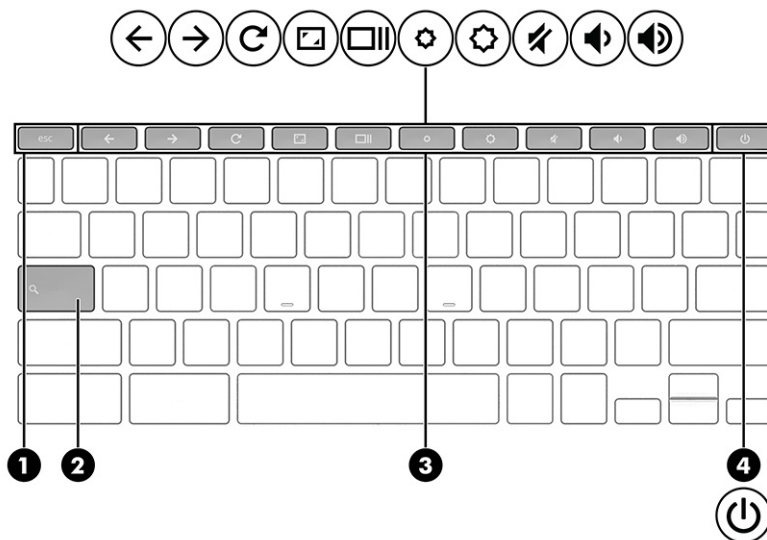

**Table 2-4** Touchpad component and description

| Component     | Description   |
|---------------|---|
| Touchpad zone | Reads your finger gestures to move the pointer or activate items on the screen. |

## Special keys

Use the illustration and table to locate the special keys.



**Table 2-5** Special keys and their descriptions

| Component                | Description                                    |
|--------------------------|--|
| (1) <code>esc</code> key | Cancels the current active computer operation. |
| (2) Search key           | Opens a search box.                            |

**Table 2-5** Special keys and their descriptions (continued)

| Component   | Description  |
|---|--|
| (3) Action keys   | Execute frequently used system functions.  |
| (4)  Power key | <ul style="list-style-type: none"> <li>When the computer is off, press the key briefly to turn on the computer.</li> <li>When the computer is on, press the key briefly to initiate Sleep.</li> <li>When the computer is in the Sleep state, press the key briefly to exit Sleep (select products only).</li> </ul> <p><b>IMPORTANT:</b> Pressing and holding down the power key results in the loss of unsaved information.</p> <p>If the computer has stopped responding and shutdown procedures are ineffective, press and hold the power key for at least 10 seconds to turn off the computer.</p> |

## Bottom

Use the illustration and table to identify the bottom components.



**Table 2-6** Bottom component and description

| Components | Description    |
|------------|----------------|
| Speakers   | Produce sound. |



---

## 3 Illustrated parts catalog

Use this table to determine the spare parts that are available for the computer.

### Computer major components

To identify the computer major components, use this illustration and table.

---

 **NOTE:** HP continually improves and changes product parts. For complete and current information about supported parts for your computer, go to <http://partsurfer.hp.com>, select your country or region, and then follow the on-screen instructions.

 **NOTE:** Details about your computer, including model, serial number, product key, and length of warranty, are on the service tag at the bottom of your computer.

---

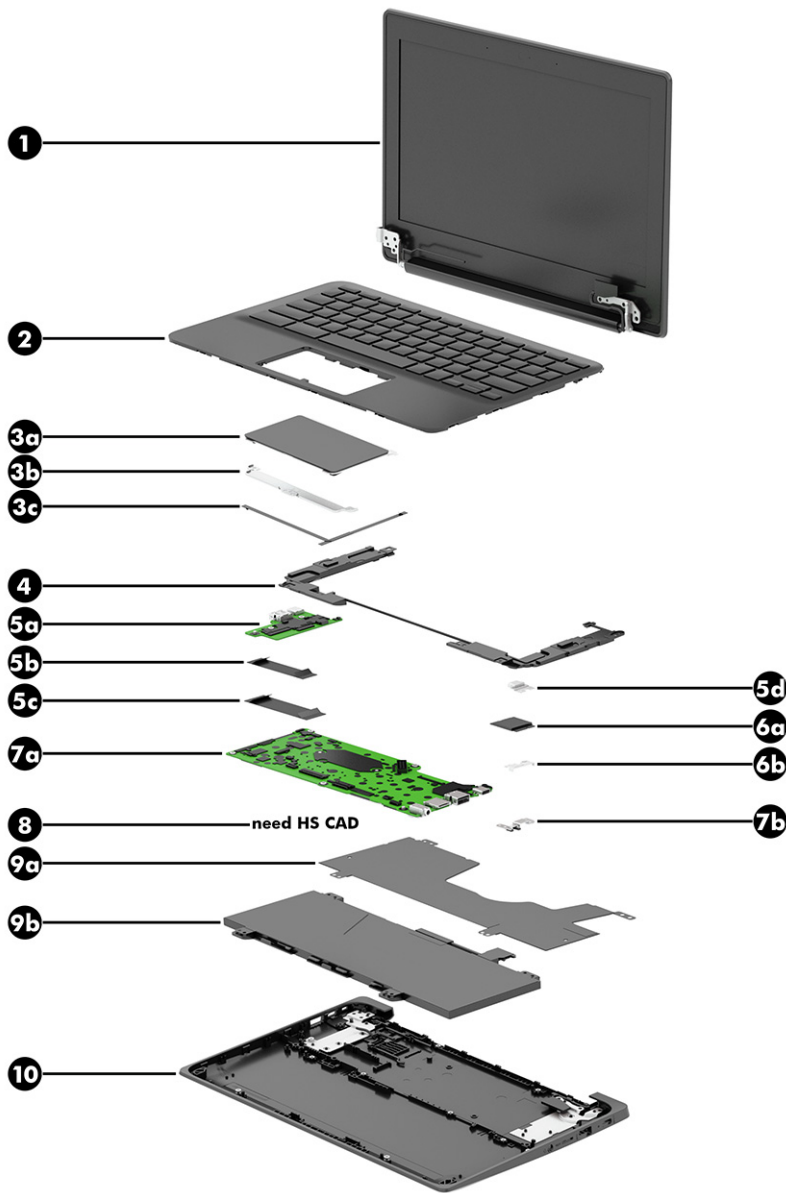

**Table 3-1** Computer major component descriptions and part numbers

| Item | Component  | Spare part number |
|------|--|-------------------|
| (1)  | Display assembly   |                   |
|      | <b>NOTE:</b> Display spare parts are available as subcomponents, not as whole units. Display subcomponent spare parts are available. For spare part information, see <a href="#">Display assembly subcomponents on page 13</a> . |                   |
| (2)  | Top cover/keyboard in jet black finish (includes keyboard cable):  |                   |
|      | For use in Belgium   | M47382-A41        |
|      | For use in Brazil  | M47382-201        |
|      | For use in Canada  | M47382-DB1        |
|      | For use in the Czech Republic and Slovakia   | M47382-FL1        |
|      | For use in Denmark, Finland, and Norway  | M47382-DH1        |

**Table 3-1 Computer major component descriptions and part numbers (continued)**

| Item | Component  | Spare part number |
|------|--|-------------------|
|      | For use in France  | M47382-051        |
|      | For use in Germany   | M47382-041        |
|      | For use in Israel  | M47382-BB1        |
|      | For use in Italy   | M47382-061        |
|      | For use in Japan   | M47382-291        |
|      | For use in Latin America   | M47382-161        |
|      | For use in the Netherlands   | M47382-B31        |
|      | For use in Portugal  | M47382-131        |
|      | For use in Romania   | M47382-271        |
|      | For use in Russia  | M47382-251        |
|      | For use in Saudi Arabia  | M47382-171        |
|      | For use in Slovenia  | M47382-BA1        |
|      | For use in South Korea   | M47382-AD1        |
|      | For use in Spain   | M47382-071        |
|      | For use in Sweden and Finland  | M47382-B71        |
|      | For use in Switzerland   | M47382-BG1        |
|      | For use in Taiwan  | M47382-AB1        |
|      | For use in Thailand  | M47382-281        |
|      | For use in Turkey  | M47382-141        |
|      | For use in the United Kingdom  | M47382-031        |
|      | For use in the United States   | M47382-001        |
|      | <b>Top cover/keyboard</b> in nautical teal finish (includes keyboard cable): |                   |
|      | For use in Belgium   | M47383-A41        |
|      | For use in Brazil  | M47383-201        |
|      | For use in Canada  | M47383-DB1        |
|      | For use in the Czech Republic and Slovakia                                   | M47383-FL1        |
|      | For use in Denmark, Finland, and Norway                                      | M47383-DH1        |
|      | For use in France  | M47383-051        |
|      | For use in Germany   | M47383-041        |
|      | For use in Israel  | M47383-BB1        |
|      | For use in Italy   | M47383-061        |
|      | For use in Latin America   | M47383-161        |
|      | For use in the Netherlands   | M47383-B31        |

**Table 3-1 Computer major component descriptions and part numbers (continued)**

| Item        | Component   | Spare part number |
|-------------|---|-------------------|
|             | For use in Portugal   | M47383-131        |
|             | For use in Romania  | M47383-271        |
|             | For use in Russia   | M47383-251        |
|             | For use in Saudi Arabia   | M47383-171        |
|             | For use in Slovenia   | M47383-BA1        |
|             | For use in South Korea  | M47383-AD1        |
|             | For use in Spain  | M47383-071        |
|             | For use in Sweden and Finland   | M47383-B71        |
|             | For use in Switzerland  | M47383-BG1        |
|             | For use in Taiwan   | M47383-AB1        |
|             | For use in Thailand   | M47383-281        |
|             | For use in Turkey   | M47383-141        |
|             | For use in the United Kingdom   | M47383-031        |
|             | For use in the United States  | M47383-001        |
| <b>(3a)</b> | <b>Touchpad:</b>  |                   |
|             | <b>NOTE:</b> The touchpad spare part kit does not include the touchpad bracket or touchpad cable. The touchpad bracket is included in the Bracket Kit, spare part number L89791-001. The touchpad cable is included in the Cable Kit, spare part number M47368-001. |                   |
|             | In jet black finish   | M47384-001        |
|             | In nautical teal finish   | M47385-001        |
| <b>(3b)</b> | <b>Touchpad bracket</b>   | L89791-001        |
|             | <b>Touchpad Bracket Rubber Kit</b> (not illustrated)  | L89786-001        |
| <b>(3c)</b> | <b>Touchpad cable:</b> (included in the Cable Kit, spare part number M47368-001)  |                   |
| <b>(4)</b>  | <b>Speakers</b> (includes left and right speakers and cables)   | M55117-001        |
| <b>(5a)</b> | <b>Connector board</b> (includes HDMI port and USB port)  | M47369-001        |
|             | <b>NOTE:</b> The connector board spare part kit does not include the connector board cable. The connector board cable is included in the Cable Kit, spare part number M47368-001.   |                   |
| <b>(5b)</b> | <b>Connector board low-power cable</b> (included in the Cable Kit, spare part number M47368-001, includes double-sided adhesive)  |                   |
| <b>(5c)</b> | <b>Connector board high-power cable</b> (included in the Cable Kit, spare part number M47368-001, includes double-sided adhesive)   |                   |
| <b>(5d)</b> | <b>I/O bracket</b>  | L89793-001        |
| <b>(6a)</b> | <b>Intel Wi-Fi 6 AX201 ax 2x2 + Bluetooth 5.0 MU-MIMO M.22230 non-vPro 160MHz MIPI+BRI WW WLAN module</b>   | L92724-005        |
| <b>(6b)</b> | <b>WLAN module bracket</b>  | M00452-001        |
| <b>(7a)</b> | <b>System board</b> (includes a graphics subsystem with UMA memory, replacement thermal material, and the Chrome operating system)  |                   |

**Table 3-1 Computer major component descriptions and part numbers (continued)**

| <b>Item</b> | <b>Component</b>  | <b>Spare part number</b> |
|-------------|---|--------------------------|
|             | Equipped with an Intel Celeron N5100 processor, 8 GB of system memory, and 64 GB of eMMC system storage | M47374-001               |
|             | Equipped with an Intel Celeron N5100 processor, 8 GB of system memory, and 32 GB of eMMC system storage | M47373-001               |
|             | Equipped with an Intel Celeron N5100 processor, 4 GB of system memory, and 32 GB of eMMC system storage | M47372-001               |
|             | Equipped with an Intel Celeron N4500 processor, 8 GB of system memory, and 64 GB of eMMC system storage | M56147-001               |
|             | Equipped with an Intel Celeron N4500 processor, 8 GB of system memory, and 32 GB of eMMC system storage | M56146-001               |
|             | Equipped with an Intel Celeron N4500 processor, 4 GB of system memory, and 64 GB of eMMC system storage | M47371-001               |
|             | Equipped with an Intel Celeron N4500 processor, 4 GB of system memory, and 32 GB of eMMC system storage | M47370-001               |
| <b>(7b)</b> | <b>I/O bracket</b>  | L89793-001               |
|             | <b>Thermal Material Kit</b> (not illustrated)   | M47379-001               |
|             | <b>WLAN module bracket</b> (not illustrated)  | M00452-001               |
| <b>(8)</b>  | <b>Heat sink</b> (includes replacement thermal material)  | M47196-001               |
|             | <b>Thermal Material Kit</b> (not illustrated)   | M47379-001               |
| <b>(9a)</b> | <b>Battery shield</b>   | L98587-001               |
| <b>(9b)</b> | <b>Battery</b> (2 cell, 47 Whr, 6.15 Ahr, Li)   | L75783-005               |
|             | <b>Battery tape</b> (not illustrated)   | L14905-001               |
| <b>(10)</b> | <b>Base enclosure</b>   |                          |
|             | In jet black finish   | M47380-001               |
|             | In nautical teal finish   | M47381-001               |

## Display assembly subcomponents

To identify the display assembly subcomponents, use this illustration and table.

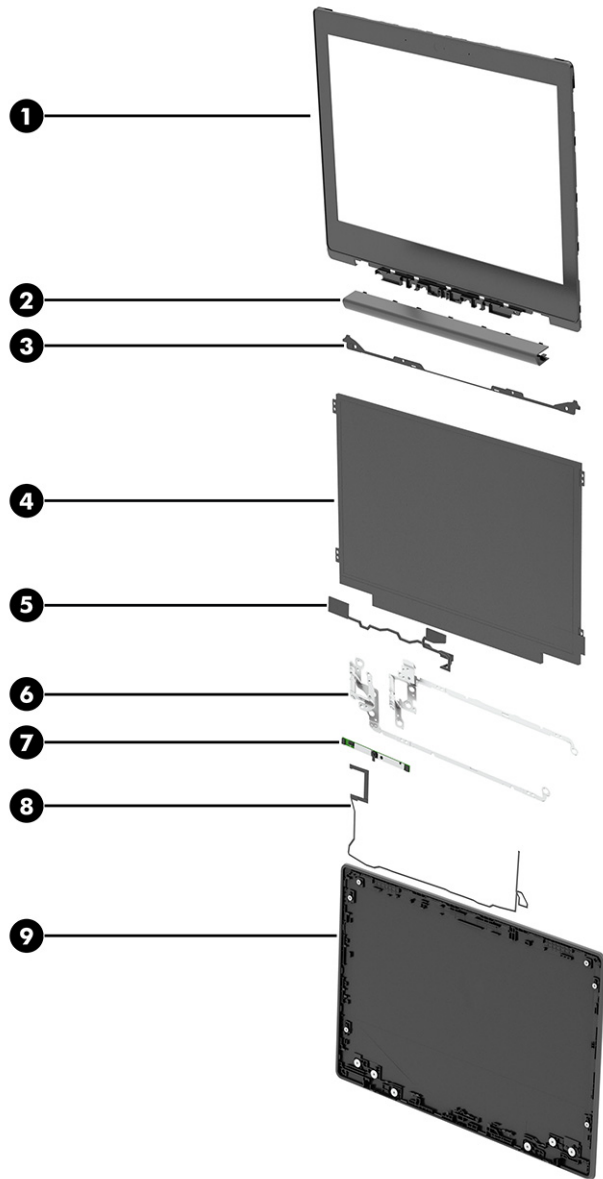

**Table 3-2** Display component descriptions and part numbers

| Item | Component   | Spare part number |
|------|---|-------------------|
| (1)  | Display bezel   | M47387-001        |
|      | <b>NOTE:</b> The display bezel tape is included in the Cable Kit, spare part number L90412-001. |                   |
| (2)  | Display hinge cover   | M44252-001        |
| (3)  | Display bracket   | L89774-001        |
| (4)  | Display panel assembly:   |                   |
|      | 29.6 cm (11.6 in), HD, antiglare, UWVA, touchscreen, 250 nits                                   | M47377-001        |
|      | 29.6 cm (11.6 in), HD, antiglare, UWVA, non-touchscreen, 250 nits                               | M47376-001        |
|      | 29.6 cm (11.6 in), HD, antiglare, SVA, non-touchscreen, 250 nits                                | M47375-001        |
| (5)  | Display panel cable:  |                   |

**Table 3-2** Display component descriptions and part numbers (continued)

| Item | Component  | Spare part number |
|------|--|-------------------|
|      | For use only on computer models equipped with a touchscreen display assembly   | M48566-001        |
|      | For use only on computer models equipped with a non-touchscreen display assembly   | M48567-001        |
| (6)  | <b>Display hinges</b> (2, includes left and right hinges)  | M44251-001        |
| (7)  | <b>Webcam/microphone module</b> (includes double-sided adhesive)   | M44253-001        |
|      | <b>NOTE:</b> The webcam/microphone module spare part kit does not include the webcam/microphone module cable. The webcam/microphone module cable is included in the Cable Kit, spare part number L90412-001. |                   |
| (8)  | <b>Webcam/microphone module cable</b> (included in the Cable Kit, spare part number M47368-001, includes double-sided adhesive)  |                   |
| (9)  | <b>Display back cover</b> (includes wireless antenna):   |                   |
|      | <b>NOTE:</b> The display bezel tape is included in the Cable Kit, spare part number M47368-001.  |                   |
|      | In jet black finish  | M55115-001        |
|      | In nautical teal finish  | M55116-001        |
|      | <b>Wireless antenna</b> (not illustrated, includes left and right wireless antenna cables and transceivers and double-sided adhesive)  | M47386-001        |

## Cables

To identify the cables, use this illustration and table.

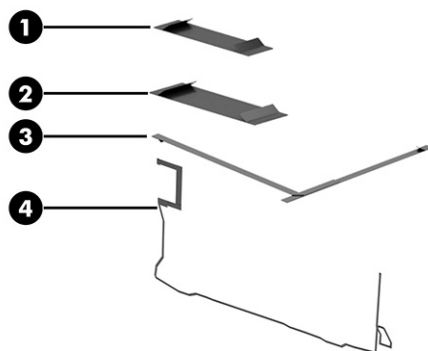

**Table 3-3** Cable descriptions and part numbers

| Item | Component   | Spare part number |
|------|---|-------------------|
|      | The cables listed in this table are available in the Cable Kit, spare part number M47368-001. |                   |
| (1)  | <b>Connector board low-power cable</b>  |                   |
| (2)  | <b>Connector board high-power cable</b>   |                   |
| (3)  | <b>Touchpad cable</b>   |                   |
| (4)  | <b>Webcam/microphone module cable</b>   |                   |

## Miscellaneous parts

To identify the miscellaneous parts, use this table.

**Table 3-4** Miscellaneous part descriptions and part numbers

| Component   | Spare part number |
|---|-------------------|
| <b>45 W, USB Type-C, AC adapter</b> (non-PFC, 1.8 m, 3 pin)   | L43407-001        |
| <b>Cable Kit</b> (includes connector board high-power cable, connector board low-power cable, sensor board cable, touchpad cable, webcam/microphone module cable, and display bezel tape) | M47368-001        |
| <b>Power cord</b> (C5, 1.0 m, conventional with sticker)  |                   |
| For use in Argentina  | L19357-001        |
| For use in Australia  | L19358-001        |
| For use in Brazil   | L19359-001        |
| For use in Denmark  | L19360-001        |
| For use in Europe   | L19361-001        |
| For use in India  | L19363-001        |
| For use in Israel   | L19362-001        |
| For use in Italy  | L19364-001        |
| For use in Japan  | L19365-001        |
| For use in North America  | L19367-001        |
| For use in South Africa   | L19369-001        |
| For use in South Korea  | L19366-001        |
| For use in Switzerland  | L19370-001        |
| For use in Taiwan   | L19372-001        |
| For use in Thailand   | L19371-001        |
| For use in the United Kingdom   | L19373-001        |
| <b>Screw Kit</b>  | M47390-001        |



---

## 4 Removal and replacement procedures preliminary requirements

Use this information to properly prepare to disassemble and reassemble the computer.

### Tools required

You need the following tools to complete the removal and replacement procedures:

- Keyboard removal tool
- Magnetic Phillips P0 screwdriver
- Nonconductive, nonmarking pry tool

## Service considerations

The following sections include some of the considerations that you must keep in mind during disassembly and assembly procedures.

---

 **NOTE:** As you remove each subassembly from the computer, place the subassembly (and all accompanying screws) away from the work area to prevent damage.

---

### Plastic parts

Using excessive force during disassembly and reassembly can damage plastic parts.

### Cables and connectors

Handle cables with extreme care to avoid damage.

---

 **IMPORTANT:** When servicing the computer, be sure that cables are placed in their proper locations during the reassembly process. Improper cable placement can damage the computer.

---

Apply only the tension required to unseat or seat the cables during removal and insertion. Handle cables by the connector whenever possible. In all cases, avoid bending, twisting, or tearing cables. Be sure that cables are routed so that they cannot be caught or snagged as you remove or replace parts. Handle flex cables with extreme care; these cables tear easily.

### Drive handling

Note the following guidelines when handling drives.

---

 **IMPORTANT:** Drives are fragile components. Handle them with care. To prevent damage to the computer, damage to a drive, or loss of information, observe these precautions:

Before removing or inserting a hard drive, shut down the computer. If you are unsure whether the computer is off or in Hibernation, turn the computer on, and then shut it down through the operating system.

Before handling a drive, be sure that you are discharged of static electricity. While handling a drive, avoid touching the connector.

Before removing an optical drive, be sure that a disc is not in the drive, and be sure that the optical drive tray is closed.

Handle drives on surfaces covered with at least 2.54 cm (1 inch) of shock-proof foam.

Avoid dropping drives from any height onto any surface.

After removing a hard drive or an optical drive, place it in a static-proof bag.

Avoid exposing an internal hard drive to products that have magnetic fields, such as monitors or speakers.

Avoid exposing a drive to temperature extremes or liquids.

If a drive must be mailed, place the drive in a bubble pack mailer or other suitable form of protective packaging, and label the package “FRAGILE.”

---

# Electrostatic discharge information

A sudden discharge of static electricity from your finger or other conductor can destroy static-sensitive devices or microcircuitry. Often the spark is neither felt nor heard, but damage occurs. An electronic device exposed to electrostatic discharge (ESD) might not appear to be affected at all and can work perfectly throughout a normal cycle. The device might function normally for a while, but it has been degraded in the internal layers, reducing its life expectancy.

Networks built into many integrated circuits provide some protection, but in many cases, the discharge contains enough power to alter device parameters or melt silicon junctions.

 **IMPORTANT:** To prevent damage to the device when you remove or install internal components, observe these precautions:

Keep components in their electrostatic-safe containers until you are ready to install them.

Before touching an electronic component, discharge static electricity by using the guidelines described [Personal grounding methods and equipment on page 20](#).

Avoid touching pins, leads, and circuitry. Handle electronic components as little as possible.

If you remove a component, place it in an electrostatic-safe container.

## Generating static electricity

Follow these static electricity guidelines.

- Different activities generate different amounts of static electricity.
- Static electricity increases as humidity decreases.

**Table 4-1** Static electricity occurrence based on activity and humidity

| Event   | Relative humidity |          |          |
|---|-------------------|----------|----------|
|   | 55%               | 40%      | 10%      |
| Walking across carpet                                   | 7,500 V           | 15,000 V | 35,000 V |
| Walking across vinyl floor                              | 3,000 V           | 5,000 V  | 12,000 V |
| Motions of bench worker                                 | 400 V             | 800 V    | 6,000 V  |
| Removing DIPs (dual in-line packages) from plastic tube | 400 V             | 700 V    | 2,000 V  |
| Removing DIPs from vinyl tray                           | 2,000 V           | 4,000 V  | 11,500 V |
| Removing DIPs from polystyrene foam                     | 3,500 V           | 5,000 V  | 14,500 V |
| Removing bubble pack from PCB (printed circuit board)   | 7,000 V           | 20,000 V | 26,500 V |
| Packing PCBs in foam-lined box                          | 5,000 V           | 11,000 V | 21,000 V |

Multiple electric components can be packaged together in plastic tubes, trays, or polystyrene foam.

 **NOTE:** As little as 700 V can degrade a product.

## Preventing electrostatic damage to equipment

Many electronic components are sensitive to ESD. Circuitry design and structure determine the degree of sensitivity. The following packaging and grounding precautions are necessary to prevent static electricity damage to electronic components.

- To avoid hand contact, transport products in static-safe containers such as tubes, bags, or boxes.
- Protect all electrostatic parts and assemblies with conductive or approved containers or packaging.
- Keep electrostatic-sensitive parts in their containers until they arrive at static-free stations.
- Place items on a grounded surface before removing them from their container.
- Always be properly grounded when touching a sensitive component or assembly.
- Avoid contact with pins, leads, or circuitry.
- Place reusable electrostatic-sensitive parts from assemblies in protective packaging or conductive foam.

## Personal grounding methods and equipment

Using certain equipment can prevent static electricity damage to electronic components.

- **Wrist straps** are flexible straps with a maximum of  $1\text{ M}\Omega \pm 10\%$  resistance in the ground cords. To provide proper ground, a strap must be worn snug against bare skin. The ground cord must be connected and fit snugly into the banana plug connector on the grounding mat or workstation.
- **Heel straps/Toe straps/Boot straps** can be used at standing workstations and are compatible with most types of shoes or boots. On conductive floors or dissipative floor mats, use them on both feet with a maximum of  $1\text{ M}\Omega \pm 10\%$  resistance between the operator and ground.

**Table 4-2** Static shielding protection levels

| Static shielding protection levels |         |
|------------------------------------|---------|
| Method                             | Voltage |
| Antistatic plastic                 | 1,500   |
| Carbon-loaded plastic              | 7,500   |
| Metallized laminate                | 15,000  |

## Grounding the work area

To prevent static damage at the work area, follow these precautions.

- Cover the work surface with approved static-dissipative material.
- Use a wrist strap connected to a properly grounded work surface and use properly grounded tools and equipment.
- Use static-dissipative mats, foot straps, or air ionizers to give added protection.
- Handle electrostatic sensitive components, parts, and assemblies by the case or PCB laminate. Handle them only at static-free work areas.
- Turn off power and input signals before inserting and removing connectors or test equipment.

- Use fixtures made of static-safe materials when fixtures must directly contact dissipative surfaces.
- Keep the work area free of nonconductive materials, such as ordinary plastic assembly aids and polystyrene foam.
- Use conductive field service tools, such as cutters, screwdrivers, and vacuums.
- Avoid contact with pins, leads, or circuitry.

## Recommended materials and equipment

HP recommends certain materials and equipment to prevent static electricity.

- Antistatic tape
- Antistatic smocks, aprons, or sleeve protectors
- Conductive bins and other assembly or soldering aids
- Conductive foam
- Conductive tabletop workstations with ground cord of  $1\text{ M}\Omega \pm 10\%$  resistance
- Static-dissipative table or floor mats with hard tie to ground
- Field service kits
- Static awareness labels
- Wrist straps and footwear straps providing  $1\text{ M}\Omega \pm 10\%$  resistance
- Material handling packages
- Conductive plastic bags
- Conductive plastic tubes
- Conductive tote boxes
- Opaque shielding bags
- Transparent metallized shielding bags
- Transparent shielding tubes

# Cleaning your computer

Cleaning your computer regularly removes dirt and debris so that your device continues to operate at its best. Use the following information to safely clean the external surfaces of your computer.

## Enabling HP Easy Clean (select products only)

HP Easy Clean helps you to avoid accidental input while you clean the computer surfaces. This software disables devices such as the keyboard, touch screen, and touchpad for a preset amount of time so that you can clean all computer surfaces.

1. Start HP Easy Clean in one of the following ways:
  - Select the **Start** menu, and then select **HP Easy Clean**.  
– or –
  - Select the **HP Easy Clean** icon in the taskbar.  
– or –
  - Select **Start**, and then select the **HP Easy Clean** tile.
2. Now that your device is disabled for a short period, see [Removing dirt and debris from your computer on page 22](#) for the recommended steps to clean the high-touch, external surfaces on your computer. After you remove the dirt and debris, you can also clean the surfaces with a disinfectant. See [Cleaning your computer with a disinfectant on page 23](#) for guidelines to help prevent the spread of harmful bacteria and viruses.

## Removing dirt and debris from your computer

Here are the recommended steps to clean dirt and debris from your computer.

For computers with wood veneer, see [Caring for wood veneer \(select products only\) on page 24](#).

1. Wear disposable gloves made of latex (or nitrile gloves, if you are latex-sensitive) when cleaning the surfaces.
2. Turn off your device and unplug the power cord and other connected external devices. Remove any installed batteries from items such as wireless keyboards.

---

 **CAUTION:** To prevent electric shock or damage to components, never clean a product while it is turned on or plugged in.

---

3. Moisten a microfiber cloth with water. The cloth should be moist, but not dripping wet.

---

 **IMPORTANT:** To avoid damaging the surface, avoid abrasive cloths, towels, and paper towels.

---

4. Wipe the exterior of the product gently with the moistened cloth.

---

 **IMPORTANT:** Keep liquids away from the product. Avoid getting moisture in any openings. If liquid makes its way inside your HP product, it can cause damage to the product. Do not spray liquids directly on the product. Do not use aerosol sprays, solvents, abrasives, or cleaners containing hydrogen peroxide or bleach that might damage the finish.

---

5. Start with the display (if applicable). Wipe carefully in one direction, and move from the top of the display to the bottom. Finish with any flexible cables, like power cord, keyboard cable, and USB cables.

6. Be sure that surfaces have completely air-dried before turning the device on after cleaning.
7. Discard the gloves after each cleaning. Clean your hands immediately after you remove the gloves.

See [Cleaning your computer with a disinfectant on page 23](#) for recommended steps to clean the high-touch, external surfaces on your computer to help prevent the spread of harmful bacteria and viruses.

## Cleaning your computer with a disinfectant

The World Health Organization (WHO) recommends cleaning surfaces, followed by disinfection, as a best practice for preventing the spread of viral respiratory illnesses and harmful bacteria.

After cleaning the external surfaces of your computer using the steps in [Removing dirt and debris from your computer on page 22](#), [Caring for wood veneer \(select products only\) on page 24](#), or both, you might also choose to clean the surfaces with a disinfectant. A disinfectant that is within HP's cleaning guidelines is an alcohol solution consisting of 70% isopropyl alcohol and 30% water. This solution is also known as rubbing alcohol and is sold in most stores.

Follow these steps when disinfecting high-touch, external surfaces on your computer:

1. Wear disposable gloves made of latex (or nitrile gloves, if you are latex-sensitive) when cleaning the surfaces.
2. Turn off your device and unplug the power cord and other connected external devices. Remove any installed batteries from items such as wireless keyboards.

---

 **CAUTION:** To prevent electric shock or damage to components, never clean a product while it is turned on or plugged in.

---

3. Moisten a microfiber cloth with a mixture of 70% isopropyl alcohol and 30% water. The cloth should be moist, but not dripping wet.

---

 **CAUTION:** Do not use any of the following chemicals or any solutions that contain them, including spray-based surface cleaners: bleach, peroxides (including hydrogen peroxide), acetone, ammonia, ethyl alcohol, methylene chloride, or any petroleum-based materials, such as gasoline, paint thinner, benzene, or toluene.

---

 **IMPORTANT:** To avoid damaging the surface, avoid abrasive cloths, towels, and paper towels.

---

4. Wipe the exterior of the product gently with the moistened cloth.

---

 **IMPORTANT:** Keep liquids away from the product. Avoid getting moisture in any openings. If liquid makes its way inside your HP product, it can cause damage to the product. Do not spray liquids directly on the product. Do not use aerosol sprays, solvents, abrasives, or cleaners containing hydrogen peroxide or bleach that might damage the finish.

---

5. Start with the display (if applicable). Wipe carefully in one direction, and move from the top of the display to the bottom. Finish with any flexible cables, like power cord, keyboard cable, and USB cables.
6. Be sure that surfaces have completely air-dried before turning the device on after cleaning.
7. Discard the gloves after each cleaning. Clean your hands immediately after you remove the gloves.

## Caring for wood veneer (select products only)

Your product might feature high-quality wood veneer. As with all natural wood products, proper care is important for best results over the life of the product. Because of the nature of natural wood, you might see unique variations in the grain pattern or subtle variations in color, which are normal.

- Clean the wood with a dry, static-free microfiber cloth or chamois.
- Avoid cleaning products containing substances such as ammonia, methylene chloride, acetone, turpentine, or other petroleum-based solvents.
- Do not expose the wood to sun or moisture for long periods of time.
- If the wood becomes wet, dry it by dabbing with an absorbent, lint-free cloth.
- Avoid contact with any substance that might dye or discolor the wood.
- Avoid contact with sharp objects or rough surfaces that might scratch the wood.

See [Removing dirt and debris from your computer on page 22](#) for the recommended steps to clean the high-touch, external surfaces on your computer. After you remove the dirt and debris, you can also clean the surfaces with a disinfectant. See [Cleaning your computer with a disinfectant on page 23](#) for sanitizing guidelines to help prevent the spread of harmful bacteria and viruses.

## Packaging and transporting guidelines

Follow these grounding guidelines when packaging and transporting equipment.

- To avoid hand contact, transport products in static-safe tubes, bags, or boxes.
- Protect ESD-sensitive parts and assemblies with conductive or approved containers or packaging.
- Keep ESD-sensitive parts in their containers until the parts arrive at static-free workstations.
- Place items on a grounded surface before removing items from their containers.
- Always be properly grounded when touching a component or assembly.
- Store reusable ESD-sensitive parts from assemblies in protective packaging or nonconductive foam.
- Use transporters and conveyors made of antistatic belts and roller bushings. Be sure that mechanized equipment used for moving materials is wired to ground and that proper materials are selected to avoid static charging. When grounding is not possible, use an ionizer to dissipate electric charges.

## Accessing support information

Use this information to find the HP support that you need.



**Table 4-3** Support information locations

| Service consideration  | Path to access information  |
|--|---|
| Records of reported failure incidents stored on the computer | <p><b>Windows:</b></p> <p>Pre-operating system failures are logged in the BIOS Event Log. To view the BIOS Event Log:</p> <ol style="list-style-type: none"><li>1. Press the power button.</li><li>2. Immediately and repeatedly press <b>esc</b> when the power button light turns white.</li></ol> <p><b>NOTE:</b> If you do not press <b>esc</b> at the appropriate time, you must restart the computer and again repeatedly press <b>esc</b> when the power button light turns white to access the utility.</p> <ol style="list-style-type: none"><li>3. Press <b>f10</b> to enter the BIOS setup.</li><li>4. (On commercial products) Under the <b>Main</b> tab, select <b>BIOS event log</b>, and then select <b>View BIOS Event Log</b>.</li></ol> <p>- or -</p> <p>(On consumer products) Under the <b>Main</b> tab, select <b>System Log</b>.</p> <p>Post operating system failures are logged in the Event Viewer.</p> <ol style="list-style-type: none"><li>1. Turn on the computer and allow the operating system to open.</li><li>2. Click the search icon  in the taskbar.</li><li>3. Type <code>Event Viewer</code>, and then press <b>enter</b>.</li><li>4. Select the log from the left panel. Details display in the right panel.</li></ol> <p><b>Chrome:</b></p> <ol style="list-style-type: none"><li>1. Go to <a href="https://support.google.com/chrome">support.google.com/chrome</a>.</li><li>2. Search <code>collect Chrome device logs</code>.</li></ol> |
| Technical bulletins  | <p>To locate technical bulletins:</p> <ol style="list-style-type: none"><li>1. Go to <a href="https://www.hp.com">www.hp.com</a>.</li><li>2. Place the cursor over <b>Problem solving</b> to display more options.</li><li>3. Select <b>Support &amp; Troubleshooting</b>.</li><li>4. Type the serial number, product number, or product name to go to the product support page.</li><li>5. Select <b>Advisories</b> to view technical bulletins.</li></ol>   |

**Table 4-3** Support information locations (continued)

| Service consideration   | Path to access information   |
|---|--|
| Repair professionals  | To locate repair professionals:<br><ol style="list-style-type: none"><li data-bbox="678 310 1439 346">1. Go to <a href="http://www.hp.com">www.hp.com</a>.</li><li data-bbox="678 363 1439 399">2. Place the cursor over <b>Support resources</b> to display more options.</li><li data-bbox="678 415 1439 447">3. Select <b>Authorized service providers</b>.</li></ol>   |
| Component and diagnosis information, failure detection, and required action | To locate diagnosis information and actions:<br><ol style="list-style-type: none"><li data-bbox="678 516 1439 552">1. Go to <a href="http://www.hp.com/go/techcenter/pcdiags">http://www.hp.com/go/techcenter/pcdiags</a>.</li><li data-bbox="678 569 1439 604">2. Select <b>Get Support</b>.</li><li data-bbox="678 621 1439 646">3. Near the bottom of the window, select <b>Notebook PCs</b>, and the select your location.</li></ol> |

---

## 5 Removal and replacement procedures for authorized service provider parts

This chapter provides removal and replacement procedures for authorized service provider parts.

---

 **IMPORTANT:** Components described in this chapter should be accessed only by an authorized service provider. Accessing these parts can damage the computer or void the warranty.

 **NOTE:** Details about your computer, including model, serial number, product key, and length of warranty, are on the service tag at the bottom of your computer.

---

# Component replacement procedures

To remove and replace computer components, use these procedures.



---

**NOTE:** HP continually improves and changes product parts. For complete and current information about supported parts for your computer, go to <http://partsurfer.hp.com>, select your country or region, and then follow the on-screen instructions.

---

You must remove, replace, or loosen as many as 48 screws when you service the parts described in this chapter. Make special note of each screw size and location during removal and replacement.

## Preparation for disassembly

### Top cover/keyboard

To remove the top cover/keyboard, use this procedure and illustration.

 **NOTE:** The top cover/keyboard spare part kit includes keyboard cable.

**Table 5-1** Top cover/keyboard description and part numbers

| For use in country/region   | Spare part number | For use in country/region     | Spare part number |
|---|-------------------|-------------------------------|-------------------|
| Top cover/keyboard in jet black finish (includes keyboard cable):     |                   |                               |                   |
| For use in Belgium  | M47382-A41        | For use in Romania            | M47382-271        |
| For use in Brazil   | M47382-201        | For use in Russia             | M47382-251        |
| For use in Canada   | M47382-DB1        | For use in Saudi Arabia       | M47382-171        |
| For use in the Czech Republic and Slovakia                            | M47382-FL1        | For use in Slovenia           | M47382-BA1        |
| For use in Denmark, Finland, and Norway                               | M47382-DH1        | For use in South Korea        | M47382-AD1        |
| For use in France   | M47382-051        | For use in Spain              | M47382-071        |
| For use in Germany  | M47382-041        | For use in Sweden and Finland | M47382-B71        |
| For use in Israel   | M47382-BB1        | For use in Switzerland        | M47382-BG1        |
| For use in Italy  | M47382-061        | For use in Taiwan             | M47382-AB1        |
| For use in Japan  | M47382-291        | For use in Thailand           | M47382-281        |
| For use in Latin America  | M47382-161        | For use in Turkey             | M47382-141        |
| For use in the Netherlands  | M47382-B31        | For use in the United Kingdom | M47382-031        |
| For use in Portugal   | M47382-131        | For use in the United States  | M47382-001        |
| Top cover/keyboard in nautical teal finish (includes keyboard cable): |                   |                               |                   |
| For use in Belgium  | M47383-A41        | For use in Romania            | M47383-271        |
| For use in Brazil   | M47383-201        | For use in Russia             | M47383-251        |
| For use in Canada   | M47383-DB1        | For use in Saudi Arabia       | M47383-171        |
| For use in the Czech Republic and Slovakia                            | M47383-FL1        | For use in Slovenia           | M47383-BA1        |
| For use in Denmark, Finland, and Norway                               | M47383-DH1        | For use in South Korea        | M47383-AD1        |
| For use in France   | M47383-051        | For use in Spain              | M47383-071        |
| For use in Germany  | M47383-041        | For use in Sweden and Finland | M47383-B71        |
| For use in Israel   | M47383-BB1        | For use in Switzerland        | M47383-BG1        |
| For use in Italy  | M47383-061        | For use in Taiwan             | M47383-AB1        |
| For use in Japan  | M47383-291        | For use in Thailand           | M47383-281        |
| For use in Latin America  | M47383-161        | For use in Turkey             | M47383-141        |

**Table 5-1** Top cover/keyboard description and part numbers (continued)

| For use in country/region  | Spare part number | For use in country/region     | Spare part number |
|----------------------------|-------------------|-------------------------------|-------------------|
| For use in the Netherlands | M47383-B31        | For use in the United Kingdom | M47383-031        |
| For use in Portugal        | M47383-131        | For use in the United States  | M47383-001        |

Before removing the top cover/keyboard, prepare the computer for disassembly (see [Preparation for disassembly on page 29](#)).

Remove the top cover/keyboard:

1. Turn the computer upside down with the front toward you.
2. Remove the two Phillips PM2.5×8.5 screws (1) that secure the top cover/keyboard to the base enclosure.
3. Remove the four Phillips PM2.5×6.9 screws (2) that secure the top cover/keyboard to the base enclosure.

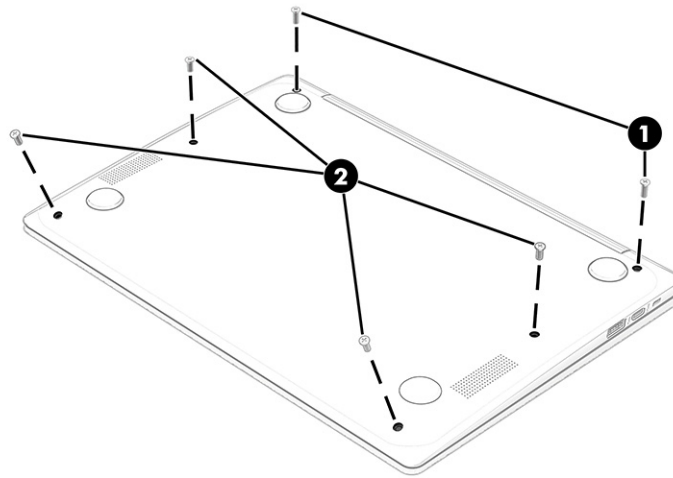

4. Open the computer and rest it on the display back cover.

5. Insert a keyboard removal tool into the top cover/keyboard rear screw holes and press until the top cover/keyboard rear edge disengages from the base enclosure.

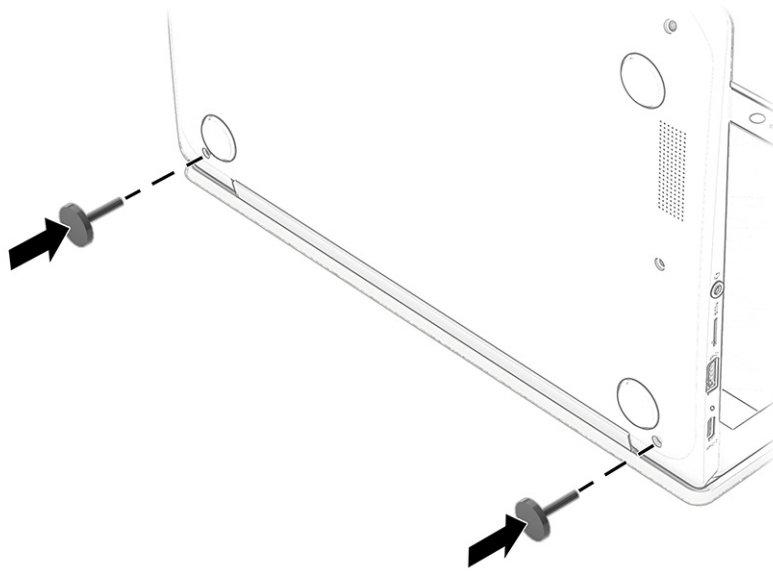

6. Position the computer with the base enclosure resting on the work surface.
7. Swing the rear edge of the top cover/keyboard (1) up and away from the computer as far as the keyboard and touchpad cables allow.
8. Release the zero insertion force (ZIF) connector (2) to which the keyboard cable is connected, and then disconnect the keyboard cable from the system board.
9. Release the ZIF connector (3) to which the touchpad cable is connected, and then disconnect the touchpad cable from the system board.
10. Remove the top cover/keyboard (4).

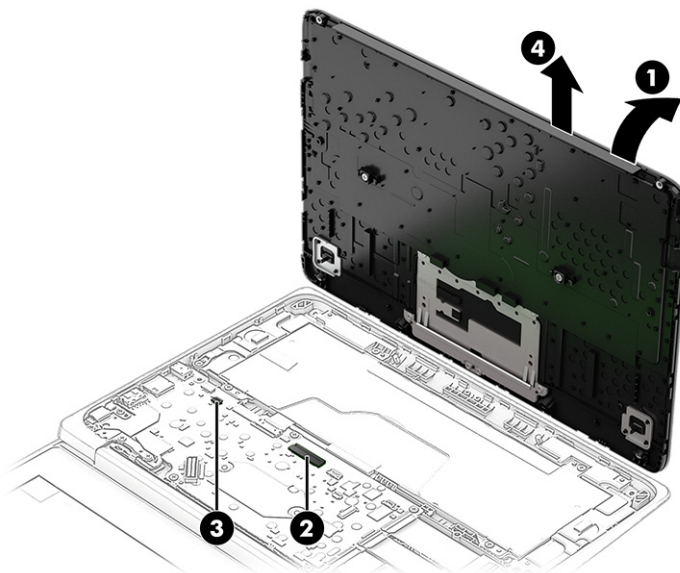

11. Each time the top cover/keyboard is removed, inspect, and if necessary, thoroughly clean the thermal material from the system board **(1)** and the surface of the top cover/keyboard **(2)**. Replacement thermal material is included with the top cover/keyboard and system board spare part kits.

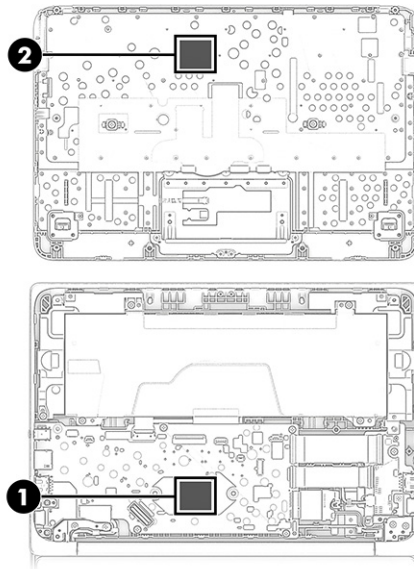

Reverse this procedure to install the top cover/keyboard.

## Touchpad cable

To remove the touchpad cable, use this procedure and illustration.

 **NOTE:** The touchpad cable is included in the Cable Kit, spare part number M47368-001.

Before removing the touchpad cable, follow these steps:

1. Prepare the computer for disassembly (see [Preparation for disassembly on page 29](#)).
2. Remove the top cover/keyboard (see [Top cover/keyboard on page 29](#)).

Remove the touchpad cable:

1. Position the top cover/keyboard upside down with the front toward you.
2. Detach the touchpad cable **(1)** from the top cover/keyboard. (The touchpad cable is attached to the top cover/keyboard with double-sided adhesive.)
3. Detach the clear shield **(2)** that covers the touchpad cable zero insertion force (ZIF) connector.
4. Release the ZIF connector **(3)** to which the touchpad cable is connected, and then disconnect the touchpad cable from the touchpad.



- Remove the touchpad cable (4).

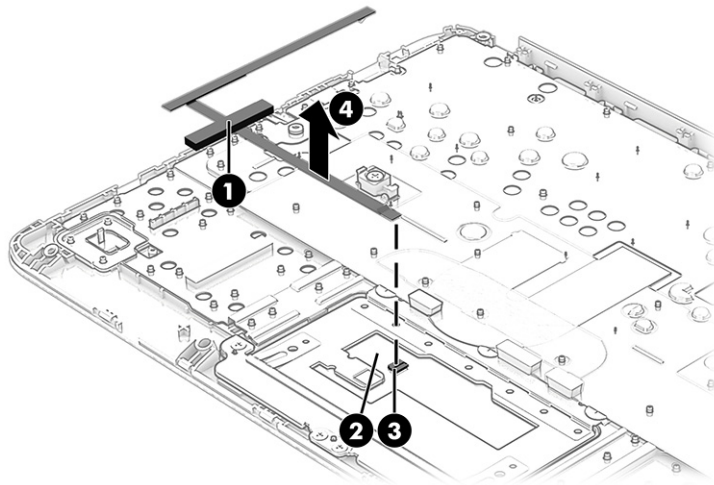

Reverse this procedure to install the touchpad cable

## Touchpad

To remove the touchpad, use this procedure and illustration.

**Table 5-2** Touchpad description and part numbers

| Description  | Spare part number |
|--|-------------------|
| Touchpad:  |                   |
| <b>NOTE:</b> The touchpad spare part kit does not include the touchpad bracket or touchpad cable. The touchpad bracket is included in the Bracket Kit, spare part number L89791-001 The touchpad cable is included in the Cable Kit, spare part number M47368-001. |                   |
| In jet black finish  | M47384-001        |
| In nautical teal finish  | M47385-001        |

Before removing the touchpad, follow these steps:

- Prepare the computer for disassembly (see [Preparation for disassembly on page 29](#)).
- Remove the top cover/keyboard (see [Top cover/keyboard on page 29](#)).

Remove the touchpad:

- Position the top cover/keyboard upside down with the front toward you.
- Detach the touchpad cable (1) from the top cover/keyboard. (The touchpad cable is attached to the top cover/keyboard with double-sided adhesive.)
- Detach the clear shield (2) that covers the touchpad screws.
- Remove the three Phillips M2.0 × 2.2 broad head screws (3) that secure the touchpad to the computer.
- Remove the four Phillips M2.0 × 2.5 screws (4) that secure the touchpad bracket and touchpad to the computer.

6. Remove the touchpad bracket (5).  
The touchpad bracket is available using spare part number L89791-001.
7. Remove the touchpad (6).

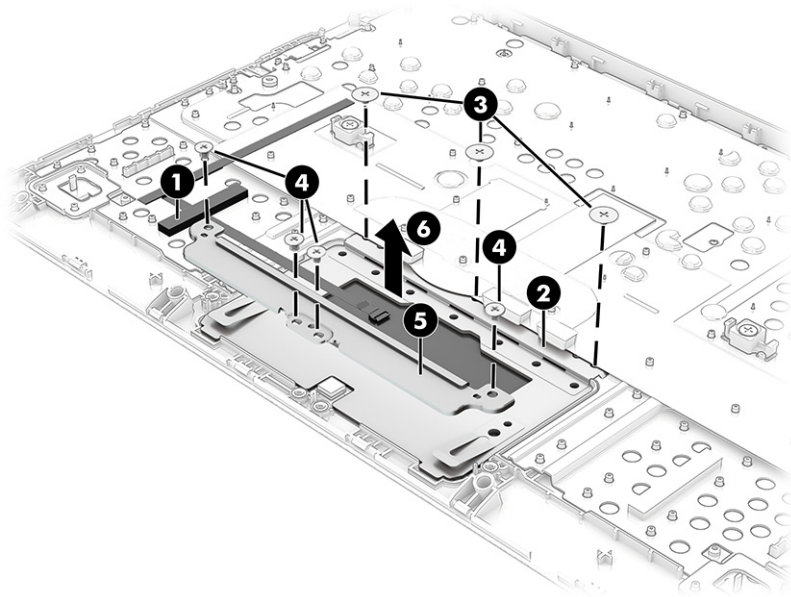

Reverse this procedure to install the touchpad.

## Battery

To remove the touchpad cable, use this procedure and illustration.

**Table 5-3 Battery description and part number**

| Description                            | Spare part number |
|--|-------------------|
| Battery (2 cell, 47 Whr, 6.15 Ahr, Li) | L75783-005        |
| Battery tape                           | L14905-001        |

Before removing the battery, follow these steps:

1. Prepare the computer for disassembly (see [Preparation for disassembly on page 29](#)).
2. Remove the top cover/keyboard (see [Top cover/keyboard on page 29](#)).

Remove the battery:

1. Disconnect the battery cable (1) from the system board.
2. Release the speaker cable (2) from the retention clips built into the front edge of the battery.
3. Remove the four Phillips M2.0 × 4.2 screws (3) that secure the battery to the computer.
4. Remove the battery shield (4).

The battery shield is available using spare part number L98587-001.

5. Remove the battery (5).

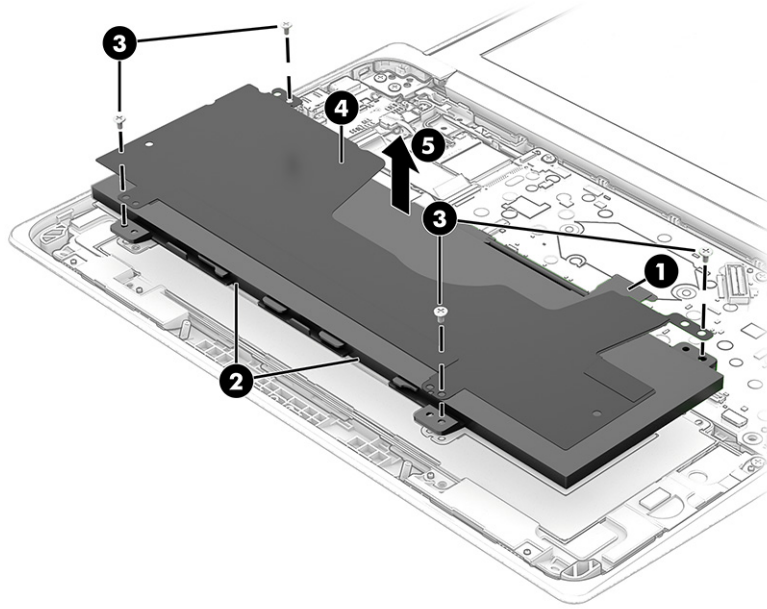

Reverse this procedure to install the battery.

## WLAN module

To remove the WLAN module, use this procedure and illustration.

**Table 5-4** WLAN module descriptions and part numbers

| Description   | Spare part number |
|---|-------------------|
| Intel Wi-Fi 6 AX201 ax 2x2 + Bluetooth 5.0 MU-MIMO M.2 2230 non-vPro 160MHz MIPI+BRI WW WLAN module | L92724-005        |

**IMPORTANT:** To prevent an unresponsive system, replace the wireless module only with a wireless module authorized for use in the computer by the governmental agency that regulates wireless devices in your country or region. If you replace the module and then receive a warning message, remove the module to restore device functionality, and then contact technical support.

Before removing the WLAN module, follow these steps:

1. Prepare the computer for disassembly (see [Preparation for disassembly on page 29](#)).
2. Remove the top cover/keyboard (see [Top cover/keyboard on page 29](#)).
3. Disconnect the battery cable from the system board (see [Battery on page 34](#)).

Remove the WLAN module:

1. Carefully disconnect the wireless antenna cables (1) from the WLAN module.

 **NOTE:** Computer models have either one or two WLAN antennas. On models with two antennas, the #1 white WLAN antenna cable connects to the WLAN module #1 Main terminal. The #2 black WLAN antenna cable connects to the WLAN module #1 Aux terminal.

2. Remove the Phillips M2.0 × 2.9 screw (2) that secures the WLAN module bracket and WLAN module to the system board.

3. Remove the WLAN module bracket (3).

The WLAN module bracket is available using spare part number M00452-001.

4. Remove the WLAN module (4).

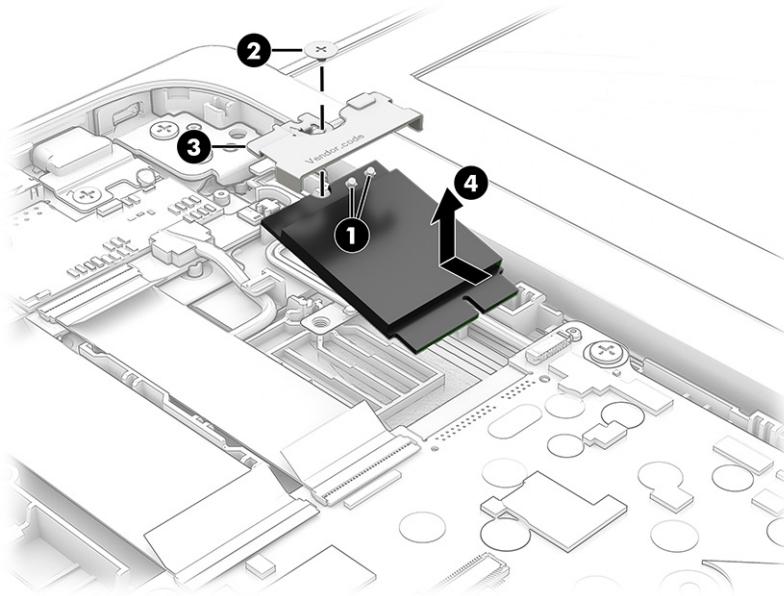

5. If the WLAN antenna is not connected to the terminal on the WLAN module, install a protective sleeve on the antenna connector, as shown in the following illustration.

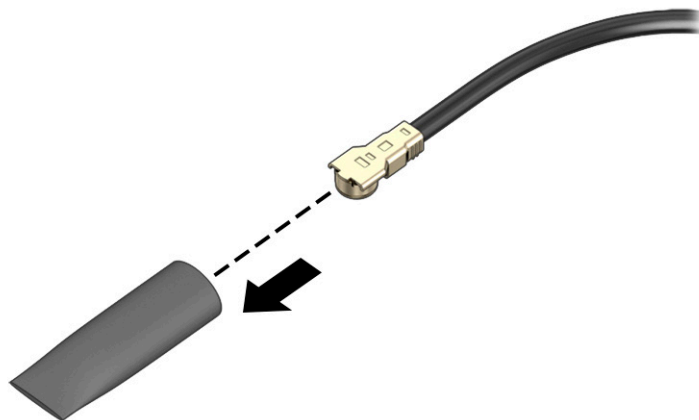

Reverse this procedure to install the WLAN module.

## Speakers

To remove the speakers, use this procedure and illustration.

**Table 5-5** Speaker description and part number

| Description   | Spare part number |
|---|-------------------|
| Speakers (include left and right speakers and cables) | M55117-001        |

Before removing the speakers, follow these steps:

1. Prepare the computer for disassembly (see [Preparation for disassembly on page 29](#)).
2. Remove the top cover/keyboard (see [Top cover/keyboard on page 29](#)).
3. Disconnect the battery cable from the system board (see [Battery on page 34](#)).

Remove the speakers:

1. Disconnect the speaker cable (1) from the system board.
2. Release the speaker cable (2) from the retention clips built into the base enclosure.
3. Remove the three Phillips M2.0 × 4.2 screws (3) that secure the speakers to the computer.
4. Remove the speakers (4).

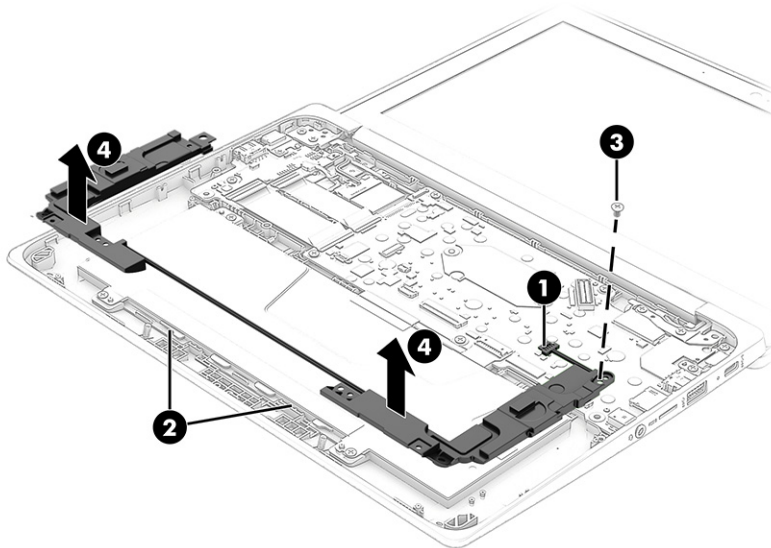

Reverse this procedure to install the speakers.

## Connector board cables

To remove the connector board cables, use this procedure and illustration.

 **NOTE:** The connector board cables are included in the Cable Kit, spare part number M47368-001, and include double-sided adhesive.

Before removing the connector board cables, follow these steps:

1. Prepare the computer for disassembly (see [Preparation for disassembly on page 29](#)).
2. Remove the top cover/keyboard (see [Top cover/keyboard on page 29](#)).
3. Disconnect the battery cable from the system board (see [Battery on page 34](#)).

Remove the connector board cables:

1. Release the zero insertion force (ZIF) connectors **(1)** to which the connector board cables are connected, and then disconnect the connector board cables from the system board.
2. Release the ZIF connectors **(2)** to which the connector board cables are connected, and then disconnect the connector board cables from the connector board.

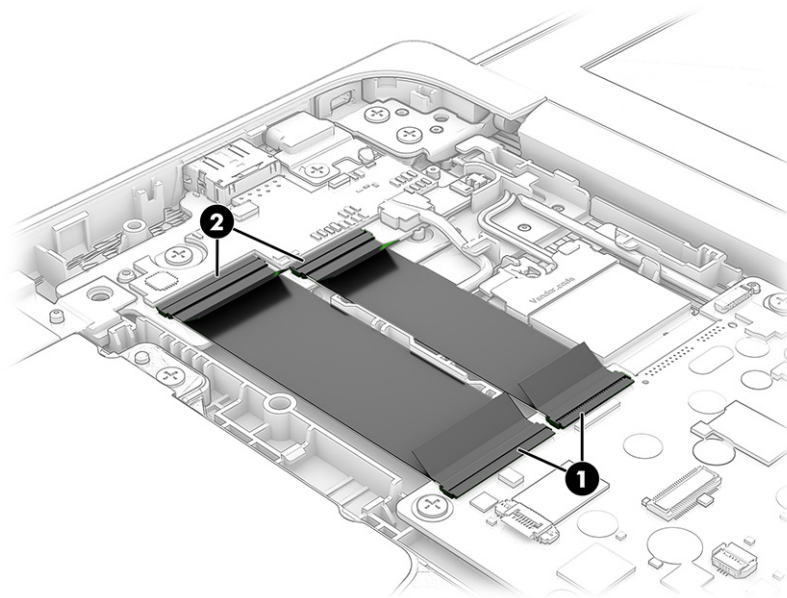

3. Remove the connector board cables.

Reverse this procedure to install the connector board cables.

## Connector board

To remove the connector board, use this procedure and illustration.

**Table 5-6** Connector board description and part number

| Description                                       | Spare part number |
|---|-------------------|
| Connector board (includes HDMI port and USB port) | M47369-001        |

**NOTE:** The connector board spare part kit does not include the connector board cables. The connector board cables are included in the Cable Kit, spare part number M47368-001.

Before removing the connector board, follow these steps:

1. Prepare the computer for disassembly (see [Preparation for disassembly on page 29](#)).
2. Remove the top cover/keyboard (see [Top cover/keyboard on page 29](#)).
3. Disconnect the battery cable from the system board (see [Battery on page 34](#)).

Remove the connector board:

1. Release the ZIF connectors (1) to which the connector board cables are connected, and then disconnect the connector board cables from the system board.
2. Remove the two Phillips M2.0 × 4.2 screws (2) that secure the connector board to the computer.
3. Remove the connector board I/O bracket (3).

The connector board I/O bracket is available using spare part number L89793-001.

4. Remove the connector board (4).

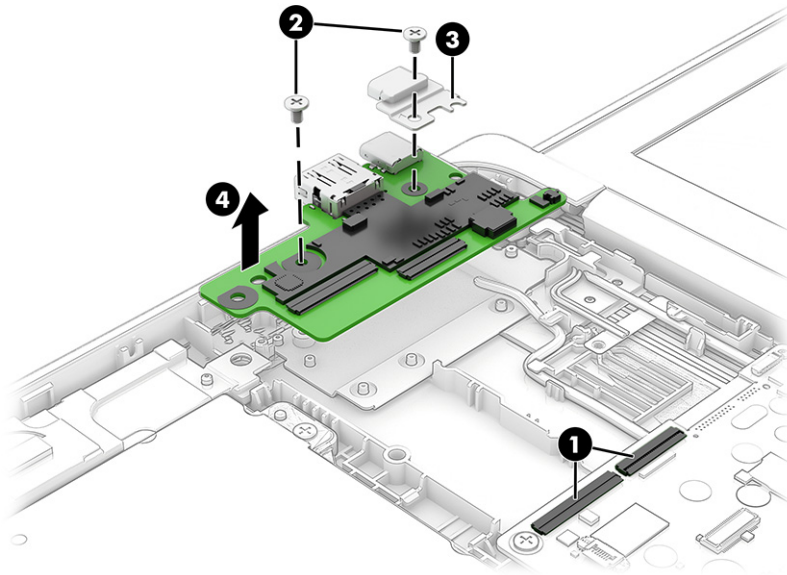

Reverse this procedure to install the connector board.

## System board

To remove the system board, use these procedures and illustrations.

**Table 5-7** System board descriptions and part numbers

| Description   | Spare part number |
|---|-------------------|
| <b>System board</b> (includes a graphics subsystem with UMA memory, replacement thermal material, and the Chrome operating system): |                   |
| Equipped with an Intel Celeron N5100 processor, 8 GB of system memory, and 64 GB of eMMC system storage                             | M47374-001        |
| Equipped with an Intel Celeron N5100 processor, 8 GB of system memory, and 32 GB of eMMC system storage                             | M47373-001        |
| Equipped with an Intel Celeron N5100 processor, 4 GB of system memory, and 32 GB of eMMC system storage                             | M47372-001        |
| Equipped with an Intel Celeron N4500 processor, 8 GB of system memory, and 64 GB of eMMC system storage                             | M56147-001        |

**Table 5-7 System board descriptions and part numbers (continued)**

| Description   | Spare part number |
|---|-------------------|
| Equipped with an Intel Celeron N4500 processor, 8 GB of system memory, and 32 GB of eMMC system storage | M56146-001        |
| Equipped with an Intel Celeron N4500 processor, 4 GB of system memory, and 64 GB of eMMC system storage | M47371-001        |
| Equipped with an Intel Celeron N4500 processor, 4 GB of system memory, and 32 GB of eMMC system storage | M47370-001        |

Before removing the system board, follow these steps:

1. Prepare the computer for disassembly (see [Preparation for disassembly on page 29](#)).
2. Remove the top cover/keyboard (see [Top cover/keyboard on page 29](#)).
3. Disconnect the battery cable from the system board (see [Battery on page 34](#)).
4. Remove the WLAN module (see [WLAN module on page 35](#)).
5. Remove the speakers (see [Speakers on page 37](#)).

Remove the system board:

1. Disconnect the webcam/microphone cable **(1)** from the system board.
2. Disconnect the display panel cable **(2)** from the system board.
3. Release the ZIF connector **(3)** to which the connector board low-power cable is connected, and then disconnect the connector board low-power cable from the system board.
4. Release the ZIF connector **(4)** to which the connector board high-power cable is connected, and then disconnect the connector board high-power cable from the system board.

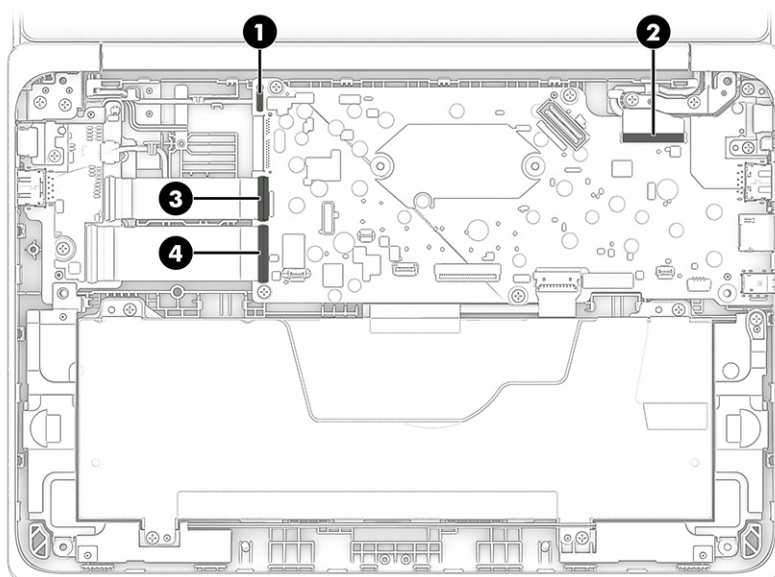

5. Remove the six Phillips M2.0 × 4.2 screws **(1)** that secure the system board to the computer.



6. Remove the system board I/O bracket (2).

The system board I/O bracket is included in the Bracket Kit, spare part number L89793-001.

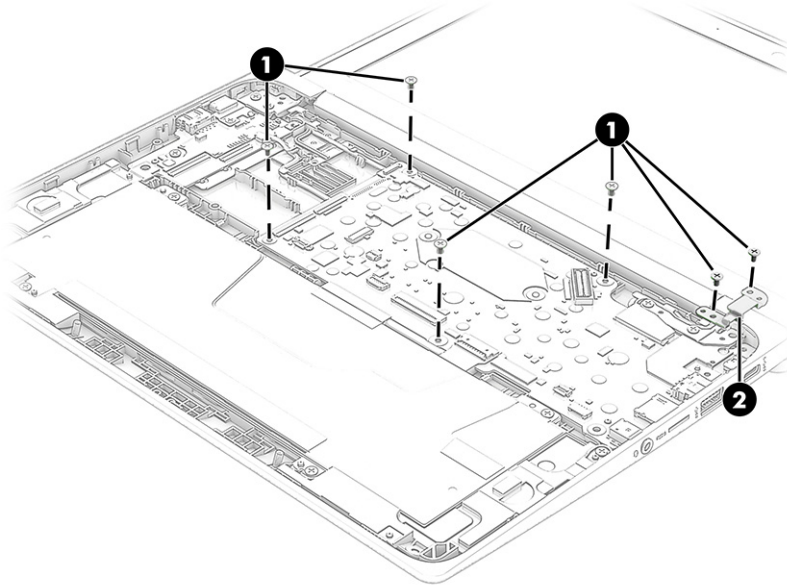

7. Lift the left side of the system board (1) until it rests at an angle.
8. Slide the system board (2) up and to the left at an angle to remove it.

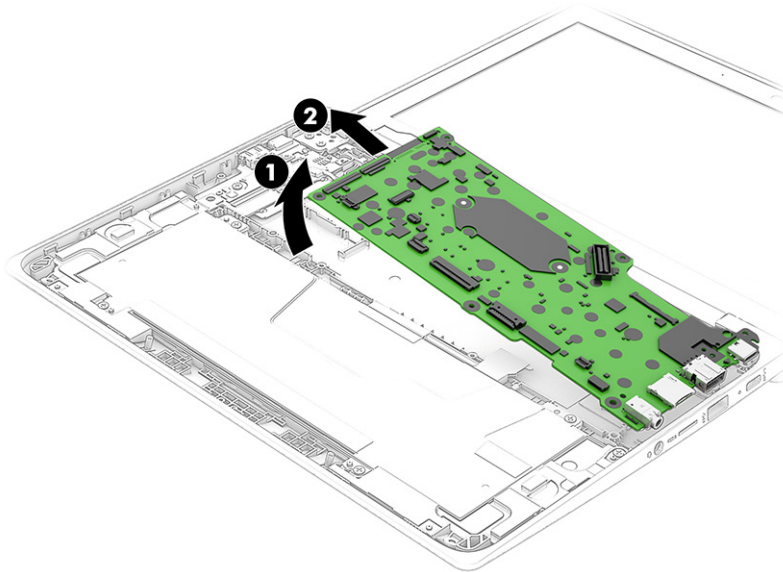

Reverse this procedure to install the system board.

## Heat sink

To remove the heat sink, use these procedures and illustrations.

**Table 5-8** Heat sink descriptions and part numbers

| Description                                       | Spare part number |
|---|-------------------|
| Heat sink (includes replacement thermal material) | M47196-001        |

Before removing the heat sink, follow these steps:

1. Prepare the computer for disassembly (see [Preparation for disassembly on page 29](#)).
2. Remove the top cover/keyboard (see [Top cover/keyboard on page 29](#)).
3. Disconnect the battery cable from the system board (see [Battery on page 34](#)).
4. Remove the WLAN module (see [WLAN module on page 35](#)).
5. Remove the speakers (see [Speakers on page 37](#)).
6. Remove the system board (see [System board on page 39](#)).

Remove the heat sink:

1. In the order indicated on the heat sink, remove the two Phillips M2.0 × 4.0 screws **(1)** that secure the heat sink to the system board.
2. Remove the heat sink **(2)**.

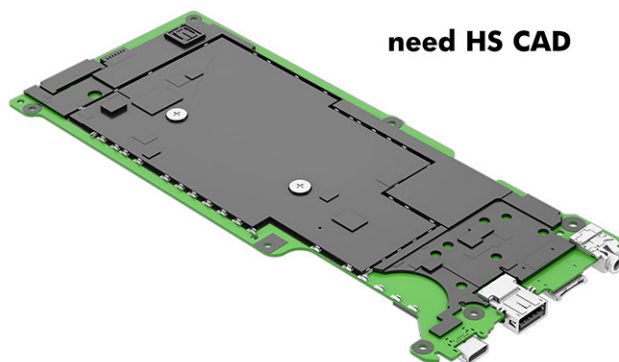

3. Thoroughly clean the thermal material from the surfaces of the heat sink and the system board components each time the heat sink is removed. Replacement thermal material is included with the heat sink and system board spare part kits. The following illustration shows the replacement thermal material locations.

Thermal paste is used on the system board components **(1), (3)** and on the heat sink areas **(2), (4)** that service them. Replacement thermal material is also available in the Thermal Material Kit, spare part number M47379-001.

**need HS CAD**

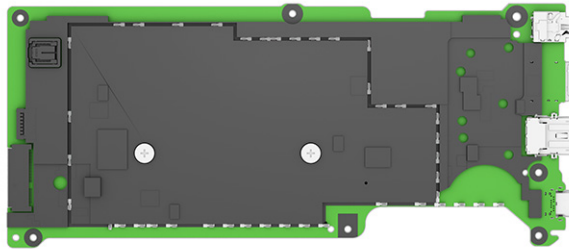

Reverse this procedure to install the heat sink.

### 29.6 cm (11.6 in) display assembly

To remove and disassemble the display assembly, use these procedures and illustrations.

Full hinge-up displays are not available as spare parts. Spare parts for displays are available only at the subcomponent level.

Before removing the display panel, follow these steps:

1. Prepare the computer for disassembly (see [Preparation for disassembly on page 29](#)).
2. Remove the top cover/keyboard (see [Top cover/keyboard on page 29](#)).
3. Disconnect the battery cable from the system board (see [Battery on page 34](#)).

Remove the display assembly:

1. Release the inside edges of the top **(1)**, left **(2)** and right sides, and bottom **(3)** of the display bezel from the display assembly.

2. Remove the display bezel (4).

The display bezel is available using spare part number M47387-001.

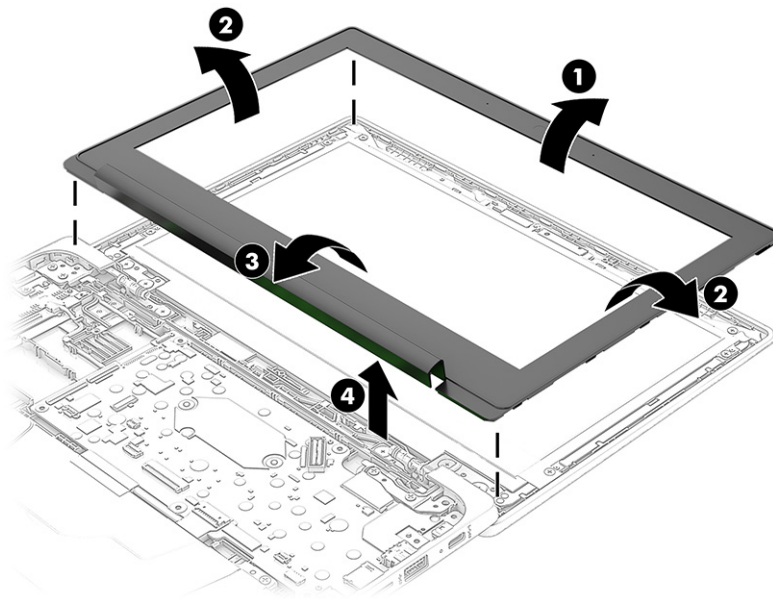

3. Remove the hinge cover from the display bezel.

The display hinge cover is available using spare part number M44252-001.

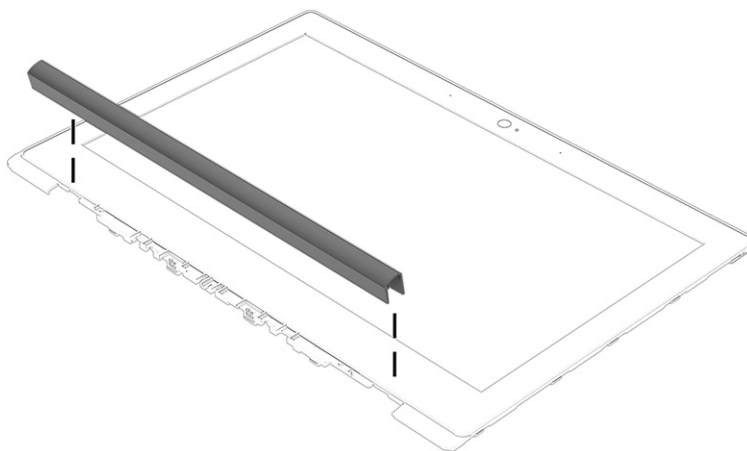

4. Remove the Phillips M2.0 × 2.3 broad head screw (1) that secures the WLAN module bracket.
5. Remove the WLAN module bracket (2).  
The WLAN module bracket is available using spare part number M00452-001.
6. Carefully disconnect the wireless antenna cables (3) from the WLAN module.

 **NOTE:** Computer models have either one or two WLAN antennas. On models with two antennas, the #1 white WLAN antenna cable connects to the WLAN module #1 Main terminal. The #2 black WLAN antenna cable connects to the WLAN module #1 Aux terminal.

7. Disconnect the webcam/microphone module cable (4) from the system board.
8. Release the webcam/microphone module cable and the WLAN AUX antenna cable from the retention clips (5) built into the computer.
9. Disconnect the display panel cable (6) from the system board.
10. Release the display panel cable and the WLAN MAIN antenna cable from the retention clips (7) built into the computer.

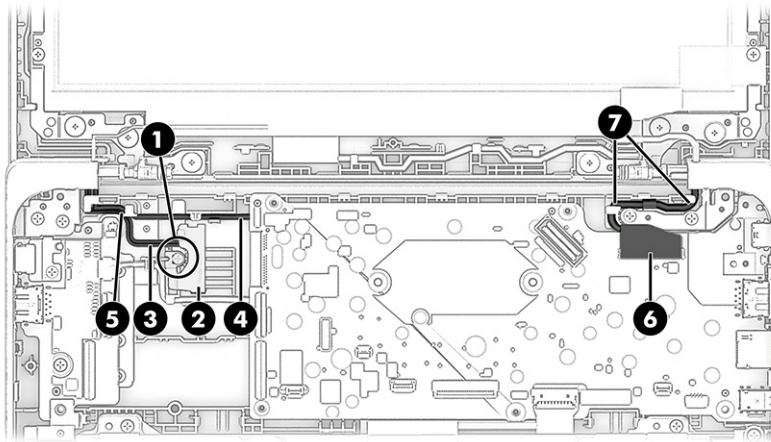

11. Remove the following screws:
  - (1) Six Phillips M2.5 × 3.0 broad head screws that secure the display hinges to the display back cover
  - (2) Six Phillips M2.5 × 2.8 screws that secure the display hinge brackets to the display back cover

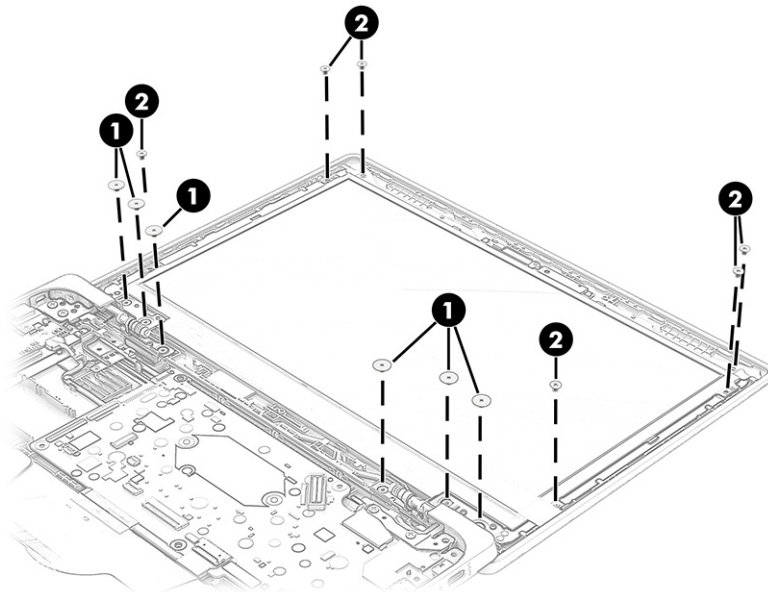

12. Release the webcam/microphone module cable, wireless antenna cables, and the display panel cable from the hinge areas (1).
13. Lift the computer (2) to disengage the hinges and hinge brackets from the display assembly.
14. Slide the computer forward (3) and remove it from the display assembly.

---

 **NOTE:** When removing the computer from the display assembly, make sure that the display hinge brackets (4) are totally disengaged from the display assembly.

---

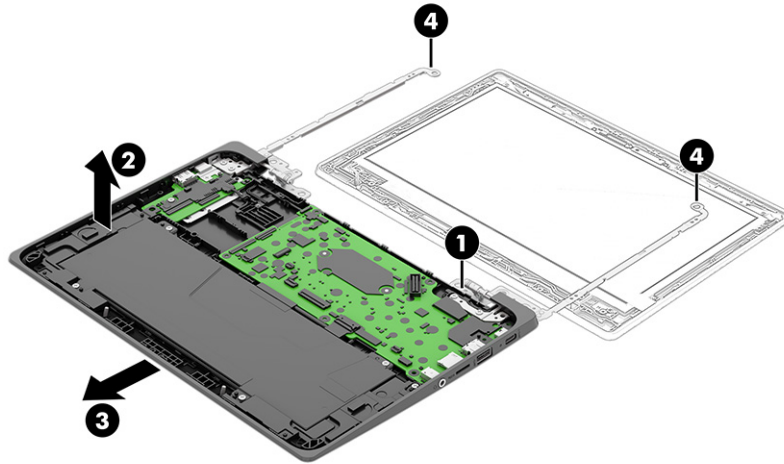

15. Release the display panel cable from the retention clips (1) and routing channel built into the display back cover.

16. Remove the display panel assembly **(2)**.

The display panel assembly is available using the following spare part numbers:

M47377-001: 29.6 cm (11.6 in), HD, antiglare, UWVA, touchscreen, 250 nits

M47376-001: 29.6 cm (11.6 in), HD, antiglare, UWVA, non-touchscreen, 250 nits

M47375-001: 29.6 cm (11.6 in), HD, antiglare, SVA, non-touchscreen, 250 nits

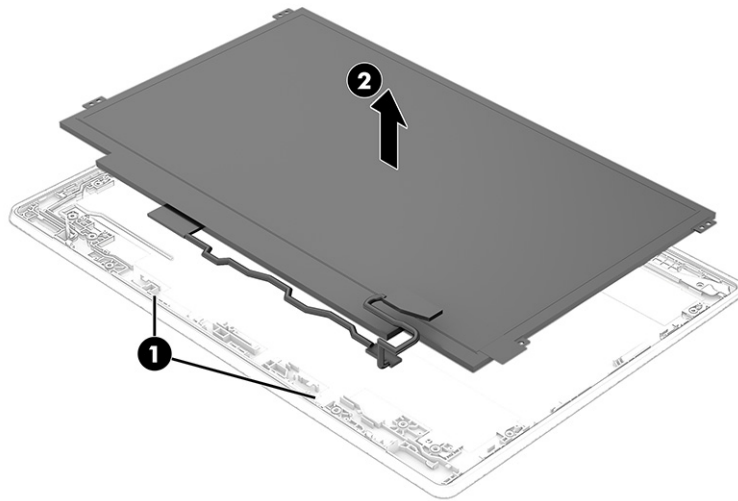

17. Turn the display panel assembly face down with the bottom edge toward you.
18. Detach the grounding tape **(1)** that secures the display panel cable to the display panel assembly.
19. Detach the adhesive support strip **(2)** that secures the display panel cable to the display panel assembly.

20. Disconnect the display panel cable (3) from the display panel assembly.

The display panel cable is available using spare part numbers M48566-001 (for use only on computer models equipped with a touchscreen display assembly) and M48567-001 (for use only on computer models equipped with a non-touchscreen display assembly).

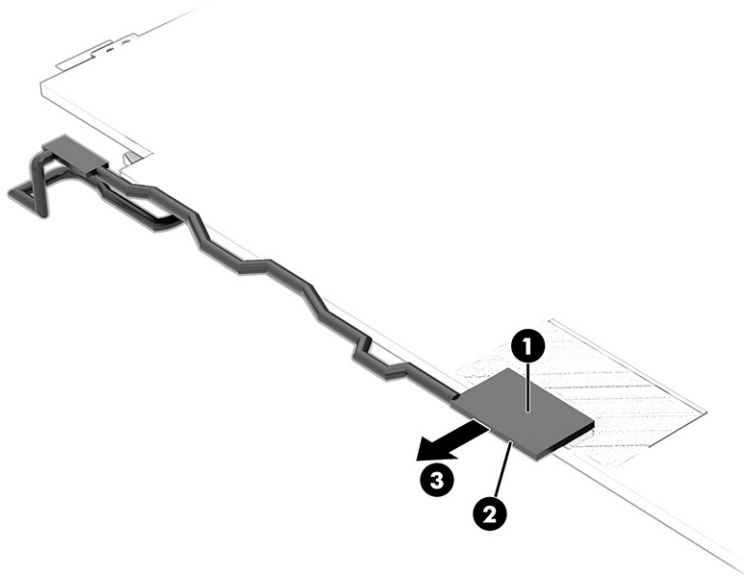

21. Detach the tabs built into the top edge of the display back cover from the slots (1) in the display bracket.
22. Remove the display bracket (2).

The display bracket is available using spare part number L89774-001.

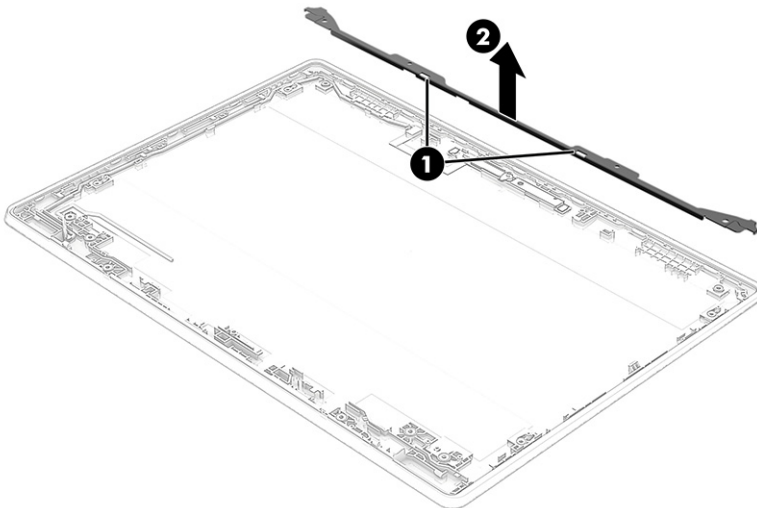

23. Release the webcam/microphone module cable from the retention clips (1) and routing channels built into the left and top edges of the display back cover.



24. Detach the webcam/microphone module (2) from the display back cover. (The webcam/microphone module is attached to the display back cover with double-sided adhesive.)

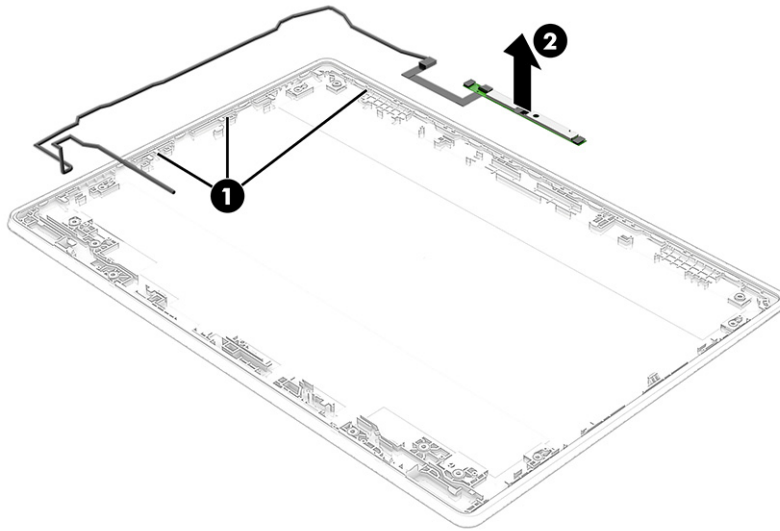

25. Release the ZIF connector (1) to which the webcam/microphone module cable is connected, and then disconnect the webcam/microphone module cable (2) from the webcam/microphone module.

The webcam/microphone module is available using spare part number M44253-001. The webcam/microphone module cable is included in the Cable Kit, spare part number M47368-001.

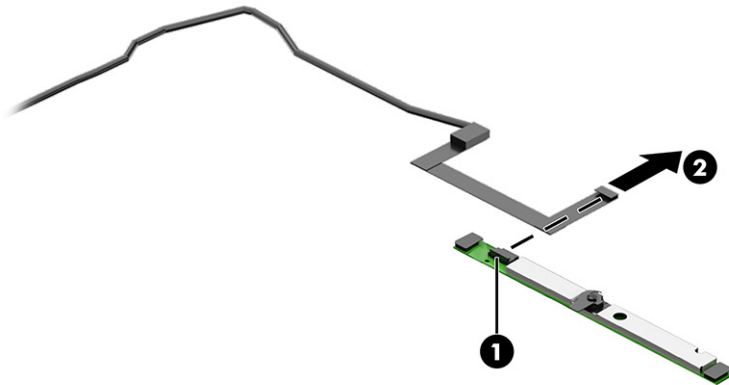

26. Remove the four Phillips M2.5 × 4.7 screws (1) that secure the hinges to the computer.

27. Rotate the hinges (2) back to release them from the base enclosure, and then slide them (3) toward the inside of the computer to remove them.

The hinges are available using spare part number M44251-001.

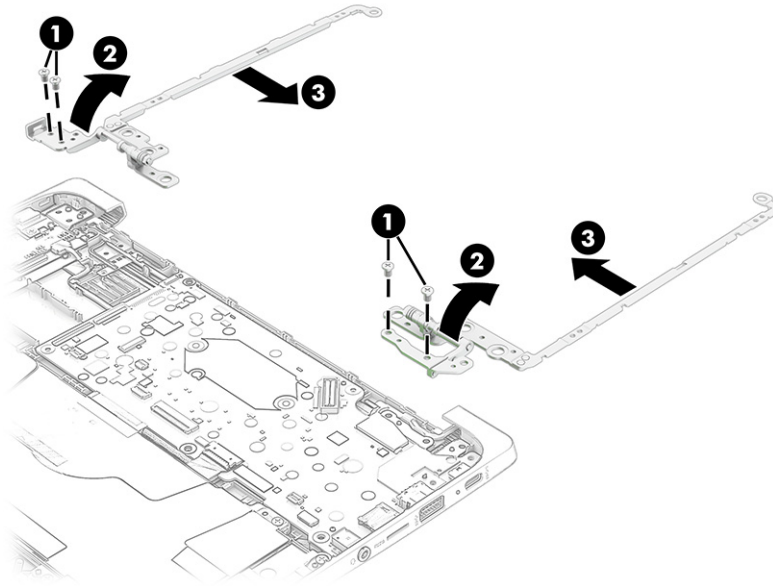

Reverse this procedure to reassemble and replace the display assembly.

---

## 6 Backing up, resetting, and recovering

This chapter provides information about processes that are standard procedure for most products.

### Backing up

You can back up your data to an optional USB flash drive or SD memory card or through Google Drive.

For detailed information about creating a backup, go to <http://www.support.google.com>.

### Resetting

A factory reset erases all the information on your computer hard drive, including all the files in the Downloads folder. Before you reset, make sure to back up your files to an optional USB flash drive, SD memory card, or through Google Drive. The factory reset will not delete any of your files on Google Drive or an external storage device.

## Recovering

When your Chrome OS™ operating system is not working properly, you can perform a recovery. A recovery reinstalls the operating system and software programs and restores the original factory settings. Locally saved files and saved networks are deleted for all accounts. Your Google Accounts and any data synced to your Google Drive™ storage are not affected by a system recovery.

---

 **NOTE:** For more information about performing a system recovery on your computer, go to <http://www.support.google.com>

---

Before beginning the recovery process, you need the following:

- A USB flash drive or SD memory card with a capacity of 4 GB or greater. All data is erased from this storage device when the recovery media is created, so back up any files from the device before you begin.
- A computer with internet access. You must also have administrative rights to the computer.
- Computer AC adapter. The computer must be plugged into AC power during recovery.
- The “Chrome OS is missing or damaged” screen displaying on your computer. If this message is not already displayed:
  - Turn on the computer, press and hold the **esc + f3** keys, and then press the power button. The computer restarts, and the screen shows the “Chrome OS is missing or damaged” screen.

### Installing the Chromebook Recovery Utility

The Chromebook™ Recovery Utility is an app used to recover the original operating system and software programs that were installed at the factory. This utility can be installed from the Chrome Web Store on any computer.

### Creating recovery media

Recovery media is used to recover the original operating system and software programs that were installed at the factory.

### Recovering the Chrome operating system

To recover the Chrome operating system on your computer using the recovery media you created:

## Setting up your computer after a reset or recovery

After a reset or recovery is complete, perform the initial setup process.

For details on setting up the computer, go to <http://www.support.google.com>.

### Erase and reformat the recovery media

During the process of creating recovery media, the USB flash drive or SD memory card is formatted for use as a recovery tool. After you recover your computer, you will need to erase the recovery media if you want to reuse your USB flash drive or SD memory card to store other files. Use the steps in this section to erase the recovery media using the Chromebook Recovery Utility.



# Specifications

This chapter provides specifications for your computer.

## Computer specifications

This section provides specifications for your computer. When you travel with your computer, the computer dimensions and weights, as well as input power ratings and operating specifications, provide helpful information.

**Table 6-1 Computer specifications**

|   | Metric                     | U.S.                |
|---|----------------------------|---------------------|
| <b>Dimensions</b>   |                            |                     |
| Width   | 326.5 mm                   | 12.9 in             |
| Depth   | 226.9 mm                   | 8.9 in              |
| Height (front to back)  | 18.4 mm                    | 0.7 in              |
| <b>Weight</b>   |                            |                     |
|   | 1.5 kg                     | 3.4 lb              |
| <b>Input power</b>  |                            |                     |
| Operating voltage and current   | 19.5 V dc @ 2.31 A – 45 W  |                     |
|   | 19.5 V dc @ 3.33 A – 65 W  |                     |
|   | 19.5 V dc @ 4.62 A – 90 W  |                     |
|   | 19.5 V dc @ 7.70 A – 150 W |                     |
|   | 19.5 V dc @ 10.3 A – 200 W |                     |
| <b>Temperature</b>  |                            |                     |
| Operating   | 5°C to 35°C                | 41°F to 95°F        |
| Nonoperating  | –20°C to 60°C              | –4°F to 140°F       |
| <b>Relative humidity</b> (noncondensing)  |                            |                     |
| Operating   | 10% to 90%                 |                     |
| Nonoperating  | 5% to 95%                  |                     |
| <b>Maximum altitude</b> (unpressurized)   |                            |                     |
| Operating   | –15 m to 3,048 m           | –50 ft to 10,000 ft |
| Nonoperating  | –15 m to 12,192 m          | –50 ft to 40,000 ft |
| <b>NOTE:</b> Applicable product safety standards specify thermal limits for plastic surfaces. The device operates well within this range of temperatures. |                            |                     |

## 29.5 cm (11.6 in) display specifications

This section provides specifications for your display.

**Table 6-2** Display specifications

|                         | <b>Metric</b>                                    | <b>U.S.</b> |
|-------------------------|--|-------------|
| Active diagonal size    | <b>35.6 cm</b>                                   | 14.0 in     |
| Resolution              | 1920 × 1080 (FHD panel)<br>1366 × 768 (HD panel) |             |
| Surface treatment       | Antiglare (FHD and HD panel)                     |             |
| Brightness              | 250 nits (FHD and HD panel, 45% NTSC panels)     |             |
| Viewing angle           | UWVA and SVA                                     |             |
| Backlight               | WLED and LED                                     |             |
| Display panel interface | eDP 1.2 without PSR and eDP                      |             |





# 7 Specifications

This chapter provides specifications for your computer.

## Computer specifications

This section provides specifications for your computer. When you travel with your computer, the computer dimensions and weights, as well as input power ratings and operating specifications, provide helpful information.

**Table 7-1 Computer specifications**

|  | Metric                     | U.S.                |
|--|----------------------------|---------------------|
| <b>Dimensions</b>                        |                            |                     |
| Width                                    | 295.0 mm                   | 11.6 in             |
| Depth                                    | 205.3 mm                   | 8.1 in              |
| Height (front to back)                   | 18.9 mm                    | 0.7 in              |
| <b>Weight</b>                            |                            |                     |
|  | 1.3 kg                     | 3.0 lb              |
| <b>Input power</b>                       |                            |                     |
| Operating voltage and current            | 19.5 V dc @ 2.31 A – 45 W  |                     |
|  | 19.5 V dc @ 3.33 A – 65 W  |                     |
|  | 19.5 V dc @ 4.62 A – 90 W  |                     |
|  | 19.5 V dc @ 7.70 A – 150 W |                     |
|  | 19.5 V dc @ 10.3 A – 200 W |                     |
| <b>Temperature</b>                       |                            |                     |
| Operating                                | 5°C to 35°C                | 41°F to 95°F        |
| Nonoperating                             | –20°C to 60°C              | –4°F to 140°F       |
| <b>Relative humidity (noncondensing)</b> |                            |                     |
| Operating                                | 10% to 90%                 |                     |
| Nonoperating                             | 5% to 95%                  |                     |
| <b>Maximum altitude (unpressurized)</b>  |                            |                     |
| Operating                                | –15 m to 3,048 m           | –50 ft to 10,000 ft |

**Table 7-1** Computer specifications (continued)

|              | Metric            | U.S.                |
|--------------|-------------------|---------------------|
| Nonoperating | -15 m to 12,192 m | -50 ft to 40,000 ft |

**NOTE:** Applicable product safety standards specify thermal limits for plastic surfaces. The device operates well within this range of temperatures.

## 29.6 cm (11.6 in) display specifications

This section provides specifications for your display.

**Table 7-2** Display specifications

|                         | Metric  | U.S.    |
|-------------------------|---|---------|
| Active diagonal size    | <b>29.6 cm</b>                                | 11.6 in |
| Resolution              | 1366 × 768 (HD panel)                         |         |
| Surface treatment       | Antiglare (HD panel)                          |         |
| Brightness              | 220 nits (HD panel, 50 % and 45% NTSC panels) |         |
| Viewing angle           | UWVA and SVA                                  |         |
| Backlight               | WLED  |         |
| Display panel interface | eDP 1.2 without PSR and eDP                   |         |

## 8 Statement of memory volatility

For general information regarding nonvolatile memory in HP business computers, and to restore nonvolatile memory that can contain personal data after the system has been turned off and the hard drive has been removed, use these instructions.

HP business computer products that use Intel®-based or AMD®-based system boards contain volatile DDR memory. The amount of nonvolatile memory present in the system depends upon the system configuration. Intel-based and AMD-based system boards contain nonvolatile memory subcomponents as originally shipped from HP, with the following assumptions:

- No subsequent modifications were made to the system.
- No applications, features, or functionality were added to or installed on the system.

Following system shutdown and removal of all power sources from an HP business computer system, personal data can remain on volatile system memory (DIMMs) for a finite period of time and also remains in nonvolatile memory. Use the following steps to remove personal data from the computer, including the nonvolatile memory found in Intel-based and AMD-based system boards.

---

 **NOTE:** If your tablet has a keyboard base, connect to the keyboard base before beginning steps in this chapter.

---

### Current BIOS steps

Use these instructions to restore nonvolatile memory.

1. Follow these steps to restore the nonvolatile memory that can contain personal data. Restoring or reprogramming nonvolatile memory that does not store personal data is neither necessary nor recommended.

- a. Turn on or restart the computer, and then quickly press **esc**.

---

 **NOTE:** If the system has a BIOS administrator password, enter the password at the prompt.

---

- b. Select **Main**, select **Apply Factory Defaults and Exit**, and then select **Yes** to load defaults. The computer restarts.
- c. During the restart, press **esc** while the "Press the ESC key for Startup Menu" message is displayed at the bottom of the screen.

---

 **NOTE:** If the system has a BIOS administrator password, enter the password at the prompt.

---

- d. Select the **Security** menu, select **Restore Security Settings to Factory Defaults**, and then select **Yes** to restore security level defaults. The computer reboots.

- e. During the reboot, press **esc** while the "Press the ESC key for Startup Menu" message is displayed at the bottom of the screen.



---

**NOTE:** If the system has a BIOS administrator password, enter the password at the prompt.

---

- f. If an asset or ownership tag is set, select the **Security** menu and scroll down to the **Utilities** menu. Select **System IDs**, and then select **Asset Tracking Number**. Clear the tag, and then make the selection to return to the prior menu.
- g. If a DriveLock password is set, select the **Security** menu, and scroll down to **Hard Drive Utilities** under the **Utilities** menu. Select **Hard Drive Utilities**, select **DriveLock**, and then clear the check box for **DriveLock password on restart**. Select **OK** to proceed.
- h. Select the **Main** menu, and then select **Reset BIOS Security to factory default**. Select **Yes** at the warning message. The computer reboots.
- i. During the reboot, press **esc** while the "Press the ESC key for Startup Menu" message is displayed at the bottom of the screen.



---

**NOTE:** If the system has a BIOS administrator password, enter the password at the prompt.

---

- j. Select the **Main** menu, select **Apply Factory Defaults and Exit**, select **Yes** to save changes and exit, and then select **Shutdown**.
  - k. Reboot the system. If the system has a Trusted Platform Module (TPM), fingerprint reader, or both, one or two prompts will appear—one to clear the TPM and the other to Reset Fingerprint Sensor. Press or tap **f1** to accept or **f2** to reject.
  - l. Remove all power and system batteries for at least 24 hours.
2. Complete one of the following:
- Remove and retain the storage drive.  
– or –
  - Clear the drive contents by using a third-party utility designed to erase data from an SSD.  
– or –
  - Clear the contents of the drive by using the following BIOS Setup Secure Erase command option steps:

If you clear data using Secure Erase, you cannot recover it.

- a. Turn on or restart the computer, and then quickly press **esc**.
- b. Select the **Security** menu and scroll down to the **esc** menu.
- c. Select **Hard Drive Utilities**.
- d. Under **Utilities**, select **Secure Erase**, select the hard drive storing the data you want to clear, and then follow the on-screen instructions to continue.

– or –

Clear the contents of the drive using the following Disk Sanitizer commands steps:

- i. Turn on or restart the computer, and then quickly press **esc**.
- ii. Select the **Security** menu and scroll down to the **Utilities** menu.
- iii. Select **Hard Drive Utilities**.
- iv. Under **Utilities**, select **Disk Sanitizer**, select the hard drive with the data that you want to clear, and then follow the on-screen instructions to continue.

 **NOTE:** The amount of time it takes for Disk Sanitizer to run can take several hours. Plug the computer into an AC outlet before starting.

## Nonvolatile memory usage

Use this table to troubleshooting nonvolatile memory usage.

**Table 8-1** Troubleshooting steps for nonvolatile memory usage

| Nonvolatile memory type   | Amount (Size)                   | Does this memory store customer data? | Does this memory retain data when power is removed? | What is the purpose of this memory?   | How is data entered into this memory?   | How is this memory write-protected?   |
|---|---------------------------------|---------------------------------------|---|---|---|---|
| HP Sure Start flash (select models only)                          | 8 MB                            | No                                    | Yes   | Provides protected backup of critical System BIOS code, EC firmware, and critical computer configuration data for select platforms that support HP Sure Start.<br><br>For more information, see <a href="#">Using HP Sure Start (select products only) on page 65</a> . | Data cannot be written to this device via the host processor. The content is managed solely by the HP Sure Start Embedded Controller. | This memory is protected by the HP Sure Start Embedded Controller.  |
| Real Time Clock (RTC) battery backed-up CMOS configuration memory | 256 bytes                       | No                                    | Yes   | Stores system date and time and noncritical data.   | RTC battery backed-up CMOS is programmed using Computer Setup (BIOS), or by changing the Windows date & time.                         | This memory is not write-protected.   |
| Controller (NIC) EEPROM   | 64 KB (not customer accessible) | No                                    | Yes   | Stores NIC configuration and NIC firmware.  | NIC EEPROM is programmed using a utility from the NIC vendor that can be run from DOS.  | A utility must be used to write data to this memory and is available from the NIC vendor. Writing data to this ROM in an inappropriate manner will render the NIC non-functional. |

**Table 8-1** Troubleshooting steps for nonvolatile memory usage (continued)

| Nonvolatile memory type   | Amount (Size)   | Does this memory store customer data? | Does this memory retain data when power is removed? | What is the purpose of this memory?   | How is data entered into this memory?   | How is this memory write-protected?  |
|---|---|---------------------------------------|---|---|---|--|
| DIMM Serial Presence Detect (SPD) configuration data  | 256 bytes per memory module, 128 bytes programmable (not customer accessible) | No                                    | Yes   | Stores memory module information.   | DIMM SPD is programmed by the memory vendor.  | Data cannot be written to this memory when the module is installed in a computer. The specific write-protection method varies by memory vendor.  |
| System BIOS   | 9 MB  | Yes                                   | Yes   | Stores system BIOS code and computer configuration data.                                    | System BIOS code is programmed at the factory. Code is updated when the system BIOS is updated. Configuration data and settings are entered using the Computer Setup (BIOS) or a custom utility.  | <b>NOTE:</b> Writing data to this ROM in an inappropriate manner can render the computer non-functional.<br><br>A utility must be used for writing data to this memory and is available on the HP website; go to <a href="http://www.hp.com/support">http://www.hp.com/support</a> . Select <b>Find your product</b> , and then follow the on-screen instructions. |
| Intel Management Engine Firmware (present only in select Elite or Z models. For more information, go to <a href="http://www.hp.com/support">http://www.hp.com/support</a> . Select <b>Identify your product for manuals and specific product information</b> , and then follow the on-screen instructions.) | 1.5 MB or 7 MB  | Yes                                   | Yes   | Stores Management Engine Code, Settings, Provisioning Data and iAMT third-party data store. | Management Engine Code is programmed at the factory. Code is updated via Intel secure firmware update utility. Unique Provisioning Data can be entered at the factory or by an administrator using the Management Engine (MEBx) setup utility. The third-party data store contents can be populated by a remote management console or local applications that have been registered by an administrator to have access to the space. | The Intel chipset is configured to enforce hardware protection to block all direct read-write access to this area. An Intel utility must be used for updating the firmware. Only firmware updates digitally signed by Intel can be applied using this utility.   |
| Bluetooth flash (select products only)  | 2 megabits  | No                                    | Yes   | Stores Bluetooth configuration and firmware.  | Bluetooth flash is programmed at the factory. Tools for writing data to this memory are not publicly available but can be obtained from the silicon vendor.   | A utility must be used for writing data to this memory and is made available through newer versions of the driver whenever the flash requires an upgrade.  |
| 802.11 WLAN EEPROM  | 4 kilobits to 8 kilobits  | No                                    | Yes   | Stores configuration and calibration data.  | 802.11 WLAN EEPROM is programmed at the factory. Tools for writing data to this memory are not made public.   | A utility must be used for writing data to this memory and is typically not made available to the public unless a firmware upgrade is necessary to address a unique issue.   |

**Table 8-1** Troubleshooting steps for nonvolatile memory usage (continued)

| Nonvolatile memory type                   | Amount (Size) | Does this memory store customer data? | Does this memory retain data when power is removed? | What is the purpose of this memory?       | How is data entered into this memory?  | How is this memory write-protected?  |
|---|---------------|---------------------------------------|---|---|--|--|
| Camera (select products only)             | 64 kilobits   | No                                    | Yes   | Stores camera configuration and firmware. | Camera memory is programmed using a utility from the device manufacturer that can be run from Windows. | A utility must be used for writing data to this memory and is typically not made available to the public unless a firmware upgrade is necessary to address a unique issue. |
| Fingerprint reader (select products only) | 512 KB flash  | Yes                                   | Yes   | Stores fingerprint templates.             | Fingerprint reader memory is programmed by user enrollment in HP ProtectTools Security Manager.        | Only a digitally signed application can make the call to write to the flash.   |

## Questions and answers

Use this section to answer your questions about nonvolatile memory.

### 1. How can the BIOS settings be restored (returned to factory settings)?



**IMPORTANT:** The restore defaults feature does not securely erase any information on your hard drive. See question and answer 6 for steps to securely erase information.

The restore defaults feature does not reset the Custom Secure Boot keys. See question and answer 7 for information about resetting the keys.

- a. Turn on or restart the computer, and then quickly press **esc**.
- b. Select **Main**, and then select **Apply Factory Defaults and Exit**.

- c. Follow the on-screen instructions.
- d. Select **Main**, select **Save Changes and Exit**, and then follow the on-screen instructions.

## 2. What is a UEFI BIOS, and how is it different from a legacy BIOS?

The Unified Extensible Firmware Interface (UEFI) BIOS is an industry-standard software interface between the platform firmware and an operating system (OS). It replaces the older BIOS architecture but supports much of the legacy BIOS functionality.

Like the legacy BIOS, the UEFI BIOS provides an interface to display the system information and configuration settings and to change the configuration of your computer before an OS is loaded. BIOS provides a secure runtime environment that supports a Graphic User Interface (GUI). In this environment, you can use either a pointing device (touch screen, touchpad, pointing stick, or USB mouse) or the keyboard to navigate and make menu and configuration selections. The UEFI BIOS also contains basic system diagnostics.

The UEFI BIOS provides functionality beyond that of the legacy BIOS. In addition, the UEFI BIOS works to initialize the computer's hardware before loading and executing the OS; the runtime environment allows the loading and execution of software programs from storage devices to provide more functionality, such as advanced hardware diagnostics (with the ability to display more detailed system information) and advanced firmware management and recovery software.

HP has provided options in Computer Setup (BIOS) to allow you to run in legacy BIOS, if required by the operating system. Examples of this requirement would be if you upgrade or downgrade the OS.

## 3. Where is the UEFI BIOS located?

The UEFI BIOS is located on a flash memory chip. You must use a utility to write to the chip.

## 4. What kind of configuration data is stored on the DIMM Serial Presence Detect (SPD) memory module? How would this data be written?

The DIMM SPD memory contains information about the memory module, such as size, serial number, data width, speed and timing, voltage, and thermal information. This information is written by the module manufacturer and stored on an EEPROM. You cannot write to this EEPROM when the memory module is installed in a computer. Third-party tools do exist that can write to the EEPROM when the memory module is not installed in a computer. Various third-party tools are available to read SPD memory.

## 5. What is meant by "Restore the nonvolatile memory found in Intel-based system boards"?

This message relates to clearing the Real Time Clock (RTC) CMOS memory that contains computer configuration data.

## 6. How can the BIOS security be reset to factory defaults and erase the data?

---

 **IMPORTANT:** Resetting results in the loss of information.

These steps do not reset Custom Secure Boot Keys. See question and answer 7 for information about resetting the keys.

---

- a. Turn on or restart the computer, and then quickly press **esc**.
- b. Select **Main**, and then select **Reset Security to Factory Defaults**.



- c. Follow the on-screen instructions.
  - d. Select **Main**, select **Save Changes and Exit**, and then follow the on-screen instructions.
7. **How can the Custom Secure Boot Keys be reset?**
- Secure Boot is a feature to ensure that only authenticated code can start on a platform. If you enabled Secure Boot and created Custom Secure Boot Keys, disabling Secure Boot does not clear the keys. You must also select to clear the Custom Secure Boot Keys. Use the same Secure Boot access procedure that you used to create the Custom Secure Boot Keys, but select to clear or delete all Secure Boot Keys.
- a. Turn on or restart the computer, and then quickly press **esc**.
  - b. Select the **Security** menu, select **Secure Boot Configuration**, and then follow the on-screen instructions.
  - c. At the **Secure Boot Configuration** window, select **Secure Boot**, select **Clear Secure Boot Keys**, and then follow the on-screen instructions to continue.

## Using HP Sure Start (select products only)

Select computer models are configured with HP Sure Start, a technology that continuously monitors your computer's BIOS for attacks or corruption.

If the BIOS becomes corrupted or is attacked, HP Sure Start restores the BIOS to its previously safe state, without user intervention. Those select computer models ship with HP Sure Start configured and enabled. HP Sure Start is configured and already enabled so that most users can use the HP Sure Start default configuration. Advanced users can customize the default configuration.

To access the latest documentation on HP Sure Start, go to <http://www.hp.com/support>.



# 9 Power cord set requirements

This chapter provides power cord requirements for countries and regions.

The wide-range input feature of the computer permits it to operate from any line voltage from 100 V ac to 120 V ac, or from 220 V ac to 240 V ac.

The three-conductor power cord set included with the computer meets the requirements for use in the country or region where the equipment is purchased.

Power cord sets for use in other countries or regions must meet the requirements of the country and region where the computer is used.

## Requirements for all countries

These power cord requirements are applicable to all countries and regions.

- The length of the power cord set must be at least **1.0 m** (3.3 ft) and no more than **2.0 m** (6.5 ft).
- All power cord sets must be approved by an acceptable accredited agency responsible for evaluation in the country or region where the power cord set will be used.
- The power cord sets must have a minimum current capacity of 10 A and a nominal voltage rating of 125 V ac or 250 V ac, as required by the power system of each country or region.
- The appliance coupler must meet the mechanical configuration of an EN 60 320/IEC 320 Standard Sheet C13 connector for mating with the appliance inlet on the back of the computer.

## Requirements for specific countries and regions

To determine power cord requirements for specific countries and regions, use this table.

**Table 9-1** Power cord requirements for specific countries and regions

| Country/region | Accredited agency | Applicable note number |
|----------------|-------------------|------------------------|
| Argentina      | IRAM              | 1                      |
| Australia      | SAA               | 1                      |
| Austria        | OVE               | 1                      |
| Belgium        | CEBEC             | 1                      |
| Brazil         | ABNT              | 1                      |
| Canada         | CSA               | 2                      |

**Table 9-1** Power cord requirements for specific countries and regions (continued)

| Country/region             | Accredited agency | Applicable note number |
|----------------------------|-------------------|------------------------|
| Chile                      | IMQ               | 1                      |
| Denmark                    | DEMKO             | 1                      |
| Finland                    | FIMKO             | 1                      |
| France                     | UTE               | 1                      |
| Germany                    | VDE               | 1                      |
| India                      | BIS               | 1                      |
| Israel                     | SII               | 1                      |
| Italy                      | IMQ               | 1                      |
| Japan                      | JIS               | 3                      |
| Netherlands                | KEMA              | 1                      |
| New Zealand                | SANZ              | 1                      |
| Norway                     | NEMKO             | 1                      |
| People's Republic of China | CCC               | 4                      |
| Saudi Arabia               | SASO              | 7                      |
| Singapore                  | PSB               | 1                      |
| South Africa               | SABS              | 1                      |
| South Korea                | KTL               | 5                      |
| Sweden                     | SEMKO             | 1                      |
| Switzerland                | SEV               | 1                      |
| Taiwan                     | BSMI              | 6                      |
| Thailand                   | TISI              | 1                      |
| United Kingdom             | ASTA              | 1                      |

**Table 9-1 Power cord requirements for specific countries and regions (continued)**

| Country/region  | Accredited agency | Applicable note number |
|---|-------------------|------------------------|
| United States   | UL                | 2                      |
| <ol style="list-style-type: none"> <li data-bbox="276 331 1465 386">1. The flexible cord must be Type H05VV-F, three-conductor, 0.75 mm<sup>2</sup> conductor size. Power cord set fittings (appliance coupler and wall plug) must bear the certification mark of the agency responsible for evaluation in the country or region where it will be used.</li> <li data-bbox="276 411 1465 485">2. The flexible cord must be Type SVT/SJT or equivalent, No. 18 AWG, three-conductor. The wall plug must be a two-pole grounding type with a NEMA 5-15P (15 A, 125 V ac) or NEMA 6-15P (15 A, 250 V ac) configuration. CSA or C-UL mark. UL file number must be on each element.</li> <li data-bbox="276 510 1465 590">3. The appliance coupler, flexible cord, and wall plug must bear a T mark and registration number in accordance with the Japanese Dentori Law. The flexible cord must be Type VCTF, three-conductor, 0.75 mm<sup>2</sup> or 1.25 mm<sup>2</sup> conductor size. The wall plug must be a two-pole grounding type with a Japanese Industrial Standard C8303 (7 A, 125 V ac) configuration.</li> <li data-bbox="276 615 1465 669">4. The flexible cord must be Type RVV, three-conductor, 0.75 mm<sup>2</sup> conductor size. Power cord set fittings (appliance coupler and wall plug) must bear the CCC certification mark.</li> <li data-bbox="276 695 1465 749">5. The flexible cord must be Type H05VV-F three-conductor, 0.75 mm<sup>2</sup> conductor size. KTL logo and individual approval number must be on each element. Approval number and logo must be printed on a flag label.</li> <li data-bbox="276 774 1465 829">6. The flexible cord must be Type HVCTF three-conductor, 1.25 mm<sup>2</sup> conductor size. Power cord set fittings (appliance coupler, cable, and wall plug) must bear the BSMI certification mark.</li> <li data-bbox="276 854 1465 926">7. For 127 V ac, the flexible cord must be Type SVT or SJT 3-conductor, 18 AWG, with plug NEMA 5-15P (15 A, 125 V ac), with UL and CSA or C-UL marks. For 240 V ac, the flexible cord must be Type H05VV-F three-conductor, 0.75 mm<sup>2</sup> or 1.00 mm<sup>2</sup> conductor size, with plug BS 1363/A with BSI or ASTA marks.</li> </ol> |                   |                        |



---

# 10 Recycling

When a nonrechargeable or rechargeable battery has reached the end of its useful life, do not dispose of the battery in general household waste. Follow the local laws and regulations in your area for battery disposal.

HP encourages customers to recycle used electronic hardware, HP original print cartridges, and rechargeable batteries. For more information about recycling programs, see the HP website at <http://www.hp.com/recycle>.





# Index

## A

- AC adapter, spare part number 16
- action keys
  - identifying 7
- antenna
  - spare part number 15
- audio-in (microphone) jack, identifying 3
- audio-out (headphone) jack, identifying 3

## B

- battery
  - removal 34
  - spare part number 34
- battery shield
  - removal 34
  - spare part number 34
- bezel
  - removal 43
  - spare part number 44

## C

- Cable Kit, spare part number 16
- cables
  - illustrated 15
  - spare part numbers 15
- camera 6
  - identifying 6
- camera light, identifying 6
- caring for your computer 22
- cautions
  - electrostatic discharge 17, 19
- cleaning your computer 22
  - caring for wood veneer 24
  - disinfecting 23
  - HP Easy Clean 22
  - removing dirt and debris 22

## components

- bottom 8
- display 5
- left side 4
- right side 3
- computer major components 9
- computer specifications 54, 57
- connector board
  - removal 38
  - spare part number 38
- connector board cables
  - removal 37
  - spare part number 37
- connector board high-power cable
  - illustrated 15
  - spare part number 15
- connector board low-power cable
  - illustrated 15
  - spare part number 15
- creating recovery media 52

## D

- display
  - specifications 54, 57, 58
- display assembly
  - removal 43
- display bracket
  - removal 48
  - spare part number 48
- display panel
  - removal 44
- display panel assembly
  - spare part numbers 47
- display panel cable
  - removal 47
  - spare part numbers 48

## E

- electrostatic discharge (ESD) 17, 19
  - preventing damage 17, 19, 20
- erase and reformat recovery media
  - removal 52
- esc key, identifying 7

## F

- factory reset 51

## G

- grounding methods 17, 19, 20
- guidelines
  - packaging 17, 24
  - transporting 17, 24
  - workstation 17, 18

## H

- hard drive
  - specifications 54, 57
- headphone (audio-out) jack 3
- heat sink
  - removal 41
  - spare part numbers 41
- hinge
  - removal 49
  - spare part number 50
- hinge cover
  - removal 44
  - spare part number 44
- HP Sure Start 59, 65

## I

- I/O bracket
  - removal 39, 41
  - spare part number 39
- illustrated parts catalog 9

install  
    Chromebook Recovery Utility 52  
    Recovery Utility 52  
internal microphones, identifying 6

## J

jacks  
    audio-in (microphone) 3  
    audio-out (headphone) 3

## K

key  
    power 8  
keyboard  
    product description 2  
keys  
    esc 7

## L

lights  
    camera 6

## M

memory  
    nonvolatile 59  
    volatile 59  
microphone (audio-in) jack,  
    identifying 3  
microSD memory card reader,  
    identifying 4

## N

nonvolatile memory 59

## P

packaging guidelines 17, 24  
pointing device, product description  
    2  
ports  
    product description 1  
power cord  
    requirements for all countries 67  
    requirements for specific countries  
        and regions 67  
    set requirements 67  
power cord, spare part numbers 16  
power key, identifying 8  
product description  
    keyboard 2  
    pointing device 2  
    ports 1

## R

recovering 52  
recovering Chrome operating  
    system 52  
Recovery Utility 52  
removal and replacement  
    procedures 28  
removing personal data from volatile  
    system memory 59  
resetting 51

## S

Screw Kit, spare part number 16  
sensor board cable  
    illustrated 15  
    spare part number 15  
setting up computer after reset or  
    recovery 52  
speaker  
    removal 37  
    spare part number 37  
speakers, identifying 8  
specifications  
    computer 54, 57  
    display 54, 57, 58  
    hard drive 54, 57  
static electricity 17, 19  
support information 24  
system board  
    removal 39  
    spare part numbers 39  
system memory, removing personal  
    data from volatile 59

## T

top cover/keyboard  
    removal 29  
    spare part numbers 29  
touchpad  
    removal 33  
    spare part numbers 33  
touchpad bracket  
    removal 34  
    spare part number 34  
touchpad cable  
    illustrated 15  
    removal 32  
    spare part number 15, 32  
touchpad zone, identifying 6  
transporting guidelines 17, 24

## W

webcam/microphone module  
    removal 48  
    spare part number 49  
webcam/microphone module cable  
    illustrated 15  
    spare part number 15, 49  
wireless antenna  
    spare part number 15  
WLAN antenna  
    spare part number 15  
WLAN antennas, identifying 6  
WLAN module  
    removal 35  
    spare part number 35  
WLAN module bracket  
    removal 36, 44  
    spare part number 36, 44  
workstation guidelines 17, 18