

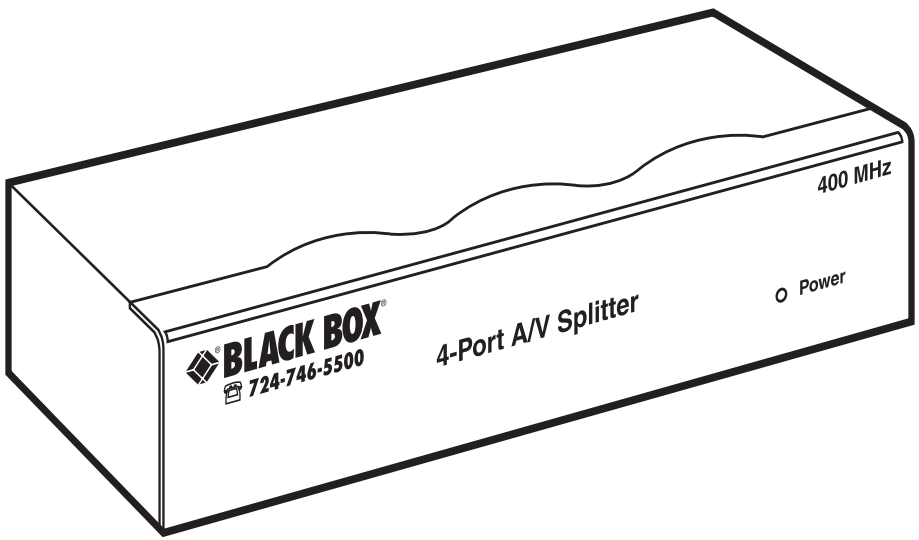

AC650A-2
AC650A-4
AC650A-2-EU
AC650A-4-EU
AC650A-2-UK
AC650A-4-UK

2-Port and 4-Port Audio/Video Splitters



**CUSTOMER
SUPPORT
INFORMATION**

Order toll-free in the U.S.: Call **877-877-BBOX** (outside U.S. call **724-746-5500**)
FREE technical support 24 hours a day, 7 days a week: Call **724-746-5500** or fax **724-746-0746**
Mailing address: **Black Box Corporation**, 1000 Park Drive, Lawrence, PA 15055-1018
Web site: www.blackbox.com • E-mail: info@blackbox.com

**FEDERAL COMMUNICATIONS COMMISSION
AND
INDUSTRY CANADA
RADIO FREQUENCY INTERFERENCE STATEMENTS**

This equipment generates, uses, and can radiate radio-frequency energy, and if not installed and used properly, that is, in strict accordance with the manufacturer's instructions, may cause interference to radio communication. It has been tested and found to comply with the limits for a Class A computing device in accordance with the specifications in Subpart B of Part 15 of FCC rules, which are designed to provide reasonable protection against such interference when the equipment is operated in a commercial environment. Operation of this equipment in a residential area is likely to cause interference, in which case the user at his own expense will be required to take whatever measures may be necessary to correct the interference.

Changes or modifications not expressly approved by the party responsible for compliance could void the user's authority to operate the equipment.

This digital apparatus does not exceed the Class A limits for radio noise emission from digital apparatus set out in the Radio Interference Regulation of Industry Canada.

Le présent appareil numérique n'émet pas de bruits radioélectriques dépassant les limites applicables aux appareils numériques de la classe A prescrites dans le Règlement sur le brouillage radioélectrique publié par Industrie Canada.

NORMAS OFICIALES MEXICANAS (NOM) ELECTRICAL SAFETY STATEMENT

INSTRUCCIONES DE SEGURIDAD

1. Todas las instrucciones de seguridad y operación deberán ser leídas antes de que el aparato eléctrico sea operado.
2. Las instrucciones de seguridad y operación deberán ser guardadas para referencia futura.
3. Todas las advertencias en el aparato eléctrico y en sus instrucciones de operación deben ser respetadas.
4. Todas las instrucciones de operación y uso deben ser seguidas.
5. El aparato eléctrico no deberá ser usado cerca del agua—por ejemplo, cerca de la tina de baño, lavabo, sótano mojado o cerca de una alberca, etc..
6. El aparato eléctrico debe ser usado únicamente con carritos o pedestales que sean recomendados por el fabricante.
7. El aparato eléctrico debe ser montado a la pared o al techo sólo como sea recomendado por el fabricante.
8. Servicio—El usuario no debe intentar dar servicio al equipo eléctrico más allá a lo descrito en las instrucciones de operación. Todo otro servicio deberá ser referido a personal de servicio calificado.
9. El aparato eléctrico debe ser situado de tal manera que su posición no interfiera su uso. La colocación del aparato eléctrico sobre una cama, sofá, alfombra o superficie similar puede bloquea la ventilación, no se debe colocar en libreros o gabinetes que impidan el flujo de aire por los orificios de ventilación.
10. El equipo eléctrico deber ser situado fuera del alcance de fuentes de calor como radiadores, registros de calor, estufas u otros aparatos (incluyendo amplificadores) que producen calor.
11. El aparato eléctrico deberá ser conectado a una fuente de poder sólo del tipo descrito en el instructivo de operación, o como se indique en el aparato.

12. Precaución debe ser tomada de tal manera que la tierra física y la polarización del equipo no sea eliminada.
13. Los cables de la fuente de poder deben ser guiados de tal manera que no sean pisados ni pellizcados por objetos colocados sobre o contra ellos, poniendo particular atención a los contactos y receptáculos donde salen del aparato.
14. El equipo eléctrico debe ser limpiado únicamente de acuerdo a las recomendaciones del fabricante.
15. En caso de existir, una antena externa deberá ser localizada lejos de las líneas de energía.
16. El cable de corriente deberá ser desconectado del cuando el equipo no sea usado por un largo periodo de tiempo.
17. Cuidado debe ser tomado de tal manera que objetos líquidos no sean derramados sobre la cubierta u orificios de ventilación.
18. Servicio por personal calificado deberá ser provisto cuando:
 - A: El cable de poder o el contacto ha sido dañado; u
 - B: Objetos han caído o líquido ha sido derramado dentro del aparato; o
 - C: El aparato ha sido expuesto a la lluvia; o
 - D: El aparato parece no operar normalmente o muestra un cambio en su desempeño; o
 - E: El aparato ha sido tirado o su cubierta ha sido dañada.

2-PORT AND 4-PORT AUDIO/VIDEO SPLITTERS

TRADEMARKS USED IN THIS MANUAL

BLACK BOX and the Double Diamond logo are registered trademarks of BB Technologies, Inc.

Any other trademarks mentioned in this manual are acknowledged to be the property of the trademark owners.

Contents

Chapter	Page
1. Specifications	6
2. Overview	7
2.1 Introduction.....	7
2.2 Front Panel.....	7
2.3 Back Panel.....	8
3. Installation.....	10
3.1 Basic Installation	10
3.2 Cascaded Installation	11
3.3 Supported Resolutions/Distances.....	12
4. Troubleshooting.....	13
4.1 Calling Black Box.....	13
4.2 Shipping and Packaging	13

1. Specifications

Distance (Maximum): 213.2 ft. (65 m)

Input/Output Signals:

Pin Number	Signal
1	Red video
2	Green video
3	Blue video
4	ID2
5, 10	Ground
6, 7, 8	Analog Ground
9	Not connected
11	ID0
12	ID1
13	Horizontal sync
14	Vertical sync
15	ID3

Pixel Frequency: 400 MHz

Resolution (Maximum): 2048 x 1536 at 60 Hz

CE Approval: Yes

Connectors: Video input: Both: (1) HD15 F;
Video output: AC650A-2: (2) HD15 F;
AC650A-4: (4) HD15 F;
Audio input: Both: (1) 3.5-mm stereo F;
Audio output: AC650A-2: (2) 3.5-mm stereo F;
AC650A-4: (4) HD15 F; (4) 3.5-mm stereo F

Power: AC650A-2, AC650A-4: Input: 120-VAC, 60 Hz;
Output: 12 VDC, 600 mA, 7.2 W;
AC650A-2-EU, AC650A-4-EU, AC650A-2-UK, AC650A-4-UK:
Input: 240 VAC, 50 Hz;
Output: 12 VDC, 600 mA, 7.2 W

Size: AC650A-2: 1.7"H x 5.1"W x 3"D (4.3 x 13 x 7.6 cm);
AC650A-4: 1.7"H x 13.5"W x 4.1"D (4.3 x 34.3 x 10.4 cm)

Weight: AC650A-2: 0.9 lb. (0.4 kg); AC650A-4: 1.5 lb. (0.7 kg)

2. Overview

2.1 Introduction

With the 2-Port and 4-Port Audio/Video Splitters, you can transmit audio and video signals from one PC to two or four monitors and headphones located up to 213.2 feet (65 m) away at a maximum resolution of 640 x 480, or up to 32 feet (10 m) away with a maximum resolution of 2048 x 1536. Use the splitters in test bench facilities, data centers, help desks, and video broadcasting applications (presentations, stock quotes, timetables, schools).

You can cascade the splitters up to two levels. Link up to three monitors and headphones to the source PC using the AC650A-2 or connect up to seven monitors and headphones to the source PC using the AC650A-4.

The splitters have easy-to-use front-panel select switches and support the VESA DDC, DDC2, DDC2B standards (for video out Port 1).

Plus, the splitters are compatible with a broad range of video interfaces, including VGA, SVGA, XGA, UXGA, QXGA, and multisync.

2.2 Front Panel

The front panels of the 2- and 4-port splitters are shown in Figures 2-1 and 2-2. Table 2-1 describes the components.

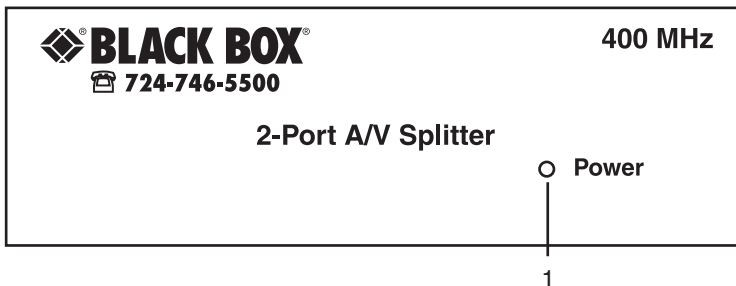

Figure 2-1. Front panel: 2-port splitter.

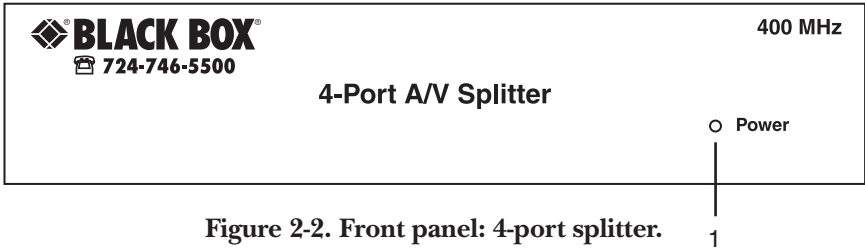

Figure 2-2. Front panel: 4-port splitter.

Table 2-1. Front panel components.

Number	Component	Description
1	Power LED	Lights when power is on

2.3 Back Panel

The back panels of the 2- and 4-port splitters are shown in Figures 2-3 and 2-4. Table 2-2 describes the components.

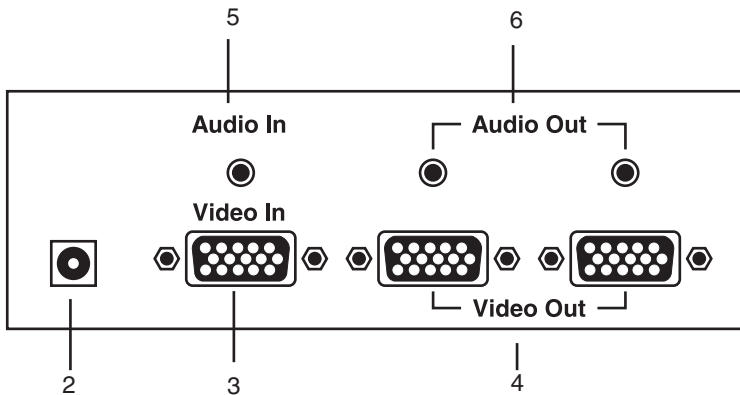

Figure 2-3. Back panel: 2-port splitter.

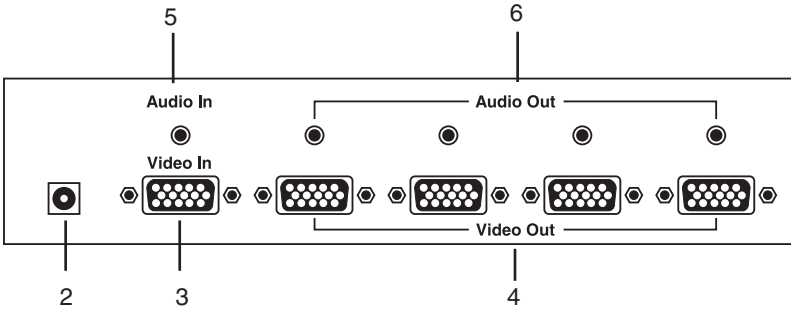

Figure 2-4. Back panel: 4-port splitter.

Table 2-2. Back panel components.

Number	Component	Description
2	Power input receptacle	Plug in the included 12 VDC, 600 mA power adapter
3	HD15 F connector	Video in port
4	HD15F connector	Video out ports
5	3.5-mm stereo F connector	Audio in port
6	3.5-mm stereo F connectors	Audio out ports

NOTE: The AC650A-2 has two audio and video output ports and the AC650A-4 has four audio and video output ports.

3. Installation

3.1 Basic Installation

Follow these steps and refer to Figure 3-1 to install the audio/video splitter.

1. Turn off the PC and monitor.
2. Connect the HD15 cable to the PC's video output port and the splitter's video input port.
3. Connect the 3.5-mm audio cable to the PC's audio output port and the splitter's audio input port.
4. Attach the HD15 video cables to the monitors' video input ports and the splitter's video output ports.
5. Link the 3.5-mm audio cables to the monitors' audio input ports and the splitter's audio output ports.
6. Plug the 3.5-mm headphone cables into the monitors' audio output ports and the splitter's audio input ports.

NOTE: If you connect a DDC monitor to the splitter, all of the monitors must be the same resolution as the DDC monitor.

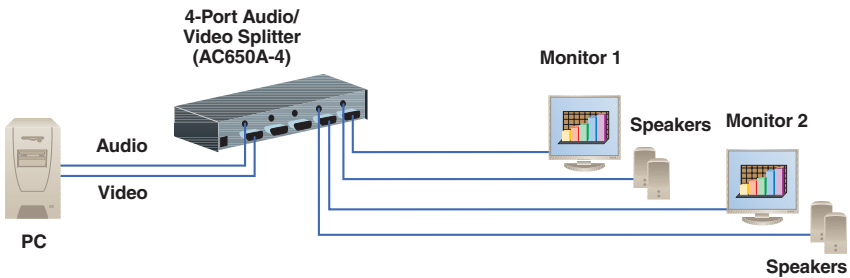

Figure 3-1. Typical installation.

3.2 Cascaded Installation

You can cascade the splitters up to two levels. Mix or match 2-port and 4-port splitters. Instructions follow for cascading a 2-port splitter and a 4-port splitter. See Figure 3-2.

1. Connect a HD15 male/male video cable between the first-level splitter's video output port and the second-level splitter's video input port.
2. Link a 3.5-mm audio cable to the first-level splitter's audio output port and the second-level splitter's audio input port.

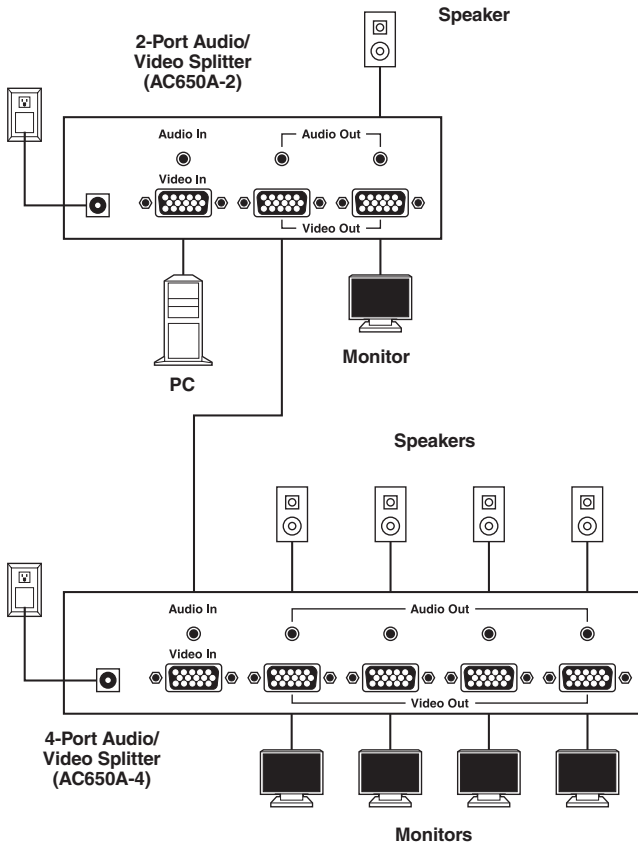

Figure 3-2. Cascaded installation.

3.3 Supported Resolutions/Distances

Table 3-1. Supported resolutions/distances.

Resolution	Frequency	Distance
640 x 480	60 Hz	213 ft. (65 m)
800 x 60	60 Hz	164 ft. (50 m)
1024 x 768	60 Hz	131 ft. (40 m)
1280 x 1024	60 Hz	98 ft. (30 m)
1600 x 1200	60 Hz	49 ft. (15 m)
2048 x 1536	60 Hz	32 ft. (10 m)

NOTE: The maximum resolution is 2048 x 1536 at 32 feet (10 m) and the maximum distance is 213 feet (65 m) at 640 x 480 resolution.

4. Troubleshooting

4.1 Calling Black Box

If you determine that your 2-Port or 4-Port Audio/Video Splitter is malfunctioning, do not attempt to alter or repair the unit. It contains no user-serviceable parts. Contact Black Box Technical Support at 724-746-5500.

Before you do, make a record of the history of the problem. We will be able to provide more efficient and accurate assistance if you have a complete description, including:

- the nature and duration of the problem.
- when the problem occurs.
- the components involved in the problem.
- any particular application that, when used, appears to create the problem or make it worse.

4.2 Shipping and Packaging

If you need to transport or ship your 2-Port or 4-Port Audio/Video Splitter:

- Package it carefully. We recommend that you use the original container.
- If you are returning the unit, make sure you include everything you received with it. Before you ship for return or repair, contact Black Box to get a Return Authorization (RA) number.



© Copyright 2013. Black Box Corporation. All rights reserved.

AC650A-2, version 2

1000 Park Drive • Lawrence, PA 15055-1018 • 724-746-5500 • Fax 724-746-0746