



Cisco IP Phone 6800 Series Multiplatform Phones User Guide

First Published: 2017-11-22

Last Modified: 2023-08-18

Americas Headquarters

Cisco Systems, Inc.
170 West Tasman Drive
San Jose, CA 95134-1706
USA
<http://www.cisco.com>
Tel: 408 526-4000
800 553-NETS (6387)
Fax: 408 527-0883

THE SPECIFICATIONS AND INFORMATION REGARDING THE PRODUCTS IN THIS MANUAL ARE SUBJECT TO CHANGE WITHOUT NOTICE. ALL STATEMENTS, INFORMATION, AND RECOMMENDATIONS IN THIS MANUAL ARE BELIEVED TO BE ACCURATE BUT ARE PRESENTED WITHOUT WARRANTY OF ANY KIND, EXPRESS OR IMPLIED. USERS MUST TAKE FULL RESPONSIBILITY FOR THEIR APPLICATION OF ANY PRODUCTS.

THE SOFTWARE LICENSE AND LIMITED WARRANTY FOR THE ACCOMPANYING PRODUCT ARE SET FORTH IN THE INFORMATION PACKET THAT SHIPPED WITH THE PRODUCT AND ARE INCORPORATED HEREIN BY THIS REFERENCE. IF YOU ARE UNABLE TO LOCATE THE SOFTWARE LICENSE OR LIMITED WARRANTY, CONTACT YOUR CISCO REPRESENTATIVE FOR A COPY.

The following information is for FCC compliance of Class A devices: This equipment has been tested and found to comply with the limits for a Class A digital device, pursuant to part 15 of the FCC rules. These limits are designed to provide reasonable protection against harmful interference when the equipment is operated in a commercial environment. This equipment generates, uses, and can radiate radio-frequency energy and, if not installed and used in accordance with the instruction manual, may cause harmful interference to radio communications. Operation of this equipment in a residential area is likely to cause harmful interference, in which case users will be required to correct the interference at their own expense.

The following information is for FCC compliance of Class B devices: This equipment has been tested and found to comply with the limits for a Class B digital device, pursuant to part 15 of the FCC rules. These limits are designed to provide reasonable protection against harmful interference in a residential installation. This equipment generates, uses and can radiate radio frequency energy and, if not installed and used in accordance with the instructions, may cause harmful interference to radio communications. However, there is no guarantee that interference will not occur in a particular installation. If the equipment causes interference to radio or television reception, which can be determined by turning the equipment off and on, users are encouraged to try to correct the interference by using one or more of the following measures:

- Reorient or relocate the receiving antenna.
- Increase the separation between the equipment and receiver.
- Connect the equipment into an outlet on a circuit different from that to which the receiver is connected.
- Consult the dealer or an experienced radio/TV technician for help.

Modifications to this product not authorized by Cisco could void the FCC approval and negate your authority to operate the product.

The Cisco implementation of TCP header compression is an adaptation of a program developed by the University of California, Berkeley (UCB) as part of UCB's public domain version of the UNIX operating system. All rights reserved. Copyright © 1981, Regents of the University of California.

NOTWITHSTANDING ANY OTHER WARRANTY HEREIN, ALL DOCUMENT FILES AND SOFTWARE OF THESE SUPPLIERS ARE PROVIDED "AS IS" WITH ALL FAULTS. CISCO AND THE ABOVE-NAMED SUPPLIERS DISCLAIM ALL WARRANTIES, EXPRESSED OR IMPLIED, INCLUDING, WITHOUT LIMITATION, THOSE OF MERCHANTABILITY, FITNESS FOR A PARTICULAR PURPOSE AND NONINFRINGEMENT OR ARISING FROM A COURSE OF DEALING, USAGE, OR TRADE PRACTICE.

IN NO EVENT SHALL CISCO OR ITS SUPPLIERS BE LIABLE FOR ANY INDIRECT, SPECIAL, CONSEQUENTIAL, OR INCIDENTAL DAMAGES, INCLUDING, WITHOUT LIMITATION, LOST PROFITS OR LOSS OR DAMAGE TO DATA ARISING OUT OF THE USE OR INABILITY TO USE THIS MANUAL, EVEN IF CISCO OR ITS SUPPLIERS HAVE BEEN ADVISED OF THE POSSIBILITY OF SUCH DAMAGES.

Any Internet Protocol (IP) addresses and phone numbers used in this document are not intended to be actual addresses and phone numbers. Any examples, command display output, network topology diagrams, and other figures included in the document are shown for illustrative purposes only. Any use of actual IP addresses or phone numbers in illustrative content is unintentional and coincidental.

All printed copies and duplicate soft copies of this document are considered uncontrolled. See the current online version for the latest version.

Cisco has more than 200 offices worldwide. Addresses and phone numbers are listed on the Cisco website at www.cisco.com/go/offices.

Cisco and the Cisco logo are trademarks or registered trademarks of Cisco and/or its affiliates in the U.S. and other countries. To view a list of Cisco trademarks, go to this URL: <https://www.cisco.com/c/en/us/about/legal/trademarks.html>. Third-party trademarks mentioned are the property of their respective owners. The use of the word partner does not imply a partnership relationship between Cisco and any other company. (1721R)

© 2023 Cisco Systems, Inc. All rights reserved.



CONTENTS

CHAPTER 1

Your Phone 1

| | |
|---|----|
| The Cisco IP Phone 6800 Series Multiplatform Phones | 1 |
| Feature Support | 3 |
| New and Changed Features | 3 |
| New and Changed for Firmware Release 12.0(3) | 3 |
| New and Changed for Firmware Release 12.0(2) | 3 |
| New and Changed for Firmware Release 12.0(1) | 4 |
| New and Changed for Firmware Release 11.3(7) | 4 |
| New and Changed for Firmware Release 11.3(6) | 5 |
| New and Changed for Firmware Release 11.3(5) | 6 |
| New and Changed for Firmware Release 11.3(4) | 6 |
| New and Changed for Firmware Release 11.3(3) | 7 |
| New and Changed for Firmware Release 11.3(2) | 9 |
| New and Changed for Cisco IP Phone 6871 with Multiplatform Firmware Release 11.3(1) | 12 |
| New and Changed for Firmware Release 11.3(1) | 13 |
| New and Changed for Firmware Release 11.2(4) | 13 |
| New and Changed for Firmware Release 11.2(3)SR1 | 14 |
| New and Changed for Firmware Release 11.2(3) | 14 |
| New and Changed for Firmware Release 11.2(2) | 15 |
| New and Changed for Firmware Release 11.2(1) | 15 |
| New and Changed for Firmware Release 11.1(2) | 16 |
| New and Changed for Firmware Release 11.1(1) | 17 |
| Phone Setup | 17 |
| Connect to the Network | 17 |
| Auto Provision Your Phone with Short Activation Code | 17 |
| Onboard Your Phone with Activation Code | 18 |

- Set a Password on Initial Phone Boot Up 18
- Create User Password on Phone 19
- User Authentication Control 19
- Sign into Your Extension from Another Phone (Extension Mobility) 19
 - Sign out of Your Extension from Another Phone 20
- Sign in to a Phone as a Guest 20
 - Sign Out of a Phone as a Guest 21
- Set the Profile Rule on the Phone 21
- Coworker Line Status 21
 - Activate or Deactivate Monitoring of the BLF List 22
 - Configure Monitoring of an Individual Line 23
 - Remove the Feature Configured on a Line Key 24
- Add a Menu Shortcut to a Line Key 25
- Remove the Menu Shortcut from a Line Key 25
- Service Interruption Message on Home Screen 25
- Phone Web Page 25
 - Speed dial numbers 26
- Phone Hardware and Buttons 27
 - Cisco IP Phone 6821 Multiplatform Phones Buttons and Hardware 27
 - Cisco IP Phone 6841, 6851, and 6861 Multiplatform Phones Buttons and Hardware 29
 - Cisco IP Phone 6871 Multiplatform Phones Buttons and Hardware 30
 - Navigation 32
 - Softkey, Line, and Feature Buttons 32
 - Phone Screen Features 33
 - Clean your phone screen 34
 - Differences Between Phone Calls and Lines 34
- Energy Savings 34
- Additional Help and Information 34
 - Accessibility Features 35
 - Cisco IP Phone 6821 Multiplatform Phones Hearing-Impaired Accessibility Features 35
 - Cisco IP Phone 6841, 6851, and 6861 Hearing-Impaired Accessibility Features 36
 - Cisco IP Phone 6871 Multiplatform Phones Hearing-Impaired Accessibility Features 38
 - Cisco IP Phone 6821 Multiplatform Phones Vision-Impaired and Blind Accessibility Features 40
 - Cisco IP Phone 6841, 6851, and 6861 Vision-Impaired and Blind Accessibility Features 43

| | |
|---|----|
| Cisco IP Phone 6871 Multiplatform Phones Vision-Impaired Accessibility Features | 45 |
| Cisco IP Phone 6821 Multiplatform Phones Mobility-Impaired Accessibility Features | 48 |
| Cisco IP Phone 6841, 6851, and 6861 Mobility-Impaired Accessibility Features | 50 |
| Cisco IP Phone 6871 Multiplatform Phones Mobility-Impaired Accessibility Features | 51 |
| Third-Party Accessibility Applications | 53 |
| Troubleshooting | 53 |
| Find Information About Your Phone | 53 |
| View the Customization State on the Phone | 54 |
| View the Network Status | 55 |
| View the Phone Status | 55 |
| View the Status Messages on the Phone | 56 |
| View the Line Status | 56 |
| View Call Records in Call Statistics | 56 |
| View 802.1X Transaction Status | 57 |
| View the Reboot History | 58 |
| Report all phone issues for your Cisco MPP device | 58 |
| View Wi-Fi Status Messages on the Phone | 58 |
| Factory Reset the Phone from Phone Web Page | 59 |
| Factory Reset from Server | 59 |
| Identify Phone Issues with a URL in the Phone Web Page | 60 |
| Lost Phone Connectivity | 60 |
| Get More Information When Your Phone Displays a Provisioning Failure Message | 60 |
| Find Information about MIC Cert Refresh Status | 61 |
| Cisco One-Year Limited Hardware Warranty Terms | 61 |

CHAPTER 2
Calls 63

| | |
|--|----|
| Make calls | 63 |
| Make a call | 63 |
| Make a call with the speakerphone | 64 |
| Make a call with a headset | 64 |
| Redial a number | 64 |
| Make an Emergency Call | 65 |
| Speed Dial | 65 |
| Assign a speed-dial code from the phone screen | 65 |

| | |
|--|----|
| Make a call with a speed-dial code | 66 |
| Configure a speed-dial on a line key | 66 |
| Remove a speed-dial from a line key | 66 |
| Use the Line in Focus for Speed-Dial Calls | 67 |
| Use the Line in Focus to Check Speed-Dial Calls | 67 |
| Dial an international number | 67 |
| Secure calls | 68 |
| Answer Calls | 68 |
| Answer a Call | 68 |
| Answer Call Waiting | 68 |
| Decline a Call | 68 |
| Silence an Incoming Call | 69 |
| Turn On Do Not Disturb | 69 |
| Turn On or Turn Off DND Using a Star Code | 70 |
| Answer a Coworker's Phone (Call Pickup) | 70 |
| Answer a Call Within Your Group (Pickup) | 70 |
| Mute Your Call | 70 |
| Hold Calls | 71 |
| Put a Call on Hold | 71 |
| Answer a Call Left on Hold for Too Long | 71 |
| Swap between active and held calls | 71 |
| Call park | 72 |
| Place a call on hold with call park | 72 |
| Retrieve a call on hold with call park | 72 |
| Park and Unpark a Call with One Line Key | 73 |
| Call Park Extension and Status | 73 |
| Forward Calls | 74 |
| Forward Calls with the Phone Web Page | 75 |
| Activate Call Forward All with Feature Activation Code Synchronization | 76 |
| Transfer Calls | 77 |
| Transfer a Call to Another Person | 77 |
| Consult Before You Complete a Transfer | 77 |
| Conference Calls and Meetings | 78 |
| Add Another Person to a Call | 78 |

| | |
|--|----|
| Conference with a Star Code | 78 |
| Remove a Participant as a Host in Ad Hoc Conference | 79 |
| View the Participants List as a Host in Ad Hoc Conference | 79 |
| View the Participants List as a Participant | 80 |
| Page a Group of Phones (Multicast Paging) | 80 |
| XML Application and Multicast Paging | 80 |
| View XML Application Details | 81 |
| Multiple Lines | 81 |
| Answer the Oldest Call First | 81 |
| View All Calls on Your Phone | 81 |
| Shared lines on your multiplatform desk phone | 81 |
| Add yourself to a call on a shared line | 82 |
| Record a Call | 83 |
| Call Center Features | 83 |
| Sign In as a Call Center Agent | 84 |
| Sign Out as a Call Center Agent | 84 |
| Change Your Status as a Call Center Agent | 85 |
| Accept a Call Center Call | 85 |
| Hold an Agent Call | 85 |
| Set a Disposition Code While on a Call Center Call | 86 |
| Trace a Call | 86 |
| Escalate a Call to a Supervisor | 86 |
| Executive Calls | 87 |
| Join an Ongoing Call as an Executive | 87 |
| Transfer an Ongoing Call to Yourself as an Executive | 87 |
| Troubleshooting Executive Calls | 88 |
| Executive Assistant Calls | 88 |
| Initiate a Call On Behalf of an Executive as an Assistant | 88 |
| Transfer an Ongoing Call to an Executive as an Assistant | 89 |
| Join or Transfer an Ongoing Call to Yourself as an Executive Assistant | 90 |
| Troubleshooting Executive-Assistant Calls | 90 |

CHAPTER 3
Contacts 91

| | |
|--|----|
| Search for a Contact in the All Directories Screen | 91 |
|--|----|

| | |
|---|-----|
| Corporate Directory | 93 |
| Webex Directory | 93 |
| Search for a Contact in Your Webex Directory | 93 |
| Search for a Webex Contact in All Directory | 95 |
| Edit the Webex Directory Name | 96 |
| Broadsoft Directory | 97 |
| Search for a Contact in Your BroadSoft Directory | 97 |
| Edit Your Contact Type in Your BroadSoft Directory | 98 |
| Manage Your Contacts in the BroadSoft Personal Directory | 98 |
| Edit Your BroadSoft Directory Name | 100 |
| Edit the Server Name of Your BroadSoft Directory | 101 |
| Edit Credentials of Your BroadSoft Directory | 101 |
| LDAP Directory | 102 |
| Edit Credentials of Your LDAP Directory | 103 |
| Search for a Contact in Your LDAP Directory | 103 |
| Call a Contact in Your LDAP Directory | 104 |
| Edit a Contact Number in Your LDAP Directory | 105 |
| XML Directory | 106 |
| Call a Contact in Your XML Directory | 106 |
| Edit a Contact Number in Your XML Directory | 106 |
| Instant Message and Presence Contacts | 107 |
| Presence | 108 |
| Make a Call to an IM and Presence Contact | 108 |
| Change Your Presence State | 109 |
| Personal Address Book | 109 |
| Add a New Contact to Your Personal Address Book | 109 |
| Add a New Contact to Your Personal Address Book with Phone Web Page | 110 |
| Search for a Contact in Your Personal Address Book | 110 |
| Call a Contact in Your Personal Address Book | 111 |
| Edit a Contact in Your Personal Address Book | 111 |
| Remove a Contact from Your Personal Address Book | 112 |
| Reverse Name Lookup for Incoming and Outgoing Calls | 112 |

| | |
|--|-----|
| Recent calls list | 115 |
| View your Recent Calls | 115 |
| View Webex Call Logs Duration | 117 |
| Spam Indication for Webex Calls | 118 |
| View Calls Logs from Server | 118 |
| Return a recent call | 119 |
| Clear the recent calls list | 119 |
| Create a Contact from a Recents Record | 120 |
| Delete a call record | 121 |
| Delete All Call Records | 121 |

CHAPTER 5**Voicemail 123**

| | |
|---|-----|
| Your Personal Voicemail Account | 123 |
| Set up Voicemail on Your Phone | 123 |
| Find out if you have new voicemail messages Your Personal | 124 |
| Access Your Personal your voicemail | 124 |
| Access Your Personal Audio Voicemail | 124 |
| Voice Messages States of Monitored Voicemail Accounts | 125 |
| Access Monitored Voicemail Account Messages | 125 |

CHAPTER 6**Settings 127**

| | |
|--|-----|
| Phone Settings Overview | 127 |
| Settings Overview | 127 |
| User Preferences Menu | 128 |
| Call Preferences | 128 |
| Forward Calls from Your Phone | 128 |
| Set up Voicemail on Your Phone | 129 |
| Block Caller ID | 130 |
| Block an Anonymous Call | 130 |
| Turn on Do Not Disturb for a Specific Line | 131 |
| Control the Call Waiting Tone | 131 |
| Secure a Call | 131 |
| Set Up an Auto Answer Page | 132 |
| Enable the Missed Call Shortcut | 132 |

- Add Multiple Locations for a BroadWorks XSI User 132
 - Enable Call Waiting 133
 - Audio Preferences 133
 - Specify an Audio Device for a Call 133
 - Change the Ringtone 134
 - Screen Preferences 134
 - Change the Screen Saver 134
 - Set the Backlight Timer 135
 - Adjust the Phone Screen Brightness or Contrast 135
 - Set the phone wallpaper 135
 - Attendant Console Preferences 136
 - Change the Display Mode 136
- Wi-Fi Settings 136
 - Connect the Phone to a Wireless Network at the First Boot 136
 - Trigger Wi-Fi Scan with Softkey 137
 - Turn the Wi-Fi On or Off from Your phone 138
 - Turn the Wi-Fi On or Off from the Phone Web Page 138
 - Connect the Phone to a Wi-Fi Manually 138
 - Connect Your Phone to a Wireless Network with WPS 139
 - Connect to a Wi-Fi Network When Your Phone Displays a Connection Failure Message 140
 - Set Up a Wi-Fi Profile from the Phone 140
 - Set Up a Wi-Fi Profile 142
 - Delete a Wi-Fi Profile 142
 - Change the Order of a Wi-Fi Profile 143
 - Scan and Save a Wi-Fi Network 143
 - View the Wi-Fi Status 145
 - View Wi-Fi Status Messages on the Phone 146
- HTTP Proxy Settings 146
 - Set Up a Proxy Server with the Auto Proxy Mode 147
 - Set Up a Proxy Server with the Manual Proxy Mode 147
 - Set Up a Proxy Server from the Phone Web Page 148
- VPN Connection Settings 149
 - Set Up a VPN Connection 150
 - Enable a VPN Connection 150

| | |
|---|-----|
| Disable a VPN Connection | 151 |
| Set Up a VPN Connection from the Phone Web Page | 152 |
| View the VPN Status | 152 |
| Executive Settings | 153 |
| Activate Call Filtering as an Executive | 154 |
| Deactivate Call Filtering as an Executive | 155 |
| Check Assistant List as an Executive | 156 |
| Executive Assistant Settings | 157 |
| Check Executive List as an Assistant | 157 |
| Opt in to or Out of an Executive's Pool as an Assistant | 158 |
| Activate or Deactivate Call Filtering as an Executive Assistant | 159 |
| Activate Call Diversion as an Executive Assistant | 160 |
| Deactivate Call Diversion as an Executive Assistant | 161 |
| Troubleshooting Executive Assistant Settings | 162 |
| Device Administration Settings | 162 |
| Change the Time Format | 162 |
| Change the Date Format | 162 |
| Set Language | 163 |
| Set up Power Save | 163 |
| Set Password | 163 |
| Set up the Profile Account | 164 |
| Reboot Your Phone | 165 |
| Phone Web Page Preferences | 165 |
| Assign a Ring Tone with the Phone Web Page | 165 |
| Control Ringer Volume | 165 |
| Turn on DND from the Phone Web Page | 166 |
| Configure the Screen Saver with the Phone Web Interface | 166 |
| Adjust the Backlight Timer from Phone Web Page | 167 |
| Add a Logo as a Phone Background | 167 |
| Enable Anonymous Call Blocking from the Phone Web Page | 168 |
| Enable Call Waiting from the Phone Web Page | 168 |
| Set Password from Phone Web Page | 168 |

- Supported Accessories 171
- Headsets 172
 - Important Headset Safety Information 172
 - Cisco Headsets 500 Series 173
 - Cisco Headset 521 and 522 173
 - Cisco Headset 531 and 532 174
 - Cisco Headset 561 and 562 176
 - Upgrade the Headset 500 Series Firmware 179
 - Cisco Headset 500 Series Setup 179
 - Replace your Cisco Headset 500 Series ear pads 181
 - Cisco Headsets 700 Series 182
 - Cisco Headset 730 182
 - Upgrade the Headset 730 Firmware 183
 - Find Details of Your Headset 730 on the Phone 184
 - Third Party Headsets 185
 - Audio Quality 185
 - Wired Headsets 185
 - Standard Headsets 186
 - Connect a standard headset 186
 - USB headsets 186
 - Connect a USB headset 186
 - E-Hookswitch Headset 187
 - Swap Headsets While on a Call 187
 - Cisco 6800 series Key Expansion Module setup overview 187
 - Key Expansion Module buttons and hardware 188
 - Key Expansion Module Power Information 188
 - Find information about the Key Expansion Module of your phone 189
 - View the UDI Information of the Key Expansion Module 189
 - Adjust the contrast of the Key Expansion Module 190
 - Change the display mode of the Key Expansion Module from the phone 190
 - Add Features or Menu Shortcuts to Key Expansion Module Line Keys 190
 - Remove Features or Menu Shortcuts from Key Expansion Module Line Keys 191
 - Wall Mount Kit 191
 - Wall Mount Kit Components 191

| | |
|--|-----|
| Install the Cisco IP Phone 6821 Multiplatform Phones on a Wall | 192 |
| Install a Cisco IP Phone 6841, 6851, 6861, or 6871 with the Wall Mount Kit | 197 |
| Adjust the Handset Rest | 200 |

CHAPTER 8**Product Safety and Security 203**

| | |
|---|-----|
| Safety and Performance Information | 203 |
| Power Outage | 203 |
| Regulatory Domains | 203 |
| Health-Care Environments | 203 |
| External Devices | 204 |
| Bluetooth Wireless Headset Performance | 204 |
| Ways to Provide Power to Your Phone | 204 |
| Phone Behavior During Times of Network Congestion | 205 |
| UL Warning | 205 |
| EnergyStar | 205 |
| Compliance Statements | 205 |
| Compliance Statements for the European Union | 205 |
| CE Marking | 205 |
| RF Exposure Statement for the European Union | 206 |
| Compliance Statements for the USA | 206 |
| Part 15 Radio Device | 206 |
| Compliance Statements for Canada | 206 |
| Canadian RF Exposure Statement | 206 |
| Canadian High-Power Radars Statement | 207 |
| Compliance Statements for New Zealand | 207 |
| Permit to Connect (PTC) General Warning | 207 |
| Compliance Statements for Taiwan | 208 |
| DGT Warning Statement | 208 |
| Low Power and Visual Warning Notices | 208 |
| Compliance Statement for Argentina | 208 |
| Compliance Information for Brazil | 208 |
| Compliance Statement for Singapore | 209 |
| Compliance Information for Japan | 209 |
| Compliance Information for Mexico | 209 |

| | |
|---|-----|
| FCC Compliance Statements | 209 |
| FCC Part 15.19 Statement | 209 |
| FCC Part 15.21 Statement | 209 |
| FCC RF Radiation Exposure Statement | 209 |
| FCC Receivers and Class B Digital Statement | 210 |
| Cisco Product Security Overview | 210 |
| Important Online Information | 210 |



CHAPTER 1

Your Phone

- [The Cisco IP Phone 6800 Series Multiplatform Phones, on page 1](#)
- [New and Changed Features, on page 3](#)
- [Phone Setup, on page 17](#)
- [Sign into Your Extension from Another Phone \(Extension Mobility\), on page 19](#)
- [Sign in to a Phone as a Guest, on page 20](#)
- [Set the Profile Rule on the Phone, on page 21](#)
- [Coworker Line Status, on page 21](#)
- [Add a Menu Shortcut to a Line Key, on page 25](#)
- [Remove the Menu Shortcut from a Line Key, on page 25](#)
- [Service Interruption Message on Home Screen, on page 25](#)
- [Phone Web Page, on page 25](#)
- [Phone Hardware and Buttons, on page 27](#)
- [Energy Savings, on page 34](#)
- [Additional Help and Information, on page 34](#)

The Cisco IP Phone 6800 Series Multiplatform Phones

The Cisco IP Phone 6800 Series Multiplatform Phones deliver easy-to-use, highly-secure voice communications. In the following figure, you see (Clockwise from the top left):

- Cisco IP Phone 6841 Multiplatform Phone
- Cisco IP Phone 6851 Multiplatform Phone with Key Expansion Module
- Cisco IP Phone 6851 Multiplatform Phone
- Cisco IP Phone 6861 Multiplatform Phone
- Cisco IP Phone 6871 Multiplatform Phone
- Cisco IP Phone 6821 Multiplatform Phone

Figure 1: Cisco IP Phone 6800 Series Multiplatform Phones



Table 1: Cisco IP Phone 6800 Series Multiplatform Phones Major Features

| Features | 6821 | 6841 | 6851 | 6861 | 6871 |
|---------------------------------------|---------------------------|---------------------------|---------------------------|---------------------------|---------------|
| Screen | Grayscale, with backlight | Grayscale, with backlight | Grayscale, with backlight | Grayscale, with backlight | Color |
| Lines | 2 | 4 | 4 | 4 | 6 |
| Fixed feature keys | 9 (See note below) | 8 | 8 | 8 | 8 |
| Power over Ethernet (PoE) | Supported | Not supported | Supported | Not supported | Supported |
| Wi-Fi | Not supported | Not supported | Not supported | Supported | Not supported |
| Electronic Hookswitch Headset support | Not supported | Not supported | Supported | Supported | Supported |
| USB port | Not supported | Not supported | Not supported | Not supported | Supported |



Note The Cisco IP Phone 6821 Multiplatform Phones presents many features on the softkeys instead of hard keys.

Your phone must be connected to a network and configured to connect to a call control system. The phones support many functions and features, depending on the call control system. Your phone might not have all functions available, based on the way your administrator has set it up.

When you add features to your phone, some features require a line button. But each line button on your phone can support only one function (a line, a speed dial, or a feature). If your phone's line buttons are already in use, your phone won't display any additional features.



Note This document doesn't include the DECT phones.

Related Topics

[Find Information About Your Phone](#), on page 53

Feature Support

This document describes all the features that the device supports. However, not all features may be supported with your current configuration. For information on supported features, contact your service provider or administrator.

New and Changed Features

New and Changed for Firmware Release 12.0(3)

| Revision | New and Changed Sections |
|---|--|
| Added a new topic to mention the support password setup after factory reset | Create User Password on Phone , on page 19 |
| Added new topics to support invoking XML applications from multicast paging | XML Application and Multicast Paging , on page 80 View XML Application Details , on page 81 |
| Added a new topic to support factory reset from a server | Factory Reset from Server , on page 59 |

New and Changed for Firmware Release 12.0(2)

| Revisions | New and Changed Sections |
|---|--|
| A new topic added for the task to manage participant list in Ad Hoc conference as a host | View the Participants List as a Host in Ad Hoc Conference , on page 79 |
| A new topic added for the task to manage participant list in Ad Hoc conference as a participant | View the Participants List as a Participant , on page 80 |
| A new topic added for the task to remove participant list in Ad Hoc conference as a host | Remove a Participant as a Host in Ad Hoc Conference , on page 79 |

New and Changed for Firmware Release 12.0(1)

| Revision | New and Changed Sections |
|--|---|
| Added a new topic for Site Survivability Gateway (SGW) | Service Interruption Message on Home Screen, on page 25 |
| Added a new task to view Webex call log duration | View Webex Call Logs Duration, on page 117 |

New and Changed for Firmware Release 11.3(7)

| Revision | New and Changed Sections |
|--|--|
| Added the topic to support spam indication for Webex calls | Spam Indication for Webex Calls, on page 118 |
| Updated the topic for Webex calls | View your Recent Calls, on page 115 |
| Updated the topic to add <code>VPN connection</code> | Phone Web Page, on page 25 |
| Added the topics for the new feature <code>VPN connection</code> | VPN Connection Settings, on page 149 Set Up a VPN Connection , on page 150 Enable a VPN Connection, on page 150 Disable a VPN Connection, on page 151 Set Up a VPN Connection from the Phone Web Page, on page 152 View the VPN Status, on page 152 |
| Updated the topic to remove a prerequisite related the line key | Configure Monitoring of an Individual Line, on page 23 |
| Added the task on how to view call statistics on the phone | View Call Records in Call Statistics, on page 56 |
| Updated the topic to mention how to set password in phone web page | Set Password, on page 163 |
| Added the task on how to set password from phone web page | Set Password from Phone Web Page, on page 168 |
| Updated the topic to add <code>HTTP proxy</code> | Phone Web Page, on page 25 |

| Revision | New and Changed Sections |
|---|--|
| Added the topics for the feature HTTP proxy | HTTP Proxy Settings, on page 146 Set Up a Proxy Server with the Auto Proxy Mode, on page 147 Set Up a Proxy Server with the Manual Proxy Mode, on page 147 Set Up a Proxy Server from the Phone Web Page, on page 148 |
| Added a new topic for Webex directory support | Webex Directory, on page 93 Search for a Contact in Your Webex Directory , on page 93 Search for a Webex Contact in All Directory, on page 95 Edit the Webex Directory Name , on page 96 |
| Updated topic for Webex call log support | View your Recent Calls, on page 115 View Calls Logs from Server , on page 118 |

New and Changed for Firmware Release 11.3(6)

| Revision | New and Changed Sections |
|--|--|
| Updated the topics for the new feature Permission Only for the Call Forward All Service Setup | Forward Calls, on page 74 |
| | Forward Calls with the Phone Web Page, on page 75 |
| | Activate Call Forward All with Feature Activation Code Synchronization, on page 76 |
| | Forward Calls from Your Phone, on page 128 |
| Updated several steps for the feature Enhancements of Displaying Contact Numbers from the LDAP Directory | Search for a Contact in the All Directories Screen, on page 91 |
| Updated the topic to add related topic links | Search for a Contact in Your LDAP Directory, on page 103 |
| Added the new task for the feature Enhancements of Displaying Contact Numbers from the LDAP Directory | Call a Contact in Your LDAP Directory, on page 104 |
| Added the new task for the feature Enhancements of Displaying Contact Numbers from the LDAP Directory | Edit a Contact Number in Your LDAP Directory, on page 105 |

| Revision | New and Changed Sections |
|--|--|
| Added the new topics for the feature Enhancements of Displaying Contact Numbers from the XML Directory | XML Directory, on page 106 |
| | Call a Contact in Your XML Directory, on page 106 |
| | Edit a Contact Number in Your XML Directory, on page 106 |
| Added the new task topic on how to control the ringer volume | Control Ringer Volume, on page 165 |
| Updated the task topic on non-availability of Continue softkey | Auto Provision Your Phone with Short Activation Code, on page 17 |
| Updated the task topic on non-availability of Save softkey | Create a Contact from a Recents Record, on page 120 |
| Updated the task topic on non-availability of Sign in softkey | Set up the Profile Account, on page 164 |

New and Changed for Firmware Release 11.3(5)

| Revision | New and Changed Sections |
|---|--|
| Added the task about how to check the MIC Cert Status | Find Information about MIC Cert Refresh Status, on page 61 |
| Updated the topic to support STIR/SHAKEN | Recent calls list, on page 115 |
| Updated the topic to introduce the new icons to support STIR/SHAKEN | View your Recent Calls, on page 115 |
| Updated the topic to add the Headset 730 support overview | Supported Accessories, on page 171 |
| Added the topic for the Headset 730 Support feature | Cisco Headsets 700 Series, on page 182 |
| Added the topic about the Headset 730 | Cisco Headset 730, on page 182 |
| Added the topic about how to upgrade headset firmware on the phone | Upgrade the Headset 730 Firmware, on page 183 |
| Added the topic about how to check the detailed information of the Headset 730 on the phone | Find Details of Your Headset 730 on the Phone, on page 184 |

New and Changed for Firmware Release 11.3(4)

This release has no impact on this guide.

New and Changed for Firmware Release 11.3(3)

| Revision | New and Changed Sections |
|---|--|
| Updated the step on how to add contacts in the topic | Search for a Contact in the All Directories Screen, on page 91 |
| Updated the topic with one prerequisite and another method to add contacts in the personal address book | Add a New Contact to Your Personal Address Book, on page 109 |
| Added the topic about how to add, edit, and delete the contacts in the BroadSoft Personal directory | Manage Your Contacts in the BroadSoft Personal Directory, on page 98 |
| Updated the topic with the new steps to add a contact | Create a Contact from a Recents Record, on page 120 |

| Revision | New and Changed Sections |
|--|--|
| Added the Executive-Assistant calls relevant topics for the Cisco IP Phone 6871 only | Executive Calls, on page 87 Join an Ongoing Call as an Executive, on page 87 Transfer an Ongoing Call to Yourself as an Executive, on page 87 Troubleshooting Executive Calls, on page 88 Executive Assistant Calls, on page 88 Initiate a Call On Behalf of an Executive as an Assistant, on page 88 Transfer an Ongoing Call to an Executive as an Assistant, on page 89 Join or Transfer an Ongoing Call to Yourself as an Executive Assistant, on page 90 Troubleshooting Executive-Assistant Calls, on page 90 Executive Settings, on page 153 Activate Call Filtering as an Executive, on page 154 Deactivate Call Filtering as an Executive, on page 155 Check Assistant List as an Executive, on page 156 Executive Assistant Settings, on page 157 Check Executive List as an Assistant, on page 157 Opt in to or Out of an Executive's Pool as an Assistant, on page 158 Activate Call Diversion as an Executive Assistant, on page 160 Deactivate Call Diversion as an Executive Assistant, on page 161 Activate or Deactivate Call Filtering as an Executive Assistant, on page 159 Troubleshooting Executive Assistant Settings, on page 162 |
| Updated the topic to block an anonymous call on the phone | Block an Anonymous Call, on page 130 |
| Added the topic to enable anonymous call blocking from the phone web page | Enable Anonymous Call Blocking from the Phone Web Page, on page 168 |
| Added the topic to enable call waiting on the phone | Enable Call Waiting, on page 133 |
| Added the topic to enable call waiting from the phone web page | Enable Call Waiting from the Phone Web Page, on page 168 |

| Revision | New and Changed Sections |
|---|--|
| Updated the topic to mention the new menu text box Unavailability | Change Your Status as a Call Center Agent , on page 85 |
| Updated the topic for the new softkeys of the calls history list | View your Recent Calls , on page 115 |
| Updated to topic to add the new menu item | Find Information About Your Phone , on page 53 |

New and Changed for Firmware Release 11.3(2)

| Revision | New and Changed Sections |
|---|---|
| Added the topics for adding and removing menu shortcuts on line keys | Add a Menu Shortcut to a Line Key , on page 25 Remove the Menu Shortcut from a Line Key , on page 25 |
| Added the topics for adding and removing menu shortcuts and features on key expansion module line keys | Add Features or Menu Shortcuts to Key Expansion Module Line Keys , on page 190 Remove Features or Menu Shortcuts from Key Expansion Module Line Keys , on page 191 |
| Added the topic for user authentication control on phone menus | User Authentication Control , on page 19 |
| Added the topic for Activation Code Sync | Activate Call Forward All with Feature Activation Code Synchronization , on page 76 |
| Updated the existing task to include information on reverse name lookup with local directory | View Calls Logs from Server , on page 118 |
| Added the topic to include the information on parking calls in a dedicated call park extension and call park status | Call Park Extension and Status , on page 73 |
| Added the overview description for phone settings | Phone Settings Overview , on page 127 |

| Revision | New and Changed Sections |
|-------------------------------------|--|
| Updated the directory-related tasks | <p data-bbox="922 289 1484 352">Search for a Contact in the All Directories Screen, on page 91</p> <p data-bbox="922 369 1484 432">Add a New Contact to Your Personal Address Book, on page 109</p> <p data-bbox="922 449 1484 512">Add a New Contact to Your Personal Address Book with Phone Web Page, on page 110</p> <p data-bbox="922 529 1484 592">Call a Contact in Your Personal Address Book, on page 111</p> <p data-bbox="922 609 1484 672">Edit a Contact in Your Personal Address Book, on page 111</p> <p data-bbox="922 688 1484 751">Remove a Contact from Your Personal Address Book, on page 112</p> |

| Revision | New and Changed Sections |
|---|---|
| Updated the tasks for the directory enhancement feature | <p>Search for a Contact in the All Directories Screen, on page 91</p> <p>Search for a Contact in Your BroadSoft Directory, on page 97</p> <p>Edit Your Contact Type in Your BroadSoft Directory, on page 98</p> <p>Edit Your BroadSoft Directory Name, on page 100</p> <p>Edit the Server Name of Your BroadSoft Directory, on page 101</p> <p>Edit Credentials of Your BroadSoft Directory, on page 101</p> <p>Search for a Contact in Your LDAP Directory, on page 103</p> <p>Make a Call to an IM and Presence Contact, on page 108</p> <p>Change Your Presence State, on page 109</p> <p>Add a New Contact to Your Personal Address Book, on page 109</p> <p>Add a New Contact to Your Personal Address Book with Phone Web Page, on page 110</p> <p>Search for a Contact in Your Personal Address Book, on page 110</p> <p>Call a Contact in Your Personal Address Book, on page 111</p> <p>Edit a Contact in Your Personal Address Book, on page 111</p> <p>Remove a Contact from Your Personal Address Book, on page 112</p> |
| Updated the tasks of forwarding a call | <p>Forward Calls with the Phone Web Page, on page 75</p> <p>Forward Calls from Your Phone, on page 128</p> |
| Updated the topic title | <p>Your Personal Voicemail Account, on page 123</p> <p>Find out if you have new voicemail messages Your Personal , on page 124</p> <p>Access Your Personal your voicemail, on page 124</p> <p>Access Your Personal Audio Voicemail, on page 124</p> |

| Revision | New and Changed Sections |
|---|--|
| Added the topics for the monitored voicemail with PLK | Voice Messages States of Monitored Voicemail Accounts , on page 125 Access Monitored Voicemail Account Messages , on page 125 |
| Updated the task with a new step to include information on the different user credentials | Edit Credentials of Your LDAP Directory , on page 103 |
| Updated the task to include user credentials | Search for a Contact in Your LDAP Directory , on page 103 |
| Update the topics to introduce or mention the LDAP cache mechanism | LDAP Directory , on page 102 Search for a Contact in Your LDAP Directory , on page 103 |
| Add the topic to edit user credentials to access the LDAP directory | Edit Credentials of Your LDAP Directory , on page 103 |
| Updated the existing topic to include ACD status synchronization | Call Center Features , on page 83 |
| Updated the topic to check the status of a call center agent. | Sign In as a Call Center Agent , on page 84 |

New and Changed for Cisco IP Phone 6871 with Multiplatform Firmware Release 11.3(1)

| Revision | New and Changed Sections |
|--|---|
| Updated the hardware information with Cisco IP Phone 6871 Multiplatform Phones | The Cisco IP Phone 6800 Series Multiplatform Phones , on page 1 Navigation , on page 32 |
| Updated the accessibility features with Cisco IP Phone 6871 Multiplatform Phones | Cisco IP Phone 6871 Multiplatform Phones Hearing-Impaired Accessibility Features , on page 38 Cisco IP Phone 6871 Multiplatform Phones Vision-Impaired Accessibility Features , on page 45 Cisco IP Phone 6871 Multiplatform Phones Mobility-Impaired Accessibility Features , on page 51 |
| Updated the supported accessories with Cisco IP Phone 6871 Multiplatform Phones | Supported Accessories , on page 171 |
| Added the supported Cisco headsets | Cisco Headsets 500 Series , on page 173 |

New and Changed for Firmware Release 11.3(1)

| Revision | New and Changed Sections |
|--|---|
| Added new task to support Auto Provisioning with Short Activation Code. | Auto Provision Your Phone with Short Activation Code, on page 17 |
| Updated an existing task to support display UDI feature on phone screen | Find Information About Your Phone, on page 53 |
| Added a task to support Serviceability Enhancement Messages for Provisioning Failure | Get More Information When Your Phone Displays a Provisioning Failure Message, on page 60 |
| Added a task to support One-Button Call Park | Park and Unpark a Call with One Line Key, on page 73 |
| Added a task to support Wi-Fi auto scan | Connect the Phone to a Wireless Network at the First Boot, on page 136 |
| Added a task to support Softkey Triggers Wi-Fi Scan | Trigger Wi-Fi Scan with Softkey, on page 137 |
| Added a task to support Serviceability Enhancement Messages for Network Connection Failure | Connect to a Wi-Fi Network When Your Phone Displays a Connection Failure Message, on page 140 |
| Added a new task to support display UDI on key expansion module screen | View the UDI Information of the Key Expansion Module, on page 189 |

New and Changed for Firmware Release 11.2(4)

| Revisions | New or Changed Sections |
|---|---|
| Updated the hardware information with Cisco IP Phone 6861 Multiplatform Phones | The Cisco IP Phone 6800 Series Multiplatform Phones, on page 1 Navigation, on page 32 |
| Updated the network connection with the wireless option | Connect to the Network, on page 17 |
| Updated the accessibility features with Cisco IP Phone 6861 Multiplatform Phones | Cisco IP Phone 6841, 6851, and 6861 Hearing-Impaired Accessibility Features, on page 36 Cisco IP Phone 6841, 6851, and 6861 Vision-Impaired and Blind Accessibility Features, on page 43 Cisco IP Phone 6841, 6851, and 6861 Mobility-Impaired Accessibility Features, on page 50 |
| Updated the navigation to the phone directories with Cisco IP Phone 6861 Multiplatform Phones | Contacts, on page 91 |

| Revisions | New or Changed Sections |
|---|--|
| Added topics about Wi-Fi feature for Cisco IP Phone 6861 Multiplatform Phones | Wi-Fi Settings, on page 136 Turn the Wi-Fi On or Off from Your phone, on page 138 Turn the Wi-Fi On or Off from the Phone Web Page, on page 138 Connect the Phone to a Wi-Fi Manually, on page 138 Connect Your Phone to a Wireless Network with WPS, on page 139 Set Up a Wi-Fi Profile from the Phone, on page 140 Set Up a Wi-Fi Profile , on page 142 Delete a Wi-Fi Profile, on page 142 Change the Order of a Wi-Fi Profile , on page 143 Scan and Save a Wi-Fi Network, on page 143 View the Wi-Fi Status, on page 145 View Wi-Fi Status Messages on the Phone, on page 58 |
| Updated the supported accessories with Cisco IP Phone 6861 Multiplatform Phones | Supported Accessories, on page 171 |
| Added topics about Wall Mount Kit | Wall Mount Kit, on page 191 |

New and Changed for Firmware Release 11.2(3)SR1

| Revisions | New or Changed Sections |
|--|---|
| Added a new task about getting your phone onboard with the activation code | Onboard Your Phone with Activation Code, on page 18 |

New and Changed for Firmware Release 11.2(3)

| Revisions | New or Changed Sections |
|---|---|
| Added a new topic replacing the <i>Monitor Coworker's Line</i> topic. | Coworker Line Status, on page 21 |
| Added a new task on how to hide or show the BLF list. | Activate or Deactivate Monitoring of the BLF List, on page 22 |
| Added a new task on how to monitor an individual line. | Configure Monitoring of an Individual Line, on page 23 |

| Revisions | New or Changed Sections |
|---|--|
| Added a new task on how to remove the configured feature from a line key. | Remove the Feature Configured on a Line Key, on page 24 |
| Added a new task on contact search in multiple directories. | Search for a Contact in the All Directories Screen, on page 91 |
| Updated the topic on profile account setup to support resync profile with the SIP credentials or the login credentials. | Set up the Profile Account, on page 164 |

New and Changed for Firmware Release 11.2(2)

| Revisions | New and Changed Sections |
|--|---|
| Added a new topic to introduce the phone buttons and hardware of Cisco IP Phone 6821 Multiplatform Phones | Cisco IP Phone 6821 Multiplatform Phones Buttons and Hardware, on page 27 |
| Added a new topic for the hearing-impaired accessibility features of Cisco IP Phone 6821 Multiplatform Phones | Cisco IP Phone 6821 Multiplatform Phones Hearing-Impaired Accessibility Features, on page 35 |
| Added a new topic for the vision-impaired and blind accessibility features of Cisco IP Phone 6821 Multiplatform Phones | Cisco IP Phone 6821 Multiplatform Phones Vision-Impaired and Blind Accessibility Features, on page 40 |
| Added a new topic for the mobility-impaired accessibility features of Cisco IP Phone 6821 Multiplatform Phones | Cisco IP Phone 6821 Multiplatform Phones Mobility-Impaired Accessibility Features, on page 48 |
| Updated the topic with the information of Cisco IP Phone 6821 Multiplatform Phones | The Cisco IP Phone 6800 Series Multiplatform Phones, on page 1 |
| Updated the topic with the softkeys, line, and feature buttons of Cisco IP Phone 6821 Multiplatform Phones | Softkey, Line, and Feature Buttons, on page 32 |
| Updated the topic with the navigation information of Cisco IP Phone 6821 Multiplatform Phones | Navigation, on page 32 |

New and Changed for Firmware Release 11.2(1)

| Revisions | New or Changed Sections |
|--|---|
| Added a new topic to support multiple locations (anywhere) for a BroadWorks XSI user | Add Multiple Locations for a BroadWorks XSI User, on page 132 |
| Updated the topic with the new Display recents from option to support XSI call logs improvement | View your Recent Calls, on page 115 |

| Revisions | New or Changed Sections |
|--|---|
| Added a new topic to support XSI call logs improvement | View Calls Logs from Server , on page 118 |
| Updated the topic with the new Missed softkey to support XSI call logs improvement. | Return a recent call , on page 119 |
| Added a new topic to support DND and call forward indication for a non-selected line | Silence an Incoming Call , on page 69 |
| Updated the topic with icons for call forward and DND to support DND and call forward indication for a non-selected line | Forward Calls , on page 74 Turn On Do Not Disturb , on page 69 |
| Updated the topic to support XSI caller ID blocking | Block Caller ID , on page 130 |
| Added a new topic to support username and password collection on HTTP authentication challenge | Set up the Profile Account , on page 164 |
| Updated the menu navigation for ringtone setting to support audio equalizers to customize audio for handset and headset (acoustic audio) | Change the Ringtone , on page 134 |
| Added a new topic to support audio equalizers to customize audio for handset and headset (acoustic audio) | Specify an Audio Device for a Call , on page 133 |
| Updated the topic to support screen saver type lock removal | Change the Screen Saver , on page 134 |

New and Changed for Firmware Release 11.1(2)

| Revision | Updated Sections |
|--|---|
| Emergency Call Support | Make an Emergency Call , on page 65 |
| Reverse Name Lookup | Reverse Name Lookup for Incoming and Outgoing Calls , on page 112 |
| Add support for key expansion module | Cisco 6800 series Key Expansion Module setup overview , on page 187 Find information about the Key Expansion Module of your phone , on page 189 Configure a speed-dial on a line key , on page 66 |
| Added how to change display mode of key expansion module, contrast of key expansion module LCD | Adjust the contrast of the Key Expansion Module , on page 190 Change the display mode of the Key Expansion Module from the phone , on page 190 |

New and Changed for Firmware Release 11.1(1)

| Feature | New or Changed Sections |
|---------------------------------|---|
| Call Center Support | Call Center Features, on page 83 |
| Call Recording | Record a Call, on page 83 |
| Contrast Adjustment Enhancement | Adjust the Phone Screen Brightness or Contrast, on page 135 |
| Power Save Support | Set up Power Save, on page 163 |
| Presence | Instant Message and Presence Contacts, on page 107 Change Your Presence State, on page 109 Make a Call to an IM and Presence Contact, on page 108 |

Phone Setup

Your administrator sets up your phone and connects it to the network. If your phone is not set up and connected, contact your administrator for instructions.

Cisco IP Phone 6841 Multiplatform Phones and Cisco IP Phone 6861 Multiplatform Phones do not support Power over Ethernet (PoE). Connect the phone using the power adapter to power the phone.

Connect to the Network

You need to connect the phone to the telephone network.

- Wired connection—The phone is plugged into the network using an Ethernet cable.
- Wireless connection—The Cisco IP Phone 6861 Multiplatform Phones connect to a Wireless Access Point using Wi-Fi. You need an SSID, security settings, username, and password to connect to the wireless network. For more information, see [Wi-Fi Settings, on page 136](#).

Auto Provision Your Phone with Short Activation Code

After your phone boots up, you see a welcome screen where you can enter the activation code. If you don't have the activation code, contact your administrator.

Before you begin

Your administrator provides your activation code:

Procedure

-
- Step 1** Press pound (#), and enter your activation code in the field that is provided on the Welcome screen.

Step 2 Press **Continue**.

Note The **Continue** softkey doesn't appear until you enter first three digits of the valid activation code followed by a # key. The **Delete** softkey appears only when you enter the first digit of activation code in the **Enter activation code** box.

The phone completes the provisioning process automatically.

Step 3 If an error message displays, enter the code again or contact your administrator.

Onboard Your Phone with Activation Code

After your phone boots up, you will see a welcome screen where you can enter the activation code. If you don't have an activation code, contact your administrator.



Note The Cisco IP Phone 6861 Multiplatform Phones don't support onboarding with activation code.

Before you begin

Your administrator provides you with a 16-digit activation code in the form xxxx-xxxx-xxxx-xxxx.

Procedure

Step 1 Enter your activation code in the field that is provided on the Welcome screen. You don't need to input the hyphen (-) character when entering the code.

Step 2 Press **Continue**.

Note The **Continue** softkey appears only when you enter either valid 16-digit activation code or the valid first three digits of it followed by a # key. The **Delete** softkey appears only when you enter the first digit of the activation code in the **Enter activation code** box.

The phone completes the onboarding process automatically.

Step 3 If an error message displays, enter the code again or contact your administrator for a new code.

Set a Password on Initial Phone Boot Up

The first time your phone boots up, you may be prompted to set a password. If you are not prompted, your administrator has created a password for you.

Procedure

Step 1 Enter your password in the **New password** and **Reenter new password** fields.

Step 2 Press **Save**.

Create User Password on Phone

Your administrator enables your phone to prompt for **Set password** notification screen when your phone reboots after every factory reset. This feature enhances the security of your phone.

Procedure

Step 1 Perform one of the following:

- After factory reset, your phone reboots and you see the **Set password** prompt on the phone.
- Press
 - a. Select **Status > Issues**. If the phone has no user password that is created, you see a message **No user password provided** and you see the **Select** softkey which lets you access the **No user password provided** screen.

If the phone has user password, the value of the **Issues** menu is displayed as **None**.
 - b. Press **Create**.

Step 2 In the **Set password** screen, set the new password in the **New password** box.
After you create a new password, an unlock icon appears on the phone screen.

User Authentication Control

Your administrator can configure if you require authentication to access phone menus. Your administrator can also customize and turn off the authentication to allow access to all phone menus.

With this feature, whether any phone menu needs authentication is controlled by your administrator. If your administrator configures authentication to access the menu, you need to provide the password and sign in to access the menu.

Sign into Your Extension from Another Phone (Extension Mobility)

If extension mobility is configured, you can sign into a different phone in your network and have it act the same as your phone. After you sign in, the phone adopts your personal directory number.

Before you begin

Your administrator configures provisioning authority.

Procedure

Step 1 Press **Sign in**.

Step 2 Enter your username and password, then press **Sign in**.

The password field allows two input methods: alphanumeric and numeric. While you type in the password, you see the **Options** softkey on the phone. Use this softkey to change the current password input type. Select **Input all** for alphanumeric input and select **Input num** for numeric entry. Your administrator configures the password input method on the phone web page.

Sign out of Your Extension from Another Phone

Procedure

Press **Sign out**.

Sign in to a Phone as a Guest

Your phone has a guest account when your administrator enables hoteling on your phone. You can then sign in to a different phone in your network as a guest.

Procedure

Step 1 Press **Sign in**.

Step 2 Enter your user ID and password.

The password field uses two types of input methods; alphanumeric and numeric. While you type in the password, you see **Options** softkey on the phone. You can use this softkey to change the current password input type. Select **Input all** for alphanumeric input and select **Input num** for numeric entry.

Step 3 Press **Save**.



Note An administrator can set up a phone to make emergency calls. Whenever you sign in as a guest to a registered phone, the phone transfers a request to obtain the location of the phone. The location is sent to the emergency services when you make an emergency call.

Sign Out of a Phone as a Guest

Procedure

-
- Step 1** Press **Guest Out**.
- Step 2** Press **Sign Out**.
-

Set the Profile Rule on the Phone

Procedure

-
- Step 1** Press **Applications** .
- Step 2** Select **Device administration** > **Profile rule**.
- Step 3** Enter the profile rule using the phone keypad.
- Step 4** Press **Resync**.
-

Coworker Line Status

You can set up line keys on your phone to monitor coworkers' lines. This feature is useful if you routinely handle calls for coworkers and need to see if they are available to answer calls. The monitoring line keys function as Busy Lamp Field (BLF) keys. A BLF is an LED that changes color to indicate the status of the monitored line.

The following table describes the LED status:

Table 2: BLF Key LED Status

| LED Color | Meaning |
|--------------|----------------------------------|
| Green | The monitored line is available. |
| Red | The monitored line is busy. |
| Blinking red | The monitored line is ringing. |
| Amber | Error in BLF key configuration. |

Your administrator performs the necessary setup on the server and for the phone to allow you to monitor the desired lines.

You can configure monitoring on your phone in two ways:

















- You can configure monitoring of an individual user's line.

- If your administrator has set up a BLF list for you, you can activate or deactivate monitoring of the entire list. The BLF list is the list of users whose lines you can monitor. The phone monitors each user on a separate line key. The phone assigns available line keys for monitoring, automatically.

With the appropriate configuration, you can use the BLF keys to call the monitored line (speed dial), and to answer incoming calls to the monitored line (call pickup).

When the configuration is complete, the icon in the BLF key label indicates the combination of features configured on the key:

Table 3: Busy Lamp Field Icons

| | BLF | BLF and Speed Dial | BLF and Call Pickup | BLF, Speed Dial, and Call Pickup |
|----------|---|---|---|---|
| Idle |  |  |  |  |
| Alerting |  |  |  |  |
| In use |  |  |  |  |
| Error |  |  |  |  |

Activate or Deactivate Monitoring of the BLF List

If your administrator has configured a Busy Lamp Field (BLF) list for you, you can activate or deactivate monitoring of the entire BLF list. The phone monitors each user on a separate line key. When you activate monitoring, the phone assigns available line keys in sequence to monitor the BLF list entries.

The phone may use line keys both on the phone and any Key Expansion Module attached to the phone, or only the Key Expansion Module. This is controlled by your administrator.

The BLF list keys function in the same way as individual BLF keys. See [Coworker Line Status, on page 21](#) for details. When you activate monitoring, the phone starts showing the status of the monitored lines on the BLF list keys. You can use each BLF list key to call the monitored line (speed dial), and to answer incoming calls to the monitored line (call pickup).



Note The sequential order of the users in the BLF list is set by your administrator. The corresponding BLF list keys always maintain this sequential order. You can choose to configure another feature such as speed dial on a BLF list key at any time. However, it renders the line key unavailable for the BLF list.

Whenever you make any change to line key configurations, the phone redoes the BLF list key assignment taking the change into account. The phone only assigns available line keys, and in the same sequential order, every time. This can result in changes in the positions of BLF list keys.

The phone monitors as many users as possible with the available line keys. You can make more line keys available for monitoring the list by removing features configured on line keys. See [Remove the Feature Configured on a Line Key, on page 24](#) for details.

Before you begin

Your administrator configures the BLF list.

Procedure

- Step 1** Press **Applications** .
- Step 2** Select **User preferences > Attendant console preferences > BLF list**.
- When **BLF list** is set to **Show**, monitoring is activated. The phone shows the status of the monitored lines on the BLF list keys.
 - When **BLF list** is set to **Hide**, monitoring is deactivated.
- Step 3** Press **Set**.
-

Configure Monitoring of an Individual Line

You can configure a line key to monitor a coworker's line status. When you add speed dial to the configuration, you can use the line key to call the monitored line. When you add call pickup to the configuration, you can use the line key to answer incoming calls to the monitored line. The line key functions as a Busy Lamp Field (BLF) key. See [Coworker Line Status, on page 21](#) for details.

You can select any available line key to configure this feature. You can also select any line key that is functioning as a speed-dial key or as a BLF key. Your configuration will override any existing configuration for the key.

If your administrator has configured a BLF list for you, you can only monitor the lines of people who are in the list.

Your phone may already be monitoring the entire list. See [Activate or Deactivate Monitoring of the BLF List, on page 22](#) for details. You can still configure an individual key to monitor a line. However, the phone will then no longer monitor the line automatically as part of the list. If you remove the individual BLF key configuration, the phone resumes monitoring the line automatically as part of the list. Note that the phone adjusts the BLF list key assignment every time it has to add or remove a line for automatic monitoring. This results in changes in the positions of BLF list keys.

Before you begin

- Your administrator performs the necessary setup to allow you to monitor the concerned line.
- Your administrator allows configuring the BLF feature options on line keys.

Procedure

- Step 1** Press and hold down the line key for two seconds.
- Step 2** On the **Select feature** screen, select one of these options:
- If you just want to use the key to monitor a line, select **BLF presence**.

- If you want to use the key to monitor a line and also speed-dial the monitored line, select **BLF + Speed dial**.
- If you want to use the key to monitor a line and also answer incoming calls to the monitored line, select **BLF + Call pickup**.
- If you want to use the key for all the three functions, select **BLF + Speed dial + Call pickup**.

Step 3 Enter the user ID of the person whose line you want to monitor, in the **User ID** field.

Note You must enter the user ID. The user ID may not be the person's name or extension. Consult your administrator if you need assistance.

If your administrator has configured a BLF list for you, you can select the user whose line you want to monitor from the list:

a) Select **Search BLF list**.

Users whose names appear in grey in the list are ones that your phone is already monitoring on individually configured BLF keys.

b) Select the user whose line you want to monitor.

The user ID appears in the **User ID** field.

If you select a user who is already monitored on an individually configured key, the new configuration overrides the previous configuration to monitor the user.

Step 4 Press **Save**.

Remove the Feature Configured on a Line Key

You can remove the feature configured on a line key.

If your phone is monitoring a Busy Lamp Field (BLF) list, removing the feature configured on a line key makes the line key available for monitoring the BLF list. This can change the positions of BLF list keys. See [Activate or Deactivate Monitoring of the BLF List, on page 22](#) for details.



Note You cannot remove some features configured by your administrator.

Procedure

Step 1 Press and hold down the line key for two seconds.

Step 2 On the **Select feature** screen, select **None**.

Step 3 When prompted to confirm, press **OK**.

Add a Menu Shortcut to a Line Key

After you configure a line key with a menu shortcut, you can open the menu with a simple press on the line key.

Before you begin

Your administrator must enable this feature on your phone.

Procedure

- Step 1** Press and hold a line key for two seconds. The available feature list is displayed.
 - Step 2** Select **Menu shortcut** from the list. The available menu list is displayed.
 - Step 3** Scroll the list and select the menu you want to add to the line key and press **Set**.
-

Remove the Menu Shortcut from a Line Key

Procedure

- Step 1** Press and hold the line key for two seconds. The available feature list is displayed.
 - Step 2** Select **None** from the list and press **Set**.
-

Service Interruption Message on Home Screen

When Webex cloud server is not available, you will see **Service interruption** notification on the phone home screen and the line status shows the survivability icon. During this situation, phone gets connected to the Site Survivability Gateway (SGW) so that you can use at least basic calling features. SGW services are deployed within your local network, hence, the phone supports only basic calling features. If you check the line status, it shows **Interrupted**. To view the line status, see [View the Line Status, on page 56](#).

When you experience this issue, your administrator can help troubleshoot.

Phone Web Page

You can customize some phone settings with the phone web page, which you access from your computer. Your administrator gives you the page URL, your user ID, and password.

In the phone web page, you can control features, line settings, and phone services for your phone.

- Phone features include speed dial, do not disturb, and your personal address book.

- Line settings affect a specific phone line (directory number) on your phone. Line settings can include call forward, visual and audio message indicators, ring patterns, and other line-specific settings.

The following table describes some specific features that you configure using the phone web page.

| Features | Description |
|----------------------------|--|
| Call forward | You specify the number that will receive calls when call forward is enabled on the phone. Use the phone web page to set up more complicated call forward functions, for example, when your line is busy. |
| Speed dial | You assign phone numbers to speed-dial numbers so that you can quickly call that person. |
| Ringtone | You assign a ringtone to a specific line. |
| Personal directory contact | You add a contact to your personal directory with phone web page. |
| HTTP proxy | You set up an HTTP proxy for the phone to connect to the internet. |
| VPN connection | You set up the phone to connect to the network through a VPN sever. |

Related Topics

[Forward Calls with the Phone Web Page](#), on page 75

[Speed Dial](#), on page 65

[Assign a Ring Tone with the Phone Web Page](#), on page 165

[Add a New Contact to Your Personal Address Book with Phone Web Page](#), on page 110

[HTTP Proxy Settings](#), on page 146

Speed dial numbers

When you dial a number on your phone, you enter a series of digits. When you set up a speed dial number, the speed dial number must contain all the digits you need to make the call. For example, if you need to dial 9 to get an outside line, you enter the number 9 and then the number you want to dial.

You can also add other dialed digits to the number. Examples of additional digits include a meeting access code, an extension, a voicemail password, an authorization code, and a billing code.

The dial string can contain the following characters:

- 0 to 9
- Pound (#)
- Asterisk (*)
- Comma (,)—This is the pause character, and gives a 2 second delay in the dialing. You can have several commas in a row. For example, two commas (,,) represent a pause of 4 seconds.

The rules for dial strings are:

- Use the comma to separate the parts of the dial string.
- An authorization code must always precede a billing code in the speed dial string.

- A single comma is required between the authorization code and the billing code in the string.
- A speed dial label is required for speed dials with authorization codes and additional digits.

Before you configure the speed dial, try to dial the digits manually at least once to ensure that the digit sequence is correct.

Your phone does not save the authorization code, billing code, or extra digits from the speed dial in the call history. If you press **Redial** after you connect to a speed dial destination, the phone prompts you to enter any required authorization code, billing code, or additional digits manually.

Example

To set up a speed dial number to call a person at a specific extension, and if you need an authorization code and billing code, consider the following requirements:

- You need to dial **9** for an outside line.
- You want to call **5556543**.
- You need to input the authorization code **1234**.
- You need to input the billing code **9876**.
- You must wait for 4 seconds.
- After the call connects, you must dial the extension **56789#**.

In this scenario, the speed dial number is **95556543,1234,9876,,56789#**.







Phone Hardware and Buttons

Cisco IP Phone 6821 Multiplatform Phones Buttons and Hardware

The following figure shows the Cisco IP Phone 6821 Multiplatform Phones.

Figure 2: Cisco IP Phone 6821 Multiplatform Phones



| | | |
|---|---|---|
| 1 | Light strip | Indicates whether you have an incoming call (flashing red) or a new voice message (steady red). |
| 2 | Programmable feature buttons and line buttons |  Access your phone lines, features, and call sessions. For more information, see Softkey, Line, and Feature Buttons, on page 32 . |
| 3 | Softkey buttons |  Access functions and services such as Conference and Transfer. For more information, see Softkey, Line, and Feature Buttons, on page 32 . |
| 4 | Navigation cluster | Navigation ring and Select  button. Scroll through menus, highlight items, and select the highlighted item. |
| 5 | Applications and Headset | Applications  Access call history, user preferences, phone settings, and phone model information. Headset  Toggle the headset on or off. When a headset is active, a headset icon is displayed in the header. |
| 6 | Mute and Speakerphone | Mute  Toggle the microphone on or off. When the microphone is muted, a mute icon flashes on the screen. Speakerphone  Toggle the speakerphone on or off. |



| | | |
|---|----------------------|--|
| 7 | Volume button |  <p>Adjust the handset, headset, and speakerphone volume (off hook) and the ringer volume (on hook).</p> |
|---|----------------------|--|











Cisco IP Phone 6841, 6851, and 6861 Multiplatform Phones Buttons and Hardware

The following figure shows the Cisco IP Phone 6841.

Figure 3: Cisco IP Phone 6841, 6851, and 6861 Multiplatform Phones Buttons and Features



| | | |
|---|---|--|
| 1 | Handset and Handset light strip | Indicates whether you have an incoming call (flashing red) or a new voice message (steady red). |
| 2 | Programmable feature buttons and line buttons |  Access your phone lines, features, and call sessions. For more information, see Softkey, Line, and Feature Buttons, on page 32 . |
| 3 | Softkey buttons |  Access functions and services. For more information, see Softkey, Line, and Feature Buttons, on page 32 . |
| 4 | Navigation cluster | Navigation ring and Select  button. Scroll through menus, highlight items, and select the highlighted item. |







| | | |
|---|--|--|
| 5 | Hold/Resume, Conference, and Transfer | <p>Hold/Resume  Place an active call on hold and resume the held call.</p> <p>Conference  Create a conference call.</p> <p>Transfer  Transfer a call.</p> |
| 6 | Speakerphone, Mute, and Headset | <p>Speakerphone  Toggle the speakerphone on or off. When the speakerphone is on, the button is lit.</p> <p>Mute  Toggle the microphone on or off. When the microphone is muted, the button is lit.</p> <p>Headset  Toggle the headset on or off. When the headset is on, the button is lit.</p> |
| 7 | Contacts, Applications, and Messages | <p>Contacts  Access personal and corporate directories.</p> <p>Applications  Access call history, user preferences, phone settings, and phone model information.</p> <p>Messages  Autodial your voice messaging system.</p> |
| 8 | Volume button |  <p>Adjust the handset, headset, and speakerphone volume (off hook) and the ringer volume (on hook).</p> |







Cisco IP Phone 6871 Multiplatform Phones Buttons and Hardware

The following figure shows the Cisco IP Phone 6871.

Figure 4: Cisco IP Phone 6871 Multiplatform Phones Buttons and Features





| | | |
|---|---|--|
| 1 | Handset and Handset light strip | Indicates whether you have an incoming call (flashing red) or a new voice message (steady red). |
| 2 | Programmable feature buttons and line buttons |  Access your phone lines, features, and call sessions. For more information, see Softkey, Line, and Feature Buttons, on page 32 . |
| 3 | Softkey buttons |  Access functions and services. For more information, see Softkey, Line, and Feature Buttons, on page 32 . |
| 4 | Navigation cluster | Navigation ring and Select  button. Scroll through menus, highlight items, and select the highlighted item. |
| 5 | Hold/Resume, Conference, and Transfer | Hold/Resume  Place an active call on hold and resume the held call. Conference  Create a conference call. Transfer  Transfer a call. |

| | | |
|---|---|--|
| 6 | Speakerphone, Mute, and Headset | <p>Speakerphone  Toggle the speakerphone on or off. When the speakerphone is on, the button is lit.</p> <p>Mute  Toggle the microphone on or off. When the microphone is muted, the button is lit.</p> <p>Headset  Toggle the headset on or off. When the headset is on, the button is lit.</p> |
| 7 | Contacts, Applications, and Messages | <p>Contacts  Access personal and corporate directories.</p> <p>Applications  Access call history, user preferences, phone settings, and phone model information.</p> <p>Messages  Autodial your voice messaging system.</p> |
| 8 | Volume button |  <p>Adjust the handset, headset, and speakerphone volume (off hook) and the ringer volume (on hook).</p> |

Navigation

Use the outer ring of the Navigation cluster to scroll through menus and between lines. Use the inner **Select** button of the Navigation cluster to select items.



6821: ; 6841, 6851, 6861, and 6871: 

If a menu item has an index number, you can enter the index number with the keypad to select the item.









Softkey, Line, and Feature Buttons

You can interact with the features on your phone in several ways:

- Softkeys, located below the screen, give you access to the function displayed on the screen above the softkey. The softkeys change depending on what you are doing at the time. The **More ...** softkey shows you that more functions are available.
- Feature and line buttons give you access to phone features and phone lines. On the Cisco IP Phone 6821, these are the buttons on the left side of the screen. On the Cisco IP Phone 6841, 6851, 6861, and 6871, these are the buttons on either side of the screen.

- Feature buttons—Used for features such as **Speed dial** or **Call pickup**, and to view your status on another line.
- Line buttons—Used to initiate or answer a call. You can also use a line key to open and close the call session window, and to navigate through the call session window. Open the call session window to see the calls on the line.

Feature and line buttons illuminate to indicate status:

-  or  Green—Line is idle.
-  or  Red, steady—Line is active or in use.
-  or  Red, flashing—Line is on hold or there is an inbound call.
-  or  Amber, steady—Line is unregistered (cannot be used).

Some functions can be set up as softkeys or as feature buttons. You can also access some functions with softkeys or the associated hard button.

The Cisco IP Phone 6821 has a limited number of hard buttons. You use the softkeys to access most call features.

Phone Screen Features

The phone screen shows information about your phone such as directory number, active call and line status, softkeys, speed dials, placed calls, and phone menu listings. The screen is made up of three sections: the header row, the middle section, and the footer row.

Figure 5: Cisco IP Phone 6841 and 6851 Screen



The Cisco IP Phone 6821 has a similar layout but in a more compact format.

| | |
|---|---|
| 1 | At the top of the screen is the header row. The header row displays the phone number, current date and time, as well a number of icons. The icons display when features are active. |
| 2 | The middle of the phone screen displays the information associated with the line and feature buttons on the phone. When you select a line which has more than two registered lines, a black box highlight around the selected line is displayed. There will be no highlight for an active call. Active and incoming call screen supports more than 21 characters. The Cisco IP Phone can display 15 digits on the phone screen when line is inactive. |
| 3 | The bottom row of the screen contains the softkey labels. Each label indicates the action for the softkey button below the screen. |

Clean your phone screen

Procedure

If your phone screen gets dirty, wipe it with a soft, dry cloth.

Caution Don't use any liquids or powders on the phone because they can contaminate the phone components and cause failures.

Differences Between Phone Calls and Lines

We use the terms *lines* and *calls* in very specific ways to explain how to use your phone.

- **Lines**—Each line corresponds to a directory number or intercom number that others can use to call you. You have as many lines as you have directory numbers and phone line icons.
- **Calls**—Each line can support multiple calls. By default, your phone supports two connected calls per line, but your administrator can adjust this number according to your needs.

Only one call can be active at any time; other calls are automatically placed on hold.

Here is an example: If you have two lines and each line supports four calls, then you could have up to eight connected calls at one time. Only one of those calls is active and the other seven are held calls.

Energy Savings

Your administrator can reduce the amount of power that the phone screen uses when you're not using your phone. Level of energy-saving that your administrator can set up:

- **Power Save**—The backlight or screen turns off when the phone has been inactive for a period of time.



Note The Cisco IP Phone 6821 Multiplatform Phones does not support Power Save.

Additional Help and Information

If you have questions about the functions available on your phone, contact your administrator.

The Cisco website (<https://www.cisco.com>) contains more information about the phones and call control systems.

- For quick start guides and end-user guides in English, follow this link:

<https://www.cisco.com/c/en/us/support/collaboration-endpoints/ip-phone-6800-series-multiplatform-firmware/products-user-guide-list.html>

- For guides in languages other than English, follow this link:

<https://www.cisco.com/c/en/us/support/collaboration-endpoints/ip-phone-6800-series-multiplatform-firmware/tsd-products-support-translated-end-user-guides-list.html>

- For licensing information, follow this link:

<https://www.cisco.com/c/en/us/support/collaboration-endpoints/ip-phone-6800-series-multiplatform-firmware/products-licensing-information-listing.html>

Accessibility Features

The Cisco IP Phone 6800 Series Multiplatform Phones provide accessibility features for the blind, and the visually, hearing, and mobility impaired. Because many of these features are standard, they can be used by users with disabilities without requiring any special configuration.

In this document, the term *phone support pages* refers to the web pages that users can access to set up certain features.

Cisco is committed to designing and delivering accessible products and technologies to meet the needs of your organization. You can find more information about Cisco and its commitment to accessibility at this URL: <http://www.cisco.com/go/accessibility>

Cisco IP Phone 6821 Multiplatform Phones Hearing-Impaired Accessibility Features

Your phone comes with standard accessibility features that require little or no setup.

Figure 6: Cisco IP Phone 6821 Multiplatform Phones Hearing-Impaired Accessibility Features



Table 4: Hearing-Impaired Accessibility Features

| Item | Accessibility Feature | Description |
|------|--|---|
| 1 | Visual message-waiting indicator | This lighted strip is visible from all angles. Your phone also provides an audible message-waiting indicator. |
| 2 | Visual notification of the phone state | Use the Mute button to toggle the microphone on or off. When the microphone is muted, the mute icon flashes on the screen |
| 3 | Inline-amplifier support (handset) | Cisco IP Phone handsets support third-party inline amplifiers. You attach an amplifier to the handset and cord and it sits between the handset and the IP phone. |
| 4 | Adjustable ringtone, pitch, and volume | <ul style="list-style-type: none"> • Select Applications > User preferences. • Adjust the volume level for the phone ring. While the handset is in the cradle and the headset and speakerphone buttons are off, press Volume to raise or lower the volume. <p>Your administrator can also change your settings.</p> |
| 5 | Hearing aid compatible (HAC) handset | <p>Supports these accessibility features:</p> <ul style="list-style-type: none"> • Hearing-aid compatible. • Magnetic coupling of the hearing aid. • Federal Communications Commission (FCC) loudness requirements for the Americans with Disabilities Act (ADA). • Section 508 loudness requirements, which are met by using industry-standard inline handset amplifiers. |
| 6 | Acoustic coupled TTY and TDD support (handset) | <p>Cisco IP Phones support these TTY and TDD features:</p> <ul style="list-style-type: none"> • Acoustic or direct connect TTYs from industry-leading manufacturers. • Real-time text transmission over phone lines. • Hearing and voice carry over phones (HCO/VCO). • VoIP network operating at G.711. <p>For information about setting up TTY, contact your administrator.</p> |

Cisco IP Phone 6841, 6851, and 6861 Hearing-Impaired Accessibility Features

Your phone comes with standard accessibility features that require little or no setup.

To check which phone model you have, press **Applications**  and select **Status > Product information**. The **Product name** field shows your phone model.

Figure 7: Hearing-Impaired Accessibility Features—Cisco IP Phone 6841 Multiplatform Phones Shown



Table 5: Hearing-Impaired Accessibility Features

| Item | Accessibility Feature | Description |
|------|--|---|
| 1 | Visual message-waiting indicator (handset) | This lighted strip is visible from all angles. Your phone also provides an audible message-waiting indicator. |
| 2 | Visual notification of the phone state | <ul style="list-style-type: none"> • Toggle the Mute and Speakerphone buttons on and off to indicate the phone state. • Use the Mute button to toggle the microphone on or off. When the microphone is muted, the button is lit. • Use the Speakerphone button to toggle the speakerphone on or off. When the speakerphone is on, the button is lit. |
| 3 | Inline-amplifier support (handset) | Cisco IP Phone handsets support third-party inline amplifiers. You attach an amplifier to the handset and cord and it sits between the handset and the IP phone. |

| Item | Accessibility Feature | Description |
|------|--|---|
| 4 | Adjustable ringtone, pitch, and volume | <ul style="list-style-type: none"> • Select Applications > User preferences. • Adjust the volume level for the phone ring. While the handset is in the cradle and the headset and speakerphone buttons are off, press Volume to raise or lower the volume. <p>Your administrator can also change your settings.</p> |
| 5 | Hearing aid compatible (HAC) handset | <p>Supports these accessibility features:</p> <ul style="list-style-type: none"> • Hearing-aid compatible. • Magnetic coupling of the hearing aid. • Federal Communications Commission (FCC) loudness requirements for the Americans with Disabilities Act (ADA). • Section 508 loudness requirements, which are met by using industry-standard inline handset amplifiers. |
| 6 | Acoustic coupled TTY and TDD support (handset) | <p>Cisco IP Phones support these TTY and TDD features:</p> <ul style="list-style-type: none"> • Acoustic or direct connect TTYs from industry-leading manufacturers. • Real-time text transmission over phone lines. • Hearing and voice carry over phones (HCO/VCO). • VoIP network operating at G.711. <p>For information about setting up TTY, contact your administrator.</p> |

Cisco IP Phone 6871 Multiplatform Phones Hearing-Impaired Accessibility Features

Your phone comes with standard accessibility features that require little or no setup.

To check which phone model you have, press **Applications**  and select **Status > Product information**. The **Product name** field shows your phone model.

Figure 8: Cisco IP Phone 6871 Multiplatform Phones Hearing-Impaired Accessibility Features



Table 6: Hearing-Impaired Accessibility Features

| Item | Accessibility Feature | Description |
|------|--|---|
| 1 | Visual message-waiting indicator (handset) | This lighted strip is visible from all angles. Your phone also provides an audible message-waiting indicator. |
| 2 | Visual notification of the phone state | <ul style="list-style-type: none"> • Toggle the Mute and Speakerphone buttons on and off to indicate the phone state. • Use the Mute button to toggle the microphone on or off. When the microphone is muted, the button is lit. • Use the Speakerphone button to toggle the speakerphone on or off. When the speakerphone is on, the button is lit. |
| 3 | Inline-amplifier support (handset) | Cisco IP Phone handsets support third-party inline amplifiers. You attach an amplifier to the handset and cord and it sits between the handset and the IP phone. |

| Item | Accessibility Feature | Description |
|------|--|---|
| 4 | Adjustable ringtone, pitch, and volume | <ul style="list-style-type: none"> • Select Applications > User preferences. • Adjust the volume level for the phone ring. While the handset is in the cradle and the headset and speakerphone buttons are off, press Volume to raise or lower the volume. <p>Your administrator can also change your settings.</p> |
| 5 | Hearing aid compatible (HAC) handset | <p>Supports these accessibility features:</p> <ul style="list-style-type: none"> • Hearing-aid compatible. • Magnetic coupling of the hearing aid. • Federal Communications Commission (FCC) loudness requirements for the Americans with Disabilities Act (ADA). • Section 508 loudness requirements, which are met by using industry-standard inline handset amplifiers. |
| 6 | Acoustic coupled TTY and TDD support (handset) | <p>Cisco IP Phones support these TTY and TDD features:</p> <ul style="list-style-type: none"> • Acoustic or direct connect TTYs from industry-leading manufacturers. • Real-time text transmission over phone lines. • Hearing and voice carry over phones (HCO/VCO). • VoIP network operating at G.711. <p>For information about setting up TTY, contact your administrator.</p> |





Cisco IP Phone 6821 Multiplatform Phones Vision-Impaired and Blind Accessibility Features

Your phone comes with standard accessibility features that require little or no setup.

Figure 9: Cisco IP Phone 6821 Multiplatform Phones



Table 7: Vision-Impaired and Blind Accessibility Features

| Item | Accessibility Feature | Description |
|------|---|---|
| 1 | High-contrast visual and audible alert of an incoming call | Alerts you to an incoming call. The light strip flashes during incoming calls and stays lit when a voicemail message is received. |
| 2 | Line and feature buttons The line and feature buttons are on the left of the screen. | <p>Use line buttons to start, answer, or switch to a call on a particular line.</p> <p>Features, such as speed dial, line status, privacy, do not disturb (DND), and service URLs, can be assigned to feature buttons.</p> <p>Your administrator sets up programmable feature buttons on your phone.</p> <p>Colors indicate your phone's status:</p> <ul style="list-style-type: none"> •  Green—Line is idle. •  Red, steady—Line is active or in use. •  Red, flashing—Line is on hold or there is an inbound call. •  Amber, steady—Line is unregistered (cannot be used). |

| Item | Accessibility Feature | Description |
|------|---|---|
| 3 | Back-lit grayscale LCD screen with adjustable contrast | Allows you to adjust your phone screen's contrast. |
| 4 | Softkeys These are large buttons just below the LCD. | Provide access to special functions. The functions are displayed on the LCD. |
| 5 | Navigation Cluster (includes the Navigation buttons and the Select button) The Navigation cluster is located in the center of the phone below the softkeys. | Use the Navigation up and down buttons to move up and down in the phone LCD. The Select button is in the center of the Navigation cluster. |
| 6 | Applications and Headset button <ul style="list-style-type: none"> • These two large buttons are located on either side of the Navigation cluster. • The Applications button is on the left. • The Headset button is on the right. | Use the Applications to access functions on your phone. Use the Headset button to toggle the headset on or off. |
| 7 | Standard 12-key layout | Allows you to use existing or familiar key positions. Key 5 has a nib. |
| 8 | <ul style="list-style-type: none"> • The Mute and Speakerphone buttons are located on either side of the volume button. • The Mute button is on the left and the Speakerphone button is on the right. | Provide audible notification of the phone state: <ul style="list-style-type: none"> • Toggle the Mute, and Speakerphone buttons on and off to indicate the phone state. • Use the Mute button to toggle the microphone on or off. When the microphone is muted, the mute icon flashes on the screen. When you turn on Mute, your phone beeps once; when you turn off Mute, your phone beeps twice. • Use the Speakerphone button to toggle the speakerphone on or off. |
| 9 | Volume key This key is located below the keypad. | Allows you to increase or decrease the ring volume or the sound through the handset, headset, or speakerphone. Press right on the rocker key to increase the volume. Press left on the rocker key to decrease the volume. |

Cisco IP Phone 6841, 6851, and 6861 Vision-Impaired and Blind Accessibility Features

Your phone comes with standard accessibility features that require little or no setup.





To check which phone model you have, press **Applications**  and select **Status > Product information**. The **Product name** field shows your phone model.

Figure 10: Vision-Impaired and Blind Accessibility Features—Cisco IP Phone 6841 Multiplatform Phones Shown



Table 8: Vision-Impaired and Blind Accessibility Features

| Item | Accessibility Feature | Description |
|------|--|---|
| 1 | High-contrast visual and audible alert of an incoming call | Alerts you to an incoming call. The handset light strip flashes during incoming calls and stays lit when a voicemail message is received. |

| Item | Accessibility Feature | Description |
|------|---|---|
| 2 | <p>Line and feature buttons</p> <p>The line and feature buttons are on the left and right sides of the screen.</p> | <p>Use line buttons to start, answer, or switch to a call on a particular line.</p> <p>Features, such as speed dial, line status, privacy, do not disturb (DND), and service URLs, can be assigned to feature buttons.</p> <p>Your administrator sets up programmable feature buttons on your phone.</p> <p>Colors indicate your phone's status:</p> <ul style="list-style-type: none"> •  Green—Line is idle. •  Red, steady—Line is active or in use. •  Red, flashing—Line is on hold or there is an inbound call. •  Amber, steady—Line is unregistered (cannot be used). |
| 3 | <p>Back-lit grayscale LCD screen with adjustable contrast</p> | <p>Allows you to adjust your phone screen's contrast.</p> |
| 4 | <p>Softkeys</p> <ul style="list-style-type: none"> • These are large buttons just below the LCD. | <p>Provide access to special functions. The functions are displayed on the LCD.</p> |
| 5 | <p>Navigation Cluster (includes the Navigation ring and the Select button)</p> <p>The Navigation cluster is located in the center of the phone.</p> | <p>Use the Navigation ring to move up and down in the phone LCD. The Select button is in the center of the Navigation cluster.</p> |
| 6 | <p>Hold button, Transfer button, and Conference button</p> <ul style="list-style-type: none"> • These three large buttons are located to the right of Navigation cluster. • In this group of buttons, the Hold button is the single button in the top row. Below the Hold button, the Transfer button is on the left, and the Conference button is on the right. | <p>Allow you to use these functions on your phone.</p> |

| Item | Accessibility Feature | Description |
|------|--|---|
| 7 | <p>Messages button, Applications button, and Contacts button</p> <ul style="list-style-type: none"> • These three large buttons are located to the left of the Navigation cluster. • In this group of buttons, the Messages button is the single button in the top row. Below the Messages button, the Applications button is on the left, and the Contacts button is on the right. | Allow you to easily access your messages, applications, and contacts. |
| 8 | <p>Volume key</p> <p>This key is located to the left of the keypad.</p> | <p>Allows you to increase or decrease the ring volume or the sound through the handset, headset, or speakerphone.</p> <p>Press up on the rocker key to increase the volume. Press down on the rocker key to decrease the volume.</p> |
| 9 | Standard 12-key layout | Allows you to use existing or familiar key positions. Key 5 has a nib. |
| 10 | <ul style="list-style-type: none"> • Headset, Speakerphone, and Mute buttons located to the right of the keypad. • The Speakerphone button is on the top, the Headset button is in the middle, and the Mute button is on the bottom. | <p>Provide audible notification of the phone state:</p> <ul style="list-style-type: none"> • Toggle the Headset, Mute, and Speakerphone buttons on and off to indicate the phone state. • Use the Headset button to toggle the headset on or off. When the headset is on, the button is lit. • Use the Mute button to toggle the microphone on or off. When the microphone is muted, the button is lit. When you turn on Mute, your phone beeps once; when you turn off Mute, your phone beeps twice. • Use the Speakerphone button to toggle the speakerphone on or off. When the speakerphone is on, the button is lit. |

Cisco IP Phone 6871 Multiplatform Phones Vision-Impaired Accessibility Features

Your phone comes with standard accessibility features that require little or no setup.





To check which phone model you have, press **Applications**  and select **Status > Product information**. The **Product name** field shows your phone model.

Figure 11: Cisco IP Phone 6871 Multiplatform Phones Vision-Impaired and Blind Accessibility Features



Table 9: Vision-Impaired and Blind Accessibility Features

| Item | Accessibility Feature | Description |
|------|--|---|
| 1 | High-contrast visual and audible alert of an incoming call | Alerts you to an incoming call. The handset light strip flashes during incoming calls and stays lit when a voicemail message is received. |

| Item | Accessibility Feature | Description |
|------|---|---|
| 2 | <p>Line and feature buttons</p> <p>The line and feature buttons are on the left and right sides of the screen.</p> | <p>Use line buttons to start, answer, or switch to a call on a particular line.</p> <p>Features, such as speed dial, line status, privacy, do not disturb (DND), and service URLs, can be assigned to feature buttons.</p> <p>Your administrator sets up programmable feature buttons on your phone.</p> <p>Colors indicate your phone's status:</p> <ul style="list-style-type: none"> •  Green—Line is idle. •  Red, steady—Line is active or in use. •  Red, flashing—Line is on hold or there is an inbound call. •  Amber, steady—Line is unregistered (cannot be used). |
| 3 | <p>Back-lit color LCD screen with adjustable brightness</p> | <p>Allows you to adjust your phone screen's brightness.</p> |
| 4 | <p>Softkeys</p> <ul style="list-style-type: none"> • These are large buttons just below the LCD. | <p>Provide access to special functions. The functions are displayed on the LCD.</p> |
| 5 | <p>Navigation Cluster (includes the Navigation ring and the Select button)</p> <p>The Navigation cluster is located in the center of the phone.</p> | <p>Use the Navigation ring to move up and down in the phone LCD. The Select button is in the center of the Navigation cluster.</p> |
| 6 | <p>Hold button, Transfer button, and Conference button</p> <ul style="list-style-type: none"> • These three large buttons are located to the right of Navigation cluster. • In this group of buttons, the Hold button is the single button in the top row. Below the Hold button, the Transfer button is on the left, and the Conference button is on the right. | <p>Allow you to use these functions on your phone.</p> |

| Item | Accessibility Feature | Description |
|------|--|---|
| 7 | <p>Messages button, Applications button, and Contacts button</p> <ul style="list-style-type: none"> • These three large buttons are located to the left of the Navigation cluster. • In this group of buttons, the Messages button is the single button in the top row. Below the Messages button, the Applications button is on the left, and the Contacts button is on the right. | Allow you to easily access your messages, applications, and contacts. |
| 8 | <p>Volume key</p> <p>This key is located to the left of the keypad.</p> | <p>Allows you to increase or decrease the ring volume or the sound through the handset, headset, or speakerphone.</p> <p>Press up on the rocker key to increase the volume. Press down on the rocker key to decrease the volume.</p> |
| 9 | Standard 12-key layout | Allows you to use existing or familiar key positions. Key 5 has a nib. |
| 10 | <p>Headset button, Speakerphone button, and Mute button</p> <ul style="list-style-type: none"> • These three large buttons are located to the right of the keypad. • The Speakerphone button is on the top, the Headset button is in the middle, and the Mute button is on the bottom. | <p>Provide audible notification of the phone state:</p> <ul style="list-style-type: none"> • Toggle the Headset, Mute, and Speakerphone buttons on and off to indicate the phone state. • Use the Headset button to toggle the headset on or off. When the headset is on, the button is lit. • Use the Mute button to toggle the microphone on or off. When the microphone is muted, the button is lit. When you turn on Mute, your phone beeps once; when you turn off Mute, your phone beeps twice. • Use the Speakerphone button to toggle the speakerphone on or off. When the speakerphone is on, the button is lit. |





Cisco IP Phone 6821 Multiplatform Phones Mobility-Impaired Accessibility Features

Your phone comes with standard accessibility features that require little or no setup.

Figure 12: Cisco IP Phone 6821 Multiplatform Phones Mobility-Impaired Accessibility Features



Table 10: Mobility-Impaired Accessibility Features

| Item | Accessibility Feature | Description |
|------|--|---|
| 1 | Lighted buttons | <p>Allow you to access the following features:</p> <ul style="list-style-type: none"> • Phone lines and intercom lines (line buttons) • Speed-dial numbers (speed-dial buttons, including the speed-dial line status feature) • Web-based services, such as a personal address book • Phone features, such as privacy <p>Indicate your phone's status:</p> <ul style="list-style-type: none"> •  Green—Line is idle. •  Red, steady—Line is active or in use. •  Red, flashing—Line is on hold or there is an inbound call. •  Amber, steady—Line is unregistered (cannot be used). |
| 2 | Large button to access Applications | Allow you to easily access your phone applications. Additional features are available with the softkeys. |
| 3 | Built-in speakerphone | Press the button to turn speakerphone on or off. |

| Item | Accessibility Feature | Description |
|------|---|--|
| 4 | Tactile-discernible buttons and functions, including a nib on Key 5 | Allow you to easily locate your phone's keys. For example, Key 5 has a nib, which you can use to locate other key positions. |

Cisco IP Phone 6841, 6851, and 6861 Mobility-Impaired Accessibility Features





Your phone comes with standard accessibility features that require little or no setup.

To check which phone model you have, press **Applications**  and select **Status > Product information**. The **Product name** field shows your phone model.

Figure 13: Mobility-Impaired Accessibility Features—Cisco IP Phone 6841 Multiplatform Phones Shown



Table 11: Mobility-Impaired Accessibility Features

| Item | Accessibility Feature | Description |
|------|---|---|
| 1 | Lighted buttons | <p>Allow you to access the following features:</p> <ul style="list-style-type: none"> • Phone lines and intercom lines (line buttons) • Speed-dial numbers (speed-dial buttons, including the speed-dial line status feature) • Web-based services, such as a personal address book • Phone features, such as privacy <p>Indicate your phone's status:</p> <ul style="list-style-type: none"> •  Green—Line is idle. •  Red, steady—Line is active or in use. •  Red, flashing—Line is on hold or there is an inbound call. •  Amber, steady—Line is unregistered (cannot be used). |
| 2 | Large buttons to access Applications, Messages, Contacts, Hold, Transfer, and Conference | Allow you to easily access your phone applications, voice messages, corporate and personal directories, and calling features. |
| 3 | Built-in speakerphone | Indicates whether the speakerphone is on or off. When the speakerphone is on, the button is lit. |
| 4 | Tactile-discernible buttons and functions, including a nib on Key 5 | Allow you to easily locate your phone's keys. For example, Key 5 has a nib, which you can use to locate other key positions. |

Cisco IP Phone 6871 Multiplatform Phones Mobility-Impaired Accessibility Features





Your phone comes with standard accessibility features that require little or no setup.

To check which phone model you have, press **Applications**  and select **Status > Product information**. The **Product name** field shows your phone model.

Figure 14: Cisco IP Phone 6871 Multiplatform Phones Mobility-Impaired Accessibility Features



Table 12: Mobility-Impaired Accessibility Features

| Item | Accessibility Feature | Description |
|------|-----------------------|---|
| 1 | Lighted buttons | <p>Allow you to access the following features:</p> <ul style="list-style-type: none"> • Phone lines and intercom lines (line buttons) • Speed-dial numbers (speed-dial buttons, including the speed-dial line status feature) • Web-based services, such as a personal address book • Phone features, such as privacy <p>Indicate your phone's status:</p> <ul style="list-style-type: none"> •  Green—Line is idle. •  Red, steady—Line is active or in use. •  Red, flashing—Line is on hold or there is an inbound call. •  Amber, steady—Line is unregistered (cannot be used). |

| Item | Accessibility Feature | Description |
|------|---|---|
| 2 | Large buttons to access Applications, Messages, Contacts, Hold, Transfer, and Conference | Allow you to easily access your phone applications, voice messages, corporate and personal directories, and calling features. |
| 3 | Built-in speakerphone | Indicates whether the speakerphone is on or off. When the speakerphone is on, the button is lit. |
| 4 | Tactile-discernible buttons and functions, including a nib on Key 5 | Allow you to easily locate your phone's keys. For example, Key 5 has a nib, which you can use to locate other key positions. |

Third-Party Accessibility Applications

Cisco works closely with partners to provide solutions that complement the accessibility and usability of Cisco products and solutions. There are third-party applications such as real-time captioning on Cisco IP Phones, Text Telephones for the Deaf (TDD/TTY), Real Time Text (RTT), hearing/voice carry over (HCO/VCO), audible caller ID, inline amplifiers for handsets for louder call sound, “busy lights”, audio/visual emergency notifications through Cisco IP Phones (supporting users with disabilities), etc.

For more information about third-party applications, contact your administrator.

Troubleshooting

You may experience issues related to the following scenarios:

- Your phone cannot communicate with the call control system.
- The call control system has communication or internal problems.
- Your phone has internal problems.

If you experience problems, your administrator can help troubleshoot the root cause of the problem.

Find Information About Your Phone

Your administrator may ask for information about your phone. This information uniquely identifies the phone for troubleshooting purposes.

The phone contains all unique device identifier (UDI) information. The UDI is composed of three data elements associated with the phone. The data elements are:

- Product Identifier (PID)
- Version Identifier (VID)
- Serial Number (SN)

You can also find the information about your phone by going to **Info > Status > Product Information** on the phone web interface.

Procedure

Step 1 Press **Applications** .

Step 2 Select **Status > Product Information**.

You can view the following information:

Product name— Name that represents the Cisco IP Phone.

Serial number— Serial number of the Cisco IP Phone.

MAC address—Hardware address of the Cisco IP Phone.

Software version—Version number of the Cisco IP Phone firmware.

Configuration version—Version number of the Cisco IP Phone configuration. This information shows when your administrator has enabled it.

Hardware version—Version number of the Cisco IP Phone hardware.

VID—Version ID of the Cisco IP Phone.

Certificate—Status of the client certificate, which authenticates the Cisco IP Phone for use in the ITSP network. This field indicates if the client certificate is properly installed in the phone.

Customization—For an RC unit, this field indicates whether the unit has been customized or not. Pending indicates a new RC unit that is ready for provisioning. If the unit has already retrieved its customized profile, this field displays the Customization state as Acquired.

Step 3 Press **Back** to return to the Applications screen.

View the Customization State on the Phone

After the RC download from the EDOS server completes, you can view the customization state of a phone on the screen.

Here are the descriptions of the remote customization states:

- **Open**—The phone has booted for the first time and is not configured.
- **Aborted**—Remote Customization is aborted due to other provisioning, for example, DHCP options.
- **Pending**—The phone can not download the profile from the EDOS server.
- **Custom-Pending**—The phone has downloaded a redirect URL from the EDOS server.
- **Acquired**—In the profile downloaded from the EDOS server, there is a redirect URL for provision configuration. If the redirect URL download from the provisioning server is successful, this state is displayed.
- **Unavailable**—Remote customization has stopped because the EDOS server responded with an empty provisioning file and the HTTP response was 200 OK.

Procedure

- Step 1** Press **Applications** .
- Step 2** Select **Status > Product information > Customization**.
- Step 3** Press **Back**.
-

View the Network Status

Procedure

- Step 1** Press **Applications** .
- Step 2** Select **Status > Network status**.

You can view the following information:

- **Network type**—Indicates the type of Local Area Network (LAN) connection that the phone uses.
 - **Network status**—Indicates if the phone is connected to a network.
 - **IPv4 status**—IP address of the phone. You can see information on IP address, Addressing type, IP status, Subnet mask, Default router, Domain Name Server (DNS) 1, DNS 2 of the phone.
 - **IPv6 status**—IP address of the phone. You can see information on IP address, Addressing type, IP status, Subnet mask, Default router, Domain Name Server (DNS) 1, DNS 2 of the phone.
 - **VLAN ID**—VLAN ID of the phone.
 - **MAC address**—Unique Media Access Control (MAC) address of the phone.
 - **Host name**—Displays the current host name assigned to the phone.
 - **Domain**—Displays the network domain name of the phone. Default: cisco.com
 - **Switch port link**—Status of the switch port.
 - **Switch port config**—Indicates speed and duplex of the network port.
 - **PC port config**—Indicates speed and duplex of the PC port.
 - **PC port link**—Indicates speed and duplex of the PC port.
-

View the Phone Status

Procedure

- Step 1** Press **Applications** .
- Step 2** Select **Status > Phone status > Phone status**.

You can view the following information:

- **Elapsed time**—Total time elapsed since the last reboot of the system
 - **Tx (Packets)**—Transmitted packets from the phone.
 - **Rx (Packets)**—Received packets from the phone.
-

View the Status Messages on the Phone

Procedure

Step 1 Press **Applications** .

Step 2 Select **Status** > **Status messages**.

You can view a log of the various phone statuses since provisioning was last done.

Note Status messages reflect UTC time and are not affected by the timezone settings on the phone.

Step 3 Press **Back**.

View the Line Status

Procedure

Step 1 Press **Applications** .

Step 2 Select **Status** > **Phone status** > **Line status**.

You can view the status of each line on the phone.

View Call Records in Call Statistics

Each call record contains additional information that you might want to check, follow the procedure provided in this topic to view the detailed information of your recent call records.

Before you begin

Sign in to the phone so you can access to access the **Call statistics** menu.

If a lock icon displays in the upper-right corner of the main screen, this means that you don't sign in to the phone yet.

Procedure

- Step 1** Press **Applications** .
- Step 2** Select **Status > Phone status > Call statistics**.
- Step 3** (Optional) If prompted, enter your password and press **Sign in**.
If you cannot sign in to the phone, contact your administrator.
- Step 4** Highlight a call statistics entry from the list, and press **Select**.
You can also press the **Select** button of the Navigation cluster to show details of the highlighted entry.
You can view the following information:
- **Call type**—An outbound or inbound call.
 - **Peer name**—The name of the person who made or answered the call.
 - **Peer phone**—The phone number of the person who made or answered the call.
 - **Encode codec**—The method used to compress the outgoing audio.
 - **Decode codec**—The method used to decompress the incoming audio.
 - **Call time**—The time a call was made or answered.
 - **Call ID**—An identifier of the caller.

The call statistics may contain additional information such as counter, statistics, and voice-quality metrics. Use this information for troubleshooting.

Related Topics

- [Sign into Your Extension from Another Phone \(Extension Mobility\)](#), on page 19
- [Sign in to a Phone as a Guest](#), on page 20
- [Sign In as a Call Center Agent](#), on page 84
- [Set up the Profile Account](#), on page 164
- [Set Password](#), on page 163

View 802.1X Transaction Status

Procedure

- Step 1** Press **Applications** .
- Step 2** Select **Network configuration > Ethernet configuration > 802.1X authentication > Transaction status**.
You can view the following information:
- **Transaction status**

- Protocol
-

View the Reboot History

Procedure

- Step 1** Press **Applications** .
- Step 2** Select **Status** > **Reboot history**.

You can view the details of the date and time whenever the phone has rebooted, no matter why the phone rebooted.

Report all phone issues for your Cisco MPP device

You can use the Problem Reporting Tool (PRT) to collect and send phone logs, and to report problems to your administrator.

Before you begin

Your administrator enables web server for the phone.

Procedure

- Step 1** Press **Applications** .
- Step 2** Select **Status** > **Report problem**.
- Step 3** Enter the date that you experienced the problem in the **Date of problem** field. The current date appears in this field by default.
- Step 4** Enter the time that you experienced the problem in the **Time of problem** field. The current time appears in this field by default.
- Step 5** Select **Problem description**.
- Step 6** Select a description from the displayed list.
- Step 7** Press **Submit**.

Note If your administrator disables web server for the phone, the phone fails to upload the problem report to the server. In addition, the phone screen shows `Error: 109 OR Report Problem together` with an unavailable download link. Contact your administrator to help you resolve the issue.

View Wi-Fi Status Messages on the Phone

You can view messages about the Wi-Fi connection status of your phone. The messages can help you diagnose Wi-Fi connection problems. The messages contain:

- connection time and MAC address of the AP
- disconnection time and diagnostic code
- connection failure time
- time that weak signal of the AP continues over 12 seconds
- the status of firmware memory when the free memory is less than 50K
- the status of losing AP beacon when the phone can't receive signal from the AP
- the status of no response for Wi-Fi authentication or association requests
- the status of TX failure
- the status of WPS connection failure

Procedure

- Step 1** Press **Applications** .
- Step 2** Select **Status > Wi-Fi messages**.
- Step 3** Use the outer ring of the navigation cluster to scroll through the messages.
- Step 4** Press **Details** to view more details of the selected message.
- Step 5** (Optional) Press **Clear** to delete all the messages.
-

Factory Reset the Phone from Phone Web Page

You can restore your phone to its original manufacturer settings from the phone web page. After you reset the phone, you can reconfigure it.

Procedure

Enter the URL in a supported web browser and click **Confirm Factory Reset**

Factory Reset from Server

You can restore your phone to its original manufacturer settings when your administrator factory reset it from the server. After you reset the phone, you can reconfigure it.

When your administrator factory reset your phone, you will observe the following notifications on the phone screen.

- If the phone is idle and has no active call or the phone is not upgrading, it shows a message, **Factory resetting as per request from administrator**, then the phone reboots to complete the factory reset.
- If the phone is busy with an active call or the phone is upgrading, it shows a message, **Phone will factory reset when idle as per request from administrator**. After the phone becomes idle, it shows **Factory resetting as per request from administrator**, then the phone reboots to complete the factory reset.

Identify Phone Issues with a URL in the Phone Web Page

When the phone doesn't work or doesn't register, a network error or any misconfiguration might be the cause. To identify the cause, add a specific IP address or a domain name to the phone admin page. Then, try to access so that the phone can ping the destination and display the cause.

Procedure

In a supported web browser, enter a URL that consists of your phone IP address and the destination IP that you want to ping. Enter the URL using the format:

`http://<Phone IP>/admin/ping?<ping destination>`, where:

`<Phone IP>` = actual IP address of your phone.

`/admin` = path to the access admin page of your phone.

`<ping destination>` = any IP address or domain name that you want to ping.

The ping destination allows only alphanumeric characters, '-', and '_' (underscores). Otherwise the phone shows an error on the web page. If the `<ping destination>` includes spaces, the phone uses only the first part of the address as the pinging destination.

For example, to ping the 192.168.1.1 address:

`http://<Phone IP>/admin/ping?192.168.1.1`

Lost Phone Connectivity

Sometimes your phone loses its connection to the phone network. When this connection is lost, your phone displays a message.

If you are on an active call when the connection is lost, the call continues. But, you don't have access to all normal phone features because some functions require information from the call control system. For example, your softkeys might not work as you expect.

When the phone reconnects to the call control system, you'll be able to use your phone normally again.

For more information on phone registration, please visit [Manual phone registration](#).

Get More Information When Your Phone Displays a Provisioning Failure Message

If your phone displays the message `Verify your provisioning settings or contact your service provider.`, you have a configuration problem. This message will display only immediately after the phone boots up. You will not see this message after the phone is registered to a call server.

This message applies to all MPP Phones.

Procedure

Step 1 Press one of these options:

- **Details**—display a list of status messages.

- **Cancel**—return to the main phone screen.

Note If you cancel a provisioning alert, the phone doesn't show another provisioning alert until the phone has rebooted.

Step 2 Highlight the relevant status message from the list, and press one of these options:

- **Details**—display the entire status message.
- **Clear**—delete the complete message list.

Step 3 Contact your administrator to help you resolve the issue. If your administrator has given you access, you can also view the messages on the phone web page.

On the phone web page, go to **Info > Download Status > Provisioning Status**

Find Information about MIC Cert Refresh Status

You can view the renewal status and related information on the phone web page to check if the Manufacture Installed Certificate (MIC) renewal is completed. Your administrator might ask you about this information during the phone troubleshooting.

Before you begin

- Your administrator has given you the access to the phone web page.
- Your administrator activates the Manufacture Installed Certificate (MIC) renewal on your phone.

Procedure

Step 1 On the phone web page, click **Info > Download Status**.

Step 2 Find the information from the **MIC Cert Refresh Status** section.

- **MIC Cert Provisioning Status:** This field includes the date and time of the performed certificate renewal, the HTTP request URL, and result messages.
- **MIC Cert Info:** This field shows the overall status of the certificate renewal procedure. Typically, it shows whether the MIC certificate of your phone is renewed successfully.

For more information, contact your administrator.

Cisco One-Year Limited Hardware Warranty Terms

Special terms apply to your hardware warranty and services that you can use during the warranty period.

Your formal Warranty Statement, including the warranties and license agreements applicable to Cisco software, is available at: [Product Warranties](#).



CHAPTER 2

Calls

- [Make calls, on page 63](#)
- [Answer Calls, on page 68](#)
- [Mute Your Call, on page 70](#)
- [Hold Calls, on page 71](#)
- [Forward Calls, on page 74](#)
- [Transfer Calls, on page 77](#)
- [Conference Calls and Meetings, on page 78](#)
- [Page a Group of Phones \(Multicast Paging\), on page 80](#)
- [XML Application and Multicast Paging, on page 80](#)
- [View XML Application Details, on page 81](#)
- [Multiple Lines, on page 81](#)
- [Record a Call, on page 83](#)
- [Call Center Features, on page 83](#)
- [Executive Calls, on page 87](#)
- [Executive Assistant Calls, on page 88](#)

Make calls

Your phone works just like a regular phone. But we make it easier for you to make calls.

Related Topics

[Make a Call to an IM and Presence Contact, on page 108](#)

Make a call

Use your phone just like any other phone to make a call.

Your administrator configures to support only one call per line. If configured, you make a call to this line, you hear a busy tone if the line has an active call or a held call.

Procedure

Enter a number and pick up the handset.

Make a call with the speakerphone

Use your speakerphone for hands-free calling. Keep in mind that your coworkers might be able to hear your call too.

Procedure

Step 1 Enter a number using the keypad.

Step 2 Press **Speakerphone** .

Make a call with a headset

Use your headset for hands-free calling that won't disturb your coworker and gives you some privacy.

Procedure

Step 1 Plug in a headset.

Step 2 Enter a number using the keypad.

Step 3 Press **Headset** .

Redial a number

You can call the most recently dialed phone number.

Procedure

Step 1 (Optional) Select a line.

Step 2 Press **Redial**.

Note For Webex Calling, workspaces support Redial when **Local Call** history is set to the workspace devices or by using FAC *66.

Step 3 Select the call record from the **Placed calls** list and press **Call**.

You can also access the **Placed calls** list from **Information and settings > Recents > Placed calls**.

Make an Emergency Call

Use your phone to make an emergency call, similar to any other call. When you dial the emergency number, your emergency services get your phone number and location so that they can assist you.



Note If your call disconnects, the emergency services can call you back.

Before you begin

Your phone must be set up to obtain your physical location. Emergency services personnel need your location to find you when you make an emergency call.

Procedure

Enter the emergency number and lift the handset.

Speed Dial

Speed Dial allows you to press a button, enter a preset code, or select a phone screen item to place a call. You can configure the speed dial from the phone screen and also from the phone web page.

You can edit, delete, and validate a speed-dial code.

Related Topics

[Phone Web Page](#), on page 25

[Speed dial numbers](#), on page 26

Assign a speed-dial code from the phone screen

You can configure a speed-dial index from your phone screen. You can also assign a speed-dial code from the phone web page.

Procedure

- Step 1** Press **Applications** .
- Step 2** Select **Speed dials**.
- Step 3** Scroll to an unassigned speed-dial index.
- Step 4** Press **Edit** and do one of the following:
- Enter the name and number.

- Select **Option** > **Select from contact** to select a contact from the address book.

Step 5 Press **Save**.

Make a call with a speed-dial code

Before you begin

Set up speed-dial codes on the phone web page or from your phone screen.

Procedure

Enter the speed-dial code and press **Call**.

Configure a speed-dial on a line key

You can press any idle line key on your phone and set up speed dial on it. The speed-dial icon, the name, and the extension number are displayed on your phone screen next to the line key. You can also verify this change by checking the **Extended Function** field on the web page. After you configure the speed dial on a line key, you can press the line key to modify the speed-dial information and assign a new phone number and name. You can press the line key that has speed-dial configured to speed dial a number.

You can configure your key expansion module line key as a speed dial key and you can press that line key to speed dial a number. Your administrator configures the key expansion module line key as a speed dial key from the phone web page.

Before you begin

Go to the web page and disable the line key that will become the speed dial key.

Procedure

Step 1 Press any idle line key on your phone for at least two seconds.

Step 2 In the **Speed-Dial** window, add the speed-dial name and phone number to call when you press this line key.

Step 3 Click **Save**.

Remove a speed-dial from a line key

You can press a line key on your phone and delete speed dial assigned to it. The speed dial on the line key is removed. Check the phone web page to confirm that the speed dial is removed.

Procedure

Step 1 Press a line key that has a speed dial configured for at least two seconds.

- Step 2** Press **Option** > **Delete** in the **Speed-Dial** window on the phone screen.
- Step 3** Select **None** and confirm with **OK**
-

Use the Line in Focus for Speed-Dial Calls

You can configure a line key to perform a speed dial either with a Voice Profile ID (VID) or without a VID. When both are configured, VID has a higher priority. The call is routed to that line.

If a line key is configured without VID, you can configure a speed-dial key to use the line in focus.

Procedure

- Step 1** Configure a speed-dial key without using VID.
- Step 2** Change the focus to the line that you prefer.
- Step 3** Press the speed-dial key to make a call.

The call is made with the line in focus.

If the existing number of calls on the line in focus is equal to the value set in the **Call Appearances Per Line** field in the phone web page, the speed-dial call is made from the next available line.

Use the Line in Focus to Check Speed-Dial Calls

If a line key is configured without VID, you can perform a check to confirm whether the call is made with the line in focus.

Procedure

- Step 1** Configure a speed-dial key without using VID.
- Step 2** Change the focus to the line that you prefer.
- Step 3** Press the speed-dial key to make a call.

The call is made with the line in focus.

Dial an international number

You can dial international calls when you prefix the phone number with a plus (+) sign.

Procedure

- Step 1** Press and hold **star** (*) for at least 1 second.
- The plus (+) sign is displayed as the first digit in the phone number.

- Step 2** Enter the phone number.
- Step 3** Press **Call** or wait 10 seconds after the last key press to automatically place the call.
-

Secure calls

Your phone encrypts all calls to protect the calls. The lock icon displays on the phone screen for all secure calls.

You can also set a password on your phone to restrict unauthorized access.

Answer Calls

Your Cisco IP Phone works just like a regular phone. But we make it easier for you to answer calls.

Answer a Call

Procedure

Press the flashing red line button.

Answer Call Waiting

When you're on an active call, you know that a call is waiting when you hear a single beep and the line button flashes red.

Procedure

- Step 1** (Optional) If you have more than one call waiting, select an incoming call.
- Step 2** Press the line button.
-

Decline a Call

You can send an active or ringing call to your voicemail system or to a preset phone number.

Procedure

Decline a call by performing one of the following actions:

- Press **Decline**.

- If you have multiple incoming calls, highlight the incoming call and press **Decline**.
-

Silence an Incoming Call

You can silence an incoming call when you are busy and don't want to be disturbed. The phone stops ringing, but you get a visual alert, and, can answer the phone call.

Before you begin

Your administrator configures the **Ignore** softkey on your phone.

Procedure

Silence the incoming call by any of the methods:

- Press the **Ignore** softkey. When you press this softkey, the softkey disappears from the phone screen, and is restored again during the next incoming call.



- Press the Volume button down. If you press this button again, the ringer volume decreases.

The ringer volume is restored during the next incoming call.

Turn On Do Not Disturb

Use Do Not Disturb (DND) to silence your phone and ignore incoming call notifications when you need to avoid distractions. However, you will always receive paging and emergency calls, even when DND is turned on.

When you enable DND, your incoming calls forward to another number, such as your voicemail, if it is set up.

When DND is turned on, **Do not disturb** is displayed in the top bar of the phone screen.

When you enable DND, by default, it affects all lines on your phone. You can also enable DND on a specific line from the **Preferences** menu.

When a line key has both feature key sync and DND enabled, the DND icon  is displayed next to the line key label.

Procedure

- Step 1** Press **DND** to turn on DND.

- Step 2** Press **Clr DND** to turn off DND.

Related Topics

[Phone Web Page](#), on page 25

[Turn on Do Not Disturb for a Specific Line](#), on page 131

Turn On or Turn Off DND Using a Star Code

You can turn on or turn off the do not disturb feature by dialing the respective star codes that are configured for your phone. The administrator enters the star codes in the **DND Act Code** and **DND Deact Code** fields respectively on the phone web page.

Procedure

- Step 1** To turn on DND, dial the star code provided by your administrator.
- Step 2** To turn off DND, dial the star code provided by your administrator.
-

Answer a Coworker's Phone (Call Pickup)

If you share call handling tasks with your coworkers, you can answer a call that is ringing on a coworker's phone. First, your administrator has to assign you to at least one call pickup group.

Answer a Call Within Your Group (Pickup)

You can answer a call that rings on another phone within your call pickup group. If multiple calls are available for pickup, you'll answer the call that has been ringing for the longest time.

Procedure

- Step 1** (Optional) Press the line button.
- Step 2** Press **PickUp** to transfer an incoming call within your pickup group to your phone.
-

Mute Your Call

While you are on a call, you can mute the audio so that you can hear the other person, but they cannot hear you.

When you mute the Cisco IP Phone 6821 Multiplatform Phones, a mute icon flashes on the screen. When you mute the Cisco IP Phone 6841 and 6851 Multiplatform Phones, the **Mute** button lights red.

Procedure



- Step 1** Press **Mute** .
- Step 2** Press **Mute** again to turn mute off.
-

Hold Calls

Put a Call on Hold

You can put an active call on hold and then resume the call when you're ready.

Procedure

- Step 1** Press **Hold**  or **Hold**.
- Step 2** To resume a call from hold, press **Hold**  or **Resume**.
-

Answer a Call Left on Hold for Too Long

Your phone is configured to provide cues that let you know when you have left a call on hold for too long:

- Flashing red line button
- Flashing message indicator on the handset
- Visual notification on the phone screen
- Ringing notification on the phone if a hold reminder is configured with phone web page

Procedure

Press **Hold**  or **Resume** to resume the held call.

Swap between active and held calls

You can easily switch between active and held calls.

Procedure

Press the line button for the held call, then press **Resume** to resume that call and place the other call on hold automatically.

Call park

You can use your phone to park a call. You can then retrieve the call either from your phone or another phone, such as a phone at a coworker's desk or in a conference room.

A parked call is monitored by your network so you won't forget about it. If the call remains parked for too long, you hear an alert. You can then answer, decline to answer, or ignore the call on your original phone. You can also continue retrieving it from another phone.

If you don't answer the call within a certain length of time, it's routed to voicemail or another destination, as set by your administrator.

Place a call on hold with call park

You can park an active call that you answered on your phone and then use another phone in the call control system to retrieve the call.

You can also park a call on your own phone. If so, then you may not hear a recording.

You can park only one call at the call park number.

Before you begin

Your call must be active.

Procedure

- Step 1** Press **Park**.
Your phone plays a recorded message that asks for the number of the parked call.
 - Step 2** (Optional) If you have call park configured on a key expansion module, press the call park line key.
 - Step 3** Enter the number and press **Pound (#)**.
 - Step 4** (Optional) Communicate the parked number to the person retrieving the call.
-

Retrieve a call on hold with call park

You can pick up a parked call from anywhere in your network.

Before you begin

You need the number that was used to park the call.

Procedure

- Step 1** Press **Unpark**.
- Step 2** (Optional) Press the line key that has busy lamp field with call pickup configured to retrieve a call on hold.
- Step 3** (Optional) If you have call park configured on a key expansion module, press the call park line key.
- Step 4** Enter the number where the call is parked followed by **Pound (#)**.
You can also enter **Pound (#)** to retrieve the parked call. If you retrieve a call parked on your own phone, you may not need to enter a number.
-

Park and Unpark a Call with One Line Key

If your administrator has configured a Busy Lamp Field (line status) list with the **prk** function for you, you can park and unpark active calls. See [Coworker Line Status, on page 21](#) for the `idle` and `Parked` call icons.

This feature doesn't apply to phone Cisco IP Phone 7811.

Before you begin

[Activate or Deactivate Monitoring of the BLF List, on page 22](#)

Procedure

- Step 1** Press the line key that monitors the user to park an active call.
- Step 2** To unpark a call, do one of three things:
- Press the monitored user that displays the parked call.
 - Press the extension line key, then press the monitored user that displays the parked call.
 - Use the navigation button to focus on the extension line key, then press the monitored user that displays the parked call.
-

Call Park Extension and Status

Your administrator can configure call park to support parking calls against dedicated call park extensions. These extensions are used only for call park and are not used for call routing.

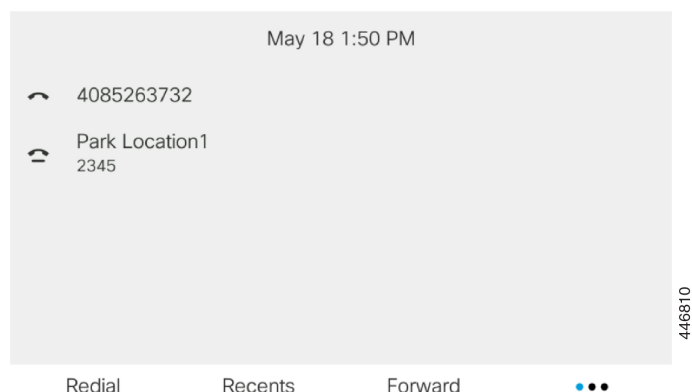
Figure 15: Call Park in Call Park Extensions

In the above example, the phone is monitoring Park Location1. Your administrator has configured a call park extension, Park Location1. If call park extensions are subscribed successfully, line keys will be assigned for call park function and get the monitored extension status.

The following table shows the call park status and the relevant icon displayed next to the call park extension:

Table 13: Call Park Status and Icons

| Status | Icon |
|--------|------|
| Idle | |
| Parked | |

Forward Calls

You can forward calls from any line on your phone to another number. Call forward is phone-line specific. If a call reaches you on a line where call forward is not enabled, the call rings as usual.

If a line is enabled with feature key sync and call forward on it, the call forward icon is displayed next to the line key label.

There are three Call Forward services:

- Call Forward All—Forward all incoming calls to a target phone number.
- Call Forward Busy—Forward an incoming call to a target phone number when the line is busy.
- Call Forward No Answer—Forward an incoming call to a target phone number when the call isn't answered.

You can set up the call forward service or services by a specific softkey.

Procedure

- Step 1** Press **Forward** or **Forward all**.
- If **Forward all** displays, you can only set up the Call Forward All service (not including Call Forward Busy and Call Forward No Answer services). After you press the softkey, the menu for only setting up the Call Forward All service displays, skip to the [Step 3](#).
- If you want to set up the Call Forward Busy and Call Forward No Answer services, see [Forward Calls from Your Phone, on page 128](#) or [Forward Calls with the Phone Web Page, on page 75](#).
- When your administrator enables the synchronization for call forward, the **Call forward all** screen displays instead of the **Call forward settings** screen. In this scenario, see [Activate Call Forward All with Feature Activation Code Synchronization, on page 76](#).
- Step 2** Select one of the following call forward services:
- **Forward all**
 - **Forward busy**
 - **Forward no answer**
- Step 3** Do any of the following:
- Enter the target number, to which you want to forward incoming calls from this phone line.
 - Press the **Contacts** softkey and select a contact from your contact directories.
- Step 4** Press **Set** to apply the settings.
- Step 5** Verify that your calls are forwarded by looking for the call forward  icon next to the line or at the top of the phone screen.
-

Related Topics

- [Phone Web Page, on page 25](#)
- [Forward Calls with the Phone Web Page, on page 75](#)
- [Activate Call Forward All with Feature Activation Code Synchronization, on page 76](#)
- [Forward Calls from Your Phone, on page 128](#)

Forward Calls with the Phone Web Page

Use the phone web page to set up your phone to forward calls.

You can also set up call forward on your phone screen. For more information, see [Forward Calls, on page 74](#) or [Forward Calls from Your Phone, on page 128](#).

Before you begin

Your administrator must enable the call forward services. Otherwise, the configuration on the phone web page doesn't take effect.

Procedure

- Step 1** On the phone web page, click **User Login > Voice > User**.
- Step 2** In the **Call Forward** section, set the **Cfwd All**, **Cfwd Busy**, **Cfwd No Answer**, or combination of them to **Yes**, and enter a phone number for each of the call forward services that you want to enable:
- **Cfwd All/Cfwd All Dest**—Forwards all calls.
 - **Cfwd Busy/Cfwd Busy Dest**—Forwards calls only if the line is busy.
 - **Cfwd No Answer/Cfwd No Ans Dest**—Forwards calls only if the line is not answered.
 - **Cfwd No Answer/Cfwd No Ans Delay**—Assigns a response delay time in seconds.
- If your administrator disables the feature key synchronization (FKS) and XSI sync for call forward on your phone, you can enter the value as number of seconds after which a call is forwarded.
- If your administrator enables feature key synchronization (FKS) or XSI sync for call forward on your phone, you can enter the value as number of rings after which a call is forwarded.
- The call forward settings on the phone web page take effect only when FKS and XSI are disabled. For more information, consult your administrator.
- Step 3** Click **Submit All Changes**.

Related Topics

- [Phone Web Page Preferences](#), on page 165
- [Phone Web Page](#), on page 25

Activate Call Forward All with Feature Activation Code Synchronization

When you press the **Forward** or **Forward all** softkey, the **Call forward all** screen displays and it allows you to set up your phone to forward all calls.

Before you begin

Your administrator enables a feature activation code that synchronizes the phone with a server to forward all calls.



- Note** The Feature Activation Code Synchronization feature only supports the Call Forward All service. The Call Forward Busy and the Call Forward No Answer services are not supported.
- When your administrator enables the feature activation code for the synchronization, the screen **Call forward settings** is ready-only.
-

Procedure

- Step 1** Press **Forward** or **Forward all**

- Step 2** Do any of the following:
- Enter the target number, to which you want to forward incoming calls from this phone line.
 - Press **Contacts** and select a contact from your contact directories.
 - Press **Redial** and select an entry from the **Placed calls** list.
- Step 3** Press **Call** to forward all calls to the specified number.
- You can clear the call forward settings by pressing **Clr fwd** or **Clf fwd all**.
- Step 4** Verify that your calls are forwarded by looking for the call forward  icon next to the line or at the top of the phone screen.
-

Transfer Calls

You can transfer an active call to another person.

Transfer a Call to Another Person

When you transfer a call, you can stay on the original call until the other person answers. This gives you an opportunity to talk privately with the other person before you remove yourself from the call. If you don't want to talk, transfer the call before the other person answers.

You can also swap between both callers to consult with them individually before you remove yourself from the call.

Procedure

- Step 1** From a call that is not on hold, press **Transfer**  or **Transfer**.
- Step 2** Enter the other person's phone number and press **Call**.
- Step 3** (Optional) Wait until you hear the line ring or until the other person answers the call.
- Step 4** Press **Transfer** again.
-



Consult Before You Complete a Transfer

Before you transfer a call, you can talk to the person that you're transferring the call to.

Before you begin

You have an active call that needs to be transferred.

Procedure

- Step 1** From a call that is not on hold, press **Transfer**  or **Transfer**.
 - Step 2** Enter the phone number for the party you want to call and press **Call**.
 - Step 3** When the other person answers, you can talk to them.
 - Step 4** (Optional) Press the line key to return to the held call.
 - Step 5** (Optional) Press the line key to return to the transfer target phone number.
 - Step 6** Press **Transfer**  or **Transfer** again.
-

Conference Calls and Meetings

You can talk with several people in a single call. You can dial another person and add them to the call. If you have multiple phone lines, you can join two calls across two lines. The conference ends when all participants hang up.

Add Another Person to a Call

Procedure

- Step 1** From an active call, press **Conference**  or **Conf**.
 - Step 2** Enter the phone number for the party you want to add and press **Call**.
 - Step 3** Press **Conference** or **Conf**.
-

Conference with a Star Code

Press **Conference**  or **Conf** only once to combine many active calls into a conference and talk to several people in a single call.

Before you begin

Your administrator has added a star code to the **Conference**  or **Conf** from the phone web page.

Procedure

- Step 1** Make a call from a line and wait for an answer.
- Step 2** Use the same line to call another number and wait for an answer. You can use the same line to call other numbers.
- Step 3** Press **Conference**  or **Conf** only once.

All numbers are added to the conference call and you see the star code that represents the conference bridge URL with one of the active calls.

Remove a Participant as a Host in Ad Hoc Conference

As a host, you can remove a participant from the participant list. However, host and participants can invite multiple participants to join the conference, but any of the participants can only be removed by the person from whom the invite has come. For example, user A is the host of the Ad Hoc conference and calls user B and conferences user C and user D. In such situation, user A will be able to remove user B, user C, and user D. Now, if user C invites user E into the conference call, user C can remove user E but user A cannot remove user E.

Before you begin

You are host of an Ad Hoc conference.

Procedure

- Step 1** When in an Ad Hoc conference, press **Participants** to display the participants name.
 - Step 2** Select any of the participants who you have invited to the conference call and press **Remove**.
 - Step 3** Confirm the removal message on the phone.
-

View the Participants List as a Host in Ad Hoc Conference

You can show the list of participants when you are hosting an Ad Hoc conference.

Before you begin

Participants softkey is available.

Procedure

- Step 1** Make a call (for example, user A) from a line and wait for an answer.
 - Step 2** Press **Conference** to invite another person (for example, user B) into the meeting.
 - Step 3** When user B answers the call, press **Conference** again to merge user B into the meeting.
You can add more participants into the meeting in the same way.
 - Step 4** Press **Participants** softkey. Name of all the participants who has joined the meeting will show up in the **Participants** screen.
 - Step 5** (Optional) Press **Exit** to exit from the **Participants** screen.
-

View the Participants List as a Participant

You can show list of participants of an Ad Hoc conference.

Before you begin

Participants softkey is available.

Procedure

- Step 1** Answer the call from a host.
- Participants** softkey displays after your host merge you into the meeting.
- Step 2** Press **Participants** softkey to display the list of participants.
- Step 3** (Optional) Press **Exit** to exit from the **Participants** screen.
-

Page a Group of Phones (Multicast Paging)

Your administrator can configure your phone as a part of a paging group. In a paging group, your phone can automatically answer pages from other Multiplatform phones in the phone system. Each paging group has a unique number associated with it. Your administrator gives you the configured paging group numbers. When your phone is paged, you hear three short beeps. The phone establishes one-way audio between you and the phone that called you. You do not have to accept the page.

Procedure

Dial the number of the paging group.

XML Application and Multicast Paging

If your phone is part of a paging group XML application enabled, your phone displays images or messages when you receive multicast pages from server. During a unicast and multicast paging or broadcast, phones in the paging group shows the following behavior:

- Phone (sender) that initiates the page, does not display any XML application message.
- Phones (receiver) that receive page displays a XML application message (incoming page) on their screen when the paging starts if your administrator configures the service.
- If the XML application closes due to timeout (sets by your administrator) or by administrator, the receiver shows the incoming page. However, if there is no timeout configured, XML application closes when paging call ends.

Your administrator can invoke XML service from multicast paging.

View XML Application Details

You can view list of Cisco XML objects that your phone supports.

Before you begin

- Your administrator has configured XML applications.

Procedure

- Step 1** Press **Applications** .
- Step 2** Press **Settings**.
- Step 3** In **Information and settings** screen, select **XML applications**.
The list of supported Cisco XML objects is displayed, such as **CiscoIPPhoneMenu**, **CiscoIPPhoneDirectory**.
- Note** **XML applications** menu is not available on your phone when your administrator disables it.
-

Multiple Lines

If you share phone numbers with other people, you could have multiple lines on your phone. When you have multiple lines, you have more calling features available to you.

Answer the Oldest Call First

You can answer the oldest call available on all your phone lines, including Hold Reversion and Park Reversion calls that are in an alerting state. Incoming calls always have priority over Held or Park Reversion calls.

When working with multiple lines, you typically press the line button for the incoming call you want to answer. If you just want to answer the oldest call regardless of line, press **Answer**.

View All Calls on Your Phone

You can view a list of all your active calls—from all your phone lines—sorted in chronological order, oldest to newest.

The list of all calls is useful if you have multiple lines or if you share lines with other users. The list displays all your calls together.

Shared lines on your multiplatform desk phone

When you share a phone number, you can use that phone line just like you would any other line, but you should be aware of these special characteristics about shared lines:

- The shared phone number can be configured to appear on a maximum of 35 devices.
- The shared phone number appears on all phones that share the number.
- If your coworker answers the call, the shared line button and the session button are solid red on your phone.
- If you put a call on hold, your line button is solid red and the session button pulses red. Your coworker's line button is also solid red and the session button pulses red.
- Once the shared line is configured, the call bridge can be invoked by using either
 - [FAC Code](#)
 - Soft keys

Here is an example of customize PSK settings to add new soft key for Call Bridge as shown below:

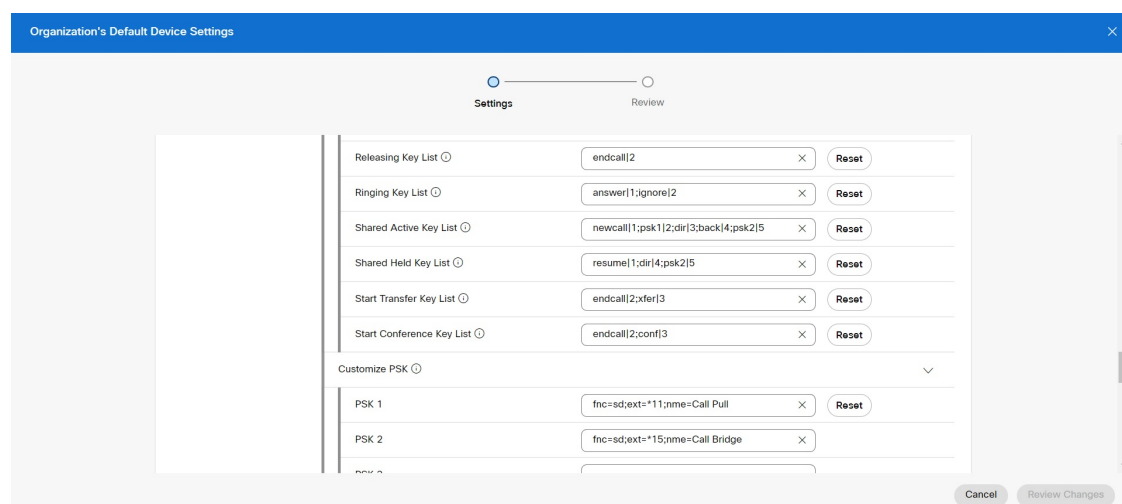

Soft keys can be configured at three levels. See [Configure and modify device settings in Webex Calling](#) to configure soft keys at organization, location and device level.

Add yourself to a call on a shared line

You or your coworker can join a call on the shared line. Your administrator needs to enable the feature on your phone.

If a user with whom you share a line has privacy turned on, you can't see their line settings and you can't add yourself to their call.

Procedure

Step 1 Press the line button for the shared line.

Step 2 Enter *33 on your phone.

Note If set up this way, you hear a tone to let you know that the system recognizes the access code.

Step 3 Enter the phone number of the person whose call you want to barge in to.



Note When connected, you're a part of the current call.

Record a Call

When you're on an active call, you can record it. You might hear a notification tone as you record the call.

During a recording, you see different icons in different recording state. You see the icons on the Calls screen and also on the line key on which you are recording a call.

Table 14: Recording Icons

| Icon | Meaning |
|---|-----------------------|
|  | Recording in progress |
|  | Recording paused |

Before you begin

Your administrator enables your phone with call recording.

Procedure

-
- Step 1** Press **Record** while on an active call.
 - Step 2** (Optional) While recording is in progress, you can press **PauseRec** or **Pause** to pause the recording.
 - Step 3** (Optional) Press **ResumeRec** or **Resume** to resume the recording.
 - Step 4** (Optional) Press **StopRec** or **Stop** to stop the recording.
 - Step 5** Press **End Call** to end the call.
-

Call Center Features

Your administrator configures your phone as a call center phone.

Your administrator can enable your phone with Automatic Call Distribution (ACD) features. This phone acts as a call center agent's phone and can be used to trace a customer call, to escalate any customer call to a supervisor in emergency, to categorize contact numbers using disposition codes, and to view customer call details.

Your phone can have ACD status as:

- Sign in
- Sign out
- Available

- Unavailable
- Wrap-up

The initial ACD status is controlled by your administrator in two ways:

- The last local status can be restored as the ACD initial status when the phone boots up, status is changed to "Registered" from "Unregistered" or "Registration failed", or registration destination ip address is changed due to failover, fallback or DNS response is changed.
- The ACD initial status can be obtained from the server.

Sign In as a Call Center Agent

When you're ready to start your work as a call center agent, you sign into the phone and set your status.

Your administrator can set up your phone so that when you sign into the phone, your status is set to Available automatically. In this case, you don't need to manually set the status.

Procedure

Step 1 Press **AgtSgnIn** or **AgtIn**.

Step 2 Check your status as a call center agent.

If the status is Available, the icon  displays beside your phone number. Otherwise, proceed with the next steps to manually set the status.

Step 3 Press **Agt status**.

Step 4 Highlight the **Available** status.

Step 5 Press **Select**.

Sign Out as a Call Center Agent

When you're ready to end your work as a call center agent, change your status and sign out of the phone. After you sign out, you won't receive more call center calls.

If you're on a call and know that you will sign off as soon as the call completes, change your status to **Wrap-up**.

Procedure

Press **AgtSgnOut** or **AgtOut**.

Change Your Status as a Call Center Agent

From time to time, you may need to take a brief break. To do that, change your status so that calls will not ring on your phone.

Procedure

- Step 1** Press **Agt status**.
 - Step 2** Highlight the **Unavailable** status.
The **Unavailable** menu text box allows you to add the reason of your unavailability.
If you need, your administrator can hide the text box on the phone from the phone web interface.
 - Step 3** Press **Select**.
 - Step 4** Press **Agt status**.
 - Step 5** Highlight the **Available** status.
 - Step 6** Press **Select**.
 - Step 7** Highlight the **Wrap-up** status.
 - Step 8** Press **Select**.
-

Accept a Call Center Call

When you sign into the phone as a call center agent and your phone status is set to available, your phone are ready to accept call center calls. Before you answer a call, you see information about the call.

Procedure

- Step 1** When you receive a call, you will see the call information page, press **Back** to exit and then press **Answer** to accept it.
 - Step 2** Press **Call Info** to see the call details.
 - Step 3** At the end of the call, press **End call**.
-

Hold an Agent Call

When you are on a call center call, you can put the caller on hold and return to the call. While the call is held for a long time, you will hear a reminder tone and a ring splash on the phone screen.

Procedure

- Step 1** Press **Hold**.

- Step 2** When you are ready to return, select the held call and press **Resume**.
-

Set a Disposition Code While on a Call Center Call

You can assign a disposition code to an active customer call or after you set your status to Wrap-up after a call. Disposition codes are quick labels that you apply to call records to describe a call. It is an easy way to label calls and keep track of customer contact history so that no details about the call are missed.

Before you begin

Your administrator enables your phone to add a disposition code.

Procedure

- Step 1** Press **Disp code**.

- Step 2** Press **Ok**.
-

Trace a Call

You can trace an active call and the last incoming call in any agent status.

Before you begin

Your administrator enables your phone to trace a call.

Procedure

From an active call or after a call, press **Trace**.

Escalate a Call to a Supervisor

When you need to escalate a call, you can add your supervisor to a conference call with you and your caller.

Before you begin

Your administrator enables emergency escalation on your phone.

Procedure

- Step 1** From an active call, press **Emergency**.

- Step 2** In the **Emergency Escalation** window, click **OK**.

You can enter preferred emergency escalation number, or you can leave it empty if you do not have any supervisor preference. You will not see any emergency escalation number.

Executive Calls



Note The executive calls are only available for the Cisco IP Phone 6871 Multiplatform Phones.

If your administrator has configured you as an executive user with a pool of assistants, you and your assistants can share control of your calls as described below:

- When call filtering is enabled, your incoming calls go to your assistants according to the criteria configured by your administrator on the BroadWorks.

You also receive your incoming calls that go to your assistants, if your administrator has enabled call screening for you.

When an assistant answers a call, you no longer see the call on your extension.

- You receive calls that your assistants transfer to you. If you do not answer a transferred call, the call returns to your assistants.
- You can join a call that is in progress with an assistant.
- You can transfer an ongoing call from an assistant to yourself.

Join an Ongoing Call as an Executive

Dial the service activation code provided by your administrator, or follow the procedure described below to join an ongoing call.

Before you begin

One of your assistants is engaged in a call on your behalf.

Procedure

Press the **Bridge in** softkey on your phone.

Transfer an Ongoing Call to Yourself as an Executive

Dial the service activation code provided by your administrator, or follow the procedure described below to transfer an ongoing call to yourself.

Before you begin

One of your assistants is engaged in a call on your behalf.

Procedure

Press **Call retrieve** on your phone.

Troubleshooting Executive Calls

Cannot Join or Transfer a Call

You can only transfer or join a call if there is only one ongoing call for you.

Executive Assistant Calls



Note The executive assistant calls are only available for the Cisco IP Phone 6871 Multiplatform Phones.

If your administrator has added you to an executive's pool of assistants, and you have opted in to the pool, you share control of the executive's calls with the executive and other assistants in the pool, as described below:

- You can initiate calls on behalf of the executive.
- When call filtering is on, you receive the executives' incoming calls according to the criteria configured by your administrator. When an executive or another assistant answers a call, you no longer see the call on your extension.
- After you initiate or answer a call, you can transfer the call to the executive. If the executive does not answer a transferred call, the call may return to you.
- You can join a call that is in progress with an executive.
- You can transfer an ongoing call from an executive to yourself.



Initiate a Call On Behalf of an Executive as an Assistant

Dial the service activation code provided by your administrator, or follow the procedure described below to initiate a call on behalf of an executive.

Before you begin

You are in an executive's pool of assistants.

Procedure

- Step 1** Do one of the following actions:
- If your administrator has programmed the **Assistant** function on a line key, press the line key.
 - If you do not have the **Assistant** function on a line key:
 - a. Press **Applications** .
 - b. Select **Assistant** .
- Step 2** If your administrator has configured your extension to connect to the XSI BroadWorks server, the **Assistant** screen displays. In the screen, select **Executive List**.
- If your administrator only enables the feature key synchronization (FKS) on your extension, the screen directly displays the executive list.
- The screen shows a list of all executives associated with all the assistant extensions on the phone. It also shows the Opt-in/Opt-out status of the assistant for each executive.
- Step 3** Select the executive on whose behalf you want to initiate a call.
- If there are multiple assistant extensions on the phone, the extension with which the selected executive is associated appears at the top.
- Step 4** Press **Proxy call**.
- Step 5** Enter the number that you want to call.
- Step 6** Press **Call**.
- Step 7** (Optional) If your administrator has configured your extension to connect to the XSI BroadWorks server, you might receive an incoming call from a SIP proxy. In this case, press **Answer** to initiate the call to the target. You can also press **Decline** to decline the call or press **Ignore** to silence the call.
-

Transfer an Ongoing Call to an Executive as an Assistant



Note You can transfer an ongoing call to an executive if it is the only ongoing call for the executive. If assistants are currently engaged in other calls for the executive, you cannot transfer a call.

Dial the service activation code provided by your administrator, or follow the procedure described below to transfer an ongoing call to an executive.

Before you begin

You are engaged in a call on behalf of an executive.

Procedure

Press the **Call push** softkey to transfer the call.

You can also transfer the call by using the following method:

- a) Press the **Hold** softkey.
 - b) Press the **Call push** softkey.
-

Join or Transfer an Ongoing Call to Yourself as an Executive Assistant

Before you begin

A call is in progress with an executive.

Procedure

- Step 1** Dial the service activation code provided by your administrator, for initiating calls on behalf of executives, and follow the voice prompts.
 - Step 2** When you are prompted to enter the destination number, dial the appropriate service activation code provided by your administrator, for joining or transferring a call to yourself.
-

Troubleshooting Executive-Assistant Calls

Cannot Join or Transfer a Call

You can only transfer or join an executive's call if there is only one ongoing call for the executive.

Cannot Initiate Multiple Calls On Behalf of Executives

The number of calls that you can initiate in parallel on behalf of executives is limited by your administrator.



CHAPTER 3

Contacts

- [Search for a Contact in the All Directories Screen, on page 91](#)
- [Corporate Directory, on page 93](#)
- [Instant Message and Presence Contacts, on page 107](#)
- [Personal Address Book, on page 109](#)
- [Reverse Name Lookup for Incoming and Outgoing Calls, on page 112](#)

Search for a Contact in the All Directories Screen

The **All directories** is the landing page of your contacts. Typically, it automatically retrieves the contacts from your personal address book and Bluetooth-paired phone.

If your target contact is not in the displayed directories, you can perform a manual search in the screen. The search scope covers the following directories (if enabled):

- Personal address book
- BroadSoft directory, including the following subdirectories:
 - Enterprise
 - Group
 - Personal
 - Enterprise Common
 - Group Common
- LDAP directory

The manual search operation tries to retrieve the contacts from the directories in the following order:

- Personal address book
- BroadSoft directory
- LDAP directory





Note Your administrator controls the directories that you can access. If the contact is in a disabled directory, the entry doesn't display in the search results.

From the search results, you can view the contact details, call the contact, or edit the number before making the call. If your administrator enables the personal directory on the phone, you can also add the contact to your personal directory.

Before you begin

Your administrator must enable the all directory search. Otherwise, the **All directories** screen doesn't display.

Procedure

-
- Step 1** Do one of the following actions:
- 6821: Press **Applications** , and select **Directories**.
 - Other phones in 6800 series: Press **Contacts** .
- Step 2** Select the contact already displayed in the screen by using the Navigation cluster.
If you can't find the contact in the screen, proceed with the next step.
- Step 3** Enter the name of the contact that you want to find.
The phone searches for first or last names that include your search string anywhere in the name.
If you search contacts without any keywords, the phone retrieves all contacts.
- Step 4** Press **Search**.
The search results show both full and partial name matches.
By default, up to 50 records of the contacts display in the phone. Your administrator can set up the maximum number of the contacts.
- Step 5** (Optional) To view a contact's details, highlight the contact in the search results, and press **Details**.
- Step 6** (Optional) To add a contact to the target directory on the phone, follow these steps:
- a) While viewing the contact details, press **Option**.
 - b) Select **Add contact**.
The menu label shows the target directory to which you want to add the contact:
 - If the menu **Add personal address entry** displays, you add the contact to the local personal address book.
 - If the menu **Add BroadSoft personal contact** displays, you add the contact to the BroadSoft Personal directory.

Your administrator can change the target directory.
If you don't see the **Add contact** option, contact your administrator.
 - c) Enter the contact details and press **Save**.

- Step 7** To call a contact, follow these steps:
- Highlight a contact in the search results.
 - Press **Details**.
 - Highlight the work number that you want to dial.
 - Press **Call**.
- Step 8** (Optional) To change the number to be dialed and then make a call to a contact, follow these steps:
- Highlight a contact in the search results.
 - Press **Details**.
 - Highlight the work number that you want to change.
 - Press **Edit call**.
 - Edit the number as necessary.
 - Press **Call**.

Related Topics

- [Search for a Contact in Your Personal Address Book](#), on page 110
- [Search for a Contact in Your BroadSoft Directory](#), on page 97
- [Search for a Contact in Your LDAP Directory](#), on page 103

Corporate Directory

You can look up a coworker's number from your phone, which makes it easier to give them a call. Your administrator sets up and maintains the directory.

Your phone supports three types of corporate directories—Lightweight Directory Access Protocol (LDAP) Directory, Broadsoft Directory, and a Cisco XML Directory.

Webex Directory

Webex directory helps you to look up for Webex contacts. Your administrator configures the Webex directory on your phone. You can search and view the Webex contacts, which makes it easier to give them a call. You can edit the display name of the Webex contact. When your administrator configures Webex contacts on a line key or as a programmable softkey, you see the directory name on the line key or as softkey on phone home screen, which makes it easier to access the directory search screen directly.

Search for a Contact in Your Webex Directory

You can search contacts in the Webex directory by email or name.

Before you begin

Your administrator enables the Webex directory.

Procedure

- Step 1** Do one of the following actions:

- 6821: Press **Applications** , and select **Directories**.
- Other phones in 6800 series: Press **Contacts** .

Step 2 In the **Directory** screen, select the Webex directory.

By default, the directory name is **Webex directory**.

Step 3 In the **Search Webex directory** screen, enter the search criteria which is either a name or an email.

Step 4 Click **Search**.

Note You can also search a Webex contact from the **All directory** search screen by entering name or email. For more information, see [Search for a Webex Contact in All Directory, on page 95](#).

- The search operation sometime retrieves contacts with same name, work phone number, and mobile number. In such cases, Webex directory displays only one contact and considers the remaining contacts as duplicate.

For example:

- If a search retrieves A (Name: "abc", Work phone: "123456") and B (Name: "abc", Work phone is "123456"): Directory displays A only.
- If a search retrieves A (Name: "abc", Work phone: "123456", and Mobile phone: "8888"), B (Name: "abc", Work phone: "123456", and Mobile phone: "8888"): Directory displays A only.
- If the search retrieves A (Name: "abc", Work phone: "123456", and Mobile phone: "8888"), B (Name: "abc", Work phone: "123456", and Mobile phone: "2222"): Directory display both A and B.

Step 5 (Optional) Select a contact from the searched list and press **Details**. You see the details, such as name, work phone number, mobile phone number, email, and department.

Step 6 (Optional) Select a contact and make a call.

- If a contact has both work phone number and mobile phone number, the directory displays the work phone number as the call number. Work phone number has higher priority than the mobile phone number. From the details screen, if you select the name or the work phone number and make a call, the phone dials the work phone number. But, if you select the mobile number and make a call, the phone dials the mobile phone number.
- If a contact has only mobile number, the directory displays the mobile phone number as the call number.
- If a contact has no work phone number and mobile phone number, the directory displays only the name without a call number. You can't make a call from this contact.

Step 7 (Optional) Select a contact and press **Edit call** to access the **New call** screen. In this screen, you can modify the contact number to either work phone number or to mobile phone number, and then make a new call. If contact doesn't have a call number, **Edit call** doesn't work.



Note While the phone searches for the contact, you can press **Cancel** and cancel the search operation before the phone fetches final result.

Webex directory search has the following conditions and error scenarios:

- You must enter minimum three characters in the **Name/Email** box. When you enter fewer than three characters, you see a message `Invalid input. Enter at least 3 characters`
- When you enter correct search criteria but the phone returns no value, you see a message: `No match found`
- If your administrator configures max display value more than 100, the query result displays only hundred contacts for a search in Webex directory. or All directory. When search result has count more than the allowed display record value, you see a message: `Too many matches found.Refine your search`
- During the search, if there's network issue or Domain Name Server (DNS) response failed and you see a message: `Directory access failed. Check the configuration and network settings, you must contact your administrator.`

Search for a Webex Contact in All Directory

You can search Webex contacts from the **All directory** screen.





Note Even if your administrator configures max display value more than 100, the query result displays only hundred contacts for a search in All directory. When search result has count more than the allowed display record value, you see a message: `Too many matches found.Refine your search`

Before you begin

- Your administrator enables the Webex directory.
- Your administrator enables All directory search.

Procedure

- Step 1** Do one of the following actions:
- 6821: Press **Applications** , and select **Directories**.
 - Other phones in 6800 series: Press **Contacts** .
- Step 2** In the **Directory** screen, select **All directories**.
- Step 3** In the **Search all directories** screen, enter the search criteria for Webex contact. You can enter a name or an email address.

All directory search supports one character as the search input and you can enter only name of the contact. But to search Webex contacts, you must enter minimum three characters and you can search by entering name

or an email. Hence, when you enter fewer than three characters in this search, phone doesn't retrieve Webex contacts.

Step 4 Click **Search**.

The search operation sometime retrieves contacts with same name and work phone number. In such cases, **All directory** list shows only one contact with the highest priority and ignores the remaining contacts as duplicate. Search operation tries to retrieve the contacts from the directories in the following order and Personal address book has the highest priority.

- Personal address book (PAB)
- Webex directory
- BroadSoft directory
- LDAP directory
- Bluetooth

Step 5 (Optional) Select a contact from the searched list and press **Details**. You see the details, such as name, work phone number, mobile phone number, email, and department in the **Search result details** screen.

In the **Search result details** screen, you can add the Webex contact to the Personal address book. To add, select the name and select **Option > Add contact > Select** and save the details in the **Add Personal address entry** screen. You can access the **Personal address book** screen and search for the added Webex contact, the result shows that the contact is added to PAB. If you search the added contact in the BroadSoft directory, the search retrieves the added Webex contact.

We recommend to choose either **Webex** or **XSI Server** to search contacts, as you can't search Webex contacts and XSI server contacts at the same time.

Edit the Webex Directory Name

You can modify the display name of the Webex directory.

Before you begin

Your administrator configures support for Webex contacts.

Procedure

Step 1 Do one of the following actions:

- 6821: Press **Applications** , and select **Directories**.
- Other phones in 6800 series: Press **Contacts** .

Step 2 Highlight the **Webex directory**.

Step 3 Click **Option**.

Step 4 Select **Edit settings**.

- Step 5** In the **Webex directory settings** screen, edit the name in the **Directory name** box. The name you enter displays as the Webex directory name under **Directory** list.
- Step 6** Click **Save**.
-

Broadsoft Directory

You can search and view your personal, group, and enterprise contacts in your Broadsoft Directory, which makes it easier to give them a call. Your administrator configures the Broadsoft Directory in your phone. This application feature uses BroadSoft's Extended Services Interface (XSI).



Search for a Contact in Your BroadSoft Directory

Before you begin

- Your administrator enables the BroadSoft XSI services.
- Your administrator enables the BroadSoft directories and sets up the directories properly.
- Your administrator enables the Browse Mode for the directories.

When this mode is enabled, a preload operation will start automatically to retrieve all the contacts from the directory.

Procedure

- Step 1** Do one of the following actions:
- 6821: Press **Applications** , and select **Directories**.
 - Other phones in 6800 series: Press **Contacts** .
- Step 2** Press **Category**, if it displays on the phone. Otherwise, skip the step.
- Step 3** Select a BroadSoft directory. The default names are:
- Enterprise
 - Group
 - Personal
 - Enterprise Common
 - Group Common

Note When your administrator disables the directory individual mode, the phone only displays **BroadSoft directory**.

After you enter the directory, wait until the preload operation is complete. You can press **Cancel** to stop the preload operation.

- Step 4** Press **Option**, then select **Search**.

If your administrator disables the directory browse mode, you can find the **Search** softkey displayed on the phone instead.



- Step 5** Select a search criteria.
- In BroadSoft Enterprise or Group directory, search a contact by Last Name, First Name, User ID, Number, Extension, Mobile phone, Department, or Email address.
 - In BroadSoft Enterprise Common, Group Common, or Personal directory, search a contact by Name or Number.
- Step 6** Enter your search criteria, and press **Search**.
-

Edit Your Contact Type in Your BroadSoft Directory

Before you begin

Your administrator disables the directory individual mode for the BroadSoft XSI service.

Procedure

- Step 1** Do one of the following actions:
- 6821: Press **Applications** , and select **Directories**.
 - Other phones in 6800 series: Press **Contacts** .
- Step 2** Press **Category**, if it displays on the phone. Otherwise, skip the step.
- Step 3** Highlight the **BroadSoft directory**.
- Step 4** Press **Option**.
- Step 5** Select **Edit settings**.
- Step 6** Select the **Type** field.
You can select Enterprise, Group, Personal, Enterprise Common, or Group Common as your BroadSoft Directory contact type.
- Step 7** Press **Save** to apply the change.
-

Manage Your Contacts in the BroadSoft Personal Directory



You can add, edit, or delete contacts in the BroadSoft Personal directory.

Before you begin

- Your phone connects to the BroadSoft XSI service.
- Your administrator enables the BroadSoft Personal directory.
- Your administrator sets the BroadSoft Personal directory as the target directory to store new contacts.
- Your administrator enables the directory browse mode.

When this mode is enabled, a preload operation will start automatically to retrieve all the contacts from the directory.

Procedure

- Step 1** Do one of the following actions:
- 6821: Press **Applications** , and select **Directories**.
 - Other phones in 6800 series: Press **Contacts** .
- Step 2** Press **Category**, if it displays on the phone. Otherwise, skip the step.
- Step 3** To add a contact in the BroadSoft Personal directory, do the following:
- a) Select the BroadSoft Personal directory. The default name is **Personal**.
Note If your administrator disables the directory individual mode, the phone displays the menu item **BroadSoft directory** instead, select it.
 - b) Wait for the preload operation to be completed or press **Cancel** to stop the preload operation.
If your administrator disables the directory browse mode, the menu **Search personal directory** displays instead. Enter your search criteria, and press **Search**.
 - c) Press **Option**, and then select **Add**.
 - d) Enter details of the contact.
 - e) Press **Save**.
- Step 4** To add a contact from other directories (if enabled) to the BroadSoft Personal directory:
- a) Select the All directories, the BroadSoft directory, the LDAP directory, or the personal address book.
 - b) Search for a contact that you want to add.
 - c) Highlight the contact.
 - d) Press **Option**, and then select **Add contact**.
 - e) Enter details of the contact.
 - f) Press **Save**.
- Step 5** To edit a contact in the BroadSoft Personal directory, do the following:
- a) Select the BroadSoft Personal directory. The default name is **Personal**.
Note If your administrator disables the directory individual mode, the phone displays the menu item **BroadSoft directory** instead, select it.
 - b) Wait for the preload operation to be completed or press **Cancel** to stop the preload operation.
If your administrator disables the directory browse mode, the menu **Search personal directory** displays instead. Enter your search criteria, and press **Search**.
 - c) Highlight the contact that you want to edit.
 - d) Press **Option**, and then select **Edit**.
You can also press the **Select** button of the Navigation cluster to edit the contact.
 - e) Edit details of the contact.
 - f) Press **Save**.

- Step 6** To delete a contact from the BroadSoft Personal directory, do the following:
- Select the BroadSoft Personal directory. The default name is **Personal**.

Note If your administrator disables the directory individual mode, the phone displays the menu item **BroadSoft directory** instead, select it.
 - Wait for the preload operation to be completed or press **Cancel** to stop the preload operation.

If your administrator disables the directory browse mode, the menu **Search personal directory** displays instead. Enter your search criteria, and press **Search**.
 - Highlight the contact that you want to delete.
 - Press **Option**, and then select **Delete**.

Edit Your BroadSoft Directory Name

When your administrator disables the directory individual mode, the phone only displays **BroadSoft directory**.



When your administrator enables the directory individual mode, the phone displays all enabled directories with default or customized names. The default names are:

- Enterprise
- Group
- Personal
- Enterprise Common
- Group Common



Note Only the directory that is enabled by your administrator can display in the **Directories** screen.

Procedure

- Step 1** Do one of the following actions:
- 6821: Press **Applications** , and select **Directories**.
 - Other phones in 6800 series: Press **Contacts** .
- Step 2** Press **Category**, if it displays on the phone. Otherwise, skip the step.
- Step 3** Do one of the following actions:
- Highlight the **BroadSoft directory**.
 - Highlight one of the configured directories.
- Step 4** Press **Option**.
- Step 5** Select **Edit Settings**.

- Step 6** Edit the **Directory Name** field.
- Step 7** Press **Save** to apply the change.
-

Edit the Server Name of Your BroadSoft Directory

When your administrator disables the directory individual mode, the phone only displays **BroadSoft directory**.



When your administrator enables the directory individual mode, the phone displays all enabled directories with default or customized names. The default names are:

- Enterprise
- Group
- Personal
- Enterprise Common
- Group Common



Note Only the directory that is enabled by your administrator can display in the **Directories** screen.

Procedure

- Step 1** Do one of the following actions:
- 6821: Press **Applications** , and select **Directories**.
 - Other phones in 6800 series: Press **Contacts** .
- Step 2** Press **Category**, if it displays on the phone. Otherwise, skip the step.
- Step 3** Do one of the following actions:
- Highlight the **BroadSoft directory**.
 - Highlight one of the configured directories.
- Step 4** Press **Option**.
- Step 5** Select **Edit Settings**.
- Step 6** Edit the **Host Server** field.
- Step 7** Press **Save** to apply the change.
-

Edit Credentials of Your BroadSoft Directory

When your administrator disables the directory individual mode, the phone only displays **BroadSoft directory**.



When your administrator enables the directory individual mode, the phone displays all enabled directories with default or customized names. The default names are:

- Enterprise
- Group
- Personal
- Enterprise Common
- Group Common



Note Only the directory that is enabled by your administrator can display in the **Directories** screen.

Procedure

- Step 1** Do one of the following actions:
- 6821: Press **Applications** , and select **Directories**.
 - Other phones in 6800 series: Press **Contacts** .
- Step 2** Press **Category**, if it displays on the phone. Otherwise, skip the step.
- Step 3** Do one of the following actions:
- Highlight the **BroadSoft directory**.
 - Highlight one of the configured directories.
- Step 4** Press **Option**.
- Step 5** Select **Edit Settings**.
- Step 6** (Optional) Set the **Authentication type** to **Login credentials** or **SIP credentials**.
- Step 7** Enter the user credentials based on the authentication type.
- Login credentials: edit the **User ID** and **Password** fields.
 - SIP credentials: edit the **SIP auth ID** and **SIP password** fields.
- Step 8** Press **Save** to apply the change.
-

LDAP Directory

The Cisco IP Phone supports Lightweight Directory Access Protocol (LDAP) v3. You can search for a specified LDAP directory for a name, phone number, or both. LDAP-based directories, such as Microsoft Active Directory 2003 and OpenLDAP-based databases, are supported.

To access the LDAP directory on the phone, enter your user credentials at least once. Your administrator can set up your user credentials on the phone administration web page. Once you successfully access the LDAP directory, the phone saves the user credentials. Next time, you can skip the user login procedure. The phone can save the user credentials for the host users or guest users. These users normally sign in to the phone through the Flexible Seating or the Extension Mobility feature.

Edit Credentials of Your LDAP Directory

When you access the LDAP directory on the phone, you might be prompted to enter your user credentials. You can edit the credentials in advance to bypass the sign-in procedure. You can also change the LDAP account by editing the user credentials.

The phone saves the credentials for different types of users. For example, the users who sign into the phone with the Flexible Seating or Extension Mobility feature. After you switch a user on the phone, the phone retains the user's credentials. Therefore, you can still access the LDAP directory without the need to sign in.

Before you begin

Your administrator enables the LDAP directory.

Procedure

Step 1 Do one of the following actions:

- 6821: Press **Applications** , and select **Directories**.
- Other phones in 6800 series: Press **Contacts** .

Step 2 (Optional) Press **Category**.

If your administrator disables the directory browse mode, the softkey doesn't display on the phone.

Step 3 Highlight the LDAP directory.

By default, the directory name is “Corporate directory (LDAP)”.

Step 4 Press **Option**, then select **Edit settings**.

Step 5 Enter the user credentials.

The displayed fields are different according to the authentication method selected by your administrator:

- If the authentication method is “Simple”, the phone prompts the **Client DN** and **Password** credentials.
- If the authentication method is “DIGEST-MD5”, the phone prompts **Username** and **Password** credentials.

Step 6 Press **Save** to save the credentials.

Search for a Contact in Your LDAP Directory

Before you begin

Your administrator enables the LDAP directory.

Procedure

Step 1 Do one of the following actions:

- 6821: Press **Applications** , and select **Directories**.

- Other phones in 6800 series: Press **Contacts** .

Step 2 Press **Category**, if it displays on the phone. Otherwise, skip the step.

Step 3 Select the LDAP directory.

By default, the directory name is “Corporate directory (LDAP)”.

Step 4 (Optional) If prompted, sign in with your user credentials.

The phone prompts one of the following credentials to access the LDAP directory:

- **Client DN and Password**
- **Username and Password**

For more information, contact your administrator.

If the local cache on the phone contains the user credentials, you skip the user sign-in procedure automatically.

When you enter the directory, the phone might start to retrieve all the contacts from the directory.

Step 5 (Optional) Press **Cancel** to stop the auto loading.

Step 6 Press **Option**, and then select one of the following methods:

- **Simple search:** You can search by last name and first name of a contact.
- **Advanced search:** You can search by last name, first name, and telephone number of a contact.

Step 7 Enter your search criteria, and then press **Search**.

Related Topics

[Call a Contact in Your LDAP Directory](#), on page 104

[Edit a Contact Number in Your LDAP Directory](#), on page 105

Call a Contact in Your LDAP Directory

Before you begin

Your administrator enables the LDAP directory.

Procedure

Step 1 Search for a contact in the LDAP directory, see [Search for a Contact in Your LDAP Directory, on page 103](#).

After the search is completed, the matched contacts display in the form of entries in the search result list.

Step 2 In the **Company directory (LDAP) result list** screen, use the outer ring of the navigation cluster to highlight an entry.

Typically, the phone displays an entry together with a contact number. However, if an entry doesn't have any contact number, the contact number field is empty.

Step 3 Press **Call**.

Note Your phone selects the first available contact number of the entry to dial out. If an entry contains multiple contact numbers and you want to call the other contact numbers, proceed with the next steps. Otherwise, skip the remaining steps.

Step 4 Press **Details** to view more information of the highlighted entry.

Step 5 In the **Company directory (LDAP) address entry** screen, use the outer ring of the navigation cluster to scroll through the details.

You can find that certain attributes display multiple times in the entry details, and each attribute contains a contact number.

Step 6 Highlight a contact number that is available to dial out, and press **Call**.

The **Call** softkey displays only for the contact numbers that are available to dial out.

Edit a Contact Number in Your LDAP Directory

Before you make a call, you can edit the contact number based on an existing number that you select.

Before you begin

Your administrator enables the LDAP directory.

Procedure

Step 1 Search for a contact in the LDAP directory, see [Search for a Contact in Your LDAP Directory, on page 103](#). After the search is completed, the matched contacts display in the form of entries in the search result list.

Step 2 In the **Company directory (LDAP) result list** screen, use the outer ring of the navigation cluster to highlight an entry.

Typically, the phone displays an entry together with a contact number. However, if an entry doesn't have any contact number, the contact number field is empty. In this scenario, you can't edit the contact number of the entry.

Step 3 Press **Edit call**.

Note If an entry contains multiple contact numbers (separated by comma) and you want to edit one of the contact numbers, perform [Step 4](#) to [Step 6](#). Otherwise, skip the steps.

Step 4 Press **Details** to view more information of the highlighted entry.

Step 5 In the **Company directory (LDAP) address entry** screen, use the outer ring of the navigation cluster to scroll through the details.

You can find that certain attributes display multiple times in the entry details, and each attribute contains a contact number.

Step 6 Highlight a contact number, and press **Edit call**.

The **Edit call** softkey displays only for the contact numbers that are available to edit.

Step 7 Edit the number as necessary.

Step 8 Press **Call**.

XML Directory

Your phone can retrieve the contacts from the XML directory service or application after your administrator configures the XML directory in your phone. In this way, you can view and call the contacts in your XML directory. Typically, your phone can display up to 200 contacts (or entries) in your XML directory.

Call a Contact in Your XML Directory

Before you begin

Your administrator has configured the XML directory.

Procedure

Step 1 Do one of the following actions:

- 6821: Press **Applications** , and select **Directories**.
- Other phones in 6800 series: Press **Contacts** .

Step 2 Press **Category**, if it displays on the phone. Otherwise, skip the step.

Step 3 Select the XML directory.

By default, the directory name is “Corporate directory (XML)”.

Step 4 In the **Directories** screen, use the outer ring of the navigation cluster to highlight an entry.

The phone displays an entry together with one or more contact numbers.

Step 5 Press **Call**.

Note For the entry that contains multiple contact numbers, your phone always selects the first contact number to dial out. If you want to call the other contact numbers of the entry, proceed with the next steps. Otherwise, skip the remaining steps.

Step 6 Press the **Select** button of the Navigation Cluster to view details of the highlighted entry.

Step 7 In the **Corporate directory (XML) address entry** screen, use the outer ring of the navigation cluster to scroll through the details.

An entry can contain up to 5 contact numbers.

Step 8 Highlight a contact number, and press **Call**.



Edit a Contact Number in Your XML Directory

Before you make a call, you can edit the contact number based on an existing number that you select.

Before you begin

Your administrator has configured the XML directory.

Procedure

- Step 1** Do one of the following actions:
- 6821: Press **Applications** , and select **Directories**.
 - Other phones in 6800 series: Press **Contacts** .
- Step 2** Press **Category**, if it displays on the phone. Otherwise, skip the step.
- Step 3** Select the XML directory.
- By default, the directory name is “Corporate directory (XML)”.
- Step 4** In the **Directories** screen, use the outer ring of the navigation cluster to highlight an entry.
- The phone displays an entry together with one or more contact numbers.
- Step 5** Do one of the following actions:
- If the entry contains only one contact number:
 - a. Press **Edit call**.
 - b. Edit the number as necessary.
 - c. Press **Call**.
 - If the entry contains multiple contact numbers (separated by comma) and you want to edit one of the contact numbers:
 - a. Press the **Select** button of the Navigation Cluster to view details of the highlighted entry.
 - b. In the **Corporate directory (XML) address entry** screen, use the outer ring of the navigation cluster to highlight a contact number.

An entry can contain up to 5 contact numbers.

 - c. Press **Edit call**.
 - d. Edit the number as necessary.
 - e. Press **Call**.
-

Instant Message and Presence Contacts

Instant message and presence (IM&P) contacts display their presence information. You can see if the person is available, busy, or unavailable, or if the person does not want to be disturbed.

You use the UC-One Communicator to manage your lists of contacts. Your phone gets your lists of contacts from the UC-One Communicator server.

When you use the phone, the phone sends status information to the UC-One Communicator.

Presence

Your company may use the “UC-One Communicator” service and integrate it with the phone. You can use this service to display the status of your contacts.

On the phone, your status is displayed on the status line of the phone. You see one of the following:

- Available
- Away
- Do Not Disturb
- Offline

For more information on the “UC-One Communicator” service, see the Broadsoft documentation.



Make a Call to an IM and Presence Contact

When you call someone on your IM&P contacts, their presence state is displayed in your call history.

Before you begin

Your administrator enables the IM&P directory in the phone.

Procedure

- Step 1** Do one of the following actions:
- 6821: Press **Applications** , and select **Directories**.
 - Other phones in 6800 series: Press **Contacts** .
- Step 2** Press **Category**, if it displays on the phone. Otherwise, skip the step.
- Step 3** Select **IM&P contacts**.
- Step 4** Select a directory.
- Step 5** Select an entry.
- The entry shows the status of your contact.
- Step 6** (Optional) Press **Detail** to view the contact details and press **Back** to return to the contacts list.
- Step 7** Press **Call**.
-



Change Your Presence State

Because the phone is always available, you need to set your presence manually on the phone.

Before you begin

Your administrator enables the IM&P directory in the phone.

Procedure

- Step 1** Do one of the following actions:
- 6821: Press **Applications** , and select **Directories**.
 - Other phones in 6800 series: Press **Contacts** .
- Step 2** Press **Category**, if it displays on the phone. Otherwise, skip the step.
- Step 3** Select **IM&P contacts**.
- Step 4** Highlight a directory. For example, **Favorite**, **Non-Group**, **All contacts**, and so on.
- Step 5** Press **Presence**.
- Step 6** Select your presence from the list.
- Available—You can take a call.
 - Away—You have stepped away from the phone for a short time.
 - Do not disturb—You don't want to take a call.
 - Offline—You are not available to take calls. Typically, you use this presence when you leave the phone for long periods of time.
-

Personal Address Book



Add a New Contact to Your Personal Address Book

Before you begin

Your administrator must enable the personal address book on the phone. Otherwise, the menu item **Personal address book** doesn't display.

Your administrator has set the personal address book as the target directory that stores the new contacts.

Procedure

- Step 1** Do one of the following actions:
- 6821: Press **Applications** , and select **Directories**.
 - Other phones in 6800 series: Press **Contacts** .

- Step 2** Press **Category**, if it displays on the phone. Otherwise, skip the step.
- Step 3** To add a contact in your personal address book.
- Select **Personal address book**.
 - Press **Add**.
 - Enter a name and at least one phone number.
 - (Optional) Select a custom ringtone for the contact.
 - Press **Save** to add the contact.
- Step 4** To add a contact from other directories to your personal address book.
- Select the All directories, the BroadSoft directory, or the LDAP directory.
 - Search for a contact that you want to add.
 - Highlight the contact.
 - Press **Option**, and then select **Add contact**.
 - Enter a name and at least one phone number.
 - (Optional) Select a custom ringtone for the contact.
 - Press **Save** to add the contact.

Related Topics

- [Search for a Contact in the All Directories Screen](#), on page 91
- [Search for a Contact in Your BroadSoft Directory](#), on page 97
- [Search for a Contact in Your LDAP Directory](#), on page 103

Add a New Contact to Your Personal Address Book with Phone Web Page

Before you begin

Your administrator must enable the personal address book on the phone. Otherwise, the **Personal address book** menu doesn't display.

Procedure



- Step 1** On the phone web page, select **User Login > Personal Directory**.
- Step 2** Click **Add to Personal Directory**.
- Step 3** Add name and related number or numbers. The number contains work number, mobile number, and home number.
- Step 4** Click **Submit All Changes**.
-

Search for a Contact in Your Personal Address Book

Before you begin

Your administrator must enable the personal directory feature on the phone. Otherwise, the **Personal address book** menu doesn't display.

Procedure



- Step 1** Do one of the following actions:
- 6821: Press **Applications** , and select **Directories**.
 - Other phones in 6800 series: Press **Contacts** .
- Step 2** Press **Category**, if it displays. Otherwise, skip the step.
- Step 3** Select **Personal address book**.
- Step 4** Select **Option** > **Search**.
- Step 5** Enter the address entry to search for. The matched contacts will display on the phone.
- You can only search by name (case insensitive). Search by number is not supported.
-

Call a Contact in Your Personal Address Book

Before you begin

Your administrator must enable the personal directory feature on the phone. Otherwise, the **Personal address book** menu doesn't display.

Procedure

- Step 1** Do one of the following actions:
- 6821: Press **Applications** , and select **Directories**.
 - Other phones in 6800 series: Press **Contacts** .
- Step 2** Press **Category**, if it displays. Otherwise, skip the step.
- Step 3** Select **Personal address book** and search for an entry.
- Step 4** Highlight the personal address book entry that you want to dial.
- Step 5** Press **Call**.
-

Related Topics



[Search for a Contact in Your Personal Address Book](#), on page 110

Edit a Contact in Your Personal Address Book

Before you begin

Your administrator must enable the personal directory feature on the phone. Otherwise, the **Personal address book** menu doesn't display.

Procedure

- Step 1** Do one of the following actions:
- 6821: Press **Applications** , and select **Directories**.
 - Other phones in 6800 series: Press **Contacts** .
- Step 2** Press **Category**, if it displays on the phone. Otherwise, skip the step.
- Step 3** Select **Personal address book** and search for an entry.
- Step 4** Highlight the entry you want to change.
- Step 5** Press **Option**, and then select **Edit**.
- Step 6** Modify the entry information.
- Step 7** Press **Save**.
-

Related Topics



[Search for a Contact in Your Personal Address Book](#), on page 110

Remove a Contact from Your Personal Address Book

Before you begin

Your administrator must enable the personal directory feature on the phone. Otherwise, the **Personal address book** menu doesn't display.

Procedure

- Step 1** Do one of the following actions:
- 6821: Press **Applications** , and select **Directories**.
 - Other phones in 6800 series: Press **Contacts** .
- Step 2** Press **Category**, if it displays. Otherwise, skip the step.
- Step 3** Select **Personal address book**.
- Step 4** Search for the contact that you want to remove.
- Step 5** Highlight the address entry of the contact and press **Option** > **Delete** to delete the entry.
-

Related Topics

[Search for a Contact in Your Personal Address Book](#), on page 110

Reverse Name Lookup for Incoming and Outgoing Calls

Reverse name lookup searches for the name of a number in an incoming, outgoing, conference, or transferred call. The reverse name lookup acts when the phone cannot find a name using the service provider directory,

Call History, or your contacts. Reverse name lookup needs a valid LDAP Directory or XML Directory configuration.

The reverse name lookup searches the phone's external directories. When a search succeeds, the name is placed in the call session and in the call history. For simultaneous, multiple phone calls, reverse name lookup searches for a name to match the first call number. When the second call connects or is placed on hold, reverse name lookup searches for a name to match the second call.

Reverse name lookup is enabled by default.

Reverse name lookup searches the directories in the following order:

1. Phone contacts
2. Call History
3. LDAP Directory
4. XML Directory



CHAPTER 4

Recent Calls

- [Recent calls list, on page 115](#)
- [View your Recent Calls, on page 115](#)
- [View Webex Call Logs Duration, on page 117](#)
- [Spam Indication for Webex Calls, on page 118](#)
- [View Calls Logs from Server , on page 118](#)
- [Return a recent call, on page 119](#)
- [Clear the recent calls list, on page 119](#)
- [Create a Contact from a Recents Record, on page 120](#)
- [Delete a call record, on page 121](#)
- [Delete All Call Records, on page 121](#)

Recent calls list

Use the Recents list to see the 180 most recent individual calls and call groups.

If your Recents list reaches the maximum size, the next new entry overwrites the oldest entry in the list.

When STIR/SHAKEN support is implemented on the server, the phone displays an extra icon next to the caller ID based on the caller's STIR/SHAKEN verification result. Based on the verification result, the phone displays three types of icons. For more information on the icons, see [View your Recent Calls, on page 115](#).

View your Recent Calls

Check to see who's called you recently.



Note Each line has missed call badging. You can view the number of missed calls per line on the phone screen. The maximum missed call badge is 99. When you view either the All calls or Missed calls list on the phone screen for a particular line, the missed call badge for the selected line gets cleared.

The missed call badge and the actual number of missed calls may be different due to a display limit of 180 calls for the Recents list. This limit consists of outgoing calls, missed calls, and incoming calls. Also, there can be some old missed calls that get added to the count for the missed call badge. This can get overwritten in the Recents list.

Procedure

Step 1 Press **Applications** .

Step 2 Do one of these actions:

- Desk phones: Select a line to view and press **Applications** .
- Conference phones: Press **Settings**.

Step 3 Select **Recents** to access the **Recents** screen.

You can also press **Recents** softkey on the phone home screen. You only see this softkey when your administrator configures it on the phone web interface.

When you press the **Recents** softkey, it directly goes to the **All calls** screen automatically.

Step 4 In the **Recents** screen, choose to view all recent calls, or to view a certain kind of recent calls from the following calls list.

- All calls
- Missed calls
- Received calls
- Placed calls
- Display recents from

To know more on how to view call logs using the **Display recents from** option, see [View Calls Logs from Server](#) , on page 118.

Your administrator configures the **Option**, **Call**, **Edit call**, **Filter**, and **Back** softkeys in this screen for All, Placed, Received, and Missed calls list. When configured, you can see those softkeys when you access any of the menus in the above calls list. The softkeys can also appear as one of the **Option** menus of calls list based on the configuration.



Your administrator enables support to log Webex calls. In the **All calls** screen, if the call is represented by a phone number, you can see **Call** and **Edit call** softkeys. If the call is not represented by a phone number, the phone doesn't show both the softkeys.

Each menu in the above calls list contains **Option** softkey with the following menus.

- Filter - Allows to access **Recents** screen, when pressed.
Availability of this menu depends on your administrator's softkey configuration on the phone web interface.
- Edit call - Enables to edit any call entry details, when pressed.
Availability of this menu depends on your administrator's softkey configuration on the phone web interface.
- Delete entry - Deletes any selected entry, when pressed.
- Delete list - Deletes all the entries in the selected menu, when pressed.
- Sort by name - Sort according to caller names when selected.
- Add contact - Adds a new contact to the directory.

When your administrator enables support to log Webex calls, and in the **All calls** screen, if the call is represented by a phone number, you can see **Add contact** option. If the call is not represented by a phone number, the option menu doesn't contain the **Add contact** option.

Note

- An extra icon  next to the caller id is displayed on the phone indicating a validated call.
When the icon appears in red color, it indicates a missed call.
When you go to the call details of any call, you can view if the call is a missed call or an answered call.
- An extra icon  next to the caller id is displayed on the phone indicating an illegitimate caller.
When the icon appears in red color, it indicates a missed call.
- An extra icon  next to the caller id is displayed on the phone indicating an unverified call.
When the icon appears in red color, it indicates a missed call.

View Webex Call Logs Duration

You can view duration of a received and placed Webex call.

Before you begin

- The phone is onboarded to the Webex cloud server.
- Your administrator adds the **Display recents from** menu on your phone.
- When your administrator enables support to show logs from Webex calls, the **Webex** option is available in the Display recents from menu.

Procedure

Step 1 Press **Applications** .

Step 2 Select **Recents** to access the **Recents** screen.

You can also press **Recents** softkey on the phone home screen. You only see this softkey when your administrator configures it on the phone web interface.

When you press the **Recents** softkey, it directly goes to the **All calls** screen automatically.

Step 3 In the **All calls** screen, select a call log.

When you select a placed call or a received call, you can see the call duration in the **Duration** field. For a missed call, the call duration information is not available.

Spam Indication for Webex Calls

If your phone is registered to Webex server, the phone displays the following icons as verification in call sessions, local call logs, and Webex call logs.

- An extra icon  next to the caller id is displayed on the phone indicating a validated call.



Note Cisco IP Phone 8811 has grayscale screen therefore doesn't support color icons.

When you go to the call details of any call, you can view if the call is a missed call or an answered call.

- An extra icon  next to the caller id is displayed on the phone indicating an illegitimate caller. When the icon appears in red color, it indicates a missed call.

- An extra icon  next to the caller id is displayed on the phone indicating an unverified call. When the icon appears in red color, it indicates a missed call.

View Calls Logs from Server

You can view a separate list for the BroadWorks XSI server call logs, for the local call logs, and for the logs from Webex cloud server depending on your selection.

The phone does a reverse name lookup against local personal directory when the user navigates the BroadWorks call log on the phone.

Before you begin

Your administrator adds the **Display recents from** menu on your phone.

When your administrator enables support to show logs from Webex calls, the **Webex** option is available in the **Display recents from** menu.

Procedure

Step 1 Select a line to view.

Step 2 Press **Applications** .

- Step 3** Select **Recents**.
- Step 4** Select **Display recents from** and choose one of the options.
- **XSI Server**: Displays call logs stored on and transferred from the server.
 - **Phone**: Displays call logs stored on the phone.
 - **Webex**: Displays call logs stored in the Webex cloud server.
- Step 5** Click **Set**.
- You can view all calls, missed calls, received calls, and placed calls list.
-



Return a recent call

Procedure

- Step 1** Do one of the following actions:
- Desk phones—Press **Applications** .
 - Conference phones—Press **Settings**.
- Step 2** Press **Recents**.
- Step 3** Select the call record that you want to dial.
- Step 4** (Optional) Press **Edit call** to edit the call record.
- Step 5** Press the required line button or press **Call** to place the call.
-

Clear the recent calls list

Procedure

- Step 1** Select a line to view.
- Step 2** Press **Applications** .
- Step 3** Do one of the following actions:
- Desk phones—Press **Applications** .
 - Conference phones—Press **Settings**.
- Step 4** Select **Recents**.
- Step 5** Select a list that you want to delete.
- All Calls
 - Missed Calls

- Received Calls
- Placed Calls
- Display recents from

Step 6 Press **Option** and select **Delete all**.

Step 7 Press **OK**.

Create a Contact from a Recents Record

Procedure

Step 1 Select a line to view.

Step 2 Press **Applications** .

Step 3 Select **Recents**.

Step 4 Select a list item.

- All Calls
- Missed Calls
- Received Calls
- Placed Calls
- Display recents from

To view calls in the **Display recents from** option, see [View Calls Logs from Server](#), on page 118.

Step 5 Highlight the individual record that you want to add.

Step 6 Press **Option**.

Step 7 Press **Add contact**.

The menu label shows the target directory to which you want to add the contact:

- If the menu **Add personal address entry** displays, you add the contact to the local personal address book.
- If the menu **Add BroadSoft personal contact** displays, you add the contact to the BroadSoft Personal directory.



Your administrator can change the target directory.

Step 8 Press **Save** to add the contact.

In the **Add BroadSoft personal contact** screen, when contact details fields are empty or you enter invalid values to the fields, you don't see the **Save** softkey.

Delete a call record

Procedure

- Step 1** Press **Applications** .
- Step 2** Do one of the following actions:
- Desk phones—Press **Applications** .
 - Conference phones—Press **Settings**.
- Step 3** Select **Recents**.
- Step 4** Choose to view all recent calls, or to view a certain kind of recent call.
- All Calls
 - Missed Calls
 - Received Calls
 - Placed Calls
 - Display recents from
- Step 5** Highlight the individual record or call group that you want to delete.
- Step 6** Press **Option**.
- Step 7** Select **Delete entry**.
- Step 8** Press **OK**.

Note For more information, refer to [6800](#), [7800](#), [8800](#), [7832](#), and [8832](#) Multiplatform Phones User Guides.

Delete All Call Records

You can delete all call history records on your phone.

Procedure

- Step 1** Press **Applications** .
- Step 2** Select **Recents**.
- Step 3** Select **All calls**.
- Step 4** Press **Option** and select **Delete all**.
- Step 5** Press **OK**.
-



CHAPTER 5

Voicemail

- [Your Personal Voicemail Account](#), on page 123
- [Find out if you have new voicemail messages Your Personal](#) , on page 124
- [Access Your Personal your voicemail](#), on page 124
- [Access Your Personal Audio Voicemail](#), on page 124
- [Voice Messages States of Monitored Voicemail Accounts](#), on page 125

Your Personal Voicemail Account

You can access your personal voice messages directly from your phone. But your administrator must set up your voicemail account, and may also set up your phone to access the voicemail system.

The **Messages**  button or the **Messages** softkey on your phone acts as a speed dial into the voicemail system.

When you aren't at your desk, you can call your voicemail system to access your voicemail. Your administrator can give you the voicemail system phone number.

Because each voicemail system is different, we can't tell you how to use your voicemail system. For information about your voicemail commands, see the voicemail system user documentation or contact your administrator.

Set up Voicemail on Your Phone

If your administrator has not set up your personal voicemail phone number on your phone, you can set it up yourself.

Procedure

- Step 1** Press **Applications** .
 - Step 2** Select **User preferences** > **Call preferences**.
 - Step 3** Enter your personal voicemail phone number in **Voice mail**.
 - Step 4** Press **Set**.
-

Find out if you have new voicemail messages Your Personal

To find out if you have new voicemail messages, look for one of these signs:

- The light strip on your handset is solid red.
- The number of missed calls and voicemail messages is displayed on your screen. If you have more than 99 new messages, a plus (+) sign is displayed.
- An exclamation mark (!) indicates urgent voicemail messages.

Cisco IP Phone 6800 Series, 7800 Series, and 8800 Series: You will also hear a stutter tone played from your handset, headset, or speakerphone when you use a phone line. This stutter tone is line-specific. You only hear it when you use a line that has voice messages.

Cisco IP Conference Phone 7832 and 8832: You will hear a stutter tone played from the speakerphone when you use the phone line. You only hear it when the line has a voice message.

Access Your Personal your voicemail

Procedure

Step 1 Press **Messages**  or **Messages**.

Step 2 Do one of the following actions:

- 6800: Press **Messages**  or **Messages**.
- 7800 and 8800: Press **Messages** .
- 7832 and 8832: Press **Messages**.

Step 3 Follow the voice prompts.

Note For details on voicemail features and PIN rules, see [Set up and manage your voicemail](#).

Access Your Personal Audio Voicemail

Depending upon how your administrator has set up your phone, you can retrieve your personal voicemail without viewing a list of messages. This option is useful if you prefer a list of voicemail messages, but you occasionally access your messages without the visual prompts.

Procedure

Step 1 In the screen, press the **Audio** softkey.

Step 2 When prompted, enter your voicemail credentials.

Voice Messages States of Monitored Voicemail Accounts





You can see the voicemail messages state of a voicemail account of a user or group on a line key or on an expansion module button.

The scope of the monitored voicemail account:

- an extension-associated voicemail account that is configured on the phone
- a voicemail account that is different from any extension-associated voicemail account

To check if your SIP proxy provides the support, contact your administrator.

A monitored voicemail account displays one of these icons beside the line key or expansion module button:

- : There are no voicemail messages for the monitored account.
- : There are new voicemail messages. The number of messages displays adjacent to the name of the monitored account. For example, (4) VM 3300 shows there are four voicemail messages for the monitored account VM 3300.
- !: The new voicemail messages contain at least one urgent message.
- : The line failed to register to the voicemail server.

The line button LED also changes color to indicate the state of the monitored line. The default LED color and pattern for the states are:

- No message: solid green
- New messages: solid red
- Urgent messages: solid red
- Registration Failed: solid amber

To customize the LED behaviour, contact your administrator.

Access Monitored Voicemail Account Messages

Before you begin

- Your administrator must configure either a line key on the phone or an expansion module button to monitor a voicemail account.
- Your administrator must assign speed dial to the configured key.
- There are new messages for the monitored voicemail account.

Procedure

- Step 1** Press the line key on the phone or the expansion module button.
You may be prompted to enter the monitored voicemail account ID and PIN.
- Step 2** Follow the voice prompts.
-



CHAPTER 6

Settings

- [Phone Settings Overview](#), on page 127
- [Settings Overview](#), on page 127
- [User Preferences Menu](#), on page 128
- [Wi-Fi Settings](#), on page 136
- [HTTP Proxy Settings](#), on page 146
- [VPN Connection Settings](#), on page 149
- [Executive Settings](#), on page 153
- [Executive Assistant Settings](#), on page 157
- [Device Administration Settings](#), on page 162
- [Phone Web Page Preferences](#), on page 165

Phone Settings Overview

Your administrator can configure the phone to make the setting menus available on the phone screen or on the phone web interface. If you can't find a specific menu, contact your administrator.

Settings Overview

You can customize your phone in a number of ways:

- From the menus on the phone, accessed from the **Applications**  button. The common settings menus are:
 - User preferences
 - Device administration
- From the phone web page.

User Preferences Menu

You can customize many settings for your phone from the **User preferences** menu. The menu groups settings according to functions.

Call Preferences

The **User preferences > Call preferences** menu allows you to set the way your phone handles calls.

Forward Calls from Your Phone

You can set up your phone to forward incoming calls after navigating to the **Call forward settings** screen.

There are two other methods to set up the call forward services. To set up the call forward services by a specific softkey, see [Forward Calls, on page 74](#). To set up the call forward services from the phone web page, see [Forward Calls with the Phone Web Page, on page 75](#).

Before you begin

Your administrator must enable the call forward services.

Your administrator disables the feature activation code synchronization for call forward. If enabled, the screen **Call forward settings** changes to be ready-only, however you can still change the setting for the Call Forward All service by pressing **Forward** or **Forward all** on the main screen. For more information, see [Activate Call Forward All with Feature Activation Code Synchronization, on page 76](#).

Procedure

-
- Step 1** Press **Applications** .
- Step 2** Select **User preferences > Call preferences > Call forwarding** to access the **Call forward settings** screen.
- Step 3** Select a call forward service.
- **Forward all**—Determines whether to forward all incoming calls to a target phone number.
 - **Forward busy**—Determines whether to forward an incoming call to a target phone number when the line is busy.
 - **Forward no answer**—Determines whether to forward an incoming call to a target phone number when the call isn't answered.
- Step 4** Enable the call forward service by pressing **Select** button of the Navigation cluster.
- Step 5** Assign a target phone number for the call forward service.
- (6821) **Forward all**—Specifies the target phone number to which you want to forward all incoming calls.
 - (6841, 6851, and 6861) **Forward all number**—Specifies the target phone number to which you want to forward all incoming calls.
 - (6821) **Forward busy**—Specifies the target phone number to which you want to forward the incoming call when the line is busy.
 - (6841, 6851, and 6861) **Forward busy number**—Specifies the target phone number to which you want to forward the incoming call when the line is busy.

- (6821) **Forward no answer**—Specifies the target phone number to which you want to forward the coming call when the call isn't answered.
- (6841, 6851, and 6861) **Fwd no answer number**—Specifies the target phone number to which you want to forward the coming call when the call isn't answered.
- (all models) **Fwd no answer delay**—Assigns a response delay time for the no answer scenario.

- Note**
- If your administrator disables the feature key synchronization (FKS) and XSI sync for call forward on your phone, you can enter the value as number of seconds after which call needs to be forwarded.
 - If your administrator enables FKS or XSI sync for call forward on your phone, you can enter the value as number of rings after which call needs to be forwarded.

The call forward settings on the phone take effect only when FKS and XSI are disabled. For more information, consult your administrator.

Step 6 (Optional) Assign a target phone number by using the **Contacts** softkey.

- a) In the **Call forward settings** screen, select any of the call forward service.
- b) Select **Forward all number**, **Forward busy number**, or **Fwd no answer number** based on the call forward service that you selected, then press the **Contacts** softkey.

For 6821, the service names are **Forward all**, **Forward busy**, and **Forward no answer**.

- c) Search for a contact. For more information, see [Search for a Contact in the All Directories Screen, on page 91](#).
- d) Press **Call** to assign the target phone number.
You can find that the target phone number displays next to the call forward service.

Step 7 Press **Set** to apply the settings.

Step 8 Verify if the setting takes effect by looking for the call forward  icon. The icon displays with a target number on the top left or middle of the phone screen.

After you enable any of the call forward services, the **Forward** or **Forward all** softkey changes to the **Clr fwd** or **Clf fwd all** respectively. You can press the softkey to disable the call forward service or services, while the target phone number still remains.

Clf fwd all disables only the Call Forward All service, **Clf fwd** disables all call forward services.

If the call forward settings on the phone don't take effect, consult your administrator.

Set up Voicemail on Your Phone

If your administrator has not set up your personal voicemail phone number on your phone, you can set it up yourself.

Procedure

Step 1 Press **Applications** .

Step 2 Select **User preferences > Call preferences**.

- Step 3** Enter your personal voicemail phone number in **Voice mail**.
- Step 4** Press **Set**.
-

Block Caller ID

You can block your caller identification to prevent your name and phone number from being displayed on the receiver's screen when you make a call. This feature helps you to maintain privacy.

Before you begin

Your administrator enables Block CID feature on your phone.

Your administrator enables Block CID feature on the XSI BroadWorks server.

Procedure

- Step 1** Press **Applications** .
- Step 2** Select **User preferences** > **Call preferences**.
- Step 3** Select **Block caller ID**.
- Step 4** Press **Select** to toggle caller ID blocking on or off.

If your administrator enables the block caller ID feature on the XSI BroadWorks server, your phone retrieves the value from the server and you see the value that your administrator sets on the server. You can then modify the value from the **Block caller ID** menu on the phone.

- Step 5** Press **Set** to save the change.
-

Block an Anonymous Call

You can block an incoming call that does not have caller information for a specific line or all lines.

If your administrator has enabled synchronization of Anonymous Call Rejection between a line and a BroadSoft XSI service, then your setting only applies to the specific line instead of all lines. Typically, the setting applies to all the lines, except for the ones where the synchronization is enabled.

Procedure

- Step 1** Press the Navigation cluster up or down to select a phone line.
- Step 2** Press **Applications** .
- Step 3** Select **User preferences** > **Call preferences** > **Block anonymous call**.
- Step 4** Select **On** if you want to block the call that does not have caller information, or select **Off** to allow the call.
- Step 5** Press **Set** to save the setting.
-

Turn on Do Not Disturb for a Specific Line

Set do not disturb (DND) to silence your phone and suppress incoming call notifications when you need to avoid distractions. You can suppress all incoming call notifications or you can suppress a specific caller notification.

Procedure

- Step 1** Select a phone line using the Navigation cluster.
 - Step 2** Press **Applications** .
 - Step 3** Select **User preferences** > **Call preferences** > **Do not disturb**.
 - Step 4** Select **On** to turn on DND or select **Off** to turn off DND.
 - Step 5** Press **Set** to save the setting.
-

Control the Call Waiting Tone

When you are talking with someone and get another call, you can set the phone to give a call waiting tone.

Procedure

- Step 1** Press **Applications** .
 - Step 2** Select **User preferences** > **Call preferences** > **Call waiting**.
 - Step 3** Press **On** you want the call waiting tone, or press **Off** if you don't want the call waiting tone.
 - Step 4** Select **Set** to apply the changes.
-

Secure a Call

You can encrypt calls to protect them from eavesdroppers. You can set up the secure call feature on all outbound calls or for a specific call.

Procedure

- Step 1** Press **Applications** .
 - Step 2** Select **User preferences** > **Call preferences** > **Secure call**.
 - Step 3** Select **On** to enable secure call feature or select **Off** to disable the secure call feature.
 - Step 4** Press **Set** to save the setting.
-

Set Up an Auto Answer Page

Procedure

- Step 1** Press **Applications** .
 - Step 2** Select **User preferences** > **Call preferences** > **Auto answer page**.
 - Step 3** Select **On** to enable the Auto answer page or select **Off** to disable Auto answer page.
 - Step 4** Press **Set** to save the changes.
-

Enable the Missed Call Shortcut

When you turn on the Missed call shortcut, you can use **Call rtn** softkey to call the person whose call you missed.

Procedure

- Step 1** Press **Applications** .
 - Step 2** Select **User preferences** > **Call preferences** > **Missed call shortcut**.
 - Step 3** Press **On** if you want to the shortcut, or press **Off** if you don't want the shortcut.
 - Step 4** Select **Set** to apply the changes.
-

Add Multiple Locations for a BroadWorks XSI User

You can add multiple locations to your phone extension. This allows an incoming call to seamlessly be moved from your phone to other mobile phones or desk phones that are added to your extension.

Before you begin

Your administrator has enabled the Anywhere feature on the extension.

Procedure

- Step 1** Press **Applications** .
 - Step 2** Select **User preferences** > **Call preferences**.
 - Step 3** Select **Anywhere**.
 - Step 4** (Optional) Select a line if BroadWorks Anywhere is configured on multiple lines.
 - Step 5** Add contact number and name in the **Locations** screen.
- Maximum length of a name that you can enter is 25. You can also keep the **Name** field empty.
- Maximum length of a number that you can enter is 20.

- Step 6** Enable or disable the location.
- Step 7** Press **Save** to add the locations to the **Locations** list.
-

Enable Call Waiting

You can enable call waiting for a specific line or all lines. If enabled, you can receive the call notification (a single beep and the line button flashes red) while on an active call.

If your administrator has enabled synchronization of Call Waiting between a line and a BroadSoft XSI service, then your setting only applies to the specific line instead of all lines. Typically, the setting applies to all lines, except for the ones where the synchronization is enabled.

Procedure

- Step 1** Press the Navigation cluster up or down to select a phone line.
- Step 2** Press **Applications** .
- Step 3** Select **User preferences > Call preferences > Call waiting**.
- Step 4** Select **On** to allow you to answer an incoming call that rings while on another call, or select **Off** to disable the function.
- Step 5** Press **Set** to save the setting.
-

Audio Preferences

The **User preferences > Audio preferences** menu allows you to customize ringtones and how you prefer to answer calls.

Specify an Audio Device for a Call

You can connect an analog headset and a USB headset simultaneously to your phone. However, you can use only one headset at time.

When you connect multiple headsets to the phone, you can choose the audio device to use for a call. Your choice applies when you place or answer a call with a line key or the corresponding softkey.

Procedure

- Step 1** Press **Applications** .
- Step 2** Select **User preferences > Audio preferences > Preferred audio device**.
- Step 3** Press **Select** to choose one of the options:
- **None**—Selects the last used audio device.
 - **Speaker**—Selects the speakerphone as the audio device.
 - **Headset**—Selects a headset as the audio device.

Step 4 Press **Set** to save the selection.

Change the Ringtone

You can set a ringtone for an incoming call.

Procedure

- Step 1** Press **Applications** .
- Step 2** Select **User preferences > Ringtone > Ext (n) - Ring tone**, where n= extension number.
- Step 3** Scroll through the list of ringtones and press **Play** to hear a sample.
- Step 4** Press **Select** and then **Set** to save a selection.
-

Screen Preferences

The **User preferences > Screen preferences** menu allows you to set your phone screen display options.

Change the Screen Saver

You can enable your phone screen saver, and specify its appearance and the amount of time for the phone to be idle before the screen saver appears.

Procedure

- Step 1** Press **Applications** .
- Step 2** Select **User preferences > Screen preferences > Screen saver**.
- Step 3** Select **On** to turn on screen saver and select **Off** to turn it off.
- Step 4** Select **Screen saver settings** to choose the settings:
- **Screen saver type**—Choose one of the following options:
 - **Clock**—Displays a rounded clock with the wallpaper in the background.
 - **Download Picture**—Displays a picture pushed from the phone web page.
 - **Logo**: Displays a logo as the phone screensaver. This image is added in the Logo URL field of the phone web page.
 - **Trigger interval**—Enter the number of seconds that the phone remains idle before the screen saver turns on.
 - **Refresh interval**—Enter the number of seconds before the screen saver should refresh (if, for example, you chose a rotation of pictures).

Step 5 Press **Set**.

Set the Backlight Timer

You can adjust the length of time that the phone screen is bright before it automatically dims.

Procedure

- Step 1** Press **Applications** .
- Step 2** Select **User preferences > Screen preferences > Backlight timer**.
- Step 3** Press **Select** to scroll through the list and select a duration for which the backlight remains on:
- 10 seconds
 - 20 seconds
 - 30 seconds
 - Always On
 - Off
- Step 4** Press **Set** to apply the selection.
-

Adjust the Phone Screen Brightness or Contrast

Procedure

- Step 1** Press **Applications** .
- Step 2** Select **User preferences > Screen preferences**, then select **Contrast level** or **Display brightness** (For 6871 only).
- Step 3** Press the Navigation cluster up or down to increase or decrease the contrast or brightness.
- Step 4** Press **Save**.
-

Set the phone wallpaper

You can select the wallpaper (background) for the phone screen.

Procedure

- Step 1** Press **Applications** .
- Step 2** Select **User preferences > Screen preferences > Wallpaper**.

Step 3 Press **Select** to scroll through the list and select a wallpaper.

Step 4 Press **Set** to apply the selection.

Attendant Console Preferences

The **User preferences > Attendant console preferences** menu allows you to customize how calls display.

Change the Display Mode

Procedure

Step 1 Press **Applications** .

Step 2 Select **User preferences > Attendant console preferences > Display mode**.

The following options are available:

- **Name**
- **Ext**
- **Both**

Step 3 Choose the display mode and press **Set**.

Wi-Fi Settings

Wi-Fi settings are available only on Cisco IP phone 6861 Multiplatform Phones.

You can customize Wi-Fi settings for your phone from the **Wi-Fi configuration** menu under the **Network configuration** menu on the phone. Some of the Wi-Fi settings are also available on the phone web page.

Connect the Phone to a Wireless Network at the First Boot

The phone automatically scans for available Wi-Fi networks in any of the following situations:

- when the phone first boots up without a network connection.
- when the phone isn't connected to a network after a factory reset.

A list of available Wi-Fi networks is displayed after the Wi-Fi scan process completes.

Procedure

Step 1 Select a Wi-Fi network from the list.

You see the following options:

- **Scan**—The phone scans again for available networks.
- **Setup**—Opens the **Setup Wi-Fi** page.
- **Skip**—You see the message *If you skip this step, you will need to configure the network manually.* If you confirm to skip the **Connect to Wi-Fi** page, the **Wi-Fi Scan** softkey displays.

Step 2 Press **Setup** and complete the fields.

Step 3 Press **Connect**.

Trigger Wi-Fi Scan with Softkey

You can use the **Wi-Fi Scan** softkey to scan for available wireless networks. The softkey displays on the phone screen in any of the following situations:

- when you skip the Wi-Fi connection at the first boot with no wired network connection
- whenever the phone loses network connection and the phone Wi-Fi is turned on



Note The **Wi-Fi Scan** softkey doesn't display if **Wi-Fi type** is set to **WPS**.

Procedure

- Step 1** Press the **Wi-Fi Scan** softkey when it displays on the phone screen. The message *Wireless scan in progress* displays. After the scan completes, a list of networks is displayed. You see the following options:
- **Scan**—Scans again for available networks.
 - **Select**—Opens the **Setup Wi-Fi** page.
 - **Cancel**—Closes the network list.
- Step 2** Select a Wi-Fi network from the list.
- Step 3** Press **Select** and complete the fields.
- Step 4** (Optional) Press **Save** to save the setups as a Wi-Fi profile. You can connect to this network later with the profile.
- Step 5** Press **Connect**.
-

Turn the Wi-Fi On or Off from Your phone

You can enable or disable the wireless LAN of your phone from the **Wi-Fi configuration** menu. By default, the wireless LAN on your phone is enabled.

Procedure

- Step 1** Press **Applications** .
- Step 2** Select **Network configuration** > **Wi-Fi configuration** > **Wi-Fi** .
- Step 3** Press the **Select** button, to turn the Wi-Fi on or off.
- Step 4** Press **Set** to save the changes.
-

Turn the Wi-Fi On or Off from the Phone Web Page

You can enable or disable the wireless LAN of your phone from the phone web page. You turn on the Wi-Fi so that the phone connects to a wireless network automatically or manually. By default, the wireless LAN on your phone is enabled.

Procedure

- Step 1** On the phone web page, select **User Login** > **Advanced** > **Voice** > **System**.
- Step 2** Go to the **Wi-Fi Settings** section and set the **Phone-wifi-on** field to **Yes**.
- Step 3** Click **Submit All Changes**.
-

Connect the Phone to a Wi-Fi Manually

When you set up a Wi-Fi profile, it provides you the options to connect the phone manually to a wireless network. You can establish the connection from the **Wi-Fi profile** screen or from the **Setup Wi-Fi** screen.

The top most Wi-Fi profile in the **Wi-Fi profile** screen gets connected automatically when the phone provisions.

Before you begin

- Turn on the Wi-Fi of your phone.
- Disconnect your phone with the wired network.

Procedure

- Step 1** Press **Applications** .
- Step 2** Select **Network configuration** > **Wi-Fi configuration** > **Wi-Fi profile**.

- Step 3** In the **Wi-Fi profile** screen, do any of the actions to connect to Wi-Fi.
- Select any of the configured Wi-Fi profile and click **Connect**.
 - Press **Scan** and select one wireless in the **Connect to Wi-Fi** screen. In the **Setup Wi-Fi** screen, enter values in the fields and press **Connect**.
- See the **Profile Parameter** table in the [Set Up a Wi-Fi Profile from the Phone, on page 140](#) for the field values.
-

Connect Your Phone to a Wireless Network with WPS

Wi-Fi Protected Setup (WPS) provides an easier way to connect your phone to a wireless network. With WPS, you don't need to enter detailed settings for the access point to connect as you do with the connection through Wi-Fi profile. You can either use the WPS button on your access point or the PIN code to connect to the network through WPS.

The WPS option is available only in the menu on the phone screen. On the phone web page, you can only configure your phone to connect to a wireless network using Wi-Fi profile.

Before you begin

Enable WPS on your access point.

Procedure

- Step 1** Press **Applications** .
- Step 2** Select **Network configuration > Wi-Fi configuration > Wi-Fi type**.
- Step 3** Press the navigation key to switch the Wi-Fi type to **WPS**.
- Step 4** Press **Set**.
Push-button configuration and **PIN configuration** display under **Wi-Fi type**. Follow either one of the following steps to connect to the network.
- Step 5** Connect to the network using the WPS button on your access point.
- a) Select **Push-button configuration**.
 - b) Press the WPS button on your access point.
The button name may vary on your access point.
 - c) Press **Continue** on your phone.
- Step 6** Connect to the network using a PIN code.
- a) Select **PIN configuration**.
An 8-digit PIN code displays on your phone screen.
 - b) Go to the web page of your access point and enter the PIN code.
The procedure of entering PIN code may vary on your access points. See the respective user guide of your access point for more details.
-

Upon either a successful connection or a connection failure, the connection status displays on your phone screen.

Connect to a Wi-Fi Network When Your Phone Displays a Connection Failure Message

If your phone supports Wi-Fi, it provides status information if it doesn't have a network connection when it boots up. You see the message `Verify your internet settings or contact your service provider`.

Before you begin

The phone must not be connected to an Ethernet cable.

Procedure

Step 1 Press **Wi-Fi Scan**.

A list of Wi-Fi networks displays.

Step 2 Press one of these options:

- **Scan**—to scan for networks again.
- **Select**—to configure the highlighted network.

Step 3 Highlight a network from the list.

Step 4 Press **Select**.

Step 5 Select one of the following options:

- **Cancel**—go back to the previous screen.
- **Save**—save the network with the information you input.
- **Connect**—connect to the selected network.

Step 6 Press **Connect**.

Note The steps above also apply if your phone loses its network connection any time after it has booted up, and it's not connected to an Ethernet cable.

Set Up a Wi-Fi Profile from the Phone

You can add maximum of four Wi-Fi profiles. You can use this profile to connect your phone to a Wi-Fi network.

Procedure

- Step 1** Press **Applications** .
- Step 2** Select **Network configuration > Wi-Fi configuration > Wi-Fi profile**.
- Step 3** In the **Wi-Fi profile** screen, move to a row in the list on which you want to set up the profile.
- Step 4** Press the **Select** button.
- You can also press **Options** and then select **Edit**.
- Step 5** In the **Edit profile** screen, set the parameters as mentioned in the **Profile Parameters** table.

Table 15: Profile Parameters

| Parameter | Description |
|---------------|---|
| Security mode | <p>Allows you to select the authentication method that is used to secure access to the Wi-Fi network. Depending on the method you choose, a password, passphrase, or key field appears so that you can provide the credentials that are required to join this Wi-Fi network. Options are:</p> <ul style="list-style-type: none"> • Auto • EAP-FAST • PEAP-GTC • PEAP-MSCHAPV2 • PSK • WEP • None <p>Default: PSK</p> |
| Network name | <p>Allows you to enter a name for the SSIDs. This name displays on the phone. Multiple profiles can have the same network name with different security mode. This name displays on the phone.</p> |
| User ID | <p>Allows you to enter a user ID for the network profile.</p> <p>This field is available when you set the security mode to Auto, EAP-FAST, PEAP-GTC, PEAP-MSCHAPV2. This is a mandatory field and it allows maximum length of 32 alphanumeric characters.</p> |
| Password | <p>Allows you to enter password for the network profile that you create.</p> <p>This field is available when you set the security mode to Auto, EAP-FAST, PEAP-GTC, PEAP-MSCHAPV2. This is a mandatory field and it allows maximum length of 64 alphanumeric characters.</p> |

| Parameter | Description |
|----------------|---|
| WEP key | Allows you to enter password for the network profile that you create. This field is available when you set the security mode to WEP. This is a mandatory field and it allows maximum length of 32 alphanumeric characters. |
| Passphrase | Allows you to enter password for the network profile that you create. You need to enter this value when the security mode is PSK. |
| Frequency band | Allows you to select the wireless signal frequency band that is used in the WLAN. Options are: <ul style="list-style-type: none"> • Auto • 2.4 GHz • 5 GHz Default: Auto |

Step 6 Press **Save**.

Set Up a Wi-Fi Profile

You can configure a Wi-Fi profile from the phone web page or from remote device profile resync and then associate the profile to the available Wi-Fi networks. You can use this Wi-Fi profile to connect to a Wi-Fi. You can configure maximum of four profiles.

Procedure

- Step 1** On the phone web page, select **User Login > Advanced > Voice > System**.
- Step 2** Set the **Wi-Fi Profile** fields with the information that your administrator provided.
- Step 3** Click **Submit All Changes**.

If the phone has an active call, you can not save the changes.

Delete a Wi-Fi Profile

You can remove a Wi-Fi profile from the list when the profile is no more required.

Procedure

- Step 1** Press **Applications** .

- Step 2** Select **Network configuration > Wi-Fi configuration > Wi-Fi profile**.
- Step 3** In the **Wi-Fi profile** screen, select the Wi-Fi profile that you want to remove.
- Step 4** Press **Options**.
- Step 5** Select **Delete** and then confirm the deletion.
-

Change the Order of a Wi-Fi Profile

You can determine the position of a Wi-Fi profile in the list. The Wi-Fi profile at the top of the list has the highest priority. When the Wi-Fi is turned on, the phone uses the Wi-Fi profile on the top of the list to connect automatically to a wireless network while provisioning.

Procedure

- Step 1** If you change the Wi-Fi profile order from the phone, follow these steps:
- Press **Applications** .
 - Select **Network configuration > Wi-Fi configuration > Wi-Fi profile**.
 - In the **Wi-Fi profile screen**, select a Wi-Fi of which you want to change the order.
 - Press **Options**.
 - Select **Move up** or **Move down** to move the Wi-Fi profile one level up or one level down respectively in the list.
- Step 2** If you change the Wi-Fi profile order from the phone web page, follow these steps:
- On the phone web page, select **User Login > Advanced > Voice > System**.
 - In the **Wi-Fi Profile (n)** section, set the **Wi-Fi Profile Order** field to the desired order.
 - Click **Submit All Changes**.
-

Scan and Save a Wi-Fi Network

You can scan a Wi-Fi profile to get the list of available wireless networks (SSID). The security mode and the network name have the same value of the scanned SSID. You can then edit the fields of any of the wireless networks. When you save the changes, it saves as a Wi-Fi profile in the phone Wi-Fi profile list. You can then use this new Wi-Fi profile to connect the phone to a wireless network.



- Note**
- When the security mode of a wireless network is None, PSK, and WEP, you can't modify the security mode. On the **Security mode** screen, you only see the security mode that is set for the network. For example, if the security mode of a network is PSK, you see only PSK in the **Security mode** screen.
 - When you scan a wireless network (SSID) which is the current connected wireless, you can't edit the **Network name** of this SSID.
-

Procedure

- Step 1** Press **Applications** .
- Step 2** Select **Network configuration > Wi-Fi configuration > Wi-Fi profile**.
- Step 3** In the **Wi-Fi profile** screen, press **Scan** to get all available wireless networks.
- Step 4** (Optional) In the **Connect to Wi-Fi** screen, press **Scan** again to rescan the list.
- Step 5** Select a wireless and press **Select** or the **Select** button.
- Step 6** In the **Setup Wi-Fi** screen, set the parameters as mentioned in the **Profile Parameters** table.

Table 16: Profile Parameters

| Parameter | Description |
|---------------|---|
| Security mode | <p>Allows you to select the authentication method that is used to secure access to the Wi-Fi network. Depending on the method you choose, a password, passphrase, or key field appears so that you can provide the credentials that are required to join this Wi-Fi network. Options are:</p> <ul style="list-style-type: none"> • Auto • EAP-FAST • PEAP-GTC • PEAP-MSCHAPV2 • PSK • WEP • None <p>Default: PSK</p> |
| Network name | <p>Allows you to enter a name for the SSIDs. This name displays on the phone. Multiple profiles can have the same network name with different security mode. This name displays on the phone.</p> |
| User ID | <p>Allows you to enter a user ID for the network profile.</p> <p>This field is available when you set the security mode to Auto, EAP-FAST, PEAP-GTC, PEAP-MSCHAPV2. This is a mandatory field and it allows maximum length of 32 alphanumeric characters.</p> |
| Password | <p>Allows you to enter password for the network profile that you create.</p> <p>This field is available when you set the security mode to Auto, EAP-FAST, PEAP-GTC, PEAP-MSCHAPV2. This is a mandatory field and it allows maximum length of 64 alphanumeric characters.</p> |

| Parameter | Description |
|----------------|--|
| WEP key | Allows you to enter password for the network profile that you create. This field is available when you set the security mode to WEP. This is a mandatory field and it allows maximum length of 32 alphanumeric characters. |
| Passphrase | Allows you to enter password for the network profile that you create. You need to enter this value when the security mode is PSK. |
| Frequency band | Allows you to select the wireless signal frequency band that is used in the WLAN. Options are: <ul style="list-style-type: none"> • Auto • 2.4 GHz • 5 GHz Default: Auto |

Step 7 Press **Save**.

View the Wi-Fi Status

You may experience issues related to Wi-Fi connection. You can gather information from the **Wi-Fi status** page to help your administrator troubleshoot.

You can also view the status from the phone web page by selecting **User Login > Advanced > Info > Status > System Information**.

Procedure

Step 1 Press **Applications** .

Step 2 Select **Network configuration > Wi-Fi configuration > Wi-Fi status**.

You see the information:

- **Wi-Fi status:** Displays if the Wi-Fi is connected or disconnected.
- **Network name:** Indicates the name of the SSID.
- **Signal strength:** Indicates strength of the network signal.
- **MAC address:** Indicates MAC address of the phone.
- **AP MAC address:** Indicates MAC address of the access point (SSID).
- **Channel:** Indicated the channel on which the Wi-Fi network transmits and receives data.
- **Frequency:** Indicates the wireless signal frequency band that is used in the Wireless LAN.

- **Security mode:** Indicates the security mode that is set for the wireless LAN.
-

View Wi-Fi Status Messages on the Phone

You can view messages about the Wi-Fi connection status of your phone. The messages can help you diagnose Wi-Fi connection problems. The messages contain:

- connection time and MAC address of the AP
- disconnection time and diagnostic code
- connection failure time
- time that weak signal of the AP continues over 12 seconds
- the status of firmware memory when the free memory is less than 50K
- the status of losing AP beacon when the phone can't receive signal from the AP
- the status of no response for Wi-Fi authentication or association requests
- the status of TX failure
- the status of WPS connection failure

Procedure

- Step 1** Press **Applications** .
- Step 2** Select **Status > Wi-Fi messages**.
- Step 3** Use the outer ring of the navigation cluster to scroll through the messages.
- Step 4** Press **Details** to view more details of the selected message.
- Step 5** (Optional) Press **Clear** to delete all the messages.
-

HTTP Proxy Settings

You can set up an HTTP proxy on your phone from the **HTTP proxy settings** menu under the **Network configuration** menu. The HTTP proxy settings are also available on the phone web page.

Related Topics

- [Set Up a Proxy Server with the Auto Proxy Mode](#), on page 147
- [Set Up a Proxy Server with the Manual Proxy Mode](#), on page 147
- [Set Up a Proxy Server from the Phone Web Page](#), on page 148

Set Up a Proxy Server with the Auto Proxy Mode

You can choose the auto proxy mode to set up an HTTP proxy server on the phone.

Procedure

- Step 1** Press **Applications** .
- Step 2** Select **Network configuration > HTTP proxy settings > Proxy mode**.
- Step 3** Press the **Select** button of the navigation cluster to choose **Auto**.
- Step 4** Highlight **Auto discovery (WPAD)**, select **On** to turn on Web Proxy Auto-Discovery (WPAD) that is used to retrieve a PAC file automatically, select **Off** to turn off WPAD.
- By default, your phone uses WPAD in the auto proxy mode.
- Step 5** (Optional) If you turn off WPAD in the previous step, you need to further enter a valid Proxy Auto-Configuration (PAC) URL in **PAC URL**. For example:
- ```
http://proxy.department.branch.example.com/pac
```
- If you don't have the PAC URL, contact your administrator.
- Step 6** Press **Set** to apply the settings.
- 

## Set Up a Proxy Server with the Manual Proxy Mode

You can choose the manual proxy mode to set up an HTTP proxy server on the phone.

### Before you begin

Your administrator provides you the server address and port of the proxy server.

### Procedure

---

- Step 1** Press **Applications** .
- Step 2** Select **Network configuration > HTTP proxy settings > Proxy mode**.
- Step 3** Press the **Select** button of the navigation cluster to choose **Manual**.
- Step 4** Enter a valid hostname or IP address of a proxy server in **Proxy host**.
- Note** Do not provide the scheme (`http://` or `https://`) for the proxy host.
- Step 5** Enter a valid server port of the specified proxy server in **Proxy port**.
- Step 6** (Optional) If your proxy server requires authentication, highlight **Proxy authentication** and then select **On**.
- Step 7** (Optional) Enter your username and password to access the proxy server.
- If you don't have the username and password, contact your administrator.

**Step 8** Press **Set** to apply the settings.

## Set Up a Proxy Server from the Phone Web Page

You can choose the auto or manual proxy mode to set up an HTTP proxy server from the phone web page.

### Procedure

**Step 1** On the phone web page, select **Voice > System**.

**Step 2** Under the section **HTTP Proxy Settings**, set the parameters described in the following table:

*Table 17: HTTP Proxy Settings*

| Parameter                 | Description                                                                                                                                                                                                                                                                                                                  |
|---------------------------|------------------------------------------------------------------------------------------------------------------------------------------------------------------------------------------------------------------------------------------------------------------------------------------------------------------------------|
| Proxy Mode                | Choose the proxy mode for the HTTP proxy setting.<br>Options are: <ul style="list-style-type: none"> <li>• Auto</li> <li>• Manual</li> <li>• Off</li> </ul> Default: Off                                                                                                                                                     |
| Use Auto Discovery (WPAD) | Select <b>Yes</b> to use the Web Proxy Auto-Discovery (WPAD) mechanism to automatically retrieve a Proxy Auto-Configuration (PAC) file.<br><br>If the parameter is set to <b>No</b> , you must configure <b>PAC URL</b> .<br><br>This parameter is available when you set <b>Proxy Mode</b> to <b>Auto</b> .<br>Default: Yes |
| PAC URL                   | URL locating the PAC file.<br><br>This parameter is available when you set <b>Proxy Mode</b> to <b>Auto</b> and <b>Use Auto Discovery (WPAD)</b> to <b>No</b> .                                                                                                                                                              |
| Proxy Host                | Server address (hostname or IP address) of the proxy server.<br><br>Do not provide the scheme ( <code>http://</code> or <code>https://</code> ).<br><br>This parameter is available when you set <b>Proxy Mode</b> to <b>Manual</b> .                                                                                        |

| Parameter                            | Description                                                                                                                                                                                                                                                       |
|--------------------------------------|-------------------------------------------------------------------------------------------------------------------------------------------------------------------------------------------------------------------------------------------------------------------|
| Proxy Port                           | Port number of the proxy server.<br>This parameter is available when you set <b>Proxy Mode</b> to <b>Manual</b> .                                                                                                                                                 |
| Proxy Server Requires Authentication | If your proxy server requires authentication, select <b>Yes</b> . Otherwise, select <b>No</b> . The parameter configuration depends on the actual behaviour of the proxy server.<br>This parameter is available when you set <b>Proxy Mode</b> to <b>Manual</b> . |
| Username                             | Enter a username of a credential user on the proxy server.<br>This parameter is available when you set <b>Proxy Mode</b> to <b>Manual</b> and <b>Proxy Server Requires Authentication</b> to <b>Yes</b> .                                                         |
| Password                             | Enter a password of the specified username for the proxy authentication purpose.<br>This parameter is available when you set <b>Proxy Mode</b> to <b>Manual</b> and <b>Proxy Server Requires Authentication</b> to <b>Yes</b> .                                   |

**Step 3** Click **Submit All Changes**.

## VPN Connection Settings

You can set up and enable a VPN connection on your phone from the **VPN settings** menu under the **Network configuration** menu. To facilitate the settings, you can also configure the VPN settings related parameters on the phone web page. If you want to enable the VPN connection, you need to reboot the phone.

Cisco IP Phone 6821 Multiplatform Phones doesn't support VPN connection.

### Related Topics

[Set Up a VPN Connection](#), on page 150

[Enable a VPN Connection](#), on page 150

[Disable a VPN Connection](#), on page 151

[Set Up a VPN Connection from the Phone Web Page](#), on page 152

[View the VPN Status](#), on page 152

## Set Up a VPN Connection

You can set up a VPN connection on your phone. After you perform the procedure described in this topic, only the VPN settings are finished. You still need to enable the VPN connection by rebooting the phone in a manual or automatic way.

If you want to set up the VPN connection from the phone web page, see [Set Up a VPN Connection from the Phone Web Page, on page 152](#).

Cisco IP Phone 6821 Multiplatform Phones doesn't support VPN connection.

### Before you begin

Your administrator provides the necessary information that is required to establish a VPN connection.

### Procedure

---

- Step 1** Press **Applications** .
- Step 2** Select **Network configuration > VPN settings**.
- Step 3** Enter the IP address or FQDN of a VPN server in **VPN server**.
- Step 4** Enter the user credentials in **Username** and **Password**.
- Step 5** (Optional) If needed, enter the name of a tunnel group in **Tunnel group**.  
If the field is empty, this means no tunnel group is used for this VPN connection.
- Step 6** Highlight **Connect to VPN on bootup**, press the **Select** button of the navigation cluster to select **On**.
- Step 7** Press **Set** to save the settings.
- The VPN settings are finished. For information about how to enable the VPN connection, see [Enable a VPN Connection, on page 150](#).
- 

## Enable a VPN Connection

You can enable a configured VPN connection by rebooting your phone automatically. If you want to manually reboot your phone to enable the VPN connection, see [Reboot Your Phone, on page 165](#).

### Before you begin

The VPN settings are finished. For details, see [Set Up a VPN Connection , on page 150](#) or [Set Up a VPN Connection from the Phone Web Page, on page 152](#).

### Procedure

---

- Step 1** Press **Applications** .
- Step 2** Select **Network configuration > VPN settings**.

**Step 3** Highlight **Enable VPN connection**, press the **Select** button of the navigation cluster to select **On** to apply the changes.

**Note** Once you set **Enable VPN connection** to **On**, the phone immediately tries to connect to the VPN server. During the process, the phone reboots automatically.

The VPN connection takes about one minute.

After your phone reboots, the VPN connection icon  on the upper-right corner of the phone screen indicates that the VPN connection is established successfully.

If the VPN connection fails, the value of **Enable VPN connection** remains **Off**.

**Step 4** (Optional) View the details of the VPN connection. For example, the current VPN connection status and VPN IP address. For details, see [View the VPN Status, on page 152](#).

---

## Disable a VPN Connection

You can disable a VPN connection by rebooting your phone in an automatic or manual way.

### Before you begin

A VPN connection is enabled on your phone.

### Procedure

---

**Step 1** Press **Applications** .

**Step 2** Select **Network configuration > VPN settings**.

**Step 3** Highlight **Connect to VPN on bootup**, press the **Select** button of the navigation cluster to select **Off**.

**Step 4** Press **Set** to save the setting.

**Step 5** Do one of the following actions:

- Highlight **Enable VPN connection**, select **Off**.

**Note** Once you set **Enable VPN connection** to **Off**, the phone immediately tries to disconnect from the VPN server. During the process, the phone reboots automatically.

- Manually reboot your phone, see [Reboot Your Phone, on page 165](#).

The VPN disconnection takes about one minute.

After the phone reboots, the VPN connection icon  on the phone screen disappears. This means that the VPN connection is disabled successfully.

**Step 6** (Optional) Check whether the VPN connection is **Disconnected**. For details, see [View the VPN Status, on page 152](#).

---

## Set Up a VPN Connection from the Phone Web Page

You can set up a VPN connection from the phone web page.

You can do the same configuration on your phone, see [Set Up a VPN Connection](#), on page 150.

Cisco IP Phone 6821 Multiplatform Phones doesn't support VPN connection.

### Procedure

- Step 1** On the phone web page, select **Voice > System**.
- Step 2** Under the section **VPN Settings**, set the parameters described in the following table.

*Table 18: VPN Settings*

| Parameter         | Description                                                                                                                                   |
|-------------------|-----------------------------------------------------------------------------------------------------------------------------------------------|
| VPN Server        | IP address or FQDN of the VPN server.<br>Default: Empty                                                                                       |
| VPN User Name     | Enter a username for a credential user on the VPN server.<br>Default: Empty                                                                   |
| VPN Password      | Enter a password of the specified username to access the VPN server.<br>Default: Empty                                                        |
| VPN Tunnel Group  | Enter a tunnel group assigned to the VPN user.<br>Tunnel group is used to identify the group policy for the VPN connection.<br>Default: Empty |
| Connect on Bootup | Choose whether your phone connects to the VPN server automatically after the phone reboots.<br>Default: No                                    |

- Step 3** Click **Submit All Changes** to save the changes.
- The VPN settings are finished. For information about how to enable the VPN connection, see [Enable a VPN Connection](#), on page 150.

## View the VPN Status

You can check the details of the VPN connection. For example, the current VPN status and VPN IP address of your phone.

You can also view the status from the phone web page by selecting **Info > Status > VPN Status**.

### Procedure

---

**Step 1** Press **Applications** .

**Step 2** Select **Status > VPN status**.

You can view the following information:

- **VPN connection**—Indicates whether the phone connects to the VPN server. The status can be either *Connected* or *Disconnected*.
  - **VPN IP address**—VPN IP address assigned from the VPN server.
  - **VPN subnet mask**—VPN subnet mask assigned from the VPN server.
  - **Sent bytes**—Total bytes the phone sent out to the network through the VPN server.
  - **Received bytes**—Total bytes the phone received from the network through the VPN server.
- 

## Executive Settings

Executive settings are available only on Cisco IP phone 6871 Multiplatform Phones.

If your administrator has configured you as an executive user with a pool of assistants, you can configure the following settings to share control of your calls with your assistants:

- You can active or deactivate call filtering. If your extension connects to the XSI BroadWorks server, you can also select the call filtering mode and type.

When call filtering is on, your incoming calls go to your assistants according to the criteria configured by your administrator on the BroadWorks server.

You also receive your incoming calls that go to your assistants, if your administrator has enabled call screening for you.

- You can check the Opt-in/Opt-out status of your assistants.

The assistants with the Opt-in status have controls of the executive's calls.



---

**Important** The menu items that display on the phone screen are different in the following scenarios:

- Your administrator enables the feature key synchronization (FKS) on your extension.
  - Your administrator connects your extension to the XSI BroadWorks server.
-

## Activate Call Filtering as an Executive

Perform this task to active call filtering. If your administrator configures your extension to connect to the XSI BroadWorks server, you can also select the call filtering mode and call filtering type.

When call filtering is active, your incoming calls go to your assistants according to the criteria configured by your administrator.

You also receive your incoming calls that go to your assistants, if your administrator has enabled call screening for you. When an assistant answers a call, the call doesn't display on your extension.



---

**Important** If you activate DND on your phone, your assistants do not receive your incoming calls.

---

Dial the service activation code provided by your administrator, or follow the procedure described below to activate call filtering.

### Before you begin

Your administrator gives you executive user privileges.



Your administrator configures and enables the call filtering criteria on the XSI BroadWorks server.

### Procedure

---

**Step 1** Do one of the following actions:

- If your administrator has programmed the **Executive** function on a line key, the phone shows the **Executive**  together with the call filtering status (**On** or **Off**) on the main screen. Press the line key.
- If you do not have the **Executive** function that is configured on a line key:

- a. Press **Applications** .
- b. Select **Executive** .

**Step 2** Follow the below procedure according to the actual menus displayed on the phone.

- If your administrator configures your extension to connect to the XSI BroadWorks server:
  - a. Select **Call filter** > **Call filter**.
  - b. Press  to select **On**.
  - c. Select the call filter mode and the call filter type.
    - **Call filter mode**—Choose one of the following options:
      - **Simple**—Your incoming calls go to your assistants according to the call filtering criteria configured in the simple mode.
      - **Advanced**—Your incoming calls go to your assistants according to the call filtering criteria configured in the advanced mode.



- **Call filter type**—Choose one of the following options:

**Note** This menu item is available when the **Call filter mode** is set to **Simple**.

- **All Calls**—All your incoming calls go to your assistants.
  - **Internal Calls**—If you and the callers are in the same BroadSoft group, their incoming calls go to your assistants.
  - **External Calls**—If you and the callers are not in the same BroadSoft group, their incoming calls go to your assistants.
- d. Press **Set** to apply the changes.
- If your administrator only enables the feature key synchronization (FKS) on your extension:
    - a. Press the **On** softkey to activate call filtering.
    - b. Press  to exit.

---

## Deactivate Call Filtering as an Executive

When call filtering is off, none of your incoming calls go to your assistants.



Dial the service activation code provided by your administrator, or follow the procedure described below to deactivate call filtering.



### Before you begin

Your administrator gives you executive user privileges.

### Procedure

---

- Step 1** Do one of the following actions:
- If your administrator has programmed the **Executive** function on a line key, the phone shows the **Executive**  together with the call filtering status (**On** or **Off**) on the main screen. Press the line key.
  - If you do not have the **Executive** function that is configured on a line key:
    - a. Press **Applications** .
    - b. Select **Executive** .
- Step 2** Follow the below procedure according to the actual menus displayed on the phone.
- If your administrator configures your extension to connect to the XSI BroadWorks server:
    - a. Select **Call filter** > **Call filter**

- b. Press  to select **Off**.
  - c. Press **Set** to apply the changes.
- If your administrator only enables the feature key synchronization (FKS) on your extension:
    - a. Press the **Off** softkey to deactivate call filtering.
    - b. Press  to exit.

---

## Check Assistant List as an Executive

You can access the **Assistant List** menu on the phone to check the assistants that have been assigned to you. The menu also shows the Opt-in/Opt-out status of the assigned assistants.

### Before you begin

Your administrator has assigned at least one assistant to you.



Your administrator has configured your extension to connect to the XSI BroadWorks server. Otherwise, the menu **Assistant List** doesn't display on the phone.

Your administrator has enabled alphanumeric dialing. Otherwise, you can't make a call to an assistant from the assistant list.

### Procedure

#### Step 1

Do one of the following actions:

- If your administrator has programmed the **Executive** function on a line key, the phone shows the **Executive**  together with the call filtering status (**On** or **Off**) on the main screen. Press the line key.
- If you do not have the **Executive** function that is configured on a line key:
  - a. Press **Applications** .
  - b. Select **Executive** .

#### Step 2

Select **Assistant List**.

The **Assistant List** screen displays a maximum of 10 assistants on the phone.

If your administrator configures more than one executive on the phone, then the screen only displays the assistants of the first available executive.

#### Step 3

(Optional) If you want to make a call to one of your assistants, then highlight the assistant's phone number, and press **Call**.

---

# Executive Assistant Settings

Executive assistant settings are available only on Cisco IP phone 6871 Multiplatform Phones.

If your administrator has configured you as an executive assistant, you can configure the following settings for shared control of the executives' calls:

- You can view the associated executives.
- You can opt in to or out of an executive's pool of assistants if your administrator has enabled this option for the pool.
- If you have opted in to a pool, when you want someone else to answer calls on behalf of executives instead of you, you can activate call diversion to a number of your choice.

You can deactivate call diversion at any time.

- If you have opted in to a pool, you can activate or deactivate call filtering for an executive.

When call filtering is on, you and other assistants associated with the executive receive the executive's incoming calls according to the criteria configured by your administrator.



---

**Important** The menu items that display on the phone screen are different in the following scenarios:

- Your administrator enables the feature key synchronization (FKS) on your extension.
  - Your administrator connects your extension to the XSI BroadWorks server.
- 

## Check Executive List as an Assistant

You can access the **Executive List** menu on the phone to check the executives that your administrator has assigned to you. The menu also shows your current Opt-in/Opt-out status for the associated executives together with their phone numbers.

### Before you begin



Your administrator gives you the assistant user privileges, and includes you in the executive's pool of assistants.

Your administrator has configured your extension to connect to the XSI BroadWorks server.

### Procedure

---

**Step 1** Do one of the following actions:

- If your administrator has programmed the **Assistant**  function on a line key, press the line key.
- If you do not have the **Assistant**  function on a line key:
  - a. Press **Applications** .

- b. Select **Assistant** .

**Step 2** Select **Executive List**.

The **Executive List** screen displays a maximum of 10 executives on the phone.

If your administrator configures more than one assistant on the phone, then the screen only displays the executives of the first available assistant.

## Opt in to or Out of an Executive's Pool as an Assistant

When you opt in to an executive's pool, you get shared control of the executive's calls.

When you opt out of an executive's pool, you do not have any control of the executive's calls.

If your administrator only enables the feature key synchronization (FSK) on your extension, dial the appropriate service activation code provided by your administrator to opt in to or out of an executive's pool. Skip the below procedure.

If your administrator has configured your extension to connect to the XSI BroadWorks server, you can either dial the appropriate service activation code or follow the procedure described below.



### Before you begin

Your administrator gives you the assistant user privileges and includes you in the executive's pool of assistants.

Your administrator grants you the permission to opt in to or out of the executive's pool.

### Procedure

**Step 1** Do one of the following actions:

- If your administrator has programmed the **Assistant**  function on a line key, press the line key.
- If you do not have the **Assistant**  function on a line key:

- a. Press **Applications** .

- b. Select **Assistant** .

**Step 2** Select **Executive List**.

**Step 3** Select an executive of whose assistant pool that you want to opt in to or out of.

**Step 4** Press  to select **Opt-in** to opt in to the executive's pool or select **Opt-out** to opt out of the executive's pool.

**Step 5** Press **Set** to apply the changes.

## Activate or Deactivate Call Filtering as an Executive Assistant

Access the **Call filter** screen to activate or deactivate call filtering. The screen shows a list of executives associated with all the assistant extensions on the phone together with the call filtering status (**On** or **Off**).

When call filtering is on for an executive, you and other assistants associated with the executive receive the executive's incoming calls according to the criteria configured by your administrator.

When the executive or another assistant answers a call, you no longer see the call on your extension.



---

**Important** Activating or deactivating call filtering for an executive activates or deactivates the setting for all the assistants in the executive's pool.

---

### Before you begin

You are in an executive's pool of assistants.

Your administrator enables the **Call filter** menu item on the phone screen.



### Procedure

---

#### Step 1



Do one of the following actions:

- If your administrator has programmed the **Assistant** function on a line key, press the line key.
- If you do not have the **Assistant** function on a line key:

- a. Press **Applications** .
- b. Select **Assistant** .

#### Step 2

Follow the below procedure according to the actual menus displayed on the phone.

- If your administrator configures your extension to connect to the XSI BroadWorks server:
    - a. Select **Call filter**.
    - b. Highlight an executive, press  to toggle call filtering on or off for the highlighted executive.
    - c. Press **Set**, and then press **OK** to apply the changes.
  - If your administrator only enables the feature key synchronization (FKS) on your extension:
    - a. Highlight the executive for whom you want to activate or deactivate call filtering.
    - b. Press  to toggle call filtering on or off for the highlighted executive.
    - c. Press  to exit.
-

## Activate Call Diversion as an Executive Assistant

Access the **Divert** screen to activate call diversion when you want someone else to receive executives' incoming calls.



---

**Important** If you activate DND on your extension, calls are not diverted.

---

You activate call diversion for an assistant extension. When you activate call diversion for an extension, if you handle multiple executives on that extension, all of the executives' incoming calls are diverted from that extension.

Other assistants in the executives' pool continue to receive executives' incoming calls.

Other assistant extensions on your phone also continue to receive executives' incoming calls.

### Before you begin



You are in an executive's pool of assistants.

### Procedure

---

**Step 1** Do one of the following actions:

- If your administrator has programmed the **Assistant** function on a line key, press the line key.
- If you do not have the **Assistant** function on a line key:

- a. Press **Applications** .
- b. Select **Assistant** .

**Step 2** Follow the below procedure according to the actual menus displayed on the phone.

- If your administrator configures your extension to connect to the XSI BroadWorks server:
  - a. Select **Divert > Divert**.
  - b. Select **On** to activate call diversion.
  - c. Highlight **Divert number** and enter the destination number to which you want the calls to be diverted.
  - d. Press **Set** to apply the changes.
- If your administrator only enables the feature key synchronization (FKS) on your extension:
  - a. Typically, the screen shows a list of all the executives associated with all the assistant extensions on the phone. Select an executive associated with the extension for which you want to activate call diversion.

The extension with which the selected executive is associated appears at the top.
  - b. Press **Divert**.
  - c. Enter the destination number to which you want the calls to be diverted.

- d. Press **Call** to complete the action.
- e. Press  to exit.

---

If your administrator has programmed the **Assistant** function on a line key, the icon in the line key label changes to  to show that call diversion is on.



If you are the only executive assistant with an extension on the phone, the diversion destination number appears under the **Assistant** line key.



## Deactivate Call Diversion as an Executive Assistant

### Before you begin

You are in an executive's pool of assistants, and call diversion is on.

### Procedure

- 
- Step 1** Do one of the following actions:
- If your administrator has programmed the **Assistant** function on a line key, press the line key.
  - If you do not have the **Assistant** function on a line key:
    - a. Press **Applications** .
    - b. Select **Assistant** .
- Step 2** Follow the below procedure according to the actual menus displayed on the phone.
- If your administrator configures your extension to connect to the XSI BroadWorks server:
    - a. Select **Divert > Divert**.
    - b. Select **Off** to deactivate call diversion.
    - c. Press **Set** to apply the change.
  - If your administrator only enables the feature key synchronization (FKS) on your extension:
    - a. Press **Clr divert**.
    - b. Press  to exit.
-

If your administrator has programmed the **Assistant** function on a line key, and call diversion is not on for any other assistant extension on the phone, the icon in the **Assistant** line key label changes back from  to .

## Troubleshooting Executive Assistant Settings

### Calls Fail Although Call Diversion Is On

Ensure that DND is not activated for your extension.

## Device Administration Settings

You can set some other preferences from the phone in the **Device administration** menu.

### Change the Time Format

You can change the current time format that the phone screen displays.

#### Procedure

---

**Step 1** Press **Applications** .

**Step 2** Select **Device administration** > **Date/Time** > **Time format**.

To set daylight savings, select **Device administration** > **Date/Time** > **Daylight savings**. Select **On** to turn on the daylight savings and select **Off** to turn it off.

**Step 3** (Optional) Select **Device administration** > **Date/Time** > **Time zone**.

**Step 4** Select a time format and press **Set** to apply the changes.

---

### Change the Date Format

You can change the date format that you want to see on your phone screen.

#### Procedure

---

**Step 1** Press **Applications** .

**Step 2** Select **Device administration** > **Date/Time** > **Date format**.

**Step 3** Select a date format and press **Set** to apply the changes.

---



## Set Language

Depending upon how your phone is configured, you may be able to change the language used by your phone.

### Procedure

---

- Step 1** Press **Applications** .
- Step 2** Select **Device administration** > **Language**.
- Step 3** Select a language from the list of available languages.
- Step 4** Select **Save**.
- 

## Set up Power Save

You can put your phone into power save mode when your phone is idle. If your phone is not idle, you can't turn power save on and you see a message on the screen.



- Note**
- In power save mode, your phone can't receive incoming calls.
  - The Cisco IP Phone 6821 Multiplatform Phones does not support power save.
- 

When your phone is in power save mode, the screen is not lit and the **Select** button is lit. You press the **Select** button to wake up the phone.

### Procedure

---

- Step 1** Press **Applications** .
- Step 2** Select **Device administration** > **Power save**.
- Step 3** Select **OK**.
- 

## Set Password

Reset your phone password regularly and keep your network secure.

### Before you begin

You must have your password.

### Procedure

---

- Step 1** Press **Applications** .
- Step 2** Select **Device administration** > **Set password**.
- Step 3** Enter your current password in the Old password field.
- Step 4** Enter your new password in the New password and the Reenter new password fields.
- Step 5** Select **Save**.

### Related Topics

[Set Password from Phone Web Page](#), on page 168

## Set up the Profile Account

You need to enter the authentication credentials to resynchronize your phone with the provisioning profile when prompted with the **Profile account setup** screen.

If you missed the **Profile account setup** screen, you can also access it from the phone menu or the **Setup** softkey if available.

If the phone fails to sign in, contact your administrator.

### Before you begin

Your administrator specifies the profile authentication type on your phone and provides you with the authentication credentials.

### Procedure

---

- Step 1** Press **Applications** .
  - Step 2** Select **Device administration** > **Profile account setup**.  
Your username and password are automatically filled. These fields are blank if your username and password were not added before.
  - Step 3** Press **Sign in** to save your username and password.
    - Note** If any of the **Username** field or the **Password** field is empty, the phone displays a grey **Sign in** softkey and you can't press the softkey.
    - If any of the **Username** field or the **Password** field is empty, the **Sign in** softkey doesn't appear. After you enter values in both the fields you see the **Sign in** softkey.
  - Step 4** (Optional) Enter a new username and password if you want to login with another set of credentials.
-

## Reboot Your Phone

You may have to reboot your phone for a software upgrade or other changes to take effect. Your settings or other customizations do not change.

### Procedure

---

- Step 1** Press **Applications** .
- Step 2** Select **Device administration** > **Restart**.
- Step 3** Select **OK** to confirm that you want to reboot your phone.
- 

## Phone Web Page Preferences

You can customize some settings from the phone web pages.

### Related Topics

[Phone Web Page](#), on page 25

## Assign a Ring Tone with the Phone Web Page

### Procedure

---

- Step 1** On the phone web page, select **User Login** > **Voice** > **Ext(n)**, where **(n)** is the number of an extension.
- Step 2** In **Call Feature Settings** area, choose a ringtone from the **Default Ring** drop-down list.
- If you don't want to specify a ringtone for the phone line, choose **No ring**. Your phone doesn't ring when receiving an incoming call.
- Step 3** Click **Submit All Changes**.
- 

## Control Ringer Volume

You can control the ringer volume of an incoming call on the phone, or from the phone administration web page.

If your administrator restricts your ability to control the ringer volume, you can't perform this task from either the phone volume key or from the phone administration web page.

### Before you begin

Your administrator must allow you to control the ringer volume.

### Procedure

---

To control the ringer volume do one of the following.

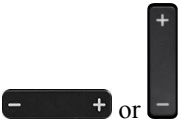
- On the phone, press the **Volume**  button to reduce or to increase the volume.
    - Note** When your administrator restricts your ability to control the ringer volume, a message appears indicating that you have no permission to change the ringer volume.
  - On the phone administration web page, access the **User Login > Advanced** and then select **Voice > User > Audio Volume**. Enter a value for the **Ringer Volume** parameter and click **Submit All Changes**.  
The valid value for the **Ringer Volume** parameter ranges from 0 to 15.
    - Note** When your administrator restricts your ability to control the ringer volume, the **Ringer Volume** parameter doesn't appear under the **Audio Volume** section.
- 

## Turn on DND from the Phone Web Page

### Procedure

---

- Step 1** On the phone web page, select **User Login > Voice > User**.
  - Step 2** Under **Supplementary Services**, set **DND Settings** to **Yes**.  
You can turn on DND on for all lines if your administrator hasn't enabled feature key sync (FKS).
  - Step 3** Click **Submit All Changes**.
- 

## Configure the Screen Saver with the Phone Web Interface

You can configure a screen saver for the phone. When the phone is idle for a specified time, it enters screen saver mode.

Any button press returns the phone to normal mode.

### Procedure

---

- Step 1** On the phone web page, select **Voice > User**.
- Step 2** In the **Screen** section, set up the fields as described in the following table.

| Parameter            | Description                                                                                                                                                                                                                                                                                                                                                             |
|----------------------|-------------------------------------------------------------------------------------------------------------------------------------------------------------------------------------------------------------------------------------------------------------------------------------------------------------------------------------------------------------------------|
| Screen Saver Enable  | Select <b>Yes</b> to enable a screen saver on the phone. When the phone is idle for a specified amount of time, the screen saver displays.<br>Default: No                                                                                                                                                                                                               |
| Screen Saver Type    | Types of screen saver. Options you can choose: <ul style="list-style-type: none"> <li>• <b>Clock</b>—Displays a digital clock on a plain background.</li> <li>• <b>Download Picture</b>—Displays a picture pushed from the phone webpage.</li> <li>• <b>Logo</b>: Displays a logo on the phone screen. Add a logo image in the <b>Logo URL</b> field.</li> </ul>        |
| Screen Saver Wait    | Amount of idle time before screen saver displays.<br>Enter the number of seconds of idle time to elapse before the screen saver starts.<br>Default: 300                                                                                                                                                                                                                 |
| Picture Download URL | URL locating the (.png) file to display on the phone screen background. If you select <b>Download Picture</b> as a screensaver on the phone screen.<br><br>When you enter an incorrect URL to download a new wallpaper, the phone fails to download the wallpaper. If the phone does not have any wallpaper downloaded earlier, the phone displays a default wallpaper. |
| Logo URL             | Enter a URL or path for the location where the logo image is saved. If you select <b>Logo</b> as a screensaver on the phone screen.                                                                                                                                                                                                                                     |

**Step 3** Click **Submit All Changes**.

## Adjust the Backlight Timer from Phone Web Page

### Procedure

- Step 1** On the phone web page, select **User Login > Advanced > Voice > User**.
- Step 2** Under **Screen**, select a duration for the **Back Light Timer** parameter.
- Step 3** In the **LCD Contrast** field, enter a number for the desired brightness.

## Add a Logo as a Phone Background

To add a logo icon as your phone screen background, add it from phone web page.

### Procedure

- Step 1** On the phone web page, select **User Login > Voice > User**.

- Step 2** In the **Screen** section, select **Logo** from the **Phone Background** field and in the **Logo URL** field enter a URL or path for the location where the logo image is saved.
- Step 3** Click **Submit All Changes**.
- After the logo is added in the phone background, if you select **Default** from the **Phone Background** list and save the changes, the logo icon on the phone screen will disappear.
- 

## Enable Anonymous Call Blocking from the Phone Web Page

### Procedure

---

- Step 1** On the phone web page, select **User Login > Voice > User**.
- Step 2** Under **Supplementary Services**, set **Block ANC Setting** to **Yes**.
- The setting applies to all lines, except for the ones where your administrator has enabled synchronization of Anonymous Call Rejection between the lines and the BroadSoft XSI service.
- Step 3** Click **Submit All Changes**.
- 

## Enable Call Waiting from the Phone Web Page

### Procedure

---

- Step 1** On the phone web page, select **User Login > Voice > User**.
- Step 2** Under **Supplementary Services**, set **CW Setting** to **Yes**.
- The setting applies to all lines, except for the ones where your administrator has enabled synchronization of Call Waiting between the lines and the BroadSoft XSI service.
- Step 3** Click **Submit All Changes**.
- 

## Set Password from Phone Web Page

You can update your password from the phone web page.

### Before you begin

You must have your current password.

## Procedure

---

- Step 1** On the phone web page, select **Voice > System**.
- Step 2** Under the section **System Configuration**, locate the parameter **User Password**, and click **Change Password** next to the parameter.
- Step 3** Enter your current password in the **Old Password** field.  
If you don't have a password, keep the field empty.
- Step 4** Enter your new password in the **New Password** field.
- Step 5** Click **Submit**.

The message `Password has been changed successfully.` will display in the web page.

---







# CHAPTER 7

## Accessories

- [Supported Accessories, on page 171](#)
- [Headsets, on page 172](#)
- [Cisco 6800 series Key Expansion Module setup overview, on page 187](#)
- [Wall Mount Kit, on page 191](#)

## Supported Accessories

The Cisco IP Phone 6800 Series Multiplatform Phones supports both Cisco and third-party accessories.

**Table 19: Accessory Support for the Cisco IP Phone 6800 Series Multiplatform Phones**

| Accessory                                | Type                 | 6821          | 6841          | 6851                                          |
|------------------------------------------|----------------------|---------------|---------------|-----------------------------------------------|
| <b>Cisco Accessories</b>                 |                      |               |               |                                               |
| Cisco IP Phone 6800 Key Expansion Module | Add-on module        | Not supported | Not supported | Supported<br>Supports on key expansion module |
| Cisco IP Phone 6800 Wall Mount Kit       |                      | Not supported | Supported     | Supported                                     |
| Cisco Headset 520 Series                 | USB                  | Not supported | Not supported | Not supported                                 |
| Cisco Headset 530 Series                 | Standard RJ9         | Supported     | Supported     | Supported                                     |
|                                          | USB Adapter          | Not supported | Not supported | Not supported                                 |
| Cisco Headset 560 Series                 | Standard RJ9 and AUX | Not supported | Not supported | Not supported                                 |
|                                          | USB                  | Not supported | Not supported | Not supported                                 |

| Accessory                      | Type            | 6821          | 6841          | 6851          | 6861          |
|--------------------------------|-----------------|---------------|---------------|---------------|---------------|
| Cisco Headset 700 Series       | USB Adapter     | Not supported | Not supported | Not supported | Not supported |
|                                | USB-C Cable     | Not supported | Not supported | Not supported | Not supported |
| <b>Third-Party Accessories</b> |                 |               |               |               |               |
| Headsets                       | Analog          | Supported     | Supported     | Supported     | Supported     |
|                                | Analog Wideband | Supported     | Supported     | Supported     | Supported     |
|                                | USB             | Not supported | Not supported | Not supported | Not supported |
| Microphone                     | External        | Not supported | Not supported | Not supported | Not supported |
| Speakers                       | External        | Not supported | Not supported | Not supported | Not supported |

## Headsets

Here are the Cisco headsets we support. For tips on setting up and using these headsets, take a look at the info for your model:

- [Bang & Olufsen Cisco 980](#)
- [Cisco Headset 320 Series](#)
- [Cisco Headset 520 Series](#)
- [Cisco Headset 530 Series](#)
- [Cisco Headset 560 Series](#)
- [Cisco Headset 720 Series](#)
- [Cisco Headset 730](#)

See the [Cisco Headset Compatibility Guide](#) for detailed information on Cisco headset integration with your device.

## Important Headset Safety Information



High Sound Pressure—Avoid listening to high volume levels for long periods to prevent possible hearing damage.

When you plug in your headset, lower the volume of the headset speaker before you put the headset on. If you remember to lower the volume before you take the headset off, the volume will start lower when you plug in your headset again.

Be aware of your surroundings. When you use your headset, it may block out important external sounds, particularly in emergencies or in noisy environments. Don't use the headset while driving. Don't leave your headset or headset cables in an area where people or pets can trip over them. Always supervise children who are near your headset or headset cables.

## Cisco Headsets 500 Series

You can use the Cisco Headset 500 Series with your Cisco IP Phone 6871 Multiplatform Phones. The Cisco Headset 500 Series offers a more enhanced experience with:

- In-call indicators: LEDs on an ear plate
- Simplified call controls
- Customized audio

The supported headsets are:

- Cisco Headset 520 Series
- Cisco Headset 531 and 532
- Cisco Headset 560 Series (Standard Base and Multibase)

## Cisco Headset 521 and 522

The Cisco Headsets 521 and 522 are two wired headsets that have been developed for use on Cisco IP Phones and devices. The Cisco Headset 521 features a single earpiece for extended wear and comfort. The Cisco Headset 522 features two earpieces for use in a noisy workplace.

Both headsets feature a 3.5-mm connector for use on laptops and mobile devices. An inline controller with a USB connector is also available for use on the Cisco IP Phone 6871 Multiplatform Phones. The controller is an easy way to answer your calls, and to access basic phone features such as hold and resume, mute, and volume control.

The Cisco Headsets 521 and 522 require Multiplatform Firmware Release 11.2(3) or later version. Upgrade your phones to the latest firmware before using these headsets.

To check your phone model and the firmware version, press **Applications** and select **Status > Product information**. The **Product name** field shows your phone model. The **Software version** field shows the installed load where you can get the firmware version.

### Cisco Headset 521 and 522 Buttons and LED

Your controller buttons are used for basic call features.

Figure 16: Cisco Headset 521 and 522 Controller

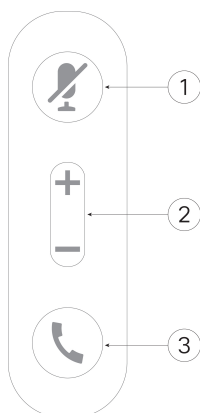

The following table describes the Cisco Headset 521 and 522 controller buttons.

Table 20: Cisco Headset 521 and 522 Controller Buttons

| Number | Name                    | Description                                                                                                                                                                                                                                                                                                              |
|--------|-------------------------|--------------------------------------------------------------------------------------------------------------------------------------------------------------------------------------------------------------------------------------------------------------------------------------------------------------------------|
| 1      | Mute button             | Toggle the microphone on and off.                                                                                                                                                                                                                                                                                        |
| 2      | Volume button (+ and -) | Adjust the volume on your headset.                                                                                                                                                                                                                                                                                       |
| 3      | Call button             | Use to manage calls: <ul style="list-style-type: none"> <li>• Press once to answer an incoming call.</li> <li>• Press and hold for 2 seconds to end a call.</li> <li>• Press twice to reject an incoming call.</li> <li>• Press once to put an active call on hold. Press again to retrieve a call from hold.</li> </ul> |

## Cisco Headset 531 and 532

The Cisco Headset 530 Series are two headsets that are developed for Cisco products and services. The 531 headset features a single earpiece, and offers lightweight comfort. The 532 headset features two earpieces for use in a noisy environment or busy office.

The Cisco Headset 531 and 532 use one of two connectors with the Cisco IP Phone 6871 Multiplatform Phones:

- RJ9 connector—Use it with Cisco IP Phones that have a headset port.
- USB headset adapter— Provides enhanced call control.

The Cisco Headset USB Adapter is available for use with the Cisco Headset 531 and 532. With the adapter, you can test your headset, and customize your bass and treble, gain or microphone volume, and sidetone or feedback settings. The adapter also retains your settings if you switch between phones.

The Cisco USB adapter is supported on Cisco IP Phone 6871 Multiplatform Phones. To check your phone model, press **Applications**  > **Status** > **Product information**. The **Product name** field shows your phone model.

The Cisco Headset 530 Series require Multiplatform Firmware Release 11.1(2) or a later version. Upgrade your phones to the latest firmware before using these headsets.

### Cisco Headset 531 and 532 LED and Buttons

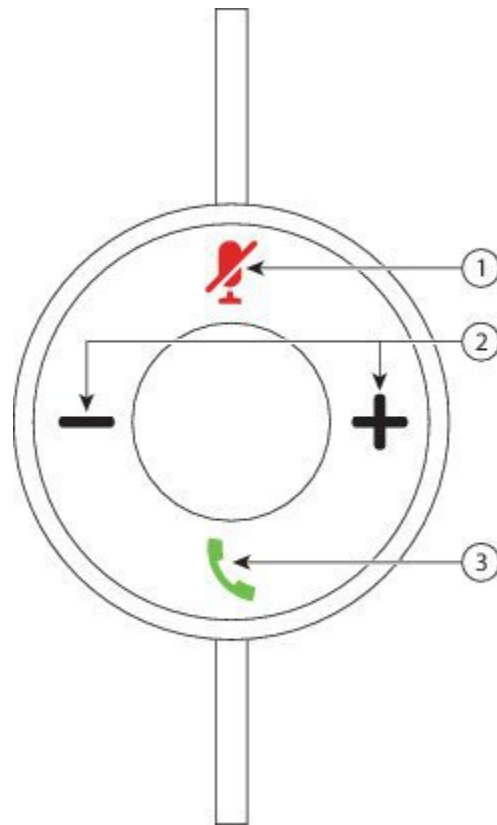

The Cisco Headset USB Adapter for Cisco Headset 530 Series is used for the basic call features.

**Figure 17: Cisco Headset USB Adapter**



The following table describes the Cisco Headset 531 and 532 USB Adapter buttons.

**Table 21: Cisco Headset USB Adapter Buttons**

| Number | Name                                                                                            | Description                                                                                                                                                                                                         |
|--------|-------------------------------------------------------------------------------------------------|---------------------------------------------------------------------------------------------------------------------------------------------------------------------------------------------------------------------|
| 1      | Mute button  | Toggle the microphone on and off. When Mute on the USB adapter is enabled, the <b>Mute</b>  button on the USB adapter lights up. |
| 2      | Volume button (+ and -)                                                                         | Adjust the volume on your headset.                                                                                                                                                                                  |

| Number | Name                                                                                          | Description                                                                                                                                                                                                                                                                                                                                                                                                                                                                                                                                                                                                                                                                                                                                                                                                                                                                                                       |
|--------|-----------------------------------------------------------------------------------------------|-------------------------------------------------------------------------------------------------------------------------------------------------------------------------------------------------------------------------------------------------------------------------------------------------------------------------------------------------------------------------------------------------------------------------------------------------------------------------------------------------------------------------------------------------------------------------------------------------------------------------------------------------------------------------------------------------------------------------------------------------------------------------------------------------------------------------------------------------------------------------------------------------------------------|
| 3      | Call button  | <p>Incoming and active call management depends upon if you have one call or multiple calls.</p> <p>One call:</p> <ul style="list-style-type: none"> <li>• Press once to answer incoming calls.</li> <li>• Press once to put an active call on hold. Press again to retrieve the call from hold.</li> <li>• Press twice to reject an incoming call.</li> </ul> <p>Multiple calls:</p> <ul style="list-style-type: none"> <li>• Press once to put an active call on hold, and to answer a second incoming call.</li> <li>• Press once to put a current call on hold and press again to resume a call.</li> <li>• Press and hold for 2 seconds to end the current call and press again to resume a held call.</li> <li>• Press and hold for 2 seconds to end an active call, and to answer another incoming call.</li> <li>• Press twice to stay on a current call, and to reject a second incoming call.</li> </ul> |

## Cisco Headset 561 and 562

The Cisco Headset 560 Series are two wireless headsets that are developed for Cisco products and services. The Cisco Headset 561 features a single earpiece, and offers lightweight comfort. The Cisco Headset 562 features two earpieces for use in a noisy environment or busy office.

The Cisco Headset 560 Series use a headset base to connect with Cisco IP Phones and charge the headsets. The available options for the base are Standard base and Multibase. The Cisco Headset 560 Series with Standard Base support connection with a single source from a phone or a computer. The Cisco Headset 560 Series with Multibase support multiple sources from phones, computers, and Bluetooth-paired devices and provide an easy and intuitive switch among the connected sources.

You can connect the Cisco Headset 560 Series with any of the following:

- RJ9 and AUX connector (Y-cable)—Supported on Cisco IP Phones 6871 with multiple platforms.
- USB connector—Supported on Cisco IP Phone 6871 with multiple platforms.

The Cisco Headset 560 Series require Multiplatform Firmware Release 11.2(3) and higher. Upgrade your phones to the latest firmware before using these headsets.

To check your phone model and the firmware version, press **Applications**  and select **Status > Product information**. The **Product name** field shows your phone model. The **Software version** field shows the installed load where you can get the firmware version.

### Cisco Headset 561 and 562 Buttons and LED



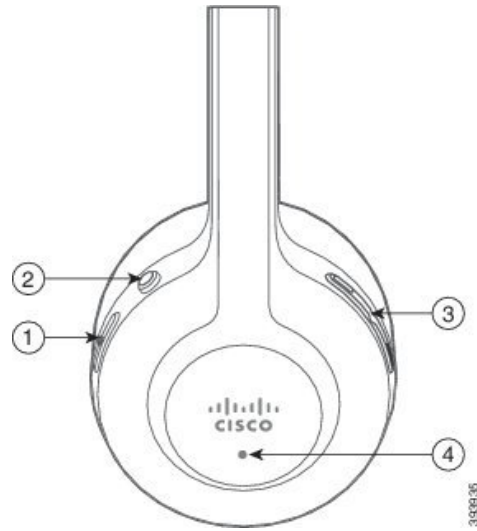

Your headset buttons are used for basic call features.

*Figure 18: Cisco Headset 561 and 562 Headset Buttons*



The following table describes the Cisco Headset 561 and 562 Headset buttons.

**Table 22: Cisco Headset 561 and 562 Headset Buttons**

| Number | Name                                                                                                    | Description                                                                                                                                                                                                                                                                                                                                                                                                                                                                                                                                                                                                                                                                                                                                                                                                                                                                                                                                                                                                                    |
|--------|---------------------------------------------------------------------------------------------------------|--------------------------------------------------------------------------------------------------------------------------------------------------------------------------------------------------------------------------------------------------------------------------------------------------------------------------------------------------------------------------------------------------------------------------------------------------------------------------------------------------------------------------------------------------------------------------------------------------------------------------------------------------------------------------------------------------------------------------------------------------------------------------------------------------------------------------------------------------------------------------------------------------------------------------------------------------------------------------------------------------------------------------------|
| 1      | Power and Call button  | <p>Use to power the headset on and off.</p> <p>Press and hold for 4 seconds to power on/off the headset.</p> <p>Incoming and active call management depends upon if you have one call or multiple calls.</p> <p>One call:</p> <ul style="list-style-type: none"> <li>• Press once to answer incoming calls.</li> <li>• Press once to put an active call on hold. Press again to retrieve the call from hold.</li> <li>• Press twice to reject an incoming call.</li> </ul> <p>Multiple calls:</p> <ul style="list-style-type: none"> <li>• Press once to put an active call on hold, and to answer a second incoming call.</li> <li>• Press once to put a current call on hold and press again to resume a call.</li> <li>• Press and hold for 2 seconds to end the current call and press again to resume a held call.</li> <li>• Press and hold for 2 seconds to end an active call, and to answer another incoming call.</li> <li>• Press twice to stay on a current call, and to reject a second incoming call.</li> </ul> |
| 2      | Mute button          | <p>Toggle the microphone on and off. When Mute on the headset is enabled:</p> <ul style="list-style-type: none"> <li>• The <b>Mute</b>  button on the phone lights up.</li> <li>• The <b>Mute</b>  button on the headset base lights up. (For Multibase only)</li> </ul>                                                                                                                                                                                                                                                                                                                                                                                                                                                                                                                                                                                 |
| 3      | Volume button (+ and -)                                                                                 | Adjust the volume on your headset.                                                                                                                                                                                                                                                                                                                                                                                                                                                                                                                                                                                                                                                                                                                                                                                                                                                                                                                                                                                             |
| 4      | LED                                                                                                     | <p>Shows the headset status:</p> <ul style="list-style-type: none"> <li>• Blinking red—Incoming call.</li> <li>• Steady red—Active call.</li> <li>• Flashing white every 6 seconds—The headset is paired and idle.</li> <li>• Blinking white—Firmware upgrade is in process or the headset is pairing with the base station.</li> </ul>                                                                                                                                                                                                                                                                                                                                                                                                                                                                                                                                                                                                                                                                                        |



## Charge Cisco Headset 561 and 562

Use the headset base to charge the headset.

### Procedure

---

Place the headset into the socket on the base.

The LEDs on the base station indicate the charging status. When the headset is fully charged, the five LEDs on the base are steady white. If the LEDs don't light up, remove the headset from the base and try again.

---

## Upgrade the Headset 500 Series Firmware

When you connect the headset to the phone, the phone checks the headset firmware version. If a new version is available, the phone prompts you to upgrade your headset. The headset upgrade prompt displays only when you are on the home screen of the idle phone. If the phone is in use when a new version firmware is detected, the upgrade prompt displays when you return to the home screen in idle mode.



---

**Note** If you don't respond to the upgrade prompt, the upgrade automatically starts when the countdown ends.

---

### Before you begin

Your administrator configures the upgrade rule for your headset on the phone administration web page.

### Procedure

---

**Step 1** Press **Upgrade** on the phone when prompted.

The upgrade icon  on the upper-right corner of the phone screen indicates that the headset is upgrading. The time that the upgrade process takes varies with headset models, from 10 to 15 minutes.

**Step 2** (Optional) If you want to upgrade your headset later, press **Postpone**.

You will be prompted every 2 hours until you start the upgrade.

---

## Cisco Headset 500 Series Setup

On the phone screen, you can test your headset, customize your bass and treble, gain or microphone volume, and sidetone or feedback settings when:

- The Cisco Headset 520 Series is connected to the phone with the inline USB controller.
- The Cisco Headset 531 and 532 is connected to the phone with the USB adapter.
- The Cisco Headset 560 Series Standard Base or Multibase is connected to the phone with the Y-cable or the USB cable.

You are prompted to set up your headset when you connect it to the phone. If you ignore the headset setup prompt, you can also access it from **Applications**  > **Status** > **Accessories**.



---

**Note** The settings are stored in the inline USB controller, the USB adapter, or the headset base, varying from headset models. A factory reset on the phone does not affect the headset settings.

---

## Adjust Your Headset Bass and Treble

You can customize your headset by adjusting the bass and treble. If you prefer a headset with more bass, tune it toward the warmer setting. If you prefer more treble, tune it toward the brighter setting.

### Procedure

---

- Step 1** Press **Applications** .
  - Step 2** Select **Status**.
  - Step 3** Select **Accessories**.
  - Step 4** Navigate to **Setup** > **Speaker** > **Tuning**.
  - Step 5** Press the Navigation cluster, left or right, to adjust the tuning.
  - Step 6** Press **Save** to apply and retain your setting.
- 

## Adjust Your Headset Microphone Volume

Microphone volume is also known as gain. You can adjust the gain level when you are on a call with various loud and soft voices. This setting equalizes the voices that you hear in the earpiece by making the loud voices softer, and the quiet voices louder.

### Procedure

---

- Step 1** Press **Applications** .
  - Step 2** Select **Status**.
  - Step 3** Select **Accessories**.
  - Step 4** Navigate to **Setup** > **Microphone** > **Gain**.
  - Step 5** Press the Navigation cluster, left or right, to adjust the gain.
  - Step 6** Press **Save** to apply and retain your setting.
- 

## Adjust your headset speaker feedback

Feedback, also called sidetone, is the term for hearing your own voice in your headset. You can adjust the sidetone level or turn it off if you find it distracting to hear your own voice during a call.

### Procedure

---

- Step 1** Press **Applications** .
  - Step 2** Navigate to **Status > Accessories > Setup > Speaker > Sidetone**.
  - Step 3** Press the Navigation cluster, left or right, to adjust the sidetone.  
The sidetone default value is low.
  - Step 4** Press **Set** to apply and retain your settings.
- 

### Test Your Headset Microphone

You can check if your microphone is working before you begin a call.

### Procedure

---

- Step 1** Press **Applications** .
  - Step 2** Select **Status**.
  - Step 3** Select **Accessories**.
  - Step 4** Navigate to **Setup > Microphone > Test**.
  - Step 5** Press **Record** and speak into the microphone.
- 

### Replace your Cisco Headset 500 Series ear pads

Your headset's ear pads are an important part of its performance. They provide comfort, grip, and sound enhancement. With time, it's natural for ear pads to wear out, but you can replace them easily.



---

**Note** Cisco Headset 560 Series ear pads are not compatible with the Cisco Headset 520 Series and Cisco Headset 530 Series.

---

### Procedure

---

- Step 1** Rotate the old ear pad counterclockwise.

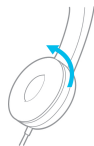

- Step 2** Pull the old ear pad away from the speaker.

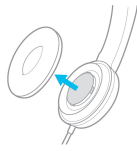

**Step 3** Push the new ear pad toward the speaker.

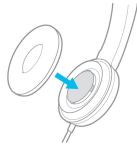

**Step 4** Rotate the new ear pad clockwise.



---

## Cisco Headsets 700 Series

You can use the Cisco Headset 700 Series with the following Cisco IP Phone Multiplatform Phones:

- Cisco IP Phone 6871 Multiplatform Phones

The Cisco Headset 700 Series is a wireless headset that uses Bluetooth connectivity to pair with Cisco IP Phone Multiplatform Phones. It provides the following features:

- Reliable audio with Clear Voice
- Enterprise-grade security
- Intelligent headset management
- Customizable Audio

The supported headset model in the Cisco Headset 700 Series is:

- Cisco Headset 730

The firmware version of the headset must be 1-7-0-138 or later.

The firmware version of the USB adapter must be 1-3-12 or later.

## Cisco Headset 730

The Cisco Headset 730 is a wireless headset that uses Bluetooth connectivity to pair with the Cisco IP Phones Multiplatform Phones. The headset features full call control and music playback capabilities in addition to powerful noise cancellation and ambient audio enhancement systems for use in a busy office environment.

The Cisco Headset 730 comes with a USB Adapter for use with devices that don't offer a reliable Bluetooth solution. The headset can also connect to devices via the included 3.5 mm cable and USB-C to USB-A cable. The USB-C cable also acts as a charging cable and can connect to any USB power adapter.

You can connect the Cisco Headset 730 with any of the following:

- USB adapter
- USB-C cable
- 3.5 mm audio cable

The following call control features apply to the Cisco Headset 730 that is used with the Cisco IP Phone Multiplatform Phones:

- Answer a call
- End a call
- Adjust the headset volume
- Hold a call
- Resume a call
- Reject a call
- Handle multiple calls
- Mute your microphone



---

**Note** These call control features are available only when the headset connects to the phone by USB adapter or USB-C cable. For the Bluetooth connection, only basic call control features are supported (such as, answer or end a call), the call control features will be fully supported in a future release.

---

For more information about the Cisco Headset 730, see [Cisco Headset 730 User Guide](#).

The Cisco Headset 730 requires Multiplatform Firmware Release 11.3(5) and higher. Upgrade your phones to the latest firmware before using the headset.

To check your phone model and the firmware version, press **Applications**  and select **Status > Product information**. The **Product name** field shows your phone model. The **Software version** field shows the installed load where you can get the firmware version.

## Upgrade the Headset 730 Firmware

When you connect the headset to the phone, the phone checks the headset firmware version. If a new version is available, the phone prompts you to upgrade your headset. The headset upgrade prompt displays only when you are on the home screen of the idle phone. If the phone is in use when a new version firmware is detected, the upgrade prompt displays when you return to the home screen in idle mode.



---

**Note** If you don't respond to the upgrade prompt, the upgrade automatically starts when the countdown ends.

---

**Before you begin**

- Your administrator configures the upgrade rule for your headset on the phone administration web page.
- Your phone is idle.

**Procedure**



---

**Step 1** Return to or enter the phone main screen.

**Step 2** Connect the headset to the phone with the USB-C cable.

**Note** The headset can be upgraded only by the USB-C connection.

**Step 3** Press **Upgrade** on the phone when prompted.

The upgrade icon  on the upper-right corner of the phone screen indicates that the headset is upgrading. The time that the upgrade process takes varies with headset models, from 10 to 15 minutes.

**Step 4** (Optional) If you want to upgrade your headset later, press **Postpone**.

You will be prompted every 2 hours until you start the upgrade.

---

**Find Details of Your Headset 730 on the Phone**

You can find information about the name, model, serial number, and firmware version of the Cisco Headset 730 on the phone.

**Before you begin**

- Ensure that the firmware version of your headset is 1-7-0-138 or later.  
To upgrade the firmware of your headset, see [Upgrade the Headset 730 Firmware, on page 183](#).
- Ensure that the firmware version of the USB adapter for the headset is 1-3-12 or later.  
For details about how to upgrade the adapter, contact the Headset support.

**Procedure**

---

**Step 1** Press **Applications** .

**Step 2** Select **Status > Accessories**.

The menu displays the accessories that have connected to the phone.

**Step 3** Highlight the **Cisco Headset 730** from the **Accessories** menu.

If the menu displays the **Cisco USB HD Adapter** instead, this means that the headset doesn't pair to the phone. You can proceed with the next step to find details about the USB adapter.

**Step 4** Press **Details**.

**Step 5** Press **Back** to exit.

---

## Third Party Headsets

Cisco Systems performs internal testing of third-party headsets for use with Cisco IP Phones. But Cisco does not certify or support products from headset or handset vendors.

Headsets connect to your phone using either the USB or the auxiliary port. Depending upon your headset model, you have to adjust your phone's audio settings for the best audio experience, including the headset sidetone setting.

If you have a third-party headset, and you apply a new sidetone setting, then wait one minute and reboot the phone so the setting is stored in flash.

The phone reduces some background noise that a headset microphone detects. You can use a noise canceling headset to further reduce the background noise and improve the overall audio quality.

If you are considering a third-party headset, we recommend the use of good quality external devices; for example, headsets that are screened against unwanted radio frequency (RF) and audio frequency (AF) signals. Depending on the quality of headsets and their proximity to other devices, such as mobile phones and two-way radios, some audio noise or echo may still occur. Either the remote party or both the remote party and the Cisco IP Phone user may hear an audible hum or buzz. A range of outside sources can cause humming or buzzing sounds; for example, electric lights, electric motors, or large PC monitors.



---

**Note** Sometimes, use of a local power cube or power injector may reduce or eliminate hum.

---

Environmental and hardware inconsistencies in the locations where Cisco IP Phones are deployed mean that no single headset solution is optimal for all environments.

We recommend that customers test headsets in the intended environment to determine performance before making a purchasing decision to deploy on a large scale.

You can use only one headset at a time. The most-recently connected headset is the active headset.

## Audio Quality

Beyond physical, mechanical, and technical performance, the audio portion of a headset must sound good to the user and to the party on the far end. Sound quality is subjective, and we cannot guarantee the performance of any third-party headset. However, various headsets from leading headset manufacturers are reported to perform well with Cisco IP Phones.

Cisco doesn't recommend or test any third-party headsets with their products. For information about third-party headset support for Cisco products, go to the manufacturer's web site.

Cisco does test the Cisco headsets with the Cisco IP Phones. For information about Cisco Headsets and Cisco IP Phone support, see <https://www.cisco.com/c/en/us/products/collaboration-endpoints/headsets/index.html>.

## Wired Headsets

A wired headset works with all Cisco IP Phone features, including the Volume and Mute buttons. These buttons adjust the earpiece volume and mute the audio from the headset microphone.

When you install a wired headset, make sure you press the cable into the channel in the phone.



**Caution** Failure to press the cable into the channel in the phone can lead to cable damage.

## Standard Headsets

You can use a standard headset with your desk phone. Standard headsets plug into the back of the phone with an RJ-type connector.

### Connect a standard headset

#### Procedure

Plug the headset into the jack on the back of the phone and press the cable into the cable channel.

**Figure 19: Standard Headset Connection**

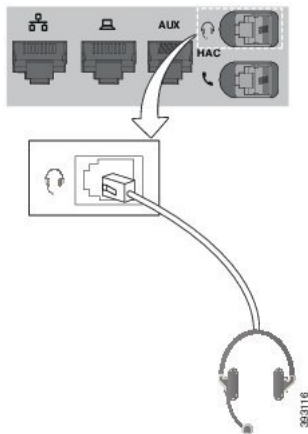

**Caution** Failure to press the cable into the channel in the phone can damage the printed circuit board inside the phone. The cable channel reduces the strain on the connector and the printed circuit board.

## USB headsets

You can use a USB headset for your calls if your phone has a USB port.

For a list of supported headsets, see [Unified Communications Endpoint and Client Accessories](#). USB headsets that are not listed may not function properly if you attach them to the USB port. For more information, see the documentation from your USB headset manufacturer.

### Connect a USB headset

When you use USB headsets with your phone, keep in mind:



- You can use only one headset at a time. The most-recently connected headset is the active headset.
- If you are on an active call and unplug a USB headset, the audio path does not change automatically. You need to press the **Speakerphone** button or pick up the handset.

#### Procedure

---

Plug the USB headset plug into the USB port on the phone.

---

## E-Hookswitch Headset

Electronic Hookswitch headsets use a base station and a wireless headset. The base station plugs into your phone headset jack. After installing the headset, your administrator enables it on the phone web page.

The Cisco IP Phone 6851, 6861, and 6871 Multiplatform Phones support Electronic Hookswitch headsets. The Cisco IP Phone 6821 and 6841 Multiplatform Phones don't support these headsets.

## Swap Headsets While on a Call

You can connect an analog headset and a USB headset simultaneously to your phone. However, you can use only one headset at a time.

When you connect multiple headsets to the phone, you can switch among the headsets during a call by pressing the **Headset** key on the phone. Though the phone is connected to multiple devices, you see a specific headset is selected as the preferred audio device in the following priority order:

- When you connect a USB headset and an analog headset to the phone, you can make your USB headset the preferred audio device.
- When you connect only an analog headset to the phone, you make your analog headset the preferred audio device.

#### Procedure

---

- Step 1** Before you make or answer a call, press **Headset**.
- Step 2** (Optional) If you place a call, dial the number.
- 







## Cisco 6800 series Key Expansion Module setup overview

The Cisco IP Phone 6851 Multiplatform Phone supports only one key expansion module. The key expansion module provides 14 lines or programmable buttons, and two pages. Each page contains 14 lines or buttons.



## Key Expansion Module buttons and hardware

The following table describes the features of the key expansion module.

|   |                                                                                                                                                                                                                                                                                                                                                                                                                                                                                                                                                                                                                                                                                                                                                                                                                                                                                                                            |
|---|----------------------------------------------------------------------------------------------------------------------------------------------------------------------------------------------------------------------------------------------------------------------------------------------------------------------------------------------------------------------------------------------------------------------------------------------------------------------------------------------------------------------------------------------------------------------------------------------------------------------------------------------------------------------------------------------------------------------------------------------------------------------------------------------------------------------------------------------------------------------------------------------------------------------------|
| 1 | LCD screens—Displays the phone number, name, and icon. Icons indicate the line status and the phone service assigned on that line.                                                                                                                                                                                                                                                                                                                                                                                                                                                                                                                                                                                                                                                                                                                                                                                         |
| 2 | <p>Lighted buttons—14 buttons. Each button corresponds to one line (same as on the phone). The lights beneath each button indicate the state of the corresponding line as follows:</p> <ul style="list-style-type: none"> <li>•  light off—Button is not configured.</li> <li>•  green steady—Line is configured correctly, registered successfully, and is in idle state.</li> <li>•  red steady—Line is in use and has an active call on it or has one parked call.</li> <li>•  amber steady/blinking—A configuration error occurred when this feature was being set up.</li> </ul> |
| 3 | <p>Page buttons—2 buttons. The button for page 1 is labeled as <b>1</b> and the button for page 2 is labeled as <b>2</b>. The lights in each button indicate the state of the page as follows:</p> <ul style="list-style-type: none"> <li>•  green steady—Page is in view.</li> <li>•  light off—Page is not in view.</li> <li>•  amber steady—Page is not in view but has one or more alerting calls on the page.</li> </ul>                                                                                                                                                                                                                                     |

## Key Expansion Module Power Information

The phone uses an RJ9 jack to connect to the key expansion module. The key expansion module requires the phone to use either Power over Ethernet (PoE) or the Cisco IP Phone 6800 Power Adapter. The key expansion module draws 9V DC, 5W from the phone.

Table 23: Power-Supply Compatibility Table

| Configuration                | 802.3af Power over Ethernet (PoE) | 802.3at PoE | Cisco IP Phone 6800 Power Adapter |
|------------------------------|-----------------------------------|-------------|-----------------------------------|
| 6851 with 1 expansion module | Yes                               | Yes         | Yes                               |

## Find information about the Key Expansion Module of your phone

Your administrator may ask for information about the key expansion module that is added to your phone. This information uniquely identifies the key expansion module for troubleshooting purposes.

### Procedure

---

- Step 1** Press **Applications** .
- Step 2** Select **Status > Accessories**.
- Step 3** Select **Attendant Console Unit1**.
- Step 4** Press **Detail**.

In the **Accessories details** screen you see the details:

- **Name:** Displays the name assigned to the key expansion module.
  - **Unit enabled:** Displays Yes or No if the connected key expansion module is enabled or disabled respectively.
  - **Unit online:** Displays Yes or No if the connected key expansion module is online or offline respectively.
  - **Hardware version:** Displays the hardware version of the key expansion module.
  - **Software version:** Displays the software version installed in the key expansion module.
  - **VID:** Indicates the extension on the calling phone from which the outbound call is sent.
  - **Serial number:** Displays the serial number of the key expansion module.
  - **Product name:** Displays the name that you assigned to the key expansion module.
  - **Description:** Displays a description for the key expansion module. For example, Cisco IP Phone 6800 Key Expansion Module.
- 

## View the UDI Information of the Key Expansion Module

You can view the Unique Device Identifier (UDI) information of the key expansion module. The UDI information includes:

- Product name (PID)
- Product Version ID (VID)
- Serial number (SN)

### Procedure

---

- Step 1** Press **Applications** .

**Step 2** Select **Status > Accessories > Attendant console unit n.**

---

## Adjust the contrast of the Key Expansion Module

You can adjust the key expansion module screen contrast to make the screen easier to read.

### Procedure

---

- Step 1** Press **Applications** .
- Step 2** Select **User Preferences > Attendant console preferences.**
- Step 3** Select **Contrast level.**
- Step 4** Press the Navigation cluster up to increase the contrast, or down to reduce the contrast.
- Step 5** Press **Save** to save the contrast level.
- 

## Change the display mode of the Key Expansion Module from the phone

### Procedure

---

- Step 1** Press **Applications** .
- Step 2** Select **User Preferences > Attendant console preferences.**
- Step 3** Select **Display mode.**
- Step 4** Press the **Select** button of the Navigation cluster to choose a display mode.
- The options are:
- **Both**
  - **Name**
  - **Ext**
- Step 5** Press **Save** to save the display mode.
- 

## Add Features or Menu Shortcuts to Key Expansion Module Line Keys

After you configure a line key on the key expansion module with a menu shortcut or a feature, you can press the configured line key to open the menu or access the feature.

### Before you begin

Your administrator must enable this feature on your phone.

### Procedure

---

- Step 1** Press and hold a line key for two seconds. The available feature list is displayed.
- Step 2** Do the following actions as you need:
- Select a feature from the list to add it to the line key.
  - Select a menu item from the menu shortcut list to add it to the line key.
- Step 3** Press **Set**.
- 

## Remove Features or Menu Shortcuts from Key Expansion Module Line Keys

### Procedure

---

- Step 1** Press and hold the line key on the key expansion module for two seconds. The feature list is displayed.
- Step 2** Select **None** from the list and press **Set**.
- 

## Wall Mount Kit

### Wall Mount Kit Components

You can mount the phone to a wall.

- The Cisco IP Phone 6821 Multiplatform Phones use a commercially-available wall plate.
- The Cisco IP Phone 6841, 6851, and 6861 Multiplatform Phones use the Cisco IP Phone 6800 Series Multiplatform Phones Wall Mount Kit.

Figure 20: Cisco IP Phone 6800 Series Multiplatform Phones Wall Mount Kit

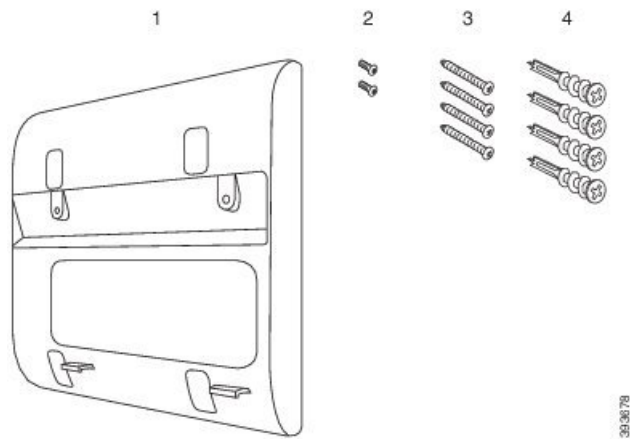

The kit is made up of these components:

- Wall bracket
- Two M3-7L screws
- Four M4-25L screws
- Four drywall anchors

#### Related Topics

[Install the Cisco IP Phone 6821 Multiplatform Phones on a Wall](#), on page 192

[Install a Cisco IP Phone 6841, 6851, 6861, or 6871 with the Wall Mount Kit](#), on page 197

## Install the Cisco IP Phone 6821 Multiplatform Phones on a Wall

### Before you begin

You can mount the Cisco IP Phone 6821 Multiplatform Phones on the wall with a standard telephone wall plate with an opening for an RJ-45 connector. Cisco recommends that you use Leviton Wall Mount plate (Leviton type number: 4108W-0SP) to wall mount the phone.

The following figure shows a list of items required to mount the phone.

Figure 21: Leviton Wall Mount Plate

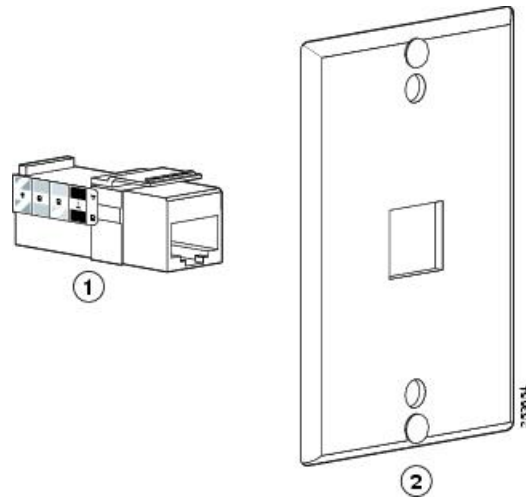

|   |                |   |                          |
|---|----------------|---|--------------------------|
| 1 | RJ45 Connector | 2 | Leviton Wall Mount Plate |
|---|----------------|---|--------------------------|

### Procedure

- 
- Step 1** If you need to use the power adapter, ensure that the adapter will reach from the phone to the electrical outlet.
- Step 2** Use the manufacturer's instructions to install the wall mount plate and connect the wall mount plate RJ45 connector to the LAN.
- Step 3** Plug the LAN cable (RJ45 connector) into the phone jack at the base of the phone as shown in the following figure.

Figure 22: RJ45 Connector in the Phone Jack

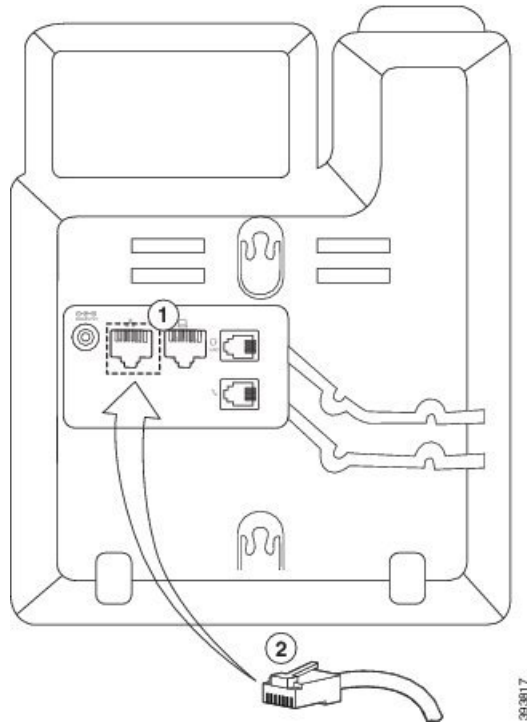

|   |                           |
|---|---------------------------|
| 1 | Network Port on the Phone |
| 2 | RJ45 Connector            |

**Step 4** Plug the RJ45 connector into the wall mount phone jack as shown in the following figure.



Figure 23: RJ45 Connector in the Wall Mount Jack

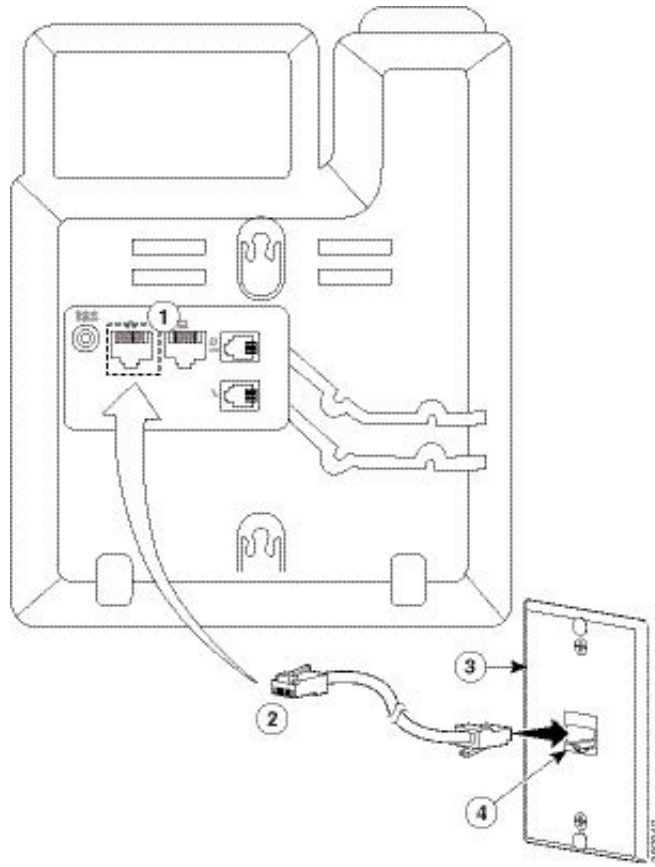

|   |                           |   |                                      |
|---|---------------------------|---|--------------------------------------|
| 1 | Network Port on the Phone | 3 | Wall Mount Plate                     |
| 2 | RJ45 Connector            | 4 | Network Port on the Wall Mount Plate |

**Step 5** Press the LAN cable into one of the cable channels.

**Step 6** (Optional) If you do not use PoE, plug the power adapter into the phone and the electrical outlet, and press the power cable into the other cable channel.

**Step 7** Slip the mounting holes on the phone over the wall mount pins as shown in the following figure.

Figure 24: Mounting Holes

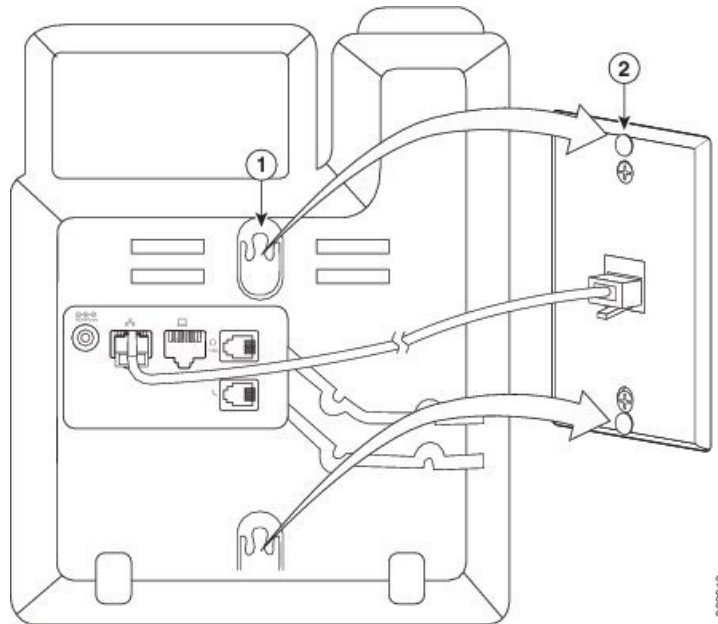

|   |                                        |
|---|----------------------------------------|
| 1 | Mounting Hole on the Phone             |
| 2 | Wall Mount Pin on the Wall Mount Plate |

**Step 8** Firmly slide the phone down into place as shown in the following image:

Figure 25: Sliding the IP Phone

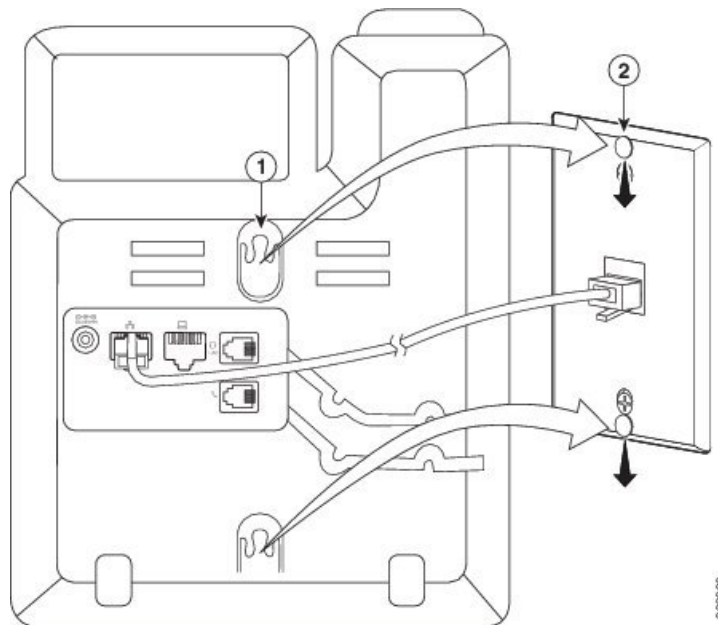

**Related Topics**

[Adjust the Handset Rest](#), on page 200

## Install a Cisco IP Phone 6841, 6851, 6861, or 6871 with the Wall Mount Kit

The wall mount kit can be mounted on most surfaces, including concrete, brick, and similar hard surfaces. To mount the kit on concrete, brick, or similar hard surfaces, you must provide the appropriate screws and anchors for your wall surface.

**Before you begin**

You need these tools:

- #2 Phillips-head screwdriver
- Level
- Pencil

You must also install an Ethernet jack for the phone in the desired location if an Ethernet jack doesn't currently exist. This jack must be wired appropriately for an Ethernet connection. You can't use a regular phone jack.

If the phone is a Cisco IP Phone 6841 or 6861, you need a power outlet close to the phone. If the phone is a Cisco IP Phone 6821, 6851, or 6871, you require either a power outlet close to the phone or you need the LAN to provide Power over Ethernet (PoE).

**Procedure**

---

- Step 1** Hold the bracket against the wall, with the notches at the bottom.
- Step 2** Use the level to ensure that the bracket is level.
- Step 3** Use a pencil to mark the screw holes.
- Step 4** Center the anchor over the pencil mark and use a #2 Phillips-head screwdriver to press the anchor into the wall. Screw the anchor clockwise into the wall until it is seated flush.
- Step 5** Use the M4-25L screws provided and the #2 Phillips-head screwdriver to attach the bracket to the wall through the anchors.

You should tighten the screws so that the bracket is held to the wall, but can be slipped off.

The following graphic shows steps 1–5.

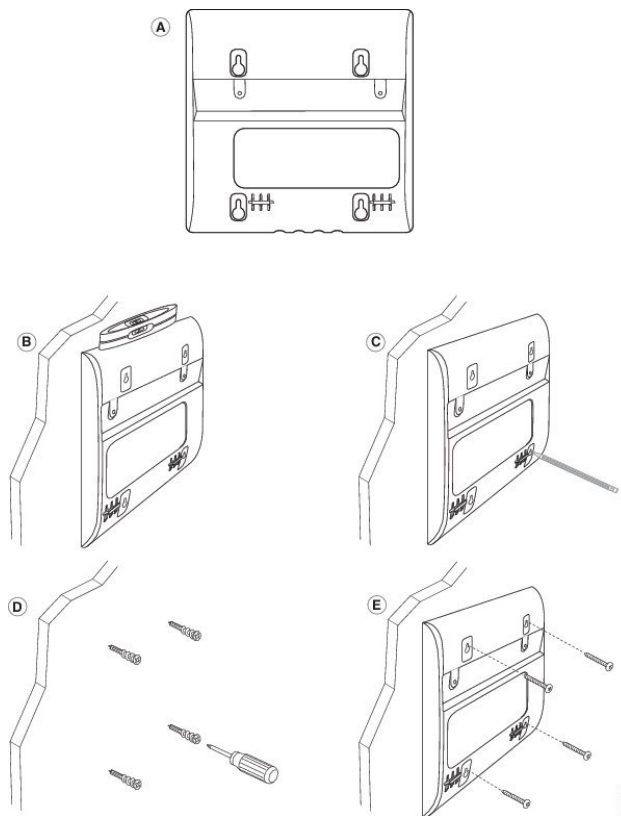

**Step 6** If the phone is in use, unplug the LAN and power cables from the phone.

The handset cable needs to be connected to the phone and seated in the cable channel.

**Step 7** Remove the wall bracket from the wall and place it on the back of the phone so that the bracket fits in the indentations in the back of the phone.

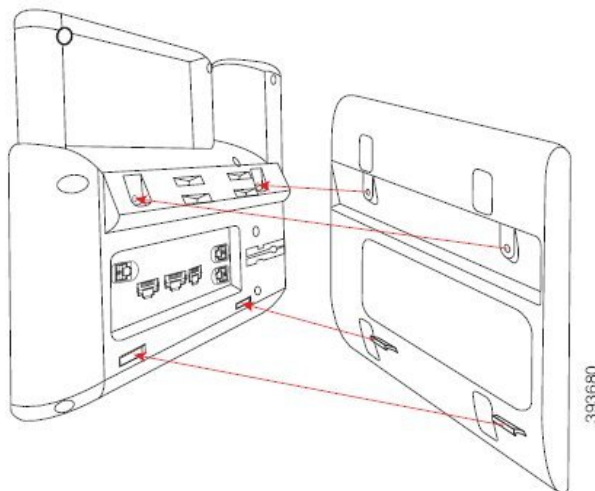

Make sure that the handset cable is between the phone and the bracket, as shown below.

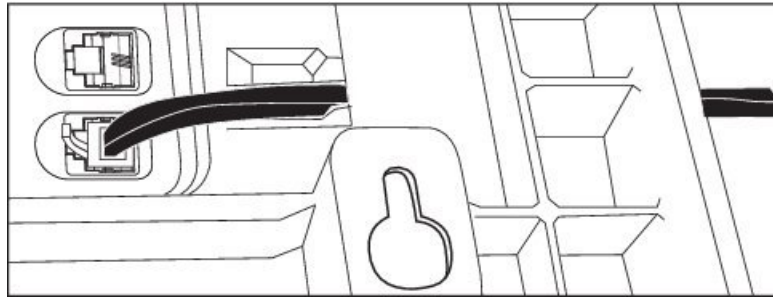

**Step 8** Attach the bracket to the phone with the M3-7L screws provided.

**Step 9** If you use the power adapter, plug the adapter into the phone and thread the cable through the closest notch in the bottom of the bracket.

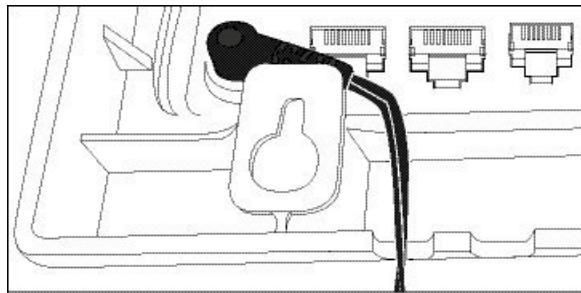

**Step 10** Plug the LAN cable into the phone and thread the cable through a notch in the bottom of the bracket.

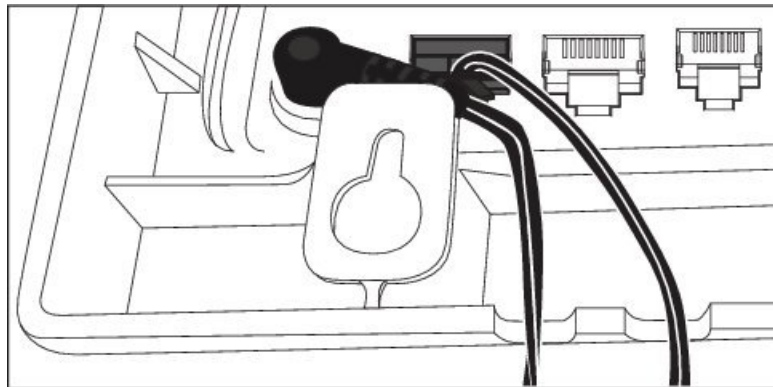

**Step 11** Place the bracket over the wall screws and pull the phone down until it is seated securely. You may need to remove the phone and loosen or tighten the wall screws to make the phone and bracket stable.

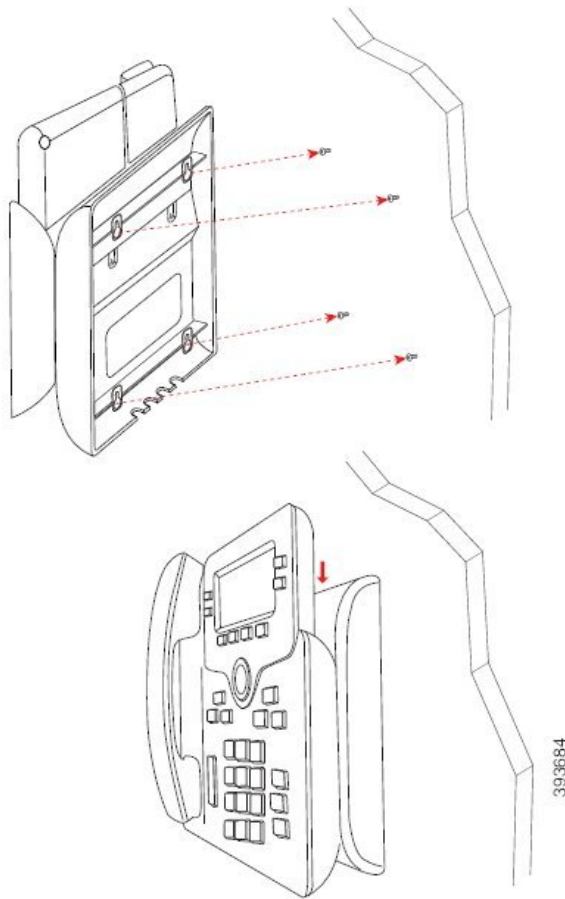

**Step 12** Plug the LAN cable into the LAN jack.

**Step 13** If you use external power, plug the power adapter into the electrical outlet.

#### What to do next

You can adjust the phone so that the handset doesn't fall out of the handset rest. See [Adjust the Handset Rest, on page 200](#).

#### Related Topics

[Adjust the Handset Rest, on page 200](#)

## Adjust the Handset Rest

If your phone is wall-mounted or if the handset slips out of the cradle too easily, you may need to adjust the handset rest to ensure that the receiver does not slip out of the cradle.

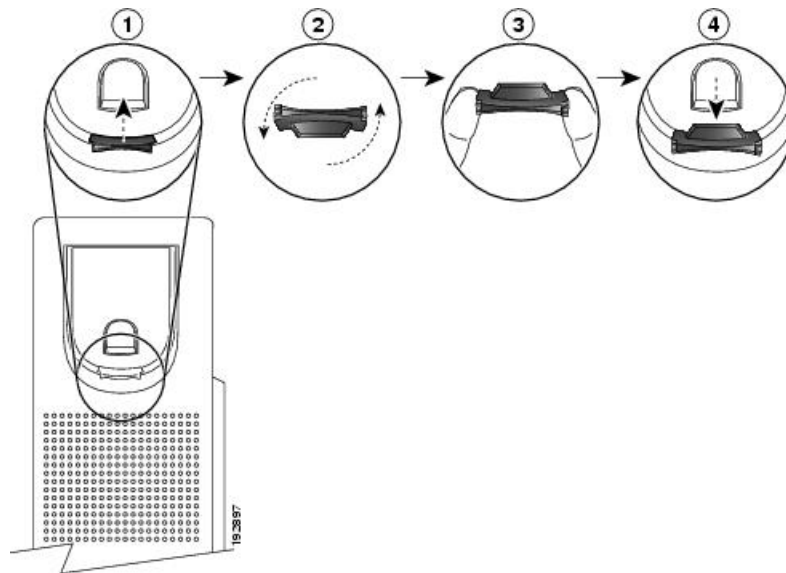
**Figure 26: Adjust the Handset Rest****Procedure**

- 
- Step 1** Remove the handset from the cradle and pull the plastic tab from the handset rest.
  - Step 2** Rotate the tab 180 degrees.
  - Step 3** Hold the tab between two fingers, with the corner notches facing you.
  - Step 4** Line up the tab with the slot in the cradle and press the tab evenly into the slot. An extension protrudes from the top of the rotated tab.
  - Step 5** Return the handset to the handset rest.
-







## CHAPTER 8

# Product Safety and Security

---

- [Safety and Performance Information, on page 203](#)
- [Compliance Statements, on page 205](#)
- [FCC Compliance Statements, on page 209](#)
- [Cisco Product Security Overview, on page 210](#)
- [Important Online Information, on page 210](#)

## Safety and Performance Information

### Power Outage

Your access to emergency service through the phone requires that the phone receive power. If a power interruption occurs, service or emergency calling service dialing does not function until power is restored. If a power failure or disruption occurs, you may need to reset or reconfigure the equipment before you can use service or emergency calling service dialing.

### Regulatory Domains

The radio frequency (RF) for this phone is configured for a specific regulatory domain. If you use this phone outside of the specific regulatory domain, the phone will not function properly, and you might violate local regulations.

The radio frequency (RF) for the handset is controlled by the base station. The base station is configured for a specific regulatory domain. If you use this system outside of the specific regulatory domain, the system will not function properly, and you might violate local regulations.

### Health-Care Environments

This product is not a medical device and uses an unlicensed frequency band that is susceptible to interference from other devices or equipment.

## External Devices

We recommend that you use good-quality external devices that are shielded against unwanted radio frequency (RF) and audio frequency (AF) signals. External devices include headsets, cables, and connectors.

Depending on the quality of these devices and their proximity to other devices, such as mobile phones or two-way radios, some audio noise may still occur. In these cases, we recommend that you take one or more of these actions:

- Move the external device away from the source of the RF or AF signals.
- Route the external device cables away from the source of the RF or AF signals.
- Use shielded cables for the external device, or use cables with a better shield and connector.
- Shorten the length of the external device cable.
- Apply ferrites or other such devices on the cables for the external device.

Cisco cannot guarantee the performance of external devices, cables, and connectors.

**Caution**

---

In European Union countries, use only external speakers, microphones, and headsets that are fully compliant with the EMC Directive [89/336/EC].

---

## Bluetooth Wireless Headset Performance

Cisco IP Phones support Bluetooth Class 2 technology when the headsets support Bluetooth. Bluetooth enables low-bandwidth wireless connections within a range of 30 feet (10 meters). The best performance is in the 3- to 6-foot (1- to 2-meter) range. You can connect up to five headsets, but only the last one connected is used as the default.

Because of potential interference issues, we recommend that you move 802.11b/g devices, Bluetooth devices, microwave ovens, and large metal objects away from the wireless headset.

The Bluetooth wireless headset does not need to be within direct line-of-sight of the phone. However, some barriers, such as walls or doors, and interference from other electronic devices, can affect the connection.

## Ways to Provide Power to Your Phone

You can provide power to your phone in one of these ways:

- Use the power adapter that comes with your phone.
- If your network supports Power over Ethernet (PoE), you can plug your phone into the network. Plug an Ethernet cable into the Ethernet phone port  and into the network.

If you are not sure whether your network supports PoE, check with your administrator.

## Phone Behavior During Times of Network Congestion

Anything that degrades network performance can affect phone audio and, in some cases, can cause a call to drop. Sources of network degradation can include, but are not limited to, the following activities:

- Administrative tasks, such as an internal port scan or security scan.
- Attacks that occur on your network, such as a Denial of Service attack.

## UL Warning

The LAN/Ethernet cable or other cables attached to the device should not be extended outside of the building.

## EnergyStar



The following phones have EnergyStar certification:

- Cisco IP Phone 6821 Multiplatform Phones
- Cisco IP Phone 6841 Multiplatform Phones
- Cisco IP Phone 6851 Multiplatform Phones
- Cisco IP Phone 6861 Multiplatform Phones
- Cisco IP Phone 6871 Multiplatform Phones

Any phone model that isn't listed in the above list isn't certified.

## Compliance Statements

### Compliance Statements for the European Union

#### CE Marking

The following CE mark is affixed to the equipment and packaging.



## RF Exposure Statement for the European Union

This device has been evaluated and found compliant in accordance with EU EMF Directive 2014/53/EU.

## Compliance Statements for the USA

### Part 15 Radio Device



#### Caution

The Part 15 radio device operates on a non-interference basis with other devices operating at this frequency. Any changes or modification to said product not expressly approved by Cisco, including the use of non-Cisco antennas, could void the user's authority to operate this device.

## Compliance Statements for Canada

This device complies with Industry Canada license-exempt RSS standard(s). Operation is subject to the following two conditions: (1) this device may not cause interference, and (2) this device must accept any interference, including interference that may cause undesired operation of the device. Privacy of communications may not be ensured when using this phone.

This product meets the applicable Innovation, Science and Economic Development Canada technical specifications.

#### Avis de Conformité Canadien

Cet appareil est conforme aux normes RSS exemptes de licence RSS d'Industry Canada. Le fonctionnement de cet appareil est soumis à deux conditions : (1) ce périphérique ne doit pas causer d'interférence et (2) ce périphérique doit supporter les interférences, y compris celles susceptibles d'entraîner un fonctionnement non souhaitable de l'appareil. La protection des communications ne peut pas être assurée lors de l'utilisation de ce téléphone.

Le présent produit est conforme aux spécifications techniques applicables d'Innovation, Sciences et Développement économique Canada.

## Canadian RF Exposure Statement

### THIS DEVICE MEETS THE LIMITS AS REFERENCED BY ISED RSS-102 R5 FOR EXPOSURE TO RADIO WAVES

Your device includes a radio transmitter and receiver. It is designed not to exceed the General populace (uncontrolled) limits for exposure to radio waves (radio frequency electromagnetic fields) as referenced in RSS-102 which references Health Canada Safety Code 6 and include a substantial safety margin designed to assure the safety of all persons, regardless of age and health.

As such the systems are designed to be operated as to avoid contact with the antennas by the end user. It is recommended to set the system in a location where the antennas can remain at least a minimum distance as specified from the user in accordance to the regulatory guidelines which are designed to reduce the overall exposure of the user or operator.

The device has been tested and found compliant with the applicable regulations as part of the radio certification process.

### Déclaration d'Exposition aux RF Canadienne

#### CE PÉRIPHÉRIQUE RESPECTE LES LIMITES DÉCRITES PAR LA NORME RSS-102 R5 D'EXPOSITION À DES ONDES RADIO

Votre appareil comprend un émetteur et un récepteur radio. Il est conçu pour ne pas dépasser les limites applicables à la population générale (ne faisant pas l'objet de contrôles périodiques) d'exposition à des ondes radio (champs électromagnétiques de fréquences radio) comme indiqué dans la norme RSS-102 qui sert de référence au règlement de sécurité n°6 sur l'état de santé du Canada et inclut une marge de sécurité importantes conçue pour garantir la sécurité de toutes les personnes, quels que soient leur âge et état de santé.

En tant que tels, les systèmes sont conçus pour être utilisés en évitant le contact avec les antennes par l'utilisateur final. Il est recommandé de positionner le système à un endroit où les antennes peuvent demeurer à au moins une distance minimum préconisée de l'utilisateur, conformément aux instructions des réglementations qui sont conçues pour réduire l'exposition globale de l'utilisateur ou de l'opérateur.

Le périphérique a été testé et déclaré conforme aux réglementations applicables dans le cadre du processus de certification radio.

## Canadian High-Power Radars Statement

Users should also be advised that high-power radars are allocated as primary users (that is, priority users) of the bands 5250-5350 MHz and 5650-5850 MHz and that these radars could cause interference and/or damage to LE-LAN devices.

Devraient également être informés des utilisateurs que les radars à haute puissance sont désignés comme utilisateurs principaux (à savoir des utilisateurs prioritaires) des bandes 5250-5350 MHz et 5650 à 5.850 MHz et que ces radars pourraient provoquer des interférences et / ou endommager les périphériques LE-LAN.

## Compliance Statements for New Zealand

### Permit to Connect (PTC) General Warning

The grant of a Telepermit for any item of terminal equipment indicates only that Spark NZ has accepted that the item complies with minimum conditions for connection to its network. It indicates no endorsement of the product by Spark NZ, nor does it provide any sort of warranty. Above all, it provides no assurance that any item will work correctly in all respects with another item of Telepermitted equipment of a different make or model, nor does it imply that any product is compatible with all of Spark NZ network services.

|                                                                                                                                                                                                 |                                                                                                                                                                                                 |                                                                                                                                                                                                 |
|-------------------------------------------------------------------------------------------------------------------------------------------------------------------------------------------------|-------------------------------------------------------------------------------------------------------------------------------------------------------------------------------------------------|-------------------------------------------------------------------------------------------------------------------------------------------------------------------------------------------------|
|  <b>TELEPERMIT</b><br>Telepermit Holder:<br>Cisco Systems (NZ) Ltd<br>Product:<br>Cisco CP-6821 IP Telephone |  <b>TELEPERMIT</b><br>Telepermit Holder:<br>Cisco Systems (NZ) Ltd<br>Product:<br>Cisco CP-6841 IP Telephone |  <b>TELEPERMIT</b><br>Telepermit Holder:<br>Cisco Systems (NZ) Ltd<br>Product:<br>Cisco CP-6851 IP Telephone |
| PTC 220 / 18 / 041                                                                                                                                                                              | PTC 220 / 17 / 039                                                                                                                                                                              | PTC 220 / 17 / 040                                                                                                                                                                              |



## Compliance Statements for Taiwan

### DGT Warning Statement

### Low Power and Visual Warning Notices

視力保護警語：使用過度恐傷害視力  
 低功率射頻電機警語：

經型式認證合格之低功率射頻電機，非經許可，公司、商號或使用者均不得擅自變更頻率、加大功率或變更原設計之特性之功能。

低功率射頻電機之使用不得影響飛航安全及干擾合法通信；經發現有干擾現象時，應立即停用，並改善至無干擾時方得繼續使用。前項合法通信，指依電信法規定作業之無線電通信。低功率射頻電機須忍受合法通信或工業、科學及醫療用電波輻射性電機設備之干擾。

4.7.9.1 應避免影響附近雷達系統之操作。

4.7.9.2 高增益指向性天線只得應用於固定式點對點系統。

## Compliance Statement for Argentina

### Advertencia

No utilizar una fuente de alimentación con características distintas a las expresadas ya que podría ser peligroso.

## Compliance Information for Brazil

### Art. 5º - 680

This equipment is not entitled to protection against harmful interference and can't cause interference in proper authorized systems.

For more information, go to this URL: <http://www.anatel.gov.br>

| Model | Certificate Number |
|-------|--------------------|
| 6821  | 00261-18-01086     |
| 6841  | 00261-18-01086     |
| 6851  | 00261-18-01086     |
| 6861  | Not approved       |
| 6871  | 07648-19-01086     |

## Compliance Statement for Singapore

**Complies with  
IMDA Standards  
DB101992**

## Compliance Information for Japan



VCCI Compliance for Class B Equipment

Japan JATE Compliance CP-6821, CP-6841, CP-6851, CP-6861

“5.2/5.3GHz is limited to indoor use only in Japan”

## Compliance Information for Mexico



Approval: CP-6821 NYC-1902CE00803

## FCC Compliance Statements

The Federal Communications Commission requires compliance statements for the following statements.

### FCC Part 15.19 Statement

This device complies with part 15 of the FCC Rules. Operation is subject to the following two conditions: (1) This device may not cause harmful interference, and (2) this device must accept any interference received, including interference that may cause undesired operation.

### FCC Part 15.21 Statement

Changes or modifications not expressly approved by the party responsible for compliance could void the user's authority to operate the equipment.

### FCC RF Radiation Exposure Statement

This equipment complies with FCC radiation exposure limits set forth for an uncontrolled environment. End users must follow the specific operating instructions for satisfying RF exposure compliance. This transmitter

must be at least 20 cm from the user and must not be collocated or operating in conjunction with any other antenna or transmitter.

## FCC Receivers and Class B Digital Statement

This product has been tested and complies with the specifications for a Class B digital device, pursuant to Part 15 of the FCC Rules. These limits are designed to provide reasonable protection against harmful interference in a residential installation. This equipment generates, uses, and can radiate radio frequency energy and, if not installed and used according to the instructions, may cause harmful interference to radio communications. However, there is no guarantee that interference will not occur in a particular installation.

If this equipment does cause harmful interference to radio or television reception, which is found by turning the equipment off and on, the user is encouraged to try to correct the interference by one or more of the following measures:

- Reorient or relocate the receiving antenna
- Increase the separation between the equipment or devices
- Connect the equipment to an outlet other than the receiver's
- Consult a dealer or an experienced radio/TV technician for assistance

## Cisco Product Security Overview

This product contains cryptographic features and is subject to U.S. and local country laws that govern import, export, transfer, and use. Delivery of Cisco cryptographic products does not imply third-party authority to import, export, distribute, or use encryption. Importers, exporters, distributors, and users are responsible for compliance with U.S. and local country laws. By using this product, you agree to comply with applicable laws and regulations. If you are unable to comply with U.S. and local laws, return this product immediately.

Further information regarding U.S. export regulations can be found at <https://www.bis.doc.gov/index.php/regulations/export-administration-regulations-ear>.

## Important Online Information

### End User License Agreement

The End User License Agreement (EULA) is located here: <https://www.cisco.com/go/eula>

### Regulatory Compliance and Safety Information

Regulatory Compliance and Safety Information (RCSI) is located here:

[https://www.cisco.com/c/dam/en/us/td/docs/voice\\_ip\\_comm/cuipph/6800-series/RCSI/RCSI-0338-book.pdf](https://www.cisco.com/c/dam/en/us/td/docs/voice_ip_comm/cuipph/6800-series/RCSI/RCSI-0338-book.pdf)

[https://www.cisco.com/c/dam/en/us/td/docs/voice\\_ip\\_comm/cuipph/MPP/6800-DECT/RCSI/RCSI-0366-book.pdf](https://www.cisco.com/c/dam/en/us/td/docs/voice_ip_comm/cuipph/MPP/6800-DECT/RCSI/RCSI-0366-book.pdf)