

L10

Enterprise Tablet



User Guide for Android™ 8.1.0 Oreo



ZEBRA

Copyright

ZEBRA and the stylized Zebra head are trademarks of Zebra Technologies Corporation, registered in many jurisdictions worldwide. Google, Android, Google Play and other marks are trademarks of Google LLC; Oreo is a trademark of Mondelez International, Inc. group. All other trademarks are the property of their respective owners. ©2021 Zebra Technologies Corporation and/or its affiliates. All rights reserved.

COPYRIGHTS & TRADEMARKS: For complete copyright and trademark information, go to zebra.com/copyright.

WARRANTY: For complete warranty information, go to zebra.com/warranty.

END USER LICENSE AGREEMENT: For complete EULA information, go to zebra.com/eula.

Terms of Use

- Proprietary Statement

This manual contains proprietary information of Zebra Technologies Corporation and its subsidiaries (“Zebra Technologies”). It is intended solely for the information and use of parties operating and maintaining the equipment described herein. Such proprietary information may not be used, reproduced, or disclosed to any other parties for any other purpose without the express, written permission of Zebra Technologies.

- Product Improvements

Continuous improvement of products is a policy of Zebra Technologies. All specifications and designs are subject to change without notice.

- Liability Disclaimer

Zebra Technologies takes steps to ensure that its published Engineering specifications and manuals are correct; however, errors do occur. Zebra Technologies reserves the right to correct any such errors and disclaims liability resulting therefrom.

- Limitation of Liability

In no event shall Zebra Technologies or anyone else involved in the creation, production, or delivery of the accompanying product (including hardware and software) be liable for any damages whatsoever (including, without limitation, consequential damages including loss of business profits, business interruption, or loss of business information) arising out of the use of, the results of use of, or inability to use such product, even if Zebra Technologies has been advised of the possibility of such damages. Some jurisdictions do not allow the exclusion or limitation of incidental or consequential damages, so the above limitation or exclusion may not apply to you.

Revision History

Changes to the original guide are listed below:

Change	Date	Description
01 Rev. A	07/01/19	Initial release
02 Rev. A	12/2020	Update data capture section to reflect Zebra scan engine.
03 Rev. A	10/2021	Update GMS Restricted section.

Contents

Copyright	2
Terms of Use	2
Revision History	2
About the Tablet	8
Introduction to the L10 Tablet	8
L10 Configurations	8
Key Features Overview	8
Optional Features	9
Software Versions	9
Chapter Descriptions	10
Notational Conventions	10
Related Documents and Software	10
Service Information	11
Getting Started	12
Introduction	12
Unpacking the Tablet	12
Overview of the XSLATE Tablet	13
Front of the XSLATE L10	13
Overview of the XPAD L10 Tablet	17
Front of the XPAD L10	17
Back of the XPAD L10	18
Left Side of the XPAD L10	19
Top Side of the XPAD L10	20
Preparing the L10 Tablet for First Use	21
Inserting a SIM Card	21
Powering Up the Tablet	22
Pens for the L10 Tablets	23
Capacitive Pens	23
Active Digitizer Pens	23
Optional Setup Tasks	23
Attaching the Pen Tether	23
Connecting the Tablet to an External Monitor	24
Battery Management	24
Monitoring Battery Usage	24

Table of Contents

Low Battery Notification	25
Battery Optimization	26
Back of Battery Charge Indicators	26
Removing and Replacing the Battery	27
Removing the Battery	27
Replacing the Battery	27
Hot Swapping the Battery	28
Using the Device	29
Introduction	29
Google Mobile Services	29
Home Screen	30
Status Bar	31
Status Icons	31
Notification Icons	32
Managing Notifications	33
Quick Settings	34
Application Shortcuts and Widgets	35
Adding an Application or Widget to the Home Screen	35
Moving Items on the Home Screen	35
Removing an App or Widget from the Home Screen	35
Folders	35
Using the Touchscreen	35
Setting Screen Rotation	36
Using the On-screen Keyboard	36
Editing Text	36
Entering Numbers, Symbols, and Special Characters	37
Using the Cameras	37
Front Camera	37
Rear Camera	37
Rear Camera Tips	37
Using the Built-in Microphones	38
Using the SD Card Reader	38
Inserting a microSD Card	38
Removing a microSD Card	38
Using the XPAD Programmable Function Buttons	39
Applications	39
Accessing Applications	42
Switching Between Recent Applications	43
Unlocking the Screen	43
Suspend Mode	46
Restarting the L10	47
Soft Reset	47
Hard Reset	47
Transferring Files with USB	48
Transferring Files with a Host Computer by USB	48
Transferring Files	48
Transferring Photos	49
Disconnecting from the Host Computer	50

Table of Contents

Applications	51
Introduction	51
Battery Manager	51
Contacts	54
Adding a Contact	54
Editing Contacts	54
Deleting	54
DataWedge Demonstration	55
Files	57
Device Central	58
Peripherals Tab	58
My Device	60
Paging an RS6000 Ring Scanner	60
Diagnostic Tool	60
Settings in the Diagnostic Tool	64
Battery Test Information	65
GPS Test Information	65
System Test Information	66
WLAN Test Information	66
WWAN Test Information	66
Bluetooth Test Information	66
Camera	67
Camera Features	67
Taking a Photo	68
Taking a Panoramic Photo	69
Recording a Video	70
Photo Settings	71
Front Camera	71
Rear Camera	71
Video Settings	72
Front Video Camera	72
Rear Video Camera	73
Photos	73
PTT Express Voice Client	74
PTT Audible Indicators	74
Notification Icons	76
Enabling PTT Communication	76
PTT Communication	77
Creating a Group Call	77
Responding with a Private Response	77
Disabling PTT Express Voice Client Communication	77
Sound Recorder	78
Wireless	79
Introduction	79
Wireless Wide Area Networks	79
Configuring the Access Point Name	79
Locking the SIM Card	80
Monitoring Data Usage	80
Turning on the Data Saver	80

Table of Contents

Setting Data Usage Warning	81
Setting a Data Limit	83
Viewing Mobile Data Usage	85
Wireless Local Area Networks	85
Scanning and Connecting to a Wi-Fi Network	86
Removing a Wi-Fi Network	87
Configuring a Wi-Fi Network	87
Manually Adding a Wi-Fi Network	88
Configuring for a Proxy Server	89
Configuring the Device to Use a Static IP Address	90
Wi-Fi Preferences	90
Additional Wi-Fi Settings	91
Wi-Fi Direct	91
WPS Pin Entry	92
WPS Push Button	92
Wi-Fi Advanced Features	93
Zebra Mobility Extensions	93
Bluetooth	94
Adaptive Frequency Hopping	94
Bluetooth Security	95
Bluetooth Profiles	95
Bluetooth Power States	96
Bluetooth Radio Power	96
Enabling Bluetooth	96
Disabling Bluetooth	97
Discovering Bluetooth Device(s)	97
Changing the Bluetooth Name	98
Connecting to a Bluetooth Device	98
Selecting Profiles on the Bluetooth Device	98
Unpairing a Bluetooth Device	99
Using the NFC Reader	99
Data Capture	100
Introduction	100
Devices for Data Capture	100
Operational Modes	100
Scanning Considerations	101
Range	101
Angle	101
Imaging	101
Using the Barcode Scanner (XPAD Only)	102
Barcode Symbologies	103
RS507x Hands-Free Imager	103
Barcode Capture Using the RS507x	104
Barcode Capture with the RS6000 Bluetooth Hands-free Scanner	105
Barcode Capture with Zebra Scanner	106
Connecting a USB Scanner	107
Connecting Using Simple Serial Interface	107
Connecting Using HID Mode	108
Pairing the RS507x/RS6000 Hands-Free Scanners	108

Table of Contents

Pairing Scanners by Using Simple Serial Interface (SSI)	108
Pairing Scanners by Using Human Interface Device (HID)	109
Pairing a DS3678 Scanner	110
Pairing a DS3678 Scanner Using Simple Serial Interface (SSI)	110
Pairing a DS3678 Scanner Using Human Interface Device (HID)	111
DataWedge	111
Enabling DataWedge	111
Disabling DataWedge	111
Accessories	112
Introduction	112
Docking Solutions	112
Power	113
Input Devices	114
Input Devices: Optional Modules	115
Carrying Accessories	115
Display Maintenance	117
Settings	118
Introduction	118
Setting the Date and Time	118
Display Setting	119
Setting the Screen Brightness	119
Setting Screen Timeout	119
Setting Font Size	119
Setting Screen Rotation	120
General Sound Setting	120
Setting Screen Lock	122
Setting Screen Lock Using PIN	122
Setting Screen Unlock Using Password	123
Setting Screen Unlock Using a Pattern	124
Passwords	125
System Language Usage	125
Adding Languages	125
Selecting a Language	126
Removing a Language	126
Adding Words to the Dictionary	126
Virtual Keyboard Settings	127
Enterprise Keyboard Configuration	127
Enabling Keyboards	127
Configuring the Gboard Keyboard	127
Configuring the Enterprise Keyboard	127
Key Programmer	128
Remapping a Button	128
About Phone	129
Application Deployment	130
Introduction	130

Table of Contents

Security	130
Secure Certificates	130
Installing a Secure Certificate	130
Configuring Credential Storage Settings	131
Development Tools	132
Android	132
Opening Developer Options	132
Enterprise Mobility Developer Kit for Android	133
StageNow	133
GMS Restricted	133
ADB USB Setup	133
Enabling USB Debugging	134
Application Installation	134
Installing Applications Using a microSD Card	134
Installing Applications Using the Android Debug Bridge (ADB)	136
Uninstalling an Application	136
Performing a System Update	137
Downloading the System Update Package	137
Using the microSD Card	137
Using ADB	137
Verifying System Update Installation	138
Performing an Enterprise Reset	138
Downloading the Enterprise Reset Package	139
Using a microSD Card	139
Using ADB	139
Performing a Factory Reset	140
Downloading the Factory Reset Package	140
Using a microSD Card	140
Using ADB	141
Storage	141
Random Access Memory	142
Internal Storage	142
External Storage	144
Formatting a microSD Card	144
Enterprise Folder	145
App Management	146
Viewing App Details	147
Managing Downloads	147
Maintenance and Troubleshooting	148
Introduction	148
Maintaining the L10	148
Operating the Tablet in Cold Ambient Temperatures	148
Battery Safety Guidelines	149
Long-term Battery Storage	149
Disposing of Used Batteries	149
Cleaning	150
Materials Required for Cleaning	150
Cleaning the L10	150
Housing	150

Table of Contents

Display	150
Power Connector	150
Cleaning the Cradle Connector	150
Caring for the Display	151
Caring for the Pen	151
Traveling with Your L10 Tablet	152
Troubleshooting	153
Specifications	154
Technical Specifications	154
Physical Characteristics	154
Performance Characteristics	155
Data Capture	155
Ruggedness and Environment	155
Wireless Communications	156
Sensors	156
Printers	157
Index	1

About the Tablet

Introduction to the L10 Tablet

This guide provides information about using the L10 tablet and accessories.



NOTE: Screens and windows pictured in this guide are samples and can differ from actual screens.

L10 Configurations

There are three models in the L10 platform.
Each is different from the other two as follows:

- XPAD™ L10 is distinguished by its integrated hard handle.
The handle has space for an integrated barcode reader option, two programmable buttons, and a front facing speaker.
- XSLATE™ L10 has no handle but is otherwise like the XPAD.
- XBOOK™ L10 is the same as the XSLATE, but includes a companion keyboard and a KickStrap (combination of a kickstand and a hand strap).



IMPORTANT: All Android features that are documented in this user guide are based on the interface of Android 8.1.0 Oreo. For all important safety information about your tablet, it is necessary to read the L10 Regulatory Guide. Refer to <http://zebra.com/l10-info> and navigate to the L10 User Documentation.

Key Features Overview

The L10 platform is a rugged tablet that provides a range of computing power and a variety of integrated features to support any mobile work flow. The L10 supports the following features:

- Qualcomm SDM660 Platform (CPU).
- 4 or 8 GB of system memory (RAM)
- 64 GB – 128 GB memory storage
- Adreno 512 graphics processor (GPU)
- 10.1" wide viewing angle display with WUXGA resolution (1920 x 1200); 500 Nit brightness standard, option for 1000 Nit View Anywhere® display for viewing in bright sunlight.

- Capacitive display with 10-point touch input
There are three touch modes in **Settings > Display > Advanced > Touch panel mode**:
 - Finger and Wet
 - Finger and Glove
 - Finger and Passive Stylus (default)
- Corning Gorilla Glass 3 for increased display damage resistance;
Capacitive Touch Panel with Multi-Touch operation with optional Active Digitizer
- Integrated 13 MP rear camera and 5 MP front camera
- Two USB 2.0 Type A ports, one USB Type-C port, and a microSD card slot
- Dual Nano SIM (4FF) port
- 9-Axis MEMS sensor (Accelerometer, eCompass, Gyroscope) and ambient light sensor
- Hot-swappable battery, 36 Whr standard battery or 98 Whr long-life battery packs
- Integrated 802.11a/g/n/ac, MuMIMO Wi-Fi, Bluetooth 5.0
- Android 8.1.0 Oreo operating system
- Integrated high-frequency NFC

Optional Features

The following features are optional and must be ordered with the tablet at the time of purchase:

- A high-performance barcode scanner is available and is integrated into the handle of the XPAD L10 tablet.
- Integrated, active Wacom-digitizer display that provides precision pen input and hover features

See also [Input Devices: Optional Modules on page 115](#). The items in that section must be ordered at time of purchase because they must be factory installed.

Software Versions

To determine the current software versions:

1. Swipe down from the Status bar to open the Quick Settings bar.
2. Touch **⚙️ > System > About phone**.
3. Scroll to view the following information:
 - Model
 - Android version
 - Kernel version
 - Build number

To determine the device serial number:

1. Touch **System > About phone > Status**.
2. Note the Serial number.

Chapter Descriptions

Topics covered in this guide are as follows:

- [Getting Started on page 12](#) provides information on getting the tablet up and running for the first time.
- [Using the Device on page 29](#) explains how to use the tablet. This includes instructions for powering on and resetting the tablet, entering and capturing data.
- [Applications on page 51](#) provides information on using applications installed on the L10.
- [Wireless on page 79](#) explains how to perform Bluetooth functionality on the tablet.
- [Data Capture on page 100](#) explains how to capture data using the optional scanners.
- [Accessories on page 112](#) describes the accessories available for the tablet.
- [Settings on page 118](#) describes some basic settings for configuring the device.
- [Application Deployment on page 130](#) describes Android procedures for including new security features, how to package applications, and procedures for deploying applications on the device.
- [Maintenance and Troubleshooting on page 148](#) includes instructions on cleaning and storing the tablet, and provides troubleshooting solutions for potential problems during tablet operation.
- [Specifications on page 154](#) includes a table listing the technical specifications for the tablet.

Notational Conventions

The following conventions are used in this document:

- Tablet refers to any of the three L10 Android tablets.
- Bold text is used to highlight the following:
 - Dialog box, window and screen names
 - Drop-down list and list box names
 - Check box and radio button names
 - Icons on a screen
 - Key names on a keypad
 - Button names on a screen.
- Bullets (•) indicate:
 - Action items
 - Lists of alternatives
 - Lists of required steps that are not necessarily sequential.
- Sequential lists (step-by-step procedures) appear as numbered lists.

Related Documents and Software

The following documents provide more information about the L10 tablets.

- L10 Quick Reference Guide, p/n MN-003429-xx_
- RS507x Hands-free Imager Product Reference Guide, p/n 72E-120802-xx

For the latest version of this guide and all guides, go to: zebra.com/support.

Service Information

If you have a problem with your equipment, contact Zebra Global Customer Support for your region. Contact information is available at: zebra.com/support.

When contacting support, please have the following information available:

- Serial number of the unit
- Model number or product name
- Software type and version number.

Zebra support responds to calls by email, telephone, or fax within the time limits set forth in support agreements.

If your problem cannot be solved by Zebra Customer Support, you might need to return your equipment for servicing and will be given specific directions. Zebra is not responsible for any damages incurred during shipment if the approved shipping container is not used. Shipping the units improperly can possibly void the warranty.

If you purchased your Zebra business product from a Zebra business partner, contact that business partner for support.

Getting Started

Introduction

This chapter explains how to set up the Zebra® L10 device for the first time.

Unpacking the Tablet

Carefully remove all protective material from around the L10 and save the shipping container for later storage and shipping.

Verify that you received all equipment listed below:

- Tablet with lithium-ion battery
- Regulatory Guide.
- Stylus
- Power supply

Inspect the equipment for damage. If you are missing any equipment or if you find any damaged equipment, contact the Zebra Support Center immediately. See [Service Information on page 11](#) for support information.



IMPORTANT: For warranty information, refer to the web site, zebra.com/support. Under Support and Downloads, touch **Tablets > L10 Series Tablets > Warranty Information**.

Overview of the XSLATE Tablet

The following photos show the location of the external features on the XSLATE™ L10 tablet. Most of these features are on the XPAD™ tablet in the same place, except for the handle of the XPAD tablet.

Front of the XSLATE L10

Figure 1 XSLATE Android Front Side



Table 1 XSLATE Front Features

Item	Description
1	Two digital microphones make up the microphone array facing forward
2	The ambient light sensor (ALS) detects the amount of ambient light, and the device adjusts the screen brightness
3	The front 5-megapixel camera has FHD resolution if enabled in the settings. You can adjust size and quality of picture.
4	The Power LED indicates the current power state of the tablet
5	The Battery LED indicates the charging status of the battery.
6	The Reset switch lets you force the tablet to power down.
7	The touchscreen is the standard means for interacting with the operating system and software.
8	The Home button displays the Home screen.

Figure 2 XSLATE Back Side



Table 2 XSLATE Back Features

Item	Description
1	The pen holder holds the short, capacitive pen when not in use.
2	The battery latch releases the battery when you slide the latch to the left.
3	This light is a flash for the rear camera and can be used as a flashlight.
4	The rear 13-megapixel camera has Full HD resolution.
5	The Kensington lock slot is a metal-reinforced hole for use with a cable and lock to secure the tablet.
6	Near Field Communication (NFC) allows devices to exchange information by placing them next to one another.
7	The expansion port cover is removed when connecting certain optional accessories to the tablet.
8	This speaker provides sound when no headset or external speakers are in use.
9	The battery powers the tablet when it is not plugged in or docked.

Figure 3 Right Side of the XSLATE L10



Table 3 Right Side Features

Item	Description
1	Power input connection for the external power adapter
2	Ethernet jack RJ45 port for LAN connectivity
3	Volume control button
4	The round button is a toggle between screen-rotation lock and auto-rotation of the screen.
5	The oval Power button turns on the tablet. When the tablet is on, press to enter and exit sleep mode.

Figure 4 Left Side of the XSLATE L10



Table 4 Left Side Features

Item	Description
1	The memory card slot reads and writes microSD cards.
2	The USB type-C port provides access to USB 3.1 and DisplayPort output through a type-C connector.
3	Two USB 2.0 type-A ports let you connect devices such as a mouse, keyboard, or external storage.
4	The 3.5 mm audio jack supports stereo output for headset and mono input for an external microphone.
5	This locking door covers the ports on the L10. When the tablet is shipped, the door is locked and the latch shows green. Slide the lock to reveal red and open the door to access the ports. To secure the door for travel or storage, close it firmly and slide the lock until the green appears.

Figure 5 Bottom Side of XSLATE and XPAD Tablets



Table 5 Docking Connectors

Item	Description
1	The docking connectors interface to docks.

Overview of the XPAD L10 Tablet

The following photos show the locations of the external features on the XPAD™ L10 tablet. In these photos, most of the features are the same on the XSLATE as on the XPAD. Most of the differences are in the handle.

Front of the XPAD L10

Figure 6 XPAD Front



Table 6 XPAD Front Features

Item	Description
1	Two digital microphones make up the microphone array facing forward.
2	Programmable function buttons, P1 and P2.
3	The ambient light sensor (ALS) detects the amount of light, and adjusts the screen brightness.
4	Pen holder for the long pen, built in to the handle of the XPAD.
5	The 5-megapixel camera has Full HD resolution.
6	The built-in speaker provides sound when no headset or external speakers are in use.
7	The Power LED indicates the current power state of the tablet
8	The Battery LED indicates the charging status of the battery.
9	The Reset switch lets you force the tablet to shut down, in case nothing else works.

Table 6 XPAD Front Features (Continued)

Item	Description
10	The touchscreen is the standard means for interacting with the operating system and software.
11	The Home button displays the Home screen.

Back of the XPAD L10

Figure 7 XPAD Back



Table 7 XPAD Back Features

Item	Description
1	The tether post for a pen secures the pen to the tablet by a tether.
2	The camera light functions as a flash for the rear camera as well as a torch light.
3	The rear 13-megapixel camera has Full HD resolution.
4	The Kensington lock slot is a metal-reinforced hole for use with a cable and lock to secure the tablet.

Table 7 XPAD Back Features (Continued)

Item	Description
5	Near Field Communication (NFC), is an optional technology that lets devices exchange information.
6	The expansion port cover is removed when connecting certain optional accessories to the tablet.
7	The hot-swappable battery powers the tablet when it is not plugged in or docked.
8	The battery latch releases the battery when you slide the latch to the left.

Left Side of the XPAD L10

Figure 8 XPAD Left Side



Table 8 Left Side Features

Item	Description
1	The barcode scanner is the built-in optical interface for reading barcodes.
2	The memory card slot reads and writes microSD cards.
3	The USB type-C port provides access to USB 3.1 and DisplayPort output through a type-C connector.
4	Two USB 2.0 ports (type-A) let you connect devices, such as a mouse, keyboard, or external storage.
5	The 3.5 mm audio jack supports stereo output for headset and mono input for an external microphone.
6	This locking door covers the ports on the L10. When the tablet is shipped, the door is locked and shows green. Slide the lock to reveal red and open it.

Figure 9 Right Side of the XPAD L10

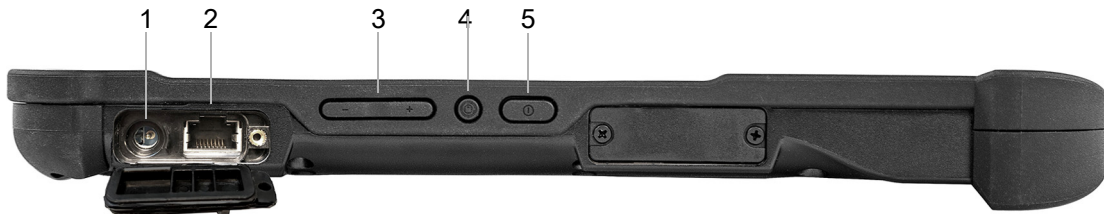

Table 9 Right Side Features

Item	Description
1	Power input connection for the external power adapter
2	Ethernet jack RJ45 port for LAN connectivity
3	Volume control button
4	The round button is a toggle between screen-rotation lock and auto-rotation of the screen.
5	The oval Power button turns on the tablet. When the tablet is on, press to enter or exit sleep mode.

Top Side of the XPAD L10

Figure 10 XPAD Top Side



Table 10 XPAD Top Side

Item	Description
1	Use the pen holder in the handle to hold the long pen when it is not in use
2	Press the scanner button to activate the barcode scanner (if installed).

Preparing the L10 Tablet for First Use

The following sections explain how to insert a SIM card and power up the tablet.

Inserting a SIM Card



IMPORTANT: Before you can connect to a mobile broadband network, you must have an active account with a cellular network provider, and a SIM card in your tablet for mobile broadband access. This SIM card works like the SIM card in your cell phone that connects you to a network provider.

The SIM card holder accommodates two Nano SIM (4FF) cards, for use with the mobile broadband option. If inserting only one SIM card, place it in the holder labeled **SIM1**. If inserting two SIM cards, put the card for the primary carrier in **SIM1** and the card for the secondary carrier in **SIM2**.

1. Turn off the tablet.
2. If you have already put the battery in the tablet, remove it.
The SIM card(s) fit into a tray in the battery bay.
3. Find and gently remove the SIM holder tray so the slot is empty.

Figure 11 Two SIM Cards in Holder

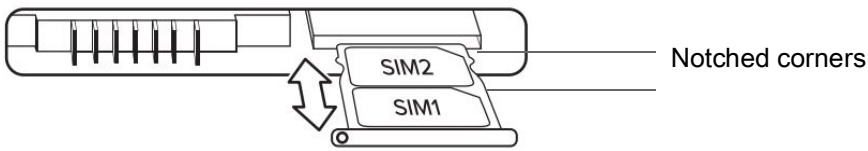

Figure 12 SIM Card Slot with Holder



4. Place the SIM card into the holder so that it is close to flush with the holder. Make sure that the SIM contacts (gold) are facing down and the notched corner is on the right side as shown in this drawing and in the graphic inside the battery bay of the tablet.
5. Carefully align the SIM holder with the opening of the SIM holder connector. Gently slide the SIM holder tray into the connector until it stops.
6. Put the battery in the tablet. See [Replacing the Battery on page 27](#).

Powering Up the Tablet

This section explains installing the battery, connecting the tablet to external power, and powering up the tablet.

1. If you have not yet inserted the battery, remove it from the packaging. On the back of the tablet, insert the bottom of the battery into the bay. Tilt the tray as shown and press it down until it clicks securely into place.

Figure 13 Installing the Battery



2. The external power has two parts: the part that plugs into the power source and the adapter with a cord that plugs into your tablet. Join the two parts by plugging the power cord into the adapter to form one long cord.
3. To connect external power to the tablet, open the port door to expose the power adapter port. Plug the AC adapter into this port on your tablet.

Figure 14 Power Adapter Port



4. Plug the power cord into an outlet.
The battery charging indicator on the front of the L10 tablet blinks amber to indicate that the battery is charging. It is solid green when fully charged
5. Press and release the oval **Power** button in the center of the right side of the tablet to turn it on.

Figure 15 Power Button



6. Keep the tablet on AC power until the battery is fully charged. However, you Do not have to wait until the tablet is fully charged to turn it on. The L10 will charge while you use it.

Pens for the L10 Tablets

All L10 tablets support touch input with your finger. In addition, a pen or stylus is provided with your tablet, and is compatible with the screen configuration that you order. Many people use a pen for more convenience or precision. The pen is particularly effective for precise data entry and navigation.

The XSLATE and XBOOK tablets come with short pens that fit into the pen holder on these devices. The XPAD tablet includes a longer, thicker pen. If you want a longer pen for the XSLATE or XBOOK tablet, a handle accessory can be ordered with the longer pen.

Capacitive Pens

Capacitive pens work with the tablet's touchscreen and are sometimes called *passive* pens. The short capacitive pen does not need a battery. The long capacitive pen uses a AAAA battery. These two pens do not require a pen digitizer in the tablet. They work with the tablet's touchscreen directly.

Figure 16 Capacitive Pens

Short Capacitive Pen



Long Capacitive ePen w/battery



Active Digitizer Pens

If the tablet is ordered with an active Wacom digitizer built in to the screen, you will receive one of the two pens pictured below. These Wacom-compatible pens allow for a large range of pressure sensitivity, tilt detection, and hover capability. Hover lets you see where the pen is pointing before the tip touches the display. These pens are frequently called active pens. These active pens use all three modes of the touch screen:

- Finger and Wet
- Finger and Glove
- Finger and Passive Stylus (default)

Figure 17 Digitizer Pens

Short Active Digitizer Pen



Long Active Digitizer Pen



Optional Setup Tasks

Attaching the Pen Tether

The pen comes with a tether so that you can attach it to your tablet to avoid misplacing it.

1. Slip one end of the tether through the hole at the end of the pen, and pull the pen through the loop until it is tight.
2. Slip the other end of the tether through the attach point on the tablet, then pull the pen through the loop until it is tight.

Connecting the Tablet to an External Monitor

There is no dedicated port for an external monitor on the L10 tablet. The tablet has a USB Type-C connector which includes a DisplayPort output capability. You need a dongle that supports USB Type-C DisplayPort and converts it to the port necessary to attach the external monitor, which can have one or more of the following ports: HDMI, DVI, DisplayPort, or VGA.

For instance, to connect a monitor with an HDMI port to your tablet, you need a USB Type-C DisplayPort to HDMI output dongle.





NOTE: Some dongles use USB to Video conversion and these use software to enable the external display over USB interface. Care must be taken to ensure the USB Type-C dongle specifically supports USB Type-C DisplayPort input. Look for a dongle that states it is plug-n-play and that no software or drivers are required.

Battery Management



NOTE: Prior to checking the battery charge level, remove the device from any AC power source (cradle or cable).

1. To check the charge status of the main battery, touch  and then touch **System**.
2. Touch **About phone > Battery Information**.
3. The Battery Manager displays details about the battery.

Alternately, swipe up from the bottom of the screen and touch  to open the **Battery Manager** application. Touch **Advanced info**.

Battery present status indicates if the battery is present and **Battery level** shows the battery charge (as a percentage of fully charged). The battery percentage can also be viewed next to the battery icon on the Status bar at the top of the screen, on the Quick Settings bar, and on the Quick Access panel. Swipe down with two fingers from the status bar to open the Quick Access panel.



IMPORTANT: In cold temperatures, see [Operating the Tablet in Cold Ambient Temperatures on page 148](#).

Monitoring Battery Usage

The Battery screen provides battery charge details, power management options, and a list of apps that consume the most battery power.

Use the power management options to extend battery life, or touch an app to display details about its power consumption. Different apps display different information. Some apps include buttons that open screens with settings to adjust power use. Use the DISABLE or FORCE STOP buttons to turn off apps that consume too much power.

1. Swipe down from the Status bar to open the Quick Settings bar and then touch .
2. Touch **Battery** to display the Battery screen.

Figure 18 Battery Screen



Low Battery Notification

When the battery is low on power, the L10 tablet notifies you as follows:

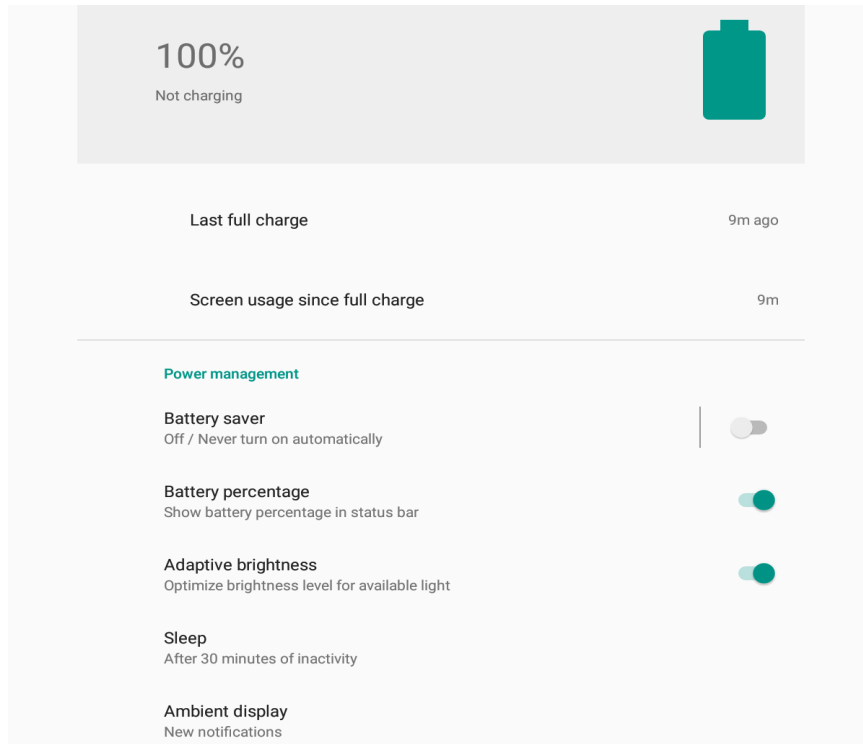
- When the battery charge drops below 10%, the tablet displays a notice to connect the device to power. Put another battery into the tablet or connect the device to a power source. Charge the battery using one of the charging accessories.
- When the battery charge drops below 5%, the tablet displays a notice to connect the device to power. Charge the battery using one of the charging accessories.
- When the battery charge drops below 3%, the device turns off. You must charge the battery using one of the charging accessories.



NOTE: Under conditions of heavy load (scanning quickly and often, RF communication, and other functions.) the device might turn off earlier than a remaining charge of 5%.

Figure 19 Low Battery Notification

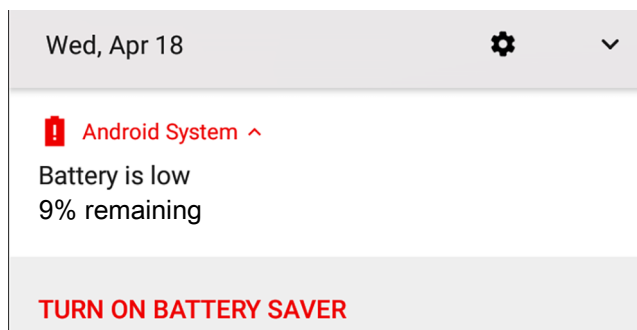

Battery Optimization

When the battery is low and recharging is not possible, you can use the following battery saving tips:

- Disable DataWedge Launcher profile. See [Disabling DataWedge on page 111](#)
- Set the screen to turn off after a short period of disuse.
- Reduce screen brightness.
- Turn off all wireless functions when not in use.
- Turn off automatic syncing for Email, Calendar, Contacts, and other apps.
- Minimize use of apps that keep the device from suspending, such as music and video apps.

Back of Battery Charge Indicators

You can check the charge of a battery when it is out of the tablet by pressing the battery check button on the back side.



IMPORTANT: If you remove the battery while the tablet is running, you only have one minute to replace it to keep the tablet running. If you need to remove it for a longer period, be sure to save your files. Then shut down or plug in to a power source.

If you have a battery out of the tablet, you can check the charge by looking at the back side and pressing the button to the left of the lights to view the charge level.

Figure 20 Battery Check Button



The five lights on the back of the battery indicate the current level of charge—from one light (20% charged) to five lights (100% charged).

Removing and Replacing the Battery

Before removing the battery, save your files and power off the tablet, or plug in the AC adapter and continue working while the battery charges. However, if you are hot swapping the battery, you can do so while the tablet is on and running only on battery power. See [Hot Swapping the Battery](#) on page 28.

Removing the Battery

To remove the battery:

1. Save files and shut down the tablet.
2. With the back of the tablet facing you, slide the battery latch to the left until the latch stays open and the battery pops out slightly. A red is displayed instead of the green dot.
3. Insert your finger under the finger tab and pull to remove the battery from the battery compartment.

Figure 21 Battery Removal



Table 11 Battery Removal

Item	Description
1	Sliding battery latch
2	Pull-out battery tab

Replacing the Battery

1. Place the tabbed end of the battery into the battery compartment as shown here.
2. Press the battery down until it snaps into place.

Figure 22 Battery Replacement



Hot Swapping the Battery

Replacing a battery while the tablet is on is called hot swapping. You can hot swap a battery only if you have a second, charged battery to replace it with.



IMPORTANT: You have approximately one minute to hot swap the battery. If you have not replaced the battery within one minute, the tablet goes into Sleep mode.

1. Remove the battery.
2. Insert the new battery.

While hot swapping the battery, notice the following behaviors:

- The tablet display gets dimmer. When the charged battery is in the tablet, the display brightens again.
- The battery status LED turns blue when the system is on and no main battery is present. When you put a charged battery in the tablet, the LED lights turn green again.
- The power button is disabled. (The power button is disabled at any time the tablet has no battery and is not running on AC power through the power adapter.)

Using the Device

Introduction

This chapter describes the screens, status, notification icons, and controls on the tablet, and provides basic instructions for using the Zebra L10 tablet.

Google Mobile Services



NOTE: This section only applies to L10 configurations with Google™ Mobile Services (GMS).

The L10 tablet with GMS contains applications and services that provide additional functionality to the tablet. GMS includes:

- **Applications** – GMS adds a variety of Google™ applications and associated widgets including Chrome, Gmail, Drive, and Maps.
- **Services:**
 - **Speech to Text** – Allows for free format speech to text, in many languages for both connected and disconnected network. Launch by touching the microphone icon on the keyboard.
 - **TalkBack Service** – Provides spoken feedback on many parts of the user interface. To enable this spoken feedback, touch **Settings > Accessibility**.
 - **Network Location Provider** – Adds a location provider, which uses mobile network tower information and Wi-Fi access point information to provide a location without using GPS. To enable, go to **Settings > Security & Location > Location**.
 - **Widevine DRM** – Enables the digital rights management so that protected content can be played. Enable via DRM Info from the Play Store.
 - **Google Cloud Messaging** – Lets you send data from your server to your tablet and also lets you receive messages from devices on the same connection.
 - **Backup and Restore** – Lets you back up your settings and applications to a Google server and then restore them from that server after a factory reset.

Home Screen

If you need to unlock the tablet upon startup, See [Unlocking the Screen on page 43](#).

The Home screen displays when the L10 starts up. Depending upon the configuration, the Home screen might appear to be different. Contact your system administrator for more information.

After a suspend or screen time-out, the Lock screen displays. Slide up to unlock the screen if no security is set. For screen locking information see [Unlocking the Screen on page 43](#).

Figure 23 Home Screen

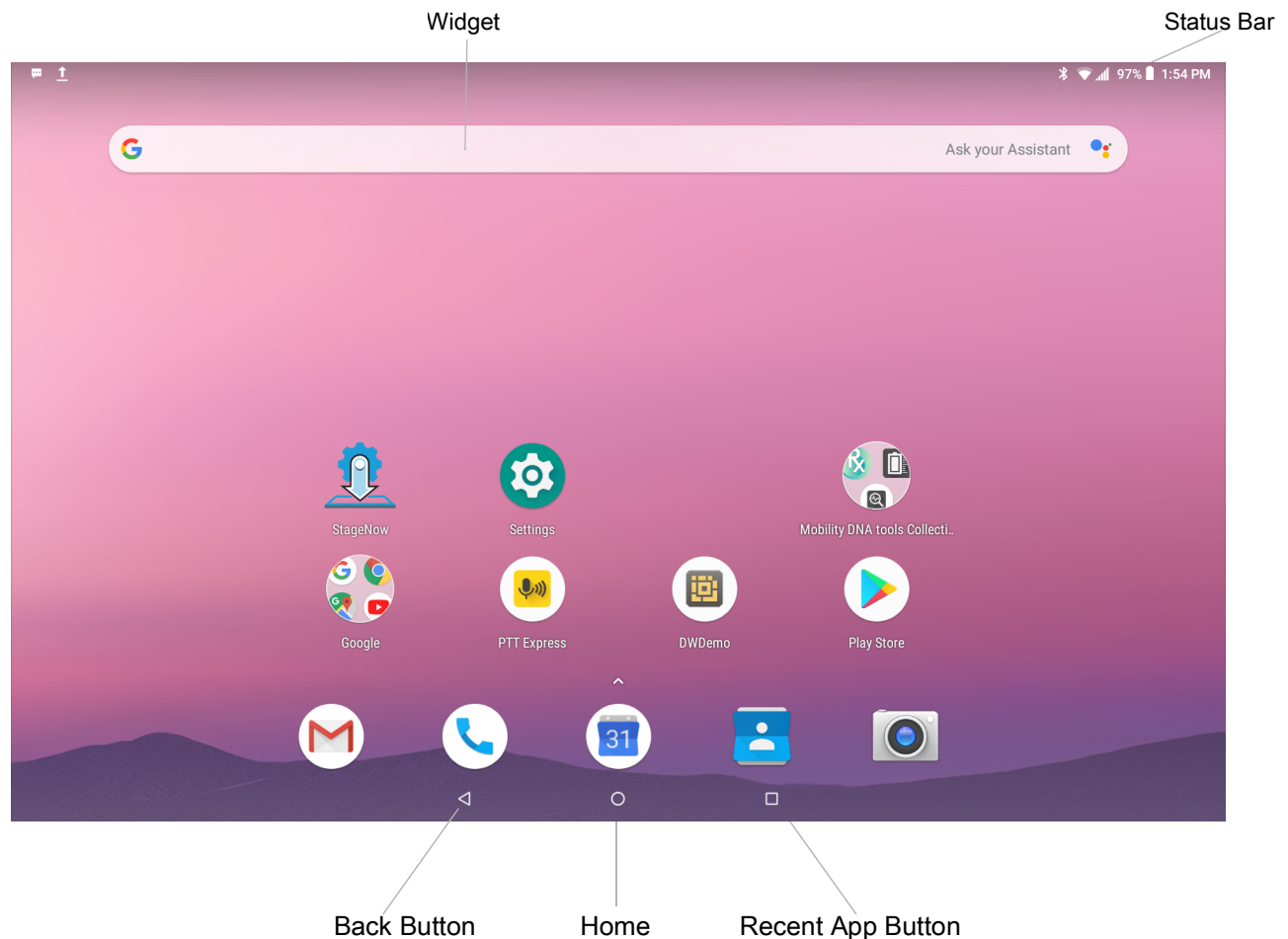

NOTE: You can configure the Home screen icons and the screen might look different than shown.

The Home screen provides four additional screens for placement of widgets and shortcuts. Swipe the screen left or right to view the additional screens.

Status Bar

The Status bar displays the time, notification icons (left side) and status icons (right side).

If there are more notifications than can fit in the Status bar, displays indicating that more notifications exist. Open the Notifications panel to view all notifications and status.

Status Icons

Table 12 Status Icons



























Icon	Description
	Indicates that the Alarm is active.
	Indicates that the ringer is silenced.
	Indicates that the main battery is fully charged.
	Indicates that the main battery is partially drained.
	Indicates that the main battery charge is low.
	Indicates that the main battery charge is very low.
	Indicates that the main battery is charging.
	All sounds, except media and alarms, are silenced and vibrate mode is active.
	Do Not Disturb mode active.
	Indicates that the Airplane Mode is active. All radios are turned off.
	Indicates that Bluetooth is on.
	The device is connected to a Bluetooth device.
	Indicates the tablet is connected to a Wi-Fi network.
	Not connected to a Wi-Fi network or no Wi-Fi signal.
	Indicates that the tablet is connected to an Ethernet network.
	Portable Wi-Fi hotspot is active.
	Indicates that all sounds except media and alarms are silenced.

Table 12 Status Icons

Icon	Description
	Indicates that a Bluetooth headset is connected to the tablet.
	Indicates that Do Not Disturb Alarm only or Priority only mode is enabled.
	Indicates that Do Not Disturb Total Silence mode is enabled.
	Connected to a 4G LTE/LTE-CA network.
	Connected to a DC-HSPA, HSDPA, HSPA+, HSUPA, LTE/LTE-CA or WCDMA network.
	Connected to a WCDMA network.
	Connected to a DC - HSPA, HSDPA, HSPA+ or HSUPA network.
	Roaming from a network.
	No SIM card installed.

Notification Icons

Table 13 Notification Icons

















Icon	Description
	Indicates that more notifications are available for viewing.
	Indicates that data is syncing.
	Indicates an upcoming event.
	Indicates that an open Wi-Fi network is available.
	Indicates that a song is playing. (L10 with GMS).
	Indicates that a problem with sign-in or sync has occurred.
	Indicates that the tablet is uploading data.
	Indicates that the tablet is downloading data when animated and download is complete when static.
	Indicates that the tablet is connected via USB cable.
	Indicates that the tablet is connected to or disconnected from virtual private network (VPN).

Table 13 Notification Icons (Continued)

Icon	Description
	Preparing Internal Storage.
	Indicates that USB debugging is enabled on the L10.
	Indicates that a Expansion Pack is installed and in HID Mode.
	Indicates that the RxLogger application is running and capturing data.
	Indicates that the RS507x is connected to the L10.
	Indicates that user attention is required.

Managing Notifications

Notification icons report the arrival of new messages, calendar events, and alarms, as well as ongoing events. When a notification occurs, an icon may appear in the Status bar with a brief description. See [Notification Icons on page 32](#) for a list of possible notification icons and their description. Open the Notifications panel to view a list of all the notifications.

To open the Notification panel, drag the Status bar down from the top of the screen.

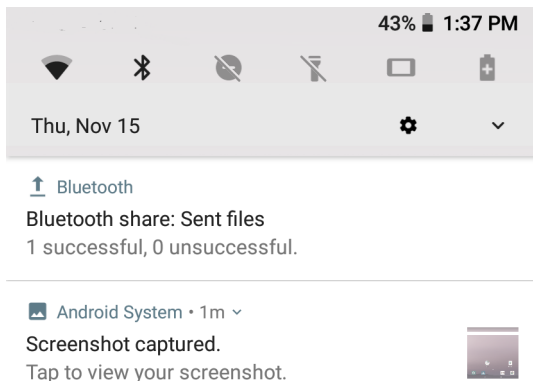
Figure 24 Notification Panel

To respond to a notification, open the Notifications Panel and then touch a notification. The Notifications Panel closes and the subsequent activity is dependent on the notification.

To clear all notifications, open the Notifications Panel and then touch **CLEAR ALL**. All event-based notifications are removed.

Ongoing notifications remain in the list.

To close the Notification Panel, swipe the Notifications Panel up.

Quick Settings

Use the Quick Access panel to get to frequently used settings, like turning on Airplane mode. To open the Quick Access panel, swipe down from the top of the screen with two fingers, or twice with one finger.

Figure 25 Quick Access Panel

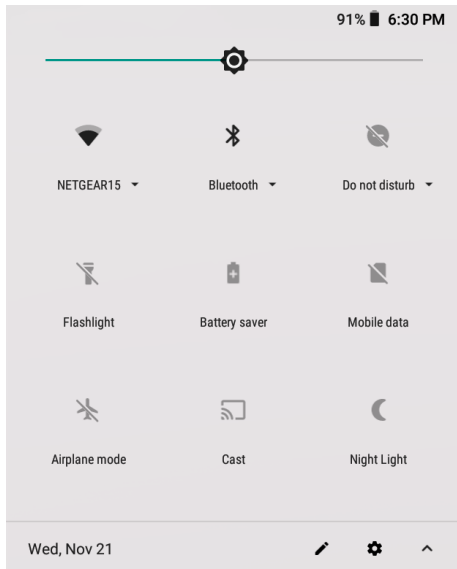

To change a setting, just touch the icon:

- Display brightness: Slide to lower or increase the brightness of the screen.
- Wi-Fi network: Turn Wi-Fi on or off. To open Wi-Fi settings, touch the Wi-Fi network name.
- Bluetooth settings: Turn Bluetooth on or off. To open Bluetooth settings, touch the **Bluetooth**.
- Do not disturb: Control how and when to receive notifications.
- Flashlight: Turn camera flash on and off.
- Battery saver: Turn on or off.
- Mobile data: Turn on or off.
- Airplane mode: Turn airplane mode on or off. Airplane mode means device will not connect to Wi-Fi or Bluetooth.
- Cast: Displays tablet screen on another device.
- Night Light: Turns screen to night time frequency (to cut blue light frequency). Toggles between day and night screen.

Application Shortcuts and Widgets

Application shortcuts placed on the Home screen allow quick and easy access to applications. Widgets are self-contained applications placed on the Home screen to access frequently used features.

Adding an Application or Widget to the Home Screen

1. Go to the Home screen that displays your app.
2. Swipe right, if necessary, to find the application icon or widget.
3. Touch and hold the icon or widget until the Home screen appears.
4. Position the icon on the screen and then release.

Moving Items on the Home Screen

1. Touch and hold the item until it floats on the screen.
2. Drag the item to a new location. Pause at the edge of the screen to drag the item onto an adjacent Home screen.
3. Lift finger to place the item on the Home screen.

Removing an App or Widget from the Home Screen

1. Go to the Home screen where the item resides.
2. Touch and hold the application shortcut or widget icon until it floats on the screen.
3. Drag the icon to **X Remove** at the top of the screen and then release.

Folders

Use Folders to organize similar applications together. Tap the folder to open and display items in the folder.

Using the Touchscreen

Use the multitap sensitive screen to operate the device.

- **Touch** – Use a finger to
 - select items on the screen
 - type letters and symbols using the on-screen keyboard
 - press on-screen buttons
- **Touch and Hold** – Press and hold your finger on
 - an item on the Home screen to move it to a new location or to the trash
 - an item in Apps to create a shortcut on the Home screen
 - the Home screen to open a menu for customizing the Home screen
 - an empty area on the Home screen until the menu appears
- **Drag** – Touch and hold an item for a moment and then move your finger on the screen until reaching the new position. Lift your finger to leave the icon in the new position.

- **Swipe** – Move finger up and down or left and right on the screen to:
 - unlock the screen
 - view additional Home screens
 - view additional application icons in the Launcher window
 - view more information on an application's screen.
- **Double-touch** – Touch twice on a web page, map, or other screen to zoom in and out.
- **Pinch** – In some applications, zoom in and out by placing two fingers on the screen and pinching them together (to zoom out) or spreading them apart (to zoom in).
- There are three touch modes in **Settings > Display > Advanced > Touch panel mode**:
 - Finger and Wet
 - Finger and Glove
 - Finger and Passive Stylus (default)
 The active pen works in all three modes.

Setting Screen Rotation

By default, screen rotation is enabled. To disable screen rotation, follow this procedure:

1. On the Home screen, touch the **Settings** icon. 
2. Touch **Display > Advanced** to view the Display menu.
3. Touch **Auto-rotate screen** to turn auto-rotate on or off.

You can also press the round button on the right side of the tablet to lock or unlock the automatic rotation of the screen. See [Table 3 on page 15](#).

4. Touch the Home button, , to return to the Home screen.

Using the On-screen Keyboard

Use the on-screen keyboard to enter text in a text field. To configure the keyboard settings, touch and hold the comma key and select  and then select **Android Keyboard Settings**.

Figure 26 On-screen Keyboard

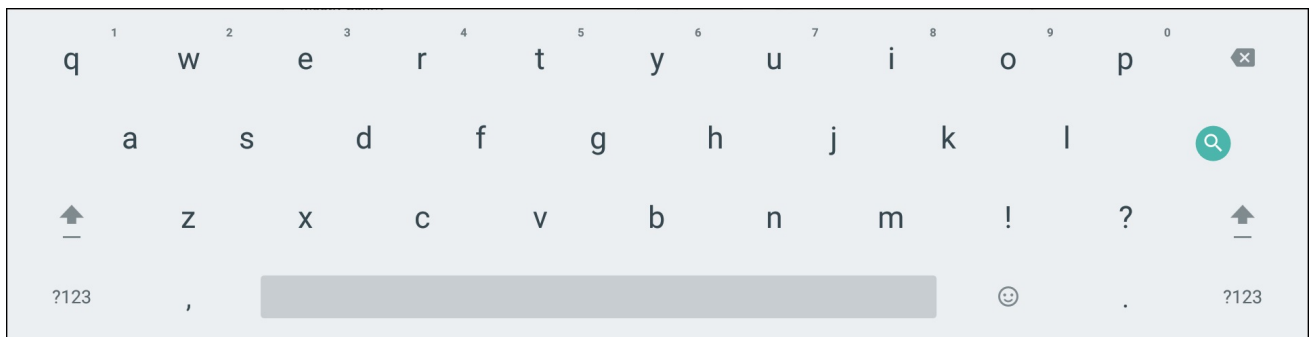

Editing Text

Edit entered text and use menu commands to cut, copy, and paste text within or across applications. Some applications do not support editing some or all of the text they display; others might offer a different way to select text.

Entering Numbers, Symbols, and Special Characters

To enter numbers and symbols, experiment with these instructions:

- Touch and hold one of the top-row keys until a menu appears. Then select a number.
- Touch and hold the **Shift** key with one finger, touch one or more capital letters or symbols to enter them, and then lift both fingers to return to the lowercase keyboard.
- Touch the **Shift** key twice to lock capital letters. Touch **Shift** again to return to the lowercase keyboard.
- Touch **?123** to switch to the numbers and symbols keyboard.
- Touch the **=\<** key on the numbers and symbols keyboard to view additional symbols.
- Touch the  key to switch to the emoji keyboard.

To enter special characters, touch and hold a number or symbol key to open a menu of additional symbols. A larger version of the key displays briefly over the keyboard.

Using the Cameras

The L10 tablet includes front and back cameras.

It is necessary to use an application to enable either of the cameras. Applications that record video or perform video conferencing will recognize these cameras and enable them as required.

For details about the Camera application, see [Camera on page 67](#) of the Applications chapter.

Front Camera

The front camera is a 5-megapixel camera that supports color images and streaming video. It's on the front of the tablet so it can be used for web-based audio/video communication, such as the Skype® application.

Rear Camera

Use the rear camera to take pictures or videos and save them to your hard drive. The rear camera is a 13-megapixel, autofocus camera. The camera lens is on the back of the tablet and includes a light to illuminate the subject.

Rear Camera Tips

- Hold the camera steady and give it a few seconds to focus.
- If your pen is tethered, ensure that the tether is not in front of the camera lens.
- If a soft handle is attached, ensure it is being held away from the camera lens.
- Make sure you have adequate lighting to take your photo. If not, use the flash.

Using the Built-in Microphones

Use the built-in array microphones to record audio, dictate notes, and use voice commands. The two microphones work together to optimize sound detection for speech recognition and voice recording. It is necessary to use an application to enable the microphones. Applications that record video, sound or perform video conferencing recognize these microphones and enable them.

By default, the device routes audio through the 3.5 mm jack when an audio device is plugged in to the audio jack on the left side of the tablet.

Using the SD Card Reader

The L10 tablet includes a card slot for adding a microSD memory card. The memory card provides extra storage for media files from your camera, videos, downloaded files, and data from other devices.

Figure 27 microSD Card Slot



Inserting a microSD Card

1. Turn off the tablet.
2. Open the port cover of the left side of the tablet and locate the microSD card slot.
3. Push the SD card with the contacts facing down into the slot until it clicks into place.
4. Resume using the tablet.

Removing a microSD Card

1. Turn off the tablet.
2. Open the port cover.
3. Push the card in slightly until it pops out.
4. Close the port cover. Press the power button to turn on the tablet.

Using the XPAD Programmable Function Buttons

Use the programmable function buttons on the front of the XPAD L10 tablet to open files and to perform many functions without having to use the pen. You can customize these buttons by modifying their functions.

Figure 28 Programmable Function Buttons



These two buttons have default functions as shown in this table.

Table 14 XPAD Programmable Buttons

Button	Default Function
P1	Displays the Home screen.
P2	Displays the screen for accessing images (photos, screenshots), videos, and audio.

You can customize these buttons to provide other functions. See [Key Programmer](#) on page 128.

Applications

The APPS screen displays icons for all installed applications. This table below lists the applications installed on the L10 platform. Refer to the L10 Integrator Guide for information on installing and removing applications.

Table 15 Applications





Icon	Description of Application
	Battery Manager – Displays information about the battery, including charge level, time left before empty, voltage, temperature, serial number, status, capacity, and wear level.
	Bluetooth Pairing – Use to pair the RS507 Hans-free Imager with the L10 by scanning a bar code.
	Calculator – Provides the basic and scientific arithmetic functions.
	Calendar – Use to manage events and appointments. L10 with GMS only.

Table 15 Applications













Icon	Description of Application
	Camera – Use to take photos and record videos. Use the camera application to control this apparatus and to take advantage of camera features. For details about the Camera application, see Camera on page 67 of the Applications chapter.
	Chrome – Use to access the Internet or intranet. L10 with GMS only.
	Clock – Use to schedule alarms for appointments or as a wake-up.
	Contacts – Use to manage contact information.
	DataWedge – Enables data capture using the imager.
	Device Central – Displays detailed information about the L10 and connected peripherals.
	Diagnostic Tool – Use to diagnose the device. See Diagnostic Tool on page 60 for more information.
	Drive – Upload photos, videos, documents, and other files to personal storage site. L10 with GMS only.
	DWDemo – Provides a way to demonstrate the data capture features using the imager. See DataWedge Demonstration on page 55 for more information.
	Duo – Makes high-quality video calls over Wi-Fi or Data connections.
	Files – Organize and manage files on the L10. See Files on page 57 for more information.
	Gmail – Use to send and receive email using a Google email account. L10 with GMS only.
	Google – Launches Google search application. L10 with GMS only.

Table 15 Applications















Icon	Description of Application
	Keep Notes – Use to create, edit, view, and share notes. L10 with GMS only.
	License Manager – Use to manage software licenses on the device, including sources and notifications.
	Maps – Use to see you location on a map (with public transit, traffic or satellite overlays). Search for any business or place of interest. Provides turn-by-turn navigation with voice guidance and traffic-avoidance and alternate routes, for drivers, cyclist, walkers and users of public transportation. L10 with GMS only.
	Messaging – Use to create, edit, view, and share notes. L10 with GMS only. WAN devices only. Send SMS and MMS messages.
	MSRN – Mobile Station Roaming Number (MSRN) is a telephone number temporarily assigned to a mobile station which roams into another numbering area. Use to verify authenticity of a paired device.
	Phone – Use to dial a phone number when used with some Voice over IP (VoIP) clients (VoIP telephony ready only). WAN devices only.
	Photos – Use to sync photos with Google account. L10 with GMS only.
	Play Movies & TV – View movies and video on your device. L10 with GMS only.
	Play Music – Use to listen to music. L10 with GMS only.
	Play Store – Download music, movies, books, and Android apps and games from the Google Play™ store L10with GMS only.
	PTT Express – Use to launch PTT Express client for VoIP communication.
	RxLogger – Use to diagnose device and application issues. See the L10 Integrator Guide for more information.
	RxLoggerUtility – This utility is a data monitoring application for viewing logs in the device while RxLogger is running. Access the logs and RxLogger Utility features in the App View or the Overlay View.

Table 15 Applications

Icon	Description of Application
	Settings – Use to configure the tablet.
	Sound Recorder – Use to record audio.
	StageNow – Allows the L10 to stage a device for initial use by initiating the deployment of settings, firmware and software.
	WorryFree WiFi – Use to Use to diagnose surrounding area and display network stats, such as coverage hole detection, or AP in vicinity. Refer to the Worry Free Wi-Fi Analyzer Administrator Guide for Android.
	YouTube – Use to view videos on the YouTube web site. L10 with GMS only.
	Zebra Bluetooth – Use to configure Bluetooth logging.

Accessing Applications

All applications installed on the device are accessed using the **APPS** window.

1. Go to the Home screen, by touching the Home button. ○.

Figure 29 APPS Window

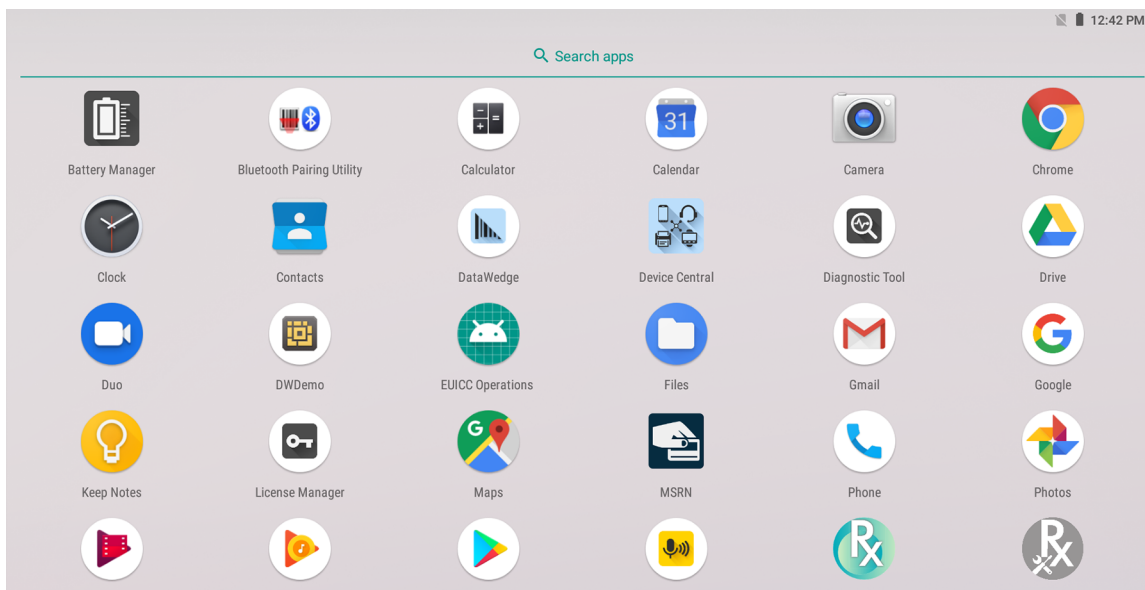

2. Slide the **APPS** window up and down to view more application icons. Touch an icon to open the application.

Switching Between Recent Applications

1. Touch  at the bottom of the screen.

A window appears on the screen with icons of recently used applications.

Figure 30 Recently Used Applications

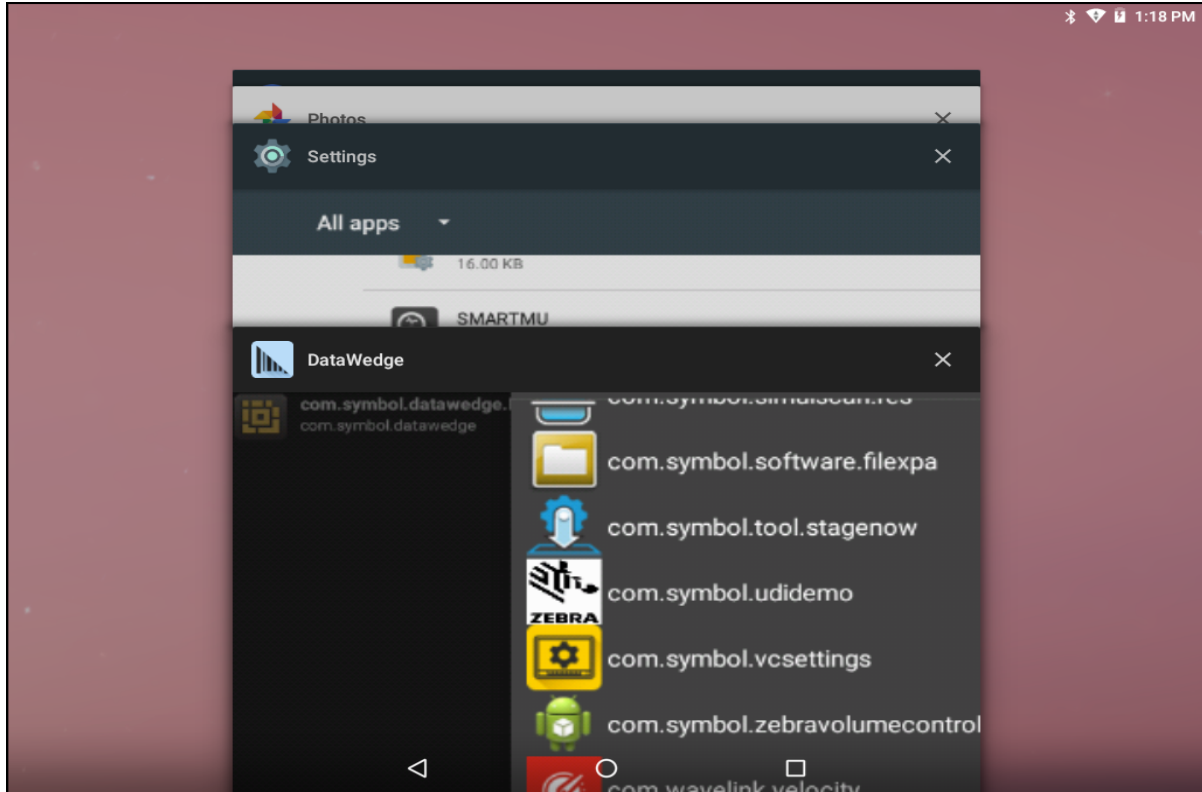

2. Slide the window up and down to view all recently used applications.
3. Swipe left or right to remove application from the list and force close the application.
4. Touch an icon to open it, or touch  (at bottom of the screen) to return to the current screen.

Unlocking the Screen

Use the Lock screen to protect access to data on the L10. Some email accounts require locking the screen. To set up the locking feature, see [Setting Screen Lock on page 122](#).

When locked, a pattern, PIN or password is required to unlock the device. Press the **Power** button to lock the screen. The device also locks after a predefined time-out.

1. Press and release the **Power** button to wake the device.
The Lock screen appears.
2. Swipe up to unlock the screen.
3. If the PIN, password, or pattern screen unlock feature is enabled, then enter the PIN, password, or pattern after unlocking the screen.

Figure 31 Lock Screen



Lock icon

Figure 32 PIN Screen

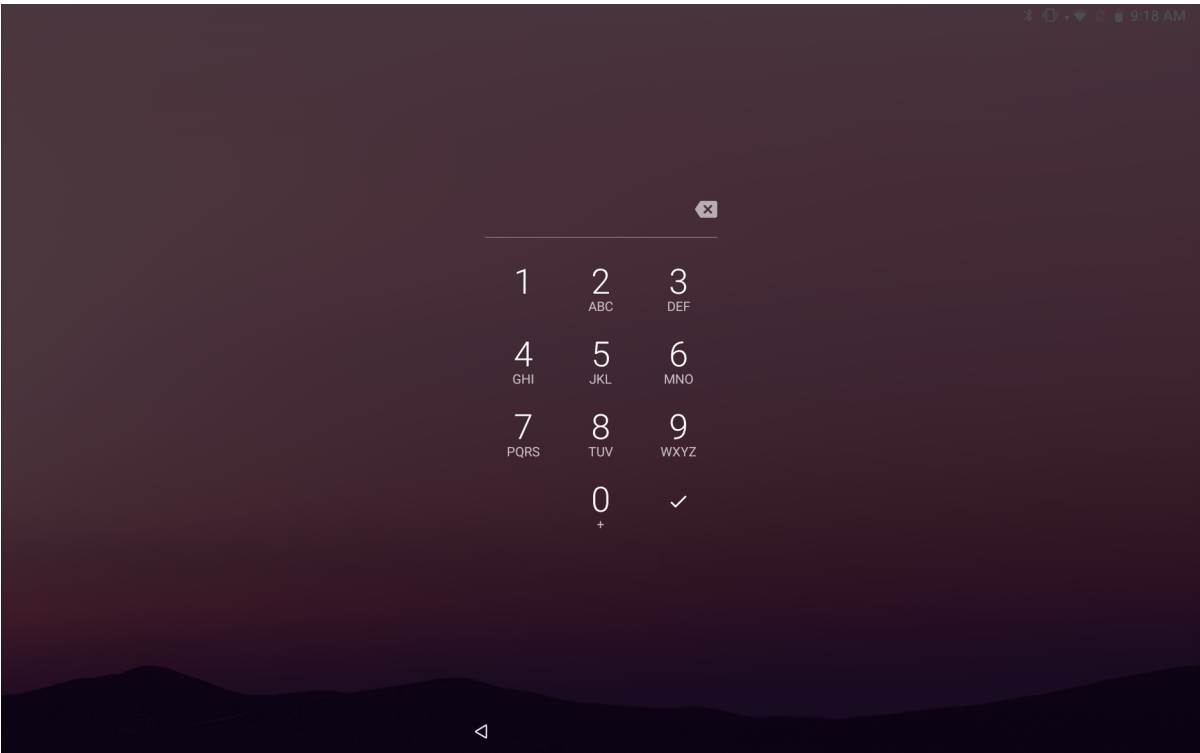
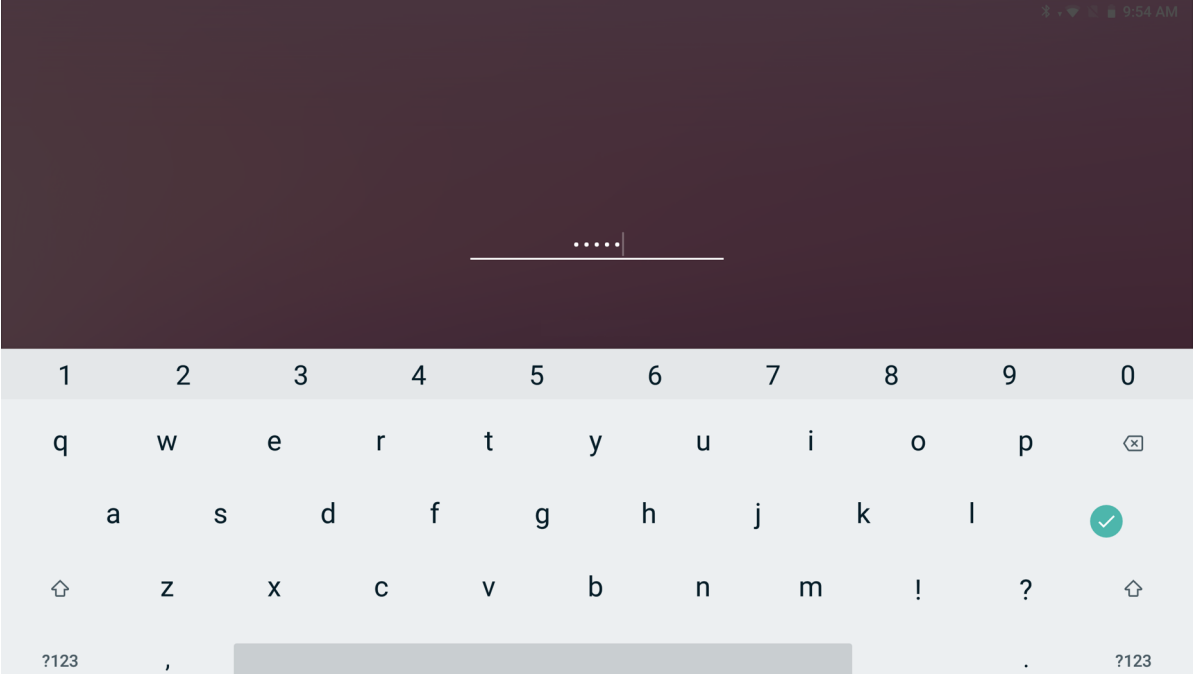

Figure 33 Pattern Screen



Figure 34 Password Screen



Suspend Mode

The L10 goes into suspend mode when you press the **Power** button or after a period of inactivity (set in the Display settings).

1. To wake the L10 from Suspend mode, press the **Power** button.
The Lock screen displays.
2. Swipe up to unlock the screen.



NOTE: If you enter the PIN, password, or pattern incorrectly five times, you must wait 30 seconds before trying again. If the you forget the PIN, password, or pattern, contact the system administrator.

Figure 35 Lock Screen

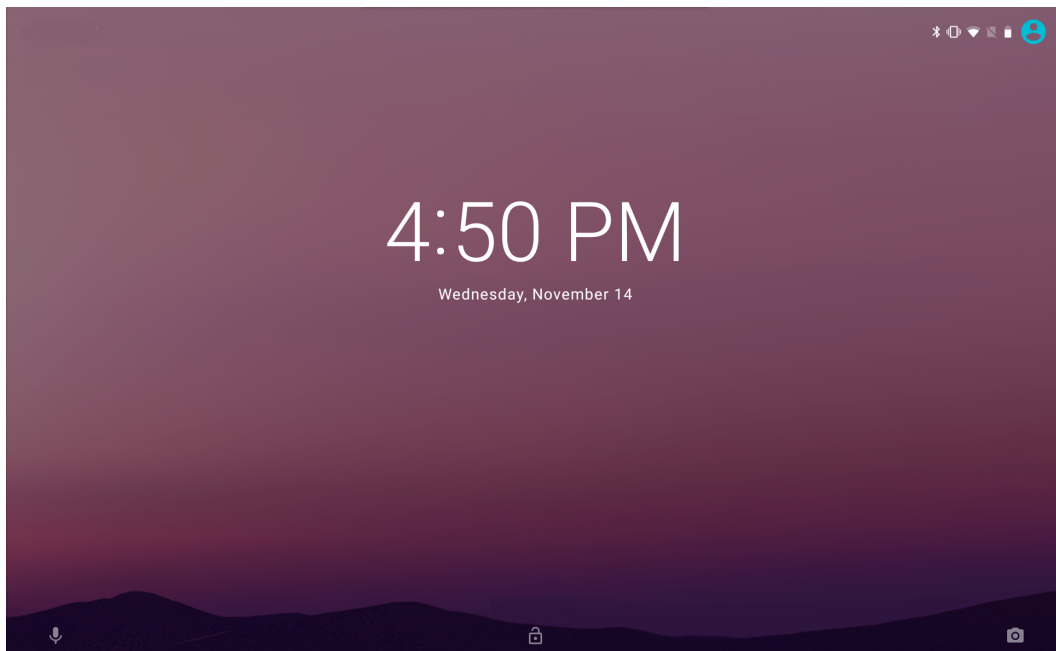

Restarting the L10

There are two reset features on the L10: Restart and a hard reset switch.

Soft Reset

Reboot the device if applications stop responding.

1. Press the **Power** button until a small menu appears.

Figure 36 Power Off or Restart Menu

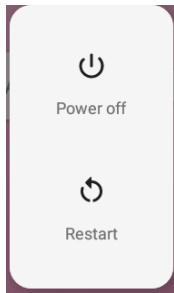

2. Touch **Restart**.
The device restarts.

Hard Reset

If the L10 is not responsive, you can use the reset switch on the face of the tablet. See the photo of the reset switch in [Figure 38 on page 48](#). This switch turns the power off immediately.



CAUTION Performing a hard reset with a microSD card installed in the L10 can cause damage or data corruption to the memory card, causing all data on the microSD card to be lost.

1. If you have a microSD card installed in the tablet, remove it before you use the reset switch.
To access the microSD card, open the port cover on the left side of the tablet and remove the microSD card.
This removal will preserve the data on the memory card.

Figure 37 microSD Card Slot

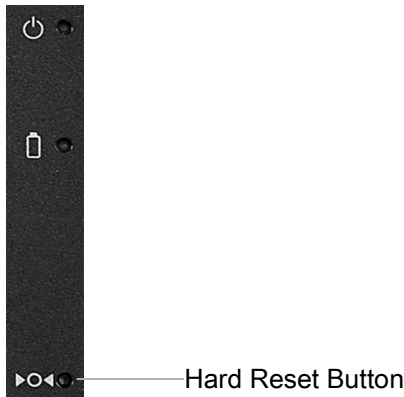

2. Use the stylus tip on the tablet pen and insert it into the reset hole to press the recessed button until the tablet shuts down. (You can also use a paper clip and unbend it to form a pin.)

Figure 38 Reset Switch on Front of Tablet

3. Restart the tablet by pressing the **Power** button.
4. Return the microSD card to the slot in the tablet.

Transferring Files with USB

Transferring Files with a Host Computer by USB

Connect the device to a host computer using a USB cable to transfer files between the device and the host computer.

When connecting the device to a host computer, follow the host computer's instructions for connecting and disconnecting USB devices, to avoid damaging or corrupting files.

Transferring Files

These steps show you how to use the Transfer files option to copy files between the device (internal memory or microSD card) and the host computer.

1. Connect a USB cable to the tablet.
2. Swipe down from the Status Bar to display the Notification panel.
The panel displays a message.

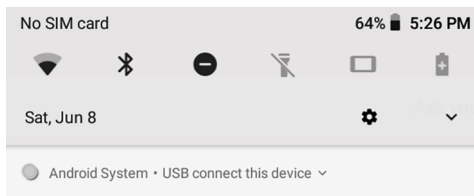

Message

3. Touch the message: **USB connect this device**.
The Notification panel displays another message.

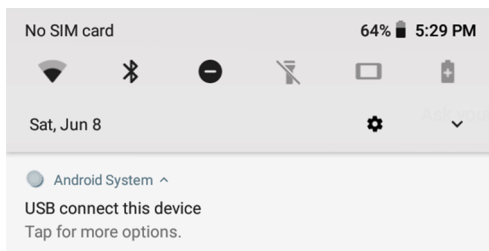

Message

4. Touch the message: **Tap for more options.**

The Use USB to dialog box appears. By default, **None** is selected.

Figure 39 Use USB to Dialog Box



5. Touch **Transfer files.**



NOTE: After you change the setting to **Transfer files**, and then disconnect the USB cable, the setting reverts back. If the USB cable is reconnected, select **Transfer files** again.

6. On the host computer, open a file explorer application.
7. Locate the **device** as a portable device.
8. Open the **SD card** or the **Internal storage** folder.
9. Copy files to and from the device or delete files as required.

Transferring Photos

This section shows you how to transfer photos using Photo Transfer Protocol (PTP).



NOTE: Use Photo Transfer Protocol to copy photos from either the microSD card or internal memory to the host computer.

1. Connect USB cable to the device.
2. Swipe down from the Status Bar to display the Notification panel.
The panel displays a message.
3. Touch **USB connect this device.**

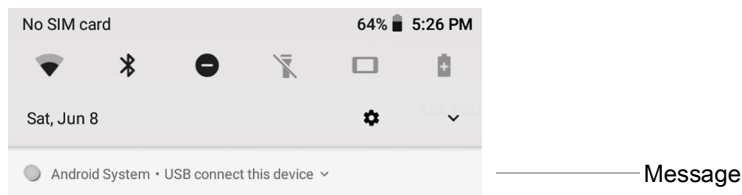

The notification panel displays Tap for more options.

4. Touch **Tap for more options.**

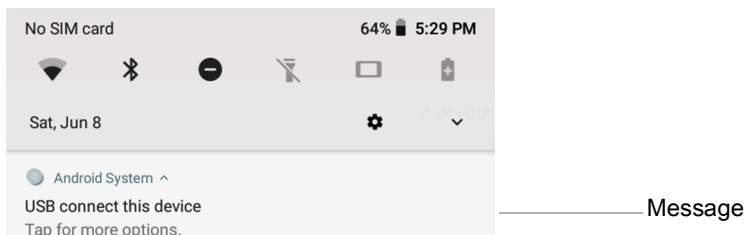

The Use USB dialog box appears. By default, **None** is selected.

Figure 40 Use USB Dialog Box

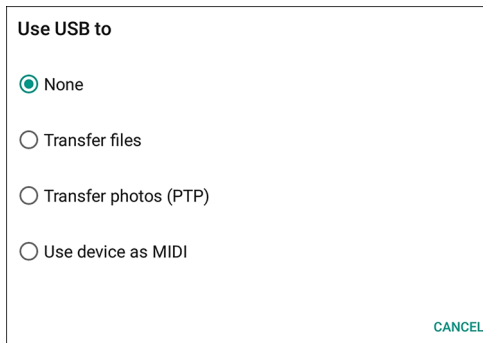

5. Touch **Transfer photos (PTP)**.
6. On the host computer, open a file explorer application.
7. Open the **SD card** or the **Internal storage** folder.
8. Copy or delete photos as required.

Disconnecting from the Host Computer

To disconnect the device from the host computer:



CAUTION: Carefully follow the host computer's instructions to unmount the microSD card and disconnect USB devices correctly to avoid losing information.

1. On the host computer, unmount the device.
2. Remove the USB cable from the device.

Applications

Introduction

This chapter describes these selected applications installed on the tablet:

- Battery Manager
- Contacts
- DWDemo
- Files
- Device Central
- Diagnostic Tool
- Using the Cameras
- Photos
- PTT Express Voice Client
- Sound Recorder

Battery Manager

The Battery Manager provides detailed information about the battery.

1. To open the Battery Manager, swipe up from the bottom of the Home screen and touch the **Battery Manager** icon .

The icon in [Battery Manager Screen on page 52](#) indicates the level of charge in the battery and the status of charging.

Figure 41 Battery Manager Screen

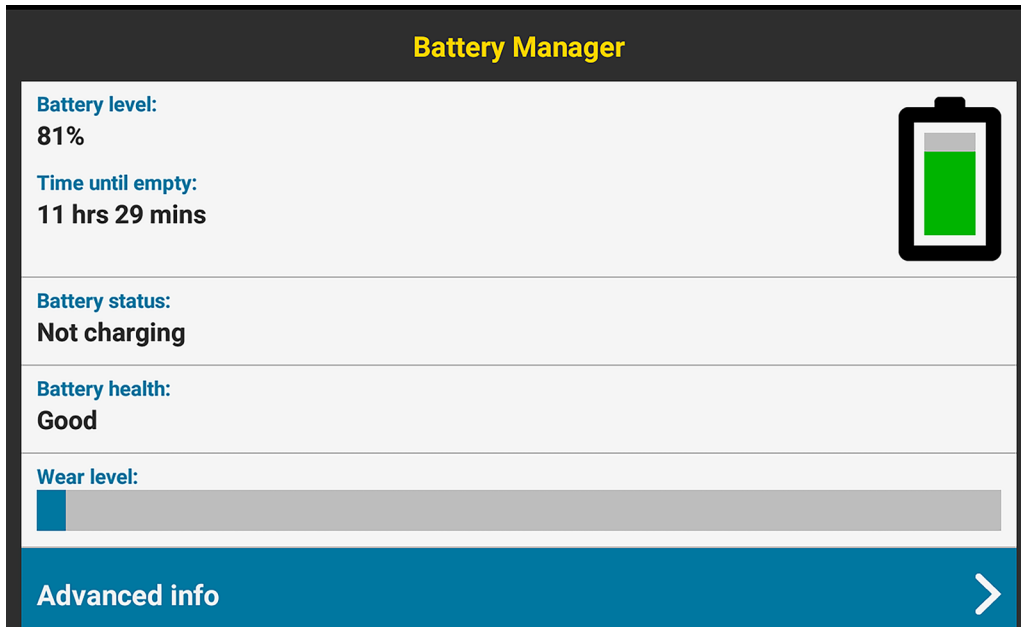

2. Touch **Advanced info** to view more.

Table 16 Battery Icon Description

Battery Icon	Description
	Battery charge level.
	Battery charging.
	Battery charge level is below 20%.

- **Battery level** – Shows the current battery charge level as a percentage. Displays -% when level is unknown.
- **Time until full** – The amount of time until the battery is fully charged.
- **Time since charging** – The amount of time since the device began charging.
- **Time until empty** – The amount of time until the battery is empty.
- **Battery status**
 - **Not charging** – The device is not .
 - **Charging over AC** – The device is connected to AC power and charging.
 - **Discharging** – That the battery is discharging.
 - **Full** – That the battery is fully charged.
 - **Unknown** – The battery status is unknown.

- **Battery health** – The health of the battery. If a critical error occurs, an exclamation icon, , appears. Touch to view the error description.
 - **Decommission** – The battery is past its useful life and should be replaced. See system administrator.
 - **Good** – The battery is good.
 - **Charge error** – An error occurred while charging. See system administrator.
 - **Over Current** – An over-current condition occurred. See system administrator.
 - **Dead** – The battery has no charge. Replace the battery.
 - **Over Voltage** – An over-voltage condition occurred. See system administrator.
 - **Below Temperature** – The battery temperature is below the operating temperature. See system administrator.
In cold temperatures, see [Operating the Tablet in Cold Ambient Temperatures on page 148](#).
 - **Failure Detected** – A failure has been detected in the battery. See system administrator.
 - **Unknown** – See system administrator.
- **Wear level** – The health of the battery in graphical form. When the wear level exceeds 80%, the bar color changes to red.
- **Advanced info** – Touch to view additional battery information.
 - **Battery present status** – Indicates that the battery is present.
 - **Battery level** – The battery charge level as a percentage of scale.
 - **Battery scale** – The battery scale level used to determine battery level (100).
 - **Battery voltage** – The current battery voltage in millivolts.
 - **Battery temperature** – The current battery temperature in degrees Centigrade.
 - **Battery technology** – The type of battery.
 - **Battery current** – The average current into or out of the battery over the last second in mAh.
 - **Battery manufacture date** – The date of manufacture.
 - **Battery serial number** – The battery serial number. The number matches the serial number printed on the battery label.
 - **Battery part number** – The battery part number.
 - **Battery rated capacity** – Lists the rated capacity of the backup battery in mAh.
 - **Battery decommission status** – Indicates if the battery is past its life span.
 - **Battery Good** – The battery is in good health.
 - **Decommissioned Battery** – The battery is past its useful life and should be replaced.
 - **Base cumulative charge** – Cumulative charge using Zebra charging equipment only.
 - **App version** – The application version number.

Contacts

Use the **Contacts** app to manage contacts.

From a Home or Apps screen, touch **Contacts** to open to the main list of contacts.  Contacts are listed in alphabetical order. Swipe up or down to scroll through the list.

Adding a Contact

1. In the **Contacts** app, touch .
2. If there are multiple accounts in contacts, touch the one to use.
3. Type the contact's name and other information. Touch a field to start typing, and swipe down to view all categories.
4. To open a menu with preset labels, such as Home or Work for an email address, touch the label to the right of the item of contact information. Or, to create your own label, touch **Custom** in the menu.
5. Touch the check mark next to **Add New Contact**.

Editing Contacts

1. In the **Contacts** app, touch a contact name to edit.
2. Touch .
3. Edit the contact information.
4. Touch **SAVE**.

Deleting

1. In the **Contacts** app, touch a contact name to delete.
2. Touch .
3. Touch **Delete**.
4. Touch **DELETE** to confirm.

DataWedge Demonstration



NOTE: DataWedge is on the Home screen. To this feature, go to the DataWedge settings and disable the Launcher profile.

Use DataWedge Demonstration to demonstrate data capture functionality.

Figure 42 DataWedge Demonstration Window

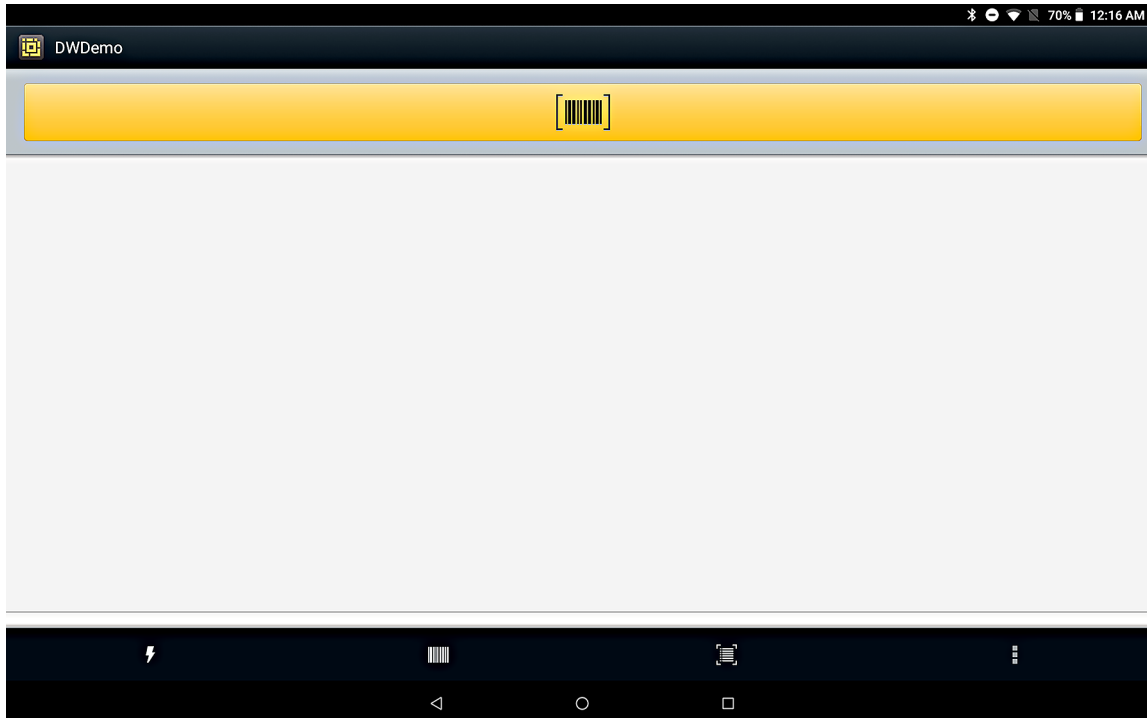

Table 17 DataWedge Demonstration Icons

	Icon	Description
Illumination		Imager illumination is on. Touch to turn illumination off.
		Imager illumination is off. Touch to turn illumination on.
		A is connected.
		A is not connected.

Table 17 DataWedge Demonstration Icons (Continued)

	Icon	Description
Scan Mode		Imager is in picklist mode. Touch to change to normal scan mode.
		Imager is in normal scan mode. Touch to change to picklist mode.
		Opens a menu to view the application information or to set the application DataWedge profile.

1. Touch the Data Capture icon to select the data capture mode.

Figure 43 Data Capture Options Menu

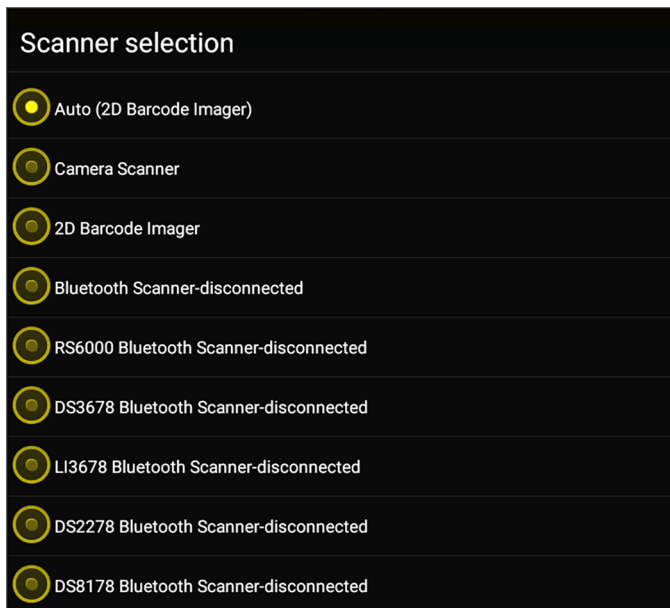

2. Press the scanner trigger button or touch the on-screen yellow scan button to capture data. The data appears in the text field below the yellow button.

Files

Use the **Files** app to view and manage files on the device.







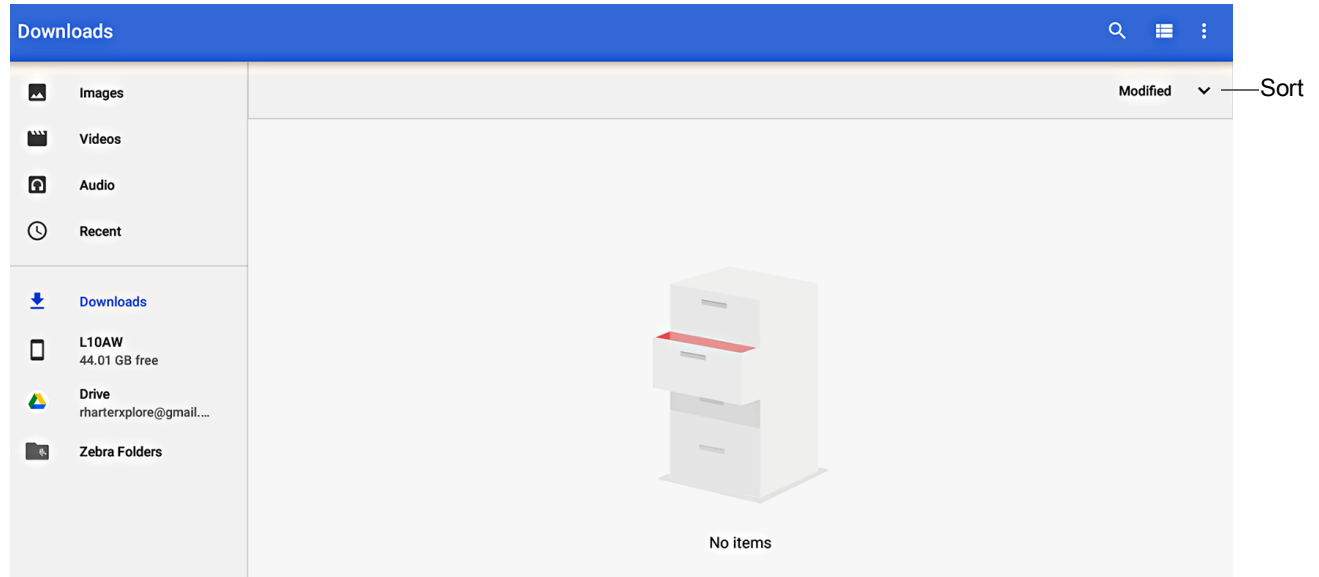

To open **Files**, swipe up from the bottom of the screen and touch the Files icon .

Figure 44 Files Screen



1. Touch and hold an item to open the File Operations menu.
2. Select an option:
 -  – Share the file with other devices.
 -  – Delete the file.
 -  – View additional options.
 - **Open with** – Select which app is used to open the file.
 - **Select all** – Select all folders and files.
 - **Copy to...** – Copy the file.
 - **Move to...** – Move the file or folder to a new location.
 - **Compress** – Compresses the selected file(s) into a ZIP file.
 - **Rename** – Rename the file.
 - Touch the Sort drop-down to sort files by name, type, size, or date.
 -  – View all file locations.
 -  – Search for a specific file on the device.
 -  – Change the folder to display items as a list / grid.
 -  – Open the More options menu.
 - **New Window** – Create a new Files window.
 - **New Folder** – Create a new folder.
 - **Select all** – Select all folders and files.
 - **Show/Hide internal storage** – Show or hide internal storage.

Device Central

The **Device Central** application displays detailed information about the L10 and connected peripherals and supports the following Zebra devices:

- RS6000 Bluetooth Ring Scanner

Device Central features include:

- Discovering and pairing with supported peripherals via Bluetooth or corded connection.
- Paging a connected RS6000 Ring Scanner.
- Updating the firmware of supported ring scanners. For information on updating ring scanner firmware using Device Central and refer to the RS6000 User Guide.
- Displaying the connection status of peripherals.
- Displaying information for a connected peripheral in the notification bar.

Figure 45 Device Central Screen

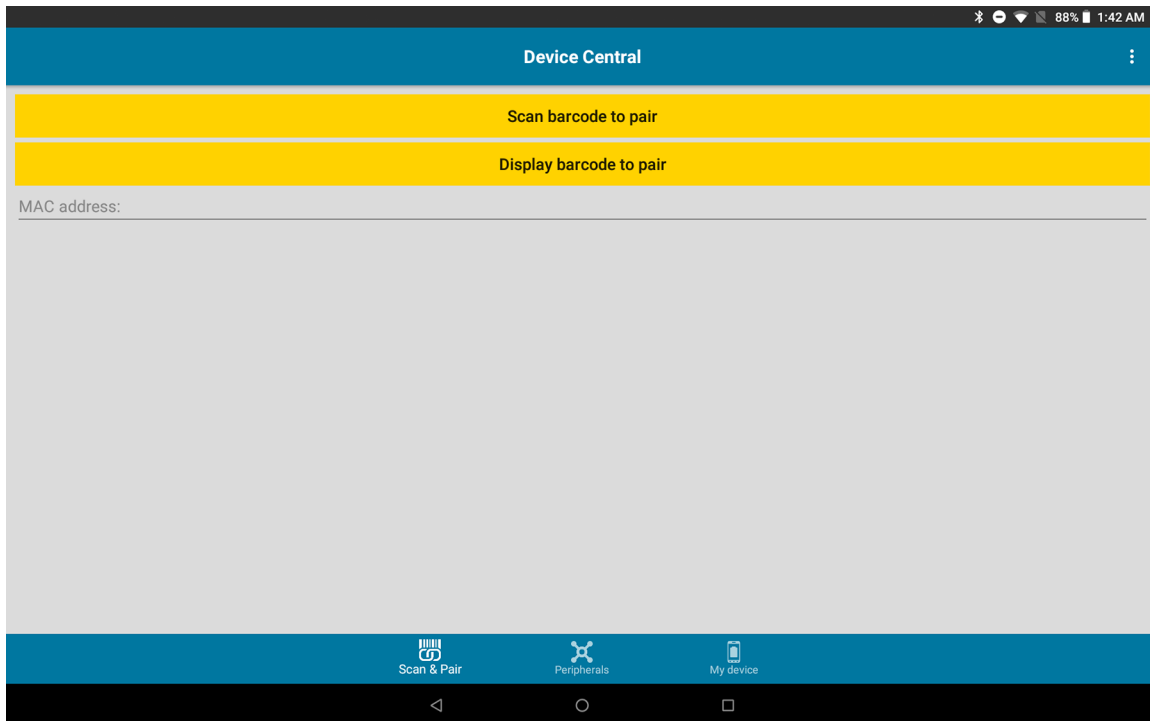

Peripherals Tab

Displays all currently connected and previously connected peripherals. Connected peripherals display the length of time (in minutes) that they have been connected. When an RS6000 is connected the **Page** button displays. See [Paging an RS6000 Ring Scanner on page 60](#).

1. Touch the peripheral information to display the **Device Details** screen.
The **Device Details** screen displays detailed device information for the selected peripheral.

Figure 46 Connected Peripherals

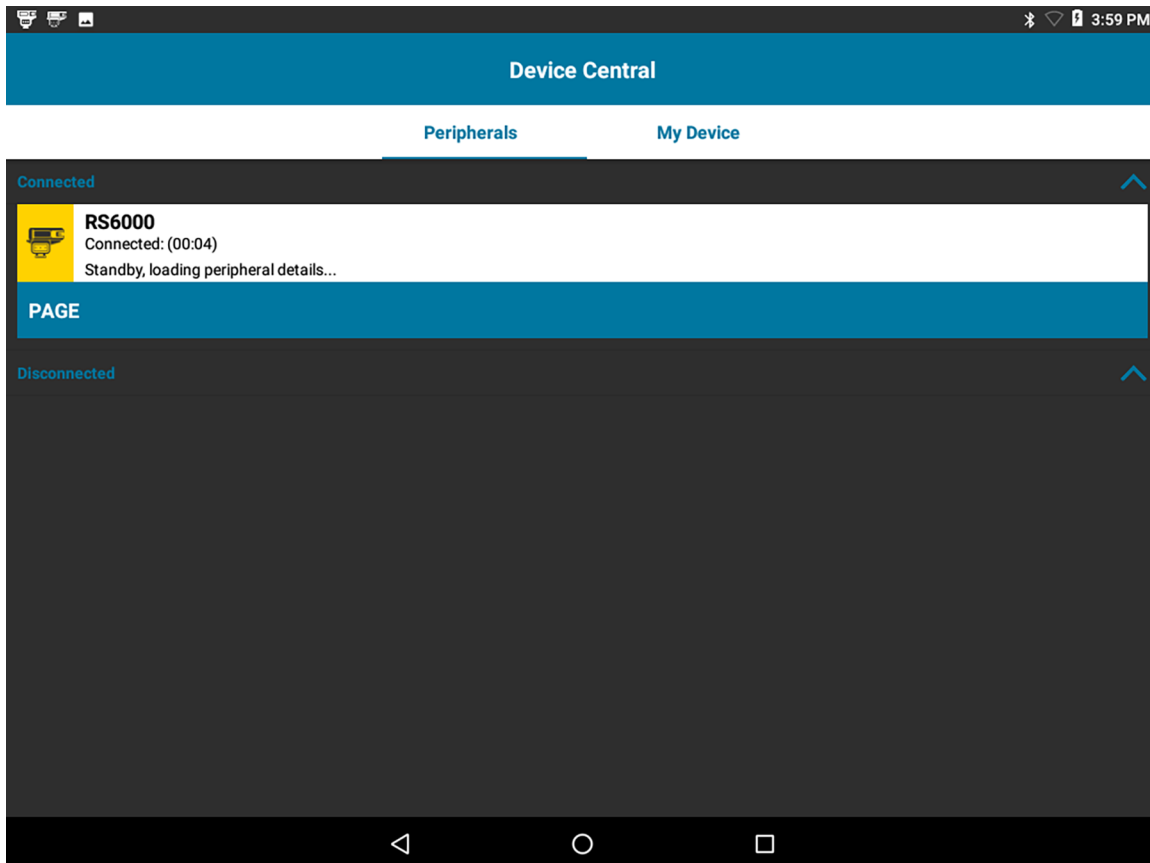

2. Touch the connected device icon to display details about the peripheral.
The **Device Details** screen appears.

Figure 47 Device Details

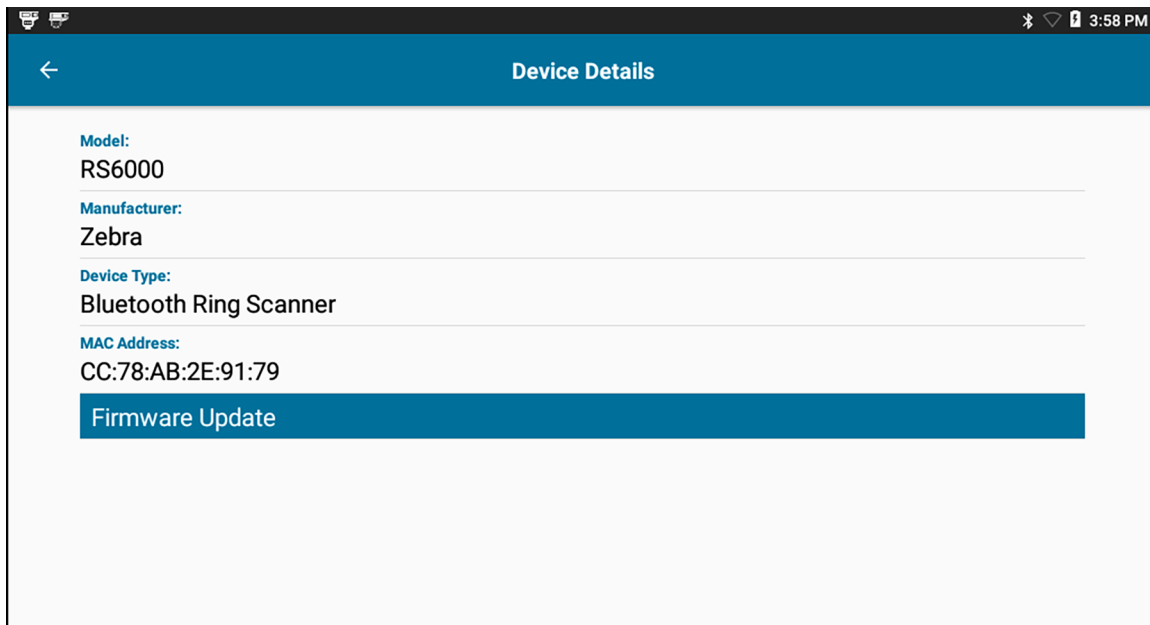

My Device

The **My Device** tab displays information about the L10 and the current version of Device Central.

- **Device Name** – displays the name assigned to the L10.
- **Device Central Version** – displays the Device Central application version number.
- **Device Details** – Opens the **Phone status** settings window.
- **Device Battery Details** – Open the **Battery** settings window.

Paging an RS6000 Ring Scanner

Use the **Page** button to easily locate the currently connected RS6000 Ring Scanner:

1. With the RS6000 Ring Scanner connected, swipe up from the bottom of the Home screen and touch the **Device Central** icon  .



NOTE: The RS6000 Ring Scanner must be within 10 m (32 ft) of the L10.

2. Under the RS6000 peripheral information, touch **Page** to begin paging the RS6000.
The paged RS6000 beeps and vibrates.
3. To stop paging, press the scan trigger of the RS6000. On a triggerless RS6000, stop paging by resetting it.

Diagnostic Tool

The **Diagnostic Tool** is a utility that determines the health of the L10. Use the Diagnostic Tool to troubleshoot the device and determine issues.

By default, the Diagnostic Tool tests the system (device) and the battery subsystem. It can also run tests and report status for other subsystems:

- GPS
 - WLAN
 - WWAN
 - Bluetooth
1. Swipe up from the bottom of the Home screen and touch the Diagnostic Tool icon. 

Figure 48 Diagnostic Tool

2. Touch **RUN TEST**.

The app tests all enabled subsystems.

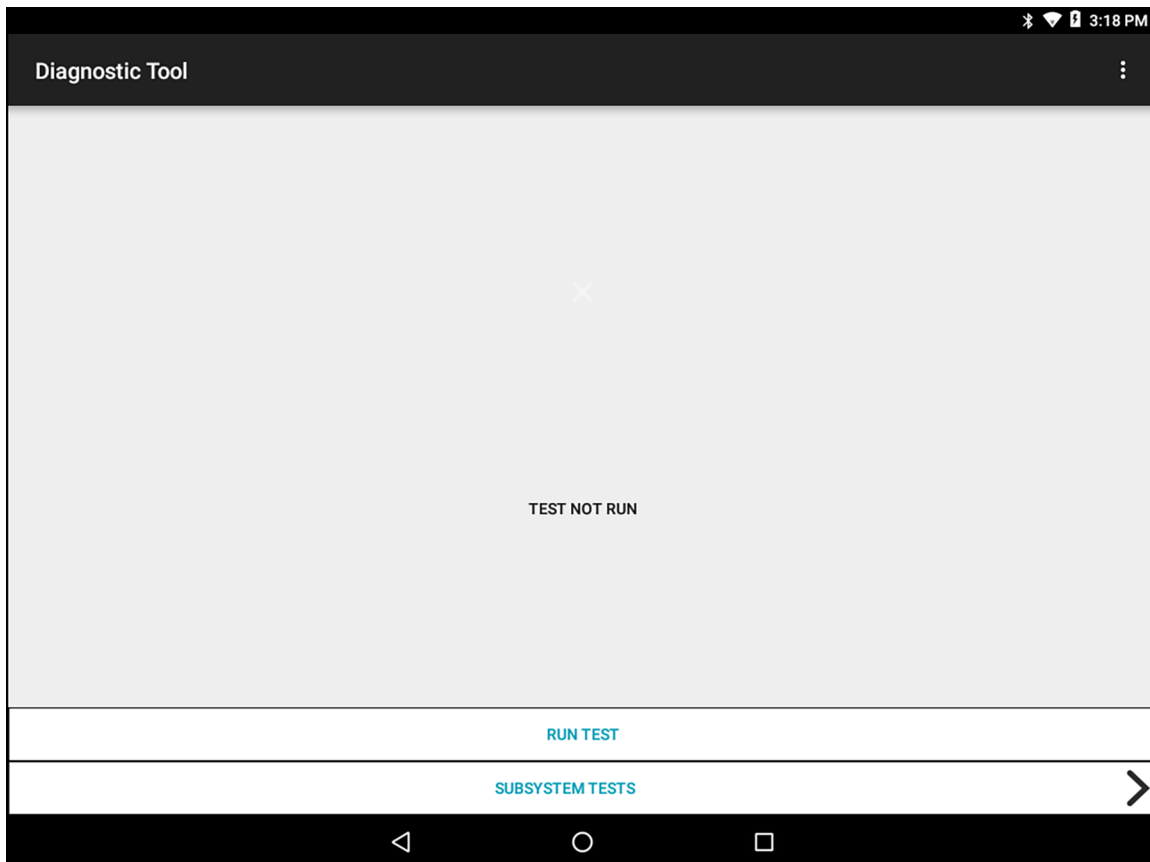

NOTE: To view or run a subsystem test, you must touch **RUN TEST** and then touch **SUBSYSTEM TESTS** to see the results of the subsystems.

See [Settings in the Diagnostic Tool on page 64](#) to enable subsystem tests.

Figure 49 Test Passed Screen

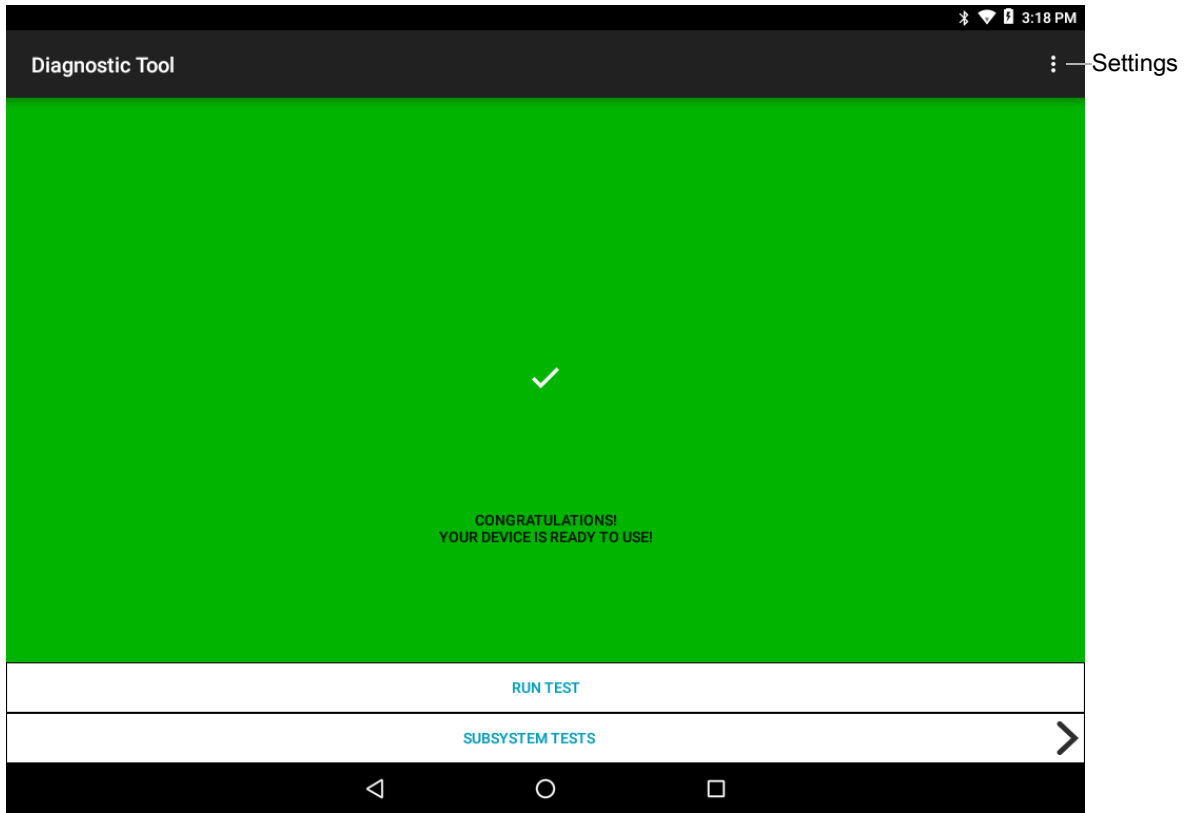
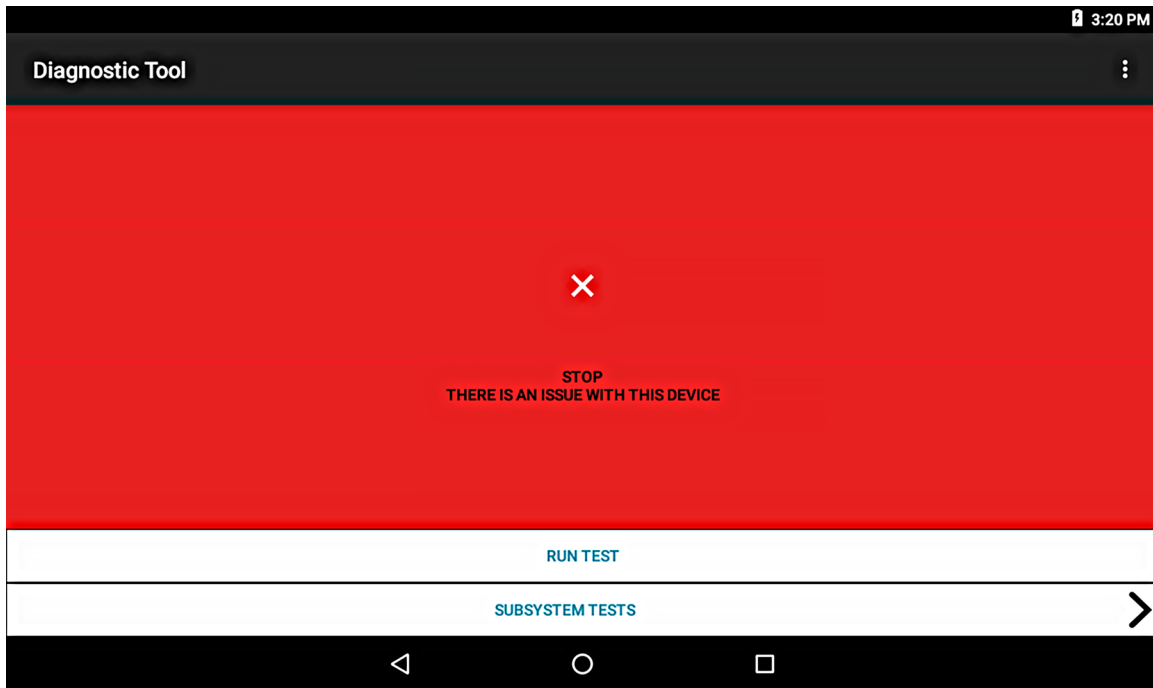

Figure 50 Test Failed Screen



- To view each individual subsystem test, touch **Subsystem Tests**.

The Subsystems screen displays all the subsystems and shows a check mark  for tests that have passed.

Figure 51 Subsystem Screen

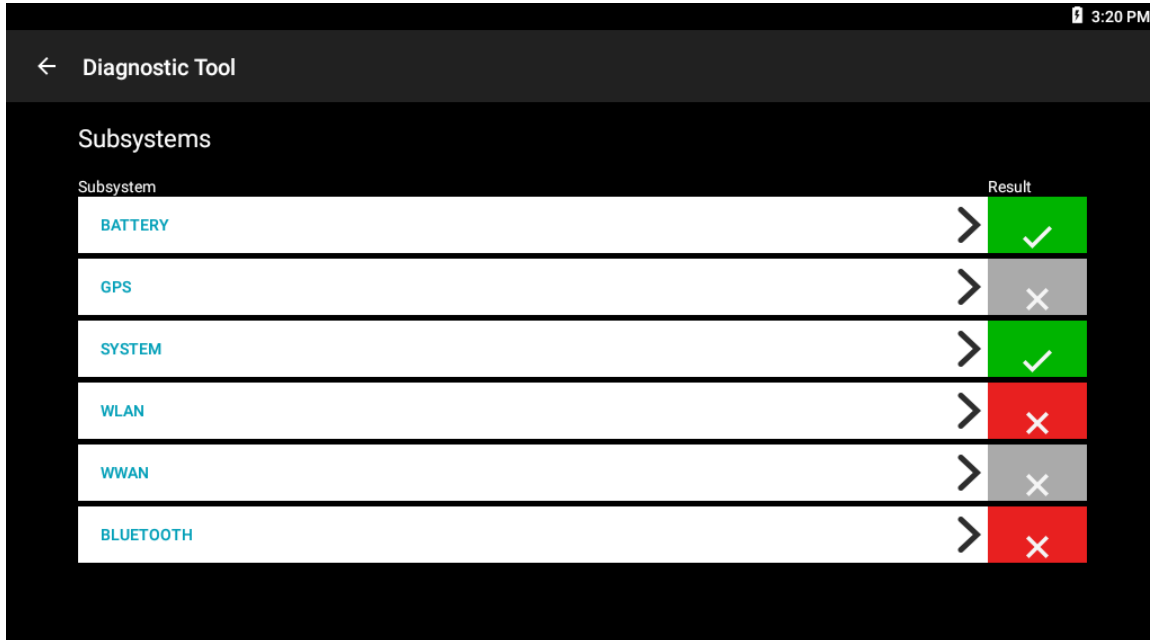



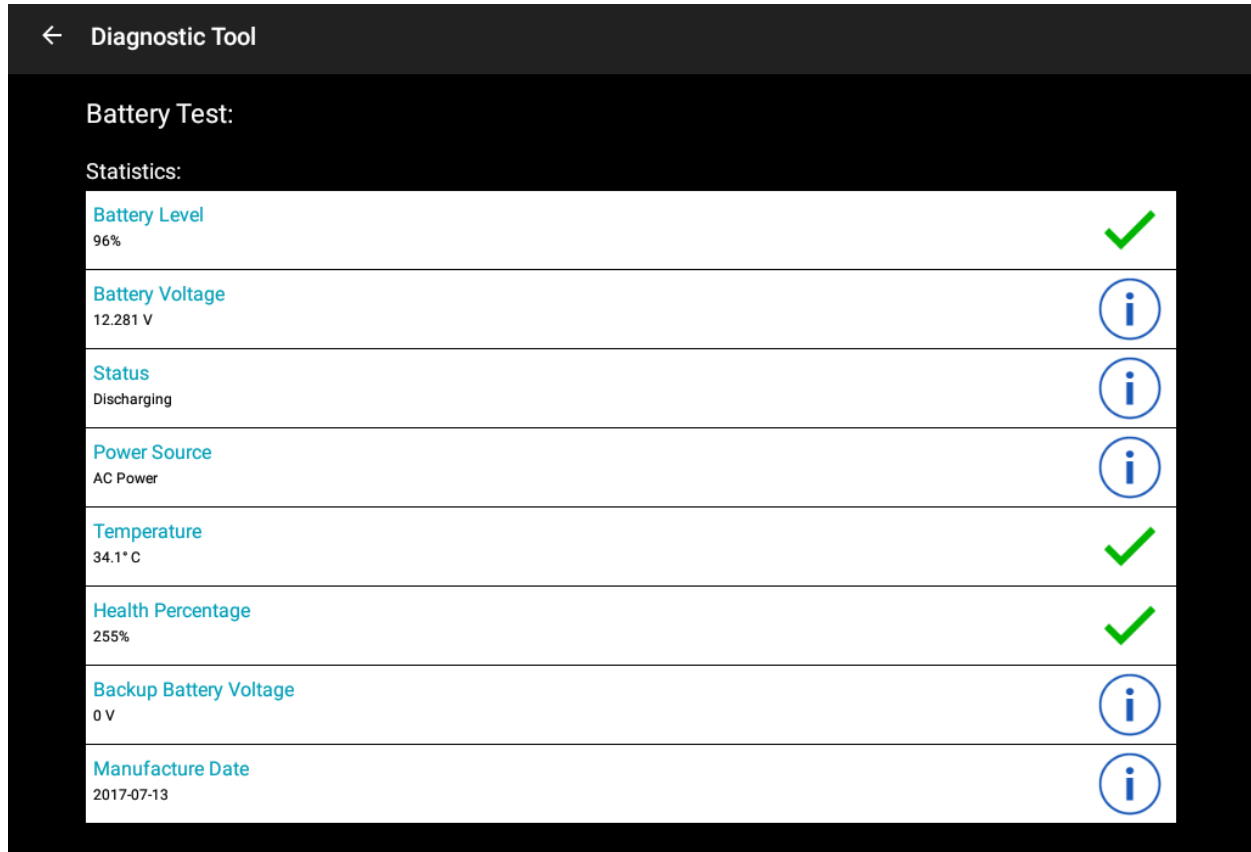

Table 18 Subsystem Test Result Indicators

Status Icon	Description
	Indicates test passed.
	Indicates test failed.
	Indicates test not supported or not enabled.

Touch one of the subsystems to view details.

Figure 52 Battery Subsystem Details



Settings in the Diagnostic Tool

By default only the Battery and System tests are enabled as shown in [Subsystem Screen on page 63](#). To enable other tests in the Diagnostic Tool:

1. Touch **Settings** in the Diagnostic Tool, as shown below, after running the test with the RUN TEST command.



The Settings menu of the Diagnostic Tool appears.

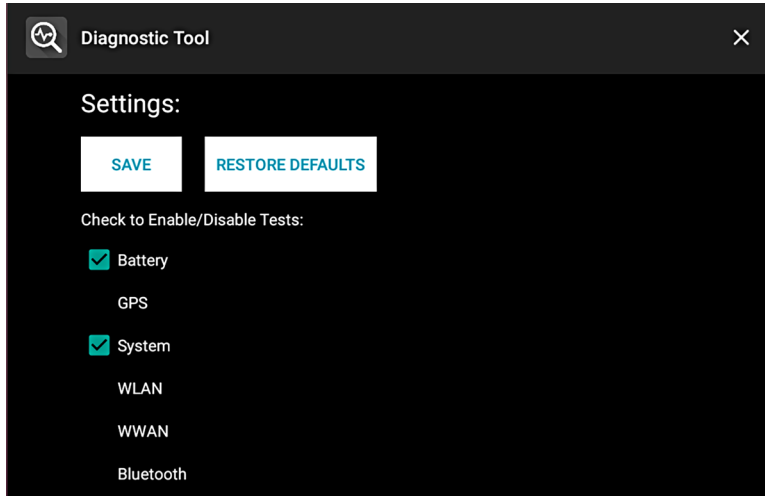

2. To enable testing of the subsystems, touch to the left of the test name to select the tests. A green box with a check mark appears.
3. Touch **SAVE**.
Touch **Yes** to confirm.
4. Touch .
5. Touch **SUBSYSTEM TESTS** again to see the results you checked.

Battery Test Information

The Battery Test obtains the following information:

- **Battery Level** – Current battery charge level
- **Battery Voltage** – Current battery voltage
- **Status** – Whether the battery is charging (on AC power) or discharging (on battery power)
- **Power Source** – Whether the device is receiving power from the battery or from an external source
- **Temperature** – Current battery temperature
- **Health Percentage** – Indicates the ratio of present capacity to design capacity at a discharge rate of design capacity.
- **Backup Battery Voltage** – Backup battery voltage
- **Manufacture Date** – Manufacture date of the battery.

GPS Test Information

The GPS Test displays the following information:

- **GPS Provider Enabled** - Whether GPS is enabled (true) or disabled (false)
- **Latitude** - Current latitude position
- **Longitude** - Current longitude position
- **Altitude** - Current altitude in meters
- **Bearing** - Current bearing
- **Speed** - In meters per second
- **Accuracy** - GPS accuracy in meters.

System Test Information

Use the System Test to determine if the CPU or memory loads are too high, there are too many processes running on the device, or that storage on the device is almost full. The System Test reports the following information:

- **CPU Load** – Indicates the amount of CPU being used.
- **Free Physical Memory** – Indicates the amount of RAM available.
- **Free Storage** – Indicates the amount of internal Flash memory available.
- **Process Count** – Indicates the number of processes currently running.

WLAN Test Information

If the Wi-Fi radio is not present or disabled the test may be skipped. Use this information to determine if the device's WLAN configuration is correct or whether there is any connection with an access point or network. The WLAN Test reports the following information:

- **WLAN Enabled** – Indicates if the WLAN radio is enabled or disabled.
- **WLAN Status** – Indicates the current status of association with the access point.
- **ESSID** – Displays the name of the wireless network.
- **BSSID** – Displays the MAC address of the connected access point.
- **MAC Address** – Displays the device's MAC address.
- **Signal** – Indicates the strength of the Wi-Fi signal (in dBm).
- **IP Address** – Displays the IP address of the device.

WWAN Test Information

The WWAN Test reports the following information:

- **SIM State** - Current state of the SIM card
- **WAN Type** - Data connection type
- **Signal Strength** - Current cellular signal strength
- **Phone Number** - Phone number assigned to the device
- **Device ID** - Device ID number.

Bluetooth Test Information

The Bluetooth Test reports the following information:

- **Enabled** – Indicates if the Bluetooth radio is enabled or disabled.
- **Status** – Indicates if the device is paired to another Bluetooth device.
- **Connectable/Discoverable** – Indicates if the device is discoverable or connectable.
- **Address** – Displays the Bluetooth radio MAC address.
- **Name** – Displays the Bluetooth name for the device.

Camera

The Camera application supports both the front and rear cameras. This section provides information for taking photos and recording videos using the integrated digital cameras.

By default, the L10 tablet saves photos and videos on the internal storage. However, if a microSD memory card is installed and the storage path is changed manually, then the tablet saves photos and videos on the microSD card.



NOTE: The native Google camera application is associated with a hidden DataWedge profile in which scanning is disabled.

Camera Features

See Photo Settings for camera setting descriptions.

1. Swipe up from the bottom of the Home screen and touch the **Camera** app. 
The camera app opens.

Figure 53 Basic Camera Features

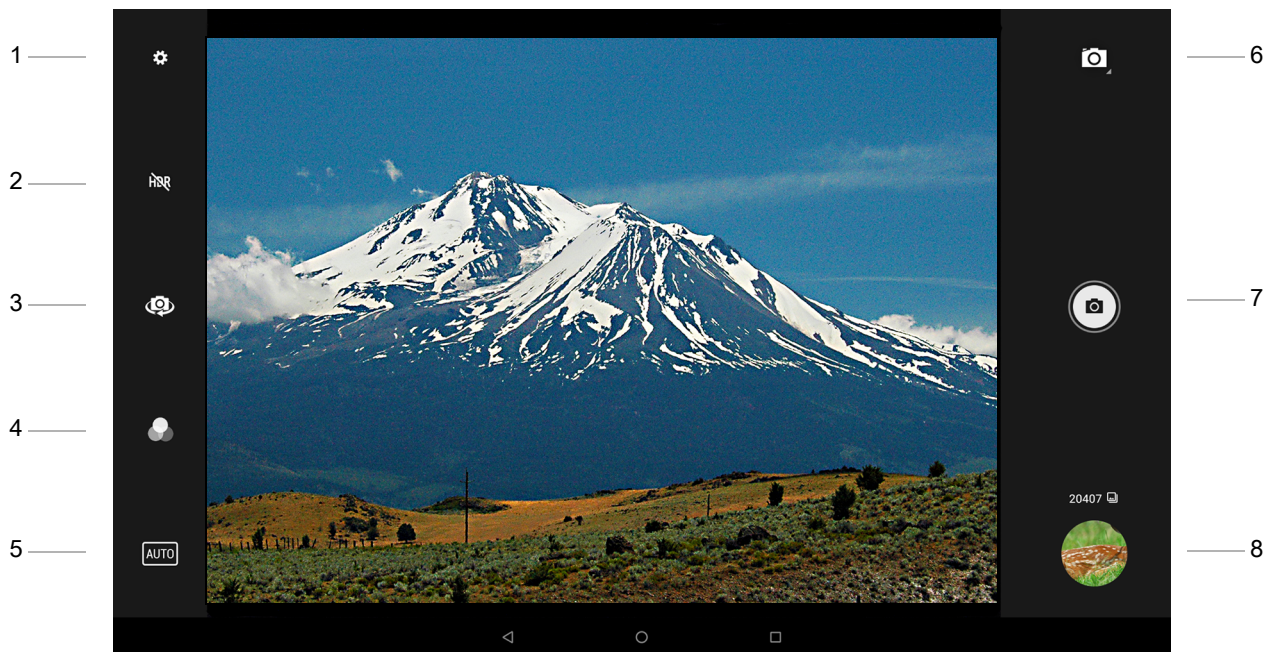

Table 19 Camera Features



Item	Description
1	Settings - Controls several features of the camera, including, flash, exposure, size, and quality.
2	High Dynamic Range (HDR) - Turns this range on or off. When on, HDR helps you capture greater detail from bright and dark areas.
3	Switch between the front or rear camera.
4	Color Effect - Provides different filters and styles to a photo.

Table 19 Camera Features (Continued)

Item	Description
5	Scene Mode - Select the type of scene and adjusts the camera to the scene.
6	Camera Mode - Switch the mode to Panoramic, Video, or Camera.
7	Shutter - Touch to take the picture.
8	Gallery - Provides access to the photos you have taken.

Taking a Photo

See Photo Settings for camera setting descriptions.

1. Swipe up from the bottom of the Home screen and touch the **Camera** app. 
The camera app opens.
2. If necessary, touch the **Camera Mode** icon and touch .
3. To switch between the rear camera and front camera, touch the **Camera Switch** icon .
4. Frame the subject on the screen.
5. To zoom in or out, press two fingers on the display and pinch or expand fingers.
The zoom controls appear on the screen.
6. Touch an area on the screen to focus.
The focus circle appears. The two bars turn green when in focus.



Focus Circle

7. Touch the Shutter Button .
- The camera takes a photo and a shutter sound plays.
The photo momentarily displays as a thumbnail in the lower right corner.



Taking a Panoramic Photo

Panorama mode creates a single wide image by panning slowly across a scene.

1. Swipe up from the bottom of the Home screen and touch **Camera**.

Figure 54 Panoramic Mode



2. Touch the **Camera Mode** icon and touch the **Panoramic Mode**  icon.
3. Frame one side of the scene to capture.
4. Touch  and slowly pan across the area to capture.
A small green square appears inside the button indicating the capture is in progress.
If you are panning too quickly, the message **Too fast** appears.
5. Touch the **Shutter** Button  to end the shot.
The panorama appears immediately and a progress indicator displays while it saves the image.

Recording a Video





1. Swipe up from the bottom of the Home screen and touch the **Camera app** .
2. Touch the camera mode menu and touch the Video icon .
3. To switch between the rear camera and front camera (if available), touch the **Camera Switch** .
4. Point the camera and frame the scene.
5. To zoom in or out, press two fingers on the display and pinch or expand fingers.
The zoom controls appear on the screen.
6. Touch  to start recording.
The video time remaining appears in the top left of the screen.
7. Touch  to the end recording.
The video momentarily displays as a thumbnail in the lower left corner.

Figure 55 Video Mode







Table 20 Video Features

Item	Description
1	Settings - Controls several features of the video camera, including, flash, quality, stabilization, and white balance.
2	Audio - Records sound or turns it off.
3	Switch between the front or the rear camera.
4	Color Effect - Provides different filters and styles to a video.
5	Camera Mode - Switches the mode to Panoramic, Video, or Camera.
6	Shutter - Starts and stops the video.
7	Gallery - Provides access to the photos you have taken.



Photo Settings





In Photo mode, photo settings appear on screen. Touch  to display the photo settings options.

Front Camera

- **Selfie Flash** - Turns screen white to help produce a little extra light in dimmer settings. Options: **Off** (default), or **On**.
- **GPS location** - Add GPS location information to the photo meta-data. Options: **On** or **Off** (default).
- **Picture size** - Set the size (in pixels) of the photo to: **5M pixels** (default), **3M pixels**, **HD1080**, **2M pixels**, **HD720**, **1M pixels**, **WVGA**, **VGA**, or **QVGA**.
- **Picture quality** - Set picture quality setting to: **Low**, **Standard** (default), or **High**.
- **Countdown timer** - Set to: **Off** (default), **2 seconds**, **5 seconds** or **10 seconds**.
- **Storage** – Set location to store the photo to: **Phone** or **SD Card**.
- **Face Detection** - Select to turn face detection **Off** (default) or **On**.
- **ISO** - Set how sensitive the camera is to light. Options: **Auto** (default), **ISO Auto (HJR)**, **ISO100**, **ISO200**, **ISO400**, **ISO800** or **ISO1600**.
- **Exposure** - Touch to adjust the exposure settings. Options: **+2**, **+1**, **0** (default), **-1** or **-2**.
- **White balance** - Select how the camera adjusts colors in different kinds of light, to achieve the most natural-looking colors:
 -  **Incandescent** - Adjust the white balance for incandescent lighting.
 -  **Fluorescent** - Adjust the white balance for florescent lighting.
 -  **Auto** - Adjust the white balance automatically (default).
 -  **Daylight** - Adjust the white balance for daylight.
 -  **Cloudy** - Adjust the white balance for a cloudy environment.
- **Redeye reduction** - Helps eliminate redeye effect. Options: **Disabled** (default), or **Enable**.
- **ZSL** - Set the camera to immediately take a picture when the button is pressed (default – enabled)
- **Selfie Mirror** - Options: **Disable** (default), or **Enable**.
- **Shutter Sound** - Select to play a shutter sound when taking a photo. Options: **Disable** (default) or **Enable**.
- **Anti Banding** - Allows the camera to avoid problems caused by artificial light sources that are not constant. These sources cycle (flicker) fast enough to go unnoticed to the human eye, appearing continuous. The camera's eye (its sensor) can still see this flicker. Options: **Auto** (default), **60 Hz**, **50 Hz**, or **Off**.

Rear Camera





- **Flash** - Select whether the camera relies on its light meter to decide whether a flash is necessary, or to turn it on or off for all shots.
 -  **Off** - Disable flash.
 -  **Auto** - Adjust flash automatically depending upon light meter (default).
 -  **On** - Enable flash upon taking a photo.
- **GPS location** - Turn **On** or **Off** (default).
- **Picture size** - The size (in pixels) of the photo to: **13M pixels** (default), **8M pixels** (default), **5M pixels**, **3M pixels**, **HD 1080**, **2M pixels**, **WXGA**, **HD720**, **1M pixels**, **WVGA**, **VGA**, or **QVGA**.
- **Picture quality** - Set the picture quality setting to: **Low**, **Standard** (default) or **High**.

- **Countdown timer** - Select **Off** (default), **2 seconds**, **5 seconds** or **10 seconds**.
- **Storage** – Set the location to store the photo to: **Phone** or **SD Card**.
- **Face Detection** - Select to turn face detection **Off** (default) or **On**.
- **ISO** - Set camera sensitivity to light to: **Auto** (default), **ISO Auto (HJR)**, **ISO100**, **ISO200**, **ISO400**, **ISO800** or **ISO1600**.
- **Exposure** - Set the exposure settings to: **+2**, **+1**, **0**(default), **-1** or **-2**.
- **White balance** - Select how the camera adjusts colors in different kinds of light, to achieve the most natural-looking colors:
 -  **Incandescent** - Adjust the white balance for incandescent lighting.
 -  **Fluorescent** - Adjust the white balance for florescent lighting.
 -  **Auto** - Adjust the white balance automatically (default).
 -  **Daylight** - Adjust the white balance for daylight.
 -  **Cloudy** - Adjust the white balance for a cloudy environment.
- **Chroma Flash** - Sets the camera to take two pictures, one with flash and one without flash. The two images are combined to produce a final image with the sharpness and clarity and bright color tones from a picture with the flash, coupled with the natural colors of a picture without a flash. Options: **Off** (default) or **On**.
- **Redeye reduction** - Helps eliminate redeye effect. Options: **Disabled** (default), or **Enable**.
- **ZSL** - Set the camera to immediately take a picture when the button is pressed (default – enabled).
- **Shutter Sound** - Select to play a shutter sound when taking a photo. Options: **Disable** (default) or **Enable**.
- **Anti Banding** - Allows the camera to avoid problems caused by artificial light sources that are not constant. These sources cycle (flicker) fast enough to go unnoticed to the human eye, appearing continuous. The camera's eye (its sensor) can still see this flicker. Options: **Auto** (default), **60 Hz**, **50 Hz**, or **Off**.







Video Settings

In Video mode, video settings appear on screen. Touch  to display the video settings options.

Front Video Camera

- **Video quality** - Set video quality to: **HD 1080**, **HD 720**, **SD 480p**, **VGA**, **CIF**, or **QVGA**.
- **Video duration** - Set to: **30 seconds (MMS)** or **30 minutes** (default).
- **GPS location** - Turn On or Off (default).
- **Storage** – Set the location to store the photo to: **Phone** (default) or **SD Card**.
- **White balance** - Select how the camera adjusts colors in different kinds of light, to achieve the most natural-looking colors.
 -  **Incandescent** - Adjust the white balance for incandescent lighting.
 -  **Fluorescent** - Adjust the white balance for florescent lighting.
 -  **Auto** - Adjust the white balance automatically (default).
 -  **Daylight** - Adjust the white balance for daylight.
 -  **Cloudy** - Adjust the white balance for a cloudy environment.
- **Image Stabilization** - Set to reduce blurry videos due to device movement. Options: **On** or **Off** (default).

Rear Video Camera

- **Flash** - Provides a steady light for recording video or not. Select whether Rear-facing Camera relies on its light meter to decide whether a light is necessary, or to turn it on or off for all shots.
 -  **Off** - Disable flash (default).
 -  **On** - Enable flash (a steady light).
- **Video quality** - Set video quality to: **4k DCI**, **4k UHD**, **HD 1080p** (default), **HD 720p**, **SD 480p**, **VGA**, **CIF**, or **QVGA**.
- **Video duration** - Set to: **30 seconds (MMS)**, or **30 minutes** (default).
- **GPS location** - Turn On or Off (default).
- **Storage** – Set the location to store the photo to: **Phone** (default) or **SD Card**.
- **White balance** - Select how the camera adjusts colors in different kinds of light, to achieve the most natural-looking colors.
 -  **Incandescent** - Adjust the white balance for incandescent lighting.
 -  **Fluorescent** - Adjust the white balance for florescent lighting.
 -  **Auto** - Adjust the white balance automatically (default).
 -  **Daylight** - Adjust the white balance for daylight.
 -  **Cloudy** - Adjust the white balance for a cloudy environment.
- **Image Stabilization** - Set to reduce blurry videos due to device movement. Options: **On** or **Off** (default).

Photos

The Photos application supports the following:

- Image formats: jpeg, gif, png, and bmp.
- Video formats: H.263, H.264 and MPEG4 Simple Profile.

Available on device with GMS software only.

Use the Photos app to:

- View photos
- Play videos
- Perform basic editing of photos
- Set photos as wallpaper
- Set photos as a contact photo
- Share photos and videos

The Photos app displays all photos and videos stored on internal memory.

1. To open the Photos application, swipe up from the bottom of the Home screen and touch .
By default, the Photos app opens to the Photos view.

Figure 56 Photos View



2. Touch **Albums** to view photos sorted by albums.

PTT Express Voice Client

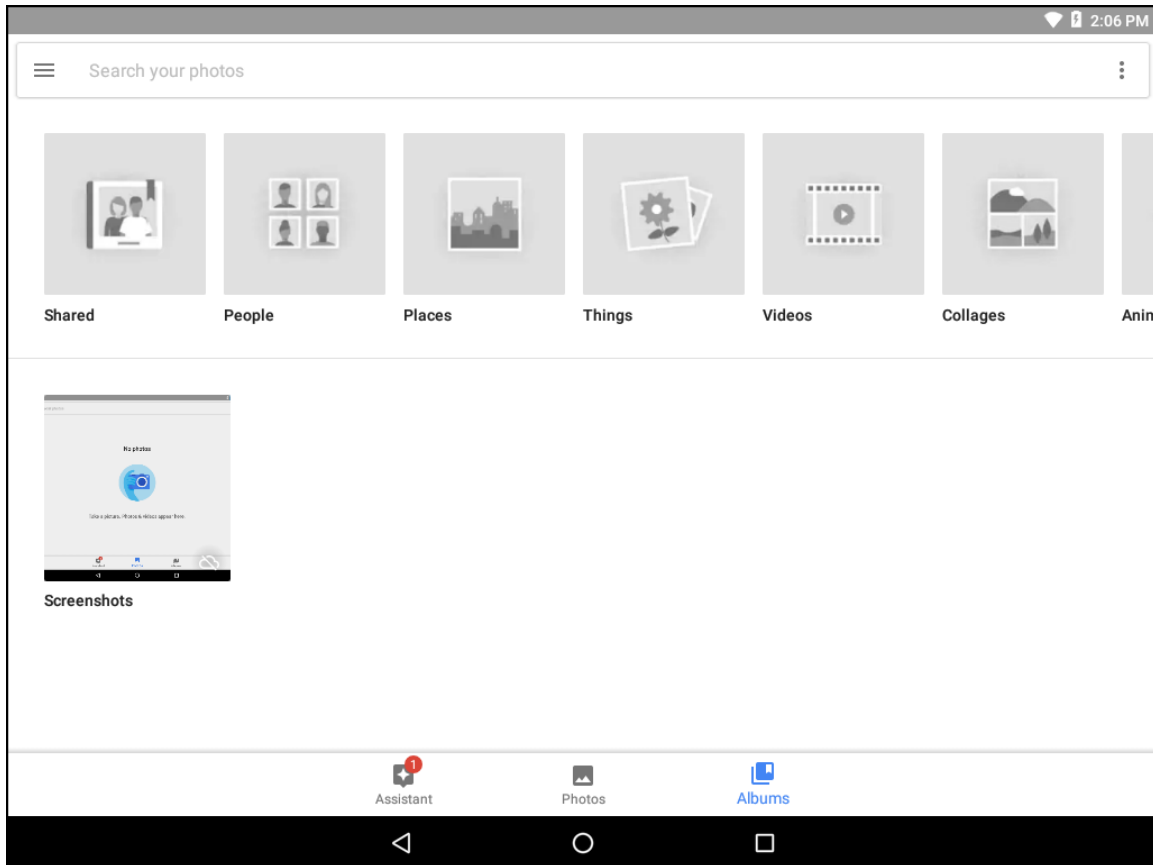
PTT Express Voice Client creates Push-To-Talk (PTT) communication capability between disparate enterprise devices. Leveraging existing Wireless Local Area Network (WLAN) infrastructure, PTT Express delivers simple PTT communication without the need of a voice communication server.

- **Group Call:** Press and hold the Talk button to start communicating with other voice client users.
- **Private Response:** Double-press and the Talk button to respond to the originator of the last broadcast or to make a Private Response.

Refer to the PTT Express User Guide at zebra.com/support for information on configuring the PTT Express Client application.

PTT Audible Indicators

The following tones provide helpful cues when using the voice client.

- **Talk Tone:** Double chirp. Plays when the Talk button is depressed. This is a prompt for the user to start talking.
- **Access Tone:** Single beep. Plays when another user just finished a broadcast or response. The user is now able to initiate a Group Broadcast or Private Response.

- **Busy Tone:** Continuous tone. Plays when the Talk button is depressed and another user is already communicating on the same talk group. Plays after the maximum allowed talk time is reached (60 seconds).
- **Network Tone:**
 - Three increasing pitch beeps. Plays when PTT Express has acquired the WLAN connection and the service is enabled.
 - Three decreasing pitch beeps. Plays when PTT Express has lost the WLAN connection or the service is disabled.

Figure 57 PTT Express Default User Interface

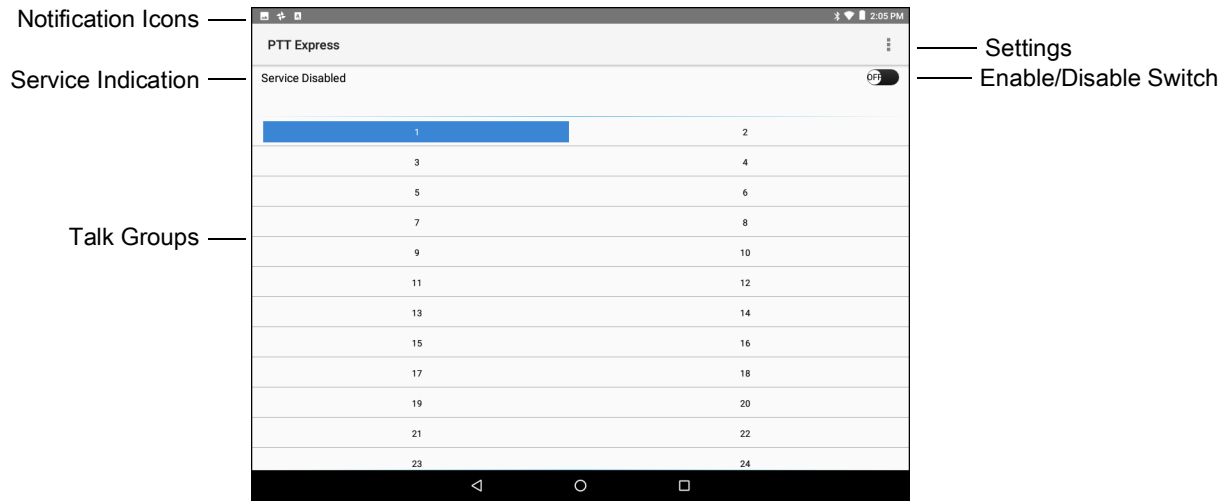









Table 21 PTT Express Default User Interface Descriptions

Item	Description
Notification Icon	Indicates the current state of the PTT Express client.
Service Indication	Indicates the status of the PTT Express client. Options: Service Enabled , Service Disabled or Service Unavailable .
Talk Groups	Lists all 32 Talk Groups available for PTT communication.
Settings	Opens the PTT Express Settings screen.
Enable/Disable Switch	Turns the PTT service on and off.

Notification Icons

Indicates the current state of the PTT Express Voice client.

Table 22 PTT Express Default User Interface Descriptions

Status Icon	Description
	Indicates that PTT Express Voice client is disabled.
	Indicates that PTT Express Voice client is enabled but not connected to a WLAN.
	Indicates that PTT Express Voice client is enabled, connected to a WLAN and listening on the Talk Group indicated by the number next to the icon.
	Indicates that PTT Express Voice client is enabled, connected to a WLAN and communicating on the Talk Group indicated by the number next to the icon.
	Indicates that PTT Express Voice client is enabled, connected to a WLAN and in a private response.
	Indicates that PTT Express Voice client is enabled and muted.
	Indicates that the PTT Express Voice client is enabled but it is not able to communicate due to a VoIP telephony call is in progress.

Enabling PTT Communication

1. Swipe up from the bottom of the Home screen and touch  .
The PTT Express Screen appears.
2. Slide the **Enable/Disable Switch** to the **ON** position.
The button changes to an **ON** button. See [Figure 58](#).
You can select one of 32 Talk Groups with the PTT Express app. However, only one talk group can be used at a time on the device.
3. Touch one of the 32 Talk Groups.
The selected Talk Group is highlighted.

Figure 58 PTT Express Screen



PTT Communication

This section describes the default PTT Express client configuration. See the PTT Express V1.2 User Guide for detailed information on using the client.

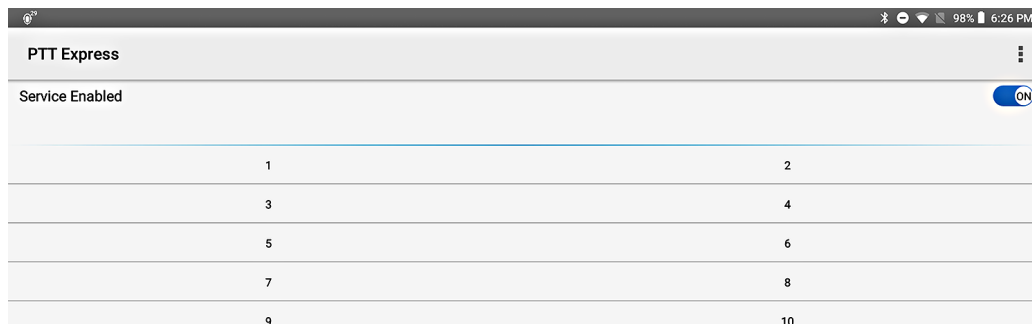

NOTE: To display the on-screen buttons, configure the PPT Express app according to the PTT Express User Guide.

Creating a Group Call

1. Press and hold the on-screen **Group Call** button to start communicating with other voice client users.
2. If you hear a double-chirp talk tone when the **Group Call** button is depressed, you can start talking.
3. If you hear a busy tone, release the button and wait a moment before making another attempt. Ensure that PTT Express and the WLAN are enabled.
4. Start talking after the double-chirp tone is heard.
5. Release the button when finished talking.



NOTE: The busy tone is a continuous sound that plays when the **Group Call** button is depressed and another user is already communicating on the same talk group. This tone also plays after the maximum allowed talk time is reached (60 seconds).

Responding with a Private Response



The Private Response can only be initiated once a Group Call has been established. The initial Private Response is made to the originator of the Group Call.

1. Press and hold the on-screen **Private Response** button to respond to the originator of the last broadcast or to make a Private Response.
2. Wait until an access tone is heard.
3. Within 10 seconds, press and hold the **Private Response** button, and listen for the talk tone to play.
4. If a busy tone is heard, release the button and wait a moment before making another attempt. Ensure that PTT Express and the WLAN are enabled.
5. Start talking after the talk tone plays.
6. Release the button when finished talking.



NOTE: If you hold the button for more than 60 seconds (default), the call is dropped allowing others to make Group calls. Release the button when finished talking to allow others to make calls.

Disabling PTT Express Voice Client Communication

1. Swipe up from the bottom of the Home screen and touch  .
2. Slide the **Enable/Disable Switch** to the **OFF** position.
The button changes to **OFF**.
3. Touch .

Sound Recorder

Use **Sound Recorder** to record audio messages.

Recordings are saved on the microSD card (if installed) or the internal storage and are available in the Music application (non-GMS devices) or the Play Music application (GMS devices).

Figure 59 Sound Recorder Application

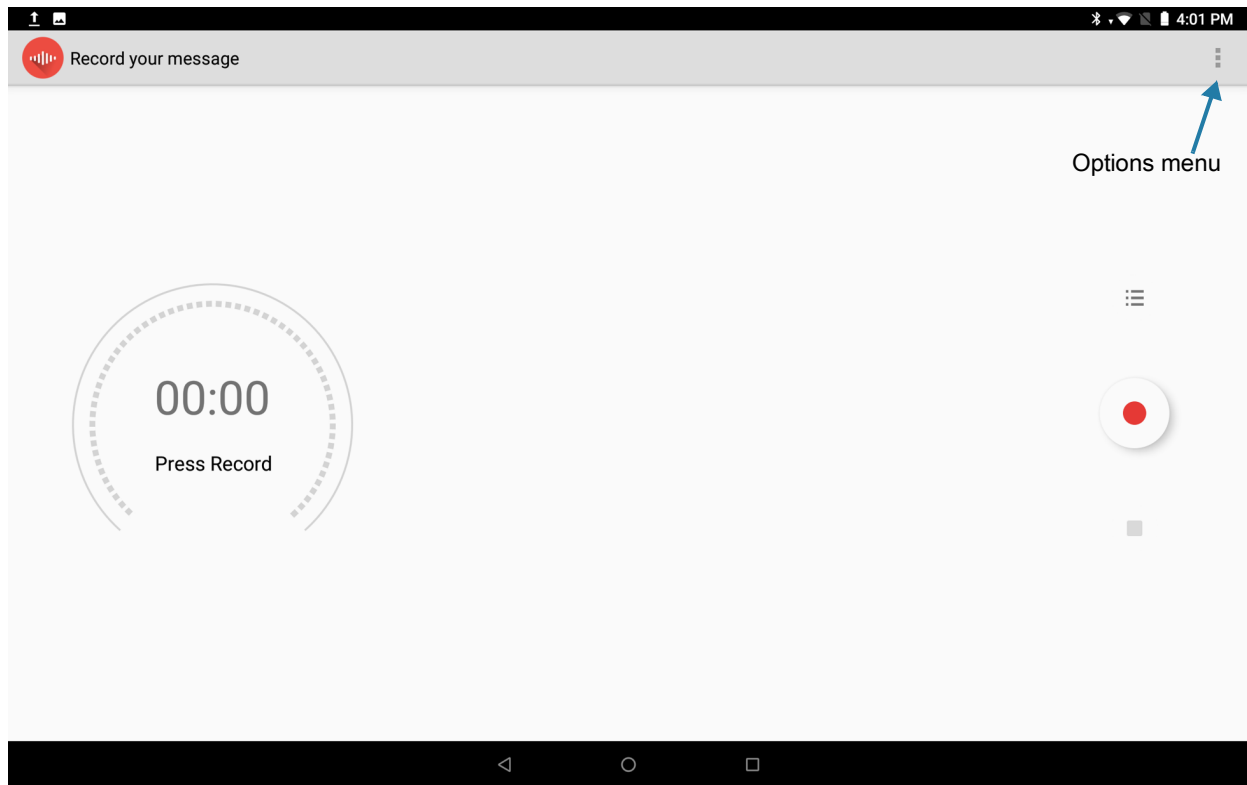

Touch  to open options menu.

- **File type** – Select the file type for the recording file.
 - **AMR**
 - **3GPP**
 - **AAC**
 - **WAV**
 - **AMR-WB**
 - **AMR-WB-3GPP.**
- **Storage location** – Select the location for the recording file.
 - **Phone storage**
 - **SD card.**

Wireless

Introduction

This section provides information on the wireless features:

- Wireless Wide Area Network (WWAN)
- Wireless Local Area Network (WLAN)
- Bluetooth technology
- Near Field Communication.

Wireless Wide Area Networks

Use wireless wide area networks (WWANs) to access data over a cellular network. This section provides information on the following topics:

- Configuring Access Point Names (APN)
- Locking a SIM card
- Monitoring data usage





Configuring the Access Point Name



NOTE: The service provider preconfigures many Access Point Name (APN) data in the device. The APN information for all other service providers must be obtained from the wireless service provider.

The Access Point Name (APN) is the name for the settings your phone reads to set up a connection to the gateway between your carrier's cellular network and the public Internet.

To use the data on a network, configure the APN information. Follow the steps in this procedure:

1. Swipe down with two fingers from the status bar to open the quick access panel and touch the **Settings** button. 
2. Touch **Network & Internet > Mobile network > Advanced**.
3. Touch **Access Point Names**.
4. Touch an APN name in the list to edit an existing APN or touch  to create a new APN.
5. Touch each APN setting and enter the appropriate data obtained from the wireless service provider.
6. When finished, touch  in the upper right corner and touch **Save**.
7. Touch the radio button next to the APN name to start using it.
8. Touch .

Locking the SIM Card

Locking the SIM card requires the user to enter a PIN every time the device is turned on. If the correct PIN is not entered, only emergency calls can be made.

1. Swipe down from the Status bar to open the Quick Access panel and then touch .
2. Touch **Security & location**.
3. Touch **SIM card lock**.
4. Touch **Lock SIM card**.

Figure 60 Enter PIN to Lock the SIM Card



5. Enter the PIN associated with the card.
6. Touch **OK**.
7. Reset the device.

Monitoring Data Usage

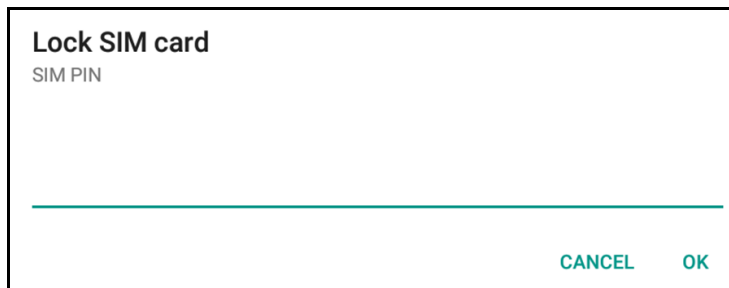
Data usage refers to the amount of data uploaded or downloaded by the device during a given period. This is data that is not accessed through Wi-Fi. Depending on the wireless plan, you might owe additional fees when your data usage exceeds your plan's limit. In this section, you learn about using the data saver, setting a warning about the amount of data used, and setting a data limit.

Turning on the Data Saver



1. Swipe down from the Status bar to open the Quick Access panel and then touch .
2. Touch **Network & Internet > Data usage**  Data usage
1% of data used

Figure 61 Data Usage Form



3. Touch **Data saver**.
The Data saver form appears.

4. Touch the button to turn the data saver function on or off.

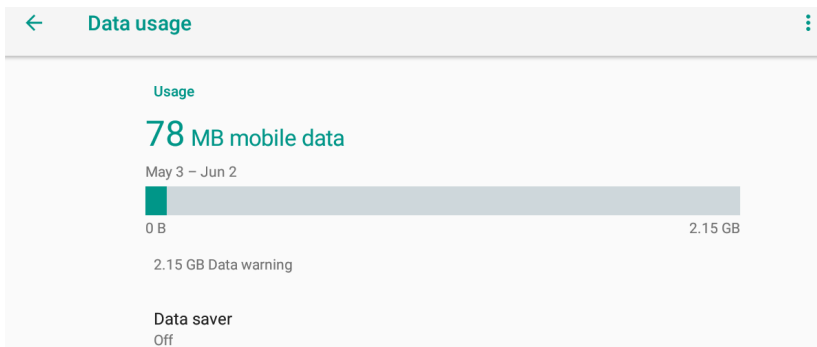
By turning the data saver on, it helps reduce some uses of data by preventing some applications from sending or receiving data in the background.



CAUTION The usage displayed on the data usage settings screen is measured by your device. Your carrier's data usage accounting might differ. Usage in excess of your carrier plan's data limits can result in steep overage charges. The feature described here can help you track your usage, but is not guaranteed to prevent additional charges.

Setting Data Usage Warning

Data usage settings provide these functions:

- Set the data usage warning level.
- Set a data usage limit.
- View or restrict data usage by app.
- Identify mobile hotspots and restrict background downloads that might result in extra charges.

To set a warning alert to tell you when the device has used a specific amount of mobile data, follow these steps:

1. Swipe down from the Status bar to open the Quick Access panel.
Touch the Settings button. 

2. Touch **Network & Internet > Data usage** 

The Data usage form appears.

Figure 62 Data Usage Form

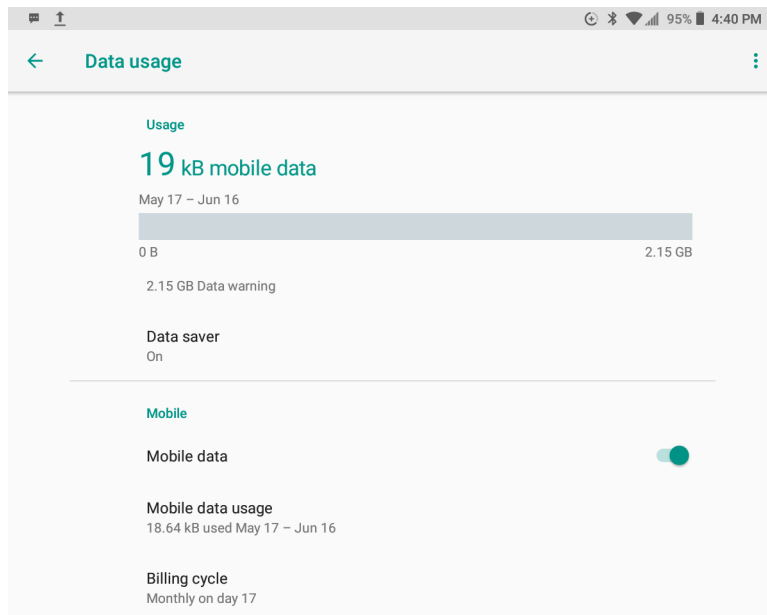

By default, the data usage screen displays the mobile data settings.

3. Touch Billing cycle.

The Billing cycle form appears. This form shows settings that help you be aware of the data usage, limits you have set, and the day of the month that resets the billing period.

Figure 63 Billing Cycle Form

The screenshot shows the 'Billing cycle' form. At the top, there is a back arrow and the title 'Billing cycle'. Below this, the 'Billing cycle' is set to 'Monthly on day 3'. The 'Set data warning' toggle switch is currently turned off. Below the toggle, the 'Data warning' field is visible.

4. Touch **Set data warning** to turn it on.
This button also turns it off.

Figure 64 Billing Cycle Form

The screenshot shows the 'Billing cycle' form with annotations. The 'Set data warning' toggle switch is now turned on (green). A line points from the text 'Data warning is on.' to the toggle. Below the toggle, the 'Data warning' field is set to '2.15 GB'. A line points from the text 'Data warning limit is shown.' to this field.

5. Touch **Data warning** to set the threshold to inform you of data use.
The Set data usage warning form appears.

Figure 65 Set Data Usage Warning

The screenshot shows the 'Set data usage warning' form. The warning threshold is set to '2.15' and the unit is 'GByte'. A dropdown arrow is visible next to the unit. A line points from the text 'Touch down arrow to switch between MBytes and GBytes.' to the dropdown arrow. Below the input field, there is a 'SET' button.

6. To switch between megabytes (MB) and gigabytes (GB), touch the down arrow on the right side of the warning form.
7. Enter a number to set the warning threshold for data usage.
8. Touch **SET** to confirm the limit.
The Data warning field shows the amount you set.
When the usage reaches the warning threshold, you are notified.

Setting a Data Limit

1. Swipe down from the Status bar to open the Quick Access panel and then touch .
2. Touch **Network & Internet**.
The Network & Internet form appears.

Figure 66 Network & Internet Form



3. Touch **Data usage**.
The Data usage form appears.

Figure 67 Data Usage Form

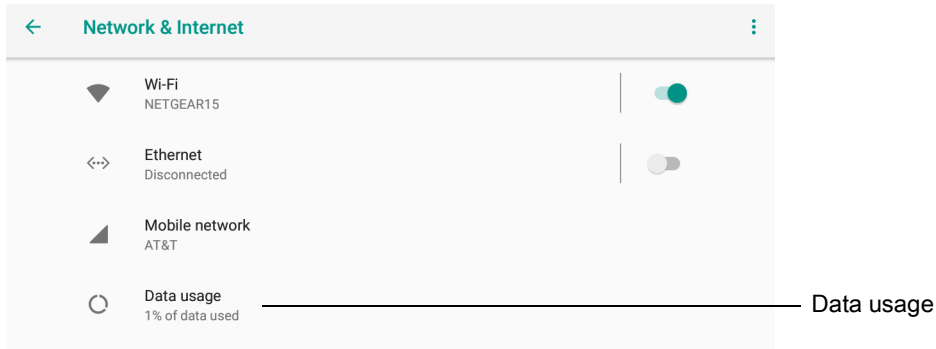
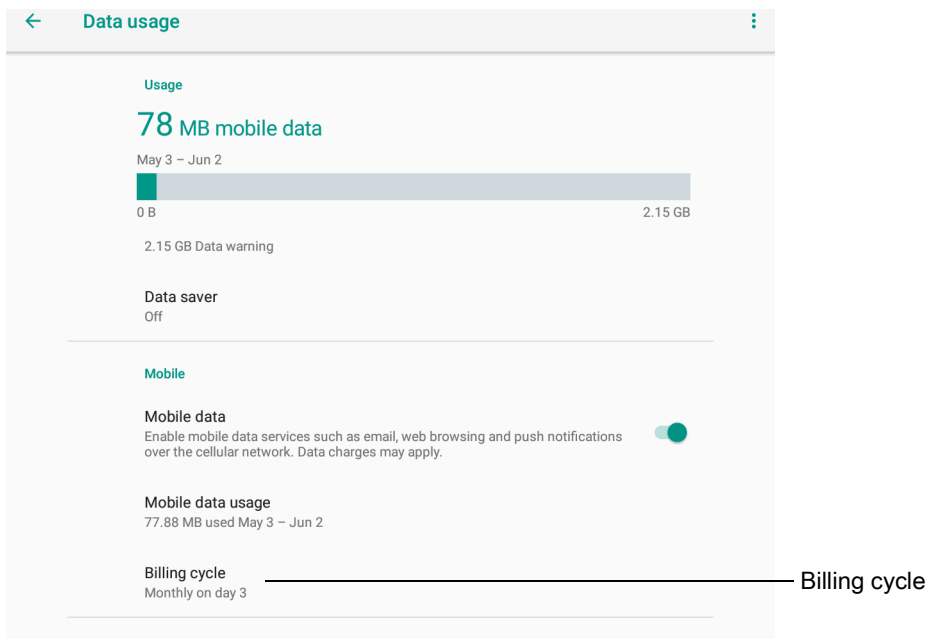

4. Touch **Billing Cycle**.
The Billing Cycle form appears.

Figure 68 Billing Cycle Form

← Billing cycle

Billing cycle
Monthly on day 3

Set data warning

Data warning

Set data limit

Data limit
6.90 GB

5. Touch **Set data limit**.
6. If you see a **Limiting data usage** pop-up window, touch **OK**.

Figure 69 Message about Limiting Data Usage

Limiting data usage

Your phone will turn off mobile data once it reaches the limit you set.

Since data usage is measured by your phone, and your carrier may account for usage differently, consider setting a conservative limit.

CANCEL OK

The **Set data usage limit** form appears.

7. If no data limit has been set, touch **Data limit**.
- The **Set data usage limit** form appears with an on-screen number pad.

Figure 70 The Set Data Usage Limit Form

Limiting data usage

Your phone will turn off mobile data once it reaches the limit you set.

Since data usage is measured by your phone, and your carrier may account for usage differently, consider setting a conservative limit.

CANCEL OK

8. Enter a number to set the limit.
To switch between megabytes (MB) and gigabytes (GB), touch the down arrow.
9. Touch **Set** to confirm the limit.
When the limit is reached, data automatically turns off and a notification appears.

Viewing Mobile Data Usage

- To see a summary of data usage, touch **Mobile data usage**.
The Mobile data usage screen displays how much data has been used, the data warning setting, and the billing cycle dates.

Figure 71 Mobile Data Usage

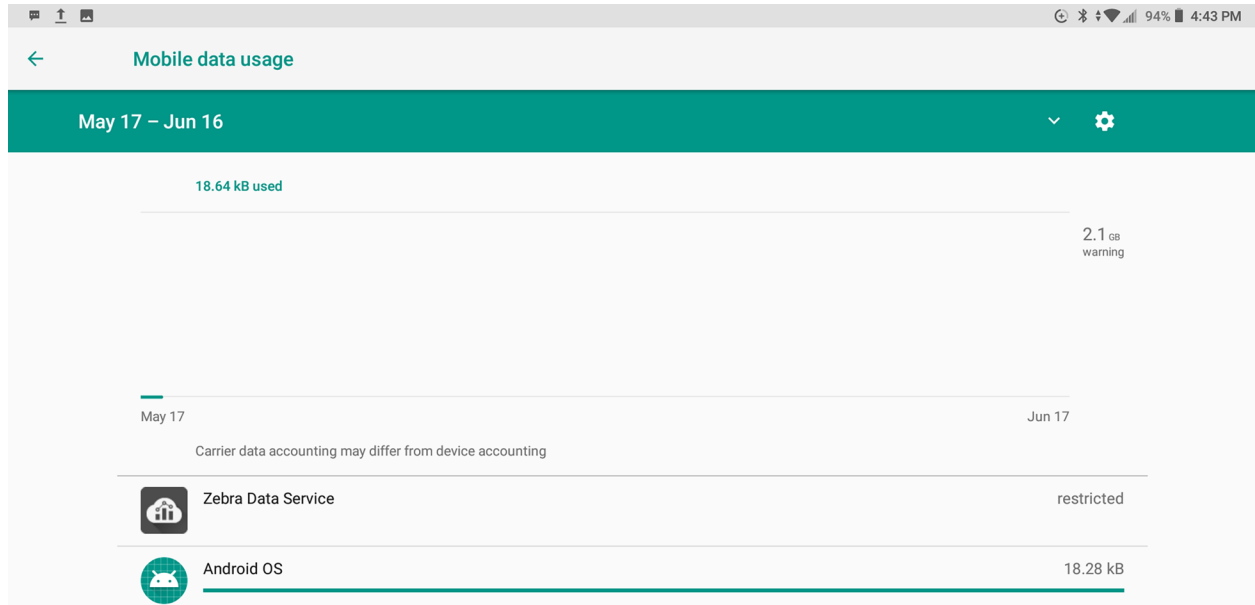

Wireless Local Area Networks



NOTE: If using an external antenna, ensure correct settings.

Wireless local area networks (WLANs) allow the device to communicate wirelessly inside a building. Before using the device on a WLAN, the facility must be set up with the required hardware to run the WLAN (sometimes known as infrastructure). The infrastructure and the device must both be properly configured to enable this communication.

Refer to the documentation provided with the infrastructure (access points (APs), access ports, switches, Radius servers, etc.) for instructions on how to set up the infrastructure.

Once the infrastructure is set up to enforce the chosen WLAN security scheme, use the **Wireless & networks** settings configure the device to match the security scheme.

The device supports the following WLAN security options:

- Open
- Wireless Equivalent Privacy (WEP).
- Wi-Fi Protected Access (WPA and WPA2) Pre-Shared Key (PSK).
- Extensible Authentication Protocol (EAP).

The **Status** bar displays icons that indicate Wi-Fi network availability and Wi-Fi status. See Status Bar for more information.

Scanning and Connecting to a Wi-Fi Network

To scan and connect to a Wi-Fi network, follow this procedure.

1. Swipe down from the Status bar to open the Quick Settings bar or the Quick Access panel.

Figure 72 Quick Access Bar Panel

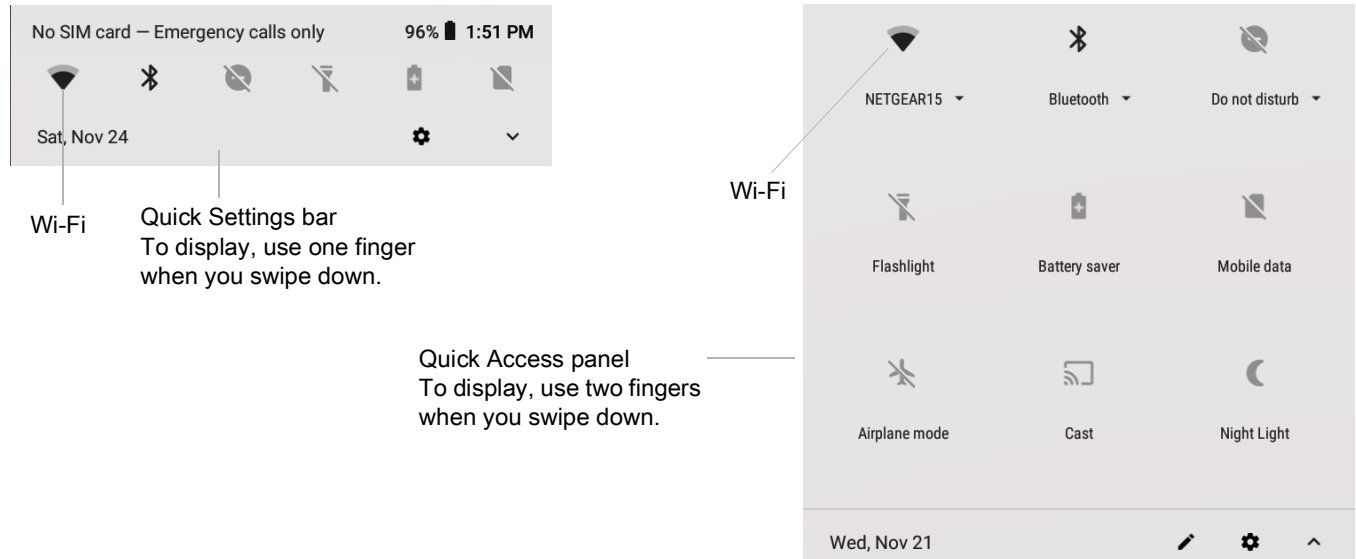

2. Touch **Wi-Fi** to open the Wi-Fi screen.
The device searches for WLANs in the area and lists them.

Figure 73 Wi-Fi Screen

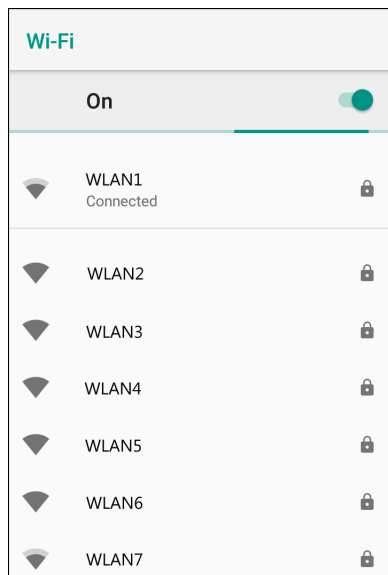



3. Scroll through the list and select a WLAN network.
4. For open networks, touch profile once or press and hold and then touch **Connect to network** or for secure networks enter the required password or other credentials then touch **Connect**.
See the system administrator for more information.

- The device obtains a network address and other required information from the network using the dynamic host configuration protocol (DHCP). To configure the device with a fixed internet protocol (IP) address, refer to the device Integrator Guide for more information.
- In the Wi-Fi setting field, **Connected** appears indicating that the device is connected to the WLAN.

Removing a Wi-Fi Network

To remove a remembered or connected network:

- Swipe down from the status bar and then touch .
- Touch **Network & Internet > Wi-Fi**.
- In the **Wi-Fi** list, touch and hold the name of the network.
A menu pops up.
- In the menu, touch **Forget network**.
- Touch .

Configuring a Wi-Fi Network

To set up a Wi-Fi network:

- Swipe down from the status bar and then touch .
- Touch **Network & Internet > Wi-Fi**.
- Slide the switch to the **ON** position.
- The device searches for WLANs in the area and lists them on the screen.
- Scroll through the list and touch the WLAN network you want.
If the network security is **Open**, the device automatically connects to the network.
For all other network security, a network security dialog box appears.

Figure 74 WLAN WEP Network Security Dialog Box



- Enter the password.
- Touch **CONNECT**.
The tablet connects to the Wi-Fi network.

Figure 75 WLAN 802.11 EAP Network Security Dialog Box

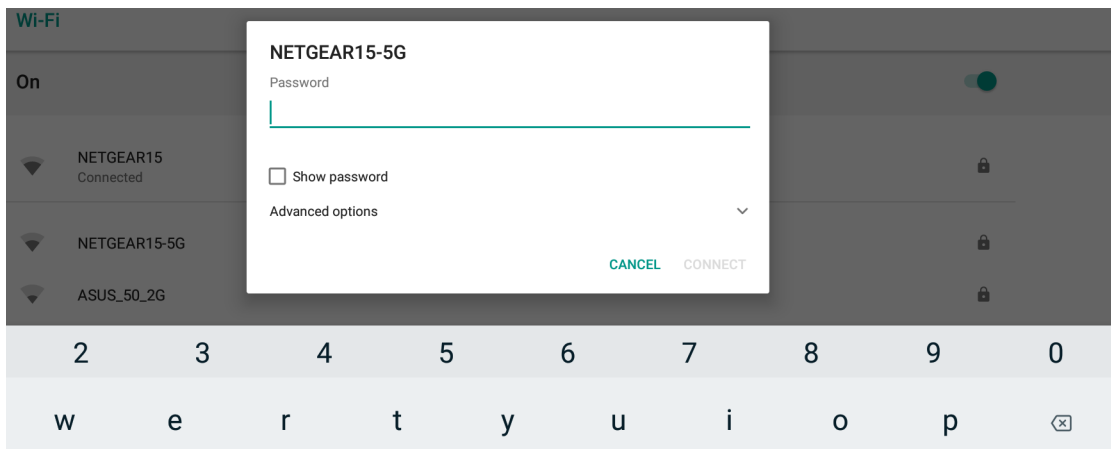
8. If the network security is **WEP** or **WPA/WPS2 PSK**, enter the required password and then touch **Connect**.
9. If the network security is 802.1x EAP, follow these steps:
 - Touch the **EAP method** drop-down list and select **PEAP**, **TLS**, **TTLS**, **PWD**, or **LEAP**.
 - Touch the **Phase 2 authentication** drop-down list and select an authentication method.
 - If required, touch **CA certificate** and select a Certification Authority (CA) certificate. Note: Certificates are installed using the **Security** settings.
 - If required, touch **User certificate** and select a user certificate. Note: User certificates are installed using the location & security settings.
 - If required, in the **Identity** text box, enter the username credentials.
 - If you like, in the **Anonymous identity** text box, enter an anonymous identity username.
 - If required, in the **Password** text box, enter the password for the given identity.





NOTE: By default, the network Proxy is set to **None** and the IP setting is set to **DHCP**. See [Configuring for a Proxy Server on page 89](#) for setting connection to a proxy server. See [Configuring the Device to Use a Static IP Address on page 90](#) for setting the device to use a static IP address.

10. Touch **Connect**.
11. Touch .

Manually Adding a Wi-Fi Network

Manually add a Wi-Fi network if the network does not broadcast its name (SSID) or to add a Wi-Fi network when out of range.

1. Swipe down from the status bar and then touch the Settings icon .
2. Touch **Network & Internet > Wi-Fi**.
3. Slide the Wi-Fi switch to the **On** position.

4. Scroll down to the bottom of the window and touch **Add network**.
 5. In the **Enter the SSID** text box, enter the name of the Wi-Fi network.
 6. In the **Security** drop-down list, select the type of security. The Options include:
 - **None**
 - **WEP**
 - **WPA/WPA2 PSK**
 - **802.1x EAP**.
 7. If the network security is **None**, touch **Save**.
 8. If the network security is **WEP** or **WPA/WPA2 PSK**, enter the required password and then touch **Save**.
 9. If the network security is **802.1x EAP**:
 - Touch the **EAP method** drop-down list and select **PEAP, TLS, TTLS, PWD, or LEAP**.
 - Touch the **Phase 2 authentication** drop-down list and select an authentication method.
 - If required, touch **CA certificate** and select a Certification Authority (CA) certificate. Note: Certificates are installed using the **Security** settings.
 - If required, touch **User certificate** and select a user certificate. Note: User certificates are installed using the **Security** settings.
 - If required, in the **Identity** text box, enter the username credentials.
 - If desired, in the **Anonymous** identity text box, enter an anonymous identity username.
 - If required, in the **Password** text box, enter the password for the given identity.
-  **NOTE:** By default, the network Proxy is set to **None** and the IP settings is set to **DHCP**. See [Configuring for a Proxy Server on page 89](#) for setting connection to a proxy server and see [Configuring the Device to Use a Static IP Address on page 90](#) for setting the device to use a static IP address.
10. Touch **Save**.
To connect to the saved network, touch and hold on the saved network and select **Connect to network**.
 11. Touch .

Configuring for a Proxy Server

A proxy server is a server that acts as an intermediary for requests from clients seeking resources from other servers. A client connects to the proxy server and requests some service, such as a file, connection, web page, or other resource, available from a different server. The proxy server evaluates the request according to its filtering rules. For example, it may filter traffic by IP address or protocol. If the request is validated by the filter, the proxy provides the resource by connecting to the relevant server and requesting the service on behalf of the client.

It is important for enterprise customers to be able to set up secure computing environments within their companies, making proxy configuration essential. Proxy configuration acts as a security barrier ensuring that the proxy server monitors all traffic between the Internet and the intranet. This is normally an integral part of security enforcement in corporate firewalls within intranets.

To configure the device for a proxy server:

1. In the network dialog box, touch a network.
2. Touch **Advanced options**.
3. Touch **Proxy** and select **Manual**.
4. In the **Proxy hostname** text box, enter the address of the proxy server.
5. In the **Proxy port** text box, enter the port number for the proxy server.

6. In the **Bypass proxy for** text box, enter addresses for web sites that are not required to go through the proxy server. Use a comma “,” between addresses. Do not use spaces or carriage returns between addresses.
7. Touch **Connect**.
8. Touch .

Configuring the Device to Use a Static IP Address

By default, the device is configured to use Dynamic Host Configuration Protocol (DHCP) to assign an Internet protocol (IP) address when connecting to a wireless network.

To configure the device to connect to a network using a static IP address:

1. In the network dialog box, touch a network.
2. Touch **Advanced options**.
3. Touch **IP settings** and select **Static**.
4. In the **IP address** text box, enter an IP address for the device.
5. If required, in the **Gateway** text box, enter a gateway address for the device.
6. If required, in the **Network prefix length** text box, enter the prefix length.
7. If required, in the **DNS 1** text box, enter a Domain Name System (DNS) address.
8. If required, in the **DNS 2** text box, enter a DNS address.
9. Touch **Connect**.
10. Touch .

Wi-Fi Preferences

Use the **Wi-Fi preferences** to configure advanced Wi-Fi settings. From the Wi-Fi screen scroll down to the bottom of the screen and touch **Wi-Fi preferences**.

- **Open network notification** - When enabled, notifies you when an open network is available.
- **Advanced - Touch to expand options.**
 - **Additional settings** - See Additional Settings.
 - **Install Certificates** – Touch to install certificates.
 - **Network rating provider** - Disabled (AOSP devices). To help determine what constitutes a good Wi-Fi network, Android supports external Network rating providers that provide information about the quality of open Wi-Fi networks. Select one of the providers listed or **None**. If none are available or selected, the Connect to open networks feature is disabled.
 - **Wi-Fi Direct** - Displays a list of devices available for a direct Wi-Fi connection.
 - **WPS Push Button** - Touch to connect to a network using Wi-Fi Protected Setup (WPS) push button method.
 - **WPS Pin Entry** - Touch to connect to a network using Wi-Fi Protected Setup (WPS) pin entry method.
 - **MAC address** - Displays the Media Access Control (MAC) address of the device when connecting to Wi-Fi networks.
 - **IP address** - Displays the IP address of the device when connecting to Wi-Fi networks.

Additional Wi-Fi Settings

Use the **Additional Settings** to configure additional Wi-Fi settings. To view the additional Wi-Fi settings, scroll to the bottom of the **Wi-Fi** screen and touch **Wi-Fi Preferences > Advanced > Additional settings**.



NOTE: Additional Wi-Fi settings are for the device, not for a specific wireless network.

- **Regulatory**
 - **Country Selection** - Displays the acquired country code if 802.11d is enabled, else it displays the currently selected country code.
 - **Region code** - Displays the current region code.
- **Band and Channel Selection**
 - **Wi-Fi frequency band** - Set the frequency band to: **Auto** (default), **5 GHz only** or **2.4 GHz only**.
 - **Available channels (2.4 GHz)** - Touch to display the **Available channels** menu. Select specific channels and touch **OK**.
 - **Available channels (5 GHz)** - Touch to display the **Available channels** menu. Select specific channels and touch **OK**.
- **Logging**
 - **Advanced Logging** – Touch to enable advanced logging or change the log directory.
 - **Wireless logs** - Use to capture Wi-Fi log files.
 - **Fusion Logger** - Touch to open the **Fusion Logger** application. This application maintains a history of high level WLAN events which helps to understand the status of connectivity.
 - **Fusion Status** - Touch to display live status of WLAN state. Also provides information about the device and connected profile.
- **About**
 - **Version** - Displays the current Fusion information.

Wi-Fi Direct

Wi-Fi Direct devices can connect to each other without having to go through an access point. Wi-Fi Direct devices establish their own ad-hoc network when required, letting you see which devices are available and choose which one you want to connect to.

1. Swipe down from the status bar and then touch .
2. Touch **Wi-Fi > Wi-Fi preferences > Advanced > Wi-Fi Direct**. The device begins searching for another Wi-Fi Direct device.

Figure 76 Wi-Fi Direct Screen

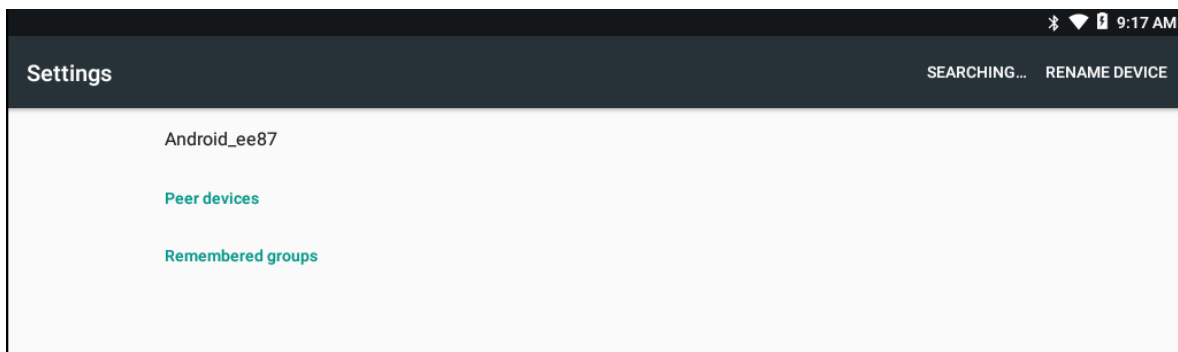

3. Under **Peer devices**, touch the other device name.
4. On the other device, select **Accept**.
5. **Connected** appears on the device. On both devices, in their respective Wi-Fi Direct screens, the other device name appears in the list.

WPS Pin Entry

Wi-Fi Protected Setup (WPS) is a feature allowing devices to easily connect to Wi-Fi access points without typing a long password.

To use a PIN to connect to a wireless router:

1. Log in to the router.
2. Go to the Add WPS Client screen. Refer to the wireless router user documentation specific information.
3. On the device, swipe down from the status bar and then touch .
4. Touch **Wi-Fi > Wi-Fi preferences > Advanced > WPS Pin Entry**.

A dialog box displays a Pin number.

Figure 77 Pin Entry Dialog Box

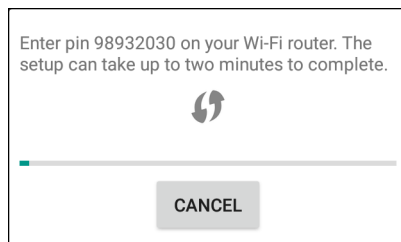

5. On the router, enter the Pin number.
6. The device connects to the wireless router.

WPS Push Button

Wi-Fi Protected Setup (WPS) is a feature allowing devices to easily connect to Wi-Fi access points without typing a long password.

To use a wireless router WPS button:

1. On the device, swipe down from the status bar and then touch .
2. Touch **Wi-Fi > Wi-Fi preferences > Advanced > WPS Push Button**.

A dialog box displays a pin number.

Figure 78 Pin Entry Dialog Box

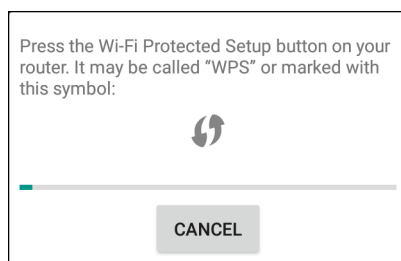

3. On the wireless router, locate the WPS button.

The device connects to the wireless router.

Wi-Fi Advanced Features

Some additional Wi-Fi settings cannot be accessed from the user interface. They can be configured by using Wi-Fi (CSP). Refer to EMDK documentation for the details on the Wi-Fi settings configuration using the Wi-Fi CSP.

- **Auto Time Config** - Using this feature, the device can sync up its time with Zebra WLAN infrastructure. This feature works only when the device is connected to Zebra WLAN infrastructure and the feature is enabled on the WLAN infrastructure side. Default: disabled.
- **PMKID Caching** - Allows the device to skip 802.1x authentication during roaming if it had previously connected to that AP with a full 802.1x authentication. Default: disabled. Note: disable OKC when enabling PMKID Caching.
- **Opportunistic Key Caching** - Use this feature to skip 802.1x authentication during roaming. The device will go for full 802.1x authentication for the first time it connects to the network. For subsequent roaming, the device skips 802.1x authentication. Default: enabled.
- **Cisco Centralized Key Management** - Allows the device to skip 802.1x and key-handshake phases during roaming. This feature is available only when the device is connected to a Cisco infrastructure that supports Cisco Centralized Key Management (CCKM). Default: enabled.
- **Fast Transition** - Fast Transition (FT) is the fast roaming standard, 802.11r. With this feature, the device can skip 802.1x and key-handshake phases during roam. Default: enabled.
- **Fast Transition Resource Information Container** - Allows the device to request TSPEC as part of reassociation frame exchange. This helps to avoid sending a separate resource request after roaming is completed. Default: enabled.
- **Power Save** - The device can be configured to work in different power save modes:
 - **Active** - Keeps the WLAN radio always in active mode (i.e. power save mode disabled).
 - **Power save using WMM-PS** - This is the default power save mode. Device uses WMM-PS power save method if the AP is configured to use this. If the AP is not supporting WMM-PS, the device will use PS-Poll power save method.
 - **Power save using PS-Poll** - In this method, the device will use PS-Poll frames to retrieve buffered frames from the AP.
 - **Null Data Power Save** - In Null Data Power Save (NDP), the device will stay awake for 100 ms after the last frame is sent or received. The device will send a Null Data packet with power management bit cleared to retrieve buffered frames from the AP.
- **802.11k** - Using 802.11k, the device can discover neighbor APs and adds support for different types of radio resource measurements. Default: enabled.
- **Band Preference** - The device can be configured to prefer one band over another. Default: disabled.
- **Subnet Roaming** - When the device roams between different sub networks, if it detects that it is roaming to a different subnet, the device will request a fresh IP address. Default: disabled.

Zebra Mobility Extensions

Zebra Mobility Extensions make use of 802.11 specifications and Zebra proprietary extensions to achieve the highest level of performance, efficiency and reliability. The device adds support for the following Zebra Mobility Extensions:

- **Coverage Hole Detection**
The device includes enhancements to the IEEE 802.11k standard. These improvements will report gaps in signal coverage to the Zebra wireless LAN infrastructure. Network administrators can detect and mitigate coverage gaps present in the network for greater reliability. Default: enabled.

- **Aggregated Fast Transition**
Aggregated FT improves on IEEE 802.11r, Over-the-DS fast roaming. In conjunction with Zebra wireless LAN infrastructure, the device will achieve more reliable and consistent fast roaming. Default: enabled.
- **Scan Assist**
The device monitors neighbor access points and retrieves roaming related information from the Zebra wireless LAN infrastructure without doing scans. Using this Scan Assist feature, the device improves roaming. Default: enabled.

Bluetooth

Bluetooth devices can communicate without wires, using frequency-hopping spread spectrum (FHSS) radio frequency (RF) to transmit and receive data in the 2.4 GHz Industry Scientific and Medical (ISM) band (802.15.1). Bluetooth wireless technology is specifically designed for short-range (10 m (32.8 ft)) communication and low power consumption.

Devices with Bluetooth capabilities can exchange information (files, appointments, and tasks) with other Bluetooth enabled devices such as printers, access points, and other mobile devices.

The device supports Bluetooth Low Energy. Bluetooth Low Energy is targeted at applications in the healthcare, fitness, security, and home entertainment industries. It provides reduced power consumption and cost while maintaining standard Bluetooth range.

Adaptive Frequency Hopping

Adaptive Frequency Hopping (AFH) is a method of avoiding fixed frequency interferers, and can be used with Bluetooth voice. All devices in the piconet (Bluetooth network) must be AFH-capable in order for AFH to work. There is no AFH when connecting and discovering devices. Avoid making Bluetooth connections and discoveries during critical 802.11b communications. AFH for Bluetooth consists of four main sections:

- **Channel Classification** - A method of detecting an interference on a channel-by-channel basis, or predefined channel mask.
- **Link Management** - Coordinates and distributes the AFH information to the rest of the Bluetooth network.
- **Hop Sequence Modification** - Avoids interference by selectively reducing the number of hopping channels.
- **Channel Maintenance** - A method for periodically re-evaluating the channels.

When AFH is enabled, the Bluetooth radio “hops around” (instead of through) the 802.11b high-rate channels. AFH coexistence allows enterprise devices to operate in any infrastructure.

The Bluetooth radio in this device operates as a Class 2 device power class. The maximum output power is 2.5 mW and the expected range is 10 m (32.8 ft). A definition of ranges based on power class is difficult to obtain due to power and device differences, and whether in open space or closed office space.



NOTE: It is not recommended to perform Bluetooth wireless technology inquiry when high rate 802.11b operation is required.

Bluetooth Security

The current Bluetooth specification defines security at the link level. Application-level security is not specified. This allows application developers to define security mechanisms tailored to their specific need. Link-level security occurs between devices, not users, while application-level security can be implemented on a per-user basis. The Bluetooth specification defines security algorithms and procedures required to authenticate devices, and if needed, encrypt the data flowing on the link between the devices. Device authentication is a mandatory feature of Bluetooth while link encryption is optional.

Pairing of Bluetooth devices is accomplished by creating an initialization key used to authenticate the devices and create a link key for them. Entering a common personal identification number (PIN) in the devices being paired generates the initialization key. The PIN is never sent over the air. By default, the Bluetooth stack responds with no key when a key is requested (it is up to user to respond to the key request event). Authentication of Bluetooth devices is based-upon a challenge-response transaction. Bluetooth allows for a PIN or passkey used to create other 128-bit keys used for security and encryption. The encryption key is derived from the link key used to authenticate the pairing devices. Also worthy of note is the limited range and fast frequency hopping of the Bluetooth radios that makes long-distance eavesdropping difficult.

Recommendations are:

- Perform pairing in a secure environment
- Keep PIN codes private and do not store the PIN codes in the device
- Implement application-level security.

Bluetooth Profiles

The device supports the Bluetooth services listed in the table below:

Table 23 Bluetooth Profiles

Profile	Description
Service Discovery Protocol (SDP)	Handles the search for known and specific services as well as general services.
Serial Port Profile (SPP)	Allows use of RFCOMM protocol to emulate serial cable connection between two Bluetooth peer devices. For example, connecting the device to a printer.
Object Push Profile (OPP)	Allows the device to push and pull objects to and from a push server.
Advanced Audio Distribution Profile (A2DP)	Allows the device to stream stereo-quality audio to a wireless headset or wireless stereo speakers.
Audio/Video Remote Control Profile (AVRCP)	Allows the device to control A/V equipment to which a user has access. It may be used in concert with A2DP.
Personal Area Network (PAN)	Allows the use of Bluetooth Network Encapsulation Protocol to provide L3 networking capabilities over a Bluetooth link. Only PANU role is supported.
Human Interface Device Profile (HID)	Allows Bluetooth keyboards, pointing devices, gaming devices and remote monitoring devices to connect to the device.
Headset Profile (HSP)	Allows a hands-free device, such as a Bluetooth headset, to place and receive calls on the device.
Hands-Free Profile (HFP)	Allows car hands-free kits to communicate with the device in the car.

Table 23 Bluetooth Profiles (Continued)

Profile	Description
Out of Band (OOB)	Allows exchange of information used in the pairing process. Pairing is completed using the Bluetooth radio, but requires information from the OOB mechanism.
File Transfer Profile (FTP)	Provides the capability to browse, manipulate and transfer files in file system of another system. Uses GOEP as a basis.
Generic Attribute Profile (GATT)	Provides profile discovery and description services for Bluetooth Low Energy protocol. It defines how attributes are grouped together into sets to form services.
HID Over GATT Profile (HOGP)	Defines the procedures and features used by Bluetooth low energy HID Devices using GATT and Bluetooth HID Hosts using GATT.
Scan Parameters Profile (ScPP)	Provides devices with information to assist them in managing their connection idle timeout and advertising parameters to optimize for power consumption and/or reconnection latency.
Phone Book Access Profile (PBAP)	PBAP is a Bluetooth profile that allows the exchange of Phone Book Objects between a car kit and a mobile device to allow the car kit to display the name of the incoming caller. Allows the car kit to download the phone book so you can initiate a call from the car display.
Simple Serial Interface (SSI)	Allows for communication with Bluetooth Imager.
Dial Up Networking (DUN)	Provides a standard to access the Internet and other dial-up services over Bluetooth.
Generic Access Profile (GAP)	GAP controls connections in Bluetooth. GAP is what makes your device visible to the outside world, and determines how two devices interact with each other. Use for device discovery and authentication.
Object EXchange (OBEX)	OBEX is a communications protocol that facilitates the exchange of binary objects between devices.

Bluetooth Power States

The Bluetooth radio is off by default:

- Suspend - When the device goes into suspend mode, the Bluetooth radio stays on.
- Airplane Mode - When the device is placed in Airplane Mode, the Bluetooth radio turns off. When Airplane Mode is disabled, the Bluetooth radio returns to the prior state and is turned back on.

Bluetooth Radio Power

Turn off the Bluetooth radio to save power or if entering an area with radio restrictions, such as on an airplane. When the radio is off, other Bluetooth devices cannot see or connect to the device.

Turn on the Bluetooth radio to exchange information with other Bluetooth devices within range.





NOTE: To achieve the best battery life, turn off radios when not in use.

Enabling Bluetooth



To enable Bluetooth:

1. Swipe down from the Status bar to open the Quick Access panel.

2. Touch  to turn Bluetooth on.
3. Touch .

Disabling Bluetooth

To disable Bluetooth:

1. Swipe down from the Status bar to open the Quick Access panel.
2. Touch  to turn Bluetooth off.
3. Touch .

Discovering Bluetooth Device(s)

The device can receive information from discovered devices without pairing. However, once paired, the device and a paired device exchange information automatically when the Bluetooth radio is on. To find Bluetooth devices in the area:

1. Ensure that Bluetooth is enabled on both devices.
2. Ensure that the Bluetooth device to discover is in discoverable mode.
3. Ensure that the two devices are within 10 meters (32.8 feet) of one another.
4. Swipe down from the Status bar to open the Quick Access panel.
5. Touch the word **Bluetooth** below the Bluetooth symbol.

Figure 79 Quick Access Panel

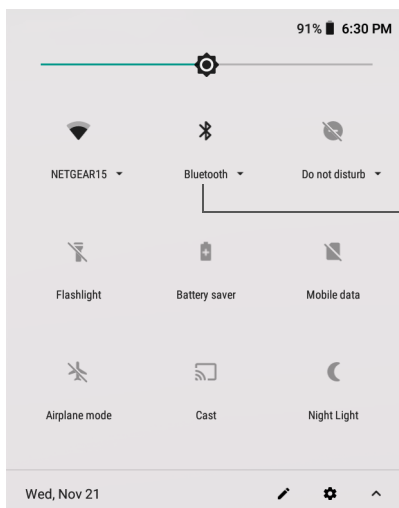

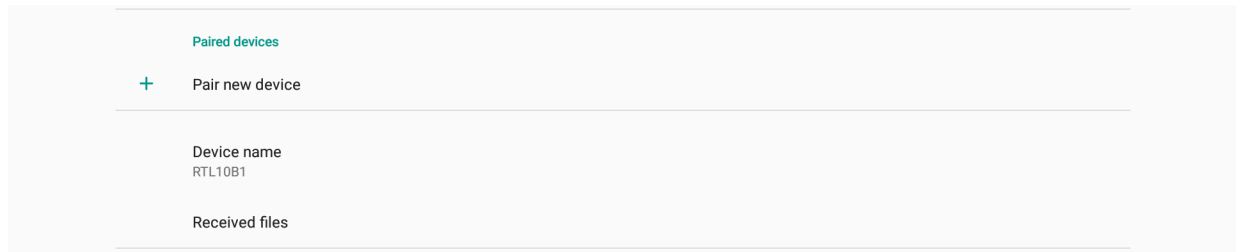

6. Touch **MORE SETTINGS**.
The **Bluetooth** screen appears.

Figure 80 Bluetooth Screen

7. Touch **Pair new device**.
The device begins searching for discoverable Bluetooth devices in the area and displays them under **Available devices**.
8. Scroll through the list and select a device.
The Bluetooth pairing request dialog box appears.
9. Touch **Pair** on both devices.
The Bluetooth device is added to the **Paired devices** list and a trusted (“paired”) connection is established.

Changing the Bluetooth Name

By default, the device has a generic Bluetooth name that is visible to other devices when connected.

1. Swipe down from the Status bar to open the Quick Access panel and then touch .
2. Touch **Connected devices > Bluetooth**.
3. If Bluetooth is not on, move the switch to turn Bluetooth on.
4. Touch **Device name**.
5. Enter a name and touch **RENAME**.
6. Touch .



Connecting to a Bluetooth Device

Once paired, connect to a Bluetooth device.

1. Swipe down from the Status bar to open the Quick Access panel and then touch .
2. Touch **Connected devices > Bluetooth**.
3. In the list, touch the unconnected Bluetooth device.
When connected, **Connected** appears below the device name.



Selecting Profiles on the Bluetooth Device

Some Bluetooth devices have multiple profiles. To select a profile:

1. Swipe down from the Status bar to open the Quick Access panel and then touch .
2. Touch **Connected devices > Bluetooth**.
3. In the **Paired devices** list, touch  next to the device name.
4. Turn on or off a profile to allow the device to use that profile.
5. Touch .

Unpairing a Bluetooth Device

To unpair a Bluetooth device and erase all pairing information:

1. Swipe down from the Status bar to open the Quick Access panel and then touch .
2. Touch **Connected devices** > **Bluetooth**.
3. In the **Paired devices** list, touch  next to the device name.
4. Touch **FORGET**.
5. Touch .

Using the NFC Reader

If your L10 tablet includes the factory-installed integrated NFC reader option, you can use it to retrieve information from RFID tags.

Data Capture

Introduction

Devices for Data Capture

The L10 supports data capture using the following devices:

- Internal scanner (XPAD model only, built-in)
- RS507x Hands-free Imager
- RS6000 Bluetooth Ring Scanner
- DS3578 Bluetooth Scanner
- DS3608 USB Scanner

Operational Modes

The imager supports two modes of operation, listed below. Activate each mode by pressing the Scan button.

- **Decode Mode:** In this mode, the scanner attempts to locate and decode enabled barcodes within its field of view. The imager remains in this mode as long as you hold the scan button, or until it decodes a barcode.



NOTE: To enable picklist mode, configure this mode in DataWedge or in an application using an API command. The picklist mode is dependent upon the scanner. Refer to the scanner user guide for more information.

- **Picklist Mode:** This mode lets you selectively decode a barcode when more than one barcode is in the scanner's field of view. To accomplish this, move the aiming crosshair or dot over the required barcode to decode only this barcode. This feature is ideal for picklists containing multiple barcodes and manufacturing or transport labels containing more than one barcode type (either 1D or 2D).

Scanning Considerations

Scanning consists of aim, scan, and decode. Scanning performance can be optimized by considering the range and the scanning angle.

Range

Any scanning device decodes well over a particular working range (minimum and maximum distances from the barcode). This range varies according to barcode density and scanning device optics.

Scanning within range brings quick and constant decodes; scanning too close or too far away prevents decodes. Move the scanner closer and further away to find the right working range for the barcodes being scanned. However, the situation is complicated by the availability of various integrated scanning modules. The best way to specify the appropriate working range per barcode density is through a chart called a decode zone for each scan module. A decode zone simply plots working range as a function of minimum element widths of barcode symbols.

Angle

The scan angle is important for optimizing decode performance. When laser beams reflect directly back into the scanner from the barcode, this specular reflection can “blind” the scanner.

To avoid this, scan the barcode so that the beam does not bounce directly back. But do not scan at too sharp an angle; the scanner needs to collect scattered reflections from the scan to make a successful decode. Practice quickly shows what tolerances to work within.



NOTE: Contact the Zebra Global Customer Support if chronic scanning difficulties develop. Decoding of properly printed barcodes should be quick and effortless.

Imaging

The imagers have the following features:

- Omnidirectional (360°) reading of a variety of barcode symbologies, including the most popular linear, postal, PDF417, and 2-D matrix code types.
- The ability to capture and download images to a host for a variety of imaging applications.
- Advanced intuitive laser aiming for easy point-and-shoot operation.

The imager uses digital camera technology to take a digital picture of a barcode, stores the resulting image in its memory, and executes state-of-the-art software decoding algorithms to extract the data from the image.

Using the Barcode Scanner (XPAD Only)

The optional XPAD L10 scanner is a factory-installed device consisting of a barcode optical image reader and hardware decoder. The SE4710 scanner is built in to the handle of the XPAD L10 tablet.

Figure 81 Barcode Scanner



1. On the tablet, open the application software that is going to receive the barcode data and put the active cursor in the appropriate field of that software.
2. Aim the scanner lens at the barcode.
3. Press and hold the Barcode Scanning button on top of the handle. Make sure that the red scan beam covers the entire barcode.



Figure 82 Barcode Scanning Button



If the scan is successful, there is a confirmation beep and the data appears in the application.

Barcode Symbolologies

The L10 barcode scanner supports several different types of barcodes—a set of barcodes are already enabled on the tablet. You can view, enable, and disable barcodes on the L10A by following these steps:

1. Swipe up from the bottom of the Home screen to display the app icons.
2. You might need to scroll through the apps to find the **DWDEMO** app.
3. Touch the **DWDEMO** icon  .
The DWDEMO screen appears.
4. Touch the three-dot icon  .
A small menu appears.
5. Touch **Settings**.
A large menu fills the screen that lets you select a scanner, configure settings, enable scanner input, and other features.
6. Scroll down to the Barcode input section and touch **Configure scanner settings**.
The Scanner configuration screen appears.
7. Touch **Decoders** to view the list of barcode decoders on the tablet.
The Decoder menu displays this list of available decoders.
The decoders that are checked are enabled. You can disable any decoder by touching the check mark. You can also enable other decoders. Keep in mind that the more decoders that are enabled, the more memory they use.

Tips for scanning barcodes include the following practices:

- You typically get the best scans if the lens is six to seven inches from the barcode.
- Make sure that the barcode fits completely inside the boundaries of the scan beam.
- If you have trouble scanning a barcode, then use two hands to steady the tablet while you scan.

RS507x Hands-Free Imager

The RS507x Hands-Free Imager is a wearable barcode scan solution for both 1D and 2D barcode symbolologies. The scanner supports Bluetooth Human Interface Device (HID) connection to the device.

Figure 83 RS507x Hands-Free Imager

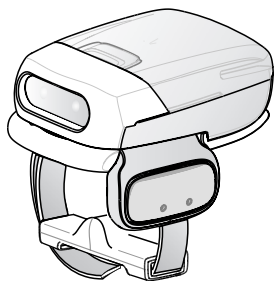

Refer to the RS507x Hands-free Imager Product Reference Guide for more information.

Barcode Capture Using the RS507x

Pair the RS507x with the L10. See [Pairing Scanners by Using Simple Serial Interface \(SSI\) on page 108](#) or [Pairing Scanners by Using Human Interface Device \(HID\) on page 109](#) for more information.

1. Ensure that an application is open on the device and a text field is in focus (text cursor in text field).
2. Point the RS507x at a barcode.

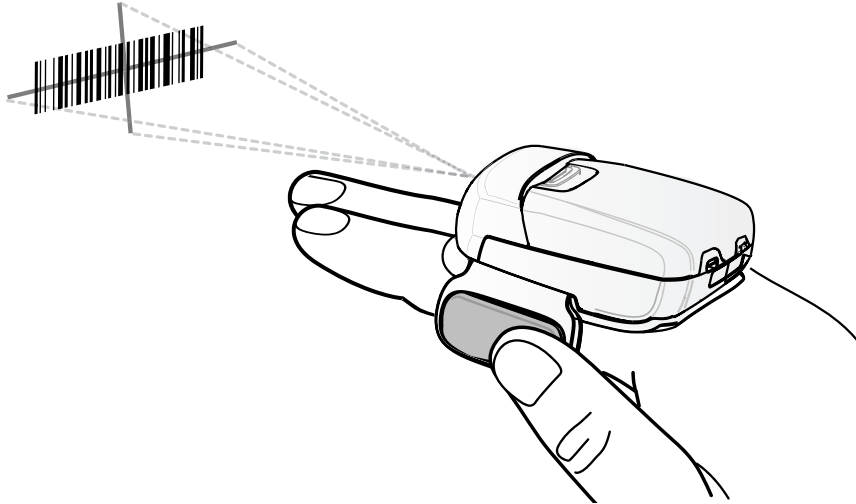

3. Press and hold the trigger.

The red laser aiming pattern turns on to assist in aiming. Ensure the barcode is within the area formed by the cross-hairs in the aiming pattern. The aiming dot is used for increased visibility in bright lighting conditions.

The RS507x LEDs light green, a beep sounds to indicate the barcode was decoded successfully. Note that when the RS507x is in Picklist Mode, the RS507x does not decode the barcode until the center of the crosshair touches the barcode.

Figure 84 Aiming Pattern



Figure 85 Picklist Mode with Multiple Barcodes in Aiming Pattern

The captured data appears in the text field.

Barcode Capture with the RS6000 Bluetooth Hands-free Scanner

This hands-free scanner is also called a ring scanner.

To read a barcode, a scan-enabled application is required. The tablet contains the **DataWedge** application that lets you enable the scanner to decode barcode data and display the barcode content. See [DataWedge Demonstration on page 55](#) for more information on launching DataWedge.

1. Pair the RS6000 scanner with the tablet.
See [Pairing Scanners by Using Simple Serial Interface \(SSI\) on page 108](#) or [Pairing Scanners by Using Human Interface Device \(HID\) on page 109](#) for more information.
2. Ensure that an application is open on the device and a text field is in focus (text cursor in text field).
3. Point the RS6000 at a barcode.

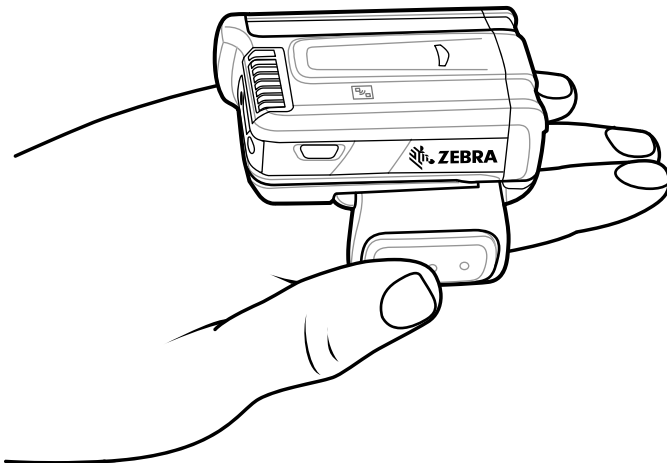
Figure 86 Barcode Scanning with RS6000

4. Press and hold the trigger.

The red laser aiming pattern turns on to assist in aiming. Ensure that the barcode is within the area formed by the cross-hairs in the aiming pattern. The aiming dot is used for increased visibility in bright lighting conditions.

The RS6000 LEDs light green, and a beep sounds to indicate that the barcode was decoded successfully.

Note that when the RS6000 is in picklist mode, the RS6000 does not decode the barcode until the center of the crosshair touches the barcode.

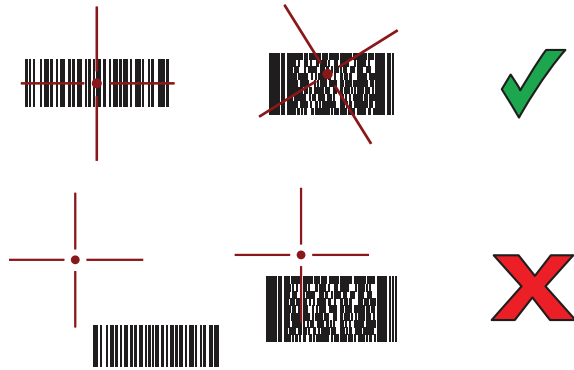
Figure 87 Aiming Pattern**Figure 88** Picklist Mode with Multiple Barcodes in Aiming Pattern

The captured data appears in the text field.

Barcode Capture with Zebra Scanner

To capture barcode data:

1. Ensure that an application is open on the device and a text field is in focus (text cursor in text field).
2. Point the scanner at a barcode.

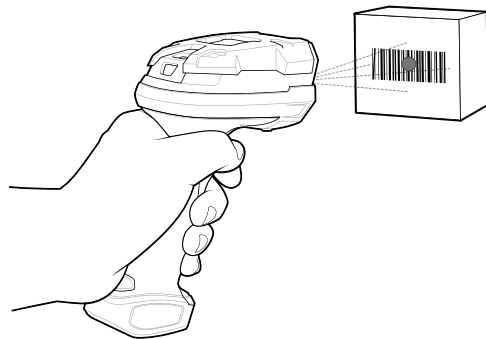
Figure 89 Barcode Scanning (DS3678-SR shown)

3. Press and hold the trigger.

Ensure the barcode is within the area formed by the aiming pattern. The aiming dot is used for increased visibility in bright lighting conditions. The aiming dot is used for increased visibility in bright lighting conditions.

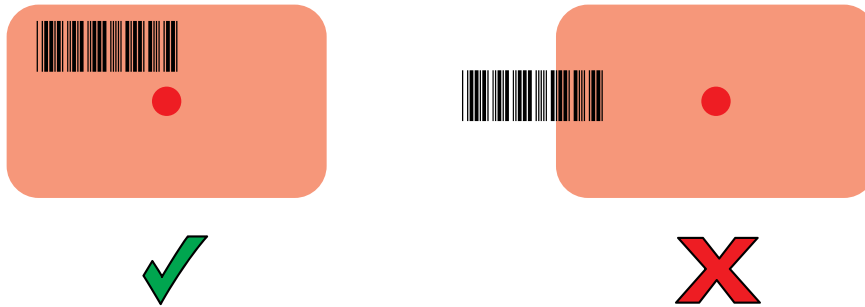
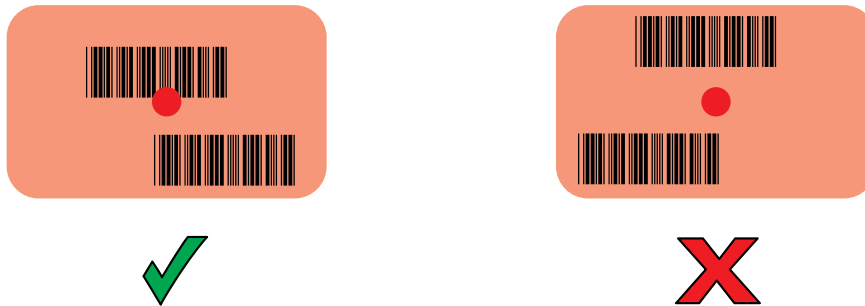
Figure 90 DS3678-SR Aiming Pattern**Figure 91** DS3678-SR Picklist Mode with Multiple Barcodes in Aiming Pattern

The captured data appears in the text field.

Connecting a USB Scanner

To connect a USB scanner, use one of the following methods:

- Simple Serial Interface (SSI) mode
- Human Interface Device (HID) mode.

Connecting Using Simple Serial Interface



IMPORTANT: Make sure that DS3608 scanner has firmware version CAACJS00-004-R00D0.DAT or higher.

To connect a USB scanner using SSI mode:

1. On the side of the tablet, open the access door.
2. Connect the scanner cable USB connector to either USB port. The scanner beeps.
3. Ensure that the scanner is in SSI mode. Refer to the scanner Product Reference Guide and scan the SSI Over USB CDC barcode.
4. On the tablet home screen, swipe up from the bottom of the Home screen and touch the **DataWedge** app .
5. Select a profile.
6. Configure additional settings.

Connecting Using HID Mode

To connect a USB scanner using HID mode:

1. On the side of the tablet, open the access door.
2. Connect the scanner cable USB connector to either USB port. The scanner beeps.
3. Ensure that the scanner is in HID mode. Refer to the Product Reference Guide and scan the HID Keyboard barcode or perform a factory reset.

Pairing the RS507x/RS6000 Hands-Free Scanners

To connect an RS507x/RS6000 hands-free scanner to the tablet, use one of the following methods:

- Simple Serial Interface (SSI) mode
- Bluetooth Human Interface Device (HID) mode

Pairing Scanners by Using Simple Serial Interface (SSI)

To pair the RS507x/RS6000 with the tablet using SSI:





1. Ensure that the scanner is in SSI mode. If the RS507x/RS6000 is already in SSI mode, skip to step 2.
 - a. Remove the battery from the RS507x/RS6000 scanner.
 - b. Press and hold the **Restore** key.
 - c. Install the battery onto the RS507x/RS6000.
 - d. Keep holding the **Restore** key for about five seconds until a chirp is heard and the Scan LEDs flash green.
2. Ensure that the two devices are within 10 meters (32.8 feet) of one another.
3. Install the battery onto the scanner.
4. On the L10, touch the **Home** button. 
5. On the tablet, swipe up from the bottom of the Home screen and touch the Bluetooth Pairing Utility  .

Figure 92 Bluetooth Pairing Utility

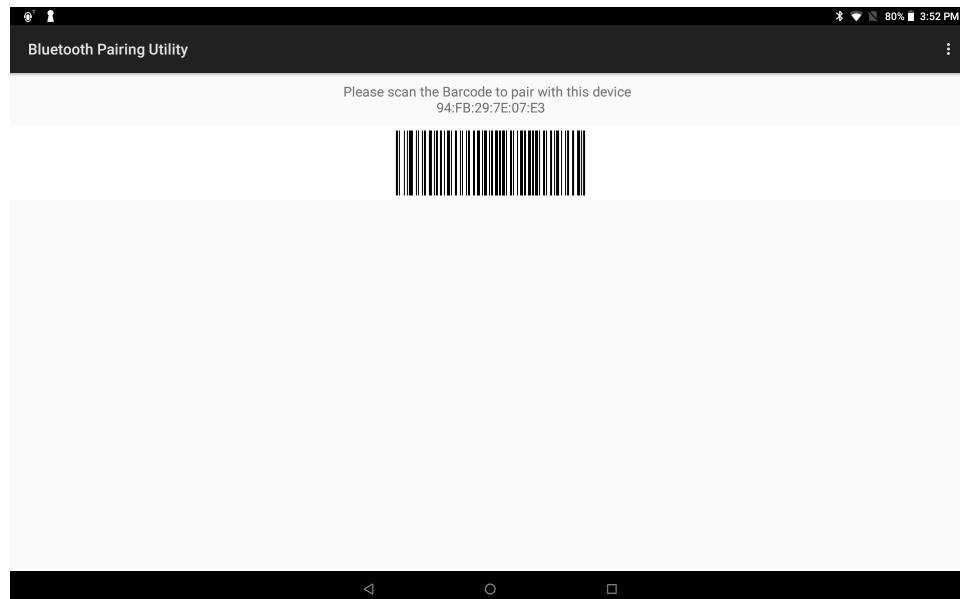

- Using the RS507x/RS6000, scan the barcode on the screen.

The RS507x emits a high/low/high/low beeps. The Scan LED flashes green indicating that the RS507x is attempting to establish connection with the tablet. When connection is established, the Scan LED turns off and the RS507x emits one string of low/high beeps.

- On the L10, touch .

Pairing Scanners by Using Human Interface Device (HID)

To pair the RS507x/RS6000 with the tablet using HID:

- Place the RS507x/RS6000 in Human Interface Device (HID) mode.
If the scanner is already in HID mode, skip to step 2.
 - Remove the battery from the RS507x/RS6000.
 - Press and hold the **Restore** key.
 - Install the battery onto the RS507x/RS6000.
 - Keep holding the **Restore** key for about five seconds until a chirp is heard and the Scan LEDs flash green.
 - Scan the barcode below to place the RS507x/RS6000 in HID mode.

Figure 93 RS507x Bluetooth HID Barcode



Figure 94 RS6000 Bluetooth HID Barcode



- Remove the battery from the RS507x/RS6000.
- Re-install the battery onto the RS507x/RS6000.
- Ensure that the two devices are within 10 meters (32.8 feet) of one another.
- Swipe down from the status bar and then touch .
- Touch **Connected devices**.
- Touch **Bluetooth**.
- If Bluetooth is Off, then touch the button to turn Bluetooth **On**.
- Touch **+ Pair new device**.

The device begins searching for discoverable Bluetooth devices in the area and displays them under Available devices.

- Scroll through the list and select the scanner.

The RS507x/RS6000 connects to the tablet and **Connected** appears below the device name. The Bluetooth device is added to the **Paired devices** list and a trusted (“paired”) connection is established.

Pairing a DS3678 Scanner

To connect an DS3678 scanner to the tablet, use one of the following methods:

- Simple Serial Interface (SSI) mode
- Bluetooth Human Interface Device (HID) mode.

Pairing a DS3678 Scanner Using Simple Serial Interface (SSI)

To pair the DS3678 scanner with the tablet using SSI:



1. Ensure that the scanner is in SSI mode.
2. Ensure that the two devices are within 10 meters (32.8 feet) of one another.
3. On the tablet, swipe up from the bottom of the Home screen and touch the Bluetooth Pairing Utility .

Figure 95 Bluetooth Pairing Utility

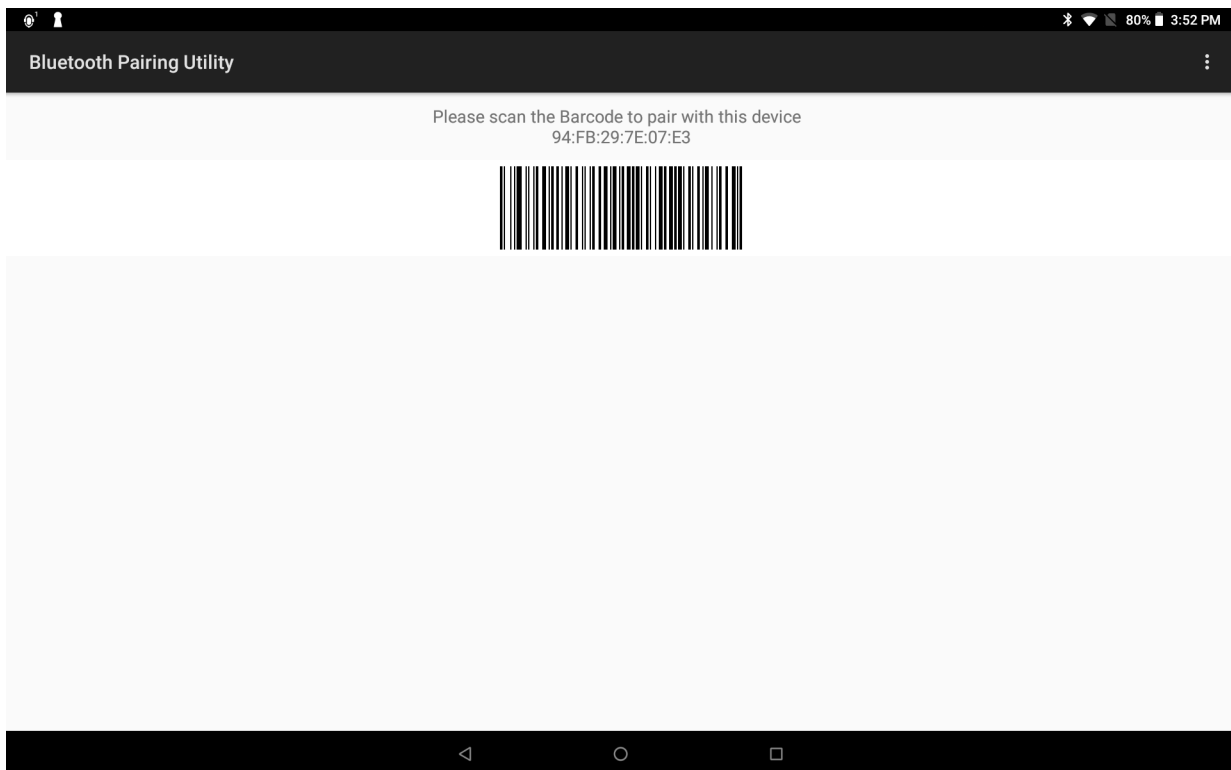

4. Use the scanner to scan the barcode on the screen.
The scanner emits a high/low/high/low beeps. The Scan LED flashes green indicating that the scanner is attempting to establish connection with the tablet. When connection is established, the Scan LED turns off and the scanner emits one string of low/high beeps.
5. On the tablet, touch .

Pairing a DS3678 Scanner Using Human Interface Device (HID)

To pair the scanner with the tablet using HID:

1. Ensure that the scanner is in HID mode.
Refer to the DS36X8 Product Reference Guide and scan the HID Keyboard barcode.
2. Ensure that the two devices are within 10 meters (32.8 feet) of one another.
3. Swipe down from the status bar and then touch .
4. Touch **Connected devices**.
5. Touch **Bluetooth**.
6. If Bluetooth is Off, then touch the button to turn Bluetooth **On**.
7. Touch **+ Pair new device**.

The device begins searching for discoverable Bluetooth devices in the area and displays them under **Available devices**.

8. Scroll through the list and select the scanner.



The device connects to the scanner and **Connected** appears below the device name. The Bluetooth device is added to the **Paired devices** list and a trusted (“paired”) connection is established.

DataWedge



DataWedge is a utility that adds advanced barcode scanning capability to any application without writing code. It runs in the background and handles the interface to built-in barcode scanners. The captured barcode data is converted to keystrokes and sent to the target application as if it was typed on the keypad.

To configure DataWedge go to: techdocs.zebra.com/datawedge.

Enabling DataWedge

1. Swipe up from the bottom of the Home screen and touch the DataWedge icon .
2. Touch .
3. Touch **Settings**.
4. Touch the **DataWedge enabled** checkbox.
A check mark appears in the checkbox indicating that DataWedge is enabled.
5. Touch .

Disabling DataWedge

1. Swipe up from the bottom of the Home screen and touch .
2. Touch the  icon.
3. Touch **Settings**.
4. Touch the **DataWedge enabled** checkbox.
The check mark disappears from the checkbox indicating that DataWedge is disabled.
5. Touch .

Accessories

Introduction

The L10 accessories provide a variety of product support capabilities. This table lists the available accessories. You can also access accessories at zebra.com/support.

Table 24 L10A Accessories

Accessory	Part Number	Description
Docking Solutions		
L10 Vehicle Dock–Cradle	300142 (L10 Vehicle Dock–Cradle, xDIM, CLA) 300144 (L10 Vehicle Dock–Cradle, RF Pass Through, xDIM, CLA)	The L10 Vehicle Dock protects and secures the L10 tablet under heavy shock and vibration. <ul style="list-style-type: none"> • Holds tablet in place under extreme vibration and stress • Barrel-style keylock to lock tablet into place for secure vehicle docking. Easy one-hand release allows grab-and-go” transitions between vehicle, field, and office. • Resistant to water and dust
xDIM G3 Docking Interface Module	300140 (xDIM Module G3, Cigarette Lighter Adapter)	Built for demanding environments. The xDIM G3 docking interface module provides power and connectivity to the vehicle dock and the tablet.
L10 Industrial Dock	300149 (L10 Industrial Dock, NA PWR) 300150 (L10 Industrial Dock, ANZ PWR) 300151 (L10 Industrial Dock, EU PWR)	The Industrial Dock combines the L10 Vehicle Cradle and a sturdy desk stand to hold your Zebra rugged tablet in place. Perfect for touch applications in the plant, warehouse, or office. The dock provides power to the tablet and has two USB ports for expanded connectivity. Add an optional 4K port replicator to gain four USB 3.0 and 2 USB 2.0 ports, DVI, DisplayPort or HDMI, Gigabit Ethernet, microphone in, Stereo speaker out, and security lock slot. <ul style="list-style-type: none"> • Sturdy industrial dock holds the rugged tablet in place while protecting it against drops and other tough usage • Includes xDIM G3 Docking Interface Module, which provides power to the tablet, and two USB ports for attaching a keyboard or other peripherals. • 4K port replicator sold separately

Table 24 L10A Accessories (Continued)

Accessory	Part Number	Description
L10 Industrial Dock	300149 (L10 Industrial Dock, NA PWR) 300150 (L10 Industrial Dock, ANZ PWR) 300151 (L10 Industrial Dock, EU PWR)	4K Port Replicator Front Panel: <ul style="list-style-type: none"> Two <i>always-on</i> USB 2.0 ports (sleep & charge) 3.5mm line-in (microphone/headset) 3.5mm line-out (headphone/headset/speakers) power light USB status light Back Panel: Four USB 3.0 ports RJ-45 10/100/1000 Ethernet Video-out: HDMI (up to 2048x1152) or DisplayPort, DVI-1 (up to 2048x1280), VGA 3 x 3.5mm line-out (5.1 surround sound speakers) DC power in Security lock slot
Power		
L10 Standard Battery: 36 Whr	450148	This battery can be charged while in the rugged tablet or while in the battery charging slot in the docking station. The power meter reports the available battery life. The hot-swappable battery capability allows you to swap the battery without shutting down the tablet. <ul style="list-style-type: none"> This lithium-ion battery has 36 Whr capacity and can power the tablet up to 10 hours (Mobilemark 14). The external LED indicates the approximate remaining battery life. The battery is hot-swappable, so you can change the battery without having to power down the tablet.
L10 Extended Life Battery: 98 Whr	450149	The extended life battery is ideal for working in the field for long periods of time, or for rugged tablets used around the clock for shift work. It powers L10 rugged tablets up to 27 hours on a single charge. This battery attaches to the tablet using the battery bracket kickstand. Large 98 Whr lithium-ion battery keeps the tablet powered for up to 27 hours. The external LED indicates the remaining battery life. It is hot swappable. Requires battery bracket kickstand. Its dimensions are contained within the kickstand; kickstand increases thickness by 0.78 in (0.2cm).
L10 Kickstand and Extended Battery Bracket	410056 (kit)	The kickstand holds your Zebra L10 rugged tablet upright for easy reading and touch while in the field and when using the companion keyboard. When you are ready work while walking, the kickstand folds away. An integrated battery bracket holds the extended battery for up to 27 hours of battery life. You do not need to remove the kickstand and bracket when docking in the Vehicle, office, or industrial docks. It can also be used in combination with the optional soft handle and stylus pen accessory set. Compatible with extended battery and companion keyboard.

Table 24 L10A Accessories (Continued)

Accessory	Part Number	Description
L10 Single Bay Battery Charger	450150 (L10 Battery Charger with AC Adapter, US) 450170 (L10 Battery Charger with AC Adapter, AU) 450171 (L10 Battery Charger with AC Adapter, EU) 450172 (L10 Battery Charger with AC Adapter, UK)	Provides maximum power and uptime for your Zebra L10 rugged tablet. This charger keeps your battery powered for maximum performance and industrial use. <ul style="list-style-type: none"> • Can be integrated into the office dock or used as a standalone charger. • Charges either Standard 36 Whr or Extended Life 98 Whr • Standard battery charge time: 2.75 Hrs; extended battery charge time: 3.25 Hrs • Includes power adapter • LED Indicator light for charging status
L10 Power Adapter	450159 (Adapter, US PWR) 450160 (Adapter, ANZ PWR) 450161 (Adapter, EU PWR)	A second AC power adapter lets you keep one adapter in a different location without carrying one with you.
Input Devices		
L10 Back-lit Rugged IP65 Companion Keyboard Available in these languages: <ul style="list-style-type: none"> • US English • UK English • German • French • Spanish 	420095 (Companion Keyboard, US) 420096 (Companion Keyboard, UK) 420097 (Companion Keyboard, DE) 420098 (Companion Keyboard, FR) 420099 (Companion Keyboard, ES)	This keyboard provides a full-travel tactile feedback feel and is spill-resistant. The touch pad supports two-finger and three-finger gestures. This keyboard offers a 2-in-1 laptop/tablet experience for the mobility of a tablet and a notebook-style support for data-intensive tasks. <ul style="list-style-type: none"> • The keyboard is easily removable when docked. • There is no need to charge it, because it is powered by the tablet. • The keyboard closes to cover the display glass for added protection.
Long Active Pen	Pen: 440036 Stylus tip kit: 440042	This active digitizer pen provides precision for writing and annotating on your Zebra L10 tablet. This active digitizer pen provides a range of pressure sensitivity, tilt detection, and hover capability. Hover lets you see where the pen is pointing before the tip touches the display. The attached tether keeps the pen and rugged tablet together. The digitizer pen stores easily in the integrated garage of the XPAD L10 or the soft handle garage of the XSLATE L10 and XBOOK L10.

Table 24 L10A Accessories (Continued)

Accessory	Part Number	Description
Short Active Pen	Pen: 440037 Stylus tip kit: 440042	This compact, active digitizer pen offers precision and comfort when you need to write and annotate on your L10 tablet. This active digitizer pen provides a range of pressure sensitivity, tilt detection, and hover capability. Hover lets you see where the pen is pointing before the tip touches the display. The attached tether keeps the pen and tablet together to prevent loss.
Long Capacitive ePen	440043	This capacitive pen is battery powered and has a 1.5 mm tip that provides pinpoint accuracy for easy writing and annotation on your tablet. It enables pressure sensitivity. This pen fits in the handle of your XPAD L10 tablet. One AAAA battery is included.
Short Capacitive Pen	440007	This compact capacitive pen provides accuracy for easy writing and annotation on your tablet. This pen fits in the handle of your XPAD L10 tablet.
Input Devices: Optional Modules		
Serial, RS232 (optional module) Note: Must be ordered at the time of tablet purchase. (factory installed)		This module adds true serial capability to your Zebra L10 rugged tablet. It connects from the multifunction port to your legacy serial equipment using a DB9 adapter. This module requires a mounting bracket, which is included with the Extended Battery Kickstand or KickStrap.
UHF RFID Reader (AEI) (optional module) Note: Must be ordered at the time of tablet purchase. (factory installed)		The UHF RFID Reader is a mobile solution designed specifically for Zebra L10 rugged tablets. This solution delivers the mobility and productivity of a hand-held RFID Reader device with the flexibility and functionality of a powerful computer. The UHF RFID (AEI) reader meets safe distance requirements for rail while adding mobility advantages over fixed readers.
Carrying Accessories		
L10 KickStrap	410055 (L10 KickStrap kit)	This combined <i>kickstand</i> and <i>rotating hand strap</i> provides working comfort for all Zebra L10 rugged tablet models in the field and at a desk. The kickstand closes tightly when you are on the move, and it provides great ergonomics when the tablet is on flat surfaces or when the companion keyboard is attached.

Accessories

Table 24 L10A Accessories (Continued)

Accessory	Part Number	Description
L10 Kickstand	410056	<p>The kickstand holds your Zebra L10 rugged tablet upright when in the field and when using the companion keyboard. The kickstand folds away when you are on the move.</p> <p>You do not need to remove the kickstand/bracket when docking in the vehicle, office, or industrial docks. You can also use it in combination with the soft handle and stylus pen accessory set.</p> <p>An integrated battery bracket holds the extended battery for up to 27 hours of battery life.</p> <p>It can also be used in combination with the optional Soft Handle and Stylus pen accessory set.</p> <ul style="list-style-type: none"> • Holds tablet upright for tablet interactions and for using the companion keyboard. Compatible with all L10 docks. • Easily stored away while on the move. • Excludes standard on-board stylus. • Compatible with top handle and top handle stylus accessory options.
L10 Soft Handle	<p>410052 (L10 Soft Handle w/Coiled tether, without Pen)</p> <p>410061 (L10 Soft Handle Kit – Active Stylus)</p> <p>410062 (L10 Soft Handle Kit – ePen)</p>	<p>This handle is available separately. This integrated handle attaches to the top of the tablet, allowing you to carry the tablet easily. The soft handle is made with smooth durable rubber, for a comfortable grip. The handle has a storage slot for either of the long L10 pens. A detachable shoulder strap attaches to the handle for carrying long distances and freeing your hands.</p>
L10 Shoulder Strap	410057	<p>The shoulder strap attaches to the optional top handle. It is ideal for handsfree, long-distance carrying, and is adjustable for height. The wide strap attaches and detaches with clips.</p> <ul style="list-style-type: none"> • It increases your comfort and endurance while standing and walking. • It frees up both hands while carrying the tablet. <p>Length: Adjustable to a maximum length of 4.1 ft (1.28 m)</p>

Table 24 L10A Accessories (Continued)

Accessory	Part Number	Description
L10 Carry Case	410059 (L10 Carry Case - XPAD) 410058 (L10 Carry Case - XSLATE)	This is a professional-grade carrying case designed specifically for your L10 tablet. The integrated handle and optional attachable shoulder strap provide a variety of carrying options. Provides convenient storage for digitizer pens. The carry case lets you work in the field and access the tablet while standing or walking, even when you keep it in the case. Professional Quality <ul style="list-style-type: none"> • Integrated handle for enhanced portability • Lightweight • Support for attachable shoulder strap (sold separately) • Digitizer pen holders (2) for easy storage • Easy access to power button, both cameras and ports
Display Maintenance		
L10 Screen Protector (3 pack)	Contact Zebra for product availability	The L10 Shatter-Resistant Screen Protector Film is an anti-glare, thin protective film with a coating that reduces reflections and gives a clear, sharp display even in brightly-lit conditions. The screen protector works with touch screen and digitizer pen displays to offer additional protection against everyday scratches. Available in a 3-pack for replacement of originally-installed screen protector.
Screen Cleaning Cloth	400000	Keeps your display clean with an approved wiping cloth. These cloths are especially designed to remove dirt and skin oils without damaging the display surface.

Settings

Introduction

This chapter describes settings available for configuring the device.

Setting the Date and Time

You are only required to set the time zone or set the date and time the wireless LAN does not support Network Time Protocol (NTP).

To set the date and time:

1. Swipe down from the Status bar to open the Quick Settings bar and then touch .
2. Touch **System > Date & time**.
3. Touch **Automatic date & time** to disable automatic date and time synchronization.
4. Touch **Update Interval**.
5. Select the interval time to synchronize your device time from the network.
6. Touch **Set date**.
7. In the calendar, set today's date.
8. Touch **OK**.
9. Touch **Set time**.
10. Touch the green circle, drag to the current hour and then release.
11. Touch the green circle, drag to the current minute and then release.
12. Touch **AM** or **PM**.
13. Touch **OK**.
14. Touch **Select time zone**.
15. Select the current time zone from the list.
16. Touch **Use 24-hour format**.
17. Touch

Display Setting

Use Display settings to change the screen brightness, change the background image, enable screen rotation, set sleep time and change font size.

Setting the Screen Brightness

To manually set the screen brightness:

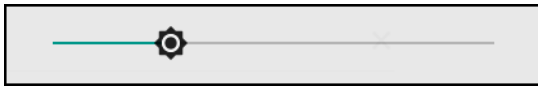

1. Swipe down with two fingers from the status bar to open the quick access panel.
2. Slide the brightness icon to adjust the screen brightness level.

Figure 96 Brightness Slider



Setting Screen Timeout

To set the screen sleep time:

1. Swipe down from the Status bar to open the Quick Settings bar and then touch .
2. Touch **Display > Advanced > Sleep**.
3. Select one of the sleep values.
 - 15 seconds
 - 30 seconds
 - 1 minute (default)
 - 2 minutes
 - 5 minutes
 - 10 minutes
 - 30 minutes
4. Touch .

Setting Font Size

To set the size of the font in system apps:

1. Swipe down from the Status bar to open the Quick Settings panel and then touch .
2. Touch **Display > Advanced**.
3. Touch **Font size**.

A sample text is displayed and a line you can use to change the font size

Figure 97 Font Size Settings

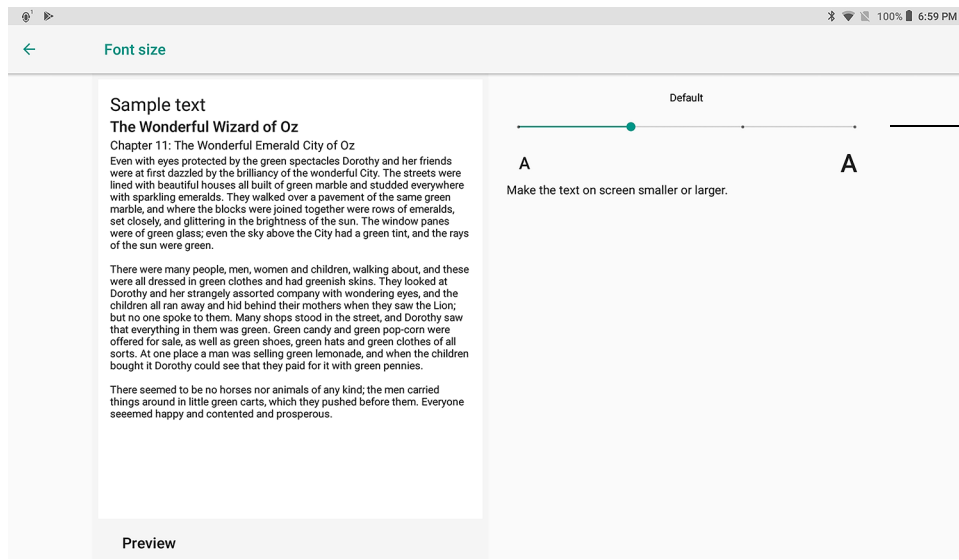

Touch or slide your finger along this line.

4. Select one of the font size values by touching the line on the right.
 - Small
 - Default
 - Large
 - Largest.
5. Touch .

Setting Screen Rotation

By default, screen rotation is enabled.

To disable screen rotation:

1. Swipe down from the Status bar to open the Quick Settings bar and then touch .
2. Touch **Display > Advanced**.
3. Touch **Auto-rotate screen**.



NOTE: To change the Home screen rotation, see Setting Home Screen Rotation.

4. Touch .

General Sound Setting

Use the **Sound** settings to configure media and alarm volumes.

To access sound settings:



1. Swipe down from the Status bar to open the Quick Settings bar and then touch .
2. Touch **Sound**.
3. Touch an option to set sounds.

Figure 98 Sound Screen

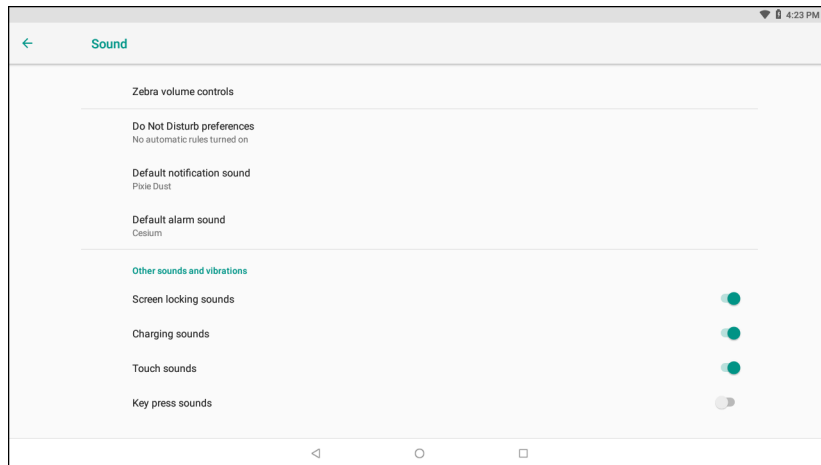

- **Zebra volume controls**
 - **Ring volume** - Controls the ringtone volume.
 - **Media volume** - Controls the music, games, and media volume.
 - **Alarm volume** - Controls the alarm clock volume.
 - **Notifications volume** - Controls the notification volume.
 - **Scanner volume** - Controls the scanner volume.
 - **Volume presets**
 -  - Mutes the ring, notifications, and scanner so that the device does not make sounds.
 -  - Enables all sounds at the user defined levels.
- **Do Not Disturb preferences** - Mutes some or all sounds and vibrations.
 - **Priority only allows** - Use to set the priorities for the following:
 - **Reminders** - Switch on or off.
 - **Events** - Switch on or off.
 - **Alarms** - This is always enabled.
 - **Messages** - Choose to allow messages from anyone, starred contacts, any contact, or none. To star contacts, use the Contacts app.
 - **Repeat callers** - Choose whether or not the phone rings if the same person calls again within 15 minutes.
 - **Block visual disturbances**
 - **Block when screen is on** - This option prevents notifications from displaying over the screen (peeking) while you are actively using the device.
 - **Block when screen is off** - This option prevents notifications from turning on the screen or pulsing the LED light when a new notification is received while you are not using the device.
 - **Automatic rules** - Choose when to automatically silence the device. Touch a default rule, such as Weekend or Weeknight, or create your own rule. To create your own rule, tap **Add more** and then **Time rule**.
- **Advanced** - Touch to display advanced sound options.
 - **Default notification sound** - Touch to select a sound to play for all system notifications.
 - **Default alarm sound** - Touch to select a sound to play for alarms.
 - **Other sounds and vibrations**

- **Screen locking sounds** - Play a sound when locking and unlocking the screen (default – enabled).
- **Charging sounds** - Not applicable.
- **Touch sounds** - Play a sound when making screen selections (default – enabled).
- **Key press sounds** - Play a sound when making keyboard button selections (default – disabled).

Setting Screen Lock

Use the **Device security** settings to set preferences for locking the screen.

1. Swipe down from the Status bar to open the Quick Access panel and then touch .
2. Touch **Security & location**.



NOTE: Options vary depending upon the policy of some apps, such as email.

- **Screen lock** - Touch to configure the device to require a slide, pattern, PIN, or password to unlock the screen.
 - **None** - Disable screen unlock security.
 - **Swipe** - Slide the lock icon to unlock the screen.
 - **Pattern** - Draw a pattern to unlock screen. See [Setting Screen Unlock Using a Pattern on page 124](#) for more information.
 - **PIN** - Enter a numeric PIN to unlock screen. See [Setting Screen Lock Using PIN on page 122](#) for more information.
 - **Password** - Enter a password to unlock screen. See [Setting Screen Unlock Using Password on page 123](#) for more information.

Lock the screen to protect access to data on the device. Some email accounts require locking the screen. The Locking feature functions differently in Single-user versus Multiple-user mode.

When locked, a slide, pattern, PIN, or password is required to unlock the device. Press the **Power** button to lock the screen. The device also locks after a predefined time-out.

- Press and release the **Power** button to wake the device. The Lock screen displays.
- Slide the screen up to unlock. If the Pattern screen unlock feature is enabled, the Pattern screen appears instead of the Lock screen.
- If the PIN or Password screen unlock feature is enabled, enter the PIN or password after unlocking the screen.

Setting Screen Lock Using PIN

1. Swipe down from the Status bar to open the Quick Access panel and then touch .
2. Touch **Security & location**.
3. Touch **Screen lock**.
4. Touch **PIN**.

- To require a PIN upon device start up, select **Yes**; or select **No** not to require a PIN.

Figure 99 PIN Screen

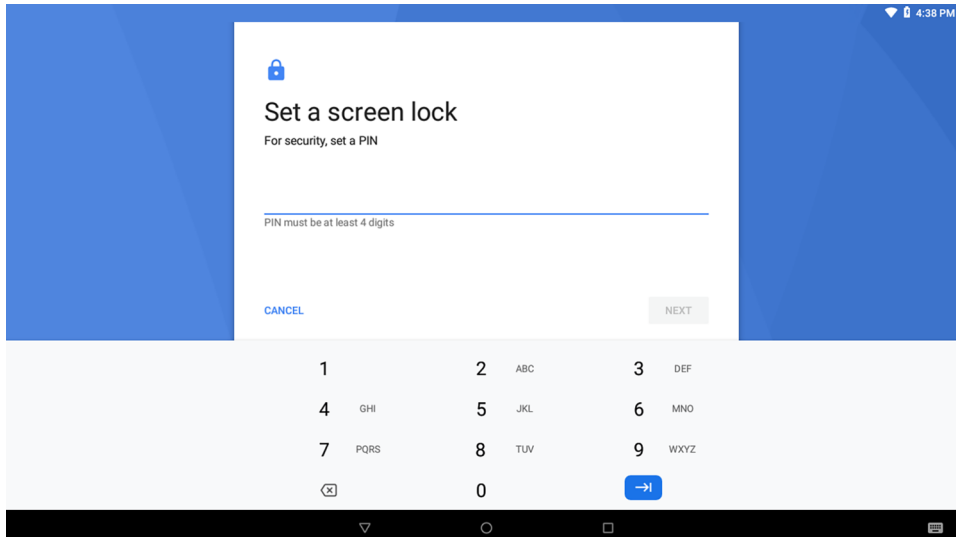

- Touch in the text field.
- Enter a PIN (4 numbers) then touch **Next**.
- Enter the PIN again and touch **Next**.
- Select the type of notifications that appear when the screen is locked and then touch **Done**.
- Touch .

The next time the device goes into suspend mode a PIN is required upon waking.

Setting Screen Unlock Using Password

- Swipe down from the Status bar to open the Quick Access panel and then touch .
- Touch **Security & location**.
- Touch **Screen lock**.
- Touch **Password**.
- To require a password upon device start up, select **Yes**; or select **No** not to require a password.
- Touch in the text field.

7. Enter a password (between 4 and 16 characters) then touch **Next**.

Figure 100 Password Screen

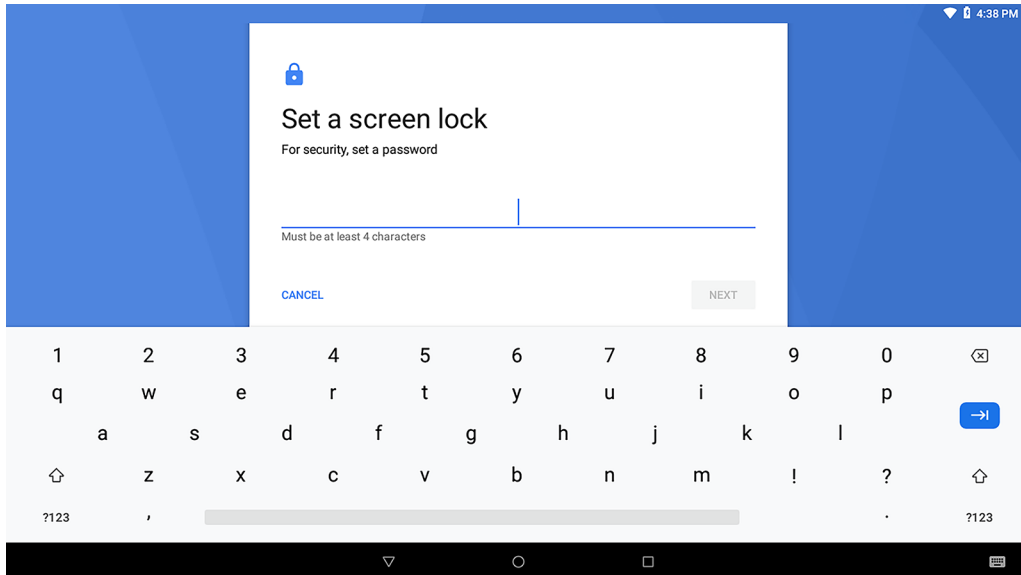

8. Enter the password again and touch **Next**.
9. Select the type of notifications that appear when the screen is locked and then touch **Done**.
10. Touch .

The next time the device goes into suspend mode, a password is required upon waking.

Setting Screen Unlock Using a Pattern

1. Swipe down from the Status bar to open the Quick Access panel and then touch .
2. Touch **Security & location**.
3. Touch **Screen lock**.
4. Touch **Pattern**.
5. To require a pattern upon device start up, select **Yes**; or select **No** not to require a pattern.

Figure 101 Choose Your Pattern Screen

6. Draw a pattern connecting at least four dots.
7. Touch **Continue**.
8. Re-draw the pattern.
9. Touch **Confirm**.
10. Select the type of notifications that appear when the screen is locked and then touch **Done**.
11. Touch . The next time the device goes into suspend mode a pattern is required upon waking.

Passwords

To set the device to briefly show password characters as the user types:

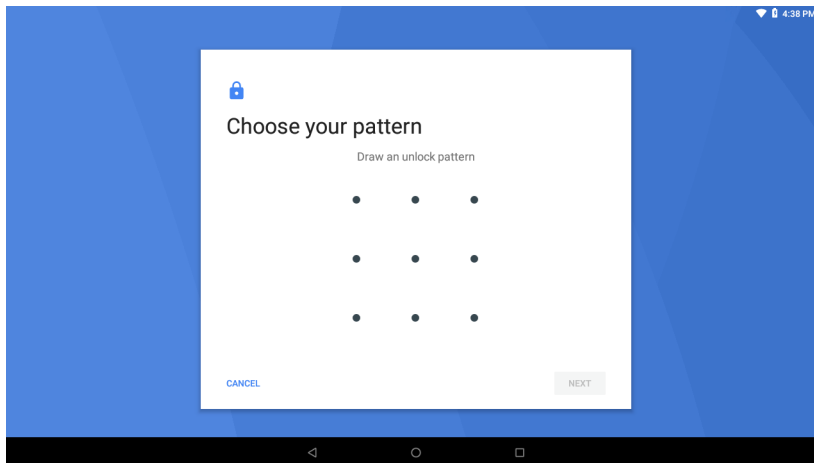
1. Swipe down from the status bar and then touch **⚙️ > Security & location**.
2. Slide the **Show passwords** switch to the **ON** position.



System Language Usage

Use the **Language & input** settings to change the language that display for the text and including words added to its dictionary.





Adding Languages

1. Swipe down from the status bar and then touch **⚙️**.
2. Touch **System > Language & input**.
3. Touch **Languages**.
4. Touch **Add a language**.
5. Scroll through the list and touch a language.
The language appears in the language list.
6. Touch **←**.



Selecting a Language

1. Swipe down from the status bar and then touch .
2. Touch **System > Language & input**.
3. Touch **Languages**.
4. Touch and drag a language to the top of the list.
5. Touch . The operating system text changes to the selected language.
6. Touch .

Removing a Language

1. Swipe down from the status bar and then touch .
2. Touch **System > Language & input**.
3. Touch **Languages**.
4. Touch .
5. Touch **Remove**.
6. Select the languages to remove.
7. Touch .
8. Touch **OK**.
9. Touch .

Adding Words to the Dictionary

1. Swipe down from the status bar and then touch .
2. Touch **System > Language & input**.
3. Touch **Advanced > Personal dictionary**.
4. If prompted, select the language that this word or phrase is stored.
5. Touch **+** to add a new word or phrase to the dictionary.
6. Enter the word or phrase.
7. In the **Shortcut** text box, enter a shortcut for the word or phrase.
8. Touch .

Virtual Keyboard Settings



Use the **Language & input** settings for configuring the on-screen virtual keyboards.

Enterprise Keyboard Configuration

Upon initial boot-up of the device, the **Enterprise Keyboard** app appears in the All Apps window. Run the app to enable and configure the Enterprise keyboard. After configuration, the app disappears from the All Apps windows.

Enabling Keyboards

To enable the installed virtual keyboard:

1. Swipe down from the status bar and then touch .
2. Touch **System > Language & input**.
3. Touch **Virtual keyboard**.
4. Touch **Manage keyboards**.
5. Touch one or more of the keyboard input method switches.
6. Touch **OK**.
7. Touch .

Configuring the Gboard Keyboard

GBoard is a virtual keyboard app developed by Google for Android and iOS devices.

To configure the GBoard keyboard:

1. Touch and hold (comma) > . The **Preferences** screen appears.
2. Select **Languages** to change the language layout of the keyboard.

By default, the keyboard uses the default system languages. To override the system languages:

 - a. Touch **Use system languages** to disable the default setting.
 - b. Scroll through the list and select languages for the keyboard.
 - c. Touch .

Configuring the Enterprise Keyboard

To configure the Enterprise keyboard:

1. Touch the **Settings** icon .
2. Touch **System > Languages & input**.
3. Touch **Virtual keyboard > + Manage keyboards >**
4. Touch **Enterprise keyboard**.

Key Programmer

The device's buttons can be programmed to perform different functions or shortcuts to installed applications.

- Home - Home button.
- LEFT_TRIGGER_1 - P1 button on XPAD.
- RIGHT_TRIGGER_1 - P2 button on XPAD.
- MINUS - Screen Rotate button.
- SCAN - Scan button on top of XPAD.
- VOLUME_DOWN - Volume down button.
- VOLUME_UP - Volume up button.

Remapping a Button

1. Swipe down from the status bar and then touch .
2. Touch **Key Programmer**.

Figure 102 Key Programmer Screen



3. Select the button to remap.
4. Touch the **BUTTON REMAPPING**, or **SHORTCUT** tab that lists the available functions and applications.
5. Touch a function or application shortcut to map to the button.

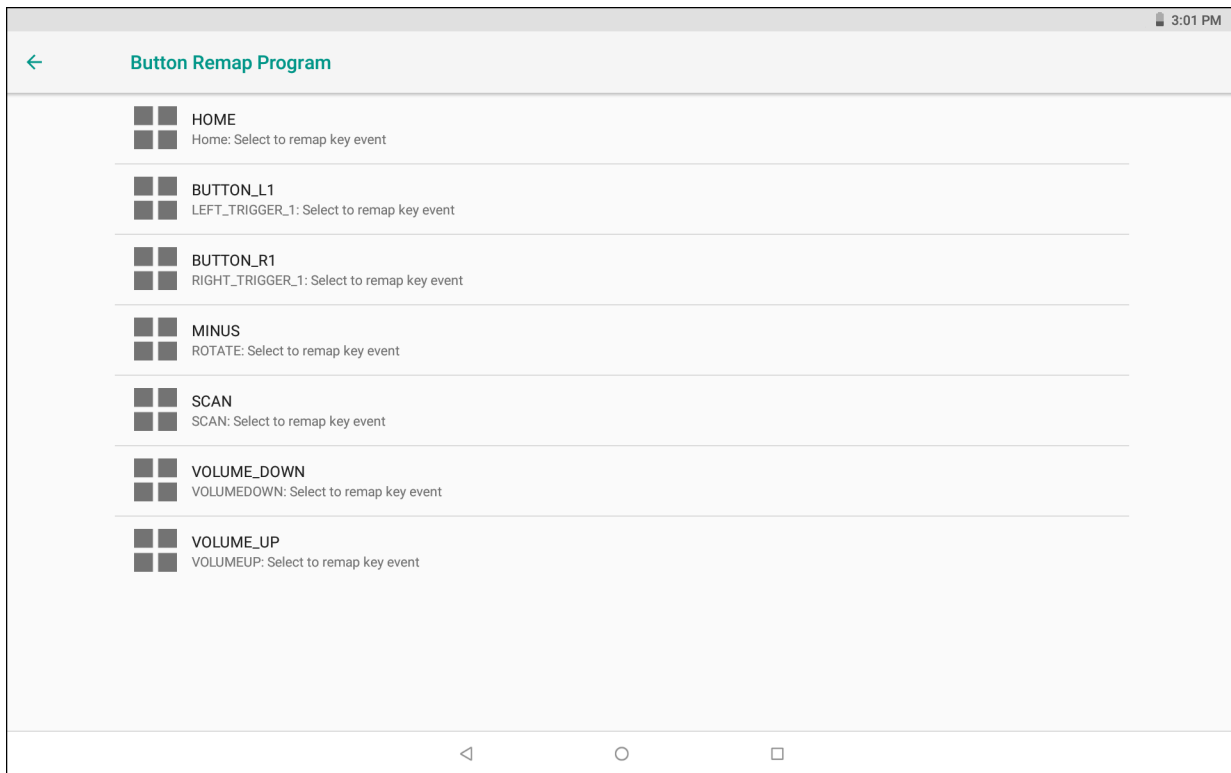

NOTE: If you select an application shortcut, the application icon appears next to the button on the Key Programmer screen.

Figure 103 Remapped Button

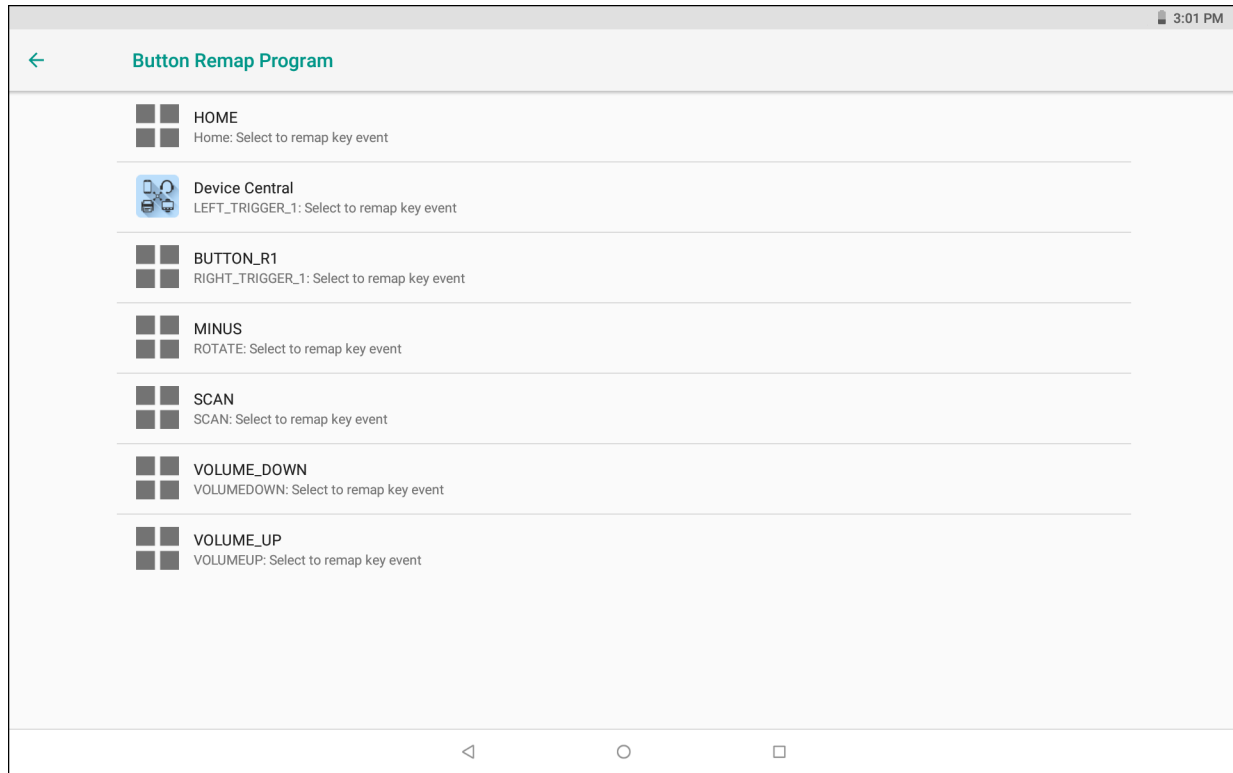

6. Touch ○.

About Phone

Use About phone settings to view information about the device. Swipe down with two fingers from the status bar to open the quick access panel and then touch **⚙️ > System > About phone**.

Application Deployment

Introduction

This chapter describes Android features for including new security features, how to package applications, and procedures for deploying applications onto the device.

Security

The device implements a set of security policies that determine whether an application is allowed to run and, if allowed, with what level of trust. To develop an application, you must know the security configuration of the device, and how to sign an application with the appropriate certificate to allow the application to run (and to run with the needed level of trust).



NOTE: Ensure the date is set correctly before installing certificates or when accessing secure web sites.

Secure Certificates

If the VPN or Wi-Fi networks rely on secure certificates, obtain the certificates and store them in the secure credential storage on the tablet, before configuring access to the VPN or Wi-Fi networks.

If downloading the certificates from a web site, set a password for the credential storage. The device supports X.509 certificates saved in PKCS#12 key store files with a .p12 extension (if key store has a .pfx or other extension, change to .p12).

The device also installs any accompanying private key or certificate authority certificates contained in the key store.

Installing a Secure Certificate

To install a secure certificate:

1. Copy the certificate from the host computer to the root of the USB drive or the device's internal memory. See [Transferring Files with USB on page 48](#) for information about connecting the device to a host computer and copying files.
2. Swipe down from the Status bar to open the Quick Access panel and then touch .
3. Touch **Security & location > Advanced > Encryption & credentials**.

4. Touch **Install from storage**.
5. Navigate to the location of the certificate file.
6. Touch the filename of the certificate to install.
7. If prompted, enter the password for credential storage. If a password has not been set for the credential storage, enter a password for it twice and then touch **OK**.
8. If prompted, enter the certificate's password and touch **OK**.
9. Enter a name for the certificate and in the Credential use drop-down, select **VPN and apps** or **Wi-Fi**.

Figure 104 Name the Certificate Dialog Box

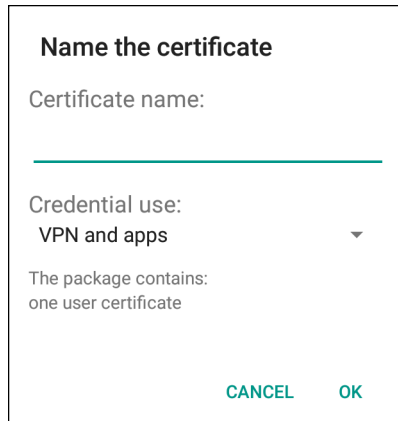

10. Touch **OK**.

The certificate can now be used when connecting to a secure network. For security, the certificate is deleted from the USB drive or internal memory.

Configuring Credential Storage Settings

1. Swipe down from the Status bar to open the Quick Access panel and then touch **⚙**.
2. Touch **Security**.
 - **Trusted credentials** - Touch to display the trusted system and user credentials.
 - **Install from storage** - Touch to install a secure certificate from the USB drive or internal storage.
 - **Clear credentials** - Deletes all secure certificates and related credentials.

Development Tools

Android

Android development tools are available at developer.android.com.

To start developing applications for the device, download the development SDK and the Android Studio IDE. Development can take place on a Microsoft® Windows®, Mac® OS X®, or Linux® operating system.

Applications are written in the Java language, but compiled and executed in the Dalvik VM (a non-Java virtual machine). Once the Java code is compiled cleanly, the developer tools make sure the application is packaged properly, including the AndroidManifest.xml file.

The development SDK is distributed as a ZIP file that unpacks to a directory on the host computer hard drive. The SDK includes:

- android.jar
 - Java archive file containing all of the development SDK classes necessary to build an application.
- documentation.html and docs directory
 - The SDK documentation is provided locally and on the Web. It's largely in the form of JavaDocs, making it easy to navigate the many packages in the SDK. The documentation also includes a high-level Development Guide and links to the broader community.
- Samples directory
 - The samples subdirectory contains full source code for a variety of applications, including ApiDemo, which exercises many APIs. The sample application is a great place to explore when starting application development.
- Tools directory
 - Contains all of the command-line tools to build applications. The most commonly employed and useful tool is the adb utility.
- usb_driver
 - Directory containing the necessary drivers to connect the development environment to an enabled device. These files are only required for developers using the Windows platform.

Opening Developer Options

By default, the Developer Options are hidden. In this procedure, you set development related settings.

1. To reveal the developer options, swipe down from the Status bar to open the Quick Access panel and then touch .
2. Touch **System > About phone**.
3. Scroll down to **Build number**. Tap **Build number** seven times until **You are now a developer appears**.
4. Touch **System > Developer options**.
5. Slide the switch to the **ON** position to enable developer options.

Enterprise Mobility Developer Kit for Android

The Enterprise Mobility Developer Kit (EMDK) for Android provides developers with a comprehensive set of tools to easily create powerful line-of-business applications for enterprise mobile computing devices. It's designed for Google's Android SDK and Android Studio, and includes class libraries, sample applications with source code, and all associated documentation to help your applications take full advantage of what Zebra devices have to offer.

The kit also delivers Profile Manager, a GUI-based device configuration tool providing exclusive access to the Zebra MX device management framework. This allows developers to configure Zebra devices from within their applications in less time, with fewer lines of code and with fewer errors.

For more information go to: techdocs.zebra.com.

StageNow

StageNow is Zebra's next-generation Android Staging Solution built on the MX platform. It allows quick and easy creation of device profiles, and can deploy to devices simply by scanning a bar code, reading a tag, or playing an audio file.

The StageNow Staging Solution includes the following components:

- The StageNow Workstation tool installs on the staging workstation (host computer) and lets the administrator easily create staging profiles for configuring device components, and perform other staging actions such as checking the condition of a target device to determine suitability for software upgrades or other activities. The StageNow Workstation stores profiles and other created content for later use.
- The StageNow Client resides on the device and provides a user interface for the staging operator to initiate staging. The operator uses one or more of the desired staging methods (print and scan a bar code, read an NFC tag or play an audio file) to deliver staging material to the device.

For more information refer to techdocs.zebra.com.

GMS Restricted

GMS Restricted mode deactivates Google Mobile Services (GMS). All GMS apps are disabled on the device and communication with Google (analytics data collection and location services) is disabled.

Use StageNow to disable or enable GMS Restricted mode. After a device is in GMS Restricted mode, enable and disable individual GMS apps and services using StageNow. To ensure GMS Restricted mode persists after an Enterprise Reset, use the Persist Manager option in StageNow. For more information on StageNow, refer to techdocs.zebra.com.



ADB USB Setup

To use the Android Debug Bridge (ADB), install the USB driver. This assumes that the development SDK has been installed on the host computer. Go to developer.android.com/sdk/index.html for details on setting up the development SDK.

ADB driver for Windows and Linux are available on the Zebra Support Central web site at zebra.com/support. Download the ADB and USB Driver Setup package. Following the instructions with the package to install the ADB and USB drivers for Windows and Linux.

Enabling USB Debugging

By default, USB debugging is disabled. To enable USB debugging:

1. Swipe down from the Status bar to open the Quick Access panel and then touch .
2. Touch **System** > **About phone**.
3. Scroll down to **Build number**.
4. Tap **Build number** seven times. The message **You are now a developer!** appears.
5. Touch .
6. Touch **Developer options**.
7. Slide the **USB debugging** switch to the **ON** position.
8. Touch **OK**.
9. Connect the device to the host computer.
The **Allow USB debugging?** dialog box appears on the device.
10. On the device, touch **OK**.
11. On the host computer, navigate to the `platform-tools` folder.
12. Type `adb devices`.

The following displays:

List of devices attached

XXXXXXXXXXXXXXXXX device (where XXXXXXXXXXXXXXXXXXXX is the device number).



NOTE: If device number does not appear, ensure that ADB drivers are installed properly.

13. Touch .

Application Installation

After an application is developed, install the application onto the device using one of the following methods:

- Android Debug Bridge, see [Installing Applications Using the Android Debug Bridge](#).
- microSD Card, see [Installing Applications Using a microSD Card](#).
- Mobile device management (MDM) platforms that have application provisioning. Refer to the MDM software documentation for details.

Installing Applications Using a microSD Card



CAUTION: When connecting the device to a host computer and mounting its microSD card, follow the host computer's instructions for connecting and disconnecting USB devices to avoid damaging or corrupting files.

1. Connect the device to a host computer using a USB cable.
2. Copy the application APK file from the host computer to the microSD card.
3. Remove the microSD card from the host computer.
4. Press and hold the Power button until the menu appears.
5. Touch **Power off**.



6. Open the access door.
7. Insert the microSD card.
8. Close the access door.
9. Press and hold the Power button to turn on the device.
10. Swipe the screen up and select  to view files on the microSD card.
11. Touch  > **SD card**.
12. Locate the application .apk file.
13. Touch the application file.

Figure 105 Install App Permission Dialog Box



14. Touch **Continue** to install the app, or **Cancel** to stop the installation.

Figure 106 Accept Installation Screen

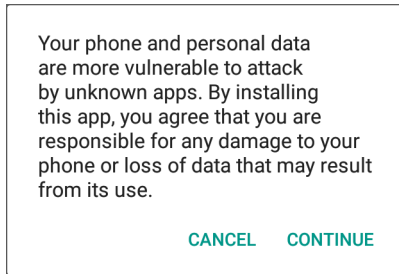
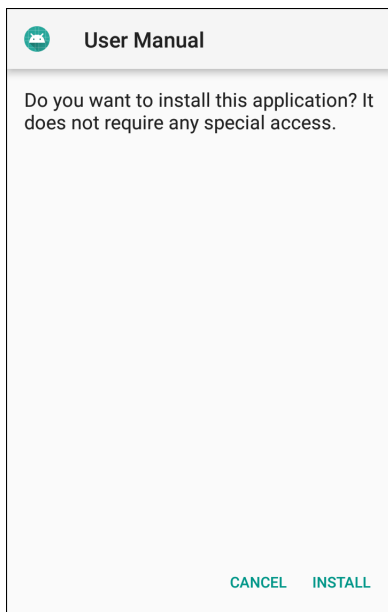

15. To confirm installation and accept what the application affects, touch **Install** otherwise touch **Cancel**.
16. Touch **Open** to open the application or **Done** to exit the installation process.
The application appears in the App list.

Installing Applications Using the Android Debug Bridge (ADB)

Use the Android Debug Bridge (ADB) commands to install applications on the tablet.



CAUTION: When connecting the device to a host computer and mounting its microSD card, follow the host computer's instructions for connecting and disconnecting USB devices, to avoid damaging or corrupting files.

Ensure that the ADB drivers are installed on the host computer. See [ADB USB Setup on page 133](#).

1. Connect the device to a host computer using a USB cable.
2. Swipe down from the Status bar to open the Quick Access panel and then touch .
3. Touch **System > Developer options**.
4. Slide the switch to the **ON** position.
5. Touch **USB Debugging**. A check appears in the check box. The **Allow USB debugging?** dialog box appears.
6. Touch **OK**.
7. On the host computer, open a command prompt window and use the adb command:
`adb install <application>`
 where: <application> = the path and filename of the apk file.
8. Disconnect the device from the host computer. See [Transferring Files with USB on page 48](#)

Uninstalling an Application

To uninstall an application:

1. Swipe down from the Status bar to open the Quick Access panel and then touch .
2. Touch **Apps & notifications**.
3. Touch **See all apps** to view all apps in the list.
4. Scroll through the list to the app.
5. Touch the app.
 The **App info** screen appears.

Figure 107 App Info Screen



6. Touch **Uninstall**.
7. Touch **OK** to confirm.

Performing a System Update

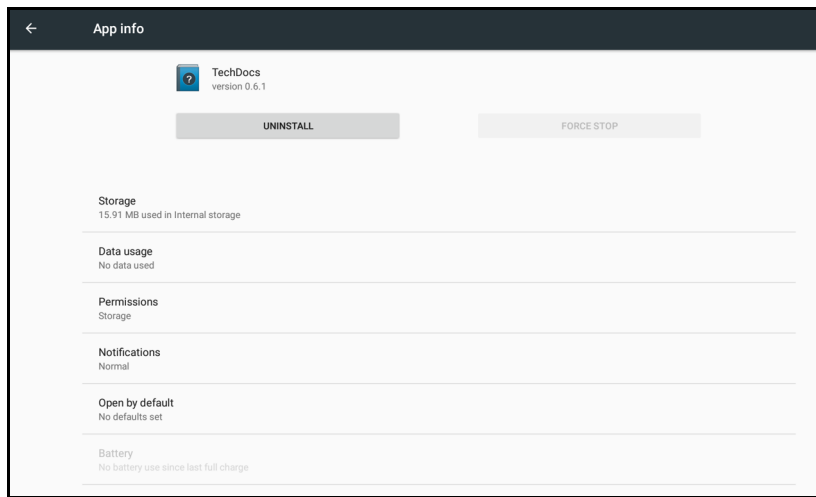
System Update packages can contain either partial or complete updates for the operating system. Zebra distributes the System Update packages on the Zebra Support & Downloads web site. Perform system update using either a microSD card or using ADB.

Downloading the System Update Package

To download the system update package:

1. Go to the Zebra Support & Downloads web site, zebra.com/support.
2. Download the appropriate System Update package to a host computer.

Using the microSD Card

Prior to using the microSD card, it is strongly recommended that you format the microSD card on the device.

1. Copy the System Update zip file to the root of the microSD card.
 - Copy the zip file to a microSD card using a host computer (See [Transferring Files with USB on page 48](#) for more information), and then installing the microSD card into the device. See [Inserting a microSD Card on page 38](#).
 - Connect the device with a microSD card already installed to the host computer, and copy zip file to the microSD card. See [Transferring Files with USB on page 48](#) for more information. Disconnect the device from the host computer.
2. Press and hold the **Power** button until the menu appears.
3. Touch **Restart**.
The device resets.
4. Press and hold the **Rotate Screen** button until the Recovery Screen appears.
5. Press the Up and Down buttons to navigate to **apply from sdcard**.
6. Press the **Volume Up** and **Volume Down** buttons to navigate to **apply from sdcard**.
7. Press the **Enter** button.
8. Press the **Power** button.
9. Use the **Up** and **Down** buttons to navigate to the System Update file.
10. Use the **Volume Up** and **Volume Down** buttons to navigate to the System Update file.
11. Press the **Power** button.
The System Update installs and then the device returns to the Recovery screen.
12. Press the **Power** button to reboot the device.

Using ADB

1. Connect a USB cable to the device and to a host computer.
2. On the device, swipe down from the Status bar to open the Quick Access panel and then touch .
3. Touch **System > Developer options**.
4. Slide the switch to the **ON** position.

5. Touch **USB Debugging**.
A check appears in the check box.
The **Allow USB debugging?** dialog box appears.
6. Touch **OK**.
7. On the host computer, open a command prompt window and use the adb command:
`adb devices`
The following displays:
List of devices attached
XXXXXXXXXXXXXXXXX device (where XXXXXXXXXXXXXXXXXXXX is the device number).



NOTE: If device number does not appear, ensure that ADB drivers are installed properly.

8. Enter this command:
`adb reboot recovery`
The System Recovery screen appears.
9. Press the Volume Up and Volume Down buttons to navigate to **apply from adb**.
10. Press the Power button.
11. On the host computer command prompt window enter this command:
`adb sideload <file>`
where: <file> = the path and filename of the zip file.
The System Update installs (progress appears as percentage in the Command Prompt window) and then the Recovery screen appears.
12. Press the **Power** button to reboot the device.

Verifying System Update Installation

To check that the system update installed properly:

1. On the device, swipe down from the Status bar to open the Quick Access panel and then touch .
2. Touch **System > About phone**.
3. Scroll down to **Build number**.
4. Ensure that the build number matches the new system update package file number.

Performing an Enterprise Reset

An Enterprise Reset erases all user data in the `/data` partition, including data in the primary storage locations (`/sdcard` and emulated storage).

Before performing an Enterprise Reset, provision (backup) all necessary configuration files and restore them after the reset.

Perform Enterprise Reset using microSD card or using ADB.

Downloading the Enterprise Reset Package

To download the system update package:

1. Go to the Zebra Support & Downloads web site, zebra.com/support.
2. Download the Enterprise Reset file to a host computer.

Using a microSD Card

It is strongly recommended that prior to use, you must format the microSD card on the device.

1. Copy the Enterprise Reset zip file to the root of the microSD card.
See [Transferring Files with USB on page 48](#) for more information.
 - Copy the zip file to a microSD card using a host computer.
 - Install the microSD card into the device.
 - Connect the device with a microSD card already installed to the host computer and copy zip file to the microSD card.
 - Disconnect the device from the host computer.
2. Press and hold the **Power** button until the menu appears.
3. Touch **Restart**.
4. Touch **OK**. The device resets.
5. Press and hold the Rotate Screen button until the System Recovery screen appears.
6. Press the **Up** and **Down** buttons to navigate to **apply from sdcard**.
7. Press the **Volume Up** and **Volume Down** buttons to navigate to **apply from sdcard**.
8. Press the **Enter** button.
9. Press the **Power** button.
10. Use the Volume Up and Volume Down buttons to navigate to the Enterprise Reset file.
11. Press the **Power** button. The Enterprise Reset occurs and then the device returns to the Recovery screen.
12. Press the **Power** button.

Using ADB

To perform an Enterprise Reset using ADB:

1. Connect a USB cable to the device and to a host computer.
2. On the device, swipe down from the Status bar to open the Quick Access panel and then touch .
3. Touch **System > Developer options**.
4. Slide the switch to the **ON** position.
5. Touch **USB Debugging**.
A check appears in the check box. The **Allow USB debugging?** dialog box appears.
6. Touch **OK**.
7. On the host computer, open a command prompt window and enter:
adb devices.

The following displays:

List of devices attached

XXXXXXXXXXXXXXXXX device (where XXXXXXXXXXXXXXXXXXXX is the device number).



NOTE: If device number does not appear, ensure that ADB drivers are installed properly.

8. Enter this command:
`adb reboot recovery`
9. Press Enter. The System Recovery screen appears.
10. Press the Volume Up and Volume Down buttons to navigate to **apply from adb**.
11. Press the Power button.
12. On the host computer command prompt window type:
`adb sideload <file>`
where: <file> = the path and filename of the zip file.
13. Press **Enter**. The Enterprise Reset package installs and then the Recovery screen appears.
14. Press the Power button to reboot the device.

Performing a Factory Reset

A Factory Reset erases all data in the `/data` and `/enterprise` partitions in internal storage and clears all device settings. A Factory Reset returns the device to the last installed operating system image. To revert to a previous operating system version, re-install that operating system image. See [Performing a System Update on page 137](#) for more information.

Downloading the Factory Reset Package

To download the Factory Reset package:

1. Go to the Zebra Support & Downloads web site, zebra.com/support.
2. Download the appropriate Factory Reset file to a host computer.

Using a microSD Card

1. Copy the Factory Reset zip file to the root of the microSD card.
See [Transferring Files with USB on page 48](#) for more information.
 - Copy the zip file to a microSD card using a host computer and then installing the microSD card into the device. See [Inserting a microSD Card on page 38](#) for more information.
 - Connect the device with a microSD card already installed to the host computer and copy zip file to the microSD card.
 - Disconnect the device from the host computer.
2. Press and hold the Power button until the menu appears.
3. Touch **Restart**.
The device resets.
4. Press and hold the Rotate Screen button until the System Recovery screen appears.
5. Press the Up and Down buttons to navigate to **apply from sdcard**.
6. Press the Volume Up and Volume Down buttons to navigate to **apply from sdcard**.
7. Press the **Enter** button.
8. Press the Power button.
9. Use the Up and Down buttons to navigate to the Factory Reset file.

10. Use the Volume Up and Volume Down buttons to navigate to the Factory Reset file.
11. Press the Power button. The Factory Reset occurs and then the device returns to the Recovery screen.
12. Press the Power button.

Using ADB

To perform an Factory Reset using ADB:

1. Connect a USB cable to the device and to a host computer.
2. On the device, swipe down from the Status bar to open the Quick Access panel and then touch .
3. Touch **System > Developer options**.
4. Slide the switch to the **ON** position.
5. Touch **USB Debugging**. A check appears in the check box. The **Allow USB debugging?** dialog box appears.
6. Touch **OK**.
7. On the host computer, open a command prompt window.
8. Enter the adb command:

```
adb reboot recovery
```

The System Recovery screen appears.

9. Press the Volume Up and Volume Down buttons to navigate to **apply from adb**.
10. Press the Power button.
11. On the host computer, open a command prompt window and use the adb command:

```
adb devices.
```

The following displays:

```
List of devices attached
```

```
XXXXXXXXXXXXXXXXX device (where XXXXXXXXXXXXXXXXXXXX is the device number).
```



NOTE: If device number does not appear, ensure that ADB drivers are installed properly.

12. Enter this command:

```
adb reboot recovery
```

The System Recovery screen appears.
13. Press the **Up** and **Down** buttons to navigate to **apply from adb**.
14. Press the **Power** button.
15. On the host computer command prompt window enter:

```
adb sideload <file>
```

where: <file> = the path and filename of the zip file.
This command installs the Factory Reset package and the Recovery screen appears.
16. Press the **Power** button to reboot the device.

Storage

The tablet contains four types of file storage:

- Random Access Memory (RAM)

- Internal storage
- External storage (USB drive)
- Enterprise folder.

Random Access Memory

Executing programs use RAM to store data. Data stored in RAM is lost upon a reset. The operating system manages how applications use RAM. It only allows applications and component processes and services to use RAM when required. It may cache recently used processes in RAM, so they restart more quickly when opened again, but it will erase the cache if it needs the RAM for new activities.

1. To view the amount of free and used memory, swipe down from the Status bar to open the Quick Access panel and then touch .
2. Touch **System > Developer options > Memory**.

Figure 108 Memory Screen



The screen displays the amount of used and free RAM.

- **Performance** - Indicates memory performance.
- **Total memory** - Indicates the total amount of RAM available.
- **Average used (%)** - Indicates the average amount of memory (as a percentage) used during the period of time selected (default - 3 hours).
- **Free** - Indicates the total amount of unused RAM.
- **Memory used by apps** - Touch to view RAM usage by individual apps.

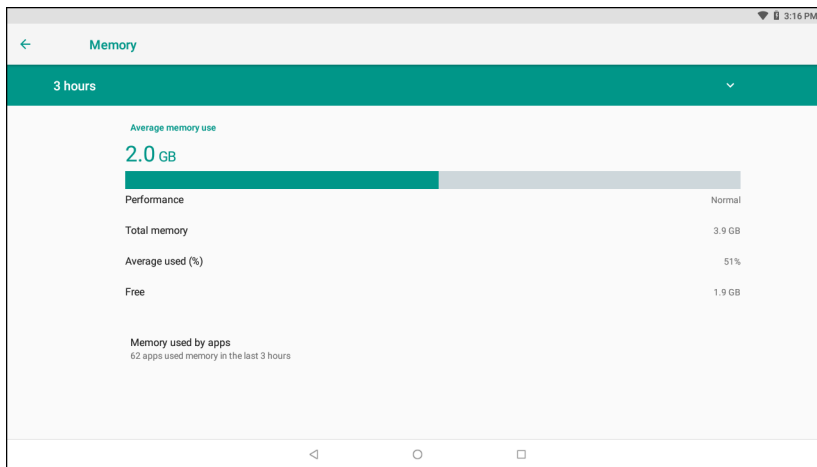
Internal Storage

The device has internal storage. The internal storage content can be viewed and files copied to and from when the device is connected to a host computer. Some applications are designed to be stored on the internal storage rather than in internal memory.

To view the used and available space on the internal storage:

1. Swipe down from the Status bar to open the Quick Access panel and then touch .

2. Touch **Storage**.

Figure 109 Storage Screen

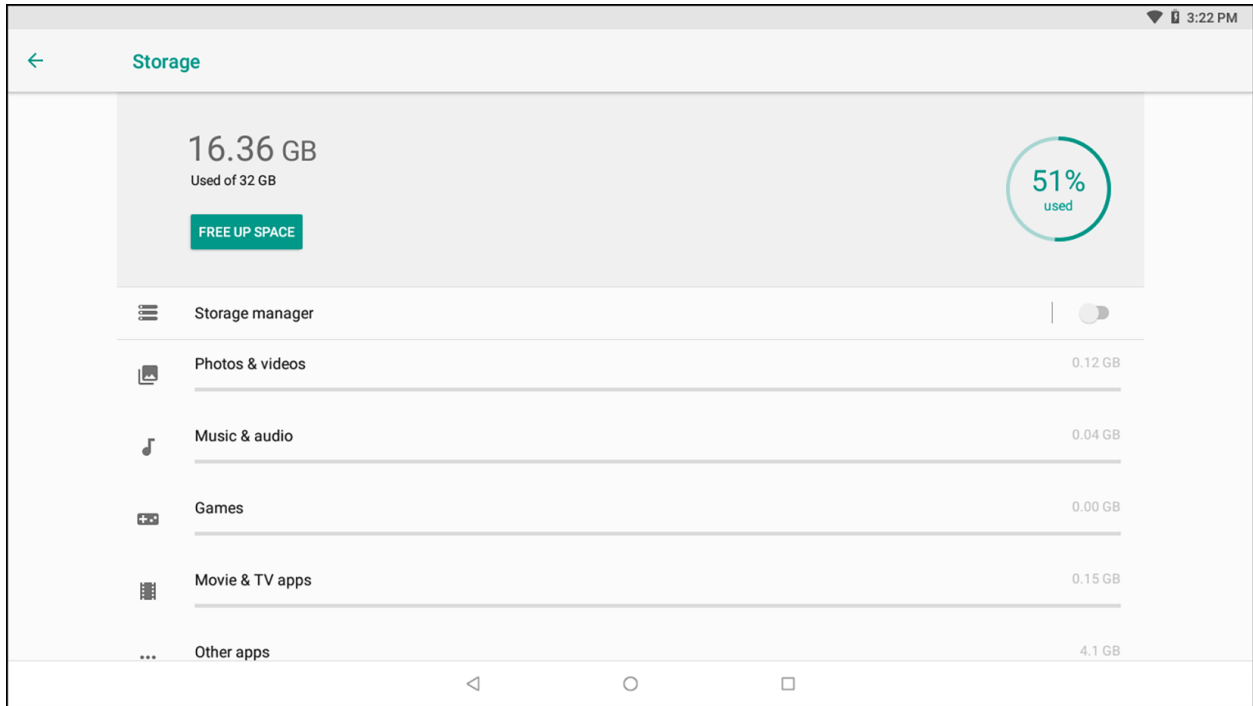

The screen displays the total amount of space on internal storage and amount used as well as the amount of storage used by apps, photos, videos, audio and other files.

External Storage

The tablet can have a removable microSD card. The microSD card content can be viewed and files copied to and from when the device is connected to a host computer.

To view the used and available space on the microSD card:



1. Swipe down from the Status bar to open the Quick Access panel and then touch .
2. Touch **Storage**.

Figure 110 External Storage Screen

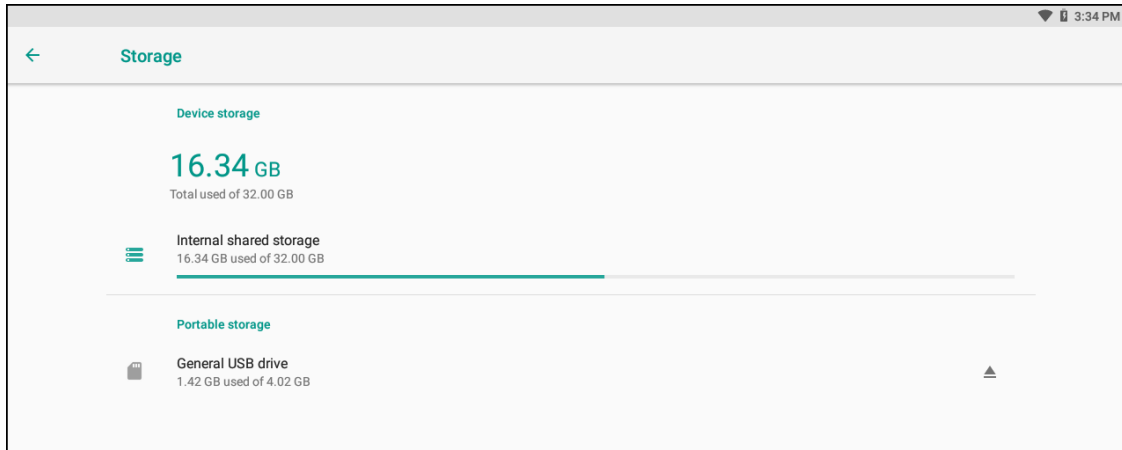

Portable storage displays the total amount of space on the installed microSD card and the amount used.

3. To unmount the USB drive, touch .
4. Touch **General USB Drive** to view the contents of the card.

Formatting a microSD Card

To format an installed microSD card as portable storage:

1. Touch **General USB Drive**.
2. Touch  > **Storage Settings**.

Figure 111 USB Drive Settings Screen



3. Touch **Format**.

Figure 112 Format Screen

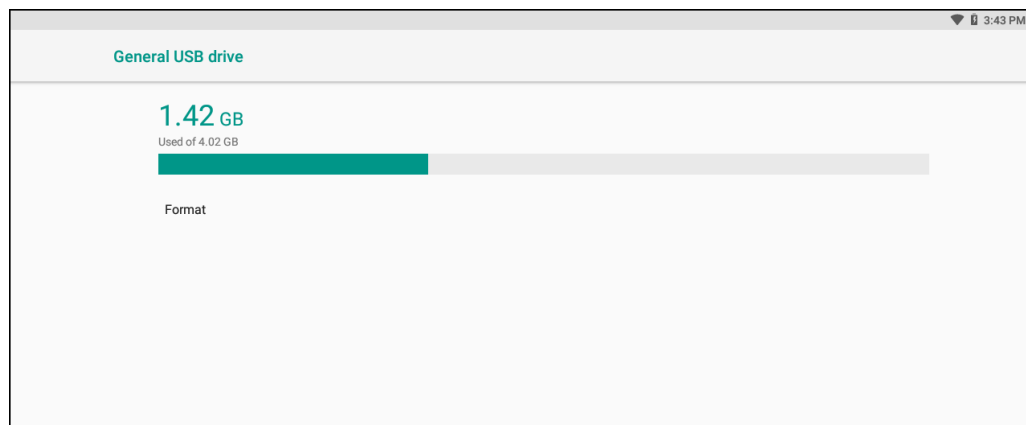
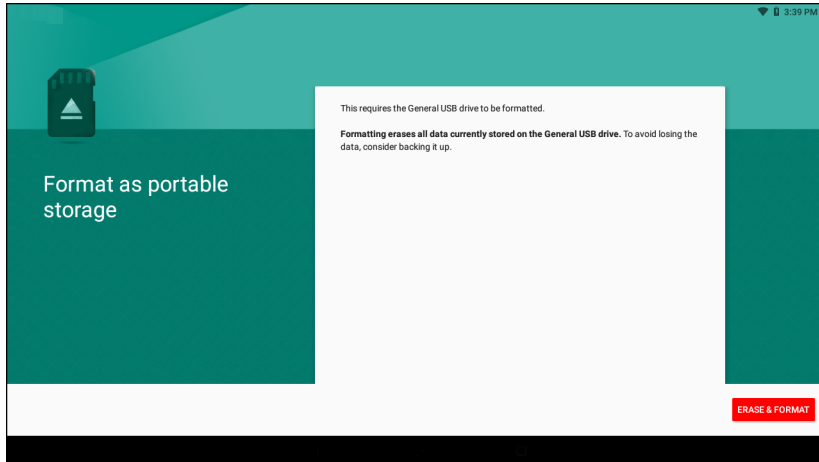

4. Touch **ERASE & FORMAT**.

5. Touch **DONE**.

Enterprise Folder

The Enterprise folder (within internal flash) is a super-persistent storage that is persistent after a reset and an Enterprise Reset. The Enterprise folder is erased during a Factory Reset. The Enterprise folder is used for deployment and device-unique data. The Enterprise folder is approximately 128 MB (formatted). Applications can persist data after an Enterprise Reset by saving data to the enterprise/user folder. The folder is ext4 formatted and is only accessible from a host computer using ADB or from an MDM.

App Management

Apps use two kinds of memory: storage memory and RAM. Apps use storage memory for themselves and any files, settings, and other data they use. They also use RAM when they are running.

1. Swipe down from the Status bar to open the Quick Access panel and then touch .
2. Touch **Apps & notifications**.

Figure 113 Apps & Notifications Screen



3. Touch **See all XX apps** to view all apps on the device.

Figure 114 App Info Screen

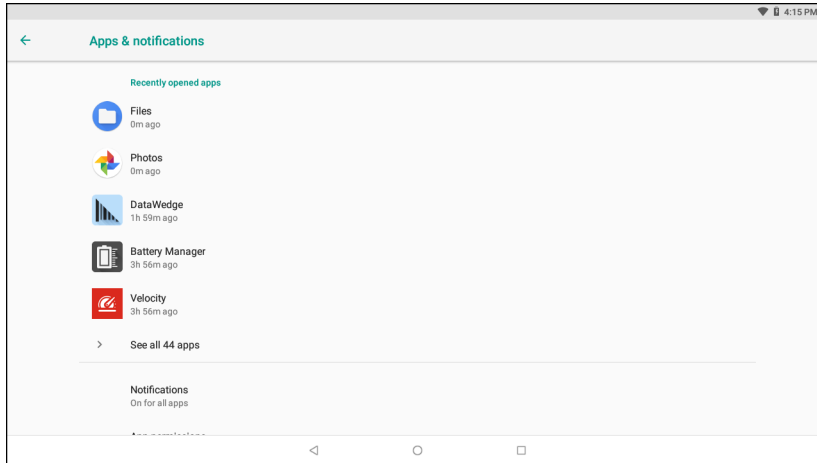
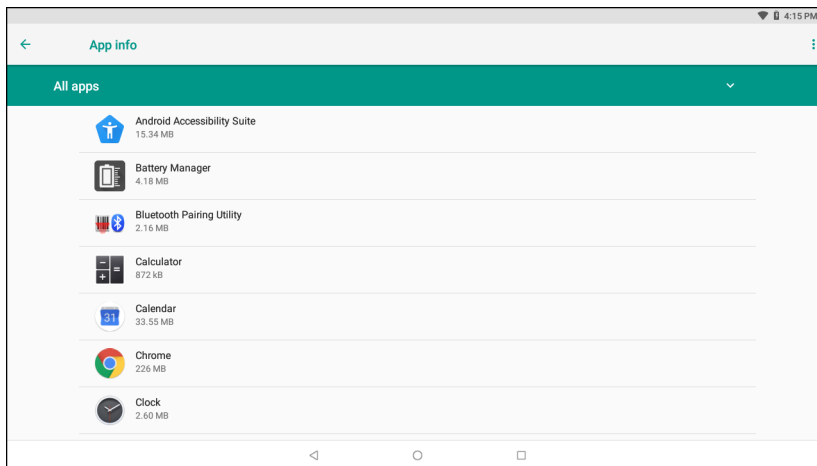

4. Touch  > **Show system** to include system processes in the list.
5. Touch an app, process, or service in the list to open a screen with details about it and, depending on the item, to change its settings, permissions, notifications and to force stop or uninstall it.

Viewing App Details

To view app details, see the steps in [App Management on page 146](#). Apps have different kinds of information and controls, but commonly include these:

- **Force stop** - stop an app.
- **Disable** - disable an app.
- **Uninstall** - remove the app and all of its data and settings from the device. See [Uninstalling an Application on page 136](#) for information about uninstalling apps.
- **Storage** - lists how much information is stored, and includes a button for clearing it.
- **Data usage** - provides information about data (Wi-Fi) consumed by an app.
- **Permissions** - lists the areas on the device that the app has access to.
- **Notifications** - set the app notification settings.
- **Open by default** - clears If you have configured an app to launch certain file types by default, you can clear that setting here.
- **Battery** - lists the amount of computing power used by the app.
- **Memory** - lists the average app memory usage.
- **Advanced**
 - **Draw over other apps** - allows an app to display on top of other apps.

Managing Downloads

Files and apps downloaded using a browser or Email are stored on the USB drive or Internal storage in the Download directory. Use the Downloads app to view, open, or delete downloaded items.



1. Swipe the screen up and touch .
2. Touch **Downloads**.

Figure 115 Files - Downloads Screen

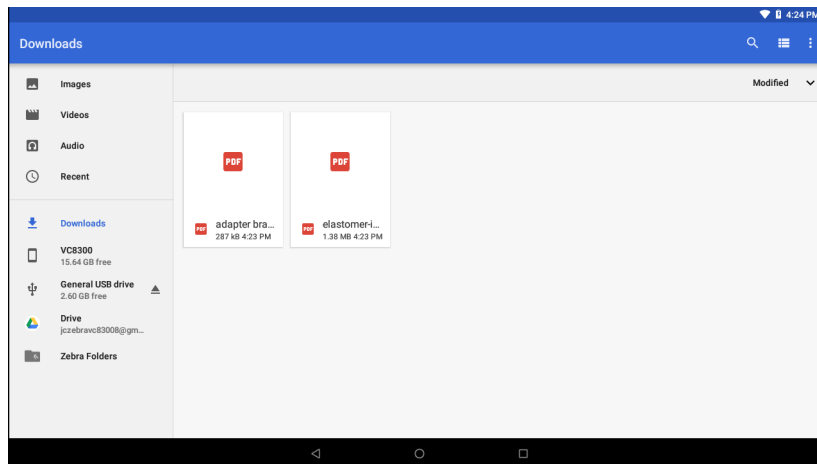

3. Touch and hold an item, select items to delete and touch . The item is deleted from the device.

Maintenance and Troubleshooting

Introduction

This chapter includes instructions on cleaning the L10, storing the tablet, battery maintenance, and troubleshooting solutions for potential problems during L10 operations.

Maintaining the L10

For trouble-free service, observe the following tips when using the L10:

- Protect the L10 from temperature extremes, shock, liquids, and strong magnetic fields.
- Do not store or use the L10 in any location that is extremely dusty, damp, or wet.
- Use a soft lens cloth to clean the screen. If the surface of the L10 screen becomes soiled, clean it with a soft cloth moistened with a diluted window-cleaning solution. Do not use bleach or ammonia.
- Take care not to scratch the screen of the L10.
- The display of the L10 contains glass. Take care not to drop the L10 or subject it to strong impact.
- Do not place heavy objects on top of the tablet.
- If you're storing the tablet for a long time, unplug the power adapter and remove the battery after partially discharging it.
- Do not open the housing that encloses the tablet. There are no user-serviceable components inside. Opening the housing will void your warranty.

Operating the Tablet in Cold Ambient Temperatures

When the tablet is on external power, such as an AC adapter or a powered vehicle dock, performance within the full operating range -4° F to 140° F/-20° C to 60° C is assured.

However, when the tablet is NOT on external power AND is in temperatures lower than 5°F (-15°C), the cold can affect the startup of the tablet and the reporting of the battery capacity.

Battery Safety Guidelines

- The area in which the L10 units are charged should be clear of debris and combustible materials or chemicals. Particular care should be taken where the device is charged in a non-commercial environment.
- Do not use incompatible batteries and chargers. If you have any questions about the compatibility of a battery or a charger, contact Zebra Support. See [Service Information on page 11](#) for contact information.
- Do not crush, puncture, or place a high degree of pressure on the battery.
- Improper battery use may result in a fire, explosion, or other hazard.
- To charge the mobile device battery, the battery and charger temperatures must be between +32°F and +104°F (0°C and +40°C)
- Do not disassemble or open, crush, bend or deform, puncture, or shred.
- Severe impact from dropping any battery-operated device on a hard surface could cause the battery to overheat.
- Do not short circuit a battery or allow metallic or conductive objects to contact the battery terminals.
- Do NOT attempt any of the following activities:
 - Modify or remanufacture this product
 - Insert foreign objects into the battery
 - Immerse or expose this product to water or other liquids
 - Expose to fire, explosion, or other hazard
- Do not leave or store the equipment in or near areas that might get very hot, such as in a parked vehicle or near a radiator or other heat source. Do not place battery into a microwave oven or dryer.
- Battery usage by children should be supervised.
- Please follow local regulations to promptly dispose of used re-chargeable batteries.
- Do not dispose of batteries in fire.
- Seek medical advice immediately if a battery has been swallowed.
- In the event of a battery leak, do not allow the liquid to come in contact with the skin or eyes. If contact has been made, wash the affected area with large amounts of water and seek medical advice.

If you have a problem with your equipment, contact Zebra Global Customer Support for your region. Contact information is available at: zebra.com/support.

Long-term Battery Storage

Do not store any batteries with a full charge, because this can cause a permanent loss of charging capacity. For long-term storage, ensure that the charge level is between 20% and 40% (two LEDs illuminated), and remove the battery from the tablet. Store the battery in a cool, dry environment in the temperature range 0°C to 30°C (32°F to 86°F).

Check stored batteries every 90 days to determine the charge status. If only one LED or no LED is illuminated, recharge the batteries to a level between 20% and 40%. In storage, the batteries will discharge at a rate of 10% of the total capacity per month.

Disposing of Used Batteries

Dispose of a Lithium-ion (Li-ion) battery at a hazardous materials recycling center when it is no longer serviceable. Do not throw it away, because the battery might be put into landfill.

Cleaning



CAUTION: Always wear eye protection.
Read warning label on compressed air and alcohol product before using.
If you have to use any other solution for medical reasons please contact Zebra for more information.



WARNING! Avoid exposing this product to contact with hot oil or other flammable liquids. If such exposure occurs, unplug the device and clean the product immediately in accordance with these guidelines.

Materials Required for Cleaning

- Alcohol wipes
- Lens tissue
- Cotton tipped applicators
- Isopropyl alcohol
- Can of compressed air with a tube

Cleaning the L10

Housing

Using the alcohol wipes, wipe the housing.

Display

The display can be wiped down with the alcohol wipes, but do not allow any pooling of liquid around the edges of the display. Immediately dry the display with a soft, non-abrasive cloth to prevent streaking.

Power Connector

1. Remove the main battery from the L10 tablet.
2. Dip the cotton portion of the cotton tipped applicator in isopropyl alcohol.
3. Use the cotton tipped applicator dipped in alcohol to remove any grease and dirt near the connector area.
4. Repeat steps 2 and 3 a total of three times.
5. Spray compressed air on the connector area by pointing the tube/nozzle about ½ inch away from the surface.



CAUTION: Do not point nozzle at yourself and others, ensure the nozzle or tube is pointed away from your face.

6. Inspect the area for any grease or dirt, repeat if required.

Cleaning the Cradle Connector

Use this procedure to clean the connectors on a cradle:

1. Remove power from the cradle.
2. Dip the cotton portion of the cotton tipped applicator in isopropyl alcohol.
3. Rub the cotton portion of the cotton tipped applicator along the pins of the connector. Slowly move the applicator back-and-forth from one side of the connector to the other. Do not let leave any cotton residue on the connector.

4. All sides of the connector should also be rubbed with the cotton tipped applicator.
5. Spray compressed air in the connector area by pointing the tube/nozzle about ½ inch away from the surface.



CAUTION: Do not point nozzle at yourself and others, ensure the nozzle or tube is pointed away from your face.

6. Ensure that there is no lint left by the cotton tipped applicator.
7. If grease and other dirt can be found on other areas of the cradle, use lint free cloth and alcohol to remove.
8. Allow at least 10 to 30 minutes (depending on ambient temperature and humidity) for the alcohol to air dry before applying power to cradle.

If the temperature is low and humidity is high, longer drying time is required. Warm temperature and dry humidity requires less drying time.

Caring for the Display

Follow these suggestions to keep your display clean:

- Clean fingerprints and smudges from the display surface by wiping it with a microfiber cloth.
- If liquid is spilled on the display, wipe it up immediately with a soft microfiber cloth.
- Use only the L10 pen or your finger to write on the display. Any other object could damage the display surface.
- Protect the display surface from unnecessary contact by using a carry case when transporting the tablet.
- Avoid exposing the display to direct sunlight for long periods of time.
- Every L10 ships from factory with a protective display film.

There are a range of products specifically for your L10 tablet. Refer to the accessories online, zebra.com/support.

Caring for the Pen

If you use an active (digitizer) pen with your tablet:

- Store the active (digitizer) pen in the pen holder when not in use.
- Avoid storing the pen vertically on its tip. It can damage the pen-to-digitizer function.
- Keep the pen away from any liquid, because the pen contains electronic components that can be damaged when wet.
- In certain environments, particles or debris can stick to the pen tip or the tablet display. Make sure you wipe off the pen with a soft cloth to avoid scratching the display.

Traveling with Your L10 Tablet

Use the following tips when you travel with your L10 Tablet:

- Put the L10 tablet in a case to protect the display. Zebra® Technologies sells a variety of cases for the L10 tablet. You can see these accessories online, zebra.com/support.
- Store the pen in the pen bay located on the tablet.
- Pack the L10 tablet securely in a briefcase or hand-carried luggage and keep it separate from toiletries, liquids, and food. Do not pack it in checked luggage.
- Before extended use in the field or long trips away from AC power, adjust the power properties to maximize battery conservation.
- For international travel, you need either a travel plug adapter or the AC power cord that is appropriate for the country that you are visiting. The travel plug adapter can be found in most airports and travel stores. The regional AC power cord can be purchased from an Zebra Authorized Reseller.
- You Do not need to buy a voltage converter; the AC adapter will automatically adjust to different voltages.
- You might want to carry proof of ownership or a merchandise passport when traveling internationally.
- Consult your insurance and credit card companies to learn about emergency travel assistance in case your tablet becomes lost or disabled.
- Turn off the tablet or place it in airplane mode for takeoff and landing. Check with the airline for rules on using your tablet and Wi-Fi while traveling. You can turn off all of your wireless devices temporarily with airplane mode. See [Quick Settings on page 34](#).



CAUTION: Do not carry your tablet through a metal detector.



DANGER: Do not transport Li-ion batteries in checked baggage. The baggage hold can get very hot, which can cause the Li-ion battery to overheat and result in a possible explosion.

Troubleshooting

Table 25 Troubleshooting the L10 Tablet

Problem	Cause	Solution
L10 does not turn on.	Battery not charged.	Charge the battery in the L10.
	Battery not installed properly.	Ensure battery is installed properly.
	System crash.	Perform a soft reset. If the L10 still does not turn on, perform a hard reset. See Restarting the L10 on page 47 .
Battery did not charge.	Battery failed.	Replace battery. If the L10 still does not operate, try a soft reset, then a hard reset. See Restarting the L10 on page 47 .
	L10 removed from cradle before charging completed.	Insert the L10 into the cradle and begin charging. The battery fully charges in approximately four hours.
	Ambient temperature of the cradle is too warm or too cold.	The ambient temperature must be between 0°C and 40°C (32°F and 104°F).
Unable to connect to the wireless network.	SIM card is valid.	Ensure that the micro SIM card is valid and workable if using a mobile network.
	Not within range of network.	Move within the network's service range and the signal strength is good.
	L10 is in airplane mode.	Turn the Airplane mode off.
The multi-touch screen responds slowly or improperly.	Finger or screen is wet.	Ensure that your hands are clean and dry when touching the screen. Restart the tablet to try again.
L10 turns itself off.	L10 is inactive.	The L10 turns off after a period of inactivity. If the L10 is running on battery power.
	Battery is depleted.	Place the L10 in the cradle to re-charge the battery.
	The L10 battery is low and it powers down to protect memory content.	Place the L10 in a cradle to charge the battery.
Screen is not rotating.	Screen rotation is disabled.	Enable screen rotation. See Right Side Features on page 15 .

Specifications

Technical Specifications

The following tables summarize the intended operating environment and general technical hardware specifications for the L10 tablet, including the operating ruggedness, connectivity, communications, and other features.

Table 26 Technical Specifications

Item	Description
Physical Characteristics	
Dimensions	XSLATE or XBOOK Tablet 280 mm x 195.2 mm x 22 mm or 11 in. x 7.7 in. x 0.88 in.
	XPAD Tablet 280.8 mm x 195.2 mm x 22 mm; 11 in. x 10.0 in. x 0.88 in., including handle
Weight	XSLATE Tablet 1.3 Kg; 2.8 lbs
	XPAD Tablet 1.4 Kg; 3.1 lbs
Display	10.1 in (diagonal), 1920 x 1200 WUVGA; brightness output is 500 nits or an optional 1000 nits View Anywhere display for viewing in bright sunlight.
Touch panel	10-point multi-touch display: capacitive or optional multi-touch active digitizer display. There are three touch modes in Settings > Display > Advanced > Touch panel mode : <ul style="list-style-type: none"> • Finger and Wet • Finger and Glove • Finger and Passive Stylus (default)
Keyboard Options	Virtual, Bluetooth, or USB
Expansion	Integrated connector to easily add accessories

Specifications

Table 26 Technical Specifications (Continued)

Item	Description
Connectivity	<ul style="list-style-type: none"> • MicroSD card slot • USB 3.1 and DisplayPort output through a Type-C connector • Two USB 2.0 Type-A connectors • Dual SIM port, holds two Nano SIM cards • 3.5mm audio jack • Charging port • Ethernet RJ45 port for LAN connectivity DisplayPort; • Docking connectors • Optional factory-configurable option that can function as a serial or HDMI-in connector
Camera notification	LED flash; camera LED indicator
Audio	Speaker and dual microphones; the XPAD has one speaker in front and the XSLATE has one speaker on the back.
Battery	Rechargeable Li-Ion, standard capacity (36 Whr), extended capacity (98 Whr), hot swappable
Performance Characteristics	
CPU	Qualcomm Snapdragon 660 platform with 4 to 8 GB of RAM; 64 to 128 GB eMMC SSD
Graphics	Qualcomm Adreno 512 GPU
Operating System	Android Open Source Project (AOSP) version 8.1.0 or Google Mobile Services (GMS) version 8.0.1.
Memory	MicroSD card slot; supports 16 to 32 GB
Data Capture	
Front Camera	5 MP 1080p full HD
Rear Camera	13 MP autofocus camera with LED flash
Video	1080p (Full HD, 1920 x 1080), frame rate = 30 fps
Scanning	Built-in barcode reader (SE 4710) XPAD only
Ruggedness and Environment	
Operating Temperature	-20°C to 60°C (-4°F to 140°F)
Storage Temperature	-30°C to 70°C (-22°F to 158°F)
Battery Charging	0°C to +40°C (32°F to 104°F)
Environmental Sealing	IP65-rated sealing with battery; able to withstand dust and low-pressure water jets
Drop Specification	MIL STD 810G at 25°C; This specification is for dropping the tablet up to 1.83 m (6 feet) to plywood and up to 1.2 m (4 feet) to concrete.

Specifications

Table 26 Technical Specifications (Continued)

Item	Description
Electrostatic Discharge (ESD)	± 8 kV direct discharge ± 15 kV air discharge
Hazardous Location	C1D2 and ATEX rating for use in hazardous locations
Display	Corning Gorilla Glass 3 for increased display damage resistance
Wireless Communications	
WWAN	Global LTE with WCDMA fallback North America: AT&T LTE with AT&T WCDMA 3G fallback; Verizon LTE
WLAN	WLAN: 802.11 a/b/g/n/d/h/i/k/r/ac, IPv4, IPv6; MU-MIMO, 2x2 <ul style="list-style-type: none"> • 2.4 GHz: 802.11b/g/n - up to 144 Mb per second; Chan 1 - 13 (2412 - 2472 MHz), • 5 GHz: 802.11a/n/ac - up to 866.7 Mb per second; Chan 36 - 165 (5180 - 5825 MHz) • Channel Bandwidth: 20, 40, 80 MHz • Actual operating channels/frequencies depend on regulatory rules and certification agency. • WEP (40 or 104 bit); WPA/WPA2 Personal (TKIP and AES); • WPA/WPA2 Enterprise (TKIP and AES) - EAP-TTLS (PAP, MSCHAP, MSCHAPv2), EAP-TLS, PEAPv0-MSCHAPv2, PEAPv1-EAP-GTC, EAP LEAP.
Bluetooth	Bluetooth v5.0 and BLE (Bluetooth low energy)
Near Field Communication (NFC)	NFC is a subset of RFID with a shorter communication range for better security for data. NFC lets you make payments share data. P2P: ISO 18092x. <ul style="list-style-type: none"> • Reader/Writer: ISO 14443 – A-B, MIFARE, FeliCa®, ISO 15693, NFC Forum Tag Types 1 to 4 • Card emulation: ISO 14443 – A-B-B', MIFARE, FeliCa RF • Distance up to 3 cm
Global Navigation Satellite Systems (GNSS)	GPS, Glonass, Galileo, and Beidou
Sensors	
Gyro	Maintains orientation based on principles of conservation of angular momentum
Motion Sensor	Three-axis accelerometer that enables motion-sensing applications for dynamic screen orientation and power management
Ambient Light Sensor	A sensor that automatically adjusts display brightness, keypad, and display backlight
Electronic Compass	An eCompass that does not depend on GPS

Specifications

Table 26 Technical Specifications (Continued)

Item	Description
Printers	
Printers	Supports extensive line of Zebra approved printers

Table 27 Supported Symbologies

Barcode Type	Symbologies
1D	Chinese 2 of 5, Codabar, Code 11, Code 128, Code 39, Code 93, Discrete 2 of 5, EAN-8, EAN-13, GS1 Databar, GS1 Databar Expanded, GS1 Databar Limited, Interleaved 2 of 5, Korean 3 of 5, MSI, Matrix 2 of 5, Trioptic39, UPCA, UPCE0, UPCE1.
2D	Aztec, Composite AB, Composite C, DataMatrix, Grid Matrix, GS1 DataMatrix, Dotcode, GS1 QRCode, Maxicode, MicroPDF, Micro QR, PDF417, QRCode, Han Xin.
Postal	Australian Postal, Canadian Postal, Dutch Postal, Japanese Postal, Mail Mark, UK Postal, US4state, US4state FICS, US Planet, US Postnet.

Index

A

A

Access Point Name (APN)	79
access points (APs)	85
active pen	
short digitizer, long digitizer	23
adaptive frequency hopping (AFH)	
link management, channel classification, hop	
sequence, channel maintenance, Bluetooth	94
ADB	
for factory reset	141
for system update	137
installing an application	136
setting up	133
adding a Wi-Fi network	88
airplane mode	96
on and off	34
ambient light	156
ambient light sensor	13, 17
Android Debug Bridge	
installing an application	136
Android development tools	
SDK, Android Studio IDE	132
Android Open Source Project (ASOP)	155
Android security features	130
APN	79
application	
installing with ADB	136
installing with microSD	134
uninstalling	136
apps	
Battery Manager	51
camera	67
DataWedge Demonstration	55
Files	57
managing, using memory and RAM	146
sound recorder	78
viewing a list	146
viewing details	147
audio connector	15, 19

auto-rotate	
screen	36

B

barcode	
scanning, aiming	106
barcode reader	
built-in	155
barcode scanner	
button (XPAD)	20, 27
barcode scanner (XPAD)	102
barcodes	
enabling, disabling, viewing	103
supported	103, 157
supported types	157
two dimensional	101
battery	
changing	28
charge level (back of battery)	26
charging	22
charging temperature	149, 155
disposing	149
hot swappable	14, 19, 155
hot swapping	28
installing, charging	22
latch	14
LED indicator	13, 17
lithium-ion	12
low power notification	25
operating temperatures	149
out of the tablet	26
removing, replacing	27
safety	149
standard and extended capacity	155
storage, charge level for storage	149
battery charging indicator	
blinking amber	22
battery LED indicator	13, 17
battery management	24
battery level	24
battery present status	24

Battery Manager	51	capacitive pens	23
battery optimization		care	
saving power	26	maintenance	148
battery test		care and maintenance	
diagnostic tool	65	active digitizer pen, ePen	151
battery, installing	22	Central Processing Unit (CPU)	155
Bluetooth	94, 156	change Bluetooth name	98
change name	98	changing the battery	28
diagnostic test	66	charging	
disable, turn off	97	battery	22
discovering devices	97	Chrome	
enable	96	browser	40
on and off	34	cleaning	148, 150
pairing with imager	39	cradle connectors	150
power states, airplane mode	96	clock	40
profiles	95	cold temperature	
security, link level, PIN, pairing	95	operating tablet, battery power	148
turn on	96	compass	
brightness		electronic, eCompass	156
sensor	13, 17	connecting	
browser		external monitor to tablet	24
Chrome	40	mobile broadband	21
		WLAN	86
C		contacts	40
calculator	39	adding	54
calendar	39	deleting	54
camera	67	editing	54
color effect, filters, styles	67	conventions	
flash, LED indicator	155	notational	10
front camera photo settings	71	Corning Gorilla glass	9
front, 5 MP	155	credential storage settings	
gallery	68	security	130, 131
light	14	customizing	
light (back of XPAD), flash	18	function buttons (XPAD)	39
photo settings	71		
rear camera photo settings	71	D	
rear, autofocus, 13 MP	155	damage resistance	9
recording videos	70	data capture	
shutter	68	imaging	101
taking panoramic photos	69	two-dimensional bar codes	101
taking photos	67, 68	data usage	
type of scene	68	form, data saver	80
camera (front)	13, 17	warning, alert	81
Skype, video, photo mode	37	DataWedge	40, 105
camera (rear)		enabling, disabling	111
13 megapixels	14, 18	DataWedge Demonstration	55
tips, video, photo mode	37	debugging	134
camera app	40	developer options	
camera mode		opening	132
panoramic, video, camera	68, 70	Device Central	40
camera settings	71	diagnostic tool	
video	72	battery test information	65
camera switch		Bluetooth test	66
front or rear	67, 70	GPS test information	65

pairing	109
High Dynamic Range	
camera feature	67
holder	
pen	14
Home screen	30
home screen	13, 18
hot swapping the battery	28
hot-swappable battery	14, 19
Human Interface Device (HID)	
for pairing devices	109

I

imager. <i>See</i> data capture, imaging	
imaging	101
information, service	11
inserting	
SD card, memory card	38
SIM card, two SIM cards	21
installing	
an application	
using microSD	134
battery	22
secure certificate	130
internal storage	142

J

jack	
Ethernet	15, 20
headset	15, 19

K

Kensington lock slot	14, 18
keyboard	
on-screen	36
keyboard (enterprise)	
configuring	127
keyboard (keypad)	
Bluetooth, USB, virtual	154
keyboard (on-screen)	37
keyboard (virtual)	
enabling	127
enterprise	127
Gboard	127
keyboard options	154
kill switch	17

L

L10	
features overview	8
L10 platform	

XPAD, XSLATE, XBOOK	8
language	
adding	125
adding words	126
removing	126
selecting	126
light	
ambient light sensor	156
light sensor	13, 17
lithium-ion battery	12
lock screen	30
locked screen	44
locking	
(SIM), PIN	80
Kensington lock slot	18
Kensington slot	14
locking door	
USB cover, left side	15, 19

M

maintenance	
tablet	148
managing apps	146, 147
managing notifications	33
memory	
micro-SD card slot	15
microSD card slot	19
memory card	
inserting, removing	38
memory card slot	
microSD	155
memory, microSD	155
microphone input	15, 19
microphones	13, 17, 155
microSD	
for enterprise reset	139
for factory reset	140
for update package	137
formatting	144
installing an application	134
microSD card slot	19
mobile broadband	
connecting, SIM card, WWAN card, cellular	21
monitor (external)	
connecting	24
motion sensor	156
moving apps on screen	35
N	
Near Field Communication (NFC)	19
sharing data, make payments	156
NFC	14
notification	

- low battery 25
- notifications
 - managing, icons, panel, description 33
- O**
- operating system, ASOP, GMS 155
- operating temperature 155
- optimizing the battery 26
- optional external RS507 155
- optional features
 - barcode scanner 9
 - integrated UHF NFC reader 9
 - Wacom-based digitizer 9
- overview of XPAD 17
 - back side 18
 - bottom side, docking connectors 16
 - front side 17
 - left side 19
 - top side 20
- overview of XSLATE
 - back side 14
 - bottom side, docking connectors 16
 - front side 13
 - front side, features 13
 - left side 15
 - right side 15, 20
- P**
- P1 and P2 (XPAD)
 - function buttons description 17
- pairing
 - HID for RS scanners with L10 109
 - HID, DS3678 scanner 111
 - SSI 110
 - with SSI, RS507x and RS6000 108
- pairing utility 108
- panoramic 69
- parts of the tablet
 - front view 12
- pen
 - active Stylus Tip Kit 151
 - attaching to tether 23
 - care and maintenance 151
 - holder 14
 - holder (XPAD) 20, 27
 - holder (XPAD), long pen 17
 - long active/digitizer, Wacom compatible 23
 - short active/digitizer, Wacom compatible 23
 - short capacitive, long capacitive ePen, battery (AAAA) 23
 - tether post (XPAD) 18
- photo transfer
 - by USB 49
- photos
 - panoramic 69
 - taking 67, 68
- pick-list scanning
 - RS6000 105
- platform L10
 - XPAD, XSLATE, XBOOK 8
- plug adapter
 - travel 152
- port
 - Ethernet 15, 20
 - for AC adapter, external power 22
 - power connector 15, 20
 - USB 2.0 15, 19
- port cover
 - expansion 14, 19
- power
 - adapter port, on/off button, AC power 22
 - low battery notification 25
- power button 15, 20, 22
- power cord
 - travel 152
- power input (port)
 - external power adapter 15, 20
- power LED 13, 17
- Pre-Shared Key (PSK) 85
- privacy 85
- proxy server
 - configuring, firewall, security 89
- PSK 85
- PTT Express 74
- Q**
- quick settings 34
- R**
- RAM
 - storage 142
- rear camera
 - video settings 73
- rebooting the tablet 47
- Regulatory Guide 8
- related documents 10
- related software 10
- removing
 - application, widget 35
- removing the battery 27
- replacing the battery 27
- reset (enterprise)
 - with microSD 139
- reset (factory)
 - with ADB 141
 - with microSD 140

- reset switch 17, 47
 - force power off 13
 - restarting the tablet 47
 - soft reset, power button 47
 - RFID/NFC reader
 - formats supported, sample application 99
 - rotate
 - screen 36
 - rotation
 - auto, lock 15, 20
 - RS507x imager
 - Bluetooth pairing utility 108
 - RS507X scanner
 - barcode reader, aiming, LED indicator 104
 - barcode reader, hands-free 104
 - RS507x scanner
 - barcode reader, hands-free 103
 - RS507x/RS6000 imager
 - pairing with SSI 108
 - RS6000 scanning
 - aiming, pick-list mode 105
- S**
- scanner
 - DS3678 106
 - picklist mode, decode mode 100
 - scanners
 - XPAD tablet built-in, RS507X, RS6000, DS3578, DS3608 100
 - scanning
 - aiming 101
 - angle 101
 - barcode, aiming 106
 - imaging 101
 - range 101
 - tips 103
 - scanning button 102
 - screen
 - brightness 119
 - caring for, protective film 151
 - locked 44
 - timeout 119
 - screen lock
 - setting 122
 - show password 125
 - with password 123, 125
 - with pattern 124
 - with PIN 122
 - screen rotation 120
 - auto-rotate, lock 36
 - SD card
 - inserting, removing 38
 - SD card reader
 - adding memory card, storage 38
 - secure certificate
 - installing 130
 - security 85
 - credential storage settings 130, 131
 - Kensington lock slot 14, 18
 - proxy server, firewall, configuring 89
 - security configuration for apps to run 130
 - sensor
 - light 156
 - motion 156
 - serial number 9
 - service information 11, 149
 - setting
 - camera 71
 - setting up
 - ADB 133
 - optional setup tasks 23
 - settings 42
 - airplane mode 34
 - display 119
 - general sound 120
 - photos 71
 - quick access panel 34
 - quick, changing 34
 - videos 72, 73
 - sharing data
 - NFC 156
 - SIM
 - card slot, holder 21
 - SIM card
 - inserting, two cards 21
 - locking, PIN 80
 - software versions 9
 - sound recorder 42, 78
 - speaker 155
 - built-in 14
 - speaker (XPAD) 17
 - specifications
 - 1D barcodes 157
 - 2D barcodes 157
 - data capture 155
 - performance characteristics 155
 - physical characteristics 154
 - postal barcodes 157
 - printers 157
 - ruggedness, environment 155
 - sensors 156
 - SIM port 155
 - supported symbologies 157
 - touch panel mode 9, 23, 36, 154
 - USB connectors 155
 - wireless communications 156
 - StageNow
 - Android Staging Solution 133
 - GMS restricted mode 133

- staging profiles 133
 - Static IP address
 - using, configuring tablet for static IP 90
 - status
 - system, LED indicator 13, 17
 - status bar 31
 - status icons 31
 - storage
 - battery 149
 - storage temperature 155
 - storing
 - tablet 148
 - swapping batteries 28
 - symbolologies
 - barcode types 157
 - system
 - diagnostic test 66
 - system language
 - adding 125
 - removing 126
 - selecting 126
 - system status 13, 17
 - system update
 - verifying 138
- T**
- tablet
 - diagnostic test 66
 - tablet information
 - model, Android version, security patch version, kernel version, build number 9
 - tablet specifications
 - dimensions, weight 154
 - display, touch panel 154
 - keyboard types 154
 - touch panel 9, 23, 36, 154
 - taking a panoramic photo 69
 - temperature
 - for battery charging 155
 - tether
 - for pen 23
 - tether post
 - for pen (XPAD) 18
 - timeout
 - screen 119
 - tips
 - active digitizer pens 151
 - touch panel mode
 - finger, glove, stylus 9, 23, 36, 154
 - touchscreen 13, 18
 - caring for 151
 - cleaning 151
 - swipe, double-touch, pinch 36
 - using, touch, drag 35
 - transferring files with USB 48
 - transferring photos with USB 49
 - travel
 - plug adapter, power cord, voltage converter 152
 - traveling with tablet 152
 - troubleshooting
 - battery 153
 - screen rotation, 153
 - wireless connection 153
- U**
- uninstalling
 - application 136
 - unlocking screen
 - password 45
 - pattern 45
 - PIN 44
 - unpacking the tablet
 - equipment in the box 12
 - updating system
 - using ADB 137
 - using microSD 137
 - USB 155
 - 2.0 port 15, 19
 - debugging 134
 - display port output 15, 19
 - transferring files 48
 - transferring photos 49
 - type-C, USB 3.1 15, 19
 - USB 3.1
 - DisplayPort, Type-C connector 155
 - Using the Device 29
- V**
- verifying
 - system update 138
 - video
 - audio recording 70
 - color effects, filters 70
 - frame rate, (fps), full HD, 1080p 155
 - gallery 70
 - settings 70
 - shutter 70
 - video settings
 - front camera 72
 - rear camera 73
 - videos
 - recording 70
 - voltage converter
 - travel 152
 - volume
 - control button 15, 20

W

weight of tablet	154
WEP	85
widgets	
adding	35
moving	35
removing	35
Wi-Fi	
advanced features	93
on and off	34
Wi-Fi network	
configuring, setting up, WEP, EAP, WPA, WPS2, PSK, user certificate	88
configuring, setting up, WLAN	87
connecting to	86
manually adding	88
Wi-Fi preferences	90
Wi-Fi protected access (WPA)	85
wireless equivalent privacy (WEP)	85
wireless local area network (WLAN)	79
wireless local area networks (WLAN)	85
wireless wide area network (WWAN)	79
with USB	134
WLAN	79, 85, 86
diagnostic test	66
WLAN, WEP, EAP	87
WPA	85
WPA2	85
WPAN	156
WPS pin entry	92
WPS push button	92
WWAN	79
diagnostic test	66

X

XBOOK	
platform L10	8
XPAD	
barcode scanner (built-in)	102
built-in scanner	100
function buttons	17, 39
overview	17
overview, features	17
pen holder, barcode scanner button	20
speaker	17
XSLATE	
overview, features	13

