

SRX Series Services Gateways for the Branch Physical Interface Modules Reference

Published
2022-04-21

Juniper Networks, Inc.
1133 Innovation Way
Sunnyvale, California 94089
USA
408-745-2000
www.juniper.net

Juniper Networks, the Juniper Networks logo, Juniper, and Junos are registered trademarks of Juniper Networks, Inc. in the United States and other countries. All other trademarks, service marks, registered marks, or registered service marks are the property of their respective owners.

Juniper Networks assumes no responsibility for any inaccuracies in this document. Juniper Networks reserves the right to change, modify, transfer, or otherwise revise this publication without notice.

SRX Series Services Gateways for the Branch Physical Interface Modules Reference
Copyright © 2022 Juniper Networks, Inc. All rights reserved.

The information in this document is current as of the date on the title page.

YEAR 2000 NOTICE

Juniper Networks hardware and software products are Year 2000 compliant. Junos OS has no known time-related limitations through the year 2038. However, the NTP application is known to have some difficulty in the year 2036.

END USER LICENSE AGREEMENT

The Juniper Networks product that is the subject of this technical documentation consists of (or is intended for use with) Juniper Networks software. Use of such software is subject to the terms and conditions of the End User License Agreement (“EULA”) posted at <https://support.juniper.net/support/eula/>. By downloading, installing or using such software, you agree to the terms and conditions of that EULA.

Table of Contents

About the Documentation | xii

Documentation and Release Notes | xii

Using the Examples in This Manual | xii

 Merging a Full Example | xiii

 Merging a Snippet | xiv

Documentation Conventions | xiv

Documentation Feedback | xvii

Requesting Technical Support | xvii

 Self-Help Online Tools and Resources | xviii

 Creating a Service Request with JTAC | xviii

1

Overview

SRX Series Services Gateway Interface Modules Support | 2

SRX Series Services Gateway Interface Overview | 2

 Interfaces Port Naming Conventions SRX Series Services Gateways | 3

Supported SRX Series Services Gateway Interfaces | 5

SRX Series Services Gateway Mini-Physical Interface Modules Overview | 6

SRX Series Services Gateway Gigabit-Backplane Physical Interface Modules Overview | 8

SRX Series Services Gateway Interface Modules and Compatibility | 11

MTU Default and Maximum Values for Physical Interface Modules | 12

Power over Ethernet Support on SRX Series Services Gateway Interfaces | 15

SRX Series Services Gateway Interfaces Power and Heat Requirements | 17

Network Interface Specifications | 19

1-Port Gigabit Ethernet SFP Mini-Physical Interface Module Network Interface Specifications | 19

1-Port SFP Mini-Physical Interface Module Network Interface Specifications | 20

1-Port ADSL2+ Mini-Physical Interface Module Network Interface Specifications | 21

1-Port DOCSIS Mini-Physical Interface Module Network Interface Specifications | 22

1-Port T1/E1 Mini-Physical Interface Module Network Interface Specifications | 23

1-Port Clear Channel DS3/E3 GPIM Network Interface Specifications | 25

8-Port Gigabit Ethernet SFP XPIM Network Interface Specifications | 26

8-Port Serial GPIM Interface Specifications | 27

Dual CT1/E1 GPIM Network Interface Specifications | 29

Quad CT1/E1 GPIM Network Interface Specifications | 30

2

Interface Module Descriptions

1-Port Gigabit Ethernet SFP Mini-Physical Interface Module | 33

1-Port Gigabit Ethernet SFP Mini-Physical Interface Module Overview | 33

1-Port Gigabit Ethernet SFP Mini-Physical Interface Module Key Features | 34

1-Port Gigabit Ethernet SFP Mini-Physical Interface Module Hardware Specifications | 35

1-Port Gigabit Ethernet SFP Mini-Physical Interface Module LEDs | 35

1-Port Gigabit Ethernet SFP Mini-Physical Interface Module Supported Modules | 36

1-Port SFP Mini-Physical Interface Module | 39

1-Port SFP Mini-Physical Interface Module Overview | 39

1-Port SFP Mini-Physical Interface Module Key Features | 40

1-Port SFP Mini-Physical Interface Module Hardware Specifications | 41

1-Port SFP Mini-Physical Interface Module LEDs | 42

1-Port SFP Mini-Physical Interface Module Supported Modules | 42

1-Port ADSL2+ Mini-Physical Interface Module | 45

1-Port ADSL2+ Mini-Physical Interface Module Overview | 45

1-Port ADSL2+ Mini-Physical Interface Module Key Features | 46

1-Port ADSL2+ Mini-Physical Interface Module Hardware Specifications | 47

1-Port ADSL2+ Mini-Physical Interface Module LEDs | 48

1-Port ADSL2+ Mini-Physical Interface Module Supported Standards | 48

1-Port ADSL2+ Mini-Physical Interface Module Supported Loopback Diagnostics | 49

1-Port DOCSIS Mini-Physical Interface Module | 51

1-Port DOCSIS Mini-Physical Interface Module Overview | 51

1-Port DOCSIS Mini-Physical Interface Module Key Features | 52

1-Port DOCSIS Mini-Physical Interface Module Hardware Specifications | 53

1-Port DOCSIS Mini-Physical Interface Module LEDs | 54

1-Port DOCSIS Mini-Physical Interface Module Supported Standards | 55

1-Port G.SHDSL 8-Wire Mini-Physical Interface Module | 57

- 1-Port G.SHDSL 8-Wire Mini-Physical Interface Module Overview | 57
- 1-Port G.SHDSL 8-Wire Mini-Physical Interface Module Key Features | 58
- 1-Port G.SHDSL 8-Wire Mini-Physical Interface Module Hardware Specifications | 59
- 1-Port G.SHDSL 8-Wire Mini-Physical Interface Module LEDs | 60
- 1-Port G.SHDSL 8-Wire Mini-Physical Interface Module Supported Standards | 61

1-Port Serial Mini-Physical Interface Module | 62

- 1-Port Serial Mini-Physical Interface Module Overview | 62
- 1-Port Serial Mini-Physical Interface Module Key Features | 63
- 1-Port Serial Mini-Physical Interface Module Hardware Specifications | 63
- 1-Port Serial Mini-Physical Interface Module LEDs | 64
- 1-Port Serial Mini-Physical Interface Module Supported Standards | 65

1-Port T1/E1 Mini-Physical Interface Module | 66

- 1-Port T1/E1 Mini-Physical Interface Module Overview | 66
- 1-Port T1/E1 Mini-Physical Interface Module Key Features | 67
- 1-Port T1/E1 Mini-Physical Interface Module Hardware Specifications | 67
- 1-Port T1/E1 Mini-Physical Interface Module LEDs | 68
- 1-Port T1/E1 Mini-Physical Interface Module Supported Standards | 69
- 1-Port T1/E1 Mini-Physical Interface Module Supported Loopback Diagnostics | 70

1-Port VDSL2 (Annex A) Mini-Physical Interface Module | 72

- 1-Port VDSL2 (Annex A) Mini-Physical Interface Module Overview | 72
- 1-Port VDSL2 (Annex A) Mini-Physical Interface Module Key Features | 73
- 1-Port VDSL2 (Annex A) Mini-Physical Interface Module Hardware Specifications | 74
- 1-Port VDSL2 (Annex A) Mini-Physical Interface Module LEDs | 74
- 1-Port VDSL2 (Annex A) Mini-Physical Interface Module Supported Profiles | 75

1-Port Clear Channel DS3/E3 GPIM | 77

- 1-Port Clear Channel DS3/E3 GPIM Overview | 77
- 1-Port Clear Channel DS3/E3 GPIM Components | 78
- 1-Port Clear Channel DS3/E3 GPIM Key Features | 79
- 1-Port Clear Channel DS3/E3 GPIM Hardware Specifications | 79
- 1-Port Clear Channel DS3/E3 GPIM LEDs | 80

- 1-Port Clear Channel DS3/E3 GPIM Supported Standards | 81
- 1-Port Clear Channel DS3/E3 GPIM Supported Loopback Diagnostics | 81

2-Port 10-Gigabit Ethernet XPIM | 83

- 2-Port 10-Gigabit Ethernet XPIM Overview | 83
- 2-Port 10-Gigabit Ethernet XPIM Components | 84
- 2-Port 10-Gigabit Ethernet XPIM Key Features | 87
- 2-Port 10 Gigabit Ethernet XPIM Hardware Specifications | 88
- 2-Port 10 Gigabit Ethernet XPIM LEDs | 90

8-Port Gigabit Ethernet SFP XPIM | 92

- 8-Port Gigabit Ethernet SFP XPIM Overview | 92
- 8-Port Gigabit Ethernet SFP XPIM Components | 93
- 8-Port Gigabit Ethernet SFP XPIM Key Features | 94
- 8-Port Gigabit Ethernet SFP XPIM Hardware Specifications | 95
- 8-Port Gigabit Ethernet SFP XPIM LEDs | 96
- 8-Port Gigabit Ethernet SFP XPIM Supported Modules | 97

8-Port Serial GPIM | 99

- 8-Port Serial GPIM Overview | 99
- 8-Port Serial GPIM Components | 100
- 8-Port Serial GPIM Key Features | 101
- 8-Port Serial GPIM Hardware Specifications | 102
- 8-Port Serial GPIM LEDs | 103

16-Port Gigabit Ethernet XPIM | 104

- 16-Port Gigabit Ethernet XPIM Overview | 104
- 16-Port Gigabit Ethernet XPIM Components | 105
- 16-Port Gigabit Ethernet XPIM Key Features | 107
- 16-Port Gigabit Ethernet XPIM Hardware Specifications | 107
- 16-Port Gigabit Ethernet XPIM LEDs | 108

24-Port Gigabit Ethernet XPIM | 111

24-Port Gigabit Ethernet XPIM Overview | 111

24-Port Gigabit Ethernet XPIM Components | 112

24-Port Gigabit Ethernet XPIM Key Features | 115

24-Port Gigabit Ethernet XPIM Hardware Specifications | 116

24-Port Gigabit Ethernet XPIM LEDs | 117

Dual CT1/E1 GPIM | 119

Dual CT1/E1 GPIM Overview | 119

Dual CT1/E1 GPIM Components | 120

Dual CT1/E1 GPIM Key Features | 121

Dual CT1/E1 GPIM Hardware Specifications | 121

Dual CT1/E1 GPIM LEDs | 122

Quad CT1/E1 GPIM | 123

Quad CT1/E1 GPIM Overview | 123

Quad CT1/E1 GPIM Components | 124

Quad CT1/E1 GPIM Key Features | 125

Quad CT1/E1 GPIM Hardware Specifications | 125

Quad CT1/E1 GPIM LEDs | 126

3

Cable Specifications and Pinouts

T1/E1 Mini-Physical Interface Module | 128

RJ-48 Connector to RJ-48 Connector (Straight) Pinouts for the 1-Port T1/E1 Mini-Physical Interface Module | 128

RJ-48 Connector to RJ-48 Connector (Crossover) Pinouts for the 1-Port T1/E1 Mini-Physical Interface Module | 129

RJ-48 Connector to DB-15 Connector (Straight) Pinouts for the 1-Port T1/E1 Mini-Physical Interface Module | 130

RJ-48 Connector to DB-15 Connector (Crossover) Pinouts for the 1-Port T1/E1 Mini-Physical Interface Module | 132

ADSL2 + Mini-Physical Interface Module | 134

RJ-11 Connector Pinouts for the 1-Port ADSL2+ Mini-Physical Interface Module | 134

G.SHDSL Mini-Physical Interface Module Cable Specifications | 135

1-Port G.SHDSL 8-Wire Mini-Physical Interface Module Cable Specifications | 135

VDSL2 Mini-Physical Interface Module Cable Specifications | 141

1-Port VDSL2 (Annex A) Mini-Physical Interface Module Cable Specifications | 141

Serial Mini-Physical Interface Module Cable Specifications | 143

1-Port Serial Mini-Physical Interface Module Interface Cables | 143

EIA-530A DCE Cable Pinouts for the 1-Port Serial Mini-Physical Interface Module | 144

EIA-530A DTE Cable Pinouts for the 1-Port Serial Mini-Physical Interface Module | 145

RS-232 DCE Cable Pinouts for the 1-Port Serial Mini-Physical Interface Module | 147

RS-232 DTE Cable Pinouts for the 1-Port Serial Mini-Physical Interface Module | 148

RS-422/449 (EIA-449) DCE Cable Pinouts for the 1-Port Serial Mini-Physical Interface Module | 149

RS-422/449 (EIA-449) DTE Cable Pinouts for the 1-Port Serial Mini-Physical Interface Module | 150

V.35 DCE Cable Pinouts for the 1-Port Serial Mini-Physical Interface Module | 152

V.35 DTE Cable Pinouts for the 1-Port Serial Mini-Physical Interface Module | 153

X.21 DCE Cable Pinouts for the 1-Port Serial Mini-Physical Interface Module | 155

X.21 DTE Cable Pinouts for the 1-Port Serial Mini-Physical Interface Module | 155

Serial Gigabit-Backplane Physical Interface Module Cable Specifications | 157

8-Port Serial GPIM Interface Cables | 157

EIA-449 DCE Cable Pinouts for 8-Port Serial Gigabit-Backplane Physical Interface Module | 159

EIA-449 DTE Cable Pinouts for 8-Port Serial Gigabit-Backplane Physical Interface Module | 163

EIA-530 DCE Cable Pinouts for the 8-Port Serial Gigabit-Backplane Physical Interface Module | 167

EIA-530 DTE Cable Pinouts for the 8-Port Serial Gigabit-Backplane Physical Interface Module | 170

EIA-530A DCE Cable Pinouts for 8-Port Serial Gigabit-Backplane Physical Interface Module | 174

EIA-530A DTE Cable Pinouts for the 8-Port Serial Gigabit-Backplane Physical Interface Module | 177

RS-232 DCE Cable Pinouts for the 8-Port Serial Gigabit-Backplane Physical Interface Module | 180

RS-232 DTE Cable Pinouts for the 8-Port Serial Gigabit-Backplane Physical Interface Module | 182

V.35 DCE Cable Pinouts for the 8-Port Serial Gigabit-Backplane Physical Interface Module | 184

V.35 DTE Cable Pinouts for the 8-Port Serial Gigabit-Backplane Physical Interface Module | 188

X.21 DCE Cable Pinouts for the 8-Port Serial Gigabit-Backplane Physical Interface Module | 191

X.21 DTE Cable Pinouts for the 8-Port Serial Gigabit-Backplane Physical Interface Module | 193

Configuration

Configuring Mini-Physical Interface Modules | 196

1-Port Gigabit Ethernet SFP Mini-Physical Interface Module Basic Configuration | 196

Using the J-Web Interface | 197

Using the CLI | 198

1-Port SFP Mini-Physical Interface Module Basic Configuration | 199

Using the J-Web Interface | 200

Using the CLI | 201

1-Port ADSL2+ Mini-Physical Interface Module Basic Configuration | 201

Using the J-Web Interface | 202

Using the CLI | 203

1-Port DOCSIS Mini-Physical Interface Module Basic Configuration | 204

Using the J-Web Interface | 204

Using the CLI | 205

1-Port G.SHDSL 8-Wire Mini-Physical Interface Module Basic Configuration | 206

1-Port Serial Mini-Physical Interface Module Basic Configuration | 207

Using the J-Web Interface | 207

Using the CLI | 208

1-Port T1/E1 Mini-Physical Interface Module Basic Configuration | 209

Using the J-Web Interface | 209

Using the CLI | 210

1-Port VDSL2 (Annex A) Mini-Physical Interface Module Basic Configuration | 211

Using the J-Web Interface | 212

Using the CLI | 212

Configuring Gigabit-Backplane Physical Interface Modules | 214

1-Port Clear Channel DS3/E3 GPIM Basic Configuration | 214

Using the CLI | 214

2-Port 10-Gigabit Ethernet XPIM Basic Configuration | 217

Using the J-Web Interface | 217

Using the Point and Click CLI to Set Interface Mode and Speed Options | 218

Using the CLI | 219

8-Port Gigabit Ethernet SFP XPIM Basic Configuration | 221

8-Port Serial GPIM Basic Configuration | 225

16-Port Gigabit Ethernet XPIM Basic Configuration | 229

24-Port Gigabit Ethernet XPIM Basic Configuration | 229

Using the J-Web Interface | 230

Using the CLI | 230

Dual CT1/E1 GPIM Basic Configuration | 232

Using the J-Web Interface | 232

Using the CLI to Configure the CT1 Interface | 233

Using the CLI to Configure the CE1 Interface | 234

Quad CT1/E1 GPIM Basic Configuration | 235

Using the J-Web Interface | 235

Using the CLI to Configure the CT1 Interface | 236

Using the CLI to Configure the CE1 Interface | 237

Mini-Physical Interface Module and Gigabit-Backplane Physical Interface Module Operating Modes and Supported Modules | 239

1-Port G.SHDSL 8-Wire Mini-Physical Interface Module Operating Modes | 239

5

Replacing Interface Modules

Overview of Replacing Interface Modules | 242

Required Tools and Parts for Replacing a Mini-Physical Interface Module | 242

Required Tools and Parts for Replacing a Gigabit-Backplane Physical Interface Module | 243

Preventing Electrostatic Discharge Damage to the SRX Series Services Gateway | 244

Replacing Mini-Physical Interface Modules | 246

Removing a Blank Mini-Physical Interface Module Faceplate from the SRX Series Services Gateway | 246

Installing a Mini-Physical Interface Module in the SRX Series Services Gateway | 247

Removing a Mini-Physical Interface Module from the SRX Series Services Gateway | 249

Replacing Gigabit-Backplane Physical Interface Modules | 252

Installing a Blank Gigabit-Backplane Physical Interface Module Faceplate on the SRX Series Services Gateway | **252**

Removing a Blank Gigabit-Backplane Physical Interface Module Faceplate from the SRX Series Services Gateway | **253**

Installing a Gigabit-Backplane Physical Interface Module on the SRX Series Services Gateway | **253**

Installing a Double-High, Double-Wide Gigabit-Backplane Physical Interface Module on the SRX Series Services Gateway | **256**

Removing a Gigabit-Backplane Physical Interface Module from the SRX Series Services Gateway | **258**

Contacting Customer Support and Returning Components | 261

Contacting Customer Support | **261**

Return Procedure for SRX Series Services Gateway Hardware Components | **262**

Locating the SRX Series Services Gateway Hardware Component Mini-PIM or GPIM Serial Number Label | **263**

SRX Series Services Gateway Mini-PIM Serial Number Label | **263**

SRX Series Services Gateway GPIM Serial Number Label | **263**

Information You Might Need to Supply to JTAC | **263**

Required Tools and Parts for Packing the SRX Series Services Gateway Hardware Components | **264**

Packing the SRX Series Services Gateway Hardware Components for Shipment | **264**

Packing the Hardware Components for Shipment | **265**

About the Documentation

IN THIS SECTION

- Documentation and Release Notes | [xii](#)
- Using the Examples in This Manual | [xii](#)
- Documentation Conventions | [xiv](#)
- Documentation Feedback | [xvii](#)
- Requesting Technical Support | [xvii](#)

Use this guide to understand the specifications and perform the basic configuration for the interface modules supported on the SRX210, SRX220, SRX240, SRX550, and SRX650 Services Gateways. After understanding the support and compatibility information, and completing the configuration procedures covered in this guide, refer to the Junos OS documentation for information about further software configuration.

Documentation and Release Notes

To obtain the most current version of all Juniper Networks[®] technical documentation, see the product documentation page on the Juniper Networks website at <https://www.juniper.net/documentation/>.

If the information in the latest release notes differs from the information in the documentation, follow the product Release Notes.

Juniper Networks Books publishes books by Juniper Networks engineers and subject matter experts. These books go beyond the technical documentation to explore the nuances of network architecture, deployment, and administration. The current list can be viewed at <https://www.juniper.net/books>.

Using the Examples in This Manual

If you want to use the examples in this manual, you can use the **load merge** or the **load merge relative** command. These commands cause the software to merge the incoming configuration into the current candidate configuration. The example does not become active until you commit the candidate configuration.

If the example configuration contains the top level of the hierarchy (or multiple hierarchies), the example is a *full example*. In this case, use the **load merge** command.

If the example configuration does not start at the top level of the hierarchy, the example is a *snippet*. In this case, use the **load merge relative** command. These procedures are described in the following sections.

Merging a Full Example

To merge a full example, follow these steps:

1. From the HTML or PDF version of the manual, copy a configuration example into a text file, save the file with a name, and copy the file to a directory on your routing platform.

For example, copy the following configuration to a file and name the file **ex-script.conf**. Copy the **ex-script.conf** file to the **/var/tmp** directory on your routing platform.

```
system {
  scripts {
    commit {
      file ex-script.xsl;
    }
  }
}
interfaces {
  fxp0 {
    disable;
    unit 0 {
      family inet {
        address 10.0.0.1/24;
      }
    }
  }
}
```

2. Merge the contents of the file into your routing platform configuration by issuing the **load merge** configuration mode command:

```
[edit]
user@host# load merge /var/tmp/ex-script.conf
load complete
```

Merging a Snippet

To merge a snippet, follow these steps:

1. From the HTML or PDF version of the manual, copy a configuration snippet into a text file, save the file with a name, and copy the file to a directory on your routing platform.

For example, copy the following snippet to a file and name the file **ex-script-snippet.conf**. Copy the **ex-script-snippet.conf** file to the **/var/tmp** directory on your routing platform.

```
commit {  
    file ex-script-snippet.xml; }
```

2. Move to the hierarchy level that is relevant for this snippet by issuing the following configuration mode command:

```
[edit]  
user@host# edit system scripts  
[edit system scripts]
```

3. Merge the contents of the file into your routing platform configuration by issuing the **load merge relative** configuration mode command:

```
[edit system scripts]  
user@host# load merge relative /var/tmp/ex-script-snippet.conf  
load complete
```

For more information about the **load** command, see [CLI Explorer](#).

Documentation Conventions

[Table 1 on page xv](#) defines notice icons used in this guide.

Table 1: Notice Icons







Icon	Meaning	Description
	Informational note	Indicates important features or instructions.
	Caution	Indicates a situation that might result in loss of data or hardware damage.
	Warning	Alerts you to the risk of personal injury or death.
	Laser warning	Alerts you to the risk of personal injury from a laser.
	Tip	Indicates helpful information.
	Best practice	Alerts you to a recommended use or implementation.

Table 2 on page xv defines the text and syntax conventions used in this guide.

Table 2: Text and Syntax Conventions

Convention	Description	Examples
Bold text like this	Represents text that you type.	To enter configuration mode, type the configure command: user@host> configure
Fixed-width text like this	Represents output that appears on the terminal screen.	user@host> show chassis alarms No alarms currently active
<i>Italic text like this</i>	<ul style="list-style-type: none"> Introduces or emphasizes important new terms. Identifies guide names. Identifies RFC and Internet draft titles. 	<ul style="list-style-type: none"> A policy <i>term</i> is a named structure that defines match conditions and actions. <i>Junos OS CLI User Guide</i> RFC 1997, <i>BGP Communities Attribute</i>

Table 2: Text and Syntax Conventions (*continued*)

Convention	Description	Examples
<i>Italic text like this</i>	Represents variables (options for which you substitute a value) in commands or configuration statements.	Configure the machine's domain name: [edit] root@# set system domain-name <i>domain-name</i>
Text like this	Represents names of configuration statements, commands, files, and directories; configuration hierarchy levels; or labels on routing platform components.	<ul style="list-style-type: none"> To configure a stub area, include the stub statement at the [edit protocols ospf area area-id] hierarchy level. The console port is labeled CONSOLE.
< > (angle brackets)	Encloses optional keywords or variables.	stub <default-metric <i>metric</i>>;
(pipe symbol)	Indicates a choice between the mutually exclusive keywords or variables on either side of the symbol. The set of choices is often enclosed in parentheses for clarity.	broadcast multicast (<i>string1</i> <i>string2</i> <i>string3</i>)
# (pound sign)	Indicates a comment specified on the same line as the configuration statement to which it applies.	rsvp { # Required for dynamic MPLS only
[] (square brackets)	Encloses a variable for which you can substitute one or more values.	community name members [<i>community-ids</i>]
Indentation and braces ({ })	Identifies a level in the configuration hierarchy.	[edit] routing-options { static { route default { nexthop <i>address</i> ; retain; } } }
;(semicolon)	Identifies a leaf statement at a configuration hierarchy level.	

GUI Conventions

Table 2: Text and Syntax Conventions (*continued*)

Convention	Description	Examples
Bold text like this	Represents graphical user interface (GUI) items you click or select.	<ul style="list-style-type: none"> • In the Logical Interfaces box, select All Interfaces. • To cancel the configuration, click Cancel.
> (bold right angle bracket)	Separates levels in a hierarchy of menu selections.	In the configuration editor hierarchy, select Protocols>Ospf .

Documentation Feedback

We encourage you to provide feedback so that we can improve our documentation. You can use either of the following methods:

- Online feedback system—Click TechLibrary Feedback, on the lower right of any page on the [Juniper Networks TechLibrary](#) site, and do one of the following:

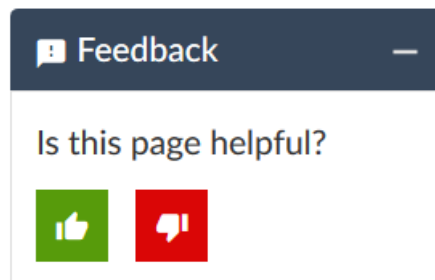

- Click the thumbs-up icon if the information on the page was helpful to you.
- Click the thumbs-down icon if the information on the page was not helpful to you or if you have suggestions for improvement, and use the pop-up form to provide feedback.
- E-mail—Send your comments to techpubs-comments@juniper.net. Include the document or topic name, URL or page number, and software version (if applicable).

Requesting Technical Support

Technical product support is available through the Juniper Networks Technical Assistance Center (JTAC). If you are a customer with an active Juniper Care or Partner Support Services support contract, or are

covered under warranty, and need post-sales technical support, you can access our tools and resources online or open a case with JTAC.

- JTAC policies—For a complete understanding of our JTAC procedures and policies, review the *JTAC User Guide* located at <https://www.juniper.net/us/en/local/pdf/resource-guides/7100059-en.pdf>.
- Product warranties—For product warranty information, visit <https://www.juniper.net/support/warranty/>.
- JTAC hours of operation—The JTAC centers have resources available 24 hours a day, 7 days a week, 365 days a year.

Self-Help Online Tools and Resources

For quick and easy problem resolution, Juniper Networks has designed an online self-service portal called the Customer Support Center (CSC) that provides you with the following features:

- Find CSC offerings: <https://www.juniper.net/customers/support/>
- Search for known bugs: <https://prsearch.juniper.net/>
- Find product documentation: <https://www.juniper.net/documentation/>
- Find solutions and answer questions using our Knowledge Base: <https://kb.juniper.net/>
- Download the latest versions of software and review release notes: <https://www.juniper.net/customers/csc/software/>
- Search technical bulletins for relevant hardware and software notifications: <https://kb.juniper.net/InfoCenter/>
- Join and participate in the Juniper Networks Community Forum: <https://www.juniper.net/company/communities/>
- Create a service request online: <https://myjuniper.juniper.net>

To verify service entitlement by product serial number, use our Serial Number Entitlement (SNE) Tool: <https://entitlementsearch.juniper.net/entitlementsearch/>

Creating a Service Request with JTAC

You can create a service request with JTAC on the Web or by telephone.

- Visit <https://myjuniper.juniper.net>.
- Call 1-888-314-JTAC (1-888-314-5822 toll-free in the USA, Canada, and Mexico).

For international or direct-dial options in countries without toll-free numbers, see <https://support.juniper.net/support/requesting-support/>.

1

PART

Overview

SRX Series Services Gateway Interface Modules Support | 2

Network Interface Specifications | 19

SRX Series Services Gateway Interface Modules Support

IN THIS CHAPTER

- [SRX Series Services Gateway Interface Overview | 2](#)
- [Supported SRX Series Services Gateway Interfaces | 5](#)
- [SRX Series Services Gateway Mini-Physical Interface Modules Overview | 6](#)
- [SRX Series Services Gateway Gigabit-Backplane Physical Interface Modules Overview | 8](#)
- [SRX Series Services Gateway Interface Modules and Compatibility | 11](#)
- [MTU Default and Maximum Values for Physical Interface Modules | 12](#)
- [Power over Ethernet Support on SRX Series Services Gateway Interfaces | 15](#)
- [SRX Series Services Gateway Interfaces Power and Heat Requirements | 17](#)

SRX Series Services Gateway Interface Overview

Mini-Physical Interface Modules (Mini-PIMs) and Gigabit-Backplane Physical Interface Modules (GPIMs) are field-replaceable network interface cards (NICs) supported on the Juniper Networks SRX Series Services Gateway for the branch. You can easily insert or remove Mini-PIMs and GPIMs from the front slots of the SRX Series Services Gateway chassis. The Mini-PIMs and GPIMs provide physical connections to a LAN or a WAN. The Mini-PIMs and GPIMs receive incoming packets from the network and transmit outgoing packets to the network. During this process, they perform framing and line-speed signaling for the medium type. The SRX Series Services Gateways run Junos OS.



CAUTION: The Mini-PIMs available on the SRX Series Services Gateway are not hot-swappable. You must power off the services gateway before removing or installing Mini-PIMs.

NOTE: Only the SRX650 Services Gateway supports hot-swappable functionality for GPIMs. The SRX550 Services Gateway does not support hot-swappable functionality for GPIMs.

Interfaces Port Naming Conventions SRX Series Services Gateways

When configuring a port on a Mini-Physical Interface Module (Mini-PIM) or Gigabit-Backplane Physical Interface Module (GPIM), you must know the slot and port number assigned to the Mini-PIM or GPIM. The slot number identifies the slot on the services gateway in which you insert the Mini-PIM or GPIM, and is typically named 1, 2, 3, and so on. The port number is the port on the Mini-PIM or GPIM that is being configured.

The name of each network interface has the following format to identify the physical device that corresponds to a single physical network connector:

type-slot/pim/port

For SRX Series Services Gateways, *pim* equals 0 for the port-naming convention.

[Table 3 on page 3](#) lists the typical interface types and interface numbers.

Table 3: SRX Series Services Gateway Interface Port Number Examples

Interface Type	Interface Number Example
ATM-over-ADSL	at-1/0/0
G.SHDSL	at-1/0/0
T1	t1-1/0/0
E1	e1-1/0/0
1-Port SFP	ge-1/0/0
1-Port Gigabit Ethernet SFP	ge-1/0/0
Serial	se-1/0/0
DOCSIS	cm-1/0/0
VDSL2	pt-1/0/0
1-Port Clear Channel DS3/E3 GPIM	t3-3/0/0

Table 3: SRX Series Services Gateway Interface Port Number Examples (*continued*)

Interface Type	Interface Number Example
8-Port Serial GPIM	se-1/0/0 through se-1/0/7
8-Port Gigabit Ethernet small form-factor pluggable (SFP) XPIM	<p data-bbox="846 411 1146 438">ge-3/0/0 through ge-3/0/7</p> <p data-bbox="846 474 1421 537">NOTE: The SRX550 and the SRX650 Services Gateways have high gigabit and non-high gigabit slots.</p> <ul data-bbox="846 573 1421 716" style="list-style-type: none"> <li data-bbox="846 573 1421 636">• In the high gigabit slot, you can achieve a maximum bandwidth of 8 gigabits. <li data-bbox="846 653 1421 716">• In the non-high gigabit slot, you can achieve a maximum bandwidth of 1 gigabit.
16-Port Gigabit Ethernet XPIM	<ul data-bbox="846 764 1078 837" style="list-style-type: none"> <li data-bbox="846 764 1078 791">• SRX550—ge-3/0/0 <li data-bbox="846 808 1078 837">• SRX650—ge-2/0/0 <p data-bbox="846 873 1421 972">NOTE: When installing the 16-Port Gigabit Ethernet XPIM, which uses 2 slots, you must install it in the 10-Gigabit or 20-Gigabit GPIM slots:</p> <ul data-bbox="846 1008 1421 1299" style="list-style-type: none"> <li data-bbox="846 1008 1421 1150">• SRX550 Services Gateway—Slots 3 and 6, which refer to the right side bottom two standard slots (slots 3 and 4) and the right side top two standard slots (6 and 8). <li data-bbox="846 1167 1421 1299">• SRX650 Services Gateway—Slots 2 and 6, which refer to the bottom four standard slots (slots 1, 2, 3, and 4), and the top four standard slots (slots 5, 6, 7, and 8).
24-Port Gigabit Ethernet XPIM	<ul data-bbox="846 1348 1078 1421" style="list-style-type: none"> <li data-bbox="846 1348 1078 1375">• SRX550—ge-6/0/0 <li data-bbox="846 1392 1078 1421">• SRX650—ge-2/0/0 <p data-bbox="846 1457 1421 1556">NOTE: When installing the 24-Port Gigabit Ethernet XPIM, which uses 4 slots, you must install it in the 20-Gigabit GPIM slots:</p> <ul data-bbox="846 1591 1421 1665" style="list-style-type: none"> <li data-bbox="846 1591 1421 1619">• SRX550 Services Gateway—Slot 6. <li data-bbox="846 1635 1421 1665">• SRX650 Services Gateway—Slots 2 and 6.

Table 3: SRX Series Services Gateway Interface Port Number Examples (continued)

Interface Type	Interface Number Example
2-Port 10-Gigabit Ethernet XPIM	<ul style="list-style-type: none"> • SRX550 Services Gateway—xe-3/0/0 • SRX650 Services Gateway—xe-2/0/0, xe-2/0/1, or xe-6/0/0, xe-6/0/1 <p>NOTE: Represents two fiber and two copper ports; user configured. Must be installed in one of the following GPIM slots:</p> <ul style="list-style-type: none"> • SRX550 Services Gateway—Slot 3 for 10-Gigabit GPIM and slot 6 for 20-Gigabit GPIM. • SRX650 Services Gateway—Slots 2 or 6.
Dual CT1/E1 GPIM	ct1-1/0/0 ce1-1/0/0
Quad CT1/E1 GPIM	ct1-1/0/0 ce1-1/0/0

RELATED DOCUMENTATION

[SRX Series Services Gateway Mini-Physical Interface Modules Overview | 6](#)

[SRX Series Services Gateway Gigabit-Backplane Physical Interface Modules Overview | 8](#)

[Supported SRX Series Services Gateway Interfaces | 5](#)

Supported SRX Series Services Gateway Interfaces

The SRX Series Services Gateways support the following Mini-Physical Interface Modules (Mini-PIMs):

- 1-Port Small Form-Factor Pluggable (SFP)
- 1-Port Gigabit Ethernet Small Form-Factor Pluggable (SFP)
- ADSL2+
- DOCSIS
- G.SHDSL
- Serial

- T1/E1
- VDSL2

The SRX Series Services Gateways support the following Gigabit-Backplane Physical Interface Modules (GPIMs/XPIMs):

- Dual CT1/E1 GPIM
- Quad CT1/E1 GPIM
- 1-Port Clear Channel DS3/E3 GPIM
- 8-Port Serial GPIM
- 2-Port 10 Gigabit Ethernet XPIM
- 8-Port Gigabit Ethernet SFP XPIM
- 16-Port Gigabit Ethernet XPIM
- 16-Port Gigabit Ethernet XPIM (with PoE)
- 24-Port Gigabit Ethernet XPIM
- 24-Port Gigabit Ethernet XPIM (with PoE)

RELATED DOCUMENTATION

[SRX Series Services Gateway Mini-Physical Interface Modules Overview | 6](#)

[SRX Series Services Gateway Gigabit-Backplane Physical Interface Modules Overview | 8](#)

[SRX Series Services Gateway Interface Modules and Compatibility | 11](#)

SRX Series Services Gateway Mini-Physical Interface Modules Overview

A Mini-Physical Interface Module (Mini-PIM) is a network interface card (NIC) that is installed on the SRX Series Services Gateway to provide physical connections to a LAN or a WAN. The Mini-PIM receives incoming packets from the network and transmits outgoing packets to the network.

[Table 4 on page 6](#) lists the Mini-PIMs and their model numbers.

Table 4: SRX Series Services Gateway Mini-PIMs Model Numbers

Mini-PIMs	Model Numbers
1-Port small form-factor pluggable (SFP) Mini-PIM	SRX-MP-1SFP (EOL)

Table 4: SRX Series Services Gateway Mini-PIMs Model Numbers (continued)

Mini-PIMs	Model Numbers
1-Port Gigabit Ethernet small form-factor pluggable (SFP)	SRX-MP-1SFP-GE
ADSL2+ Mini-PIM	SRX-MP-1ADSL2-A (Annex A) (EOL) SRX-MP-1ADSL2-B (Annex B) (EOL)
DOCSIS Mini-PIM	SRX-MP-1DOCSIS3 (EOL)
G.SHDSL Mini-PIM	SRX-MP-8GSHDSL (EOL)
Serial Mini-PIM	SRX-MP-1Serial (EOL)
T1/E1 Mini-PIM	SRX-MP-1T1E1 (EOL)
VDSL2 Mini-PIM	SRX-MP-1VDSL2-A (Annex A) (EOL)

The Mini-PIMs supported on the SRX Series Services Gateway are field-replaceable. You can install a Mini-PIM in the Mini-PIM slot on the front panel of the services gateway chassis.



CAUTION: The Mini-PIMs available on the SRX Series Services Gateway are not hot-swappable. You must power off the services gateway before removing or installing Mini-PIMs.

RELATED DOCUMENTATION

[Supported SRX Series Services Gateway Interfaces | 5](#)

[SRX Series Services Gateway Interface Modules and Compatibility | 11](#)

[SRX Series Services Gateway Interfaces Power and Heat Requirements | 17](#)

SRX Series Services Gateway Gigabit-Backplane Physical Interface Modules Overview

A Gigabit-Backplane Physical Interface Module (GPIM) is a network interface card (NIC) that installs in the front slots of the SRX550 or SRX650 Services Gateway to provide physical connections to a LAN or a WAN. The GPIM receives incoming packets from a network and transmits outgoing packets to a network. These modules complement the onboard Ethernet interfaces to extend the types and port counts of network connections for the LAN or WAN.

Interface module terminology:

- GPIM—Network interface card (NIC) that installs in a single-high, single-wide GPIM front slots of the SRX550 Services Gateway and the SRX650 Services Gateway that have Gigabit connectivity to the system backplane.
- XPIM—Can be installed in:
 - SRX550 Services Gateway—only in the 10-Gigabit GPIM slot 3 or in the 20-Gigabit GPIM slot 6 on the front panel
 - SRX650 Services Gateway—only in the 20-Gigabit GPIM slots (slots 2 and 6 on the front panel)

The GPIMs can have one of the following configurations:

- Single-high, single-wide LAN switch GPIM that uses one slot
- Double-high, single-wide LAN switch GPIM that uses two standard slots vertically
- Double-high, double-wide LAN switch GPIM that uses two standard slots vertically and two standard slots horizontally

NOTE: When installing the 24-Port Gigabit Ethernet XPIM, which uses four slots, you must install it in the 20-Gigabit GPIM slots:

- SRX550 Services Gateway—Slot 6 among the top four standard slots (slots 5 through 8).
- SRX650 Services Gateway—Slot 2 among the bottom four standard slots (slots 1 through 4), and slot 6 among the top four standard slots (slots 5 through 8).

Table 5 on page 8 lists the GPIMs and XPIMs and their respective model numbers.

Table 5: SRX Series Services Gateway GPIM/XPIM Model Numbers

GPIM or XPIM	Model Number
Dual CT1/E1 GPIM	SRX-GP-DUAL-T1-E1

Table 5: SRX Series Services Gateway GPIM/XPIM Model Numbers (continued)

GPIM or XPIM	Model Number
Quad CT1/E1 GPIM	SRX-GP-QUAD-T1-E1
1-Port Clear Channel DS3/E3 GPIM	SRX-GP-1DS3-E3 (EOL)
8-Port Serial GPIM	SRX-GP-8SERIAL (EOL)
2-Port 10-Gigabit Ethernet XPIM	SRX-GP-2XE-SFPP-TX (EOL)
8-Port Gigabit Ethernet SFP XPIM	SRX-GP-8SFP
16-Port Gigabit Ethernet XPIM	SRX-GP-16GE (EOL)
16-Port Gigabit Ethernet XPIM (with PoE)	SRX-GP-16GE-POE
24-Port Gigabit Ethernet XPIM	SRX-GP-24GE (EOL)
24-Port Gigabit Ethernet XPIM (with PoE)	SRX-GP-24GE-POE (EOL)

Figure 1 on page 9 shows how the slots on the front panel of the SRX550 Services Gateway are numbered. Slots 1 and 2 are for Mini-PIMs, and slots 3 through 8 are for GPIMs.

Figure 1: SRX550 Services Gateway Slot Numbers

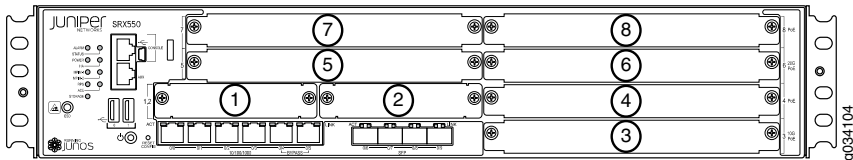
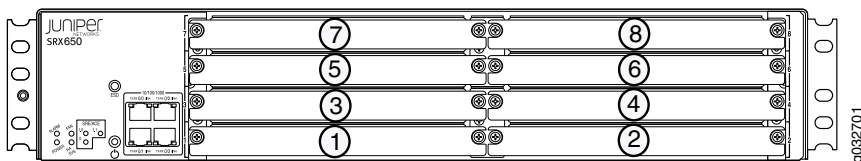

Figure 2 on page 9 shows how the slots on the front panel of the SRX650 Services Gateway are numbered. Slots 1 through 8 are for GPIMs.

Figure 2: SRX650 Services Gateway Slot Numbers



NOTE: Only the SRX650 Services Gateway supports hot-swappable functionality for GPIMs. Because the services gateway GPIMs communicate with the backplane at various performance levels, you must install them in the correct slots.

Figure 3 on page 10, Figure 4 on page 10, and Figure 5 on page 10 show the three form factors for the services gateway GPIMs.

Figure 3: Example of a Standard GPIM (Installs in One Standard Slot)

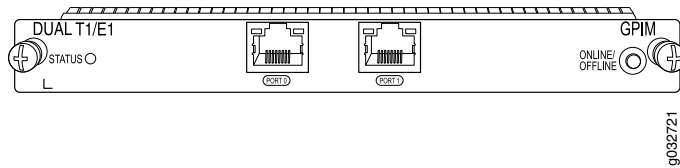

Figure 4: Example of a Double-High, Single-Wide XPIM

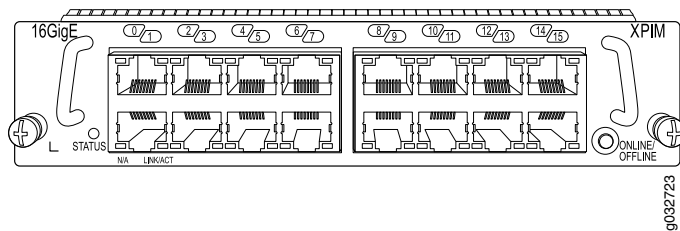
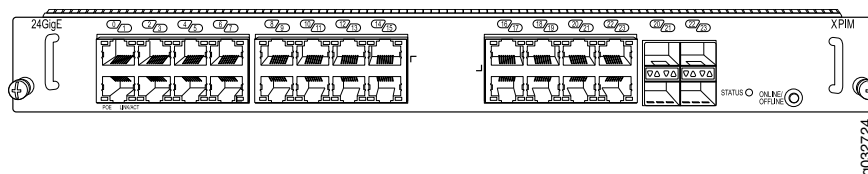

Figure 5: Example of a Double-High, Double-Wide XPIM



RELATED DOCUMENTATION

[Required Tools and Parts for Replacing a Gigabit-Backplane Physical Interface Module | 243](#)

[Removing a Blank Gigabit-Backplane Physical Interface Module Faceplate from the SRX Series Services Gateway | 253](#)

[Installing a Gigabit-Backplane Physical Interface Module on the SRX Series Services Gateway | 253](#)

[Installing a Double-High, Double-Wide Gigabit-Backplane Physical Interface Module on the SRX Series Services Gateway | 256](#)

SRX Series Services Gateway Interface Modules and Compatibility

Table 6 on page 11 shows the types of Mini-Physical Interface Modules (Mini-PIMs) with the SRX Series devices and the Junos OS releases that support them.

Table 6: Mini-PIM Types and Hardware Platform Compatibility

Name	Supported Platforms and the First Junos OS Release Supported			
	SRX210	SRX220	SRX240	SRX550
1-Port small form-factor pluggable (SFP)	Junos OS Release 9.4	Not Supported	Junos OS Release 9.4	Not Supported
1-Port Gigabit Ethernet small form-factor pluggable (SFP)	Junos OS Release 10.4	Junos OS Release 10.4	Junos OS Release 10.4	Junos OS Release 12.1
ADSL2+	Junos OS Release 9.5	Junos OS Release 10.3	Junos OS Release 9.5	Junos OS Release 12.1
DOCSIS	Junos OS Release 10.1	Junos OS Release 10.3	Junos OS Release 10.1	Junos OS Release 12.1
G.SHDSL	Junos OS Release 10.0	Junos OS Release 10.3	Junos OS Release 10.0	Junos OS Release 12.1
Serial	Junos OS Release 9.5	Junos OS Release 10.3	Junos OS Release 9.5	Junos OS Release 12.1
T1/E1	Junos OS Release 9.4	Junos OS Release 10.3	Junos OS Release 9.4	Junos OS Release 12.1
VDSL2	Junos OS Release 10.1	Junos OS Release 10.3	Junos OS Release 10.1	Junos OS Release 12.1

Table 7 on page 12 shows the types of Gigabit-Backplane Physical Interface Modules (GPIMs and XPIMs), along with the SRX Series devices and the Junos OS Releases that support them.

Table 7: GPIM and XPIM Types and Hardware Platform Compatibility

Type	Name	First Junos OS Release	
		SRX650	SRX550
GPIMs	Dual CT1/E1	Junos OS Release 9.5	Junos OS Release 12.1
	Quad CT1/E1	Junos OS Release 9.5	Junos OS Release 12.1
	1-Port Clear Channel DS3/E3	Junos OS Release 11.1	Junos OS Release 12.1
	8-Port Serial	Junos OS Release 12.1	Junos OS Release 12.1
XPIMs (10 Gigabit Ethernet GPIM)	8-Port Gigabit Ethernet SFP	Junos OS Release 12.1x44-D10	Junos OS Release 12.1x44-D10
	16-Port Gigabit Ethernet	Junos OS Release 9.5	Junos OS Release 12.1
	24-Port Gigabit Ethernet	Junos OS Release 9.5	Junos OS Release 12.1
	2-Port 10- Gigabit Ethernet	Junos OS Release 10.2	Junos OS Release 12.1

NOTE: All Mini-PIMs and GPIMs require Junos OS.

RELATED DOCUMENTATION

[SRX Series Services Gateway Mini-Physical Interface Modules Overview | 6](#)

[SRX Series Services Gateway Gigabit-Backplane Physical Interface Modules Overview | 8](#)

[Supported SRX Series Services Gateway Interfaces | 5](#)

[SRX Series Services Gateway Interfaces Power and Heat Requirements | 17](#)

MTU Default and Maximum Values for Physical Interface Modules

Table 8 on page 13 lists maximum transmission unit (MTU) values for the SRX Series Services Gateways Physical Interface Modules (PIMs).

Table 8: MTU Values for the SRX Series Services Gateways PIMs

PIM	Physical Interface MTU (Bytes)-Default	Logical Interface MTU (Bytes)-Default	Maximum MTU (Bytes)
1-Port Gigabit Ethernet small form-factor pluggable (SFP) Mini-PIM	1514	1500	9010
1-Port small form-factor pluggable (SFP) Mini-PIM	1514	1500	1518
DOCSIS Mini-PIM	1504	1500	1504
Serial Mini-PIM	1504	1500	2000
T1/E1 Mini-PIM	1504	1500	2000
Dual CT1/E1 GPIM	1504	1500	9000
Quad CT1/E1 GPIM	1504	1500	9000
8-Port Serial GPIM	1504	1500	9192
1-Port Clear Channel DS3/E3 GPIM	1504	1500	9192
2-Port 10 Gigabit Ethernet XPIM	1514	1500	9192
8-Port Gigabit Ethernet Small Form-Factor Pluggable (SFP) XPIM	1514	1500	9192
16-Port Gigabit Ethernet XPIM	1514	1500	9192
24-Port Gigabit Ethernet XPIM	1514	1500	9192
ADSL2+ Mini-PIM (Encapsulation)			
atm-snap	1512	1504	1512
atm-vcmux	1512	1512	1512

atm-nlpid	1512	1508	1512
atm-cisco-nlpid	1512	1510	1512
ether-over-atm-llc	1512	1488	1512
atm-ppp-llc	1512	1506	1512
atm-ppp-vcmux	1512	1510	1512
atm-mlppp-llc	1512	1500	1512
ppp-over-ether-over-atm-llc	1512	1480	1512

VDSL- Mini-PIM AT mode (Encapsulation)

atm-snap	1514	1506	1514
atm-vcmux	1514	1514	1514
atm-nlpid	1514	1510	1514
atm-cisco-nlpid	1514	1512	1514
ether-over-atm-llc	1514	1490	1524
atm-ppp-llc	1514	1508	1514
atm-ppp-vcmux	1514	1512	1514
atm-mlppp-llc	1514	1500	1514
ppp-over-ether-over-atm-llc	1514	1482	1514

VDSL- Mini-PIM PT mode	1514	1500	1514
------------------------	------	------	------

G.SHDSL Mini-PIM (Encapsulation)

atm-snap	4482	4470	4482
-----------------	------	------	------

atm-vcmux	4482	4470	4482
atm-nlpid	4482	4470	4482
atm-cisco-nlpid	4482	4470	4482
ether-over-atm-llc	4482	1500	4482
atm-ppp-llc	4482	4476	4482
atm-ppp-vcmux	4482	4480	4482
atm-mlppp-llc	4482	1500	4482
ppp-over-ether-over-atm-llc	4482	1492	4482

RELATED DOCUMENTATION

[SRX Series Services Gateway Mini-Physical Interface Modules Overview | 6](#)

[Supported SRX Series Services Gateway Interfaces | 5](#)

[SRX Series Services Gateway Interface Modules and Compatibility | 11](#)

Power over Ethernet Support on SRX Series Services Gateway Interfaces

Power over Ethernet (PoE) supports the implementation of the IEEE 802.3 af and IEEE 802.3 at standards, which allow both data and electric power to pass over a copper Ethernet LAN cable.

The SRX550 and SRX650 Services Gateways provide PoE ports, which supply electric power over the same ports that are used for connecting network devices. PoE ports allow you to plug in devices that require both network connectivity and electric power, such as voice over IP (VoIP) and IP phones and wireless access points.

The PoE ports for the SRX550 and SRX650 Services Gateway reside on the individual XPIMs. The services gateway supports the following XPIMs with PoE:

- 16-Port Gigabit Ethernet XPIM
- 24-Port Gigabit Ethernet XPIM

The active Services and Routing Engine (SRE) manages the overall system PoE power. You can configure the services gateway to act as power sourcing equipment to supply the power to the GPIMs connected on the designated PoE ports.

[Table 9 on page 16](#) lists the SRX550 and SRX650 Services Gateway PoE specifications.

Table 9: SRX550 and SRX650 Services Gateway PoE Specifications

Power Management Schemes	Values
Supported standards	<ul style="list-style-type: none"> • IEEE 802.3 af • IEEE 802.3 at • Legacy
Supported slots	<p>PoE is supported on the following front panel slots:</p> <ul style="list-style-type: none"> • SRX550 Services Gateway—Slots 3,4,6,8 • SRX650 Services Gateway—Slots 2,4,6,8
Total PoE power sourcing capacity	<p>The 645 W AC and 645 W DC power supplies support the following capacities:</p> <ul style="list-style-type: none"> • 255 W with PoE on a single power supply, or with redundancy using the two-power-supply option • 510 W with PoE using the two-power-supply option operating as nonredundant
Per-port power limit	31.2 W
Power management modes	<ul style="list-style-type: none"> • Static: Power allocation for each interface can be configured. • Class: Power for interfaces is allocated based on the class of the powered device connected.

RELATED DOCUMENTATION

[SRX Series Services Gateway Gigabit-Backplane Physical Interface Modules Overview | 8](#)

[16-Port Gigabit Ethernet XPIM Overview | 104](#)

[24-Port Gigabit Ethernet XPIM Overview | 111](#)

[Installing a Gigabit-Backplane Physical Interface Module on the SRX Series Services Gateway | 253](#)

[Installing a Double-High, Double-Wide Gigabit-Backplane Physical Interface Module on the SRX Series Services Gateway | 256](#)

SRX Series Services Gateway Interfaces Power and Heat Requirements

Table 10 on page 17 shows the power consumption value of each Physical Interface Module (PIM).

Table 10: PIM Power Consumption Values

PIM Model	Power Consumption (Watts)
1-Port small form-factor pluggable (SFP) Mini-PIM	4.29
1-Port Gigabit Ethernet small form-factor pluggable (SFP) Mini-PIM	4.4
ADSL2+ Mini-PIM	4.11
DOCSIS Mini-PIM	7.00
G.SHDSL Mini-PIM	8.31
Serial Mini-PIM	4.29
T1/E1 Mini-PIM	1.92
VDSL2 Mini-PIM	9.80
Dual CT1/E1 GPIM	16.81
Quad CT1/E1 GPIM	16.81
8-Port Serial GPIM	13.1
1-Port Clear Channel DS3/E3 GPIM	22.89
2-Port 10 Gigabit Ethernet XPIM	20
8-Port Gigabit Ethernet SFP XPIM	22
16-Port Gigabit Ethernet XPIM	40 (without PoE)
24-Port Gigabit Ethernet XPIM	40 (without PoE)

RELATED DOCUMENTATION

[SRX Series Services Gateway Mini-Physical Interface Modules Overview](#) | 6

SRX Series Services Gateway Gigabit-Backplane Physical Interface Modules Overview | 8

Supported SRX Series Services Gateway Interfaces | 5

SRX Series Services Gateway Interface Modules and Compatibility | 11

Network Interface Specifications

IN THIS CHAPTER

- 1-Port Gigabit Ethernet SFP Mini-Physical Interface Module Network Interface Specifications | 19
- 1-Port SFP Mini-Physical Interface Module Network Interface Specifications | 20
- 1-Port ADSL2+ Mini-Physical Interface Module Network Interface Specifications | 21
- 1-Port DOCSIS Mini-Physical Interface Module Network Interface Specifications | 22
- 1-Port T1/E1 Mini-Physical Interface Module Network Interface Specifications | 23
- 1-Port Clear Channel DS3/E3 GPIM Network Interface Specifications | 25
- 8-Port Gigabit Ethernet SFP XPIM Network Interface Specifications | 26
- 8-Port Serial GPIM Interface Specifications | 27
- Dual CT1/E1 GPIM Network Interface Specifications | 29
- Quad CT1/E1 GPIM Network Interface Specifications | 30

1-Port Gigabit Ethernet SFP Mini-Physical Interface Module Network Interface Specifications

Table 11 on page 19 gives the network interface specifications of the 1-Port Gigabit Ethernet Small Form-Factor Pluggable Mini-Physical Interface Module (SFP Mini-PIM).

Table 11: 1-Port Gigabit Ethernet SFP Mini-PIM Network Interface Specifications

Specification	1-Port Gigabit Ethernet SFP Mini-PIM
Operating modes	Full-duplex and half-duplex
Operating speed	10/100/1000 Mbps
VLAN support	802.1q virtual LANs
Class-of-service support	Supported
Encapsulations	DIX, LLC/SNAP, CCC, TCC, and VLAN-CCC

Table 11: 1-Port Gigabit Ethernet SFP Mini-PIM Network Interface Specifications (continued)

Specification	1-Port Gigabit Ethernet SFP Mini-PIM
Loopback diagnostic feature	Supported
Autonegotiation	Supported

RELATED DOCUMENTATION

[1-Port Gigabit Ethernet SFP Mini-Physical Interface Module Overview | 33](#)

[1-Port Gigabit Ethernet SFP Mini-Physical Interface Module Hardware Specifications | 35](#)

[1-Port Gigabit Ethernet SFP Mini-Physical Interface Module Key Features | 34](#)

[1-Port Gigabit Ethernet SFP Mini-Physical Interface Module Supported Modules | 36](#)

[1-Port Gigabit Ethernet SFP Mini-Physical Interface Module LEDs | 35](#)

[1-Port Gigabit Ethernet SFP Mini-Physical Interface Module Basic Configuration | 196](#)

1-Port SFP Mini-Physical Interface Module Network Interface Specifications

Table 12 on page 20 gives the network interface specifications of the 1-Port Small Form-Factor Pluggable Mini-Physical Interface Module (SFP Mini-PIM).

Table 12: 1-Port SFP Mini-PIM Network Interface Specifications

Specifications	1-Port SFP Specification
Operating modes	Full-duplex and half-duplex
VLAN support	802.1q virtual LANs
Class-of-service support	Supported
Encapsulations	DIX, LLC/SNAP, CCC, TCC, and VLAN-CCC
Loopback diagnostic feature	Supported

RELATED DOCUMENTATION

1-Port SFP Mini-Physical Interface Module Overview	39
1-Port SFP Mini-Physical Interface Module Hardware Specifications	41
MTU Default and Maximum Values for Physical Interface Modules	12
1-Port SFP Mini-Physical Interface Module Supported Modules	42
1-Port SFP Mini-Physical Interface Module Key Features	40
1-Port SFP Mini-Physical Interface Module LEDs	42
1-Port SFP Mini-Physical Interface Module Basic Configuration	199

1-Port ADSL2+ Mini-Physical Interface Module Network Interface Specifications

Table 13 on page 21 lists the 1-Port ADSL2+ Mini-Physical Interface Module (Mini-PIM) network interface specifications.

Table 13: 1-Port ADSL2+ Mini-PIM Network Interface Specifications

Specifications	Values
Supported operating modes	<p>ANNEX-A</p> <ul style="list-style-type: none"> • Auto • ANSI-DMT(ANSI T1.413) • ITU-DMT(G.992.1) • ITU-DMT-BIS (G.992.3) • ADSL2+(G.992.5) <p>ANNEX-B</p> <ul style="list-style-type: none"> • Auto • ITU-DMT(G.992.1) • ITU-DMT-BIS (G.992.3) • ADSL2+(G.992.5) • ITU-ANNEXB-UR2 <p>ANNEX-M</p> <ul style="list-style-type: none"> • ITU-DMT-BIS (G.992.3) • ADSL2+(G.992.5)

Table 13: 1-Port ADSL2+ Mini-PIM Network Interface Specifications (*continued*)

Specifications	Values
Supported maximum speed	<ul style="list-style-type: none"> • For ANSI DMT, 8 Mbps downstream and 896 Kbps upstream • For G.992.1, 8 Mbps downstream and 1.2 Mbps upstream • For G.992.3, 12 Mbps (Annex A) or 10 Mbps (Annex B) downstream and 1.2 Mbps Upstream • For G.992.5, 24 Mbps downstream and 1.2 Mbps upstream
Supported ATM QoS	<ul style="list-style-type: none"> • CBR • VBR • RTVBR
Supported encapsulation	<ul style="list-style-type: none"> • ATM-PVC • Ethernet-over-ATM

RELATED DOCUMENTATION

[1-Port ADSL2+ Mini-Physical Interface Module Overview | 45](#)

[1-Port ADSL2+ Mini-Physical Interface Module Hardware Specifications | 47](#)

[MTU Default and Maximum Values for Physical Interface Modules | 12](#)

[1-Port ADSL2+ Mini-Physical Interface Module Supported Standards | 48](#)

[1-Port ADSL2+ Mini-Physical Interface Module Key Features | 46](#)

[1-Port ADSL2+ Mini-Physical Interface Module LEDs | 48](#)

[1-Port ADSL2+ Mini-Physical Interface Module Supported Loopback Diagnostics | 49](#)

[1-Port ADSL2+ Mini-Physical Interface Module Basic Configuration | 201](#)

1-Port DOCSIS Mini-Physical Interface Module Network Interface Specifications

Table 14 on page 23 provides the network interface properties of the Data over Cable System Interface Specifications Mini-Physical Interface Module (1-Port DOCSIS Mini-PIM).

Table 14: 1-Port DOCSIS Mini-PIM Network Interface Properties

Specifications	Downstream	Upstream
Modulation	64 or 256 quadrature amplitude modulation (QAM)	Quadrature Phase Shift Keying (QPSK) and 8, 16, 32, 64, 128 QAM
Bandwidth	6 MHz (US)	200 kHz, 400 kHz, 800 kHz, 1.6 MHz, 3.2 MHz, 6.4 MHz
Symbol rate	64 QAM 5.057 Msym/s, 256 QAM 5.361 Msym/s	160, 320, 640, 1280, 2560, and 5120 ksym/s
Operating level range	-15 to +15 dBmV	A-TDMA +8 to +54 dBmV (32 QAM, 64 QAM); +8 to +55 dBmV (8 QAM, 16 QAM); +8 to +58 dBmV (QPSK); S-CDMA +8 to +53 dBmV (all modulations)
Input impedance	75Ω (nominal)	75Ω (nominal)
Frequency range	108 to 1002 MHz (edge to edge)	5 to 42 MHz (US)
Channel bonding	Up to 4 channels	Up to 4 channels

RELATED DOCUMENTATION

[1-Port DOCSIS Mini-Physical Interface Module Overview | 51](#)

[1-Port DOCSIS Mini-Physical Interface Module Key Features | 52](#)

[1-Port DOCSIS Mini-Physical Interface Module Supported Standards | 55](#)

[1-Port DOCSIS Mini-Physical Interface Module Hardware Specifications | 53](#)

[1-Port DOCSIS Mini-Physical Interface Module Basic Configuration | 204](#)

1-Port T1/E1 Mini-Physical Interface Module Network Interface Specifications

The 1-Port T1/E1 Mini-Physical Interface Module (Mini-PIM) has the network interface specifications given in [Table 15 on page 24](#).

Table 15: 1-Port T1/E1 Mini-PIM Network Interface Specifications

Specification	T1 Specification	E1 Specifications
Network interface specifications		
Transmit bit rate	1.544 Mbps	2.048 Mbps
Receive bit rate	1.544 Mbps	2.048 Mbps
Line encoding	AMI/B8ZS	HDB3
Mode	Framed Clear Channel	Framed Clear Channel, Unframed Clear Channel
Fractional Framing	Superframe (D4/SF), Extended Superframe (ESF)	G704 without CRC4 Unframed
HDLC features		
N x 64 Kbps or N x 56 Kbps, nonchannelized data rates	(T1:N=1 to 24)	(E1:N=1 to 31)
CRC	16/32	16/32
Shared Flag	Supported	Supported
Idle flag/fill	Supported	Supported
Counters:	Runts, Giants, FCS, Error, Abort Error, Align Error	Runts, Giants, FCS, Error, Abort Error, Align Error

RELATED DOCUMENTATION

[1-Port T1/E1 Mini-Physical Interface Module Overview | 66](#)

[1-Port T1/E1 Mini-Physical Interface Module Hardware Specifications | 67](#)

[1-Port T1/E1 Mini-Physical Interface Module Supported Standards | 69](#)

[1-Port T1/E1 Mini-Physical Interface Module Key Features | 67](#)

[1-Port T1/E1 Mini-Physical Interface Module LEDs | 68](#)

[1-Port T1/E1 Mini-Physical Interface Module Supported Loopback Diagnostics | 70](#)

[1-Port T1/E1 Mini-Physical Interface Module Basic Configuration | 209](#)

1-Port Clear Channel DS3/E3 GPIM Network Interface Specifications

The 1-Port Clear Channel DS3/E3 Gigabit-Backplane Physical Interface Module (GPIM) provides the network interface specifications for DS3 or E3 modes, listed in [Table 16 on page 25](#).

Table 16: 1-Port Clear Channel DS3/E3 GPIM Network Interface Specifications

Description	DS3 Mode	E3 Mode
Network Interface Specifications		
Line encoding	B3ZS	HDB3
Framing	<ul style="list-style-type: none"> • M23 (default) • C-bit 	G.751 (default)
Substrate and scrambling	Vendor algorithms supported: <ul style="list-style-type: none"> • Verilink • Kentrox • Digital Link • Larscom • Adtran 	Vendor algorithms supported: <ul style="list-style-type: none"> • Kentrox • Digital Link
Network alarms	Supported in accordance with the ANSI specification: <ul style="list-style-type: none"> • Loss of Signal (LOS) • Out of Frame (OOF) • Loss of Frame (LOF) • Alarm Identification Signal (AIS) • Remote Defect Identification (RDI) 	Supported in accordance with the ITU-T specification: <ul style="list-style-type: none"> • LOS • OOF • AIS • RDI • Phase Locked Loop (PLL)

Table 16: 1-Port Clear Channel DS3/E3 GPIM Network Interface Specifications (*continued*)

Description	DS3 Mode	E3 Mode
Error counters	Incremented during a periodic 1-second polling routine: <ul style="list-style-type: none"> • Line Code Violations (LCV) • P-bit Code Violations (PCV) • C-bit Code Violations (CCV) • Line Errored Seconds (LES) • P-bit Errored Seconds (PES) • C-bit Errored Seconds (CES) • Severely Errored Framing Seconds (SEFS) • P-bit Severely Errored Seconds (PSES) • C-bit Severely Errored Seconds (CSES) • Unavailable Seconds (UAS) 	Incremented during a periodic 1-second polling routine: <ul style="list-style-type: none"> • Frame Alignment Error (FAE) • Bipolar Coding Violations (BCV) • Excessive Zeros (EXZ) • LCV • LES • SEFS • UAS
HDLC Features		
MTU	Default (4474 bytes) or maximum jumbo (up to 9192 bytes)	Default (4474 bytes) or maximum jumbo (up to 9192 bytes)
Shared flag	Supported	Supported
Idle flag/fill (0x7e or all ones)	Supported	Supported
Counters	Runts, giants	Runts, giants

8-Port Gigabit Ethernet SFP XPIM Network Interface Specifications

Table 17 on page 26 gives the network interface specifications of the 8-Port Gigabit Ethernet small form-factor pluggable XPIM (SFP XPIM).

Table 17: 8-Port Gigabit Ethernet SFP XPIM Network Interface Specifications

Network Interface Specification	Value
Operating modes	Full-duplex and half-duplex

Table 17: 8-Port Gigabit Ethernet SFP XPIM Network Interface Specifications (continued)

Network Interface Specification	Value
Operating speed	10/100/1000 Mbps
VLAN support	802.1Q virtual LANs
Class-of-service support	Supported
Encapsulations	DIX, LLC/SNAP, CCC, TCC, and VLAN-CCC
Loopback diagnostic feature	Supported
Autonegotiation	Supported

RELATED DOCUMENTATION

[8-Port Gigabit Ethernet SFP XPIM Overview | 92](#)

[8-Port Gigabit Ethernet SFP XPIM Hardware Specifications | 95](#)

[8-Port Gigabit Ethernet SFP XPIM Supported Modules | 97](#)

[8-Port Gigabit Ethernet SFP XPIM Key Features | 94](#)

[8-Port Gigabit Ethernet SFP XPIM LEDs | 96](#)

[8-Port Gigabit Ethernet SFP XPIM Components | 93](#)

[8-Port Gigabit Ethernet SFP XPIM Basic Configuration | 221](#)

8-Port Serial GPIM Interface Specifications

Table 18 on page 27 lists the network interface specifications of the 8-Port Serial Gigabit-Backplane Physical Interface Module (GPIM).

Table 18: 8-Port Serial GPIM Network Interface Specifications

Description	Specification
Network Interface Specifications	
Line encoding	NRZ and NRZI

Table 18: 8-Port Serial GPIM Network Interface Specifications (continued)

Description	Specification
Line Protocols	<ul style="list-style-type: none"> • EIA-530 • EIA-530A • EIA-449 • RS-232 • V.35 • X.21
Modes	<ul style="list-style-type: none"> • data terminal equipment (DTE) <ul style="list-style-type: none"> • clear to send (CTS) • data carrier detect (DCD) • data set ready (DSR) • data circuit-terminating equipment (DCE) <ul style="list-style-type: none"> • request to send (RTS) • data terminal ready (DTR)
Synchronous Tx/Rx rate/port	Up to 8 Mbps
Error counters	rx_error_counts, tx_abort_counts, rx_giant_counts, rx_runt_counts, and crc_err_counts
HDLC Features	
Mode	56K or 64K
PPP, Frame Relay, and Cisco-HDLC protocols	Supported
Shared flag	Supported
Idle flag/fill (0x7e or all ones)	Supported
Counters	Runts, giants, fcs error, abort error, and align error

RELATED DOCUMENTATION

[8-Port Serial GPIM Overview | 99](#)
[8-Port Serial GPIM Hardware Specifications | 102](#)
[8-Port Serial GPIM Components | 100](#)

[8-Port Serial GPIM Key Features | 101](#)

[8-Port Serial GPIM LEDs | 103](#)

[8-Port Serial GPIM Interface Cables | 157](#)

[8-Port Serial GPIM Basic Configuration | 225](#)

Dual CT1/E1 GPIM Network Interface Specifications

The Dual CT1/E1 Gigabit-Backplane Physical Interface Module (GPIM) provides the network interface specifications specific to T1 or E1 modes, listed in [Table 19 on page 29](#).

Table 19: Dual CT1/E1 GPIM Network Interface Specifications

Description	T1 Mode	E1 Mode
Network Interface Specifications		
Line encoding	AMI/B8ZS	HDB3
Mode	Framed clear channel	<ul style="list-style-type: none"> Framed clear channel (64 Kbps) Unframed clear channel
Fractional framing	<ul style="list-style-type: none"> Superframe (D4/SF) Extended Superframe (ESF) 	<ul style="list-style-type: none"> G704 G704 with no CRC4 G703 Unframed
HDLC Features		
N x 64 Kbps or N x 56 Kbps, nonchannelized data rates	(T1:N=1 to 24)	(E1:N=1 to 31)
CRC	16/32	16/32
Shared flag	Supported	Supported
Idle flag/fill	Supported	Supported
Counters:	Runts, Giants, FCS, Error, Abort Error, Align Error	Runts, Giants, FCS, Error, Abort Error, Align Error

Quad CT1/E1 GPIM Network Interface Specifications

The Quad CT1/E1 Gigabit-Backplane Physical Interface Module (GPIM) provides the network interface specifications specific to T1 or E1 modes, listed in [Table 20 on page 30](#).

Table 20: Quad CT1/E1 GPIM Network Interface Specifications

Description	T1 Mode	E1 Mode
Network Interface Specifications		
Line encoding	AMI/B8ZS	HDB3
Mode	Framed clear channel	<ul style="list-style-type: none"> Framed clear channel (64 Kbps) Unframed clear channel
Fractional framing	<ul style="list-style-type: none"> Superframe (D4/SF) Extended Superframe (ESF) 	<ul style="list-style-type: none"> G704 G704 with no CRC4 G703 Unframed
HDLC Features		
N x 64 Kbps or N x 56 Kbps, nonchannelized data rates	(T1:N=1 to 24)	(E1:N=1 to 31)
CRC	16/32	16/32
Shared flag	Supported	Supported
Idle flag/fill	Supported	Supported
Counters:	Runts, Giants, FCS, Error, Abort Error, Align Error	Runts, Giants, FCS, Error, Abort Error, Align Error

2

PART

Interface Module Descriptions

1-Port Gigabit Ethernet SFP Mini-Physical Interface Module | **33**

1-Port SFP Mini-Physical Interface Module | **39**

1-Port ADSL2+ Mini-Physical Interface Module | **45**

1-Port DOCSIS Mini-Physical Interface Module | **51**

1-Port G.SHDSL 8-Wire Mini-Physical Interface Module | **57**

1-Port Serial Mini-Physical Interface Module | **62**

1-Port T1/E1 Mini-Physical Interface Module | **66**

1-Port VDSL2 (Annex A) Mini-Physical Interface Module | **72**

1-Port Clear Channel DS3/E3 GPIM | **77**

2-Port 10-Gigabit Ethernet XPIM | **83**

8-Port Gigabit Ethernet SFP XPIM | **92**

8-Port Serial GPIM | **99**

16-Port Gigabit Ethernet XPIM | **104**

24-Port Gigabit Ethernet XPIM | **111**

Dual CT1/E1 GPIM | **119**

1-Port Gigabit Ethernet SFP Mini-Physical Interface Module

IN THIS CHAPTER

- 1-Port Gigabit Ethernet SFP Mini-Physical Interface Module Overview | 33
- 1-Port Gigabit Ethernet SFP Mini-Physical Interface Module Key Features | 34
- 1-Port Gigabit Ethernet SFP Mini-Physical Interface Module Hardware Specifications | 35
- 1-Port Gigabit Ethernet SFP Mini-Physical Interface Module LEDs | 35
- 1-Port Gigabit Ethernet SFP Mini-Physical Interface Module Supported Modules | 36

1-Port Gigabit Ethernet SFP Mini-Physical Interface Module Overview

The 1-Port Gigabit Ethernet small form-factor pluggable Mini-Physical Interface Module (SFP Mini-PIM) provides connectivity to a single Gigabit Ethernet device or to a network. The 1-Port Gigabit Ethernet SFP Mini-PIM complements the on-board 10/100/1000 Mbps Ethernet interfaces with extended LAN or WAN connectivity. It offers support for a variety of transceivers. This Mini-PIM can be used in copper and optical environments to provide maximum flexibility when upgrading from an existing infrastructure to Metro Ethernet.

[Figure 6 on page 33](#) shows the front panel of the Gigabit Ethernet 1-Port SFP Mini-PIM.

Figure 6: 1-Port Gigabit Ethernet SFP Mini-PIM Front Panel

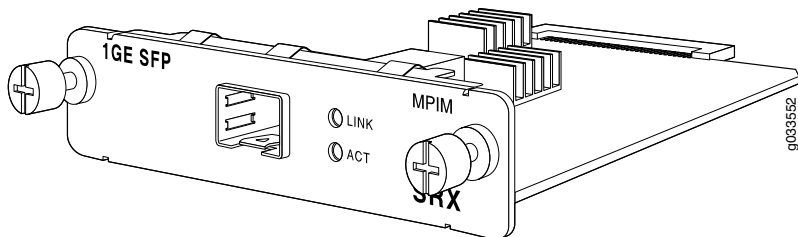

RELATED DOCUMENTATION

[1-Port Gigabit Ethernet SFP Mini-Physical Interface Module Hardware Specifications | 35](#)

[1-Port Gigabit Ethernet SFP Mini-Physical Interface Module Key Features | 34](#)

[1-Port Gigabit Ethernet SFP Mini-Physical Interface Module Network Interface Specifications | 19](#)

[1-Port Gigabit Ethernet SFP Mini-Physical Interface Module Supported Modules | 36](#)

[1-Port Gigabit Ethernet SFP Mini-Physical Interface Module LEDs | 35](#)

[1-Port Gigabit Ethernet SFP Mini-Physical Interface Module Basic Configuration | 196](#)

1-Port Gigabit Ethernet SFP Mini-Physical Interface Module Key Features

The 1-Port Gigabit Ethernet small form-factor pluggable Mini-Physical Interface Module (SFP Mini-PIM) has the following key features:

- Supports hot-swappable transceivers
- Real-time visual status of connectivity and traffic flows
- Provides Link Up/Down alarm
- Half-duplex/full-duplex support
- Autonegotiation



CAUTION: If you face a problem running a Juniper Networks device that uses a third-party optic or cable, the Juniper Networks Technical Assistance Center (JTAC) can help you diagnose the source of the problem. Your JTAC engineer might recommend that you check the third-party optic or cable and potentially replace it with an equivalent Juniper Networks optic or cable that is qualified for the device.

RELATED DOCUMENTATION

[1-Port Gigabit Ethernet SFP Mini-Physical Interface Module Overview | 33](#)

[1-Port Gigabit Ethernet SFP Mini-Physical Interface Module Hardware Specifications | 35](#)

[1-Port Gigabit Ethernet SFP Mini-Physical Interface Module Network Interface Specifications | 19](#)

[1-Port Gigabit Ethernet SFP Mini-Physical Interface Module Supported Modules | 36](#)

[1-Port Gigabit Ethernet SFP Mini-Physical Interface Module LEDs | 35](#)

[1-Port Gigabit Ethernet SFP Mini-Physical Interface Module Basic Configuration | 196](#)

1-Port Gigabit Ethernet SFP Mini-Physical Interface Module Hardware Specifications

Table 21 on page 35 gives the physical specifications of the 1-Port Gigabit Ethernet Small Form-Factor Pluggable Mini-Physical Interface Module (SFP Mini-PIM).

Table 21: 1-Port Gigabit Ethernet SFP Mini-PIM Physical Specifications

Description	Value
Dimensions (H x W x L)	0.80 in. x 3.75 in. x 5.9 in. (2.0 cm x 9.5 cm x 14.5 cm)
Weight	2.96 oz (84 g)
Connector type	SFP
Form factor	Mini-PIM

RELATED DOCUMENTATION

[1-Port Gigabit Ethernet SFP Mini-Physical Interface Module Overview | 33](#)

[1-Port Gigabit Ethernet SFP Mini-Physical Interface Module Key Features | 34](#)

[1-Port Gigabit Ethernet SFP Mini-Physical Interface Module Network Interface Specifications | 19](#)

[1-Port Gigabit Ethernet SFP Mini-Physical Interface Module Supported Modules | 36](#)

[1-Port Gigabit Ethernet SFP Mini-Physical Interface Module LEDs | 35](#)

[1-Port Gigabit Ethernet SFP Mini-Physical Interface Module Basic Configuration | 196](#)

1-Port Gigabit Ethernet SFP Mini-Physical Interface Module LEDs

The 1-Port Gigabit Ethernet Small Form-Factor Pluggable Mini-Physical Interface Module (SFP Mini-PIM) has two LEDs located to the right of the socket. Table 22 on page 36 describes the LED states.

Table 22: 1-Port Gigabit Ethernet SFP Mini-PIM LED States

LED	Color	State	Description
LINK	Green	On	Port is online
		Off	Port is offline
ACT	Green	Blinking	Port is receiving or sending data
		Off	Port might be on but is not receiving or sending data

RELATED DOCUMENTATION

[1-Port Gigabit Ethernet SFP Mini-Physical Interface Module Overview | 33](#)

[1-Port Gigabit Ethernet SFP Mini-Physical Interface Module Hardware Specifications | 35](#)

[1-Port Gigabit Ethernet SFP Mini-Physical Interface Module Network Interface Specifications | 19](#)

[1-Port Gigabit Ethernet SFP Mini-Physical Interface Module Supported Modules | 36](#)

[1-Port Gigabit Ethernet SFP Mini-Physical Interface Module Key Features | 34](#)

[1-Port Gigabit Ethernet SFP Mini-Physical Interface Module Basic Configuration | 196](#)

1-Port Gigabit Ethernet SFP Mini-Physical Interface Module Supported Modules

The 1-Port Gigabit Ethernet SFP Mini-Physical Interface Module can be customized by using different 1-port small form-factor pluggable (SFP) modules. [Table 23 on page 36](#) shows the supported 1-Port Gigabit Ethernet SFP modules.

Table 23: Supported 1-Port Gigabit Ethernet SFP Mini-Physical Interface Modules

Juniper Product Number	Connector Type (SFP Transceiver)	Cable
SRX-SFP-FE-FX EX-SFP-1FE-FX	100BASE-FX	LC
SRX-SFP-1GE-LH EX-SFP-1GE-LH	1000BASE-LH	LC

Table 23: Supported 1-Port Gigabit Ethernet SFP Mini-Physical Interface Modules (continued)

Juniper Product Number	Connector Type (SFP Transceiver)	Cable
SRX-SFP-1GE-LX EX-SFP-1GE-LX	1000BASE-LX	LC
SRX-SFP-1GE-SX EX-SFP-1GE-SX	1000BASE-SX	LC
SRX-SFP-1GE-T EX-SFP-1GE-T	1000BASE-T, Copper Transceiver	CAT-5e
EX-SFP-GE10KT13R14	1000BASE-BX10, at 10 km (TX1310 nm / RX1490 nm)	LC
EX-SFP-GE10KT13R15	1000BASE-BX10, at 10 km (TX1310 nm / RX1550 nm)	LC
EX-SFP-GE10KT14R13	1000BASE-BX10, at 10 km (TX1490 nm / RX1310 nm)	LC
EX-SFP-GE10KT15R13	1000BASE-BX10, at 10 km (TX1550 nm / RX1310 nm)	LC
EX-SFP-FE20KT13R15	100Base-BX Fast Ethernet Optics, at 20 km (TX 1310 nm / RX 1550 nm)	LC
EX-SFP-FE20KT15R13	100Base-BX Fast Ethernet Optics, at 20 km (TX 1550 nm / RX 1310 nm)	LC
EX-SFP-GE40KT13R15	1000BASE-BX, at 40 km (TX1310 nm / 1550 nm)	LC
EX-SFP-GE40KT15R13	1000BASE-BX, at 40 km (TX1550 nm / RX1310 nm)	LC



CAUTION: If you face a problem running a Juniper Networks device that uses a third-party optic or cable, the Juniper Networks Technical Assistance Center (JTAC) can help you diagnose the source of the problem. Your JTAC engineer might recommend that you check the third-party optic or cable and potentially replace it with an equivalent Juniper Networks optic or cable that is qualified for the device.

RELATED DOCUMENTATION

[1-Port Gigabit Ethernet SFP Mini-Physical Interface Module Overview | 33](#)

[1-Port Gigabit Ethernet SFP Mini-Physical Interface Module Hardware Specifications | 35](#)

[1-Port Gigabit Ethernet SFP Mini-Physical Interface Module Network Interface Specifications | 19](#)

[1-Port Gigabit Ethernet SFP Mini-Physical Interface Module Key Features | 34](#)

[1-Port Gigabit Ethernet SFP Mini-Physical Interface Module LEDs | 35](#)

[1-Port Gigabit Ethernet SFP Mini-Physical Interface Module Basic Configuration | 196](#)

1-Port SFP Mini-Physical Interface Module

IN THIS CHAPTER

- [1-Port SFP Mini-Physical Interface Module Overview | 39](#)
- [1-Port SFP Mini-Physical Interface Module Key Features | 40](#)
- [1-Port SFP Mini-Physical Interface Module Hardware Specifications | 41](#)
- [1-Port SFP Mini-Physical Interface Module LEDs | 42](#)
- [1-Port SFP Mini-Physical Interface Module Supported Modules | 42](#)

1-Port SFP Mini-Physical Interface Module Overview

The 1-Port small form-factor pluggable Mini-Physical Interface Module (SFP Mini-PIM) provides connectivity to a single Gigabit Ethernet device or to a network.

[Figure 7 on page 39](#) shows the front panel of the 1-Port SFP Mini-PIM.

Figure 7: 1-Port SFP Mini-PIM Front Panel

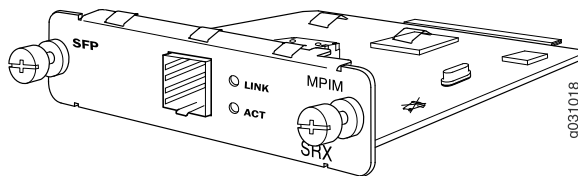

RELATED DOCUMENTATION

- [1-Port SFP Mini-Physical Interface Module Hardware Specifications | 41](#)
- [1-Port SFP Mini-Physical Interface Module Network Interface Specifications | 20](#)
- [1-Port SFP Mini-Physical Interface Module Supported Modules | 42](#)
- [1-Port SFP Mini-Physical Interface Module Key Features | 40](#)
- [1-Port SFP Mini-Physical Interface Module LEDs | 42](#)
- [1-Port SFP Mini-Physical Interface Module Basic Configuration | 199](#)

1-Port SFP Mini-Physical Interface Module Key Features

The 1-Port small form-factor pluggable Mini-Physical Interface Module (SFP Mini-PIM) has the following key features:

- Enables you to install and remove transceivers without powering down the device
- Provides real-time visual status of connectivity and traffic flows
- Provides Link Up/Down alarm
- Supports the following transceiver types:
 - 1000BASE-SX
 - 100BASE-LX
 - 1000BASE-LX10
 - 100BASE-FX
 - 1000BASE-T
 - 1000BASE-LH (ZX)
 - Tri-Rate 10/100/1000BASE-T, Copper Transceiver
 - 1000BASE-BX10, at 10 km (TX1310 nm / RX1490 nm)
 - 1000BASE-BX10, at 10 km (TX1310 nm / RX1550 nm)
 - 1000BASE-BX10, at 10 km (TX1490 nm / RX1310 nm)
 - 1000BASE-BX10, at 10 km (TX1550 nm / RX1310 nm)
 - 1000BASE-BX, at 40 km (TX1310 nm / 1550 nm)
 - 1000BASE-BX, at 40km (TX1550 LC nm / RX1310 nm)
 - 100Base-BX Fast Ethernet Optics, at 20 km (TX 1310 nm / RX 1550 nm)
 - 100Base-BX Fast Ethernet Optics, at 20 km (TX 1550 nm / RX 1310 nm)

NOTE: The 1-Port SFP Mini-PIM with Ethernet connector provides 1000-Mbps link speed. Actual bandwidth is limited to 100 Mbps.



CAUTION: If you face a problem running a Juniper Networks device that uses a third-party optic or cable, the Juniper Networks Technical Assistance Center (JTAC) can help you diagnose the source of the problem. Your JTAC engineer might recommend that you check the third-party optic or cable and potentially replace it with an equivalent Juniper Networks optic or cable that is qualified for the device.

RELATED DOCUMENTATION

[1-Port SFP Mini-Physical Interface Module Overview | 39](#)

[1-Port SFP Mini-Physical Interface Module Hardware Specifications | 41](#)

[1-Port SFP Mini-Physical Interface Module Network Interface Specifications | 20](#)

[1-Port SFP Mini-Physical Interface Module LEDs | 42](#)

[1-Port SFP Mini-Physical Interface Module Basic Configuration | 199](#)

1-Port SFP Mini-Physical Interface Module Hardware Specifications

Table 24 on page 41 gives the physical specifications of the 1-Port Small Form-Factor Pluggable Mini-Physical Interface Module (SFP Mini-PIM).

Table 24: 1-Port SFP Mini-PIM Physical Specifications

Description	Value
Dimensions (H x W x L)	0.80 in. x 3.75 in. x 5.9 in. (2.0 cm x 9.5 cm x 14.5 cm)
Weight	3.36 oz (95 g)
Connector type	SFP
Form factor	Mini-PIM

RELATED DOCUMENTATION

[1-Port SFP Mini-Physical Interface Module Network Interface Specifications | 20](#)

[1-Port SFP Mini-Physical Interface Module Supported Modules | 42](#)

[1-Port SFP Mini-Physical Interface Module Key Features | 40](#)

[1-Port SFP Mini-Physical Interface Module LEDs | 42](#)

[1-Port SFP Mini-Physical Interface Module Basic Configuration | 199](#)

1-Port SFP Mini-Physical Interface Module LEDs

The 1-Port Small Form-Factor Pluggable Mini-Physical Interface Module (SFP Mini-PIM) has two LEDs located to the right of the socket. [Table 25 on page 42](#) describes the LED states.

Table 25: 1-Port SFP Mini-PIM LED States

LED	Color	State	Description
LINK	Green	On	Port is online
		Off	Port is offline
ACT	Green	Blinking	Port is receiving or sending data
		Off	Port might be on but is not receiving or sending data

RELATED DOCUMENTATION

[1-Port SFP Mini-Physical Interface Module Overview | 39](#)

[1-Port SFP Mini-Physical Interface Module Hardware Specifications | 41](#)

[1-Port SFP Mini-Physical Interface Module Network Interface Specifications | 20](#)

[1-Port SFP Mini-Physical Interface Module Supported Modules | 42](#)

[1-Port SFP Mini-Physical Interface Module Key Features | 40](#)

[1-Port SFP Mini-Physical Interface Module Basic Configuration | 199](#)

1-Port SFP Mini-Physical Interface Module Supported Modules

You can customize the Ethernet interface type by using different 1-port small form-factor pluggable (SFP) modules. [Table 26 on page 43](#) shows the supported 1-Port SFP modules.

Table 26: 1-Port SFP Mini-Physical Interface Modules

Product Number	Interface Type	Connector
JX-SFP-1GE-LX SRX-SFP-1GE-LX	1000BASE-LX	LC
JX-SFP-1GE-SX SRX-SFP-1GE-SX	1000BASE-SX	LC
JX-SFP-1FE-FX SRX-SFP-FE-FX	100BASE-FX	LC
JX-SFP-1GE-LH SRX-SFP-1GE-LH	1000BASE-LH	LC
JX-SFP-1GE-LX SRX-SFP-1GE-LX	1000BASE-LX	LC
JX-SFP-1GE-SX SRX-SFP-1GE-SX	1000BASE-SX	LC
JX-SFP-1GE-T SRX-SFP-1GE-T	1000BASE-T, Copper Transceiver	CAT-5e
EX-SFP-GE10KT13R14	1000BASE-BX, at 10 km (TX1310 nm / RX1490 nm)	LC
EX-SFP-GE10KT13R15	1000BASE-BX, at 10 km (TX1310 nm / RX1550 nm)	LC
EX-SFP-GE10KT14R13	1000BASE-BX, at 10 km (TX1490 nm / RX1310 nm)	LC
EX-SFP-GE10KT15R13	1000BASE-BX, at 10 km (TX1550 nm / RX1310 nm)	LC
EX-SFP-FE20KT13R15	100BASE-BX Fast Ethernet Optics, at 20 km (TX 1310 nm / RX 1550 nm)	LC

Table 26: 1-Port SFP Mini-Physical Interface Modules (continued)

Product Number	Interface Type	Connector
EX-SFP-FE20KT15R13	100BASE-BX Fast Ethernet Optics, at 20 km (TX 1550 nm / RX 1310 nm)	LC
EX-SFP-GE40KT13R15	1000BASE-BX, at 40 km (TX1310 nm / 1550 nm)	LC
EX-SFP-GE40KT15R13	1000BASE-BX, at 40 km (TX1550 nm / RX1310 nm)	LC



CAUTION: If you face a problem running a Juniper Networks device that uses a third-party optic or cable, the Juniper Networks Technical Assistance Center (JTAC) can help you diagnose the source of the problem. Your JTAC engineer might recommend that you check the third-party optic or cable and potentially replace it with an equivalent Juniper Networks optic or cable that is qualified for the device.

RELATED DOCUMENTATION

[1-Port SFP Mini-Physical Interface Module Overview | 39](#)

[1-Port SFP Mini-Physical Interface Module Hardware Specifications | 41](#)

[1-Port SFP Mini-Physical Interface Module Network Interface Specifications | 20](#)

[1-Port SFP Mini-Physical Interface Module Key Features | 40](#)

[1-Port SFP Mini-Physical Interface Module LEDs | 42](#)

[1-Port SFP Mini-Physical Interface Module Basic Configuration | 199](#)

1-Port ADSL2+ Mini-Physical Interface Module

IN THIS CHAPTER

- 1-Port ADSL2+ Mini-Physical Interface Module Overview | 45
- 1-Port ADSL2+ Mini-Physical Interface Module Key Features | 46
- 1-Port ADSL2+ Mini-Physical Interface Module Hardware Specifications | 47
- 1-Port ADSL2+ Mini-Physical Interface Module LEDs | 48
- 1-Port ADSL2+ Mini-Physical Interface Module Supported Standards | 48
- 1-Port ADSL2+ Mini-Physical Interface Module Supported Loopback Diagnostics | 49

1-Port ADSL2+ Mini-Physical Interface Module Overview

The 1-Port ADSL2+ Mini-Physical Interface Module (Mini-PIM) provides a single physical interface to asymmetric digital subscriber line (ADSL) network media types.

The following 1-Port ADSL2+ Mini-PIM cards are available:

- Annex A
- Annex B

NOTE: The ADSL2+ Annex A card also operates in Annex M mode.

Figure 8 on page 45 shows the front panel of ADSL2+ Annex A Mini-PIM.

Figure 8: ADSL2+ Annex A Mini-PIM Front Panel

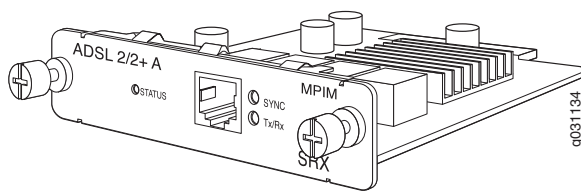
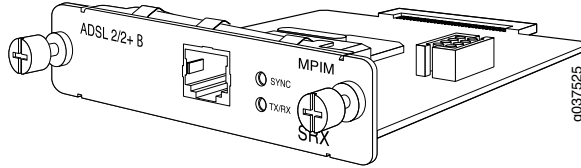

Figure 9 on page 46 shows the front panel of ADSL2+ Annex B Mini-PIM.

Figure 9: ADSL2+ Annex B Mini-PIM Front Panel



RELATED DOCUMENTATION

[1-Port ADSL2+ Mini-Physical Interface Module Hardware Specifications | 47](#)

[1-Port ADSL2+ Mini-Physical Interface Module Network Interface Specifications | 21](#)

[1-Port ADSL2+ Mini-Physical Interface Module Supported Standards | 48](#)

[1-Port ADSL2+ Mini-Physical Interface Module Key Features | 46](#)

[1-Port ADSL2+ Mini-Physical Interface Module LEDs | 48](#)

[1-Port ADSL2+ Mini-Physical Interface Module Supported Loopback Diagnostics | 49](#)

[1-Port ADSL2+ Mini-Physical Interface Module Basic Configuration | 201](#)

1-Port ADSL2+ Mini-Physical Interface Module Key Features

The 1-Port ADSL2+ Mini-Physical Interface Module (Mini-PIM) provides the following key features:

- Automatic configuration of the ADSL after negotiating with the DSLAM
- Support for ADSL, ADSL 2, and ADSL2+ protocols on the same interface card
- Dying Gasp support
- MLPPP on one interface
- Asynchronous Transfer Mode (ATM) Adaptation Layer 5 (AAL5) encapsulation
- Support of latency modes fast and interleave
- Support for ATM AAL5 with CBR, VBR-nrt and UBR traffic types
- Support for 10 permanent virtual circuits (PVCS)

RELATED DOCUMENTATION

[1-Port ADSL2+ Mini-Physical Interface Module Overview | 45](#)

[1-Port ADSL2+ Mini-Physical Interface Module Hardware Specifications | 47](#)

[1-Port ADSL2+ Mini-Physical Interface Module Network Interface Specifications | 21](#)

[1-Port ADSL2+ Mini-Physical Interface Module Supported Standards | 48](#)

[1-Port ADSL2+ Mini-Physical Interface Module LEDs | 48](#)

[1-Port ADSL2+ Mini-Physical Interface Module Supported Loopback Diagnostics | 49](#)

[1-Port ADSL2+ Mini-Physical Interface Module Basic Configuration | 201](#)

1-Port ADSL2+ Mini-Physical Interface Module Hardware Specifications

[Table 27 on page 47](#) gives the physical specifications of the 1-Port ADSL2+ Mini-Physical Interface Module (Mini-PIM).

Table 27: 1-Port ADSL2+ Mini-PIM Specifications

Description	Value
Dimensions (H x W x L)	3.75 in. x 5.9 in. x 0.80 in. (9.5 cm x 14.5 cm x 2.0 cm)
Weight	2.72 oz (77 g)
Connector type	RJ-11
Form factor	Mini-PIM
Environmental operating temperature	32°F through 104°F (0°C through 40°C)
Storage temperature	-40°F through 158°F (-40°C through 70°C)
Relative humidity	5% to 90% noncondensing

RELATED DOCUMENTATION

[1-Port ADSL2+ Mini-Physical Interface Module Overview | 45](#)

[1-Port ADSL2+ Mini-Physical Interface Module Network Interface Specifications | 21](#)

[1-Port ADSL2+ Mini-Physical Interface Module Supported Standards | 48](#)

[1-Port ADSL2+ Mini-Physical Interface Module Key Features | 46](#)

[1-Port ADSL2+ Mini-Physical Interface Module LEDs | 48](#)

[1-Port ADSL2+ Mini-Physical Interface Module Supported Loopback Diagnostics | 49](#)

[1-Port ADSL2+ Mini-Physical Interface Module Basic Configuration | 201](#)

1-Port ADSL2+ Mini-Physical Interface Module LEDs

The 1-Port ADSL2+ Mini-Physical Interface Module (Mini-PIM) has two LEDs. [Table 28 on page 48](#) describes the LED states.

Table 28: 1-Port ADSL2+ Mini-PIM LED States

LED	Color	State	Description
SYNC	Green	On	Indicates that the ADSL interface is trained
		Blinking	Indicates training is in progress
		Off	Indicates that the interface is idle
TX/RX	Green	Blinking	Indicates that traffic is passing through
		Off	Indicates that no traffic is passing through

RELATED DOCUMENTATION

[1-Port ADSL2+ Mini-Physical Interface Module Overview | 45](#)

[1-Port ADSL2+ Mini-Physical Interface Module Hardware Specifications | 47](#)

[1-Port ADSL2+ Mini-Physical Interface Module Network Interface Specifications | 21](#)

[1-Port ADSL2+ Mini-Physical Interface Module Supported Standards | 48](#)

[1-Port ADSL2+ Mini-Physical Interface Module Key Features | 46](#)

[1-Port ADSL2+ Mini-Physical Interface Module Supported Loopback Diagnostics | 49](#)

[1-Port ADSL2+ Mini-Physical Interface Module Basic Configuration | 201](#)

1-Port ADSL2+ Mini-Physical Interface Module Supported Standards

The 1-Port ADSL2+ Mini-Physical Interface Module (Mini-PIM) supports the following standards:

- ANSI T1.413 Issue 2 (Annex A only)
- ITU G.992.1 (G.dmt)
- ITU G.992.3 (ADSL2)
- ITU G.992.5 (ADSL2+)

RELATED DOCUMENTATION

[1-Port ADSL2+ Mini-Physical Interface Module Overview | 45](#)

[1-Port ADSL2+ Mini-Physical Interface Module Hardware Specifications | 47](#)

[1-Port ADSL2+ Mini-Physical Interface Module Network Interface Specifications | 21](#)

[1-Port ADSL2+ Mini-Physical Interface Module Key Features | 46](#)

[1-Port ADSL2+ Mini-Physical Interface Module LEDs | 48](#)

[1-Port ADSL2+ Mini-Physical Interface Module Supported Loopback Diagnostics | 49](#)

[1-Port ADSL2+ Mini-Physical Interface Module Basic Configuration | 201](#)

1-Port ADSL2+ Mini-Physical Interface Module Supported Loopback Diagnostics

The 1-Port ADSL2+ Mini-Physical Interface Module (Mini-PIM) provides the following Operation, Administration, and Maintenance (OAM) loopback diagnostics:

- OAM F4 far loopback test
- OAM F4 near loopback test
- OAM F5 far loopback test
- OAM F5 near loopback test

RELATED DOCUMENTATION

[1-Port ADSL2+ Mini-Physical Interface Module Overview | 45](#)

[1-Port ADSL2+ Mini-Physical Interface Module Hardware Specifications | 47](#)

[1-Port ADSL2+ Mini-Physical Interface Module Network Interface Specifications | 21](#)

[1-Port ADSL2+ Mini-Physical Interface Module Supported Standards | 48](#)

[1-Port ADSL2+ Mini-Physical Interface Module Key Features | 46](#)

1-Port ADSL2+ Mini-Physical Interface Module LEDs | 48

1-Port ADSL2+ Mini-Physical Interface Module Basic Configuration | 201

1-Port DOCSIS Mini-Physical Interface Module

IN THIS CHAPTER

- 1-Port DOCSIS Mini-Physical Interface Module Overview | 51
- 1-Port DOCSIS Mini-Physical Interface Module Key Features | 52
- 1-Port DOCSIS Mini-Physical Interface Module Hardware Specifications | 53
- 1-Port DOCSIS Mini-Physical Interface Module LEDs | 54
- 1-Port DOCSIS Mini-Physical Interface Module Supported Standards | 55

1-Port DOCSIS Mini-Physical Interface Module Overview

The Data over Cable System Interface Specifications Mini-Physical Interface Module (1-Port DOCSIS Mini-PIM) has the following features:

- Provides a single cable modem interface for connecting to a cable modem termination system (CMTS) network
- Supports high-speed, bidirectional data transfer over an existing cable TV system
- Provides high-speed WAN connectivity

The DOCSIS 3.0 US model of the 1-Port DOCSIS Mini-PIM is supported.

[Figure 10 on page 51](#) shows the front panel of 1-Port DOCSIS Mini-PIM.

Figure 10: DOCSIS Mini-PIM

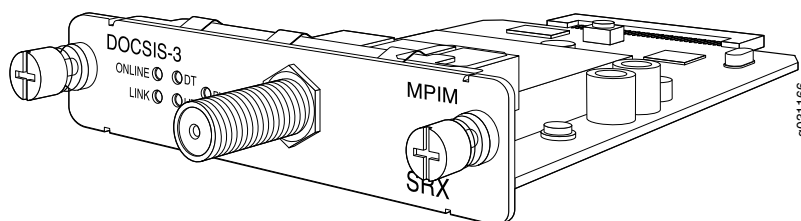

NOTE: (För Sverige och Norge endast) Att ansluta en enhet via en jordad kontakt och/eller via annan utrustning samtidigt som den är kopplad till ett kabel-tv system innebär en brandrisk. För att förebygga detta måste du placera en galvanisk isolator mellan enheten och kabel-tv systemet.

The note translates as follows:

(For Sweden and Norway only) Connecting a device through a grounded outlet and/or through other equipment while it is also connected to a cable TV system creates a fire risk. To prevent this, you need to place a galvanic isolator between the device and the cable TV system.

RELATED DOCUMENTATION

[1-Port DOCSIS Mini-Physical Interface Module Key Features | 52](#)

[1-Port DOCSIS Mini-Physical Interface Module Supported Standards | 55](#)

[1-Port DOCSIS Mini-Physical Interface Module Hardware Specifications | 53](#)

[1-Port DOCSIS Mini-Physical Interface Module Network Interface Specifications | 22](#)

[1-Port DOCSIS Mini-Physical Interface Module LEDs | 54](#)

[1-Port DOCSIS Mini-Physical Interface Module Basic Configuration | 204](#)

1-Port DOCSIS Mini-Physical Interface Module Key Features

The Data over Cable System Interface Specifications Mini-Physical Interface Module (1-Port DOCSIS Mini-PIM) has the following key features:

- Provides high data transfer rates of over 150 Mbps downstream
- Supports four downstream and four upstream channel bonding
- Supports quality of service (QoS)
- Provides interoperability with any DOCSIS compliant cable modem termination system (CMTS)
- Supports IPv6 and IPv4 for the modem management interface
- Supports Advanced Encryption Standard (AES)
- Supports baseline privacy encryption (BPI+)

RELATED DOCUMENTATION

[1-Port DOCSIS Mini-Physical Interface Module Overview | 51](#)

[1-Port DOCSIS Mini-Physical Interface Module Supported Standards | 55](#)

[1-Port DOCSIS Mini-Physical Interface Module Hardware Specifications | 53](#)

[1-Port DOCSIS Mini-Physical Interface Module Network Interface Specifications | 22](#)

[1-Port DOCSIS Mini-Physical Interface Module LEDs | 54](#)

[1-Port DOCSIS Mini-Physical Interface Module Basic Configuration | 204](#)

1-Port DOCSIS Mini-Physical Interface Module Hardware Specifications

Table 29 on page 53 lists the hardware specifications of the Data over Cable System Interface Specifications Mini-Physical Interface Module (1-Port DOCSIS Mini-PIM).

Table 29: 1-Port DOCSIS Mini-PIM Hardware Specifications

Description	Value
Dimensions (H x W x L)	0.80 in. x 3.75 in. x 5.9 in. (2.0 cm x 9.5 cm x 14.5 cm)
Weight	4.40 oz (125 g)
Connector type	F-Type coaxial connector
Form factor	Mini-PIM
Environmental operating temperature	32°F through 104°F (0°C through 40°C)
Storage temperature	-40°F through 158°F (-40°C through 70°C)
Relative humidity	5% to 90% noncondensing

RELATED DOCUMENTATION

[1-Port DOCSIS Mini-Physical Interface Module Overview | 51](#)

[1-Port DOCSIS Mini-Physical Interface Module Key Features | 52](#)

[1-Port DOCSIS Mini-Physical Interface Module Supported Standards | 55](#)

[1-Port DOCSIS Mini-Physical Interface Module Network Interface Specifications | 22](#)

1-Port DOCSIS Mini-Physical Interface Module LEDs

The Data over Cable System Interface Specifications Mini-Physical Interface Module (1-Port DOCSIS Mini-PIM) has five LEDs. [Figure 11 on page 54](#) describes the LEDs available on the 1-Port DOCSIS Mini-PIM.

Figure 11: 1-Port DOCSIS Mini-PIM LEDs

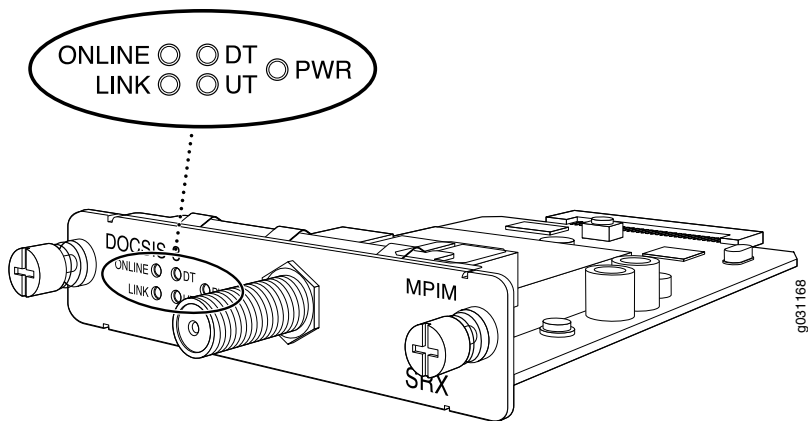

[Table 30 on page 54](#) describes the LED states.

Table 30: 1-Port DOCSIS Mini-PIM LED States

LED	Color	State	Description
PWR	Green	On	The 1-Port DOCSIS Mini-PIM has been powered on and completed the power-on-self-test (POST).
	Red	On	The 1-Port DOCSIS Mini-PIM has failed the POST.
DT (Downstream)	Green	Blinking	The 1-Port DOCSIS Mini-PIM scans for a valid downstream DOCSIS channel to lock onto a downstream channel.
		On	The 1-Port DOCSIS Mini-PIM has locked onto the DOCSIS downstream channel.

Table 30: 1-Port DOCSIS Mini-PIM LED States (continued)

LED	Color	State	Description
UT (Upstream)	Green	Blinking	The 1-Port DOCSIS Mini-PIM scans for a valid upstream DOCSIS channel to lock onto an upstream channel.
		On	The 1-Port DOCSIS Mini-PIM has locked onto the DOCSIS upstream channel.
LINK (to CMTS)	Green	Blinking	The 1-Port DOCSIS Mini-PIM has an active link with the CPE device, but data communication is not taking place.
		On	The 1-Port DOCSIS Mini-PIM has an active link with the CPE device, and data communication is taking place. NOTE: The Link LED does not blink for data traffic that originates or terminates at the cable modem.
ONLINE	Green	Blinking	The 1-Port DOCSIS Mini-PIM is establishing a connection to the SRX Series device.
		On	The 1-Port DOCSIS Mini-PIM is synchronized with the SRX Series device.

RELATED DOCUMENTATION

[1-Port DOCSIS Mini-Physical Interface Module Overview | 51](#)

[1-Port DOCSIS Mini-Physical Interface Module Key Features | 52](#)

[1-Port DOCSIS Mini-Physical Interface Module Supported Standards | 55](#)

[1-Port DOCSIS Mini-Physical Interface Module Hardware Specifications | 53](#)

[1-Port DOCSIS Mini-Physical Interface Module Network Interface Specifications | 22](#)

[1-Port DOCSIS Mini-Physical Interface Module Basic Configuration | 204](#)

1-Port DOCSIS Mini-Physical Interface Module Supported Standards

The Data over Cable System Interface Specifications Mini-Physical Interface Module (1-Port DOCSIS Mini-PIM) supports DOCSIS 3.0 standards.

NOTE: Ensure that your cable modem service provider has approved the use of 1-Port DOCSIS 3.0 Mini-PIM in your network.

The 1-Port DOCSIS Mini-PIM provides backward compatibility with the cable modem termination system (CMTS) based on the following standards:

- DOCSIS 2.0
- DOCSIS 1.1
- DOCSIS 1.0

RELATED DOCUMENTATION

[1-Port DOCSIS Mini-Physical Interface Module Overview | 51](#)

[1-Port DOCSIS Mini-Physical Interface Module Key Features | 52](#)

[1-Port DOCSIS Mini-Physical Interface Module Hardware Specifications | 53](#)

[1-Port DOCSIS Mini-Physical Interface Module Network Interface Specifications | 22](#)

[1-Port DOCSIS Mini-Physical Interface Module LEDs | 54](#)

[1-Port DOCSIS Mini-Physical Interface Module Basic Configuration | 204](#)

1-Port G.SHDSL 8-Wire Mini-Physical Interface Module

IN THIS CHAPTER

- 1-Port G.SHDSL 8-Wire Mini-Physical Interface Module Overview | 57
- 1-Port G.SHDSL 8-Wire Mini-Physical Interface Module Key Features | 58
- 1-Port G.SHDSL 8-Wire Mini-Physical Interface Module Hardware Specifications | 59
- 1-Port G.SHDSL 8-Wire Mini-Physical Interface Module LEDs | 60
- 1-Port G.SHDSL 8-Wire Mini-Physical Interface Module Supported Standards | 61

1-Port G.SHDSL 8-Wire Mini-Physical Interface Module Overview

Symmetric high-speed digital subscriber line (SHDSL), also known as *G.SHDSL*, is part of the xDSL family of modem technologies that provide faster data transmission over a pair of single flat untwisted or twisted copper wires. ITU-T G.991.2 is the officially designated standard describing *G.SHDSL*.

The *G.SHDSL* interface on the SRX Series Services Gateways supports SHDSL for data transfer between a single customer premises equipment (CPE) subscriber and a central office (CO).

The 1-Port *G.SHDSL* 8-Wire Mini-Physical Interface Module (Mini-PIM) supported on SRX Series Services Gateways provides the physical connection to DSL network media types.

[Figure 12 on page 57](#) shows the 1-Port *G.SHDSL* 8-Wire Mini-PIM.

Figure 12: 1-Port G.SHDSL8-Wire Mini-PIM

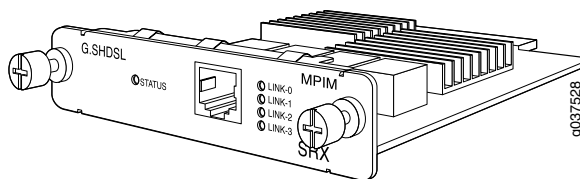

RELATED DOCUMENTATION

[1-Port G.SHDSL 8-Wire Mini-Physical Interface Module Supported Standards | 61](#)

[1-Port G.SHDSL 8-Wire Mini-Physical Interface Module Operating Modes | 239](#)

[1-Port G.SHDSL 8-Wire Mini-Physical Interface Module Key Features | 58](#)

[1-Port G.SHDSL 8-Wire Mini-Physical Interface Module Hardware Specifications | 59](#)

[1-Port G.SHDSL 8-Wire Mini-Physical Interface Module LEDs | 60](#)

1-Port G.SHDSL 8-Wire Mini-Physical Interface Module Key Features

The 1-Port G.SHDSL 8-Wire Mini-Physical Interface Module (Mini-PIM) provides the following key features:

- 2-wire (4-port 2-wire) mode, 4-wire (2-port 4-wire) mode, and 8-wire (1-port 8-wire) mode support
- Annex A, Annex B, Annex F, and Annex G support
- Virtual circuits per Mini-PIM (8 maximum)
- Asynchronous Transfer Mode (ATM) over G.SHDSL framing
- ATM class-of-service (CoS) support
- ATM Operation, Administration, and Maintenance (OAM) support
- Dying Gasp support

Dying Gasp is the ability of the device to automatically notify the service provider digital subscriber line access multiplexer (DSLAM) if a power failure occurs. The customer premises equipment (CPE) sends a message to the DSLAM, which indicates that a line was lost because of loss in CPE power.

- Wetting current support

Wetting current is a small amount of electrical current sent from the central office (CO) over the copper pair to the CPE to prevent the erosion of the copper wires. Some service providers also use wetting current as a method for identifying cable pairs, and they therefore need to recognize and receive wetting current. Additionally, wetting current can be used to power devices such as repeaters and low power devices.

- Noise margin support
- Point-to-Point Protocol over ATM and PPPoE over ATM encapsulation support
- Local loopback mode support

RELATED DOCUMENTATION

[1-Port G.SHDSL 8-Wire Mini-Physical Interface Module Overview | 57](#)

[1-Port G.SHDSL 8-Wire Mini-Physical Interface Module Supported Standards | 61](#)

[MTU Default and Maximum Values for Physical Interface Modules | 12](#)

[1-Port G.SHDSL 8-Wire Mini-Physical Interface Module Operating Modes | 239](#)

[1-Port G.SHDSL 8-Wire Mini-Physical Interface Module Hardware Specifications | 59](#)

[1-Port G.SHDSL 8-Wire Mini-Physical Interface Module LEDs | 60](#)

1-Port G.SHDSL 8-Wire Mini-Physical Interface Module Hardware Specifications

Table 31 on page 59 describes the physical specifications of the 1-Port G.SHDSL 8-Wire Mini-Physical Interface Module (Mini-PIM).

Table 31: 1-Port G.SHDSL 8-Wire Mini-PIM Physical Specifications

Description	Value
Dimensions (H x W x D)	0.8 in. x 3.75 in. x 5.9 in. (2.0 cm x 9.5 cm x 14.5 cm)
Weight	5.28 oz (150 g)
Connector type	RJ-45
Form factor	Mini-PIM
Environmental operating temperature	32°F through 104°F (0°C through 40°C)
Storage temperature	-40°F through 158°F (-40°C through 70°C)
Relative humidity	5% to 90% noncondensing

RELATED DOCUMENTATION

[1-Port G.SHDSL 8-Wire Mini-Physical Interface Module Overview | 57](#)

[1-Port G.SHDSL 8-Wire Mini-Physical Interface Module Supported Standards | 61](#)

[1-Port G.SHDSL 8-Wire Mini-Physical Interface Module Operating Modes | 239](#)

[1-Port G.SHDSL 8-Wire Mini-Physical Interface Module Key Features | 58](#)

1-Port G.SHDSL 8-Wire Mini-Physical Interface Module LEDs

The 1-Port G.SHDSL 8-Wire Mini-Physical Interface Module (Mini-PIM) has the following LEDs to indicate the state of the Mini-PIM and its four ports (one LED for each port).

Table 32 on page 60 describes the LED states.

Table 32: 1-Port G.SHDSL Mini-PIM LED States

Name	Color	State	Description
STATUS	Green	On	Port is online with no alarms or failures
	Amber	On	Port is initializing
	Red	On	Port has detected an alarm
LINK	Green	On	Link is active
		Blinking	Data communication is taking place
		Off	Link is inactive

NOTE: There are four LINK LEDs available on the G.SHDSL Mini-PIM. Each LED provides the link status of the wire pair.

RELATED DOCUMENTATION

[1-Port G.SHDSL 8-Wire Mini-Physical Interface Module Overview | 57](#)

[1-Port G.SHDSL 8-Wire Mini-Physical Interface Module Supported Standards | 61](#)

[1-Port G.SHDSL 8-Wire Mini-Physical Interface Module Operating Modes | 239](#)

[1-Port G.SHDSL 8-Wire Mini-Physical Interface Module Key Features | 58](#)

[1-Port G.SHDSL 8-Wire Mini-Physical Interface Module Hardware Specifications | 59](#)

[1-Port G.SHDSL 8-Wire Mini-Physical Interface Module Basic Configuration | 206](#)

1-Port G.SHDSL 8-Wire Mini-Physical Interface Module Supported Standards

The 1-Port G.SHDSL 8-Wire Mini-Physical Interface Module (Mini-PIM) complies with the following standards:

- ITU-T G.991.2—*Symmetric high-speed digital subscriber line (SHDSL) transceiver*
- ITU-T G.994.1—*Handshake procedures for digital subscriber line (DSL) transceivers (3 LC Comment)*
- ITU-T G.997.1—*Physical layer management for DSL transceivers*

RELATED DOCUMENTATION

[1-Port G.SHDSL 8-Wire Mini-Physical Interface Module Overview | 57](#)

[1-Port G.SHDSL 8-Wire Mini-Physical Interface Module Operating Modes | 239](#)

[1-Port G.SHDSL 8-Wire Mini-Physical Interface Module Key Features | 58](#)

[1-Port G.SHDSL 8-Wire Mini-Physical Interface Module Hardware Specifications | 59](#)

[1-Port G.SHDSL 8-Wire Mini-Physical Interface Module LEDs | 60](#)

1-Port Serial Mini-Physical Interface Module

IN THIS CHAPTER

- [1-Port Serial Mini-Physical Interface Module Overview | 62](#)
- [1-Port Serial Mini-Physical Interface Module Key Features | 63](#)
- [1-Port Serial Mini-Physical Interface Module Hardware Specifications | 63](#)
- [1-Port Serial Mini-Physical Interface Module LEDs | 64](#)
- [1-Port Serial Mini-Physical Interface Module Supported Standards | 65](#)

1-Port Serial Mini-Physical Interface Module Overview

Serial WAN links are bidirectional links and require very few control signals. In a basic serial setup, the data circuit-terminating equipment (DCE) is responsible for establishing, maintaining, and terminating a connection. A modem is a typical DCE device. A serial cable connects the DCE to a telephony network where, ultimately, a link is established with data terminal equipment (DTE). DTE is typically where a link terminates.

[Figure 13 on page 62](#) shows the front panel of the 1-Port Serial Mini-Physical Interface Module (Mini-PIM).

Figure 13: 1-Port Serial Mini-PIM Front Panel

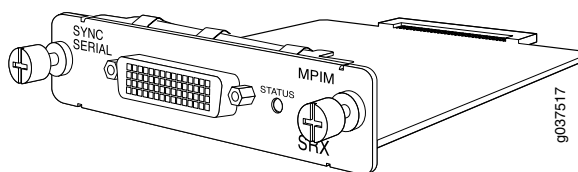

RELATED DOCUMENTATION

- [1-Port Serial Mini-Physical Interface Module Hardware Specifications | 63](#)
- [1-Port Serial Mini-Physical Interface Module Supported Standards | 65](#)
- [1-Port Serial Mini-Physical Interface Module Key Features | 63](#)

[1-Port Serial Mini-Physical Interface Module LEDs | 64](#)

[1-Port Serial Mini-Physical Interface Module Basic Configuration | 207](#)

1-Port Serial Mini-Physical Interface Module Key Features

The 1-Port Serial Mini-Physical Interface Module (Mini-PIM) provides the following key features:

- Autoselection of operational modes based on DTE or DCE cables
- Local and remote loopback diagnostics
- Configurable clock rate for the transmit (TX) clock and receive (RX) clock
- Complete configuration and management by using the CLI and the J-Web interface

RELATED DOCUMENTATION

[1-Port Serial Mini-Physical Interface Module Overview | 62](#)

[1-Port Serial Mini-Physical Interface Module Hardware Specifications | 63](#)

[1-Port Serial Mini-Physical Interface Module Supported Standards | 65](#)

[MTU Default and Maximum Values for Physical Interface Modules | 12](#)

[1-Port Serial Mini-Physical Interface Module LEDs | 64](#)

[1-Port Serial Mini-Physical Interface Module Basic Configuration | 207](#)

1-Port Serial Mini-Physical Interface Module Hardware Specifications

Table 33 on page 63 gives the physical specifications of the 1-Port Serial Mini-Physical Interface Module (Mini-PIM).

Table 33: 1-Port Serial Mini-PIM Physical Specifications

Description	Value
Dimensions (H x W x L)	0.8 in. x 3.75 in. x 5.9 in. (2.0 cm x 9.5 cm x 14.5 cm)
Weight	3.04 oz (86 g)
Connector type	60-pin Synchronous Serial (socket)

Table 33: 1-Port Serial Mini-PIM Physical Specifications (continued)

Description	Value
Form factor	Mini-PIM

RELATED DOCUMENTATION

[1-Port Serial Mini-Physical Interface Module Overview | 62](#)

[1-Port Serial Mini-Physical Interface Module Supported Standards | 65](#)

[1-Port Serial Mini-Physical Interface Module Key Features | 63](#)

[1-Port Serial Mini-Physical Interface Module LEDs | 64](#)

[1-Port Serial Mini-Physical Interface Module Basic Configuration | 207](#)

1-Port Serial Mini-Physical Interface Module LEDs

The 1-Port Serial Mini-Physical Interface Module (Mini-PIM) has one LED located to the right of the serial port. [Table 34 on page 64](#) describes the LED states.

Table 34: 1-Port Serial Mini-PIM LED States

Name	Color	State	Description
STATUS	Green	On	Online with no alarms or failures.
		Off	Device has detected a failure.

RELATED DOCUMENTATION

[1-Port Serial Mini-Physical Interface Module Overview | 62](#)

[1-Port Serial Mini-Physical Interface Module Hardware Specifications | 63](#)

[1-Port Serial Mini-Physical Interface Module Supported Standards | 65](#)

[1-Port Serial Mini-Physical Interface Module Key Features | 63](#)

[1-Port Serial Mini-Physical Interface Module Basic Configuration | 207](#)

1-Port Serial Mini-Physical Interface Module Supported Standards

The 1-Port Serial Mini-Physical Interface Module (Mini-PIM) supports the following standards:

- TIA/EIA 530
- V.35
- X.21
- RS-232
- RS-449

RELATED DOCUMENTATION

[1-Port Serial Mini-Physical Interface Module Overview | 62](#)

[1-Port Serial Mini-Physical Interface Module Hardware Specifications | 63](#)

[1-Port Serial Mini-Physical Interface Module Key Features | 63](#)

[1-Port Serial Mini-Physical Interface Module LEDs | 64](#)

[1-Port Serial Mini-Physical Interface Module Basic Configuration | 207](#)

1-Port T1/E1 Mini-Physical Interface Module

IN THIS CHAPTER

- [1-Port T1/E1 Mini-Physical Interface Module Overview | 66](#)
- [1-Port T1/E1 Mini-Physical Interface Module Key Features | 67](#)
- [1-Port T1/E1 Mini-Physical Interface Module Hardware Specifications | 67](#)
- [1-Port T1/E1 Mini-Physical Interface Module LEDs | 68](#)
- [1-Port T1/E1 Mini-Physical Interface Module Supported Standards | 69](#)
- [1-Port T1/E1 Mini-Physical Interface Module Supported Loopback Diagnostics | 70](#)

1-Port T1/E1 Mini-Physical Interface Module Overview

The 1-Port T1/E1 Mini-Physical Interface Module (Mini-PIM) provides the physical connection to T1 or E1 network media types and also performs T1 or E1 framing and line-speed signaling.

[Figure 14 on page 66](#) shows the front panel of the 1-Port T1/E1 Mini-PIM.

Figure 14: 1-Port T1/E1 Mini-Physical Interface Module Front Panel

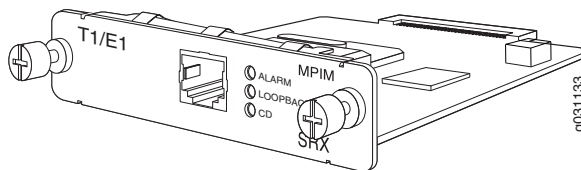

RELATED DOCUMENTATION

[1-Port T1/E1 Mini-Physical Interface Module Hardware Specifications | 67](#)

[1-Port T1/E1 Mini-Physical Interface Module Network Interface Specifications | 23](#)

[1-Port T1/E1 Mini-Physical Interface Module Supported Standards | 69](#)

[1-Port T1/E1 Mini-Physical Interface Module Key Features | 67](#)

[1-Port T1/E1 Mini-Physical Interface Module LEDs | 68](#)

[1-Port T1/E1 Mini-Physical Interface Module Supported Loopback Diagnostics | 70](#)

[1-Port T1/E1 Mini-Physical Interface Module Basic Configuration | 209](#)

1-Port T1/E1 Mini-Physical Interface Module Key Features

The 1-Port T1/E1 Mini-Physical Interface Module (Mini-PIM) provides the following key features:

- Channel service unit/data service unit (CSU/DSU) to eliminate the need for a separate external device
- 56-Kbps and 64-Kbps operating modes
- Independent internal and external clocking option
- Alarm reporting with a 24-hour history maintained
- Loopback, BERT, FDL (T1 only), and Long Buildout (T1 only) diagnostics
- Multilink Frame Relay and Multilink PPP support

RELATED DOCUMENTATION

[1-Port T1/E1 Mini-Physical Interface Module Overview | 66](#)

[1-Port T1/E1 Mini-Physical Interface Module Hardware Specifications | 67](#)

[1-Port T1/E1 Mini-Physical Interface Module Network Interface Specifications | 23](#)

[MTU Default and Maximum Values for Physical Interface Modules | 12](#)

[1-Port T1/E1 Mini-Physical Interface Module Supported Standards | 69](#)

[1-Port T1/E1 Mini-Physical Interface Module LEDs | 68](#)

[1-Port T1/E1 Mini-Physical Interface Module Supported Loopback Diagnostics | 70](#)

[1-Port T1/E1 Mini-Physical Interface Module Basic Configuration | 209](#)

1-Port T1/E1 Mini-Physical Interface Module Hardware Specifications

[Table 35 on page 68](#) gives the physical specifications of the 1-Port T1/E1 Mini-Physical Interface Module (Mini-PIM).

Table 35: 1-Port T1/E1 Mini-PIM Physical Specifications

Description	Value
Dimensions (H x W x L)	0.80 in. x 3.75 in. x 5.9 in. (2.0 cm x 9.5 cm x 14.5 cm)
Weight	2.88 oz (82 g)
Connector type	RJ-48
Form factor	Mini-PIM
Environmental operating temperature	32°F through 104°F (0°C through 40°C)
Storage temperature	-40°F through 158°F (-40°C through 70°C)
Relative humidity	5% to 90% noncondensing

RELATED DOCUMENTATION

[1-Port T1/E1 Mini-Physical Interface Module Overview | 66](#)

[1-Port T1/E1 Mini-Physical Interface Module Network Interface Specifications | 23](#)

[1-Port T1/E1 Mini-Physical Interface Module Supported Standards | 69](#)

[1-Port T1/E1 Mini-Physical Interface Module Key Features | 67](#)

[1-Port T1/E1 Mini-Physical Interface Module LEDs | 68](#)

[1-Port T1/E1 Mini-Physical Interface Module Supported Loopback Diagnostics | 70](#)

[1-Port T1/E1 Mini-Physical Interface Module Basic Configuration | 209](#)

1-Port T1/E1 Mini-Physical Interface Module LEDs

The 1-Port T1/E1 Mini-Physical Interface Module (Mini-PIM) has three LEDs. [Table 36 on page 69](#) describes the LED states.

Table 36: 1-Port T1/E1 Mini-PIM LED States

LED	Color	State	Description
ALARM	Yellow	On	Indicates that there is a local or remote alarm; device has detected a failure.
		Off	Indicates that there are no alarms or failures.
LOOPBACK	Yellow	On	Indicates that a loopback or line state is detected.
		Off	Indicates that the loopback is not active.
CD (Carrier Detector)	Green	On	Indicates that the Mini-PIM link is up.
		Off	Indicates that carrier detect is not active.

RELATED DOCUMENTATION

[1-Port T1/E1 Mini-Physical Interface Module Overview | 66](#)

[1-Port T1/E1 Mini-Physical Interface Module Hardware Specifications | 67](#)

[1-Port T1/E1 Mini-Physical Interface Module Network Interface Specifications | 23](#)

[1-Port T1/E1 Mini-Physical Interface Module Supported Standards | 69](#)

[1-Port T1/E1 Mini-Physical Interface Module Key Features | 67](#)

[1-Port T1/E1 Mini-Physical Interface Module Supported Loopback Diagnostics | 70](#)

[1-Port T1/E1 Mini-Physical Interface Module Basic Configuration | 209](#)

1-Port T1/E1 Mini-Physical Interface Module Supported Standards

The 1-Port T1/E1 Mini-Physical Interface Module (Mini-PIM) supports the following standards:

- ANSI T1.107, T1.102
- GR 499-core, GR 253-core
- AT&T Pub 54014
- ITU G.751, G.703

RELATED DOCUMENTATION

[1-Port T1/E1 Mini-Physical Interface Module Overview | 66](#)

[1-Port T1/E1 Mini-Physical Interface Module Hardware Specifications | 67](#)

[1-Port T1/E1 Mini-Physical Interface Module Network Interface Specifications | 23](#)

[1-Port T1/E1 Mini-Physical Interface Module Key Features | 67](#)

[1-Port T1/E1 Mini-Physical Interface Module LEDs | 68](#)

[1-Port T1/E1 Mini-Physical Interface Module Supported Loopback Diagnostics | 70](#)

[1-Port T1/E1 Mini-Physical Interface Module Basic Configuration | 209](#)

1-Port T1/E1 Mini-Physical Interface Module Supported Loopback Diagnostics

The 1-Port T1/E1 Mini-Physical Interface Module (Mini-PIM) has the following loopback diagnostics:

- Local, remote, payload
- Test patterns (BERT)
- All ones
- All zeros
- Alternating ones and zeros (AA/55)
- 1:3 or 1-in-4 pattern
- 1:7 or 1-in-8 pattern
- 3:24 - 3 bits set in every 24 bits
- QRSS20 (Modified PRBS $2^{20}-1$, with 14 zero suppression)
- PRBS 2^7-1 - PRBS 2^9-1 (as specified in ITU-T O.153)
- PRBS $2^{11}-1$ (as specified in ITU-T O.153)/2047 pattern
- PRBS $2^{15}-1$ (as specified in ITU-T O.151/O.153)
- PRBS $2^{20}-1$ (as specified in ITU-T O.153)
- Programmable word or 32-bit programmable pattern
- Network (T1) alarms
- LOS, LOF, AIS, YLW

RELATED DOCUMENTATION

[1-Port T1/E1 Mini-Physical Interface Module Overview | 66](#)

[1-Port T1/E1 Mini-Physical Interface Module Hardware Specifications | 67](#)

[1-Port T1/E1 Mini-Physical Interface Module Network Interface Specifications | 23](#)

[1-Port T1/E1 Mini-Physical Interface Module Supported Standards | 69](#)

[1-Port T1/E1 Mini-Physical Interface Module Key Features | 67](#)

[1-Port T1/E1 Mini-Physical Interface Module LEDs | 68](#)

[1-Port T1/E1 Mini-Physical Interface Module Basic Configuration | 209](#)

1-Port VDSL2 (Annex A) Mini-Physical Interface Module

IN THIS CHAPTER

- 1-Port VDSL2 (Annex A) Mini-Physical Interface Module Overview | 72
- 1-Port VDSL2 (Annex A) Mini-Physical Interface Module Key Features | 73
- 1-Port VDSL2 (Annex A) Mini-Physical Interface Module Hardware Specifications | 74
- 1-Port VDSL2 (Annex A) Mini-Physical Interface Module LEDs | 74
- 1-Port VDSL2 (Annex A) Mini-Physical Interface Module Supported Profiles | 75

1-Port VDSL2 (Annex A) Mini-Physical Interface Module Overview

Very-high-bit-rate digital subscriber line (VDSL) technology is part of the xDSL family of modem technologies, which provide faster data transmission over a single flat untwisted or twisted pair of copper wires.

The SRX210 Services Gateway supports the 1-Port VDSL2 (Annex A) Mini-Physical Interface Module (Mini-PIM). The 1-Port VDSL2 (Annex A) Mini-PIM carries the Ethernet backplane. When the Mini-PIM is plugged into the chassis, the Mini-PIM connects to one of the ports of the baseboard switch. The 1-Port VDSL2 (Annex A) Mini-PIM on the SRX Series Services Gateway provides ADSL backward compatibility.

The 1-Port VDSL2 (Annex A) Mini-PIM is compatible with the ITU-T G.993.2 (VDSL2) standard.

[Figure 15 on page 72](#) shows the 1-Port VDSL2 (Annex A) Mini-PIM.

Figure 15: VDSL2 Annex A Mini-PIM

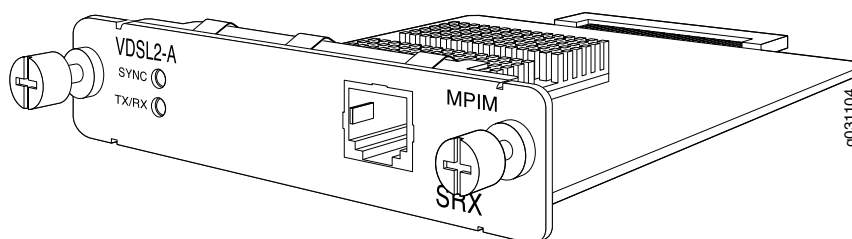

RELATED DOCUMENTATION

[1-Port VDSL2 \(Annex A\) Mini-Physical Interface Module Key Features | 73](#)

[1-Port VDSL2 \(Annex A\) Mini-Physical Interface Module Supported Profiles | 75](#)

[1-Port VDSL2 \(Annex A\) Mini-Physical Interface Module LEDs | 74](#)

[1-Port VDSL2 \(Annex A\) Mini-Physical Interface Module Hardware Specifications | 74](#)

[1-Port VDSL2 \(Annex A\) Mini-Physical Interface Module Cable Specifications | 141](#)

[1-Port VDSL2 \(Annex A\) Mini-Physical Interface Module Basic Configuration | 211](#)

1-Port VDSL2 (Annex A) Mini-Physical Interface Module Key Features

The following features are supported on the 1-Port VDSL2 (Annex A) Mini-Physical Interface Module (Mini-PIM):

- ADSL/ADSL2/ADSL2+ backward compatibility with Annex-A, Annex-M support
- Packet Mode Transfer (PTM) or Ethernet in the First Mile (EFM) (802.3ah) support
- Operation, Administration, and Maintenance (OAM) support for ADSL/ADSL2/ADSL2+ mode
- Asynchronous Transfer Mode (ATM) quality of service (QoS) (supported only when the VDSL2 Mini-PIM is operating in ADSL2 mode)
- Multilink Point-to-Point Protocol (MLPPP) (supported only when the VDSL2 Mini-PIM is operating in ADSL2 mode)
- Support for a maximum of 10 permanent virtual connections (PVCs) (only in ADSL/ADSL2/ADSL2+ mode)
- Dying Gasp support (ADSL and VDSL2 mode)

RELATED DOCUMENTATION

[1-Port VDSL2 \(Annex A\) Mini-Physical Interface Module Overview | 72](#)

[1-Port VDSL2 \(Annex A\) Mini-Physical Interface Module Supported Profiles | 75](#)

[1-Port VDSL2 \(Annex A\) Mini-Physical Interface Module LEDs | 74](#)

[1-Port VDSL2 \(Annex A\) Mini-Physical Interface Module Hardware Specifications | 74](#)

[MTU Default and Maximum Values for Physical Interface Modules | 12](#)

[1-Port VDSL2 \(Annex A\) Mini-Physical Interface Module Cable Specifications | 141](#)

[1-Port VDSL2 \(Annex A\) Mini-Physical Interface Module Basic Configuration | 211](#)

1-Port VDSL2 (Annex A) Mini-Physical Interface Module Hardware Specifications

Table 37 on page 74 gives the hardware specifications of the 1-Port VDSL2 (Annex A) Mini-Physical Interface Module (Mini-PIM).

Table 37: 1-Port VDSL2 (Annex A) Mini-PIM Hardware Specifications

Description	Value
Dimensions (H x W x L)	3.75 in. x 5.9 in. x 0.80 in. (9.5 cm x 14.5 cm x 2.0 cm)
Weight	4.0 oz (114 g)
Connector type	RJ-11
Form factor	Mini-PIM
Environmental operating temperature	32°F through 113°F (0°C through 45°C)
Storage temperature	-40°F through 158°F (-40°C through 70°C)
Relative humidity	5% to 90% noncondensing

RELATED DOCUMENTATION

[1-Port VDSL2 \(Annex A\) Mini-Physical Interface Module Overview | 72](#)

[1-Port VDSL2 \(Annex A\) Mini-Physical Interface Module Key Features | 73](#)

[1-Port VDSL2 \(Annex A\) Mini-Physical Interface Module Supported Profiles | 75](#)

[1-Port VDSL2 \(Annex A\) Mini-Physical Interface Module LEDs | 74](#)

[1-Port VDSL2 \(Annex A\) Mini-Physical Interface Module Cable Specifications | 141](#)

[1-Port VDSL2 \(Annex A\) Mini-Physical Interface Module Basic Configuration | 211](#)

1-Port VDSL2 (Annex A) Mini-Physical Interface Module LEDs

The 1-Port VDSL2 (Annex A) Mini-Physical Interface Module (Mini-PIM) has two LEDs. Table 38 on page 75 describes the LED states.

Table 38: 1-Port VDSL2 (Annex A) Mini-PIM LED States

LED	Color	State	Description
SYNC	Green	On	Indicates that the VDSL2 interface is trained.
		Blinking	Indicates training is in progress.
TX/RX	Green	Blinking	Indicates that traffic is passing through.
		Off	Indicates that no traffic is passing through.

RELATED DOCUMENTATION

[1-Port VDSL2 \(Annex A\) Mini-Physical Interface Module Overview | 72](#)

[1-Port VDSL2 \(Annex A\) Mini-Physical Interface Module Key Features | 73](#)

[1-Port VDSL2 \(Annex A\) Mini-Physical Interface Module Supported Profiles | 75](#)

[1-Port VDSL2 \(Annex A\) Mini-Physical Interface Module Hardware Specifications | 74](#)

[1-Port VDSL2 \(Annex A\) Mini-Physical Interface Module Cable Specifications | 141](#)

[1-Port VDSL2 \(Annex A\) Mini-Physical Interface Module Basic Configuration | 211](#)

1-Port VDSL2 (Annex A) Mini-Physical Interface Module Supported Profiles

A profile is a table that contains a list of preconfigured VDSL2 settings. [Table 39 on page 75](#) lists the different profiles supported on the 1-Port VDSL2 (Annex A) Mini-PIM, along with their data rates.

Table 39: Supported Profiles on the 1-Port VDSL2 Mini-PIM

Profiles	Data Rate
8a	50
8b	50
8c	50
8d	50
12a	68

Table 39: Supported Profiles on the 1-Port VDSL2 Mini-PIM (continued)

Profiles	Data Rate
12b	68
17a	100
Auto	Auto mode (default)

RELATED DOCUMENTATION

[1-Port VDSL2 \(Annex A\) Mini-Physical Interface Module Overview | 72](#)

[1-Port VDSL2 \(Annex A\) Mini-Physical Interface Module Key Features | 73](#)

[1-Port VDSL2 \(Annex A\) Mini-Physical Interface Module LEDs | 74](#)

[1-Port VDSL2 \(Annex A\) Mini-Physical Interface Module Hardware Specifications | 74](#)

[1-Port VDSL2 \(Annex A\) Mini-Physical Interface Module Cable Specifications | 141](#)

[1-Port VDSL2 \(Annex A\) Mini-Physical Interface Module Basic Configuration | 211](#)

1-Port Clear Channel DS3/E3 GPIM

IN THIS CHAPTER

- 1-Port Clear Channel DS3/E3 GPIM Overview | 77
- 1-Port Clear Channel DS3/E3 GPIM Components | 78
- 1-Port Clear Channel DS3/E3 GPIM Key Features | 79
- 1-Port Clear Channel DS3/E3 GPIM Hardware Specifications | 79
- 1-Port Clear Channel DS3/E3 GPIM LEDs | 80
- 1-Port Clear Channel DS3/E3 GPIM Supported Standards | 81
- 1-Port Clear Channel DS3/E3 GPIM Supported Loopback Diagnostics | 81

1-Port Clear Channel DS3/E3 GPIM Overview

The 1-Port Clear Channel DS3/E3 GPIM functions as a clear channel interface that can support DS3 (T3) or E3 line rates of 44.796 or 34.368 Mbps, respectively. The device does not support channelization, but it supports a subrate DS3/E3 configuration. The DS3/E3 interface is a popular high-bandwidth WAN interface for large enterprise branch locations that enables high-quality voice, video, and data applications with reduced latency. The clear channel implementation provides such features as subrate and scrambling options used by major DSU vendors. The interface also supports loopback, bit error rate test (BERT), and far-end alarm and control (FEAC) diagnostic capabilities. It supports Frame Relay, Point-to-Point Protocol (PPP), and High-Speed Data Link Control (HDLC) serial encapsulation protocols.

The 1-Port Clear Channel DS3/E3 GPIM is suitable for:

- Branch office and regional sites for medium-sized to large enterprises.
- Corporate headquarters for medium-sized enterprises.

The 1-Port Clear Channel DS3/E3 GPIM supports IP configurations. Using the command-line interface (CLI), you can configure the 1-Port Clear Channel DS3/E3 GPIM to operate in either DS3 or E3 mode.

The 1-Port Clear Channel DS3/E3 GPIM can be plugged into any GPIM slot on the services gateway. [Figure 16 on page 78](#) shows the front panel of the 1-Port Clear Channel DS3/E3 GPIM..

Figure 16: 1-Port Clear Channel DS3/E3 GPIM Front Panel

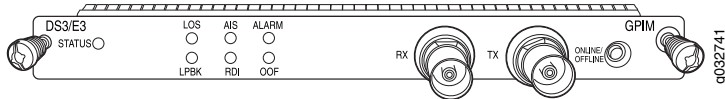

NOTE: Only the SRX650 Services Gateway supports hot-swappable functionality for GPIMs. The SRX550 Services Gateway does not support hot-swappable functionality for GPIMs.

1-Port Clear Channel DS3/E3 GPIM Components

The 1-Port Clear Channel DS3/E3 GPIM contains the components listed in [Table 40 on page 78](#).

Table 40: 1-Port Clear Channel DS3/E3 GPIM Components

Component	Location	Description
<p>ONLINE/OFFLINE button</p> <p>Only the SRX650 Services Gateway supports hot-swappable functionality for GPIMs. The SRX550 Services Gateway does not support hot-swappable functionality for GPIMs.</p>	Right side of the GPIM	<p>Use the ONLINE/OFFLINE button to gracefully shut down the GPIM. Press down and hold the button for 4 to 5 seconds; then release. The GPIM gracefully shuts down and turns off the power supply units (PSUs).</p> <p>To power up the GPIM (if the Services and Routing Engine [SRE] is off), press and hold the ONLINE/OFFLINE button for 4 to 5 seconds.</p>
TX and RX coaxial connectors	Middle/right of the GPIM	Dual 75-ohm BNC coaxial socket connectors: TX (transmit) and RX (receive).
Captive screws	One on each side of the GPIM	Use the captive screws to hold the GPIM in place.

1-Port Clear Channel DS3/E3 GPIM Key Features

The 1-Port Clear Channel DS3/E3 Gigabit-Backplane Physical Interface Module (GPIM) provides the following key features:

- Framed and unframed DS3/E3 modes
- Line encoding for DS3/E3 modes
- Support for Frame Relay, PPP, and HDLC serial encapsulation protocols
- External and internal clocking support
- Support for DS3/E3 network alarms
- Support for chassis clusters
- Support for anti-counterfeit check
- Loopback (local, remote, and payload) and BERT, PRBS, and QRSS diagnostics support
- Support for generation and detection of loopback control codes (line-loopback activate and deactivate) and FEAC codes
- Maximum transmission unit (MTU) size of 4474 bytes (default) and 9192 bytes (maximum)

1-Port Clear Channel DS3/E3 GPIM Hardware Specifications

The 1-Port Clear Channel DS3/E3 Gigabit-Backplane Physical Interface Module (GPIM) has the hardware specifications listed in [Table 41 on page 79](#).

Table 41: 1-Port Clear Channel DS3/E3 GPIM Hardware Specifications

Description	Value
Dimensions (H x W x L)	0.76 in. x 6.72 in. x 8.52 in. (19.2 mm x 170.8 mm x 216.4 mm)
Weight	1.11 lb (0.504 kg)
Connector type	DSX3 interface with dual 75-ohm BNC coaxial socket connectors (separate Tx/Rx)
Form factor	Single-high, single-wide GPIM
Environmental operating temperature	32°F through 104°F (0°C through 40°C)

Table 41: 1-Port Clear Channel DS3/E3 GPIM Hardware Specifications (*continued*)

Description	Value
Storage temperature	-40°F through 158°F (-40°C through 70°C)
Relative humidity	5% to 90% noncondensing
Altitude	Up to 10,000 ft (3,000 m)

1-Port Clear Channel DS3/E3 GPIM LEDs

The 1-Port Clear Channel DS3/E3 Gigabit-Backplane Physical Interface Module (GPIM) has the LEDs described in [Table 42 on page 80](#).

Table 42: 1-Port Clear Channel DS3/E3 GPIM LED States

LED	Color	State	Description
STATUS	Green	On	GPIM is online and functioning normally.
	Amber	On	GPIM is starting up, running diagnostics, or shutting down.
	Red	On	GPIM has failed.
		Off	GPIM has no power and can be removed safely.
LOS	Amber	On	Loss of signal online.
LPBK	Amber	On	Loopback is on.
AIS	Amber	On	Port is receiving alarm indication signal (AIS) alarm.
RDI	Amber	On	Port is receiving remote defect indication (RDI) alarm.
ALARM	Green	On	There are no alarms or defects.
	Red	On	An alarm or a defect is present.

Table 42: 1-Port Clear Channel DS3/E3 GPIM LED States (continued)

LED	Color	State	Description
OOF	Amber	On	Out-of-frame (OOF) RX multi-frame is not aligned.

1-Port Clear Channel DS3/E3 GPIM Supported Standards

The 1-Port Clear Channel DS3/E3 Gigabit-Backplane Physical Interface Module (GPIM) supports the following standards:

- DS3 mode standards:
 - ANSI T1.102, T1.107, T1.404
 - Telecordia GR 499-CORE, GR 253-CORE, GR 449-CORE
 - Telecordia TR-TSY-000009
 - AT&T Technical Reference 54014
- E3 mode standards:
 - ITU G.751, G.823, G.703
 - Telecordia GR 499-CORE

1-Port Clear Channel DS3/E3 GPIM Supported Loopback Diagnostics

The 1-Port Clear Channel DS3/E3 Gigabit-Backplane Physical Interface Module (GPIM) has the following loopback diagnostics:

- DS3 mode: local, remote, payload
- E3 mode: local and remote
- Test patterns (BERT):
 - All ones
 - All zeros
 - Alternating ones and zeros (AA/55)
 - PRBS $2^{15}-1$ (as specified in ITU-T 0.151)

- PRBS $2^{20}-1$ (as specified in ITU-T 0.153)
- PRBS $2^{23}-1$ (as specified in ITU-T 0.151)
- PRBS 2^9-1
- PRBS $2^{11}-1$
- PRBS $2^{29}-1$
- PRBS $2^{31}-1$
- QRSS $2^{20}-1$ (as specified in ITU-T 0.151)
- BERT results must be in the following form:
 - Received bit count
 - Received error count

In conformance with ANSI T1.107-1995, the 1-Port Clear Channel DS3/E3 GPIM supports both generation and detection of FEAC codes, as well as line-loopback activate and deactivate control codes.

2-Port 10-Gigabit Ethernet XPIM

IN THIS CHAPTER

- 2-Port 10-Gigabit Ethernet XPIM Overview | 83
- 2-Port 10-Gigabit Ethernet XPIM Components | 84
- 2-Port 10-Gigabit Ethernet XPIM Key Features | 87
- 2-Port 10 Gigabit Ethernet XPIM Hardware Specifications | 88
- 2-Port 10 Gigabit Ethernet XPIM LEDs | 90

2-Port 10-Gigabit Ethernet XPIM Overview

The 2-Port 10-Gigabit Ethernet XPIM provides a connection to high-speed Ethernet networks through branch WAN service and allows carriers to provide multiple levels of Ethernet service with a single connection option for all service ranges.

The 2-Port 10-Gigabit Ethernet XPIM can be installed only in the following slots, which provide 20G connectivity to the Services and Routing Engine (SRE) switch:

- Slot 6 on the SRX550 Services Gateway. See [Figure 17 on page 83](#).
- Slots 2 and 6 on the SRX650 Services Gateway. See [Figure 18 on page 84](#).

Figure 17: SRX550 Services Gateway Slot Numbers

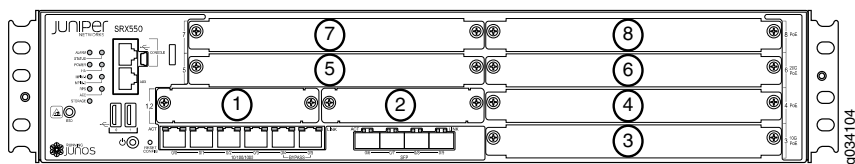
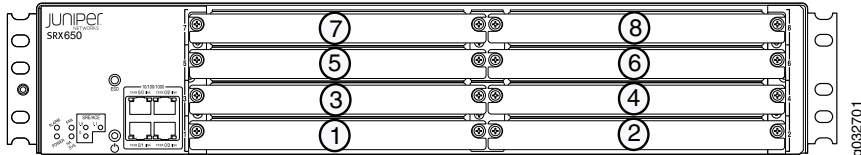

Figure 18: SRX650 Services Gateway Slot Numbers



The 2-Port 10-Gigabit Ethernet XPIM contains two 10-Gigabit Ethernet interfaces with both copper and small form-factor pluggable plus transceiver (SFP+) terminations, to support redundancy and enable the services gateway to be used as a pure security service device. The 2-Port 10-Gigabit Ethernet XPIM also provides effective MPLS/GRE termination of customer traffic with reasonable performance.

NOTE: Only the SRX650 Services Gateway supports hot-swappable functionality for GPIMs. The SRX550 Services Gateway does not support hot-swappable functionality for GPIMs.

Figure 19 on page 84 shows the 2-Port 10-Gigabit Ethernet XPIM.

Figure 19: 2-Port 10-Gigabit Ethernet XPIM

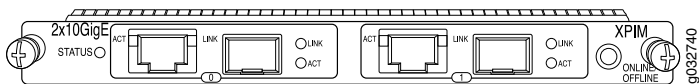

RELATED DOCUMENTATION

[2-Port 10-Gigabit Ethernet XPIM Key Features | 87](#)

[2-Port 10 Gigabit Ethernet XPIM Hardware Specifications | 88](#)

[2-Port 10 Gigabit Ethernet XPIM LEDs | 90](#)

[2-Port 10-Gigabit Ethernet XPIM Components | 84](#)

[2-Port 10-Gigabit Ethernet XPIM Basic Configuration | 217](#)

[Installing a Gigabit-Backplane Physical Interface Module on the SRX Series Services Gateway | 253](#)

2-Port 10-Gigabit Ethernet XPIM Components

The 2-Port 10 Gigabit Ethernet XPIM contains the components listed in [Table 43 on page 85](#).

Table 43: 2-Port 10 Gigabit Ethernet XPIM Components

Component	Location	Description
<p>XPIM ONLINE/OFFLINE button</p> <p>Only the SRX650 Services Gateway supports hot-swappable functionality for GPIMs. The SRX550 Services Gateway does not support hot-swappable functionality for GPIMs.</p>	Right side of the XPIM	Use the XPIM ONLINE/OFFLINE button to gracefully shut down the XPIM.
<p>Two groups of ports labeled 0 and 1, where each group contains 1 copper port and 1 fiber port.</p> <p>NOTE: By default, all ports are flow control enabled, and support link speed of 10 G in full-duplex mode.</p> <p>The 10 G fiber port does not support autonegotiation.</p> <p>Use the fiber ports to connect various SFP+ transceivers for fiber cable connections. See Table 44 on page 86 for supported SFP+ transceivers.</p>	Middle of the XPIM	<ul style="list-style-type: none"> ● Copper ports support link speeds of 10/100/1000 Mbps/10 G in full-duplex and half-duplex modes. ● Fiber ports support link speeds of 1000 Mbps/10 G in full-duplex mode. <p>NOTE: The 1 G fiber port configuration is supported starting with Junos OS Release 10.2R2.</p> <ul style="list-style-type: none"> ● Copper ports (for 10 G) use a CAT-6a or CAT-7 cable connector. ● Copper ports support autonegotiation; whereas fiber ports do not support autonegotiation. <p>NOTE: The 10 G fiber port does not support autonegotiation.</p> <ul style="list-style-type: none"> ● All ports support flow control and can be configured in loopback mode for testing purposes.
Captive screws	One on each side of the XPIM	Use the captive screws to hold the XPIM in place.

You can customize the Ethernet interface type by using different SFP+ transceivers. [Table 44 on page 86](#) shows the available SFP+ transceivers.



CAUTION: If you face a problem running a Juniper Networks device that uses a third-party optic or cable, the Juniper Networks Technical Assistance Center (JTAC) can help you diagnose the source of the problem. Your JTAC engineer might recommend that you check the third-party optic or cable and potentially replace it with an equivalent Juniper Networks optic or cable that is qualified for the device.

Table 44: 2-Port 10- Gigabit Ethernet XPIM SFP+ Transceivers

Product Number	Interface Type	Media	Connector
SFPP-10GE-SR	10GBase-SR Ethernet optical transceiver SFP, 26 m reach	MMF	LC
SFPP-10GE-LR	10GBase-LR Ethernet optical transceiver SFP, SMF, 10 Km reach	SMF	LC
SFPP-10GE-ER	10GBase-ER Ethernet optical transceiver SFP, 40 Km reach	SMF	LC
SFPP-10GE-LRM	10GBase-LRM Ethernet optical transceiver SFP, MMF, 220 m reach	MMF	LC
Copper Twin-AX 1m	10GE Ethernet cable assembly plugs into SFP+ socket, 15 m reach	Direct Attached 30 AWG	Cable connector with 1 m cable length
Copper Twin-AX 3m	10GE Ethernet cable assembly plugs into SFP+ socket, 15 m reach	Direct Attached 30 AWG	Cable connector with 3 m cable length
Copper Twin-AX 5m	10GE Ethernet cable assembly plugs into SFP+ socket, 15 m reach	Direct Attached 24 AWG	Cable connector with 5 m cable length
Copper Twin-AX 7m	10GE Ethernet cable assembly plugs into SFP+ socket, 15 m reach	Direct Attached 24 AWG	Cable connector with 7 m cable length

RELATED DOCUMENTATION

[2-Port 10-Gigabit Ethernet XPIM Overview | 83](#)

[2-Port 10-Gigabit Ethernet XPIM Key Features | 87](#)

[2-Port 10 Gigabit Ethernet XPIM Hardware Specifications | 88](#)

[2-Port 10 Gigabit Ethernet XPIM LEDs | 90](#)

[2-Port 10-Gigabit Ethernet XPIM Basic Configuration | 217](#)

2-Port 10-Gigabit Ethernet XPIM Key Features

The 2-Port 10-Gigabit Ethernet XPIM supports the following key features:

- Contains a total of four ports:
 - Two SFP+ fiber ports
 - Two 10 G Base-T copper ports

Only two of the four ports can be active at the same time (one from port group 0 and one from port group 1). Mixing and matching between the copper and fiber port types is supported.

- Receives SFP+ optics and, at a minimum, supports these SFP+ transceivers:
 - SFPP-10GE-SR
 - SFPP-10GE-LR
 - SFPP-10GE-ER
 - SFPP-10GE-LRM
 - Copper Twin-AX 1m
 - Copper Twin-AX 3m
 - Copper Twin-AX 5m
 - Copper Twin-AX 7m

NOTE: The 2-Port 10-Gigabit Ethernet XPIM does not support 1GE SFP transceivers.

- Anti-counterfeit capabilities.
- Quad speed support for copper mode: 10GBase-T IEEE 802.3an, 1000Base-T IEEE 802.3ab, 100Base-T IEEE 802.3u, and 10Base-T IEEE 802.3.
- Standard quality of service (QoS) features.

- User-configuration of fiber and copper ports:
 - When the interface is configured as a copper port, typical Ethernet configuration such as autonegotiation is supported. Forced rate and link mode are allowed. Four forced and autonegotiation rates are provided: 10 G and 1 G. Autonegotiation is required to establish link when rates are 1 G and 10 G. Copper ports support autonegotiation; whereas fiber ports do not support autonegotiation.

NOTE: The 1 G fiber port configuration is supported starting with Junos OS Release 10.2R2. The 10 G fiber port does not support autonegotiation.

- When the interface is configured as a fiber port, typical configurations similar to the 1 Gbps fiber (SFP) ports in the 24-Port Gigabit Ethernet XPIM are supported. See [“24-Port Gigabit Ethernet XPIM Overview” on page 111](#) for more details.
- Diagnostics for debugging and problem isolation.
- Operates in routed mode.
- SNMP support.
- J-Web support.

RELATED DOCUMENTATION

[2-Port 10-Gigabit Ethernet XPIM Overview | 83](#)

[2-Port 10 Gigabit Ethernet XPIM Hardware Specifications | 88](#)

[2-Port 10 Gigabit Ethernet XPIM LEDs | 90](#)

[2-Port 10-Gigabit Ethernet XPIM Components | 84](#)

[2-Port 10-Gigabit Ethernet XPIM Basic Configuration | 217](#)

2-Port 10 Gigabit Ethernet XPIM Hardware Specifications

The 2-Port 10 Gigabit Ethernet XPIM has the hardware specifications listed in [Table 45 on page 88](#).

Table 45: 2-Port 10 Gigabit Ethernet XPIM Hardware Specifications

Description	Value
Dimensions (H x W x L)	.78 in. H x 6.72 in. W x 8.01 in. L (1.98 cm x 17.08 cm x 20.57 cm)

Table 45: 2-Port 10 Gigabit Ethernet XPIM Hardware Specifications (continued)

Description	Value
Weight	18.6 oz (.53 kg)
Connector Types	<p>Contains a total of four ports:</p> <ul style="list-style-type: none"> • Two SFP+ fiber ports • Two 10 G Base-T copper ports <p>Port 0 is grouped as one copper port and one fiber port, and port 1 is grouped as one copper port and one fiber port. Mixing and matching between the copper and fiber ports is supported.</p>
Supported SFPs	<p>Receives SFP+ optics and, at a minimum, supports these SFP+ transceivers:</p> <ul style="list-style-type: none"> • SFPP-10GE-SR • SFPP-10GE-LR • SFPP-10GE-ER • SFPP-10GE-LRM • Copper Twin-AX 1m • Copper Twin-AX 3m
Form factor	Single-high, single-wide XPIM
Environmental operating temperature	32°F through 104°F (0°C through 40°C)
Storage temperature	-40°F through 158°F (-40°C through 70°C)
Relative humidity	5% to 90% noncondensing
Power consumption	Estimated at 20 W
Throughput	7.5 Gbps across two ports in routed mode

RELATED DOCUMENTATION

[2-Port 10-Gigabit Ethernet XPIM Overview | 83](#)

[2-Port 10-Gigabit Ethernet XPIM Key Features | 87](#)

[2-Port 10 Gigabit Ethernet XPIM LEDs | 90](#)

2-Port 10 Gigabit Ethernet XPIM LEDs

The 2-Port 10 Gigabit Ethernet XPIM has the LEDs listed in [Table 46 on page 90](#).

Table 46: 2-Port 10 Gigabit Ethernet XPIM LED States

LED	Color	State	Description
STATUS	Green	On	XPIM is online and functioning normally.
	Amber	On	XPIM is starting up, running diagnostics, or shutting down.
	Red	On	XPIM has failed.
		Off	XPIM has no power and can be pulled out safely.
LINK/ACT for fiber ports	Link Green	On	Port is online.
		Off	Port is offline.
	Activity Green	Blinking	Port is sending data. NOTE: For fiber ports, the Activity LED does not blink when the port is only receiving data.
		Off	Port might be on but is not receiving or sending data.
LINK/ACT for copper ports NOTE: Each port has two LEDs; one on either side of the port. The left LED is activity and the right is link.	Link Green	On	Port is online.
		Off	Port is offline.
	Activity Green	Blinking	Port is sending data.
		Off	Port might be on but is not receiving or sending data.

Figure 20 on page 91 shows the 2-Port 10 Gigabit Ethernet XPIM.

Figure 20: 2-Port 10 Gigabit Ethernet XPIM

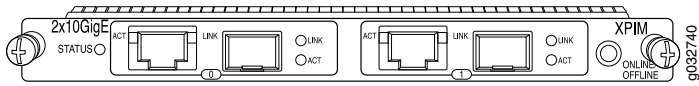

RELATED DOCUMENTATION

[2-Port 10-Gigabit Ethernet XPIM Overview | 83](#)

[2-Port 10-Gigabit Ethernet XPIM Key Features | 87](#)

[2-Port 10 Gigabit Ethernet XPIM Hardware Specifications | 88](#)

[2-Port 10-Gigabit Ethernet XPIM Components | 84](#)

[2-Port 10-Gigabit Ethernet XPIM Basic Configuration | 217](#)

8-Port Gigabit Ethernet SFP XPIM

IN THIS CHAPTER

- 8-Port Gigabit Ethernet SFP XPIM Overview | 92
- 8-Port Gigabit Ethernet SFP XPIM Components | 93
- 8-Port Gigabit Ethernet SFP XPIM Key Features | 94
- 8-Port Gigabit Ethernet SFP XPIM Hardware Specifications | 95
- 8-Port Gigabit Ethernet SFP XPIM LEDs | 96
- 8-Port Gigabit Ethernet SFP XPIM Supported Modules | 97

8-Port Gigabit Ethernet SFP XPIM Overview

The ports of the 8-Port Gigabit Ethernet small form-factor pluggable Gigabit-Backplane Physical Interface Module (SFP XPIM) can be used for connecting to Ethernet WAN service as well as for local server connectivity at Gigabit Ethernet speeds. The XPIM enables Layer 2 line-rate Gigabit switching and system-processor dependent Layer 3 service with connection of up to eight SFP Gigabit Ethernet ports. The 8-Port Gigabit Ethernet SFP XPIM complements the on-board 10/100/1000 Mbps Ethernet interfaces with extended WAN connectivity. It supports a variety of transceivers. This XPIM can be used in copper and optical environments to provide maximum flexibility when upgrading from an existing infrastructure to Metro Ethernet.

The 8-Port Gigabit Ethernet XPIM can be installed in any GPIM slot on the SRX550 and SRX650 Services Gateways.

The earliest supported release on the 8-Port Gigabit Ethernet XPIM is Junos OS Release 12.1X44-D10.

[Figure 21 on page 92](#) shows the front panel of the 8-Port Gigabit Ethernet SFP XPIM.

Figure 21: 8-Port Gigabit Ethernet SFP XPIM Front Panel

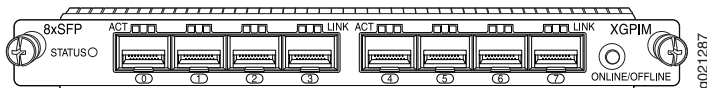

RELATED DOCUMENTATION

- [8-Port Gigabit Ethernet SFP XPIM Hardware Specifications | 95](#)

- [8-Port Gigabit Ethernet SFP XPIM Network Interface Specifications | 26](#)

- [8-Port Gigabit Ethernet SFP XPIM Supported Modules | 97](#)

- [8-Port Gigabit Ethernet SFP XPIM Key Features | 94](#)

- [8-Port Gigabit Ethernet SFP XPIM LEDs | 96](#)

- [8-Port Gigabit Ethernet SFP XPIM Components | 93](#)

- [8-Port Gigabit Ethernet SFP XPIM Basic Configuration | 221](#)

8-Port Gigabit Ethernet SFP XPIM Components

The 8-Port Gigabit Ethernet small form-factor pluggable Gigabit-Backplane Physical Interface Module (SFP XPIM) contains the components listed in [Table 47 on page 93](#).

Table 47: 8-Port Gigabit Ethernet SFP XPIM Components

Component	Location	Description
ONLINE/OFFLINE button	Right side of the XPIM	Use the ONLINE/OFFLINE button to gracefully shut down the XPIM. Press down and hold the button for 4 to 5 seconds; then release. The XPIM gracefully shuts down and turns off the power supply units (PSUs). To power up the XPIM (if the Services and Routing Engine [SRE] is off), press and hold the ONLINE/OFFLINE button for 4 to 5 seconds.
TX and RX coaxial connectors	Middle/right of the XPIM	Dual 75-ohm BNC coaxial socket connectors: TX (transmit) and RX (receive).
Two captive screws	One on each side of the XPIM	Use the captive screws to hold the XPIM in place.

RELATED DOCUMENTATION

- [8-Port Gigabit Ethernet SFP XPIM Overview | 92](#)

- [8-Port Gigabit Ethernet SFP XPIM Hardware Specifications | 95](#)

[8-Port Gigabit Ethernet SFP XPIM Network Interface Specifications | 26](#)

[8-Port Gigabit Ethernet SFP XPIM Supported Modules | 97](#)

[8-Port Gigabit Ethernet SFP XPIM Key Features | 94](#)

[8-Port Gigabit Ethernet SFP XPIM LEDs | 96](#)

[8-Port Gigabit Ethernet SFP XPIM Basic Configuration | 221](#)

8-Port Gigabit Ethernet SFP XPIM Key Features

The 8-Port Gigabit Ethernet small form-factor pluggable XPIM (SFP XPIM) has the following key features:

- 8 triple-speed (10/100/1000 Mbps) Ethernet ports, double-high card
- PoE not supported
- PCI-Express interface for control and management
- I2C interface for module monitor and identification
- Maximum module power of 40.0 W without PoE
- JTAG support for boundary scan test



CAUTION: If you face a problem running a Juniper Networks device that uses a third-party optic or cable, the Juniper Networks Technical Assistance Center (JTAC) can help you diagnose the source of the problem. Your JTAC engineer might recommend that you check the third-party optic or cable and potentially replace it with an equivalent Juniper Networks optic or cable that is qualified for the device.

RELATED DOCUMENTATION

[8-Port Gigabit Ethernet SFP XPIM Overview | 92](#)

[8-Port Gigabit Ethernet SFP XPIM Hardware Specifications | 95](#)

[8-Port Gigabit Ethernet SFP XPIM Network Interface Specifications | 26](#)

[8-Port Gigabit Ethernet SFP XPIM Supported Modules | 97](#)

[8-Port Gigabit Ethernet SFP XPIM LEDs | 96](#)

[8-Port Gigabit Ethernet SFP XPIM Components | 93](#)

[8-Port Gigabit Ethernet SFP XPIM Basic Configuration | 221](#)

8-Port Gigabit Ethernet SFP XPIM Hardware Specifications

Table 48 on page 95 gives the physical specifications of the 8-Port Gigabit Ethernet small form-factor pluggable XPIM (SFP XPIM).

Table 48: 8-Port Gigabit Ethernet SFP XPIM Physical Specifications

Description	Value
Dimensions (H x W x L)	0.78 in. x 6.72 in. x 8.1 in. (1.98 cm x 17.1 cm x 20.57 cm)
Weight	17.6 oz (0.499 kg)
Connector type	SFP
Form factor	XPIM
Environmental operating temperature	32°F through 104°F (0°C through 40°C)
Relative humidity	5% to 90% noncondensing
Altitude	Up to 10,000 ft (3000 m)

RELATED DOCUMENTATION

[8-Port Gigabit Ethernet SFP XPIM Overview | 92](#)

[8-Port Gigabit Ethernet SFP XPIM Network Interface Specifications | 26](#)

[8-Port Gigabit Ethernet SFP XPIM Supported Modules | 97](#)

[8-Port Gigabit Ethernet SFP XPIM Key Features | 94](#)

[8-Port Gigabit Ethernet SFP XPIM LEDs | 96](#)

[8-Port Gigabit Ethernet SFP XPIM Components | 93](#)

[8-Port Gigabit Ethernet SFP XPIM Basic Configuration | 221](#)

8-Port Gigabit Ethernet SFP XPIM LEDs

The 8-Port Gigabit Ethernet small form-factor pluggable XPIM (SFP XPIM) has two LEDs for each port – LINK and ACT. Each XPIM has a STATUS LED, which indicates the status of the XPIM. The LEDs are listed in [Table 49 on page 96](#). See [“8-Port Gigabit Ethernet SFP XPIM Overview” on page 92](#) for more information.

Table 49: 8-Port Gigabit Ethernet SFP XPIM LED States

LED	Color	State	Description
LINK	Green	On	Port is online.
		Off	Port is offline.
ACT	Green	Blinking	Port is receiving or sending data.
		Off	Port might be online but, is not receiving or sending data.
STATUS	Green	On	The GPIM is functioning normally.
	Yellow		The GPIM is starting up, running diagnostics, or going offline.
	Red		The GPIM has failed.
		Off	The GPIM is not powered on, is offline, or is not configured.

RELATED DOCUMENTATION

[8-Port Gigabit Ethernet SFP XPIM Overview | 92](#)

[8-Port Gigabit Ethernet SFP XPIM Hardware Specifications | 95](#)

[8-Port Gigabit Ethernet SFP XPIM Network Interface Specifications | 26](#)

[8-Port Gigabit Ethernet SFP XPIM Supported Modules | 97](#)

[8-Port Gigabit Ethernet SFP XPIM Key Features | 94](#)

[8-Port Gigabit Ethernet SFP XPIM Components | 93](#)

[8-Port Gigabit Ethernet SFP XPIM Basic Configuration | 221](#)

8-Port Gigabit Ethernet SFP XPIM Supported Modules

You can customize the Ethernet interface type by using different 1-port small form-factor pluggable (SFP) modules. [Table 50 on page 97](#) shows the SFP transceivers and cables supported on the 8-port Gigabit Ethernet SFP modules for XPIMs.

Table 50: 8-Port Gigabit Ethernet SFP XPIM Supported Modules

Juniper Product Number	Connector Type (SFP Transceiver)	Cable
SRX-SFP-FE-FX EX-SFP-1FE-FX	100BASE-FX	LC
SRX-SFP-1GE-LH EX-SFP-1GE-LH	1000BASE-LH	LC
SRX-SFP-1GE-LX EX-SFP-1GE-LX	1000BASE-LX	LC
SRX-SFP-1GE-SX EX-SFP-1GE-SX	1000BASE-SX	LC
SRX-SFP-1GE-T EX-SFP-1GE-T	1000BASE-T, Copper Transceiver	CAT-5e
EX-SFP-GE10KT13R14	1000BASE-BX10, at 10km (TX1310nm / RX1490nm)	LC
EX-SFP-GE10KT13R15	1000BASE-BX10, at 10km (TX1310nm / RX1550nm)	LC
EX-SFP-GE10KT14R13	1000BASE-BX10, at 10km (TX1490nm / RX1310nm)	LC
EX-SFP-GE10KT15R13	1000BASE-BX10, at 10km (TX1550nm / RX1310nm)	LC
EX-SFP-FE20KT13R15	100Base-BX Fast Ethernet Optics, at 20km (TX 1310nm / RX 1550nm)	LC
EX-SFP-FE20KT15R13	100Base-BX Fast Ethernet Optics, at 20km (TX 1550nm / RX 1310nm)	LC
EX-SFP-GE40KT13R15	1000BASE-BX, at 40km (TX1310nm / 1550nm)	LC

Table 50: 8-Port Gigabit Ethernet SFP XPIM Supported Modules (continued)

Juniper Product Number	Connector Type (SFP Transceiver)	Cable
EX-SFP-GE40KT15R13	1000BASE-BX, at 40km (TX1550nm / RX1310nm)	LC



CAUTION: If you face a problem running a Juniper Networks device that uses a third-party optic or cable, the Juniper Networks Technical Assistance Center (JTAC) can help you diagnose the source of the problem. Your JTAC engineer might recommend that you check the third-party optic or cable and potentially replace it with an equivalent Juniper Networks optic or cable that is qualified for the device.

RELATED DOCUMENTATION

[8-Port Gigabit Ethernet SFP XPIM Overview | 92](#)

[8-Port Gigabit Ethernet SFP XPIM Hardware Specifications | 95](#)

[8-Port Gigabit Ethernet SFP XPIM Network Interface Specifications | 26](#)

[8-Port Gigabit Ethernet SFP XPIM Key Features | 94](#)

[8-Port Gigabit Ethernet SFP XPIM LEDs | 96](#)

[8-Port Gigabit Ethernet SFP XPIM Components | 93](#)

[8-Port Gigabit Ethernet SFP XPIM Basic Configuration | 221](#)

8-Port Serial GPIM

IN THIS CHAPTER

- 8-Port Serial GPIM Overview | 99
- 8-Port Serial GPIM Components | 100
- 8-Port Serial GPIM Key Features | 101
- 8-Port Serial GPIM Hardware Specifications | 102
- 8-Port Serial GPIM LEDs | 103

8-Port Serial GPIM Overview

The 8-Port Serial Gigabit-Backplane Physical Interface Module (GPIM) is a hot-swappable network interface card (NIC) that installs in the front slots of the SRX650 and SRX550 Services Gateways to provide physical connections to a WAN. It can be plugged in all the slots of SRX650 and SRX550 Services Gateways. After you install the GPIM in the services gateway, you configure a network interface on the GPIM. It provides higher port density and flexible support for universal serial ports including a wide array of interface options such as synchronous support.

NOTE: Only the SRX650 Services Gateway supports hot-swappable functionality for GPIMs. The SRX550 Services Gateway does not support hot-swappable functionality for GPIMs.

All the ports of the 8-Port Serial GPIM are connected to two dual stacked 136-pin VHDCI connectors. Custom cables are used to connect from the VHDCI connectors to data terminal equipment (DTE) or data circuit-terminating equipment (DCE). Different cables are required to support different protocols. The protocols that a cable supports are identified using the cable ID. The cables are labeled with a letter (refers to the cable type) and four digits (unique serial numbers for the cables).

Figure 22: 8-Port Serial GPIM Front Panel

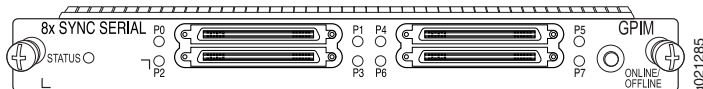

RELATED DOCUMENTATION

[8-Port Serial GPIM Hardware Specifications | 102](#)

[8-Port Serial GPIM Components | 100](#)

[8-Port Serial GPIM Key Features | 101](#)

[8-Port Serial GPIM LEDs | 103](#)

[8-Port Serial GPIM Interface Cables | 157](#)

[8-Port Serial GPIM Interface Specifications | 27](#)

[8-Port Serial GPIM Basic Configuration | 225](#)

8-Port Serial GPIM Components

Table 51 on page 100 lists the components of the 8-Port Serial Gigabit-Backplane Physical Interface Module (GPIM).

Table 51: 8-Port Serial GPIM Components

Component	Location	Description
<p>ONLINE/OFFLINE button</p> <p>Only the SRX650 Services Gateway supports hot-swappable functionality for GPIMs. The SRX550 Services Gateway does not support hot-swappable functionality for GPIMs.</p>	Right side of the GPIM	<p>Use the ONLINE/OFFLINE button to gracefully shut down the GPIM. Press down and hold the button for 4 to 5 seconds and then release. The GPIM gracefully shuts down and turns off the power supply units (PSUs).</p> <p>To power up the GPIM (if the Services and Routing Engine is off), press and hold the ONLINE/OFFLINE button for 4 to 5 seconds.</p>
Connector	Middle or right of the GPIM	Two dual stacked 136-pin VHDCI connectors. Custom cables are used to connect from the VHDCI connectors to the data terminal equipment (DTE) or the data circuit-terminating equipment (DCE)
Captive screws	One on each side of the GPIM	Use the captive screws to hold the GPIM in place.

RELATED DOCUMENTATION

[8-Port Serial GPIM Overview | 99](#)

[8-Port Serial GPIM Hardware Specifications | 102](#)

[8-Port Serial GPIM Key Features | 101](#)

[8-Port Serial GPIM LEDs | 103](#)

[8-Port Serial GPIM Interface Cables | 157](#)

[8-Port Serial GPIM Interface Specifications | 27](#)

[8-Port Serial GPIM Basic Configuration | 225](#)

8-Port Serial GPIM Key Features

The 8-Port Serial Gigabit-Backplane Physical Interface Module (GPIM) provides the following key features:

- Autoselection of operational modes based on data terminal equipment (DTE) or data circuit-terminating equipment (DCE) cables
- Local, remote, and dce-local loopback diagnostics
- Clock rate from 1.2 KHz to 8 MHz
- Clocking mode—DCE clock, Internal (Baud) clock, and External (loop) clock
- Complete configuration and management using the CLI
- Maximum transmission unit (MTU) values of 1504 bytes (default) and 9192 bytes (maximum)
- Line encoding for NRZ and NRZI modes
- Support for Frame Relay, PPP (PAP/CHAP), Cisco-HDLC, MLFR, and MLPPP (with the maximum throughput at 44 Mbps for 64-byte packet).
- Support for data signal and control signal alarms
- Support for invert data
- Support for Serial auto-resync
- Support for loopback modes (local and remote) and for ignoring control signals
- Support for receiving SNMP information at each port

RELATED DOCUMENTATION

[8-Port Serial GPIM Overview | 99](#)

[8-Port Serial GPIM Hardware Specifications | 102](#)

[8-Port Serial GPIM Components | 100](#)

[8-Port Serial GPIM LEDs | 103](#)

[8-Port Serial GPIM Interface Cables | 157](#)

[8-Port Serial GPIM Interface Specifications | 27](#)

[8-Port Serial GPIM Basic Configuration | 225](#)

8-Port Serial GPIM Hardware Specifications

Table 52 on page 102 lists the hardware specifications of the 8-Port Serial Gigabit-Backplane Physical Interface Module (GPIM).

Table 52: 8-Port Serial GPIM Hardware Specifications

Description	Value
Dimensions (H x W x L)	0.756 in. x 6.723 in. x 8.234 in. (1.921 cm x 17.079 cm x 20.916 cm)
Weight	16.6 oz (0.470 kg)
Connector type	Two dual stacked 136-pin VHDCI connectors. Custom cables are used to connect from VHDCI connector to data terminal equipment (DTE) or data circuit-terminating equipment (DCE)
Form factor	Single-high, single-wide GPIM
Environmental operating temperature	32°F through 104°F (0°C through 40°C)
Storage temperature	-40°F through 158°F (-40°C through 70°C)
Relative humidity	5% to 90% noncondensing
Altitude	Up to 10,000 ft (3,000 m)

RELATED DOCUMENTATION

[8-Port Serial GPIM Overview | 99](#)

8-Port Serial GPIM Components 100
8-Port Serial GPIM Key Features 101
8-Port Serial GPIM LEDs 103
8-Port Serial GPIM Interface Cables 157
8-Port Serial GPIM Interface Specifications 27
8-Port Serial GPIM Basic Configuration 225

8-Port Serial GPIM LEDs

Table 53 on page 103 lists the LEDs of the 8-Port Serial Gigabit-Backplane Physical Interface Module (GPIM).

Table 53: 8-Port Serial GPIM LED States

LED	Color	State	Description
STATUS	Green	On	GPIM is online and functioning normally.
	Yellow	On	GPIM is starting up, running diagnostics, or shutting down.
	Red	On	GPIM has failed.
		Off	GPIM has no power and can be removed safely.
P0 - P7	Yellow	On	An alarm is present.
	Green	On	Alarm is not present.

RELATED DOCUMENTATION

8-Port Serial GPIM Overview 99
8-Port Serial GPIM Hardware Specifications 102
8-Port Serial GPIM Components 100
8-Port Serial GPIM Key Features 101
8-Port Serial GPIM Interface Cables 157
8-Port Serial GPIM Interface Specifications 27
8-Port Serial GPIM Basic Configuration 225

16-Port Gigabit Ethernet XPIM

IN THIS CHAPTER

- 16-Port Gigabit Ethernet XPIM Overview | 104
- 16-Port Gigabit Ethernet XPIM Components | 105
- 16-Port Gigabit Ethernet XPIM Key Features | 107
- 16-Port Gigabit Ethernet XPIM Hardware Specifications | 107
- 16-Port Gigabit Ethernet XPIM LEDs | 108

16-Port Gigabit Ethernet XPIM Overview

The 16-Port Gigabit Ethernet XPIM is a double-high, single-wide LAN switch Gigabit-Backplane Physical Interface Module (GPIM) that uses two standard slots vertically. It is available with or without Power over Ethernet (PoE) support. The PoE GPIMs provide ports that supply electric power over the same ports that are used to connect network devices. For more information about PoE, see [“Power over Ethernet Support on SRX Series Services Gateway Interfaces”](#) on page 15.

The 16-Port Gigabit Ethernet XPIM must be installed in one of the following 20-Gigabit slots on the services gateway:

- SRX550—Slot 3 or 6

NOTE: The 16-Port Gigabit Ethernet XPIM is supported on both slot 3 and slot 6 of the SRX550 Services Gateway. However, the performance (bandwidth) in slot 3 will be limited as it has a 10G back link.

- SRX650—Slot 2 or 6

NOTE: Only the SRX650 Services Gateway supports hot-swappable functionality for GPIMs. The SRX550 Services Gateway does not support hot-swappable functionality for GPIMs.

The earliest supported release on the 16-Port Gigabit Ethernet XPIM is Junos OS Release 9.5.

Figure 23: 16-Port Gigabit Ethernet XPIM

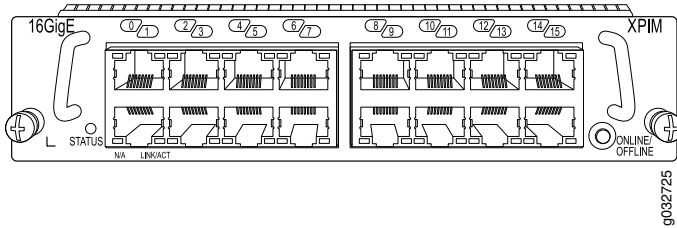
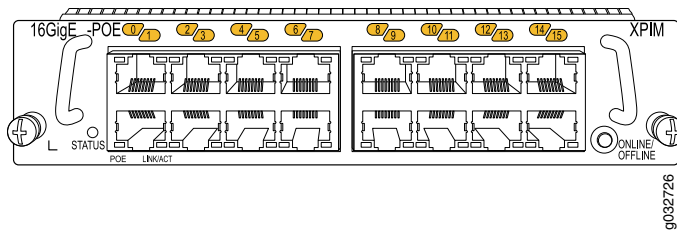

Figure 24: 16-Port Gigabit Ethernet with PoE XPIM



RELATED DOCUMENTATION

[16-Port Gigabit Ethernet XPIM Key Features | 107](#)

[16-Port Gigabit Ethernet XPIM Hardware Specifications | 107](#)

[16-Port Gigabit Ethernet XPIM LEDs | 108](#)

[16-Port Gigabit Ethernet XPIM Components | 105](#)

[16-Port Gigabit Ethernet XPIM Basic Configuration | 229](#)

16-Port Gigabit Ethernet XPIM Components

The 16-Port Gigabit Ethernet XPIM contains the components listed in [Table 54 on page 106](#).

Table 54: 16-Port Gigabit Ethernet XPIM Components

Component	Location	Description
<p>XPIM ONLINE/OFFLINE button</p> <p>Only the SRX650 Services Gateway supports hot-swappable functionality for GPIMs. The SRX550 Services Gateway does not support hot-swappable functionality for GPIMs.</p>	Right side of the XPIM	Use the XPIM ONLINE/OFFLINE button to gracefully shut down the XPIM.
<p>16 fixed Gigabit Ethernet ports labeled 0 to 15</p> <p>NOTE: The 16-Port Gigabit Ethernet with PoE XPIM port labels are yellow instead of white.</p>	Middle of the XPIM	<p>NOTE: Each port on the 16-Port Gigabit Ethernet with PoE XPIM supports Power over Ethernet (PoE).</p> <p>Each Gigabit Ethernet port:</p> <ul style="list-style-type: none"> • Provides link speeds of 10/100/1000 Mbps • Uses an RJ-45 connector • Operates in full-duplex and half-duplex modes • Supports flow control • Supports autonegotiation
Captive screws	One on each side of the XPIM	Use the captive screws to hold the XPIM in place in the services gateway.
Handles	One on each side of the XPIM	Use the handles to grasp the XPIM for installation or removal.

RELATED DOCUMENTATION

[16-Port Gigabit Ethernet XPIM Overview | 104](#)

[16-Port Gigabit Ethernet XPIM Key Features | 107](#)

[16-Port Gigabit Ethernet XPIM Hardware Specifications | 107](#)

[16-Port Gigabit Ethernet XPIM LEDs | 108](#)

[16-Port Gigabit Ethernet XPIM Basic Configuration | 229](#)

[Power over Ethernet Support on SRX Series Services Gateway Interfaces | 15](#)

16-Port Gigabit Ethernet XPIM Key Features

The 16-Port Gigabit Ethernet XPIM has the following key features:

- 16 triple-speed (10/100/1000 Mbps) Ethernet ports, double-high card
- PoE support for all ports
- PCI-Express interface for control and management
- I2C interface for module monitor and identification
- Maximum module power of 40.0 W without PoE
- JTAG support for boundary scan test

RELATED DOCUMENTATION

[16-Port Gigabit Ethernet XPIM Overview | 104](#)

[16-Port Gigabit Ethernet XPIM Hardware Specifications | 107](#)

[16-Port Gigabit Ethernet XPIM LEDs | 108](#)

[16-Port Gigabit Ethernet XPIM Components | 105](#)

[16-Port Gigabit Ethernet XPIM Basic Configuration | 229](#)

16-Port Gigabit Ethernet XPIM Hardware Specifications

The 16-Port Gigabit Ethernet XPIM has the specifications listed in [Table 55 on page 107](#).

Table 55: 16-Port Gigabit Ethernet XPIM Hardware Specifications

Description	Value
Dimensions (H x W x L)	1.58 in. H x 6.72 in. W x 8.5 in. L (4.0 cm x 17.1 cm x 21.6 cm)
Weight	16.5 oz (0.68 kg)
Connector type	16 RJ-45
Form factor	Double-high, single-wide XPIM
Environmental operating temperature	32°F through 104°F (0°C through 40°C)

Table 55: 16-Port Gigabit Ethernet XPIM Hardware Specifications (*continued*)

Description	Value
Storage temperature	-40°F through 158°F (-40°C through 70°C)
Relative humidity	5% to 90% noncondensing

RELATED DOCUMENTATION

[16-Port Gigabit Ethernet XPIM Overview | 104](#)

[16-Port Gigabit Ethernet XPIM Key Features | 107](#)

[16-Port Gigabit Ethernet XPIM LEDs | 108](#)

[16-Port Gigabit Ethernet XPIM Components | 105](#)

[16-Port Gigabit Ethernet XPIM Basic Configuration | 229](#)

16-Port Gigabit Ethernet XPIM LEDs

The 16-Port Gigabit Ethernet XPIM has the LEDs listed in [Table 56 on page 108](#).

Table 56: 16-Port Gigabit Ethernet XPIM LED States

LED	Color	State	Description
STATUS	Green	On	XPIM is online and functioning normally.
	Amber	On	XPIM is starting up, running diagnostics, or shutting down.
	Red	On	XPIM has failed.
LINK/ACT	Green	On	Port is online.
		Off	Port is offline.
		Blinking	Port is receiving or sending data.

Table 56: 16-Port Gigabit Ethernet XPIM LED States (continued)

LED	Color	State	Description
N/A	N/A	N/A	Not used on the non-PoE XPIM.
PoE	Green	On	Port is PoE enabled and online.
		Off	Port is offline.
		Blinking	Port is PoE enabled and receiving or sending data.

Figure 25: 16-Port Gigabit Ethernet XPIM

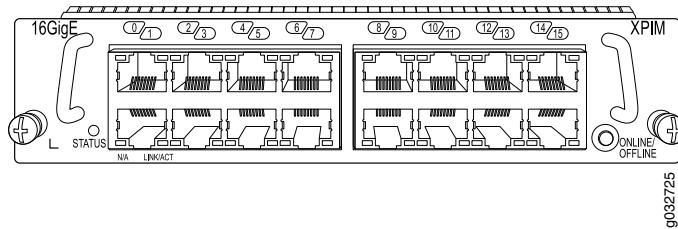
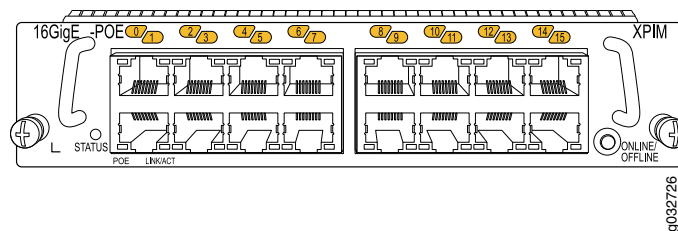

Figure 26: 16-Port Gigabit Ethernet with PoE XPIM



RELATED DOCUMENTATION

[16-Port Gigabit Ethernet XPIM Overview | 104](#)

[16-Port Gigabit Ethernet XPIM Key Features | 107](#)

[16-Port Gigabit Ethernet XPIM Hardware Specifications | 107](#)

16-Port Gigabit Ethernet XPIM Components | 105

16-Port Gigabit Ethernet XPIM Basic Configuration | 229

Power over Ethernet Support on SRX Series Services Gateway Interfaces | 15

24-Port Gigabit Ethernet XPIM

IN THIS CHAPTER

- 24-Port Gigabit Ethernet XPIM Overview | 111
- 24-Port Gigabit Ethernet XPIM Components | 112
- 24-Port Gigabit Ethernet XPIM Key Features | 115
- 24-Port Gigabit Ethernet XPIM Hardware Specifications | 116
- 24-Port Gigabit Ethernet XPIM LEDs | 117

24-Port Gigabit Ethernet XPIM Overview

The 24-Port Gigabit Ethernet XPIM is a double-high, double-wide LAN switch Gigabit-Backplane Physical Interface Module (GPIM) that uses two standard slots vertically and two standard slots horizontally. It is available with or without Power over Ethernet (PoE) support. The PoE GPIMs provide ports that supply electric power over the same ports that are used to connect network devices. For more information about PoE, see [“Power over Ethernet Support on SRX Series Services Gateway Interfaces”](#) on page 15.

The 24-Port XPIM must be installed in specific GPIM slot groupings as shown in [Table 57](#) on page 111.

Table 57: Slot Groups for the 24-Port Gigabit Ethernet XPIM

Device	Slot Groups for the 24-Port Gigabit Ethernet XPIM
SRX550 Services Gateway	Top four standard slots (slots 5, 6, 7, and 8)
SRX650 Services Gateway	Bottom four standard slots (slots 1, 2, 3, and 4) and top four standard slots (slots 5, 6, 7, and 8)

The center GPIM slot bracket must be removed before installing a double-high, double-wide GPIM. See [“Installing a Double-High, Double-Wide Gigabit-Backplane Physical Interface Module on the SRX Series Services Gateway”](#) on page 256 for details.

The earliest supported release on the 24-Port Gigabit Ethernet XPIM is Junos OS Release 9.5.

NOTE: Only the SRX650 Services Gateway supports hot-swappable functionality for GPIMs. The SRX550 Services Gateway does not support hot-swappable functionality for GPIMs.

Figure 27 on page 112 shows the 24-Port Gigabit Ethernet XPIM, and Figure 28 on page 112 shows the 24-Port Gigabit Ethernet XPIM with PoE.

Figure 27: 24-Port Gigabit Ethernet XPIM

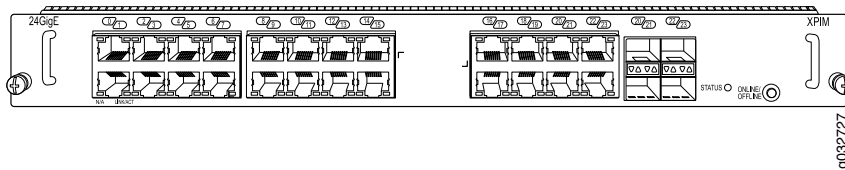
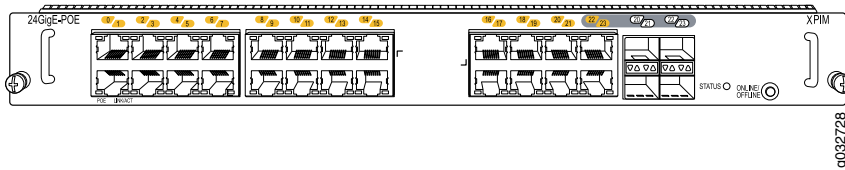

Figure 28: 24-Port Gigabit Ethernet XPIM with PoE



RELATED DOCUMENTATION

[24-Port Gigabit Ethernet XPIM Key Features | 115](#)

[24-Port Gigabit Ethernet XPIM Hardware Specifications | 116](#)

[24-Port Gigabit Ethernet XPIM LEDs | 117](#)

[24-Port Gigabit Ethernet XPIM Components | 112](#)

[24-Port Gigabit Ethernet XPIM Basic Configuration | 229](#)

[Installing a Double-High, Double-Wide Gigabit-Backplane Physical Interface Module on the SRX Series Services Gateway | 256](#)

24-Port Gigabit Ethernet XPIM Components

The 24-Port Gigabit Ethernet XPIM contains the components listed in [Table 58 on page 113](#).

Table 58: 24-Port Gigabit Ethernet XPIM Components

Component	Location	Description
<p>XPIM ONLINE/OFFLINE button</p> <p>Only the SRX650 Services Gateway supports hot-swappable functionality for GPIMs. The SRX550 Services Gateway does not support hot-swappable functionality for GPIMs.</p>	Right side of the XPIM	Use the XPIM ONLINE/OFFLINE button to gracefully shut down the XPIM.
<p>24 fixed Gigabit Ethernet ports labeled 0–23</p> <p>NOTE: The 24-Port Gigabit Ethernet with PoE XPIM port labels are yellow instead of white.</p> <p>NOTE: The RJ-45 and SFP ports 20–23 are shared ports. The SFP port will always take priority over the corresponding RJ-45 port if they are both connected.</p>	Middle of the XPIM	<p>NOTE: Each port on the 24-Port Gigabit Ethernet with PoE XPIM supports Power over Ethernet (PoE).</p> <p>Each Gigabit Ethernet port:</p> <ul style="list-style-type: none"> ● Provides link speeds of 10/100/1000 Mbps ● Uses an RJ-45 connector ● Operates in full-duplex and half-duplex modes ● Supports flow control ● Supports autonegotiation
<p>4 1-Gigabit small form-factor pluggable (SFP) ports labeled 20–23</p> <p>See Table 59 on page 114 for supported SFP transceivers.</p> <p>NOTE: The RJ-45 and SFP ports 20–23 are shared ports. The SFP port will always take priority over the corresponding RJ-45 port if they are both connected.</p>	Right side of the RJ-45 ports 0–23	Use these ports to connect various SFP transceivers for fiber cable connections.
Captive screws	One on each side of the XPIM	Use the captive screws to hold the XPIM in place.
Handles	One on each side of the XPIM	Use the handles to grasp the XPIM for installation or removal.

You can customize the Ethernet interface type by using different SFP transceivers. [Table 59 on page 114](#) shows the available SFP transceivers.



CAUTION: If you face a problem running a Juniper Networks device that uses a third-party optic or cable, the Juniper Networks Technical Assistance Center (JTAC) can help you diagnose the source of the problem. Your JTAC engineer might recommend that you check the third-party optic or cable and potentially replace it with an equivalent Juniper Networks optic or cable that is qualified for the device.

Table 59: 24-Port Gigabit Ethernet XPIM SFP Transceivers

Product Number	Interface Type	Connector
JX-SFP-FE-FX	100Base-FX Fast Ethernet optical transceiver SFP	LC
JX-SFP-1GE-LH	1000Base-LH Gigabit Ethernet optical transceiver SFP, 80 Km reach	LC
JX-SFP-1GE-LX	1000Base-LX Gigabit Ethernet optical transceiver SFP	LC
JX-SFP-1GE-SX	1000Base-SX Gigabit Ethernet optical transceiver SFP, 550 m reach without DDM (Difference in the Depth of Modulation)	LC
JX-SFP-1GE-T	1000Base-T Gigabit Ethernet copper transceiver SFP	RJ-45
SRX-SFP-1GE-LH	1000Base-LH Gigabit Ethernet optical transceiver SFP	LC
SRX-SFP-1GE-LX	1000Base-LX Gigabit Ethernet optical transceiver SFP	LC
SRX-SFP-1GE-SX	1000Base-SX Gigabit Ethernet optical transceiver SFP	LC
SRX-SFP-1GE-T	1000Base-T Gigabit Ethernet optical transceiver SFP	Cat 5 cable

Table 59: 24-Port Gigabit Ethernet XPIM SFP Transceivers (continued)

Product Number	Interface Type	Connector
SRX-SFP-FE-FX	100Base-FX Fast Ethernet optical transceiver SFP	LC

RELATED DOCUMENTATION

[24-Port Gigabit Ethernet XPIM Overview | 111](#)

[24-Port Gigabit Ethernet XPIM Key Features | 115](#)

[24-Port Gigabit Ethernet XPIM Hardware Specifications | 116](#)

[24-Port Gigabit Ethernet XPIM LEDs | 117](#)

[24-Port Gigabit Ethernet XPIM Basic Configuration | 229](#)

[Power over Ethernet Support on SRX Series Services Gateway Interfaces | 15](#)

24-Port Gigabit Ethernet XPIM Key Features

The 24-Port Gigabit Ethernet XPIM has the following key features:

- 24 triple-speed (10/100/1000 Mbps) Ethernet ports, double-high and double-wide card
- 4 ports that can be configured to use SFPs
- PoE support for all ports
- PCI-Express interface for control and management
- I2C interface for module monitor and identification
- Maximum module power of 40.0 W without PoE
- JTAG support for boundary scan test

RELATED DOCUMENTATION

[24-Port Gigabit Ethernet XPIM Overview | 111](#)

[24-Port Gigabit Ethernet XPIM Hardware Specifications | 116](#)

[24-Port Gigabit Ethernet XPIM LEDs | 117](#)

[24-Port Gigabit Ethernet XPIM Components | 112](#)

24-Port Gigabit Ethernet XPIM Hardware Specifications

The 24-Port Gigabit Ethernet XPIM has the hardware specifications listed in [Table 60 on page 116](#).

Table 60: 24-Port Gigabit Ethernet XPIM Hardware Specifications

Description	Value
Dimensions (H x W x L)	1.58 in. H x 13.49 in. W x 8.5 in. L (40.2 cm x 34.3 cm x 21.6 cm)
Weight	2.79 lb (1.27 kg)
Connector types	24 RJ-45 and 4 small form-factor pluggable (SFP) ports NOTE: Ports 20 to 23 are shared so you can use either the RJ-45 copper ports 20–23 with 10/100/1000 Mbps, or the SFP connector ports 20–23 for 1 Gigabit connectivity.
Supported SFPs	Juniper Internal SFPs: <ul style="list-style-type: none"> • LX (1 GB) • SX (1 GB) • FX (100 Mbps) • TX (1 GB) • ZX (1 GB) External SFPs: <ul style="list-style-type: none"> • Finisar
Form factor	Double-high, double-wide XPIM
Environmental operating temperature	32°F through 104°F (0°C through 40°C)
Storage temperature	-40°F through 158°F (-40°C through 70°C)
Relative humidity	5% to 90% noncondensing

RELATED DOCUMENTATION

[24-Port Gigabit Ethernet XPIM Overview | 111](#)

[24-Port Gigabit Ethernet XPIM Key Features | 115](#)

[24-Port Gigabit Ethernet XPIM LEDs | 117](#)

[24-Port Gigabit Ethernet XPIM Components | 112](#)

[24-Port Gigabit Ethernet XPIM Basic Configuration | 229](#)

24-Port Gigabit Ethernet XPIM LEDs

The 24-Port Gigabit Ethernet XPIM has the LEDs listed in [Table 61 on page 117](#).

Table 61: 24-Port Gigabit Ethernet XPIM LED States

LED	Color	State	Description
STATUS	Green	On	XPIM is online and functioning normally.
	Amber	On	XPIM is starting up, running diagnostics, or shutting down.
	Red	On	XPIM has failed.
LINK/ACT	Green	On	Port is online.
		Off	Port is offline.
		Blinking	Port is receiving or sending data.
N/A	N/A	N/A	Not used on the non-PoE XPIM.
PoE	Green	On	Port is PoE enabled and online.
		Off	Port is offline.
		Blinking	Port is PoE enabled and receiving or sending data.

NOTE: This LED is not applicable on the non-PoE 24-Port XPIM. See [Figure 29 on page 118](#).

NOTE: Applicable on the PoE XPIM only. See [Figure 30 on page 118](#).

Table 61: 24-Port Gigabit Ethernet XPIM LED States (continued)

LED	Color	State	Description
SFP ports 20–23 NOTE: Each port has two LEDs in the shape of a triangle pointing toward the port. The left LED is link and the right is activity.	Link Green	On	Port is online.
		Off	Port is offline.
	Activity Green	Blinking	Port is receiving or sending data.
		Off	Port might be on but is not receiving or sending data.

Figure 29: 24-Port Gigabit Ethernet XPIM

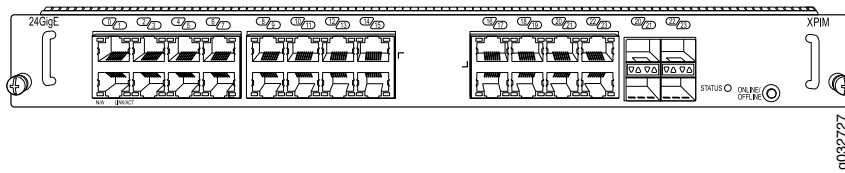
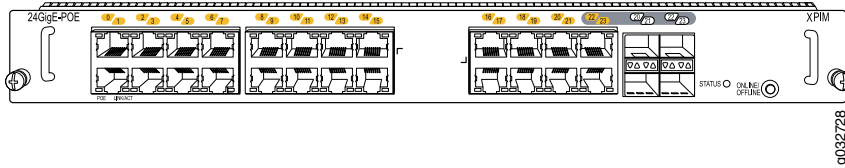

Figure 30: 24-Port Gigabit Ethernet XPIM with PoE



RELATED DOCUMENTATION

[24-Port Gigabit Ethernet XPIM Overview | 111](#)

[24-Port Gigabit Ethernet XPIM Key Features | 115](#)

[24-Port Gigabit Ethernet XPIM Hardware Specifications | 116](#)

[24-Port Gigabit Ethernet XPIM Components | 112](#)

[24-Port Gigabit Ethernet XPIM Basic Configuration | 229](#)

[Power over Ethernet Support on SRX Series Services Gateway Interfaces | 15](#)

Dual CT1/E1 GPIM

IN THIS CHAPTER

- Dual CT1/E1 GPIM Overview | 119
- Dual CT1/E1 GPIM Components | 120
- Dual CT1/E1 GPIM Key Features | 121
- Dual CT1/E1 GPIM Hardware Specifications | 121
- Dual CT1/E1 GPIM LEDs | 122

Dual CT1/E1 GPIM Overview

A Gigabit-Backplane Physical Interface Module (GPIM) is a network interface card (NIC) that installs in the front slots of the SRX550 or SRX650 Services Gateway to provide physical connections to a LAN or a WAN. The GPIM receives incoming packets from a network and transmits outgoing packets to a network.

NOTE: The Dual CT1/E1 GPIM does not yet support channelization.

The Dual CT1/E1 GPIM provides the physical connection to T1 or E1 network media types and performs T1 or E1 framing and line-speed signaling.

NOTE: Only the SRX650 Services Gateway supports hot-swappable functionality for GPIMs. The SRX550 Services Gateway does not support hot-swappable functionality for GPIMs.

The Dual CT1/E1 GPIM can be plugged into any GPIM slot on the services gateway. [Figure 31 on page 120](#) shows the Dual CT1/E1 GPIM.

Figure 31: Dual CT1/E1 GPIM

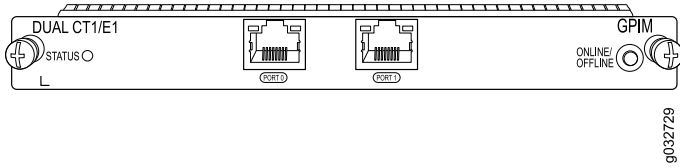

Dual CT1/E1 GPIM Components

The Dual CT1/E1 Gigabit-Backplane Physical Interface Module (GPIM) contains the components listed in [Table 62 on page 120](#).

Table 62: Dual CT1/E1 GPIM Components

Component	Location	Description	
<p>GPIM ONLINE/OFFLINE button</p> <p>Only the SRX650 Services Gateway supports hot-swappable functionality for GPIMs. The SRX550 Services Gateway does not support hot-swappable functionality for GPIMs.</p>	Right side of the GPIM	Use the GPIM ONLINE/OFFLINE button to gracefully shut down the GPIM.	
<p>Two fixed T1/E1 ports labeled 0 and 1</p> <p>Each port can be configured using the CLI in T1 or E1 mode.</p>	Middle of the GPIM	<p>T1 Mode:</p> <ul style="list-style-type: none"> • Transmit bit rate: 1.544 Mbps • Receive bit rate: 1.544 Mbps 	<p>E1 Mode:</p> <ul style="list-style-type: none"> • Transmit bit rate: 2.048 Mbps • Receive bit rate: 2.048 Mbps
Captive screws	One on each side of the GPIM	Use the captive screws to hold the GPIM in place in the services gateway.	

Dual CT1/E1 GPIM Key Features

The Dual CT1/E1 Gigabit-Backplane Physical Interface Module (GPIM) provides the following common key features for both T1 and E1 modes:

- Channel service unit/data service unit (CSU/DSU) to eliminate the need for a separate external device
- 56-Kbps and 64-Kbps operating modes
- Independent internal and external clocking option
- Alarm reporting with a 24-hour history maintained
- Loopback (local and remote) and BERT/PRBS diagnostics
- Multilink Frame Relay and Multilink PPP support
- MTU size of 9000 bytes (maximum)

Dual CT1/E1 GPIM Hardware Specifications

The Dual CT1/E1 Gigabit-Backplane Physical Interface Module (GPIM) has the hardware specifications listed in [Table 63 on page 121](#).

Table 63: Dual CT1/E1 GPIM Hardware Specifications

Description	Value
Dimensions (H x W x L)	0.78 in. H x 6.72 in. W x 8.1 in. L (19.8 mm x 170.8 mm x 205.7 mm)
Weight	15.4 oz (0.44 kg)
Connector type	RJ-45
Form factor	Single-high, single-wide GPIM
Environmental operating temperature	32°F through 104°F (0°C through 40°C)
Storage temperature	-40°F through 158°F (-40°C through 70°C)
Relative humidity	5% to 90% noncondensing

Dual CT1/E1 GPIM LEDs

The Dual CT1/E1 Gigabit-Backplane Physical Interface Module (GPIM) has the LED listed in [Table 64 on page 122](#).

Table 64: Dual CT1/E1 GPIM LED States

LED	Color	State	Description
STATUS	Green	On	GPIM is online and functioning normally.
	Amber	On	GPIM is starting up, running diagnostics, or shutting down.
	Red	On	GPIM has failed.

Quad CT1/E1 GPIM

IN THIS CHAPTER

- Quad CT1/E1 GPIM Overview | 123
- Quad CT1/E1 GPIM Components | 124
- Quad CT1/E1 GPIM Key Features | 125
- Quad CT1/E1 GPIM Hardware Specifications | 125
- Quad CT1/E1 GPIM LEDs | 126

Quad CT1/E1 GPIM Overview

A Gigabit-Backplane Physical Interface Module (GPIM) is a network interface card (NIC) that installs in the front slots of the SRX550 or SRX650 Services Gateway to provide physical connections to a LAN or a WAN. The GPIM receives incoming packets from a network and transmits outgoing packets to a network.

NOTE: The Quad CT1/E1 GPIM does not support channelization.

The Quad CT1/E1 GPIM provides the physical connection to T1 or E1 network media types and also performs T1 or E1 framing and line-speed signaling.

NOTE: Only the SRX650 Services Gateway supports hot-swappable functionality for GPIMs. The SRX550 Services Gateway does not support hot-swappable functionality for GPIMs.

[Figure 32 on page 124](#) shows the Quad CT1/E1 GPIM.

Figure 32: Quad CT1/E1 GPIM

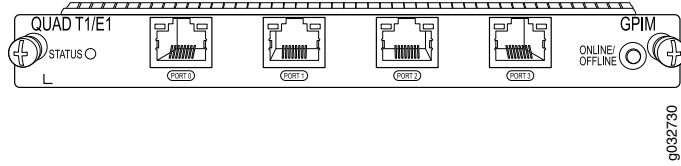

Quad CT1/E1 GPIM Components

The Quad CT1/E1 Gigabit-Backplane Physical Interface Module (GPIM) contains the components listed in [Table 65 on page 124](#).

Table 65: Quad CT1/E1 GPIM Components

Component	Location	Description
<p>GPIM ONLINE/OFFLINE button</p> <p>Only the SRX650 Services Gateway supports hot-swappable functionality for GPIMs. The SRX550 Services Gateway does not support hot-swappable functionality for GPIMs.</p>	Right side of the GPIM	Use the GPIM ONLINE/OFFLINE button to gracefully shut down the GPIM.
<p>Four fixed T1/E1 ports labeled 0-3</p> <p>Each port can be configured using the CLI in T1 or E1 mode.</p>	Middle of the GPIM	<p>T1 Mode:</p> <ul style="list-style-type: none"> • Transmit bit rate: 1.544 Mbps • Receive bit rate: 1.544 Mbps <p>E1 Mode:</p> <ul style="list-style-type: none"> • Transmit bit rate: 2.048 Mbps • Receive bit rate: 2.048 Mbps
Captive screws	One on each side of the GPIM	Use the captive screws to hold the GPIM in place in the services gateway.

Quad CT1/E1 GPIM Key Features

The Quad CT1/E1 Gigabit-Backplane Physical Interface Module (GPIM) provides the following common key features for both T1 and E1 modes:

- Channel service unit/data service unit (CSU/DSU) to eliminate the need for a separate external device
- 56-Kbps and 64-Kbps operating modes
- Independent internal and external clocking option
- Alarm reporting with a 24-hour history maintained
- Loopback (local and remote) and BERT/PRBS diagnostics
- Multilink Frame Relay and Multilink PPP support
- MTU size of 9000 bytes (maximum)

Quad CT1/E1 GPIM Hardware Specifications

The Quad CT1/E1 Gigabit-Backplane Physical Interface Module (GPIM) has the specifications listed in [Table 66 on page 125](#).

Table 66: Quad CT1/E1 GPIM Hardware Specifications

Description	Value
Dimensions (H x W x L)	0.78 in. H x 6.72 in. W x 8.1 in. L (19.8 mm x 170.8 mm x 205.7 mm)
Weight	15.4 oz (0.44 kg)
Connector type	RJ-45
Form factor	Single-high, single-wide GPIM
Environmental operating temperature	32°F through 104°F (0°C through 40°C)
Storage temperature	-40°F through 158°F (-40°C through 70°C)
Relative humidity	5% to 90% noncondensing

Quad CT1/E1 GPIM LEDs

The Quad CT1/E1 Gigabit-Backplane Physical Interface Module (GPIM) has the LED listed in [Table 67 on page 126](#).

Table 67: Quad CT1/E1 GPIM LED States

LED	Color	State	Description
STATUS	Green	On	GPIM is online and functioning normally.
	Amber	On	GPIM is starting up, running diagnostics, or shutting down.
	Red	On	GPIM has failed.

3

PART

Cable Specifications and Pinouts

T1/E1 Mini-Physical Interface Module | **128**

ADSL2 + Mini-Physical Interface Module | **134**

G.SHDSL Mini-Physical Interface Module Cable Specifications | **135**

VDSL2 Mini-Physical Interface Module Cable Specifications | **141**

Serial Mini-Physical Interface Module Cable Specifications | **143**

Serial Gigabit-Backplane Physical Interface Module Cable Specifications | **157**

T1/E1 Mini-Physical Interface Module

IN THIS CHAPTER

- RJ-48 Connector to RJ-48 Connector (Straight) Pinouts for the 1-Port T1/E1 Mini-Physical Interface Module | 128
- RJ-48 Connector to RJ-48 Connector (Crossover) Pinouts for the 1-Port T1/E1 Mini-Physical Interface Module | 129
- RJ-48 Connector to DB-15 Connector (Straight) Pinouts for the 1-Port T1/E1 Mini-Physical Interface Module | 130
- RJ-48 Connector to DB-15 Connector (Crossover) Pinouts for the 1-Port T1/E1 Mini-Physical Interface Module | 132

RJ-48 Connector to RJ-48 Connector (Straight) Pinouts for the 1-Port T1/E1 Mini-Physical Interface Module

The 1-Port T1/E1 Mini-Physical Interface Module (Mini-PIM) uses an RJ-48 cable, which is not supplied with the Mini-PIM.



CAUTION: To maintain agency approvals, use only a properly constructed, shielded cable.

Table 68 on page 128 gives RJ-48 connector to RJ-48 connector (straight) pinouts.

Table 68: RJ-48 Connector to RJ-48 Connector (Straight) Pinouts

RJ-48 Pin (on 1-Port T1/E1 Mini-PIM)	RJ-48 Pin (Data Numbering Form)	Signal
1	1	RX, Ring, -
2	2	RX, Tip, +
4	4	TX, Ring, -

Table 68: RJ-48 Connector to RJ-48 Connector (Straight) Pinouts (continued)

RJ-48 Pin (on 1-Port T1/E1 Mini-PIM)	RJ-48 Pin (Data Numbering Form)	Signal
5	5	TX, Tip, +
3	3	Shield/Return/Ground
6	6	Shield/Return/Ground
7	No connect	No connect
8	No connect	No connect

RELATED DOCUMENTATION

[RJ-48 Connector to RJ-48 Connector \(Crossover\) Pinouts for the 1-Port T1/E1 Mini-Physical Interface Module | 129](#)

[RJ-48 Connector to DB-15 Connector \(Straight\) Pinouts for the 1-Port T1/E1 Mini-Physical Interface Module | 130](#)

[RJ-48 Connector to DB-15 Connector \(Crossover\) Pinouts for the 1-Port T1/E1 Mini-Physical Interface Module | 132](#)

[1-Port T1/E1 Mini-Physical Interface Module Overview | 66](#)

RJ-48 Connector to RJ-48 Connector (Crossover) Pinouts for the 1-Port T1/E1 Mini-Physical Interface Module

Table 69 on page 129 gives RJ-48 connector to RJ-48 connector (crossover) pinouts for the 1-Port T1/E1 Mini-Physical Interface Module (Mini-PIM).

Table 69: RJ-48 Connector to RJ-48 Connector (Crossover) Pinouts

RJ-48 Pin (on T1/E1 Mini-PIM)	RJ-48 Pin (Data Numbering Form)	Signal
1	4	RX/Ring/- <--->TX/Ring/-
2	5	RX/Tip/+ <--->TX/Tip/+

Table 69: RJ-48 Connector to RJ-48 Connector (Crossover) Pinouts (*continued*)

RJ-48 Pin (on T1/E1 Mini-PIM)	RJ-48 Pin (Data Numbering Form)	Signal
4	1	TX/Ring/- <--->RX/Ring/-
5	2	TX/Tip/+ <--->RX/Tip/+
3	3	Shield/Return/Ground
6	6	Shield/Return/Ground
7	No connect	No connect
8	No connect	No connect

RELATED DOCUMENTATION

[RJ-48 Connector to RJ-48 Connector \(Straight\) Pinouts for the 1-Port T1/E1 Mini-Physical Interface Module | 128](#)

[RJ-48 Connector to DB-15 Connector \(Straight\) Pinouts for the 1-Port T1/E1 Mini-Physical Interface Module | 130](#)

[RJ-48 Connector to DB-15 Connector \(Crossover\) Pinouts for the 1-Port T1/E1 Mini-Physical Interface Module | 132](#)

[1-Port T1/E1 Mini-Physical Interface Module Overview | 66](#)

RJ-48 Connector to DB-15 Connector (Straight) Pinouts for the 1-Port T1/E1 Mini-Physical Interface Module

Table 70 on page 130 gives RJ-48 connector to DB-15 connector (straight) pinouts.

Table 70: RJ-48 Connector to DB-15 Connector (Straight) Pinouts

RJ-48 Pin (on T1/E1 Mini-PIM)	DB-15 Pin (Data Numbering Form)	Signal
1	11	RX/Ring/- <--->RX/Ring/-
2	3	RX/Tip/+ <--->RX/Tip/+

Table 70: RJ-48 Connector to DB-15 Connector (Straight) Pinouts (continued)

RJ-48 Pin (on T1/E1 Mini-PIM)	DB-15 Pin (Data Numbering Form)	Signal
4	9	TX/Ring/- <--->TX/Ring/-
5	1	TX/Tip/+ <--->TX/Tip/+
3	4	Shield/Return/Ground
6	2	Shield/Return/Ground
7	No connect	No connect
8	No connect	No connect
9	No connect	No connect
10	No connect	No connect
11	No connect	No connect
12	No connect	No connect
13	No connect	No connect
14	No connect	No connect
15	No connect	No connect

RELATED DOCUMENTATION

[RJ-48 Connector to RJ-48 Connector \(Straight\) Pinouts for the 1-Port T1/E1 Mini-Physical Interface Module | 128](#)

[RJ-48 Connector to RJ-48 Connector \(Crossover\) Pinouts for the 1-Port T1/E1 Mini-Physical Interface Module | 129](#)

[RJ-48 Connector to DB-15 Connector \(Crossover\) Pinouts for the 1-Port T1/E1 Mini-Physical Interface Module | 132](#)

[1-Port T1/E1 Mini-Physical Interface Module Overview | 66](#)

RJ-48 Connector to DB-15 Connector (Crossover) Pinouts for the 1-Port T1/E1 Mini-Physical Interface Module

Table 71 on page 132 gives RJ-48 connector to DB-15 connector (crossover) pinouts.

Table 71: RJ-48 Connector to DB-15 Connector (Crossover) Pinouts

RJ-48 Pin (on T1/E1 Mini-PIM)	DB-15 Pin (Data Numbering Form)	Signal
1	9	RX/Ring/- <--->TX/Ring/-
2	1	RX/Tip/+ <--->TX/Tip/+
4	11	TX/Ring/- <--->RX/Ring/-
5	3	TX/Tip/+ <--->RX/Tip/+
3	4	Shield/Return/Ground
6	2	Shield/Return/Ground
7	No connect	No connect
8	No connect	No connect
9	No connect	No connect
10	No connect	No connect
11	No connect	No connect
12	No connect	No connect
13	No connect	No connect
14	No connect	No connect
15	No connect	No connect

RELATED DOCUMENTATION

[RJ-48 Connector to RJ-48 Connector \(Straight\) Pinouts for the 1-Port T1/E1 Mini-Physical Interface Module | 128](#)

[RJ-48 Connector to RJ-48 Connector \(Crossover\) Pinouts for the 1-Port T1/E1 Mini-Physical Interface Module | 129](#)

[RJ-48 Connector to DB-15 Connector \(Straight\) Pinouts for the 1-Port T1/E1 Mini-Physical Interface Module | 130](#)

[1-Port T1/E1 Mini-Physical Interface Module Overview | 66](#)

ADSL2 + Mini-Physical Interface Module

IN THIS CHAPTER

- [RJ-11 Connector Pinouts for the 1-Port ADSL2+ Mini-Physical Interface Module | 134](#)

RJ-11 Connector Pinouts for the 1-Port ADSL2+ Mini-Physical Interface Module

The 1-Port ADSL2+ Mini-Physical Interface Module (Mini-PIM) uses an RJ-11 cable, which is not supplied with the Mini-PIM. [Table 72 on page 134](#) gives the RJ-11 connector pinouts.

Table 72: RJ-11 Connector Pinouts for the 1-Port ADSL2+ Mini-PIM

Pin	Signal
1	No connect
2	No connect
3	RJ P-Tip
4	RJ N-Ring
5	No connect
6	No connect

RELATED DOCUMENTATION

[1-Port ADSL2+ Mini-Physical Interface Module Overview | 45](#)

[1-Port ADSL2+ Mini-Physical Interface Module Hardware Specifications | 47](#)

G.SHDSL Mini-Physical Interface Module Cable Specifications

IN THIS CHAPTER

- [1-Port G.SHDSL 8-Wire Mini-Physical Interface Module Cable Specifications | 135](#)

1-Port G.SHDSL 8-Wire Mini-Physical Interface Module Cable Specifications

The 1-Port G.SHDSL Mini-Physical Interface Module (Mini-PIM) requires different combination of RJ-45 cables depending upon the connection available on the patch panel.

[Table 73 on page 135](#) lists the cables that you can order from Juniper Networks to connect the G.SHDSL Mini-PIM.

Table 73: 1-Port G.SHDSL Mini-PIM Cable Part Numbers

Connections	Details
1X8-wire	Standard RJ-45 connector
2X4-wire	RJ-45 connector that connects to two RJ-11 connectors (RJ-45 to 2 X RJ-11)
4X2-wire	RJ-45 connector that connects to four RJ-11 connectors. (RJ-45 to 4 X RJ-11)

The following topology diagrams show different G.SHDSL Mini-PIM connections:

[Figure 33 on page 136](#) shows the topology for 1-Port G.SHDSL Mini-PIM operating in 4 X 2-wire mode.

Figure 33: 1-Port G.SHDSL Mini-PIM Operating in 4 X 2-Wire Mode

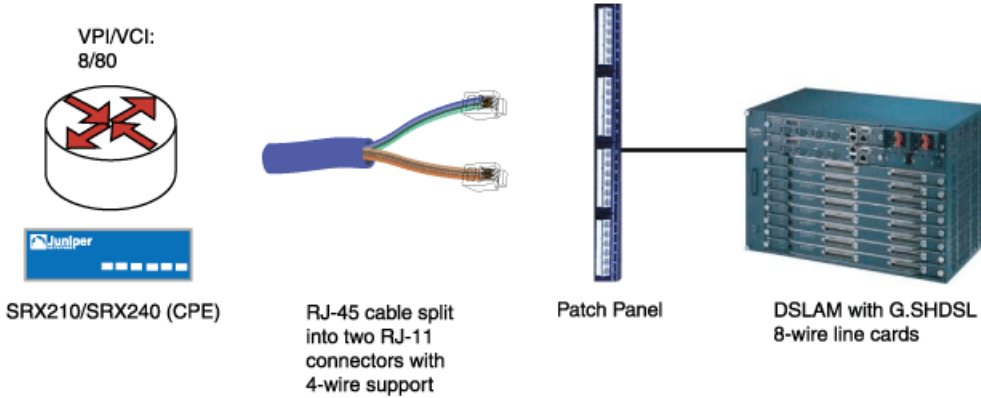

Figure 34 on page 136 shows the topology for 1-Port G.SHDSL Mini-PIM operating in 2 X 4-wire mode.

Figure 34: G.SHDSL Mini-PIM Operating in 2 X 4-Wire Mode

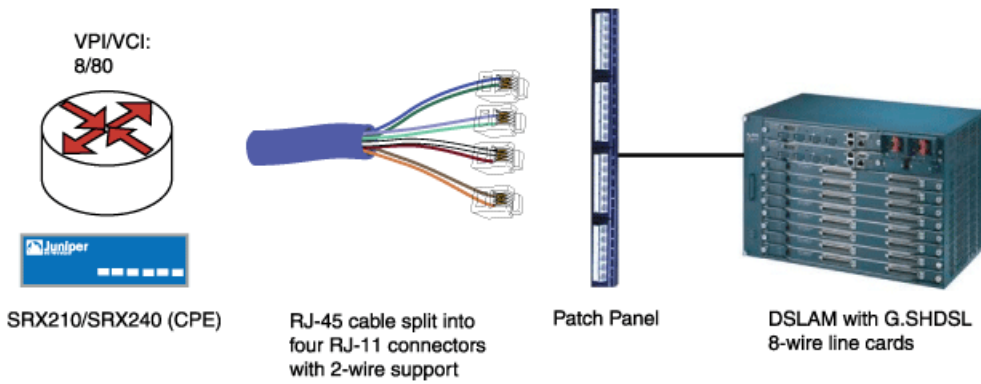
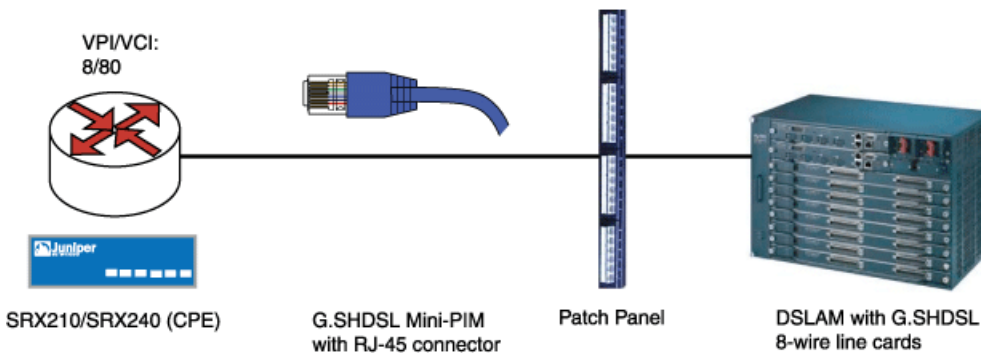

Figure 35 on page 136 shows the topology for 1-Port G.SHDSL Mini-PIM operating in 1 X 8-wire mode.

Figure 35: G.SHDSL Mini-PIM Operating in 1 X 8-Wire Mode



RJ-45 Cable (RJ-45 to Four RJ-11 Connectors) Pin Assignment

Table 74 on page 137 shows the pin assignments of the RJ-45 cable (RJ-45 to 4 X RJ-11).

Table 74: RJ-45 Cable (RJ-45 to Four RJ-11 Connectors) Pinout Details

RJ-45 Pin Number	Connections	RJ-11 Pin Number	Connections	Plug Number
1	Tip 1	3	Tip 1 of 1st port	P1
2	Ring 1	4	Ring 1 of 2nd port	
3	Tip 2	3	Tip 2 of 3rd port	P2
4	Tip 0	3	Tip 0 of 1st port	
5	Ring 0	4	Ring 0 of 1st port	P3
6	Ring 2	4	Ring 2 of 3rd port	
7	Tip 3	3	Tip 3 of 4th port	P4
8	Ring 3	4	Ring 3 of 4th port	

Figure 36 on page 138 shows the RJ-45 cable design that connects to four RJ-11 cable connections.

Figure 36: RJ-45 Cable Design (RJ-45 to Four RJ-11 Connectors)

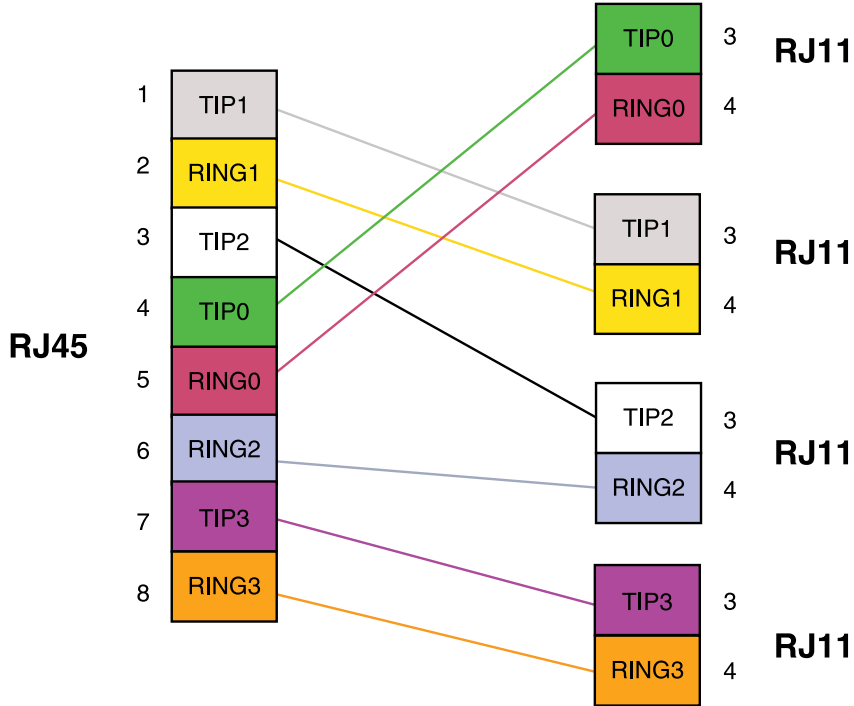

RJ-45 Cable (RJ-45 to Two RJ-11 Connectors) Pin Assignment

Table 75 on page 138 shows the pin assignments of the RJ-45 cable that connects to two RJ-11 connectors.

Table 75: RJ-45 Cable (RJ-45 to Two RJ-11 Connectors) Pinout Details

RJ-45 Pin Number	Signal	RJ-11 Pin Number	Signal Plug 1	Signal Plug 2
1	Tip 1	2	Tip 1 of 1st port	-
2	Ring 1	5	Ring 1 of 1st port	-
3	Tip 2	3	-	Tip 2 of 2nd port
4	Tip 0	3	Tip 0 of 1st port	-
5	Ring 0	4	Ring 0 of 1st port	-
6	Ring 2	4	-	Ring 2 of 2nd port
7	Tip 3	2	-	Tip 3 of 2nd port
8	Ring 3	5	-	Ring 3 of 2nd port

Figure 37 on page 139 shows the RJ-45 cable design that connects two RJ-11 cable connections.

Figure 37: RJ-45 Cable Design (RJ-45 to Two RJ-11 Connectors)

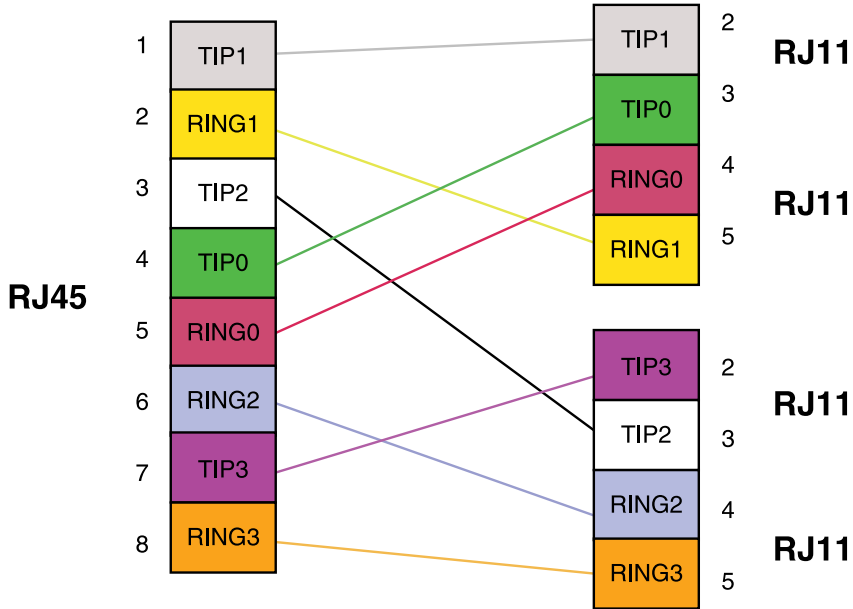

Standard RJ-45 Cable Pin Assignment

Table 76 on page 139 shows the pin assignments of the standard RJ-45 cable.

Table 76: Standard RJ-45 Cable Pinout Details

RJ-45 Pin Number	Connections
1	Tip
2	Ring
3	Tip
4	Tip
5	Ring
6	Ring
7	Tip
8	Ring

RELATED DOCUMENTATION

[1-Port G.SHDSL 8-Wire Mini-Physical Interface Module Overview | 57](#)

[1-Port G.SHDSL 8-Wire Mini-Physical Interface Module Supported Standards | 61](#)

[1-Port G.SHDSL 8-Wire Mini-Physical Interface Module Operating Modes | 239](#)

[1-Port G.SHDSL 8-Wire Mini-Physical Interface Module Key Features | 58](#)

[1-Port G.SHDSL 8-Wire Mini-Physical Interface Module Hardware Specifications | 59](#)

[1-Port G.SHDSL 8-Wire Mini-Physical Interface Module LEDs | 60](#)

VDSL2 Mini-Physical Interface Module Cable Specifications

IN THIS CHAPTER

- [1-Port VDSL2 \(Annex A\) Mini-Physical Interface Module Cable Specifications | 141](#)

1-Port VDSL2 (Annex A) Mini-Physical Interface Module Cable Specifications

The 1-Port VDSL2 (Annex A) Mini-Physical Interface Module (Mini-PIM) requires a standard RJ-11 cable.

[Figure 38 on page 141](#) shows the RJ-11 cable design.

Figure 38: RJ-11 Cable Pinout for 1-Port VDSL2 (Annex A) Mini-PIM

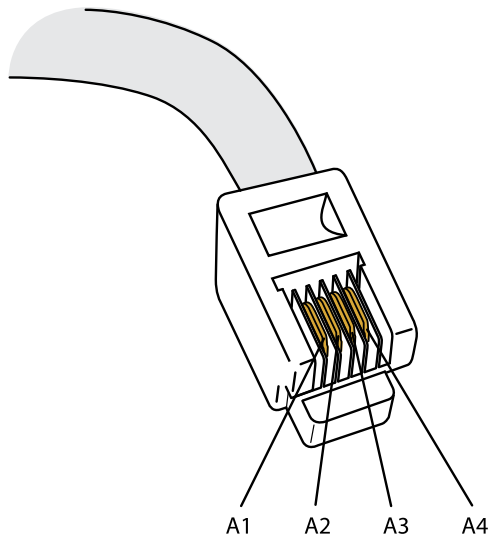

[Table 77 on page 142](#) shows the pin assignments of the RJ-11 cable.

Table 77: RJ-11 Cable Pinout Details for 1-Port VDSL2 (Annex A) Mini-PIM

Pin	Signal
A1	Ground
A2	RX (data input)
A3	Tx (data output)
A4	Vcc (power)

RELATED DOCUMENTATION

[1-Port VDSL2 \(Annex A\) Mini-Physical Interface Module Overview | 72](#)

[1-Port VDSL2 \(Annex A\) Mini-Physical Interface Module Key Features | 73](#)

[1-Port VDSL2 \(Annex A\) Mini-Physical Interface Module Supported Profiles | 75](#)

[1-Port VDSL2 \(Annex A\) Mini-Physical Interface Module LEDs | 74](#)

[1-Port VDSL2 \(Annex A\) Mini-Physical Interface Module Hardware Specifications | 74](#)

Serial Mini-Physical Interface Module Cable Specifications

IN THIS CHAPTER

- 1-Port Serial Mini-Physical Interface Module Interface Cables | 143
- EIA-530A DCE Cable Pinouts for the 1-Port Serial Mini-Physical Interface Module | 144
- EIA-530A DTE Cable Pinouts for the 1-Port Serial Mini-Physical Interface Module | 145
- RS-232 DCE Cable Pinouts for the 1-Port Serial Mini-Physical Interface Module | 147
- RS-232 DTE Cable Pinouts for the 1-Port Serial Mini-Physical Interface Module | 148
- RS-422/449 (EIA-449) DCE Cable Pinouts for the 1-Port Serial Mini-Physical Interface Module | 149
- RS-422/449 (EIA-449) DTE Cable Pinouts for the 1-Port Serial Mini-Physical Interface Module | 150
- V.35 DCE Cable Pinouts for the 1-Port Serial Mini-Physical Interface Module | 152
- V.35 DTE Cable Pinouts for the 1-Port Serial Mini-Physical Interface Module | 153
- X.21 DCE Cable Pinouts for the 1-Port Serial Mini-Physical Interface Module | 155
- X.21 DTE Cable Pinouts for the 1-Port Serial Mini-Physical Interface Module | 155

1-Port Serial Mini-Physical Interface Module Interface Cables

Table 78 on page 143 lists the cables that you can order from Juniper Networks to connect to a port on the synchronous 1-Port Serial Mini-Physical Interface Module (Mini-PIM). The device to which you are connecting and the serial interface types determine which type of cable you need.

Table 78: Juniper Networks Serial Cables

Product Number	Interface Type	Length	Connector Type
JX-CBL-EIA530-DCE	EIA530 cable (DCE)	3.04 m (10 ft)	Socket
JX-CBL-EIA530-DTE	EIA530 cable (DTE)	3.04 m (10 ft)	Plug
JX-CBL-RS232-DCE	RS232 cable (DCE)	3.04 m (10 ft)	Socket

Table 78: Juniper Networks Serial Cables (*continued*)

Product Number	Interface Type	Length	Connector Type
JX-CBL-RS232-DTE	RS232 cable (DTE)	3.04 m (10 ft)	Plug
JX-CBL-RS449-DCE	RS449 cable (DCE)	3.04 m (10 ft)	Socket
JX-CBL-RS449-DTE	RS449 cable (DTE)	3.04 m (10 ft)	Plug
JX-CBL-V35-DCE	V.35 cable (DCE)	3.04 m (10 ft)	Socket
JX-CBL-V35-DTE	V.35 cable (DTE)	3.04 m (10 ft)	Plug
JX-CBL-X21-DCE	X.21 cable (DCE)	3.04 m (10 ft)	Socket
JX-CBL-X21-DTE	X.21 cable (DTE)	3.04 m (10 ft)	Plug

EIA-530A DCE Cable Pinouts for the 1-Port Serial Mini-Physical Interface Module

Table 79 on page 144 gives the EIA-530A DCE cable pinouts.

Table 79: EIA-530A DCE Cable Pinouts for the 1-Port Serial Mini-PIM

LFH-60 Pin	DB-25 Pin	LFH-60 Pairing	Description
15	1	-	Shield Ground
1	2	2	Transmit Data (A)
60	3	59	Receive Data (A)
37	4	38	Request to Send (A)
48	5	47	Clear to Send (A)
33	6	-	Data Set Ready (A)
57	7	-	Signal Ground
13	8	14	Received Line Signal Detector (A)

Table 79: EIA-530A DCE Cable Pinouts for the 1-Port Serial Mini-PIM (continued)

LFH-60 Pin	DB-25 Pin	LFH-60 Pairing	Description
51	9	52	Receive Clock (B)
14	10	13	Received Line Signal Detector (B)
6	11	5	Terminal Timing (B)
55	12	56	Transmit Clock (B)
47	13	48	Clear to Send (B)
2	14	1	Transmit Data (B)
56	15	55	Transmit Clock (A)
59	16	60	Receive Data (B)
52	17	51	Receive Clock (A)
45	18	-	Local Loopback
38	19	37	Request to Send (B)
9	20	-	Data Terminal Ready (A)
4	23	-	Signal Ground
5	24	6	Terminal Timing (A)
26 to 25	-	-	-
30 to 29	-	-	-

EIA-530A DTE Cable Pinouts for the 1-Port Serial Mini-Physical Interface Module

Table 80 on page 146 gives the EIA-530A DTE cable pinouts.

Table 80: EIA-530A DTE Cable Pinouts for the 1-Port Serial Mini-PIM

LFH-60 Pin	DB-25 Pin	LFH-60 Pairing	Description
15	1	-	Shield Ground
60	2	59	Transmit Data (A)
1	3	2	Receive Data (A)
48	4	47	Request to Send (A)
37	5	38	Clear to Send (A)
9	6	-	Data Set Ready (A)
57	7	-	Signal Ground
13	8	14	Received Line Signal Detector (A)
6	9	5	Receive Clock (B)
14	10	13	Received Line Signal Detector (B)
51	11	52	Terminal Timing (B)
55	12	56	Transmit Clock (B)
38	13	37	Clear to Send (B)
59	14	60	Transmit Data (B)
56	15	55	Transmit Clock (A)
2	16	1	Receive Data (B)
5	17	6	Receive Clock (A)
41	18	-	Local Loopback
47	19	48	Request to Send (B)
33	20	-	Data Terminal Ready (A)
4	23	-	Signal Ground

Table 80: EIA-530A DTE Cable Pinouts for the 1-Port Serial Mini-PIM (*continued*)

LFH-60 Pin	DB-25 Pin	LFH-60 Pairing	Description
52	24	51	Terminal Timing (A)
26 to 25	-	-	-
30 to 29	-	-	-
18 to 17	-	-	-

RS-232 DCE Cable Pinouts for the 1-Port Serial Mini-Physical Interface Module

Table 81 on page 147 gives the RS-232 DCE cable pinouts.

Table 81: RS-232 DCE Cable Pinouts for the 1-Port Serial Mini-PIM

LFH-60 Pin	DB-25 Pin	LFH-60 Pairing	Description
15	1	-	Frame Ground
1	2	-	Transmit Data
60	3	-	Receive Data
37	4	-	Request to Send
48	5	-	Clear to Send
33	6	-	Data Set Ready
57	7	-	Signal Ground
13	8	-	Data Carrier Detect
56	15	-	Transmit Clock
52	17	-	Receive Clock
45	18	-	Local Loopback

Table 81: RS-232 DCE Cable Pinouts for the 1-Port Serial Mini-PIM (continued)

LFH-60 Pin	DB-25 Pin	LFH-60 Pairing	Description
9	20	-	Data Terminal Ready
5	24	-	Terminal Clock
22 to 21	-	-	-

RS-232 DTE Cable Pinouts for the 1-Port Serial Mini-Physical Interface Module

Table 82 on page 148 gives the RS-232 DTE cable pinouts.

Table 82: RS-232 DTE Cable Pinouts for the 1-Port Serial Mini-PIM

LFH-60 Pin	DB-25 Pin	LFH-60 Pairing	Description
15	1	-	Frame Ground
60	2	-	Transmit Data
1	3	-	Receive Data
48	4	-	Request to Send
37	5	-	Clear to Send
9	6	-	Data Set Ready
57	7	-	Signal Ground
13	8	-	Data Carrier Detect
56	15	-	Transmit Clock
5	17	-	Receive Clock
41	18	-	Local Loopback

Table 82: RS-232 DTE Cable Pinouts for the 1-Port Serial Mini-PIM (continued)

LFH-60 Pin	DB-25 Pin	LFH-60 Pairing	Description
33	20	-	Data Terminal Ready
52	24	-	Terminal Clock
22 to 21	-	-	-
18 to 17	-	-	-

RS-422/449 (EIA-449) DCE Cable Pinouts for the 1-Port Serial Mini-Physical Interface Module

Table 83 on page 149 gives the RS-422/449 DCE cable pinouts.

Table 83: RS-422/449 DCE Cable Pinouts for the 1-Port Serial Mini-PIM

LFH-60 Pin	DC-37 (DB-37) Pin	LFH-60 Pairing	Description
15	1	-	Shield Ground
1	4	2	Send Data (A)
56	5	55	Send Timing (A)
60	6	59	Receive Data (A)
37	7	38	Request to Send (A)
52	8	51	Receive Timing (A)
48	9	47	Clear to Send (A)
45	10	-	Local Loopback
33	11	34	Data Mode (A)
9	12	10	Terminal Ready (A)

Table 83: RS-422/449 DCE Cable Pinouts for the 1-Port Serial Mini-PIM (continued)

LFH-60 Pin	DC-37 (DB-37) Pin	LFH-60 Pairing	Description
13	13	14	Receive Ready (A)
5	17	6	Terminal Timing (A)
36	19	-	Signal Ground
4	20	-	Receive Common
2	22	1	Send Data (B)
55	23	56	Send Timing (B)
59	24	60	Receive Data (B)
38	25	37	Request to Send (B)
51	26	52	Receive Timing (B)
47	27	48	Clear to Send (B)
34	29	33	Data Mode (B)
10	30	9	Terminal Ready (B)
14	31	13	Receiver Ready (B)
6	35	5	Terminal Timing (B)
57	37	-	Send Common
26 to 25	-	-	-

RS-422/449 (EIA-449) DTE Cable Pinouts for the 1-Port Serial Mini-Physical Interface Module

Table 84 on page 151 gives the RS-422/449 DTE cable pinouts.

Table 84: RS-422/449 DTE Cable Pinouts for the 1-Port Serial Mini-PIM

LFH-60 Pin	DC-37 (DB-37) Pin	LFH-60 Pairing	Description
15	1	-	Shield Ground
60	4	59	Send Data (A)
56	5	55	Send Timing (A)
1	6	2	Receive Data (A)
48	7	47	Request to Send (A)
5	8	6	Receive Timing (A)
37	9	38	Clear to Send (A)
41	10	-	Local Loopback
9	11	10	Data Mode (A)
33	12	34	Terminal Ready (A)
13	13	14	Receive Ready (A)
52	17	51	Terminal Timing (A)
36	19	-	Signal Ground
4	20	-	Receive Common
59	22	60	Send Data (B)
55	23	56	Send Timing (B)
2	24	1	Receive Data (B)
47	25	48	Request to Send (B)
6	26	5	Receive Timing (B)
38	27	37	Clear to Send (B)

Table 84: RS-422/449 DTE Cable Pinouts for the 1-Port Serial Mini-PIM (*continued*)

LFH-60 Pin	DC-37 (DB-37) Pin	LFH-60 Pairing	Description
10	29	9	Data Mode (B)
34	30	33	Terminal Ready (B)
14	31	13	Receiver Ready (B)
51	35	52	Terminal Timing (B)
57	37	-	Send Common
26 to 25	-	-	
18 to 17	-	-	

V.35 DCE Cable Pinouts for the 1-Port Serial Mini-Physical Interface Module

Table 85 on page 152 gives the V.35 DCE cable pinouts.

Table 85: V.35 DCE Cable Pinouts for the 1-Port Serial Mini-PIM

LFH-60 Pin	M/34 Pin	LFH-60 Pairing	Description
15	A	-	Frame Ground
57	B	-	Signal Ground
37	C	-	Request to Send
48	D	-	Clear to Send
33	E	-	Data Set Ready
13	F	-	Received Line Signal Detector
9	H	-	Data Terminal Ready
45	K	-	Test Mode

Table 85: V.35 DCE Cable Pinouts for the 1-Port Serial Mini-PIM (continued)

LFH-60 Pin	M/34 Pin	LFH-60 Pairing	Description
1	P	2	Transmit Data (A)
60	R	59	Receive Data (A)
2	S	1	Transmit Data (B)
59	T	60	Receive Data (B)
5	U	6	Terminal Timing (A)
52	V	51	Receive Timing (A)
6	W	5	Terminal Timing (B)
51	X	52	Receive Timing (B)
56	Y	55	Transmit Timing (A)
55	AA	56	Transmit Timing (B)
22 to 21	-	-	-
26 to 25	-	-	-

V.35 DTE Cable Pinouts for the 1-Port Serial Mini-Physical Interface Module

Table 86 on page 153 describes the V.35 DTE cable pinouts.

Table 86: V.35 DTE Cable Pinouts for the 1-Port Serial Mini-PIM

LFH-60 Pin	M/34 Pin	LFH-60 Pairing	Description
15	A	-	Frame Ground
57	B	-	Signal Ground
48	C	-	Request to Send

Table 86: V.35 DTE Cable Pinouts for the 1-Port Serial Mini-PIM (continued)

LFH-60 Pin	M/34 Pin	LFH-60 Pairing	Description
37	D	-	Clear to Send
9	E	-	Data Set Ready
13	F	-	Received Line Signal Detector
33	H	-	Data Terminal Ready
41	K	-	Test Mode
60	P	59	Transmit Data (A)
1	R	2	Receive Data (A)
59	S	60	Transmit Data (B)
2	T	1	Receive Data (B)
52	U	51	Terminal Timing (A)
5	V	6	Receive Timing (A)
51	W	52	Terminal Timing (B)
6	X	5	Receive Timing (B)
56	Y	55	Transmit Timing (A)
55	AA	56	Transmit Timing (B)
22 to 21	-	-	-
26 to 25	-	-	-
18 to 17	-	-	-

X.21 DCE Cable Pinouts for the 1-Port Serial Mini-Physical Interface Module

Table 87 on page 155 gives the X.21 DCE cable pinouts.

Table 87: X.21 DCE Cable Pinouts for the 1-Port Serial Mini-PIM

LFH-60 Pin	DB-15 Pin	LFH-60 Pairing	Description
15	1	-	Shield Ground
1	2	2	Transmit Data (A)
37	3	38	Control (A)
60	4	59	Receive (A)
48	5	47	Indicate (A)
52	6	51	Signal Element Timing (A)
57	8	-	Signal Ground
2	9	1	Transmit Data (B)
38	10	37	Control (B)
59	11	60	Receive (B)
47	12	48	Indicate (B)
51	13	52	Signal Element Timing (B)
30 to 29	-	-	-

X.21 DTE Cable Pinouts for the 1-Port Serial Mini-Physical Interface Module

Table 88 on page 156 gives the X.21 DTE cable pinouts.

Table 88: X.21 DTE Cable Pinouts for the 1-Port Serial Mini-PIM

LFH-60 Pin	DB-15 Pin	LFH-60 Pairing	Description
15	1	-	Shield Ground
60	2	59	Transmit Data (A)
48	3	47	Control (A)
1	4	2	Receive (A)
37	5	38	Indicate (A)
5	6	6	Signal Element Timing (A)
57	8	-	Signal Ground
59	9	60	Transmit Data (B)
47	10	48	Control (B)
2	11	1	Receive (B)
38	12	37	Indicate (B)
6	13	5	Signal Element Timing (B)
30 to 29	-	-	-
18 to 17	-	-	-

Serial Gigabit-Backplane Physical Interface Module Cable Specifications

IN THIS CHAPTER

- 8-Port Serial GPIM Interface Cables | 157
- EIA-449 DCE Cable Pinouts for 8-Port Serial Gigabit-Backplane Physical Interface Module | 159
- EIA-449 DTE Cable Pinouts for 8-Port Serial Gigabit-Backplane Physical Interface Module | 163
- EIA-530 DCE Cable Pinouts for the 8-Port Serial Gigabit-Backplane Physical Interface Module | 167
- EIA-530 DTE Cable Pinouts for the 8-Port Serial Gigabit-Backplane Physical Interface Module | 170
- EIA-530A DCE Cable Pinouts for 8-Port Serial Gigabit-Backplane Physical Interface Module | 174
- EIA-530A DTE Cable Pinouts for the 8-Port Serial Gigabit-Backplane Physical Interface Module | 177
- RS-232 DCE Cable Pinouts for the 8-Port Serial Gigabit-Backplane Physical Interface Module | 180
- RS-232 DTE Cable Pinouts for the 8-Port Serial Gigabit-Backplane Physical Interface Module | 182
- V.35 DCE Cable Pinouts for the 8-Port Serial Gigabit-Backplane Physical Interface Module | 184
- V.35 DTE Cable Pinouts for the 8-Port Serial Gigabit-Backplane Physical Interface Module | 188
- X.21 DCE Cable Pinouts for the 8-Port Serial Gigabit-Backplane Physical Interface Module | 191
- X.21 DTE Cable Pinouts for the 8-Port Serial Gigabit-Backplane Physical Interface Module | 193

8-Port Serial GPIM Interface Cables

All the ports of the 8-Port Serial Gigabit-Backplane Physical Interface Module (GPIM) are connected to two dual stacked 136-pin VHDCI connectors. Custom cables are used to connect from the VHDCI connectors to the data terminal equipment (DTE) or the data circuit-terminating equipment (DCE). Different cables are required to support different protocol and the protocols are identified using the cable ID. The cables are labeled with a letter (refers to the cable type) and 4 digits (unique serial numbers for the cables).

[Table 89 on page 158](#) lists the cables supported by 8-Port Serial GPIMs. You can order the cables from Juniper Networks to connect to a port on the synchronous 8-Port Serial GPIM. The device to which you are connecting and the serial interface types determine which type of cable you need.

Table 89: Juniper Networks Supported Cables

Product Number	Interface Type	Letter	Connector Type
SRX-CBL-RS232-DTE-2	RS-232 cable (DTE)	C	Plug
SRX-CBL-RS232-DCE-2	RS-232 cable (DCE)	D	Socket
SRX-CBL-V35-DTE-2	V.35 cable (DTE)	E	Plug
SRX-CBL-V35-DCE-2	V.35 cable (DCE)	F	Socket
SRX-CBL-EIA449-DTE-2	EIA-449 cable (DTE)	G	Plug
SRX-CBL-EIA449-DCE-2	EIA-449 cable (DCE)	H	Socket
SRX-CBL-EIA530A-DTE-2	EIA-530A cable (DTE)	I	Plug
SRX-CBL-EIA530A-DCE-2	EIA-530A cable (DCE)	J	Socket
SRX-CBL-X21-DTE-2	X.21 cable (DTE)	K	Plug
SRX-CBL-X21-DCE-2	X.21 cable (DCE)	L	Socket
SRX-CBL-EIA530-DTE-2	EIA-530 cable (DTE)	M	Plug
SRX-CBL-EIA530-DCE-2	EIA-530 cable (DCE)	N	Socket

Figure 39 on page 158 shows the cables with name A and B at the serial connector end. Label A refers to port 0, port 2, port 4, or port 6 and label B refers to port 1, port 3, port 5, or port 7 depending on which port the cable is connected.

Figure 39: Example of a Cable Numbering

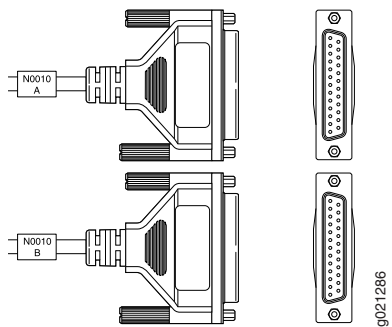

RELATED DOCUMENTATION

[8-Port Serial GPIM Overview | 99](#)

[8-Port Serial GPIM Hardware Specifications | 102](#)

[8-Port Serial GPIM Components | 100](#)

[8-Port Serial GPIM Key Features | 101](#)

[8-Port Serial GPIM LEDs | 103](#)

[8-Port Serial GPIM Interface Specifications | 27](#)

[8-Port Serial GPIM Basic Configuration | 225](#)

EIA-449 DCE Cable Pinouts for 8-Port Serial Gigabit-Backplane Physical Interface Module

Table 90 on page 159 gives the EIA-449 DCE cable pinouts for 8-Port Serial Gigabit-Backplane Physical Interface Module (GPIM).

Table 90: EIA-449 DCE Cable Pinouts for the 8-Port Serial GPIM

VHDCI-68 Pin	DB-37 (1) Pin	DB-37 (2) Pin	Dir Output (O) and Input (I)	Pair	Pairing	Description
T17	1					Shield Ground
T41	4		I	Pair 1	T39	Receive Data (A)
T7	5		O	Pair 2	T5	Send Timing (A)
T16	6		O	Pair 3	T14	Send Data (A)
T42	7		I	Pair 4	T40	Clear to Send (A)
T4	8		O	Pair 5	T2	Terminal Timing (A)
T50	9		O	Pair 6	T48	Request to Send (A)
T8	10		I			Local Loopback

Table 90: EIA-449 DCE Cable Pinouts for the 8-Port Serial GPIM (continued)

VHDCI-68 Pin	DB-37 (1) Pin	DB-37 (2) Pin	Dir Output (O) and Input (I)	Pair	Pairing	Description
T49	11		O	Pair 7	T47	Terminal Ready (A)
T45	12		I	Pair 8	T43	Data Mode (A)
T46	13		O	Pair 9	T44	Receive Ready (A)
T38	17		I	Pair 10	T36	Receive Timing (A)
T33	19					Shield Ground
T37	20					Shield Ground
T39	22		I	Pair 1	T41	Receive Data (B)
T5	23		O	Pair 2	T7	Send Timing (B)
T14	24		O	Pair 3	T16	Send Data (B)
T40	25		I	Pair 4	T42	Clear to Send (B)
T2	26		O	Pair 5	T4	Terminal Timing (B)
T48	27		O	Pair 6	T50	Request to Send (B)
T47	29		O	Pair 7	T59	Terminal Ready (B)
T43	30		I	Pair 8	T45	Data Mode (B)
T44	31		O	Pair 9	T46	Receiver Ready (B)

Table 90: EIA-449 DCE Cable Pinouts for the 8-Port Serial GPIM (continued)

VHDCI-68 Pin	DB-37 (1) Pin	DB-37 (2) Pin	Dir Output (O) and Input (I)	Pair	Pairing	Description
T36	35		I	Pair 10	T38	Receive Timing (B)
T51	37					Shield Ground
T11 to T15						Protocol Identifier_1
T52		1				Shield Ground
T59		4	I	Pair 1	T57	Receive Data (A)
T25		5	O	Pair 2	T23	Send Timing (A)
T34		6	O	Pair 3	T32	Send Data (A)
T60		7	I	Pair 4	T58	Clear to Send (A)
T22		8	O	Pair 5	T20	Terminal Timing (A)
T68		9	O	Pair 6	T66	Request to Send (A)
T26		10	I			Local Loopback
T67		11	O	Pair 7	T65	Terminal Ready (A)
T63		12	I	Pair 8	T61	Data Mode (A)
T64		13	O	Pair 9	T62	Receive Ready (A)
T56		17	I	Pair 10	T54	Receive Timing (A)
T18		19				Shield Ground

Table 90: EIA-449 DCE Cable Pinouts for the 8-Port Serial GPIM (continued)

VHDCI-68 Pin	DB-37 (1) Pin	DB-37 (2) Pin	Dir Output (O) and Input (I)	Pair	Pairing	Description
T24		20				Shield Ground
T57		22	I	Pair 1	T59	Receive Data (B)
T23		23	O	Pair 2	T25	Send Timing (B)
T32		24	O	Pair 3	T34	Send Data (B)
T58		25	I	Pair 4	T60	Clear to Send (B)
T20		26	O	Pair 5	T22	Terminal Timing (B)
T66		27	O	Pair 6	T68	Request to Send (B)
T65		29	O	Pair 7	T67	Terminal Ready (B)
T61		30	I	Pair 8	T63	Data Mode (B)
T62		31	O	Pair 9	T64	Receiver Ready (B)
T54		35	I	Pair 10	T56	Receive Timing (B)
T27		37				Shield Ground
T29 to T27						Protocol Identifier_1

RELATED DOCUMENTATION

EIA-449 DTE Cable Pinouts for 8-Port Serial Gigabit-Backplane Physical Interface Module | 163

EIA-530 DTE Cable Pinouts for the 8-Port Serial Gigabit-Backplane Physical Interface Module	170
EIA-530 DCE Cable Pinouts for the 8-Port Serial Gigabit-Backplane Physical Interface Module	167
EIA-530A DTE Cable Pinouts for the 8-Port Serial Gigabit-Backplane Physical Interface Module	177
EIA-530A DCE Cable Pinouts for 8-Port Serial Gigabit-Backplane Physical Interface Module	174
RS-232 DTE Cable Pinouts for the 8-Port Serial Gigabit-Backplane Physical Interface Module	182
RS-232 DCE Cable Pinouts for the 8-Port Serial Gigabit-Backplane Physical Interface Module	180
V.35 DTE Cable Pinouts for the 8-Port Serial Gigabit-Backplane Physical Interface Module	188
V.35 DCE Cable Pinouts for the 8-Port Serial Gigabit-Backplane Physical Interface Module	184
X.21 DTE Cable Pinouts for the 8-Port Serial Gigabit-Backplane Physical Interface Module	193
X.21 DCE Cable Pinouts for the 8-Port Serial Gigabit-Backplane Physical Interface Module	191

EIA-449 DTE Cable Pinouts for 8-Port Serial Gigabit-Backplane Physical Interface Module

Table 91 on page 163 gives the EIA-449 DTE cable pinouts for 8-Port Serial Gigabit-Backplane Physical Interface Module (GPIM).

Table 91: EIA-449 DTE Cable Pinouts for the 8-Port Serial GPIM

VHDCI-68 Pin	DB-37 (1) Pin	DB-37 (2) Pin	Dir Output (O) and Input (I)	Pair	Pairing	Description
T17	1					Shield Ground
T16	4		O	Pair 1	T14	Send Data (A)
T7	5		I	Pair 1	T5	Send Timing (A)
T41	6		I	Pair 3	T39	Receive Data (A)
T50	7		O	Pair 4	T48	Request to Send (A)
T38	8		I	Pair 5	T36	Receive Timing (A)
T42	9		I	Pair 6	T40	Clear to Send (A)
T10	10		O			Local Loopback

Table 91: EIA-449 DTE Cable Pinouts for the 8-Port Serial GPIM (continued)

VHDCI-68 Pin	DB-37 (1) Pin	DB-37 (2) Pin	Dir Output (O) and Input (I)	Pair	Pairing	Description
T45	11		I	Pair 7	T43	Data Mode (A)
T49	12		O	Pair 8	T47	Terminal Ready (A)
T46	13		I	Pair 9	T44	Receive Ready (A)
T4	17		O	Pair 10	T2	Terminal Timing (A)
T33	19					Shield Ground
T37	20					Shield Ground
T14	22		O	Pair 1	T16	Send Data (B)
T5	23		I	Pair 2	T7	Send Timing (B)
T39	24		I	Pair 3	T41	Send Data (B)
T48	25		O	Pair 4	T50	Request to Send (B)
T36	26		I	Pair 5	T38	Receive Timing (B)
T40	27		I	Pair 6	T42	Clear to Send (B)
T43	29		I	Pair 7	T45	Data Mode (B)
T47	30		O	Pair 8	T49	Terminal Ready (B)
T44	31		I	Pair 9	T46	Receiver Ready (B)
T2	35		O	Pair 10	T4	Terminal Timing (B)
T51	37					Shield Ground
T11 to T15						Protocol Identifier_1
T1 to T3						Protocol Mode

Table 91: EIA-449 DTE Cable Pinouts for the 8-Port Serial GPIM (continued)

VHDCI-68 Pin	DB-37 (1) Pin	DB-37 (2) Pin	Dir Output (O) and Input (I)	Pair	Pairing	Description
T52		1				Shield Ground
T34		4	O	Pair 1	T32	Send Data (A)
T25		5	I	Pair 2	T23	Send Timing (A)
T59		6	I	Pair 3	T57	Receive Data (A)
T68		7	O	Pair 4	T66	Request to Send (A)
T56		8	I	Pair 5	T54	Receive Timing (A)
T60		9	I	Pair 6	T58	Clear to Send (A)
T28		10	O			Local Loopback
T63		11	I	Pair 7	T61	Data Mode (A)
T67		12	O	Pair 8	T65	Terminal Ready (A)
T64		13	I	Pair 9	T62	Receive Ready (A)
T22		17	O	Pair 10	T20	Terminal Timing (A)
T18		19				Shield Ground
T24		20				Shield Ground
T32		22	O	Pair 1	T34	Send Data (B)
T23		23	I	Pair 2	T25	Send Timing (B)
T57		24	I	Pair 3	T59	Receive Data (B)
T66		25	O	Pair 4	T68	Request to Send (B)
T54		26	I	Pair 5	T56	Receive Timing (B)

Table 91: EIA-449 DTE Cable Pinouts for the 8-Port Serial GPIM (continued)

VHDCI-68 Pin	DB-37 (1) Pin	DB-37 (2) Pin	Dir Output (O) and Input (I)	Pair	Pairing	Description
T58		27	I	Pair 6	T60	Clear to Send (B)
T61		29	I	Pair 7	T63	Data Mode (B)
T65		30	O	Pair 8	T67	Terminal Ready (B)
T62		31	I	Pair 9	T64	Receiver Ready (B)
T20		35	O	Pair 10	T22	Terminal Timing (B)
T27		37				Shield Ground
T29 to T27						Protocol Identifier_1
T19 to T18						Protocol Mode

RELATED DOCUMENTATION

[EIA-449 DCE Cable Pinouts for 8-Port Serial Gigabit-Backplane Physical Interface Module | 159](#)

[EIA-530 DTE Cable Pinouts for the 8-Port Serial Gigabit-Backplane Physical Interface Module | 170](#)

[EIA-530 DCE Cable Pinouts for the 8-Port Serial Gigabit-Backplane Physical Interface Module | 167](#)

[EIA-530A DTE Cable Pinouts for the 8-Port Serial Gigabit-Backplane Physical Interface Module | 177](#)

[EIA-530A DCE Cable Pinouts for 8-Port Serial Gigabit-Backplane Physical Interface Module | 174](#)

[RS-232 DTE Cable Pinouts for the 8-Port Serial Gigabit-Backplane Physical Interface Module | 182](#)

[RS-232 DCE Cable Pinouts for the 8-Port Serial Gigabit-Backplane Physical Interface Module | 180](#)

[V.35 DTE Cable Pinouts for the 8-Port Serial Gigabit-Backplane Physical Interface Module | 188](#)

[V.35 DCE Cable Pinouts for the 8-Port Serial Gigabit-Backplane Physical Interface Module | 184](#)

[X.21 DTE Cable Pinouts for the 8-Port Serial Gigabit-Backplane Physical Interface Module | 193](#)

[X.21 DCE Cable Pinouts for the 8-Port Serial Gigabit-Backplane Physical Interface Module | 191](#)

EIA-530 DCE Cable Pinouts for the 8-Port Serial Gigabit-Backplane Physical Interface Module

Table 92 on page 167 gives the EIA-530 DCE cable pinouts for the 8-Port Serial Gigabit-Backplane Physical Interface Modules.

Table 92: EIA-530 DCE Cable Pinouts for the 8-Port Serial GPIM

VHDCI-68 Pin	DB-25 (1) Pin	DB-25 (2) Pin	Dir	Pair	Pairing	Description
T33	1					Shield Ground
T41	2		I	Pair 1	T39	Receive Data (A)
T16	3		O	Pair 2	T14	Send Data (A)
T42	4		I	Pair 3	T40	Clear to Send (A)
T50	5		O	Pair 4	T48	Request to Send (A)
T49	6		O	Pair 5	T47	Terminal Ready (A)
T47	22			Pair 5	T49	Terminal Ready (B)
T37	7					Shield Ground
T46	8		O	Pair 6	T44	Receive Ready (A)
T2	9		O	Pair 7	T4	Terminal Timing (B)
T44	10		O	Pair 6	T46	Receiver Ready (B)
T36	11		I	Pair 8	T38	Receive Timing (B)
T5	12		O	Pair 9	T7	Send Timing (B)
T48	13		O	Pair 4	T50	Request to Send (B)
T39	14		I	Pair 1	T41	Receive Data (B)

Table 92: EIA-530 DCE Cable Pinouts for the 8-Port Serial GPIM (continued)

VHDCI-68 Pin	DB-25 (1) Pin	DB-25 (2) Pin	Dir	Pair	Pairing	Description
T7	15		O	Pair 9	T5	Send Timing (A)
T14	16		O	Pair 2	T16	Send Data (B)
T4	17		O	Pair 7	T2	Terminal Timing (A)
T8	18		I			Local Loopback
T40	19		I	Pair 3	T42	Clear to Send (B)
T45	20		I	Pair 10	T43	Data Mode (A)
T43	23		I	Pair 10	T45	Terminal Ready (B)
T38	24		I	Pair 8	T36	Receive Timing (A)
T13 to T15						Protocol Identifier_0
T35 to T33						Protocol Identifier_2
T52		1				Shield Ground
T59		2	I	Pair 1	T57	Receive Data (A)
T34		3	O	Pair 2	T32	Send Data (A)
T60		4	I	Pair 3	T58	Clear to Send (A)
T68		5	O	Pair 4	T66	Request to Send (A)
T67		6	O	Pair 5	T65	Terminal Ready (A)
T65		22		Pair 5	T67	
T18		7				Shield Ground

Table 92: EIA-530 DCE Cable Pinouts for the 8-Port Serial GPIM (continued)

VHDCI-68 Pin	DB-25 (1) Pin	DB-25 (2) Pin	Dir	Pair	Pairing	Description
T64		8	O	Pair 6	T62	Receive Ready (A)
T20		9	O	Pair 7	T22	Terminal Timing (B)
T62		10	O	Pair 6	T64	Receiver Ready (B)
T54		11	I	Pair 8	T56	Receive Timing (B)
T23		12	O	Pair 9	T25	Send Timing (B)
T66		13	O	Pair 4	T68	Request to Send (B)
T57		14	I	Pair 1	T59	Receive Data (B)
T25		15	O	Pair 9	T23	Send Timing (A)
T32		16	O	Pair 2	T34	Send Data (B)
T22		17	O	Pair 7	T20	Terminal Timing (A)
T26		18	I			Local Loopback
T58		19	I	Pair 3	T60	Clear to Send (B)
T63		20	I	Pair 10	T61	Data Mode (A)
T61		23	I	Pair 10	T63	Data Mode (B)
T56		24	I	Pair 8	T54	Receive Timing (A)
T31 to T27						Protocol Identifier_0
T53 to T52						Protocol Identifier_2

RELATED DOCUMENTATION

EIA-449 DTE Cable Pinouts for 8-Port Serial Gigabit-Backplane Physical Interface Module	 163
EIA-449 DCE Cable Pinouts for 8-Port Serial Gigabit-Backplane Physical Interface Module	 159
EIA-530 DTE Cable Pinouts for the 8-Port Serial Gigabit-Backplane Physical Interface Module	 170
EIA-530A DTE Cable Pinouts for the 8-Port Serial Gigabit-Backplane Physical Interface Module	 177
EIA-530A DCE Cable Pinouts for 8-Port Serial Gigabit-Backplane Physical Interface Module	 174
RS-232 DTE Cable Pinouts for the 8-Port Serial Gigabit-Backplane Physical Interface Module	 182
RS-232 DCE Cable Pinouts for the 8-Port Serial Gigabit-Backplane Physical Interface Module	 180
V.35 DTE Cable Pinouts for the 8-Port Serial Gigabit-Backplane Physical Interface Module	 188
V.35 DCE Cable Pinouts for the 8-Port Serial Gigabit-Backplane Physical Interface Module	 184
X.21 DTE Cable Pinouts for the 8-Port Serial Gigabit-Backplane Physical Interface Module	 193
X.21 DCE Cable Pinouts for the 8-Port Serial Gigabit-Backplane Physical Interface Module	 191

EIA-530 DTE Cable Pinouts for the 8-Port Serial Gigabit-Backplane Physical Interface Module

[Table 93 on page 170](#) gives the EIA-530 DTE cable pinouts for the 8-Port Serial Gigabit-Backplane Physical Interface Modules.

Table 93: EIA-530 DTE Cable Pinouts for the 8-Port Serial GPIM

VHDCI-68 Pin	DB-25 (1) Pin	DB-25 (2) Pin	Dir	Pair	Pairing	Description
T33	1					Shield Ground
T16	2		O	Pair 1	T14	Send Data (A)
T41	3		I	Pair 2	T39	Receive Data (A)
T50	4		O	Pair 3	T48	Request to Send (A)
T42	5		I	Pair 4	T40	Clear to Send (A)
T45	6		I	Pair 5	T43	Data Mode (A)
T43	22		I	Pair 5	T45	Data Mode (B)

Table 93: EIA-530 DTE Cable Pinouts for the 8-Port Serial GPIM (continued)

VHDCI-68 Pin	DB-25 (1) Pin	DB-25 (2) Pin	Dir	Pair	Pairing	Description
T37	7					Shield Ground
T46	8		I	Pair 6	T44	Receive Ready (A)
T36	9		I	Pair 7	T38	Receive Timing (B)
T44	10		I	Pair 6	T46	Receiver Ready (B)
T2	11		O	Pair 8	T4	Terminal Timing (B)
T5	12		I	Pair 9	T7	Send Timing (B)
T40	13		I	Pair 4	T42	Clear to Send (B)
T14	14		O	Pair 1	T16	Send Data (B)
T7	15		I	Pair 9	T5	Send Timing (A)
T39	16		I	Pair 2	T41	Receive Data (B)
T38	17		I	Pair 7	T36	Receive Timing (A)
T10	18		O			Local Loopback
T48	19		O	Pair 3	T50	Request to Send (B)
T49	20		O	Pair 10	T47	Terminal Ready (A)
T47	23		O	Pair 10	T49	Terminal Ready (B)
T4	24		O	Pair 8	T2	Terminal Timing (A)
T13 to T15						Protocol Identifier_0
T35 to T33						Protocol Identifier_2

Table 93: EIA-530 DTE Cable Pinouts for the 8-Port Serial GPIM (continued)

VHDCI-68 Pin	DB-25 (1) Pin	DB-25 (2) Pin	Dir	Pair	Pairing	Description
T1 to T3						Protocol Mode
T52		1				Shield Ground
T34		2	O	Pair 1	T32	Send Data (A)
T59		3	I	Pair 2	T57	Receive Data (A)
T68		4	O	Pair 3	T66	Request to Send (A)
T60		5	I	Pair 4	T58	Clear to Send (A)
T63		6	I	Pair 5	T61	Data Mode (A)
T61		22	I	Pair 5	T63	Data Mode (B)
T18		7				Shield Ground
T64		8	I	Pair 6	T62	Receiver Ready (A)
T54		9	I	Pair 7	T56	Receive Timing (B)
T62		10	I	Pair 6	T64	Receiver Ready (B)
T20		11	O	Pair 8	T22	Terminal Timing (B)
T23		12	I	Pair 9	T25	Send Timing (B)
T58		13	I	Pair 4	T60	Clear to Send (B)
T32		14	O	Pair 1	T34	Send Data (B)
T25		15	I	Pair 9	T23	Send Timing (A)
T57		16	I	Pair 2	T59	Receive Data (B)
T56		17	I	Pair 7	T54	Receive Timing (A)

Table 93: EIA-530 DTE Cable Pinouts for the 8-Port Serial GPIM (continued)

VHDCI-68 Pin	DB-25 (1) Pin	DB-25 (2) Pin	Dir	Pair	Pairing	Description
T28		18	O			Local Loopback
T66		19	O	Pair 3	T68	Request to Send (B)
T67		20	O	Pair 10	T65	Terminal Ready (A)
T65		23	O	Pair 10	T67	Terminal Ready (B)
T22		24	O	Pair 8	T20	Terminal Timing (A)
T31 to T27						Protocol Identifier_0
T53 to T52						Protocol Identifier_2
T19 to T18						Protocol Mode

RELATED DOCUMENTATION

[EIA-449 DTE Cable Pinouts for 8-Port Serial Gigabit-Backplane Physical Interface Module | 163](#)

[EIA-449 DCE Cable Pinouts for 8-Port Serial Gigabit-Backplane Physical Interface Module | 159](#)

[EIA-530 DCE Cable Pinouts for the 8-Port Serial Gigabit-Backplane Physical Interface Module | 167](#)

[EIA-530A DTE Cable Pinouts for the 8-Port Serial Gigabit-Backplane Physical Interface Module | 177](#)

[EIA-530A DCE Cable Pinouts for 8-Port Serial Gigabit-Backplane Physical Interface Module | 174](#)

[RS-232 DTE Cable Pinouts for the 8-Port Serial Gigabit-Backplane Physical Interface Module | 182](#)

[RS-232 DCE Cable Pinouts for the 8-Port Serial Gigabit-Backplane Physical Interface Module | 180](#)

[V.35 DTE Cable Pinouts for the 8-Port Serial Gigabit-Backplane Physical Interface Module | 188](#)

[V.35 DCE Cable Pinouts for the 8-Port Serial Gigabit-Backplane Physical Interface Module | 184](#)

[X.21 DTE Cable Pinouts for the 8-Port Serial Gigabit-Backplane Physical Interface Module | 193](#)

[X.21 DCE Cable Pinouts for the 8-Port Serial Gigabit-Backplane Physical Interface Module | 191](#)

EIA-530A DCE Cable Pinouts for 8-Port Serial Gigabit-Backplane Physical Interface Module

Table 94 on page 174 gives the EIA-530A DCE cable pinouts for 8-Port Serial Gigabit-Backplane Physical Interface Module (GPIM).

Table 94: EIA-530A DCE Cable Pinouts for the 8-Port Serial GPIM

VHDCI-68 Pin	DB-25 (1) Pin	DB-25 (2) Pin	Dir Output (O) and Input (I)	Pair	Pairing	Description
T33	1			-		Shield Ground
T41	2		I	Pair 1	T39	Receive Data (A)
T16	3		O	Pair 3	T14	Send Data (A)
T42	4		I	Pair 4	T40	Clear to Send (A)
T50	5		O	Pair 5	T48	Request to Send (A)
T49	6		O			Terminal Ready (A)
T37	7					Shield Ground
T46	8		O	Pair 6	T44	Receive Ready (A)
T2	9		O	Pair 7	T4	Terminal Timing (B)
T44	10		O	Pair 6	T46	Receiver Ready (B)
T36	11		I	Pair 8	T38	Receive Timing (B)
T5	12		O	Pair 2	T7	Send Timing (B)
T48	13		O	Pair 5	T50	Request to Send (B)
T39	14		I	Pair 1	T41	Receive Data (B)
T7	15		O	Pair 2	T5	Send Timing (A)

Table 94: EIA-530A DCE Cable Pinouts for the 8-Port Serial GPIM (continued)

VHDCI-68 Pin	DB-25 (1) Pin	DB-25 (2) Pin	Dir Output (O) and Input (I)	Pair	Pairing	Description
T14	16		O	Pair 3	T16	Send Data (B)
T4	17		O	Pair 7	T2	Terminal Timing (A)
T8	18		I			Local Loopback
T40	19		I	Pair 4	T42	Clear to Send (B)
T45	20		I			Data Mode (A)
T51	23					Shield Ground
T38	24		I	Pair 8	T36	Receive Timing (A)
T11 to T15						Protocol Identifier_1
T35 to T33						Protocol Identifier_2
T52		1				Shield Ground
T59		2	I	Pair 1	T57	Receive Data (A)
T34		3	O	Pair 3	T32	Send Data (A)
T60		4	I	Pair 4	T58	Clear to Send (A)
T68		5	O	Pair 5	T66	Request to Send (A)
T67		6	O			Terminal Ready (A)
T18		7				Shield Ground
T64		8	O	Pair 6	T62	Receive Ready (A)
T20		9	O	Pair 7	T22	Terminal Timing (B)
T62		10	O	Pair 6	T64	Receiver Ready (B)

Table 94: EIA-530A DCE Cable Pinouts for the 8-Port Serial GPIM (continued)

VHDCI-68 Pin	DB-25 (1) Pin	DB-25 (2) Pin	Dir Output (O) and Input (I)	Pair	Pairing	Description
T54		11	I	Pair 8	T56	Receive Timing (B)
T23		12	O	Pair 2	T25	Send Timing (B)
T66		13	O	Pair 5	T68	Request to Send (B)
T57		14	I	Pair 1	T59	Receive Data (B)
T25		15	O	Pair 2	T23	Send Timing (A)
T32		16	O	Pair 3	T34	Send Data (B)
T22		17	O	Pair 7	T20	Terminal Timing (A)
T26		18	I			Local Loopback
T58		19	I	Pair 4	T60	Clear to Send (B)
T63		20	I			Data Mode (A)
T24		23				Shield Ground
T56		24	I	Pair 8	T54	Receive Timing (A)
T29 to T27						Protocol Identifier_1
T53 to T52						Protocol Identifier_2

RELATED DOCUMENTATION

[EIA-449 DTE Cable Pinouts for 8-Port Serial Gigabit-Backplane Physical Interface Module | 163](#)

[EIA-449 DCE Cable Pinouts for 8-Port Serial Gigabit-Backplane Physical Interface Module | 159](#)

[EIA-530 DTE Cable Pinouts for the 8-Port Serial Gigabit-Backplane Physical Interface Module | 170](#)

[EIA-530 DCE Cable Pinouts for the 8-Port Serial Gigabit-Backplane Physical Interface Module | 167](#)

[EIA-530A DTE Cable Pinouts for the 8-Port Serial Gigabit-Backplane Physical Interface Module | 177](#)

[RS-232 DTE Cable Pinouts for the 8-Port Serial Gigabit-Backplane Physical Interface Module | 182](#)

[RS-232 DCE Cable Pinouts for the 8-Port Serial Gigabit-Backplane Physical Interface Module | 180](#)

[V.35 DTE Cable Pinouts for the 8-Port Serial Gigabit-Backplane Physical Interface Module | 188](#)

[V.35 DCE Cable Pinouts for the 8-Port Serial Gigabit-Backplane Physical Interface Module | 184](#)

[X.21 DTE Cable Pinouts for the 8-Port Serial Gigabit-Backplane Physical Interface Module | 193](#)

[X.21 DCE Cable Pinouts for the 8-Port Serial Gigabit-Backplane Physical Interface Module | 191](#)

EIA-530A DTE Cable Pinouts for the 8-Port Serial Gigabit-Backplane Physical Interface Module

[Table 95 on page 177](#) gives the EIA-530A DTE cable pinouts for the 8-Port Serial Gigabit-Backplane Physical Interface Modules.

Table 95: EIA-530A DTE Cable Pinouts for the 8-Port Serial GPIM

VHDCI-68 Pin	DB-25 (1) Pin	DB-25 (2) Pin	Dir	Pair	Pairing	Description
T33	1					Shield Ground
T16	2		O	Pair 1	T14	Send Data (A)
T41	3		I	Pair 3	T39	Receive Data (A)
T50	4		O	Pair 4	T48	Request to Send (A)
T42	5		I	Pair 5	T40	Clear to Send (A)
T45	6		I			Data Mode (A)
T37	7					Shield Ground
T46	8		I	Pair 6	T44	Receive Ready (A)
T36	9		I	Pair 7	T38	Receive Timing (B)
T44	10		I	Pair 6	T36	Receiver Ready (B)
T2	11		O	Pair 8	T4	Terminal Timing (B)

Table 95: EIA-530A DTE Cable Pinouts for the 8-Port Serial GPIM (continued)

VHDCI-68 Pin	DB-25 (1) Pin	DB-25 (2) Pin	Dir	Pair	Pairing	Description
T5	12		I	Pair 2	T4	Send Timing (B)
T40	13		I	Pair 5	T42	Clear to Send (B)
T14	14		O	Pair 1	T16	Send Data (B)
T7	15		I	Pair 2	T50	Send Timing (A)
T39	16		I	Pair 3	T41	Receive Data (B)
T38	17		I	Pair 7	T36	Receive Timing (A)
T10	18		O			Local Loopback
T48	19		O	Pair 4	T50	Request to Send (B)
T49	20		O			Terminal Ready (A)
T51	23					Shield Ground
T4	24		O	Pair 8	T2	Terminal Timing (A)
T11 to T15						Protocol Identifier_1
T35 to T33						Protocol Identifier_2
T1 to T3						Protocol Mode
T52		1				Shield Ground
T34		2	O	Pair 1	T32	Send Data (A)
T59		3	I	Pair 3	T57	Receive Data (A)
T68		4	O	Pair 4	T66	Clear to Send (A)
T60		5	I	Pair 5	T58	Data Mode (A)

Table 95: EIA-530A DTE Cable Pinouts for the 8-Port Serial GPIM (continued)

VHDCI-68 Pin	DB-25 (1) Pin	DB-25 (2) Pin	Dir	Pair	Pairing	Description
T63		6	I			Shield Ground
T18		7				Receive Ready (A)
T64		8	I	Pair 6	T62	Receive Timing (B)
T54		9	I	Pair 7	T56	Receiver Ready (B)
T62		10	I	Pair 6	T64	Receiver Ready (B)
T20		11	O	Pair 8	T22	Terminal Timing (B)
T23		12	I	Pair 2	T25	Send Timing (B)
T58		13	I	Pair 5	T60	Clear to Send (B)
T32		14	O	Pair 1	T34	Send Data (B)
T25		15	I	Pair 2	T23	Send Timing (A)
T57		16	I	Pair 3	T59	Receive Data (B)
T56		17	I	Pair 7	T54	Receive Timing (A)
T28		18	O			Local Loopback
T66		19	O	Pair 4	T68	Request to Send (B)
T67		20	O			Terminal Ready (A)
T24		23				Shield Ground
T22		24	O	Pair 8	T20	Terminal Timing (A)
T29 to T27						Protocol Identifier_1
T53 to T52						Protocol Identifier_2

Table 95: EIA-530A DTE Cable Pinouts for the 8-Port Serial GPIM (continued)

VHDCI-68 Pin	DB-25 (1) Pin	DB-25 (2) Pin	Dir	Pair	Pairing	Description
T19 to T18						Protocol Mode

RELATED DOCUMENTATION

[EIA-449 DTE Cable Pinouts for 8-Port Serial Gigabit-Backplane Physical Interface Module | 163](#)

[EIA-449 DCE Cable Pinouts for 8-Port Serial Gigabit-Backplane Physical Interface Module | 159](#)

[EIA-530 DTE Cable Pinouts for the 8-Port Serial Gigabit-Backplane Physical Interface Module | 170](#)

[EIA-530 DCE Cable Pinouts for the 8-Port Serial Gigabit-Backplane Physical Interface Module | 167](#)

[EIA-530A DCE Cable Pinouts for 8-Port Serial Gigabit-Backplane Physical Interface Module | 174](#)

[RS-232 DTE Cable Pinouts for the 8-Port Serial Gigabit-Backplane Physical Interface Module | 182](#)

[RS-232 DCE Cable Pinouts for the 8-Port Serial Gigabit-Backplane Physical Interface Module | 180](#)

[V.35 DTE Cable Pinouts for the 8-Port Serial Gigabit-Backplane Physical Interface Module | 188](#)

[V.35 DCE Cable Pinouts for the 8-Port Serial Gigabit-Backplane Physical Interface Module | 184](#)

[X.21 DTE Cable Pinouts for the 8-Port Serial Gigabit-Backplane Physical Interface Module | 193](#)

[X.21 DCE Cable Pinouts for the 8-Port Serial Gigabit-Backplane Physical Interface Module | 191](#)

RS-232 DCE Cable Pinouts for the 8-Port Serial Gigabit-Backplane Physical Interface Module

Table 96 on page 180 gives the RS-232 DCE cable pinouts for the 8-Port Serial Gigabit-Backplane Physical Interface Modules.

Table 96: RS-232 DCE Cable Pinouts for the 8-Port Serial GPIM

VHDCI-68 Pin	DB-25 (1) Pin	DB-25 (2) Pin	Dir	Description
T37	1			Shield Ground
T41	2		I	Receive Data (A)
T16	3		O	Send Data (A)
T42	4		I	Clear to Send (A)

Table 96: RS-232 DCE Cable Pinouts for the 8-Port Serial GPIM (continued)

VHDCI-68 Pin	DB-25 (1) Pin	DB-25 (2) Pin	Dir	Description
T50	5		O	Request to Send (A)
T49	6		O	Terminal Ready (A)
T51	7			Shield Ground
T46	8		O	Receive Ready (A)
T7	15		O	Send Timing (A)
T4	17		O	Terminal Timing (A)
T8	18		I	Local Loopback
T45	20		I	Data Mode (A)
T38	24		I	Receive Timing (A)
T13 to T12				Protocol Identifier_0
T52		1		Shield Ground
T59		2	I	Receive Data (A)
T34		3	O	Send Data (A)
T60		4	I	Clear to Send (A)
T68		5	O	Request to Send (A)
T67		6	O	Terminal Ready (A)
T55		7		Shield Ground
T64		8	O	Receive Ready (A)
T25		15	O	Send Timing (A)
T22		17	O	Terminal Timing (A)
T26		18	I	Local Loopback

Table 96: RS-232 DCE Cable Pinouts for the 8-Port Serial GPIM (continued)

VHDCI-68 Pin	DB-25 (1) Pin	DB-25 (2) Pin	Dir	Description
T63		20	I	Data Mode (A)
T56		24	I	Receive Timing (A)
T31 to T30				Protocol Identifier_0

RELATED DOCUMENTATION

[EIA-449 DTE Cable Pinouts for 8-Port Serial Gigabit-Backplane Physical Interface Module | 163](#)

[EIA-449 DCE Cable Pinouts for 8-Port Serial Gigabit-Backplane Physical Interface Module | 159](#)

[EIA-530 DTE Cable Pinouts for the 8-Port Serial Gigabit-Backplane Physical Interface Module | 170](#)

[EIA-530 DCE Cable Pinouts for the 8-Port Serial Gigabit-Backplane Physical Interface Module | 167](#)

[EIA-530A DTE Cable Pinouts for the 8-Port Serial Gigabit-Backplane Physical Interface Module | 177](#)

[EIA-530A DCE Cable Pinouts for 8-Port Serial Gigabit-Backplane Physical Interface Module | 174](#)

[RS-232 DTE Cable Pinouts for the 8-Port Serial Gigabit-Backplane Physical Interface Module | 182](#)

[V.35 DTE Cable Pinouts for the 8-Port Serial Gigabit-Backplane Physical Interface Module | 188](#)

[V.35 DCE Cable Pinouts for the 8-Port Serial Gigabit-Backplane Physical Interface Module | 184](#)

[X.21 DTE Cable Pinouts for the 8-Port Serial Gigabit-Backplane Physical Interface Module | 193](#)

[X.21 DCE Cable Pinouts for the 8-Port Serial Gigabit-Backplane Physical Interface Module | 191](#)

RS-232 DTE Cable Pinouts for the 8-Port Serial Gigabit-Backplane Physical Interface Module

Table 97 on page 182 gives the RS-232 DTE cable pinouts for the 8-Port Serial Gigabit-Backplane Physical Interface Modules.

Table 97: RS-232 DTE Cable Pinouts for the 8-Port Serial GPIM

VHDCI-68 Pin	DB-25 (1) Pin	DB-25 (2) Pin	Dir	Description
T37	1			Shield Ground
T16	2		O	Send Data (A)

Table 97: RS-232 DTE Cable Pinouts for the 8-Port Serial GPIM (continued)

VHDCI-68 Pin	DB-25 (1) Pin	DB-25 (2) Pin	Dir	Description
T41	3		I	Receive Data (A)
T50	4		O	Request to Send (A)
T42	5		I	Clear to Send (A)
T45	6		I	Data Mode (A)
T51	7			Shield Ground
T46	8		I	Receive Ready (A)
T7	15		I	Send Timing (A)
T38	17		I	Receive Timing (A)
T10	18		O	Local Loopback
T49	20		O	Terminal Ready (A)
T4	24		O	Terminal Timing (A)
T13 to T12				Protocol Identifier_0
T1 to T3				Protocol Mode
T52		1		Shield Ground
T34		2	O	Send Data (A)
T59		3	I	Receive Data (A)
T68		4	O	Request to Send (A)
T60		5	I	Clear to Send (A)
T63		6	I	Data Mode (A)
T55		7		Shield Ground
T64		8	I	Receive Ready (A)

Table 97: RS-232 DTE Cable Pinouts for the 8-Port Serial GPIM (continued)

VHDCI-68 Pin	DB-25 (1) Pin	DB-25 (2) Pin	Dir	Description
T25		15	I	Send Timing (A)
T56		17	I	Receive Timing (A)
T28		18	O	Local Loopback
T67		20	O	Terminal Ready (A)
T22		24	O	Terminal Timing (A)
T31 to T30				Protocol Identifier_0
T19 to T18				Protocol Mode

RELATED DOCUMENTATION

[EIA-449 DTE Cable Pinouts for 8-Port Serial Gigabit-Backplane Physical Interface Module | 163](#)

[EIA-449 DCE Cable Pinouts for 8-Port Serial Gigabit-Backplane Physical Interface Module | 159](#)

[EIA-530 DTE Cable Pinouts for the 8-Port Serial Gigabit-Backplane Physical Interface Module | 170](#)

[EIA-530 DCE Cable Pinouts for the 8-Port Serial Gigabit-Backplane Physical Interface Module | 167](#)

[EIA-530A DTE Cable Pinouts for the 8-Port Serial Gigabit-Backplane Physical Interface Module | 177](#)

[EIA-530A DCE Cable Pinouts for 8-Port Serial Gigabit-Backplane Physical Interface Module | 174](#)

[RS-232 DCE Cable Pinouts for the 8-Port Serial Gigabit-Backplane Physical Interface Module | 180](#)

[V.35 DTE Cable Pinouts for the 8-Port Serial Gigabit-Backplane Physical Interface Module | 188](#)

[V.35 DCE Cable Pinouts for the 8-Port Serial Gigabit-Backplane Physical Interface Module | 184](#)

[X.21 DTE Cable Pinouts for the 8-Port Serial Gigabit-Backplane Physical Interface Module | 193](#)

[X.21 DCE Cable Pinouts for the 8-Port Serial Gigabit-Backplane Physical Interface Module | 191](#)

V.35 DCE Cable Pinouts for the 8-Port Serial Gigabit-Backplane Physical Interface Module

Table 98 on page 185 gives the V.35 DCE cable pinouts for the 8-Port Serial Gigabit-Backplane Physical Interface Modules.

Table 98: V.35 DCE Cable Pinouts for the 8-Port Serial GPIM

VHDCI-68 Pin	M34 (1) Pin	M34 (2) Pin	Dir	Pair	Pairing	Description
T37	A					Shield Ground
T51	B					Shield Ground
T42	C		I			Clear to Send (A)
T50	D		O			Request to Send (A)
T49	E		O			Terminal Ready (A)
T46	F		O			Receive Ready (A)
T45	H		I			Data Mode (A)
T8	K1		I			Local Loopback
T41	P		I	Pair 1	T39	Receive Data (A)
T16	R		O	Pair 2	T14	Send Data (A)
T39	S		I	Pair 1	T41	Receive Data (B)
T14	T		O	Pair 2	T16	Send Data (B)
T38	U		I	Pair 3	T36	Receive Timing (A)
T4	V		O	Pair 4	T2	Terminal Timing (A)
T36	W		I	Pair 3	T38	Receive Timing (B)
T2	X		O	Pair 4	T4	Terminal Timing (B)
T7	Y		O	Pair 5	T5	Send Timing (A)

Table 98: V.35 DCE Cable Pinouts for the 8-Port Serial GPIM (continued)

VHDCI-68 Pin	M34 (1) Pin	M34 (2) Pin	Dir	Pair	Pairing	Description
T5	AA		O	Pair 5	T7	Send Timing (B)
T13 to T12						Protocol Identifier_0
T11 to T15						Protocol Identifier_1
T52		A				Shield Ground
T55		B				Shield Ground
T60		C	I			Clear to Send (A)
T68		D	O			Request to Send (A)
T67		E	O			Terminal Ready (A)
T64		F	O			Receive Ready (A)
T63		H	I			Data Mode (A)
T26		K1	I			Local Loopback
T59		P	I	Pair 1	T57	Receive Data (A)
T34		R	O	Pair 2	T32	Send Data (A)
T57		S	I	Pair 1	T59	Receive Data (B)
T32		T	O	Pair 2	T34	Send Data (B)
T56		U	I	Pair 3	T54	Receive Timing (A)
T22		V	O	Pair 4	T20	Terminal Timing (A)

Table 98: V.35 DCE Cable Pinouts for the 8-Port Serial GPIM (continued)

VHDCI-68 Pin	M34 (1) Pin	M34 (2) Pin	Dir	Pair	Pairing	Description
T54		W	I	Pair 3	T56	Receive Timing (B)
T20		X	O	Pair 4	T22	Terminal Timing (B)
T25		Y	O	Pair 5	T23	Send Timing (A)
T23		AA	O	Pair 5	T25	Send Timing (B)
T31 to T30						Protocol Identifier_0
T29 to T27						Protocol Identifier_1

RELATED DOCUMENTATION

[EIA-449 DTE Cable Pinouts for 8-Port Serial Gigabit-Backplane Physical Interface Module | 163](#)

[EIA-449 DCE Cable Pinouts for 8-Port Serial Gigabit-Backplane Physical Interface Module | 159](#)

[EIA-530 DTE Cable Pinouts for the 8-Port Serial Gigabit-Backplane Physical Interface Module | 170](#)

[EIA-530 DCE Cable Pinouts for the 8-Port Serial Gigabit-Backplane Physical Interface Module | 167](#)

[EIA-530A DTE Cable Pinouts for the 8-Port Serial Gigabit-Backplane Physical Interface Module | 177](#)

[EIA-530A DCE Cable Pinouts for 8-Port Serial Gigabit-Backplane Physical Interface Module | 174](#)

[RS-232 DTE Cable Pinouts for the 8-Port Serial Gigabit-Backplane Physical Interface Module | 182](#)

[RS-232 DCE Cable Pinouts for the 8-Port Serial Gigabit-Backplane Physical Interface Module | 180](#)

[V.35 DTE Cable Pinouts for the 8-Port Serial Gigabit-Backplane Physical Interface Module | 188](#)

[X.21 DTE Cable Pinouts for the 8-Port Serial Gigabit-Backplane Physical Interface Module | 193](#)

[X.21 DCE Cable Pinouts for the 8-Port Serial Gigabit-Backplane Physical Interface Module | 191](#)

V.35 DTE Cable Pinouts for the 8-Port Serial Gigabit-Backplane Physical Interface Module

Table 99 on page 188 gives the V.35 DTE cable pinouts for the 8-Port Serial Gigabit-Backplane Physical Interface Modules.

Table 99: V.35 DTE Cable Pinouts for the 8-Port Serial GPIM

VHDCI-68 Pin	M34 (1) Pin	M34 (2) Pin	Dir	Pair	Pairing	Description
T37	A					Shield Ground
T51	B					Shield Ground
T50	C		O			Request to Send (A)
T42	D		I			Clear to Send (A)
T45	E		I			Data Mode (A)
T46	F		I			Receive Ready (A)
T49	H		O			Terminal Ready (A)
T10	K1		O			Local Loopback
T16	P		O	Pair 1	T14	Send Data (A)
T41	R		I	Pair 2	T39	Receive Data (A)
T14	S		O	Pair 1	T16	Send Data (B)
T39	T		I	Pair 2	T41	Receive Data (B)
T4	U		O	Pair 3	T2	Terminal Timing (A)
T38	V		I	Pair 4	T36	Receive Timing (A)
T2	W		O	Pair 3	T4	Terminal Timing (B)
T36	X		I	Pair 4	T38	Receive Timing (B)

Table 99: V.35 DTE Cable Pinouts for the 8-Port Serial GPIM (continued)

VHDCI-68 Pin	M34 (1) Pin	M34 (2) Pin	Dir	Pair	Pairing	Description
T7	Y		I	Pair 5	T5	Send Timing (A)
T5	AA		I	Pair 5	T7	Send Timing (B)
T13 to T12						Protocol Identifier_0
T11 to T15						Protocol Identifier_1
T1 to T3						Protocol Mode
T52		A				Shield Ground
T55		B				Shield Ground
T68		C	O			Request to Send (A)
T60		D	I			Clear to Send (A)
T63		E	I			Data Mode (A)
T64		F	I			Receive Ready (A)
T67		H	O			Terminal Ready (A)
T28		K1	O		T32	Local Loopback
T34		P	O	Pair 1	T57	Send Data (A)
T59		R	I	Pair 2	T34	Receive Data (A)
T32		S	O	Pair 1	T59	Send Data (B)
T57		T	I	Pair 2	T20	Receive Data (B)
T22		U	O	Pair 3	T54	Terminal Timing (A)
T56		V	I	Pair 4	T22	Receive Timing (A)

Table 99: V.35 DTE Cable Pinouts for the 8-Port Serial GPIM (continued)

VHDCI-68 Pin	M34 (1) Pin	M34 (2) Pin	Dir	Pair	Pairing	Description
T20		W	O	Pair 3	T54	Terminal Timing (B)
T54		X	I	Pair 4	T25	Receive Timing (B)
T25		Y	I	Pair 5	T23	Send Timing (A)
T23		AA	I	Pair 5		Send Timing (B)
T31 to T30						Protocol Identifier_0
T29 to T27						Protocol Identifier_1
T19 to T18						Protocol Mode

RELATED DOCUMENTATION

[EIA-449 DTE Cable Pinouts for 8-Port Serial Gigabit-Backplane Physical Interface Module | 163](#)

[EIA-449 DCE Cable Pinouts for 8-Port Serial Gigabit-Backplane Physical Interface Module | 159](#)

[EIA-530 DTE Cable Pinouts for the 8-Port Serial Gigabit-Backplane Physical Interface Module | 170](#)

[EIA-530 DCE Cable Pinouts for the 8-Port Serial Gigabit-Backplane Physical Interface Module | 167](#)

[EIA-530A DTE Cable Pinouts for the 8-Port Serial Gigabit-Backplane Physical Interface Module | 177](#)

[EIA-530A DCE Cable Pinouts for 8-Port Serial Gigabit-Backplane Physical Interface Module | 174](#)

[RS-232 DTE Cable Pinouts for the 8-Port Serial Gigabit-Backplane Physical Interface Module | 182](#)

[RS-232 DCE Cable Pinouts for the 8-Port Serial Gigabit-Backplane Physical Interface Module | 180](#)

[V.35 DCE Cable Pinouts for the 8-Port Serial Gigabit-Backplane Physical Interface Module | 184](#)

[X.21 DTE Cable Pinouts for the 8-Port Serial Gigabit-Backplane Physical Interface Module | 193](#)

[X.21 DCE Cable Pinouts for the 8-Port Serial Gigabit-Backplane Physical Interface Module | 191](#)

X.21 DCE Cable Pinouts for the 8-Port Serial Gigabit-Backplane Physical Interface Module

Table 100 on page 191 gives the X.21 DCE cable pinouts for the 8-Port Serial Gigabit-Backplane Physical Interface Modules.

Table 100: X.21 DCE Cable Pinouts for the 8-Port Serial GPIM

VHDCI-68 Pin	DB-15 (1) Pin	DB-15 (2) Pin	Dir	Pair	Pairing	Description
T37	1					Shield Ground
T41	2		I	Pair 1	T39	Receive Data (A)
T42	3		I	Pair 2	T40	Clear to Send (A)
T16	4		O	Pair 3	T14	Send Data (A)
T50	5		O	Pair 4	T48	Request to Send (A)
T4	6		O	Pair 5	T2	Terminal Timing (A)
T51	8					Shield Ground
T39	9		I	Pair 1	T41	Receive Data (B)
T40	10		I	Pair 2	T42	Clear to Send (B)
T14	11		O	Pair 3	T16	Send Data (B)
T48	12		O	Pair 4	T50	Request to Send (B)
T2	13		O	Pair 5	T4	Terminal Timing (B)
T35 to T33						Protocol Identifier_2
T52		1				Shield Ground
T59		2	I	Pair 1	T57	Receive Data (A)
T60		3	I	Pair 2	T58	Clear to Send (A)

Table 100: X.21 DCE Cable Pinouts for the 8-Port Serial GPIM (continued)

VHDCI-68 Pin	DB-15 (1) Pin	DB-15 (2) Pin	Dir	Pair	Pairing	Description
T34		4	O	Pair 3	T32	Send Data (A)
T68		5	O	Pair 4	T66	Request to Send (A)
T22		6	O	Pair 5	T20	Terminal Timing (A)
T55		8				Shield Ground
T57		9	I	Pair 1	T59	Receive Data (B)
T58		10	I	Pair 2	T60	Clear to Send (B)
T32		11	O	Pair 3	T34	Send Data (B)
T66		12	O	Pair 4	T68	Request to Send (B)
T20		13	O	Pair 5	T22	Terminal Timing (B)
T53 to T52						Protocol Identifier_2

RELATED DOCUMENTATION

[EIA-449 DTE Cable Pinouts for 8-Port Serial Gigabit-Backplane Physical Interface Module | 163](#)

[EIA-449 DCE Cable Pinouts for 8-Port Serial Gigabit-Backplane Physical Interface Module | 159](#)

[EIA-530 DTE Cable Pinouts for the 8-Port Serial Gigabit-Backplane Physical Interface Module | 170](#)

[EIA-530 DCE Cable Pinouts for the 8-Port Serial Gigabit-Backplane Physical Interface Module | 167](#)

[EIA-530A DTE Cable Pinouts for the 8-Port Serial Gigabit-Backplane Physical Interface Module | 177](#)

[EIA-530A DCE Cable Pinouts for 8-Port Serial Gigabit-Backplane Physical Interface Module | 174](#)

[RS-232 DTE Cable Pinouts for the 8-Port Serial Gigabit-Backplane Physical Interface Module | 182](#)

[RS-232 DCE Cable Pinouts for the 8-Port Serial Gigabit-Backplane Physical Interface Module | 180](#)

[V.35 DTE Cable Pinouts for the 8-Port Serial Gigabit-Backplane Physical Interface Module | 188](#)

[V.35 DCE Cable Pinouts for the 8-Port Serial Gigabit-Backplane Physical Interface Module | 184](#)

[X.21 DTE Cable Pinouts for the 8-Port Serial Gigabit-Backplane Physical Interface Module | 193](#)

X.21 DTE Cable Pinouts for the 8-Port Serial Gigabit-Backplane Physical Interface Module

Table 101 on page 193 gives the X.21 DTE cable pinouts for the 8-Port Serial Gigabit-Backplane Physical Interface Modules.

Table 101: X.21 DTE Cable Pinouts for the 8-Port Serial GPIM

VHDCI-68 Pin	DB-15 (1) Pin	DB-15 (2) Pin	Dir	Pair	Pairing	Description
T37	1					Shield Ground
T16	2		O	Pair 1	T14	Send Data (A)
T50	3		O	Pair 2	T48	Request to Send (A)
T41	4		I	Pair 3	T39	Receive Data (A)
T42	5		I	Pair 4	T40	Clear to Send (A)
T38	6		I	Pair 5	T36	Receive Timing (A)
T51	8					Shield Ground
T14	9		O	Pair 1	T16	Send Data (B)
T48	10		O	Pair 2	T50	Request to Send (B)
T39	11		I	Pair 3	T41	Receive Data (B)
T40	12		I	Pair 4	T42	Clear to Send (B)
T36	13		I	Pair 5	T38	Receive Timing (B)
T35 to T33						Protocol Identifier_2
T1 to T3						Protocol Mode
T52		1				Shield Ground
T34		2	O	Pair 1	T32	Send Data (A)
T68		3	O	Pair 2	T66	Request to Send (A)

Table 101: X.21 DTE Cable Pinouts for the 8-Port Serial GPIM (continued)

VHDCI-68 Pin	DB-15 (1) Pin	DB-15 (2) Pin	Dir	Pair	Pairing	Description
T59		4	I	Pair 3	T57	Receive Data (A)
T60		5	I	Pair 4	T58	Clear to Send (A)
T56		6	I	Pair 5	T54	Receive Timing (A)
T55		8				Shield Ground
T32		9	O	Pair 1	T34	Send Data (B)
T66		10	O	Pair 2	T68	Request to Send (B)
T57		11	I	Pair 3	T59	Receive Data (B)
T58		12	I	Pair 4	T60	Clear to Send (B)
T54		13	I	Pair 5	T56	Receive Timing (B)
T53 to T52						Protocol Identifier_2
T19 to T18						Protocol Mode

RELATED DOCUMENTATION

[EIA-449 DTE Cable Pinouts for 8-Port Serial Gigabit-Backplane Physical Interface Module | 163](#)

[EIA-449 DCE Cable Pinouts for 8-Port Serial Gigabit-Backplane Physical Interface Module | 159](#)

[EIA-530 DTE Cable Pinouts for the 8-Port Serial Gigabit-Backplane Physical Interface Module | 170](#)

[EIA-530 DCE Cable Pinouts for the 8-Port Serial Gigabit-Backplane Physical Interface Module | 167](#)

[EIA-530A DTE Cable Pinouts for the 8-Port Serial Gigabit-Backplane Physical Interface Module | 177](#)

[EIA-530A DCE Cable Pinouts for 8-Port Serial Gigabit-Backplane Physical Interface Module | 174](#)

[RS-232 DTE Cable Pinouts for the 8-Port Serial Gigabit-Backplane Physical Interface Module | 182](#)

[RS-232 DCE Cable Pinouts for the 8-Port Serial Gigabit-Backplane Physical Interface Module | 180](#)

[V.35 DTE Cable Pinouts for the 8-Port Serial Gigabit-Backplane Physical Interface Module | 188](#)

[V.35 DCE Cable Pinouts for the 8-Port Serial Gigabit-Backplane Physical Interface Module | 184](#)

[X.21 DCE Cable Pinouts for the 8-Port Serial Gigabit-Backplane Physical Interface Module | 191](#)

4

PART

Configuration

Configuring Mini-Physical Interface Modules | **196**

Configuring Gigabit-Backplane Physical Interface Modules | **214**

Mini-Physical Interface Module and Gigabit-Backplane Physical Interface Module
Operating Modes and Supported Modules | **239**

Configuring Mini-Physical Interface Modules

IN THIS CHAPTER

- 1-Port Gigabit Ethernet SFP Mini-Physical Interface Module Basic Configuration | 196
- 1-Port SFP Mini-Physical Interface Module Basic Configuration | 199
- 1-Port ADSL2+ Mini-Physical Interface Module Basic Configuration | 201
- 1-Port DOCSIS Mini-Physical Interface Module Basic Configuration | 204
- 1-Port G.SHDSL 8-Wire Mini-Physical Interface Module Basic Configuration | 206
- 1-Port Serial Mini-Physical Interface Module Basic Configuration | 207
- 1-Port T1/E1 Mini-Physical Interface Module Basic Configuration | 209
- 1-Port VDSL2 (Annex A) Mini-Physical Interface Module Basic Configuration | 211

1-Port Gigabit Ethernet SFP Mini-Physical Interface Module Basic Configuration

IN THIS SECTION

- Using the J-Web Interface | 197
- Using the CLI | 198

To enable the 1-Port Gigabit Ethernet small form-factor pluggable Mini-Physical Interface Module (SFP Mini-PIM) installed on the SRX Series Services Gateway, you must configure the basic settings for the PIM. You can perform the configuration tasks for this using either the J-Web interface or the CLI.

Using the J-Web Interface

To perform basic configuration of the 1-Port Gigabit Ethernet SFP Mini-PIM and to configure network interfaces for the services gateway using the J-Web interface:

1. In the J-Web interface, select **Configure>Interfaces>Ports**.

The Interfaces page is displayed and lists the network interfaces present on the services gateway, along with configuration information (if the device is configured).

2. To configure properties for a network interface (Mini-PIM), select the interface name, and click **Edit**.
3. To use the port on the Mini-PIM, you must assign it to a security zone other than the Null zone. Optionally, you can also assign the port an IP address (for example, 192.168.3.1/24). Enter or select the following settings:

NOTE: The configuration settings given in the following steps are an example. The actual configuration settings might vary depending on your requirements.

- a. Select **Configure>Security>Zones/Screens**.
 - b. Add or select a security zone other than Null; for example, **Trust**.
 - c. For host inbound traffic, set the following:
 - Services=**telnet**
 - Protocols=**ospf**
 - d. Click **OK**, and click **Commit** to apply the configuration and other pending changes (if any).
4. To use the port on the Mini-PIM, you must also set security policies. Select the following settings:
 - a. Select **Configure>Security>Policy>Apply Policy**.
 - b. Set Policy Action: Default Policy Action=**from-zone trust to-zone trust**.
 - c. Click **OK** to save changes, and click **Commit** to apply the configuration and other pending changes (if any).

For advanced configuration information, see the [Junos OS Network Interfaces Configuration Guide](#).

Using the CLI

To perform basic configuration of the 1-Port Gigabit Ethernet SFP Mini-PIM and to configure network interfaces for the services gateway with the CLI:

NOTE: The configuration settings given in the following steps are an example. The actual configuration settings might vary depending on your requirements.

- Verify that the 1-Port Gigabit Ethernet SFP Mini-PIM is installed on the device:

show chassis hardware

user@host > show chassis hardware

The following is a sample output of the command (SRX240 output shown, other devices similar):

```
Hardware inventory:
Item                Version  Part number  Serial number  Description
Chassis
Routing Engine     REV 01   750-021793   PW7925         RE-SRX240H
  da0              999 MB  ST72682
  usb0 (addr 1)    DWC OTG root hub 0   vendor 0x0000  uhub0
  usb0 (addr 2)    product 0x6254 25172 vendor 0x058f  uhub1
  usb0 (addr 3)    ST72682 High Speed Mode 64218 STMicroelectronics umass0
FPC 0
  PIC 0
FPC 1
  PIC 0
FPC 2              REV 00   750-032730   AABC5081      FPC
  PIC 0
  Xcvr 0           REV 02   740-013111   9101465      SFP-T
FPC 3
  PIC 0
FPC 4
  PIC 0
  Xcvr 0           REV 01   740-011782   PBL0C3T      SFP-SX
Power Supply 0
```

NOTE: In the example shown above, the output for the 1-Port SFP Mini-PIM appears as 1X GE SFP mPIM, and the output for the 1-Port Gigabit Ethernet SFP Mini-PIM appears as 1X GE High-Perf SFP mPIM.

- Verify the status of the interface:

show interfaces terse

- Assign the port an IP address, for example:

set interfaces ge-1/0/0 unit 0 family inet address *interface address/destination prefix*

- Add or select a security zone; for example, Trust:

set security zones security-zone trust interfaces ge-1/0/0.0 host-inbound-traffic system-services telnet

- Add or select security zones for host inbound traffic protocol options, for example :

set security zones security-zone trust interfaces ge-1/0/0.0 host-inbound-traffic protocols ospf

- Set security policies:

set security policies from-zone trust to-zone trust

RELATED DOCUMENTATION

[1-Port Gigabit Ethernet SFP Mini-Physical Interface Module Overview | 33](#)

[1-Port Gigabit Ethernet SFP Mini-Physical Interface Module Hardware Specifications | 35](#)

[1-Port Gigabit Ethernet SFP Mini-Physical Interface Module Network Interface Specifications | 19](#)

[1-Port Gigabit Ethernet SFP Mini-Physical Interface Module Supported Modules | 36](#)

[1-Port Gigabit Ethernet SFP Mini-Physical Interface Module Key Features | 34](#)

1-Port SFP Mini-Physical Interface Module Basic Configuration

IN THIS SECTION

- [Using the J-Web Interface | 200](#)
- [Using the CLI | 201](#)

To enable the 1-Port small form-factor pluggable Mini-Physical Interface Module (SFP Mini-PIM) installed on the SRX Series Services Gateway, you must configure the basic settings for the PIM. You can perform the configuration tasks for this using either the J-Web interface or the CLI.

Using the J-Web Interface

To perform basic configuration of the 1-Port SFP Mini-PIM and to configure network interfaces for the services gateway using the J-Web interface:

1. In the J-Web interface, select **Configure>Interfaces>Ports**.

The Interfaces page displays and lists the network interfaces present on the services gateway, along with configuration information (if configured).

2. To configure properties for a network interface (Mini-PIM), select the interface name, and click **Edit**.

3. To use the port on the Mini-PIM, you must assign it to a security zone other than the Null zone. Optionally, you can also assign the port an IP address (for example, 192.168.3.1/24). Enter or select the following settings:

- a. Select **Configure>Security>Zones/Screens**.
- b. Add or select a security zone other than Null; for example, **Trust**.
- c. For host inbound traffic, set the following:
 - Services=**Allow All**
 - Protocols=**Allow All**
- d. Click **OK**, and click **Commit** to apply the configuration and other pending changes (if any).

4. To use the port on the Mini-PIM, you must also set security policies. Select the following settings:

- a. Select **Configure>Security>Policy>Apply Policy**.
- b. Set Policy Action: Default Policy Action=**Permit-All**.
- c. Click **OK** to save changes, and click **Commit** to apply the configuration and other pending changes (if any).

For advanced configuration information, see the [Junos OS Network Interfaces Configuration Guide](#).

Using the CLI

To perform basic configuration for the 1-Port SFP Mini-PIM and to configure network interfaces for the services gateway with the CLI:

- Verify that the 1-Port SFP Mini-PIM is installed on the device:

```
show chassis hardware
```

- Verify the status of the interface:

```
show interfaces terse
```

- Assign the port an IP address:

```
set interfaces ge-1/0/0 unit 0 family inet address interface address/destination prefix
```

- Add or select a security zone; for example, Trust:

```
set security zones security-zone trust interfaces ge-1/0/0.0 host-inbound-traffic system-services all
```

- Add or select security zones for host inbound traffic protocol options:

```
set security zones security-zone trust interfaces ge-1/0/0.0 host-inbound-traffic protocols all
```

- Set security policies:

```
set security policies default-policy permit-all
```

RELATED DOCUMENTATION

[1-Port SFP Mini-Physical Interface Module Overview | 39](#)

[1-Port SFP Mini-Physical Interface Module Hardware Specifications | 41](#)

[1-Port SFP Mini-Physical Interface Module Network Interface Specifications | 20](#)

[1-Port SFP Mini-Physical Interface Module Supported Modules | 42](#)

[1-Port SFP Mini-Physical Interface Module Key Features | 40](#)

1-Port ADSL2+ Mini-Physical Interface Module Basic Configuration

IN THIS SECTION

● [Using the J-Web Interface | 202](#)

● [Using the CLI | 203](#)

To enable the 1-Port ADSL2+ Mini-Physical Interface Module (Mini-PIM) installed on the SRX Series Services Gateway, you must configure the basic settings for the PIM. You can perform the configuration tasks for this using either the J-Web interface or the CLI:

Using the J-Web Interface

To perform basic configuration for the 1-Port ADSL2 Mini-PIM and to configure network interfaces for the services gateway using the J-Web interface:

1. In the J-Web interface, select **Configure>Interfaces>Ports**.

The Interfaces page displays and lists the network interfaces present on the services gateway, along with configuration information (if configured).

2. To configure properties for a network interface (Mini-PIM), select the interface name (**at-1/0/0**), and click **Edit**.

3. To use the port on the Mini-PIM, you must assign it to a security zone other than the Null zone. Optionally, you can also assign the port an IP address (for example, 192.168.3.1/24). Enter or select the following settings:

- a. Select **Configure>Security>Zones**.

- b. Add or select a security zone other than Null; for example, **Trust**.

- c. For host inbound traffic, set the following:

- System Services=**Allow All**
- Protocols=**Allow All**

- d. Click **OK** to save changes, and click **Commit** to apply the configuration and other pending changes.

4. To use the port on the Mini-PIM, you must also set security policies. Select the following settings:

- a. Select **Configure>Security>Policy>Apply Policy**.

- b. Set Policy Action: Default Policy Action=**Permit-All**.

- c. Click **OK** to save changes, and click **Commit** to apply the configuration and other pending changes (if any).

See the [Junos OS Network Interfaces Configuration Guide](#) for more details.

Using the CLI

To perform basic configuration for the 1-Port ADSL2+ Mini-PIM and to configure network interfaces for the services gateway with the CLI:

- Verify that the serial interface is installed on the device:

```
show chassis hardware
```

- Verify the status of the interface:

```
show interfaces terse
```

- Assign the port an IP address:

```
set interfaces at-1/0/0 unit 0 family inet address interface address/destination prefix
```

- Add or select a security zone; for example, Trust:

```
set security zones security-zone trust interfaces at-1/0/0.0 host-inbound-traffic system-services all
```

- Add or select security zones for host inbound traffic protocol options:

```
set security zones security-zone trust interfaces at-1/0/0.0 host-inbound-traffic protocols all
```

- Set security policies:

```
set security policies default-policy permit-all
```

See the [Junos OS Network Interfaces Configuration Guide](#) for more details.

RELATED DOCUMENTATION

[1-Port ADSL2+ Mini-Physical Interface Module Overview | 45](#)

[1-Port ADSL2+ Mini-Physical Interface Module Hardware Specifications | 47](#)

[1-Port ADSL2+ Mini-Physical Interface Module Network Interface Specifications | 21](#)

[1-Port ADSL2+ Mini-Physical Interface Module Supported Standards | 48](#)

[1-Port ADSL2+ Mini-Physical Interface Module Key Features | 46](#)

[1-Port ADSL2+ Mini-Physical Interface Module LEDs | 48](#)

1-Port DOCSIS Mini-Physical Interface Module Basic Configuration

IN THIS SECTION

- [Using the J-Web Interface | 204](#)
- [Using the CLI | 205](#)

To enable the Data over Cable System Interface Specifications Mini-Physical Interface Module (1-Port DOCSIS Mini-PIM) installed on the SRX Series Services Gateway, you must configure the basic settings for the PIM. You can perform the configuration tasks for this using either the J-Web interface or the CLI:

Using the J-Web Interface

To perform basic configuration for the 1-Port DOCSIS Mini-PIM and to configure network interfaces for the services gateway using the J-Web interface:

1. In the J-Web interface, select **Configure>Interfaces>Ports**.

The Interfaces page displays and lists the network interfaces present on the services gateway, along with configuration information (if configured).

2. To configure properties for a network interface (Mini-PIM), select the interface name (**cm-1/0/0**), and click **Edit**.
3. To use the port on the Mini-PIM, you must assign it to a security zone other than the Null zone. Optionally, you can also assign the port an IP address (for example, 192.168.3.1/24). Enter or select the following settings:
 - a. Select **Configure>Security>Zones**.
 - b. Add or select a security zone other than Null; for example, **Trust**.
 - c. For host inbound traffic, set the following:
 - System Services=**Allow All**

- Protocols=**Allow All**
- d. Click **OK** to save changes, and click **Commit** to apply the configuration and other pending changes.
4. To use the port on the Mini-PIM, you must also set security policies. Select the following settings:
 - a. Select **Configure>Security>Policy>Apply Policy**.
 - b. Set Policy Action: Default Policy Action=**Permit-All**.
 - c. Click **OK** to save changes, and click **Commit** to apply the configuration and other pending changes (if any).

For more information, in the J-Web interface, select **Configure>Interfaces** and click **Help**.

Using the CLI

To perform basic configuration of the 1-Port DOCSIS Mini-PIM and to configure network interfaces for the services gateway with the CLI:

- Verify that the 1-Port DOCSIS Mini-Physical Interface Module is installed on the services gateway:
show chassis hardware
- Verify the status of the interface:
show interfaces terse
- Assign the port an IP address:
set interfaces cm-1/0/0 unit 0 family inet address *interface address/destination prefix*
- Add or select a security zone; for example, Trust:
set security zones security-zone trust interfaces cm-1/0/0.0 host-inbound-traffic system-services all
- Add or select security zones for host inbound traffic protocol options:
set security zones security-zone trust interfaces cm-1/0/0 host-inbound-traffic protocols all
- Set security policies:
set security policies default-policy permit-all

See the [Junos OS Network Interfaces Configuration Guide](#) for more details.

RELATED DOCUMENTATION

| [1-Port DOCSIS Mini-Physical Interface Module Overview](#) | 51

[1-Port DOCSIS Mini-Physical Interface Module Key Features | 52](#)

[1-Port DOCSIS Mini-Physical Interface Module Supported Standards | 55](#)

[1-Port DOCSIS Mini-Physical Interface Module Hardware Specifications | 53](#)

[1-Port DOCSIS Mini-Physical Interface Module Network Interface Specifications | 22](#)

[1-Port DOCSIS Mini-Physical Interface Module LEDs | 54](#)

1-Port G.SHDSL 8-Wire Mini-Physical Interface Module Basic Configuration

To enable the 1-Port G.SHDSL Mini-Physical Interface Module (Mini-PIM) installed on the SRX Series Services Gateway, you must configure its properties. You can perform the same configuration tasks using J-Web or the CLI. In addition, you can configure a wider variety of options that are encountered less frequently.

To perform basic configuration of the 1-Port G.SHDSL Mini-PIM and configure network interfaces for the services gateway with the CLI:

- Verify that the 1-Port G.SHDSL Mini-PIM is installed on the services gateway:

show chassis hardware

- Verify the status of the interface:

show interfaces terse

- Assign the port an IP address:

set interface at-1/0/0 unit 0 family inet address *interface address/destination prefix*

- Add or select a security zone, for example, Zone1:

set security zones security-zone zone1 interfaces at-1/0/0.0 host-inbound-traffic system-services all

- Add or select a security zones for host inbound traffic protocol options:

set security zones security-zone zone1 interfaces at-1/0/0.0 host-inbound-traffic protocols all

- Set security policies:

set security policies default-policy permit-all

RELATED DOCUMENTATION

[1-Port G.SHDSL 8-Wire Mini-Physical Interface Module Overview | 57](#)

[1-Port G.SHDSL 8-Wire Mini-Physical Interface Module Supported Standards | 61](#)

[1-Port G.SHDSL 8-Wire Mini-Physical Interface Module Operating Modes | 239](#)

[1-Port G.SHDSL 8-Wire Mini-Physical Interface Module Key Features | 58](#)

[1-Port G.SHDSL 8-Wire Mini-Physical Interface Module Hardware Specifications | 59](#)

1-Port Serial Mini-Physical Interface Module Basic Configuration

IN THIS SECTION

- [Using the J-Web Interface | 207](#)
- [Using the CLI | 208](#)

To enable the 1-Port Serial Mini-Physical Interface Module (Mini-PIM) installed on the SRX Series Services Gateway, you must configure the basic settings for the PIM. You can perform the configuration tasks for this using either the J-Web interface or the CLI.

Using the J-Web Interface

To perform basic configuration of the 1-Port Serial Mini-PIM and to configure network interfaces for the services gateway using the J-Web interface:

1. In the J-Web interface, select **Configure>Interfaces>Ports**.

The Interfaces page displays and lists the network interfaces present on the services gateway, along with configuration information (if configured).

2. To configure properties for a network interface (Mini-PIM), select the interface name (**se-1/0/0**), and click **Edit**.
3. To use the port on the Mini-PIM, you must assign it to a security zone other than the Null zone. Optionally, you can also assign the port an IP address (for example, 192.168.3.1/24). Enter or select the following settings:
 - a. Select **Configure>Security>Zones**.
 - b. Add or select a security zone other than Null; for example, **Trust**
 - c. For host inbound traffic, set the following:
 - System Services=**Allow All**

- Protocols=**Allow All**
- d. Click **OK** to save changes, and click **Commit** to apply the configuration and other pending changes (if any).
4. To use the port on the Mini-PIM, you must also set security policies. Select the following settings:
 - a. Select **Configure>Security>Policy>Apply Policy**.
 - b. Set Policy Action: Default Policy Action=**Permit-All**.
 - c. Click **OK** to save changes, and click **Commit** to apply the configuration and other pending changes (if any).

For advanced configuration information, see the [Junos OS Network Interfaces Configuration Guide](#).

Using the CLI

To perform basic configuration for the 1-Port Serial Mini-PIM and to configure network interfaces for the services gateway with the CLI:

- Verify that the serial interface is installed on the device:

```
show chassis hardware
```
- Verify the status of the interface:

```
show interfaces terse
```
- Assign the port an IP address:

```
set interfaces se-1/0/0 unit 0 family inet address interface address/destination prefix
```
- Add or select a security zone; for example, Trust:

```
set security zones security-zone trust interfaces se-1/0/0.0 host-inbound-traffic system-services all
```
- Add or select security zones for host inbound traffic protocol options:

```
set security zones security-zone trust interfaces se-1/0/0.0 host-inbound-traffic protocols all
```
- Set security policies:

```
set security policies default-policy permit-all
```

RELATED DOCUMENTATION

| [1-Port Serial Mini-Physical Interface Module Overview](#) | 62

[1-Port Serial Mini-Physical Interface Module Hardware Specifications | 63](#)

[1-Port Serial Mini-Physical Interface Module Supported Standards | 65](#)

[1-Port Serial Mini-Physical Interface Module Key Features | 63](#)

[1-Port Serial Mini-Physical Interface Module LEDs | 64](#)

1-Port T1/E1 Mini-Physical Interface Module Basic Configuration

IN THIS SECTION

● [Using the J-Web Interface | 209](#)

● [Using the CLI | 210](#)

To enable the 1-Port T1/E1 Mini-Physical Interface Module (Mini-PIM) installed on the SRX Series Services Gateway, you must configure the basic settings for the PIM. You can perform the configuration tasks for this using either the J-Web interface or the CLI.

Using the J-Web Interface

To perform basic configuration for the 1-Port T1/E1 Mini-Physical Interface Module and to configure network interfaces for the services gateway using the J-Web interface:

1. In the J-Web interface, select **Configure>Interfaces>Ports**.

The Interfaces page displays and lists the network interfaces present on the services gateway, along with configuration information (if configured).

2. To configure properties for a network interface (Mini-PIM), select the interface name (**t1-1/0/0** or **e1-1/0/0**), and click **Edit**.
3. To use the port on the Mini-PIM, you must assign it to a security zone other than the Null zone. Optionally, you can also assign the port an IP address (for example, 192.168.3.1/24). Enter or select the following settings:
 - a. Select **Configure>Security>Zones**.
 - b. Add or select a security zone other than Null; for example, **Trust**.

- c. For host inbound traffic, set the following:
 - System Services=**Allow All**
 - Protocols=**Allow All**
 - d. Click **OK** to save changes, and click **Commit** to apply the configuration and other pending changes (if any).
4. To use the port on the Mini-PIM, you must also set security policies. Select the following settings:
 - a. Select **Configure>Security>Policy>Apply Policy**.
 - b. Set Policy Action: Default Policy Action=**Permit-All**.
 - c. Click **OK** to save changes, and click **Commit** to apply the configuration and other pending changes (if any).

For advanced configuration information, see the [Junos OS Network Interfaces Configuration Guide](#).

Using the CLI

To perform basic configuration for the 1-Port T1/E1 Mini-PIM (for the T1 interface) and to configure network interfaces for the services gateway with the CLI:

- Verify that the T1/E1 interface is installed on the device:

```
show chassis hardware
```

- Verify the status of the interface:

```
show interfaces terse
```

- Assign the port an IP address:

For T1 interfaces:

```
set interfaces t1-1/0/0 unit 0 family inet address interface address/destination prefix
```

For E1 interfaces:

```
set interfaces e1-1/0/0 unit 0 family inet address interface address/destination prefix
```

- Add or select a security zone; for example, Trust:

For T1 interfaces:

```
set security zones security-zone trust interfaces t1-1/0/0.0 host-inbound-traffic system-services all
```

For E1 interfaces:

```
set security zones security-zone trust interfaces e1-1/0/0.0 host-inbound-traffic system-services all
```

- Add or select security zones for host inbound traffic protocol options:

For T1 interfaces:

```
set security zones security-zone trust interfaces t1-1/0/0.0 host-inbound-traffic protocols all
```

For E1 interfaces:

```
set security zones security-zone trust interfaces e1-1/0/0.0 host-inbound-traffic protocols all
```

- Set security policies:

```
set security policies default-policy permit-all
```

NOTE: You can use the CLI commands **set interfaces t1-1/0/0** or **set interfaces e1-1/0/0** to enable the 1-Port T1/E1 Mini-PIM to function as a T1 or an E1 interface.

RELATED DOCUMENTATION

[1-Port T1/E1 Mini-Physical Interface Module Overview | 66](#)

[1-Port T1/E1 Mini-Physical Interface Module Hardware Specifications | 67](#)

[1-Port T1/E1 Mini-Physical Interface Module Network Interface Specifications | 23](#)

[1-Port T1/E1 Mini-Physical Interface Module Supported Standards | 69](#)

[1-Port T1/E1 Mini-Physical Interface Module LEDs | 68](#)

[1-Port T1/E1 Mini-Physical Interface Module Supported Loopback Diagnostics | 70](#)

1-Port VDSL2 (Annex A) Mini-Physical Interface Module Basic Configuration

IN THIS SECTION

- [Using the J-Web Interface | 212](#)
- [Using the CLI | 212](#)

To enable the 1-Port VDSL2 (Annex A) Mini-Physical Interface Module (Mini-PIM) installed on the SRX Series Services Gateway, you must configure the basic settings for the PIM. You can perform the configuration tasks for this using either the J-Web interface or the CLI.

Using the J-Web Interface

To perform basic configuration for the 1-Port VDSL2 (Annex A) Mini-Physical Interface Module (Mini-PIM) and to configure network interfaces for the services gateway using the J-Web interface:

1. In the J-Web interface, select **Configure>Interfaces>Ports**.

The Interfaces page displays and lists the network interfaces present on the services gateway, along with configuration information (if configured).

2. To configure properties for a network interface (Mini-PIM), select the interface name (**pt-1/0/0**), and click **Edit**.
3. To use the port on the Mini-PIM, you must assign it to a security zone other than the Null zone. Optionally, you can also assign the port an IP address (for example, 192.168.3.1/24). Enter or select the following settings:
 - a. Select **Configure>Security>Zones**.
 - b. Add or select a security zone other than Null; for example, **Trust**.
 - c. For host inbound traffic, set the following:
 - System Services=**Allow All**
 - Protocols=**Allow All**
 - d. Click **OK** to save changes, and click **Commit** to apply the configuration and other pending changes.
4. To use the port on the Mini-PIM, you must also set security policies. Select the following settings:
 - a. Select **Configure>Security>Policy>Apply Policy**.
 - b. Set Policy Action: Default Policy Action=**Permit-All**.
 - c. Click **OK** to save changes, and click **Commit** to apply the configuration and other pending changes (if any).

For more information, in the J-Web interface, select **Configure>Interfaces** and click **Help**.

Using the CLI

To perform basic configuration of the 1-Port VDSL2 (Annex A) Mini-PIM and to configure network interfaces for the services gateway with the CLI:

- Verify that the 1-Port VDSL2 interface is installed on the device:
show chassis hardware
- Verify the status of the interface:
show interfaces terse
- Assign the port an IP address:
set interfaces pt-1/0/0 unit 0 family inet address *interface address/destination prefix*
- Add or select a security zone; for example, Zone1:
set security zones security-zone trust interfaces pt-1/0/0.0 host-inbound-traffic system-services all
- Add or select security zones for host inbound traffic options protocols:
set security zones security-zone trust interfaces pt-1/0/0.0 host-inbound-traffic protocols all
- Set security policies:
set security policies default-policy permit-all

See the [Junos OS Network Interfaces Configuration Guide](#) for more details.

RELATED DOCUMENTATION

[1-Port VDSL2 \(Annex A\) Mini-Physical Interface Module Overview | 72](#)

[1-Port VDSL2 \(Annex A\) Mini-Physical Interface Module Key Features | 73](#)

[1-Port VDSL2 \(Annex A\) Mini-Physical Interface Module Supported Profiles | 75](#)

[1-Port VDSL2 \(Annex A\) Mini-Physical Interface Module Hardware Specifications | 74](#)

[1-Port VDSL2 \(Annex A\) Mini-Physical Interface Module Cable Specifications | 141](#)

Configuring Gigabit-Backplane Physical Interface Modules

IN THIS CHAPTER

- 1-Port Clear Channel DS3/E3 GPIM Basic Configuration | 214
- 2-Port 10-Gigabit Ethernet XPIM Basic Configuration | 217
- 8-Port Gigabit Ethernet SFP XPIM Basic Configuration | 221
- 8-Port Serial GPIM Basic Configuration | 225
- 16-Port Gigabit Ethernet XPIM Basic Configuration | 229
- 24-Port Gigabit Ethernet XPIM Basic Configuration | 229
- Dual CT1/E1 GPIM Basic Configuration | 232
- Quad CT1/E1 GPIM Basic Configuration | 235

1-Port Clear Channel DS3/E3 GPIM Basic Configuration

IN THIS SECTION

- Using the CLI | 214

To enable the 1-Port Clear Channel DS3/E3 GPIM installed on the SRX Series Services Gateway, you must configure its properties. You can perform the basic configuration tasks using the CLI. In addition, you can configure a wide variety of options that are not encountered frequently.

Using the CLI

To perform basic configuration for the 1-Port Clear Channel DS3/E3 GPIM and to configure network interfaces for the services gateway with the CLI:

- Verify that the 1-Port Clear Channel DS3/E3 GPIM is installed on the services gateway:

show chassis hardware

```

root@srx650r03> show chassis hardware
Hardware inventory:
Item                Version  Part number  Serial number  Description
Chassis              REV 09   710-023875   AABJ4077      SRX650
Midplane             REV 08   710-023209   AABK2897      SRXSME System IO
System IO            REV 18   750-023223   AABJ8853      RE-SRXSME-SRE6
Routing Engine
FPC 0
  PIC 0              REV 03   750-023873   TV4286        4x GE Base PIC
FPC 2
FPC 5
FPC 6
  PIC 0              REV 10   750-023810   AABE1433      FPC
FPC 7
FPC 8
  PIC 0              REV 10   750-023808   AAAJ9355      FPC
FPC 8
  PIC 0              REV 10   750-023808   AAV0753      4x CT1E1 gPIM
FPC 7
FPC 8
  PIC 0              REV 09   750-023810   AAAC6572      FPC
Power Supply 0      Rev 03   740-024283   UE05105      1x CLR CH T3/E3
PS 645W AC

```

- Verify the FPC status of the interface:

show chassis fpc

```

root@srx650r03> show chassis fpc
Slot State          Temp  CPU Utilization (%)  Memory  Utilization (%)
                   (C)   Total  Interrupt           DRAM (MB) Heap    Buffer
0  Online           ----- CPU less FPC -----
1  Empty            ----- Not Usable -----
2  Offline          ----- FPC configured offline -----
3  Empty            ----- Not Usable -----
4  Empty            ----- Not Usable -----
5  Offline          ----- FPC configured offline -----
6  Online           0      0      128      14      41
7  Offline          ----- FPC configured offline -----
8  Online           0      0      128      14      41

```

- Verify the PIC status:

show chassis fpc pic-status

```

root@srx650r03> show chassis fpc pic-status
Slot 0   Online      FPC
  PIC 0   Online      4x GE Base PIC
Slot 2   Offline    FPC
Slot 5   Offline    FPC
Slot 6   Online      FPC
  PIC 0   Online      4x CT1E1 gPIM
Slot 7   Offline    FPC
Slot 8   Online      FPC
  PIC 0   Online      1x CLR CH T3/E3

```

- Set the DS3/E3 port mode; for example, DS3 mode:

```
set chassis fpc <fpc no> pic 0 port 0 framing t3/e3
```

NOTE: By default, the PIC comes up in DS3 mode and the t3-x/y/z physical interface is created. The port mode chosen for t3 is IFDP_T3, and the port mode chosen for e3 is IFDP_E3.

- Assign the port an IP address:

```
set interfaces t3-3/0/0 unit 0 family inet address interface address/destination prefix
```

- Assign MTU values:

```
set interfaces t3-3/0/0 unit 0 family inet mtu mtu values
```

- Enable/disable unframed DS3 mode; for example, unframed:

```
set interfaces t3-3/0/0 t3-options unframed
```

- Set encapsulation:

```
set interfaces t3-3/0/0 encapsulation cisco-hdlc
```

- Add or select a security zone; for example, trust:

```
set security zones security-zone trust interfaces t3-3/0/0.0 host-inbound-traffic system-services all
```

- Add or select security zones for host inbound traffic:

```
set security zones security-zone trust interfaces t3-3/0/0.0 host-inbound-traffic protocols all
```

- Set security policies:

```
set security policies default-policy permit-all
```

2-Port 10-Gigabit Ethernet XPIM Basic Configuration

IN THIS SECTION

- Using the J-Web Interface | 217
- Using the Point and Click CLI to Set Interface Mode and Speed Options | 218
- Using the CLI | 219

To enable the 2-Port 10-Gigabit Ethernet XPIM installed on the SRX Series Services Gateway, you must configure the basic settings for the PIM. You can perform the configuration tasks for this using the J-Web interface, the Point and Click CLI, or the CLI.

Using the J-Web Interface

To perform basic configuration for the 2-Port 10-Gigabit Ethernet XPIM and to configure network interfaces for the services gateway using the J-Web interface:

1. In the J-Web interface, select **Configure>Interfaces>Ports**.

The Interfaces page lists the network interfaces present on the services gateway. Verify whether the interface has been configured by reviewing the information in the Configured column (**yes/no**).

2. Select the interface name to edit.
3. To use the port on the XPIM, you must assign it to a security zone other than the Null zone. Optionally, you can also assign the port an IP address (for example, **192.168.3.1/24**). Enter or select the following settings:
 - a. Select **Configure>Security>Zones**.
 - b. Add or select a security zone other than Null; for example, **Trust**.
 - c. For host inbound traffic, set the following:
 - System Services=**Allow All**

- Protocols=**Allow All**
- d. Click **OK**, and click **Commit** to apply the configuration and other pending changes (if any).
4. To use the port on the XPIM, you must also set security policies. Select the following settings:
 - a. Select **Configure>Security>Policy>Apply Policy**.
 - b. Set Policy Action: Default Policy Action=**Permit-All**.
 - c. Click **OK** to save changes, and click **Commit** to apply the configuration and other pending changes (if any).

NOTE: You cannot configure the mode and speed options for the 2-Port 10-Gigabit Ethernet XPIM using the J-Web interface. You must either use the Point and Click CLI or the CLI to configure them.

For advanced configuration information, see the [Junos OS Network Interfaces Configuration Guide](#).

Using the Point and Click CLI to Set Interface Mode and Speed Options

To set the interface mode and speed options for the 2-Port 10-Gigabit Ethernet XPIM with the Point and Click CLI:

1. From the J-Web interface main menu, select **Configure>CLI Tools>CLI Tools>Point and Click CLI**.
2. Next to Interfaces, click **Configure** or **Edit**. The Interfaces page displays.
3. Click the Interface name or click **Edit**. The details page for the specified interface appears.
4. To set the mode for the 2-Port 10-Gigabit Ethernet XPIM, select either **fiber** or **copper** from the Mode drop-down list box.

NOTE: Autonegotiation is not supported when the 2-Port 10-Gigabit Ethernet XPIM is operating in fiber mode at a link speed of 10 Gbps.

5. To set the speed for the 2-Port 10-Gigabit Ethernet XPIM, select **10m**, **100m**, **1g**, or **10g**, from the the Speed drop-down list box.

NOTE: For copper ports, all 10 Mbps, 100 Mbps, 1 G, and 10 G speeds are supported; for fiber ports, only 1 G and 10 G speeds are supported.

- Click **OK** to save changes, and click **Commit** to apply the configuration and other pending changes (if any).

For advanced configuration information, see the [Junos OS Network Interfaces Configuration Guide](#).

Using the CLI

To perform basic configuration for the 2-Port 10-Gigabit Ethernet XPIM and to configure network interfaces for the services gateway with the CLI:

- Verify that the 2-Port 10-Gigabit Ethernet XPIM is installed on the services gateway:

```
show chassis hardware
```

- Verify the FPC status of the interface:

```
show chassis fpc
```

- Assign the port an IP address:

```
set interfaces xe-6/0/0 unit 0 family inet address interface address/destination prefix
```

NOTE: The interface `xe-6/0/0` is the correct configuration if the 2-Port 10-Gigabit Ethernet XPIM is installed in slot 6. If the 2-Port 10-Gigabit Ethernet XPIM is installed in slot 2 (valid only on SRX650 Services Gateway), then the correct interface configuration would be `xe-2/0/0`

- Assign MTU values:

```
set interfaces xe-6/0/0 unit 0 family inet mtu mtu values
```

- Set link options:

```
set interfaces xe-6/0/0 gigger-options802.3ad/auto-negotiation/ loopback
```

- Add or select a security zone; for example, Trust:

```
set security zones security-zone trust interfaces xe-6/0/0.0 host-inbound-traffic system-services all
```

- Add or select security zones for host inbound traffic:

```
set security zones security-zone trust interfaces xe-6/0/0.0 host-inbound-traffic protocols all
```

- Set security policies:

set security policies default-policy permit-all

- Set operating mode, for example, copper:

set interfaces xe-6/0/0 media-type copper

NOTE: Autonegotiation is not supported when the 2-Port 10-Gigabit Ethernet XPIM is operating in fiber mode at a link speed of 10 Gbps.

- Set interface speed, for example, 10 G:

set interfaces xe-6/0/0 speed 10g

NOTE: For copper ports, all 10 Mbps, 100 Mbps, 1 G, and 10 G speeds are supported; for fiber ports, only 1 G and 10 G speeds are supported.

RELATED DOCUMENTATION

[2-Port 10-Gigabit Ethernet XPIM Overview | 83](#)

[2-Port 10-Gigabit Ethernet XPIM Key Features | 87](#)

[2-Port 10 Gigabit Ethernet XPIM Hardware Specifications | 88](#)

[2-Port 10 Gigabit Ethernet XPIM LEDs | 90](#)

[2-Port 10-Gigabit Ethernet XPIM Components | 84](#)

[Installing a Gigabit-Backplane Physical Interface Module on the SRX Series Services Gateway | 253](#)

8-Port Gigabit Ethernet SFP XPIM Basic Configuration

The 8-Port Gigabit Ethernet small form-factor pluggable Gigabit-Backplane Physical Interface Module (SFP XPIM) provides connectivity to a single Gigabit Ethernet device or to a network. After you install the XPIM in the services gateway, you configure a network interface on the XPIM.

NOTE: Only the SRX650 Services Gateway supports hot-swappable functionality for GPIMs. The SRX550 Services Gateway does not support hot-swappable functionality for GPIMs.

To configure a network interface on the 8-Port Gigabit Ethernet SFP XPIM :

1. Verify that the 8-Port Gigabit Ethernet SFP XPIM is installed in the services gateway:

```
user@host >show chassis hardware
```

The following is a sample output of the command. (The output shown is for an SRX550 Services Gateway; other devices give similar output):

```
Hardware inventory:
Item          Version  Part number  Serial number  Description
Chassis                               AL1011AA0013  SRX550
Midplane      REV 02   750-035027  AADB5084
Routing Engine REV 07   711-035026  AADB5153      RE-SRXSME-SRX550
FPC 0
  PIC 0
  PIC
FPC 3          REV 03   750-037551  AAEC8075      FPC
  PIC 0
    Xcvr 0      REV 02   740-013111  B302363       SFP-T
    Xcvr 1      REV 01   740-011612  9XT702501077 SFP-LH
    Xcvr 2      REV 01   740-011612  9XT702501078 SFP-LH
    Xcvr 3      REV 01   740-011612  9XT702501079 SFP-LH
    Xcvr 4      REV 01   740-011612  9XT702501080 SFP-LH
    Xcvr 5      REV 01   740-011620  2850670       SFP-FX
    Xcvr 6      REV 01   740-011782  P8Q21GG       SFP-SX
    Xcvr 7      REV 01   740-020465  5446212       SFP-1000BASE-BX10-D
Power Supply 0 Rev 03   740-024283  VA11443       PS 645W AC
```

The output shows that FPC 3 PIC 0 is the XPIM.

2. Verify that the PIC on the XPIM is online:

user@host> show chassis fpc pic-status

The following sample output shows that FPC 3 PIC 0 is **online**:

```
root@magni02-2a> show chassis fpc pic-status
Slot 0   Online      FPC
  PIC 0   Online      6x GE, 4x GE SFP Base PIC
Slot 3   Online      FPC
  PIC 0   Online      8x GE SFP gPIM
```

3. Verify that the network interface that you want to configure on the XPIM is up:

user@host> show interfaces terse

The following is a sample output for this command:

```
root@magni02-2a> show interfaces terse ge-3/0/*
Interface          Admin Link Proto   Local          Remote
ge-3/0/0           up    up
ge-3/0/1           up    up
ge-3/0/2           up    up
ge-3/0/3           up    up
ge-3/0/4           up    up
ge-3/0/5           up    up
ge-3/0/6           up    up
ge-3/0/7           up    up
```

The following sample output shows extensive details of ge-3/0/0 on the interface:

```
root@magni02-2a> show interfaces ge-3/0/0 extensive | no-more Physical interface:
ge-3/0/0, Enabled, Physical link is Up
Interface index: 150, SNMP ifIndex: 722, Generation: 153
Link-level type: Ethernet, MTU: 1514, Link-mode: Full-duplex, Speed: 1000mbps,

BPDU Error: None, MAC-REWRITE Error: None, Loopback: Disabled,
Source filtering: Disabled, Flow control: Enabled, Auto-negotiation: Enabled,

Remote fault: Online
Device flags   : Present Running
Interface flags: SNMP-Traps Internal: 0x0
Link flags     : None
CoS queues    : 8 supported, 8 maximum usable queues
Hold-times    : Up 0 ms, Down 0 ms
Current address: 00:1f:12:e4:71:54, Hardware address: 00:1f:12:e4:71:54
```

```

Last flapped   : 2012-04-03 00:28:04 PDT (23:49:14 ago)
Statistics last cleared: Never
Traffic statistics:
  Input bytes   :                0                0 bps
  Output bytes  :                0                0 bps
  Input packets :                0                0 pps
  Output packets:                0                0 pps
Input errors:
  Errors: 0, Drops: 0, Framing errors: 0, Runts: 0, Policed discards: 0,
  L3 incompletes: 0, L2 channel errors: 0, L2 mismatch timeouts: 0,
  FIFO errors: 0, Resource errors: 0
Output errors:
  Carrier transitions: 1, Errors: 0, Drops: 0, Collisions: 0, Aged packets:
0,
  FIFO errors: 0, HS link CRC errors: 0, MTU errors: 0, Resource errors: 0
Active alarms   : None
Active defects  : None
MAC statistics:
                                     Receive          Transmit
Total octets           0                0
Total packets          0                0
Unicast packets        0                0
Broadcast packets     0                0
Multicast packets     0                0
CRC/Align errors      0                0
FIFO errors            0                0
MAC control frames    0                0
MAC pause frames      0                0
Oversized frames      0
Jabber frames         0
Fragment frames       0
VLAN tagged frames    0
Code violations        0
Filter statistics:
  Input packet count           0
  Input packet rejects         0
  Input DA rejects             0
  Input SA rejects             0
  Output packet count           0
  Output packet pad count       0
  Output packet error count     0
  CAM destination filters: 1, CAM source filters: 0
Autonegotiation information:
  Negotiation status: Complete
  Link partner:

```

```

Link mode: Full-duplex, Flow control: None, Remote fault: OK,
Link partner Speed: 1000 Mbps
Local resolution:
Flow control: None, Remote fault: Link OK
Packet Forwarding Engine configuration:
Destination slot: 3
CoS information:
Direction : Output
CoS transmit queue          Bandwidth          Buffer Priority
Limit
                                %          bps          %          usec
0 best-effort                95          950000000    95          0          low
none
3 network-control            5           50000000     5           0          low
none
Interface transmit statistics: Disabled

```

4. Assign the interface an IP address:

[edit]

user@host# set interfaces *interface-name* unit 0 family inet address *interface address/destination prefix*

5. Set security policies:

[edit]

user@host# set security policies *policy-name*

RELATED DOCUMENTATION

[8-Port Gigabit Ethernet SFP XPIM Overview | 92](#)

[8-Port Gigabit Ethernet SFP XPIM Hardware Specifications | 95](#)

[8-Port Gigabit Ethernet SFP XPIM Network Interface Specifications | 26](#)

[8-Port Gigabit Ethernet SFP XPIM Supported Modules | 97](#)

[8-Port Gigabit Ethernet SFP XPIM Key Features | 94](#)

[8-Port Gigabit Ethernet SFP XPIM LEDs | 96](#)

[8-Port Gigabit Ethernet SFP XPIM Components | 93](#)

8-Port Serial GPIM Basic Configuration

The 8-Port Serial Gigabit-Backplane Physical Interface Module (GPIM) is a network interface card (NIC) that installs in the front slots of the SRX650 and SRX550 Services Gateways to provide physical connections to a WAN. After you install the GPIM in the services gateway, you configure a network interface on the GPIM.

NOTE: Only the SRX650 Services Gateway supports hot-swappable functionality for GPIMs. The SRX550 Services Gateway does not support hot-swappable functionality for GPIMs.

Before you begin to configure the GPIM:

- Ensure that you have configured security zones on the services gateway.
- Ensure that you have configured security policies on the services gateway.

NOTE: This topic shows a basic configuration that applies a security zone to all protocols and a default policy set. You can also configure specific zone settings and policies on the interface.

To configure the 8-Port Serial GPIM and configure a network interface on the GPIM:

1. Verify that the 8-Port Serial GPIM is installed in the services gateway:

```
user@host > show chassis hardware
```

The following sample output shows that FPC 3 PIC 0 is the GPIM:

```
Hardware inventory:
```

Item	Version	Part number	Serial number	Description
Chassis			AJ2409AA0005	SRX650
Midplane	REV 08	710-023875	AAAB4991	
System IO	REV 08	710-023209	AAAC3710	SRXSME System IO
Routing Engine				RE-SRXSME-SRE6
FPC 0				FPC
PIC 0				4x GE Base PIC
FPC 3	REV 00	750-038290	AADB5216	FPC
PIC 0				8x Sync Serial gPIM
FPC 6	REV 11	750-023872	AAAV8510	FPC
PIC 0				24x GE POE gPIM
Power Supply 1	Rev 02	740-024283	TF00372	PS 645W AC

2. Verify that the PIC on the GPIM is online:

```
user@host> show chassis fpc pic-status
```

The following sample output shows that FPC 3 PIC 0 is **online**:

```
root@srx-650-b# run show chassis fpc pic-status
```

Slot 0	Online	FPC
PIC 0	Online	4x GE Base PIC
Slot 3	Online	FPC
PIC 0	Online	8x Sync Serial gPIM
Slot 6	Online	FPC
PIC 0	Online	24x GE POE gPIM

3. Verify that the serial network interface that you want to configure on the GPIM is up:

```
user@host> show interfaces terse
```

The following sample output shows that the serial network interface you are configuring is up:

```

root@srx-650-a> show interfaces se-4/0/* terse
Interface          Admin Link Proto  Local          Remote
se-4/0/0           up    up
se-4/0/1           up    up
se-4/0/2           up    up
se-4/0/3           up    up
se-4/0/4           up    up
se-4/0/5           up    up
se-4/0/6           up    up
se-4/0/7           up    up

```

The following sample output shows extensive details of **se-4/0/0** on the interface:

```

root@srx-650-a> show interfaces se-4/0/0 extensive Physical interface: se-4/0/0,
Enabled, Physical link is Up
Interface index: 150, SNMP ifIndex: 773, Generation: 177
Type: Serial, Link-level type: PPP, MTU: 1504, Maximum speed: 8mbps
Device flags      : Present Running
Interface flags: Point-To-Point Internal: 0x0
Link flags        : Keepalives
Hold-times        : Up 0 ms, Down 0 ms
CoS queues        : 8 supported, 8 maximum usable queues
Last flapped      : 2012-03-01 11:07:13 PST (10:57:02 ago)
Statistics last cleared: Never
Traffic statistics:
  Input bytes      :                0          0 bps
  Output bytes     :                0          0 bps
  Input packets    :                0          0 pps
  Output packets   :                0          0 pps
Input errors:
  Errors: 3, Drops: 0, Framing errors: 3, Runts: 0, Giants: 0,
  Policed discards: 0, Resource errors: 0
Output errors:
  Carrier transitions: 1, Errors: 0, Drops: 0, MTU errors: 0,
  Resource errors: 0
Serial media information:
  Line protocol: eia530a
  Resync history:
    Sync loss count: 0
  Data signal:
    Rx Clock: OK
  Control signals:
    Local mode: DCE

```

```

    To DTE: CTS: up, DCD: up, DSR: up
    From DTE: DTR: up, RTS: up
    DCE loopback override: Off
    Clocking mode: internal
    Loopback: none
    Tx clock: non-invert
    Line encoding: nrz
    Packet Forwarding Engine configuration:
    Destination slot: 4
    CoS information:
    Direction : Output
    CoS transmit queue          Bandwidth          Buffer Priority
    Limit
                                %          bps          %          usec          low
    0 best-effort                95          7600000      95          0
    none
    3 network-control            5           400000       5           0
    none

```

4. Assign the interface an IP address:

[edit]

```
user@host# set interfacesinterface-nameunit 0 family inet addressinterface address/destination prefix
```

5. Add or select a security zone:

[edit]

```
user@host# set security zones security-zonezone-name interfacesinterface-namehost-inbound-traffic system-services all
```

6. Add or select security zones for host inbound traffic protocol options:

[edit]

```
user@host# set security zones security-zonezone-nameinterfacesinterface-name host-inbound-traffic protocols all
```

7. Set security policies:

[edit]

```
user@host# set security policiespolicy-name
```

RELATED DOCUMENTATION

8-Port Serial GPIM Overview		99
8-Port Serial GPIM Hardware Specifications		102
8-Port Serial GPIM Components		100
8-Port Serial GPIM Key Features		101
8-Port Serial GPIM LEDs		103
8-Port Serial GPIM Interface Cables		157
8-Port Serial GPIM Interface Specifications		27

16-Port Gigabit Ethernet XPIM Basic Configuration

To enable the 16-Port Gigabit Ethernet XPIM installed on your SRX Series Services Gateway, you must configure its properties. You can perform the same configuration tasks using the J-Web interface or the CLI configuration editor. In addition, you can configure a wider variety of options that are encountered less frequently.

24-Port Gigabit Ethernet XPIM Basic Configuration

IN THIS SECTION

- [Using the J-Web Interface](#) | [230](#)
- [Using the CLI](#) | [230](#)

To enable the 24-Port Gigabit Ethernet XPIM installed on your SRX Series Services Gateway, you must configure the basic settings for the PIM. You can perform the configuration tasks for this using either the J-Web interface or the CLI.

NOTE: When installing the 24-Port Gigabit Ethernet XPIM, which uses four slots, you must install it in the 20-Gigabit GPIM slots 2 and 6, which refer to the bottom four slots 1 to 4, or the top four slots 5 to 8.

Using the J-Web Interface

To perform basic configuration for the 24-Port Gigabit Ethernet XPIM and to configure network interfaces for the services gateway using the J-Web interface:

1. In the J-Web interface, select **Configure>Interfaces>Ports**.

The Interfaces page lists the network interfaces present on the services gateway. Verify whether the interface has been configured by reviewing the information in the Configured column (**yes/no**).

2. Select the name of the interface you want to edit.
3. To use the port on the XPIM, you must assign it to a security zone other than the Null zone. Optionally, you can also assign the port an IP address (for example, **192.168.3.1/24**). Enter or select the following settings:
 - a. Select **Configure>Security>Zones**.
 - b. Add or select a security zone other than Null; for example, **Trust**.
 - c. For host inbound traffic, set the following:
 - System Services=**Allow All**
 - Protocols=**Allow All**
 - d. Click **OK**, and click **Commit** to apply the configuration and other pending changes (if any).
4. To use the port on the XPIM, you must also set security policies. Select the following settings:
 - a. Select **Configure>Security>Policy>Apply Policy**.
 - b. Set Policy Action: Default Policy Action=**Permit-All**.
 - c. Click **OK** to save changes, and click **Commit** to apply the configuration and other pending changes (if any).

For advanced configuration information, see the [Junos OS Network Interfaces Configuration Guide](#).

Using the CLI

To perform basic configuration for the 24-Port Gigabit Ethernet XPIM and to configure network interfaces for the services gateway with the CLI:

- Verify that the 24-Port Gigabit Ethernet XPIM is installed on the services gateway:
show chassis hardware
- Verify the FPC status of the interface:
show chassis fpc
- Assign the port an IP address:
set interfaces ge-2/0/0 unit 0 family inet address *interface address/destination prefix*
- Assign MTU values:
set interfaces ge-2/0/0 unit 0 family inet mtu *mtu values*
- Set link options:
set interfaces ge-2/0/0 gigether-options *auto-negotiation*
- Add or select a security zone; for example, Trust:
set security zones security-zone trust interfaces ge-2/0/0.0 host-inbound-traffic system-services all
- Add or select security zones for host inbound traffic:
set security zones security-zone trust interfaces ge-2/0/0.0 host-inbound-traffic protocols all
- Set security policies:
set security policies default-policy permit-all

RELATED DOCUMENTATION

[24-Port Gigabit Ethernet XPIM Overview | 111](#)

[24-Port Gigabit Ethernet XPIM Key Features | 115](#)

[24-Port Gigabit Ethernet XPIM Hardware Specifications | 116](#)

[24-Port Gigabit Ethernet XPIM LEDs | 117](#)

[24-Port Gigabit Ethernet XPIM Components | 112](#)

[Installing a Double-High, Double-Wide Gigabit-Backplane Physical Interface Module on the SRX Series Services Gateway | 256](#)

Dual CT1/E1 GPIM Basic Configuration

IN THIS SECTION

- [Using the J-Web Interface | 232](#)
- [Using the CLI to Configure the CT1 Interface | 233](#)
- [Using the CLI to Configure the CE1 Interface | 234](#)

To enable the Dual CT1/E1 Gigabit-Backplane Physical Interface Module (GPIM) installed on your SRX Series Services Gateway, you must configure the basic settings for the PIM. You can perform the configuration tasks for this using either the J-Web interface or the CLI.

Using the J-Web Interface

To perform basic configuration for the Dual CT1/E1 GPIM and to configure network interfaces for the services gateway using the J-Web interface:

1. In the J-Web interface, select **Configure>Interfaces>Ports**.

The Interfaces page lists the network interfaces present on the services gateway. Verify whether the interface has been configured by reviewing the information in the Configured column (**yes/no**).

2. Select the name of the parent interface you want to edit.

NOTE: You must configure the parent CT1 or CE1 interface before you configure the child T1 or E1 interface, respectively.

3. From the CT1/CE1 Interfaces General Configuration page, for the parent CT1 or CE1 interface, select **no** for the Partitioning field.
4. Click **OK** to save changes.
5. Select the name of the child interface (T1 or E1) you want to edit.

6. To use the port on the GPIM, you must assign it to a security zone other than the Null zone. Optionally, you can also assign the port an IP address (for example, 192.168.3.1/24). Enter or select the following settings:
 - a. Select **Configure>Security>Zones**.
 - b. Add or select a security zone other than Null; for example, **Trust**.
 - c. For host inbound traffic, set the following:
 - System Services=**Allow All**
 - Protocols=**Allow All**
 - d. Click **OK** to save changes, and click **Commit** to apply the configuration and other pending changes (if any).
7. To use the port on the GPIM, you must also set security policies. Select the following settings:
 - a. Select **Configure>Security>Policy>Apply Policy**.
 - b. Set Policy Action: Default Policy Action=**Permit-All**.
 - c. Click **OK** to save changes, and click **Commit** to apply the configuration and other pending changes (if any).

For advanced configuration information, see the [Junos OS Network Interfaces Configuration Guide](#).

Using the CLI to Configure the CT1 Interface

To perform basic configuration for the Dual CT1/E1 GPIM (for the CT1 interface) and to configure network interfaces for the services gateway with the CLI:

NOTE: You must configure the parent CT1 interface before you can configure the child T1 interface.

- Verify that the Dual CT1/E1 GPIM is installed on the services gateway:
show chassis hardware
- Verify the FPC status of the interface:
show chassis fpc
- Configure the parent CT1 interface with no partitioning:

set interfaces ct1-3/0/0 no-partition interface-type t1

- Configure the child T1 interface and assign an IP address:

set interfaces t1-3/0/0 unit 0 family inet address *ip4-address/prefix*

- Assign MTU values to the child T1 interface:

set interfaces t1-3/0/0 unit 0 mtu *mtu values*

- Configure a security zone for the child T1 interface and set the configuration for host inbound traffic services and protocols:

set security zones security-zone trust interfaces t1-3/0/0 host-inbound-traffic system-services all

set security zones security-zone trust interfaces t1-3/0/0 host-inbound-traffic protocols all

- Set security policies:

set security policies default-policy permit-all

Using the CLI to Configure the CE1 Interface

To perform basic configuration for the Dual CT1/E1 GPIM (for the CE1 interface) and to configure network interfaces for the services gateway with the CLI:

NOTE: You must configure the parent CE 1 interface before you can configure the child E1 interface.

- Verify that the Dual CT1/E1 GPIM is installed on the services gateway:

show chassis hardware

- Verify the FPC status of the interface:

show chassis fpc

- Configure the parent CE1 interface with no partitioning:

set interfaces ce1-3/0/0 no-partition interface-type e1

- Configure the child E1 interface and assign an IP address:

set interfaces e1-3/0/0 unit 0 family inet address *ip4-address/prefix*

- Assign MTU values to the child E1 interface:

set interfaces e1-3/0/0 unit 0 mtu *mtu values*

- Configure a security zone for the child E1 interface and set the configuration for host inbound traffic services and protocols:

set security zones security-zone trust interfaces e1-3/0/0 host-inbound-traffic system-services all

```
set security zones security-zone trust interfaces e1-3/0/0 host-inbound-traffic protocols all
```

- Set security policies:

```
set security policies default-policy permit-all
```

Quad CT1/E1 GPIM Basic Configuration

IN THIS SECTION

- [Using the J-Web Interface | 235](#)
- [Using the CLI to Configure the CT1 Interface | 236](#)
- [Using the CLI to Configure the CE1 Interface | 237](#)

To enable the Quad CT1/E1 Gigabit-Backplane Physical Interface Module (GPIM) installed on the SRX Series Services Gateway, you must configure the basic settings for the PIM. You can perform the configuration tasks for this using either the J-Web interface or the CLI.

Using the J-Web Interface

To perform basic configuration for the Quad CT1/E1 GPIM and to configure network interfaces for the services gateway using the J-Web interface:

1. In the J-Web interface, select **Configure>Interfaces>Ports**.

The Interfaces page lists the network interfaces present on the services gateway. Verify whether the interface has been configured by reviewing the information in the Configured column (**yes/no**).

2. Select the name of the parent interface you want to edit.

NOTE: You must configure the parent CT 1 or CE1 interface before you configure the child T1 or E1 interface, respectively.

3. From the CT1/CE1 Interfaces General Configuration page, for the parent CT1 or CE1 interface, select **No** for the Partitioning field.

4. Click **OK** to save changes.
5. Select the name of the child interface (T1 or E1) you want to edit.
6. To use the port on the GPIM, you must assign it to a security zone other than the Null zone. Optionally, you can also assign the port an IP address (for example, **192.168.3.1/24**). Enter or select the following settings:
 - a. Select **Configure>Security>Zones**.
 - b. Add or select a security zone other than Null; for example, **Trust**.
 - c. For host inbound traffic, set the following:
 - System Services=**Allow All**
 - Protocols=**Allow All**
 - d. Click **OK**, and click **Commit** to apply the configuration and other pending changes (if any).
7. To use the port on the GPIM, you must also set security policies. Select the following settings:
 - a. Select **Configure>Security>Policy>FW Policies**.
 - b. Set Policy Action: Default Policy Action=**Permit-All**.
 - c. Click **OK** to save changes, and click **Commit** to apply the configuration and other pending changes (if any).

For advanced configuration information, see the [Junos OS Network Interfaces Configuration Guide](#).

Using the CLI to Configure the CT1 Interface

To perform basic configuration for the Quad CT1/E1 GPIM (for the CT1 interface) and to configure network interfaces for the services gateway with the CLI:

NOTE: You must configure the parent CT1 interface before you can configure the child T1 interface.

- Verify that the Quad CT1/E1 GPIM is installed on the services gateway:
show chassis hardware
- Verify the FPC status of the interface:

show chassis fpc

- Configure the parent CT1 interface with no partitioning:

set interfaces ct1-1/0/0 no-partition interface-type t1

- Configure the child T1 interface and assign an IP address:

set interfaces t1-1/0/0 unit 0 family inet address ip4-address/prefix

- Assign MTU values to the child T1 interface:

set interfaces t1-1/0/0 unit 0 mtu mtu values

- Configure a security zone for the child T1 interface and set the configuration for host inbound traffic services and protocols:

set security zones security-zone trust interfaces t1-1/0/0 host-inbound-traffic system-services all

set security zones security-zone trust interfaces t1-1/0/0 host-inbound-traffic protocols all

- Set security policies:

set security policies default-policy permit-all

Using the CLI to Configure the CE1 Interface

To perform basic configuration for the Quad CT1/E1 GPIM (for the CE1 interface) and to configure network interfaces for the services gateway with the CLI:

NOTE: You must configure the parent CE1 interface before you can configure the child E1 interface.

- Verify that the Quad CT1/E1 GPIM is installed on the services gateway:

show chassis hardware

- Verify the FPC status of the interface:

show chassis fpc

- Configure the parent CE1 interface with no partitioning:

set interfaces ce1-1/0/0 no-partition interface-type e1

- Configure the child E1 interface and assign an IP address:

set interfaces e1-1/0/0 unit 0 family inet address ip4-address/prefix

- Assign MTU values to the child E1 interface:

set interfaces e1-1/0/0 unit 0 mtu mtu values

- Configure a security zone for the child E1 interface and set the configuration for host inbound traffic services and protocols:

```
set security zones security-zone trust interfaces e1-1/0/0 host-inbound-traffic system-services all
```

```
set security zones security-zone trust interfaces e1-1/0/0 host-inbound-traffic protocols all
```

- Set security policies:

```
set security policies default-policy permit-all
```

Mini-Physical Interface Module and Gigabit-Backplane Physical Interface Module Operating Modes and Supported Modules

IN THIS CHAPTER

- [1-Port G.SHDSL 8-Wire Mini-Physical Interface Module Operating Modes | 239](#)

1-Port G.SHDSL 8-Wire Mini-Physical Interface Module Operating Modes

The 1-Port G.SHDSL 8-Wire Mini-Physical Interface Module (Mini-PIM) can be configured to operate in the following modes:

- 4X2-wire (4-port 2-wire)
- 2X4-wire (2-port 4-wire)
- 1X8-wire (1-port 8-wire)

NOTE: The 4-wire mode is the default operating mode for the 1-Port G.SHDSL 8-Wire Mini-PIM.

The 1-Port G.SHDSL 8-Wire Mini-PIM can operate in any of the following annexes:

- Annex A
- Annex B
- Annex F
- Annex G

NOTE: All the annexes supported on the 1-Port G.SHDSL 8-Wire Mini-PIM can operate in 2-wire, 4-wire, and 8-wire modes.

Table 102 on page 240 lists the 1-Port G.SHDSL 8-Wire Mini-PIM data rates for the different operating modes.

Table 102: 1-Port G.SHDSL 8-Wire Mini-PIM Data Rates

Annexes	Operating Modes	Data Rates (Mbps)
Annex A and Annex B	2-wire (4 port 2-wire)	2.3 (maximum)
	4-wire (2 port 4-wire)	4.6 (maximum)
	8-wire (1 port 8-wire)	9.2 (maximum)
Annex F and Annex G	2-wire (4 port 2-wire)	0.768 to 5.696
	4-wire (2 port 4-wire)	1.536 to 11.392
	8-wire (1 port 8-wire)	3.072 to 22.784

RELATED DOCUMENTATION

[1-Port G.SHDSL 8-Wire Mini-Physical Interface Module Overview | 57](#)

[1-Port G.SHDSL 8-Wire Mini-Physical Interface Module Supported Standards | 61](#)

[1-Port G.SHDSL 8-Wire Mini-Physical Interface Module Key Features | 58](#)

[1-Port G.SHDSL 8-Wire Mini-Physical Interface Module Hardware Specifications | 59](#)

[1-Port G.SHDSL 8-Wire Mini-Physical Interface Module LEDs | 60](#)

5

PART

Replacing Interface Modules

[Overview of Replacing Interface Modules | 242](#)

[Replacing Mini-Physical Interface Modules | 246](#)

[Replacing Gigabit-Backplane Physical Interface Modules | 252](#)

[Contacting Customer Support and Returning Components | 261](#)

Overview of Replacing Interface Modules

IN THIS CHAPTER

- [Required Tools and Parts for Replacing a Mini-Physical Interface Module | 242](#)
- [Required Tools and Parts for Replacing a Gigabit-Backplane Physical Interface Module | 243](#)
- [Preventing Electrostatic Discharge Damage to the SRX Series Services Gateway | 244](#)

Required Tools and Parts for Replacing a Mini-Physical Interface Module

The following tools and parts are required for replacing Mini-Physical Interface Modules (Mini-PIMs) on the SRX Series Services Gateway:

- Electrostatic bag or antistatic mat, for each component
- Electrostatic discharge (ESD) grounding wrist strap
- Flat blade (-) screwdriver, approximately 1/8 in. (3 mm)
- Phillips (+) screwdrivers, number 1

RELATED DOCUMENTATION

[Removing a Blank Mini-Physical Interface Module Faceplate from the SRX Series Services Gateway | 246](#)

[Installing a Mini-Physical Interface Module in the SRX Series Services Gateway | 247](#)

[Removing a Mini-Physical Interface Module from the SRX Series Services Gateway | 249](#)

[SRX Series Services Gateway Mini-Physical Interface Modules Overview | 6](#)

Required Tools and Parts for Replacing a Gigabit-Backplane Physical Interface Module

The following tools and parts are required for replacing a Gigabit-Backplane Physical Interface Module (GPIM) on the SRX Series Services Gateway:

- Electrostatic bag or antistatic mat, for each component
- Electrostatic discharge (ESD) grounding wrist strap
- Flat-blade (-) screwdriver, approximately 1/8 in. (3 mm)
- Phillips (+) screwdrivers, numbers 1 and 2
- Blank panels (if no component is installed)

RELATED DOCUMENTATION

[Removing a Blank Gigabit-Backplane Physical Interface Module Faceplate from the SRX Series Services Gateway | 253](#)

[Installing a Gigabit-Backplane Physical Interface Module on the SRX Series Services Gateway | 253](#)

[Installing a Double-High, Double-Wide Gigabit-Backplane Physical Interface Module on the SRX Series Services Gateway | 256](#)

[Removing a Gigabit-Backplane Physical Interface Module from the SRX Series Services Gateway | 258](#)

Preventing Electrostatic Discharge Damage to the SRX Series Services Gateway

Many services gateway hardware components are sensitive to damage from static electricity. Some components can be impaired by voltages as low as 30 V. You can easily generate potentially damaging static voltages whenever you handle plastic or foam packing material or if you move components across plastic or carpets. Observe the following guidelines to minimize the potential for electrostatic discharge (ESD) damage, which can cause intermittent or complete component failures:

- Always use an ESD wrist strap or ankle strap, and verify that it is in direct contact with your skin.



CAUTION: For safety, periodically check the resistance value of the ESD strap. The measurement must be in the range of 1 to 10 Mohms.

- When handling any component that is removed from the chassis, verify that the equipment end of your ESD strap is attached to one of the ESD points on the chassis.
- Avoid contact between the component and your clothing. ESD voltages emitted from clothing can damage components.
- When removing or installing a component, always place it component-side up on an antistatic surface, in an antistatic card rack, or in an electrostatic bag. See [Figure 40 on page 244](#). If you are returning a component, place it into an electrostatic bag before packing it.

Figure 40: Placing a Component into an Electrostatic Bag

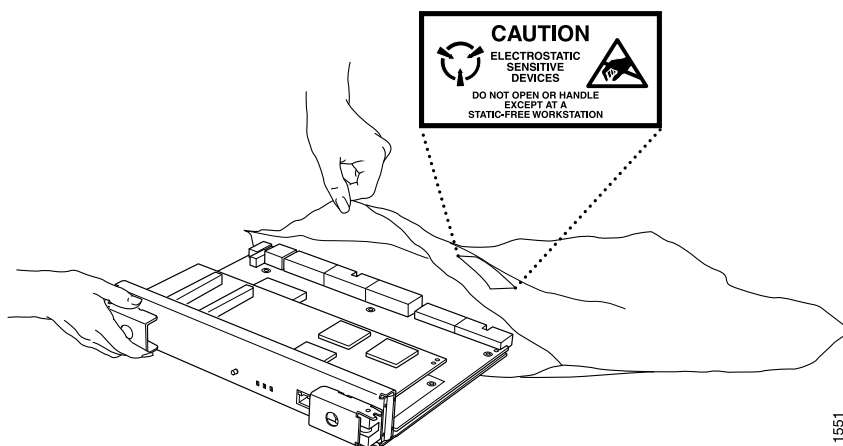

RELATED DOCUMENTATION

Installing a Gigabit-Backplane Physical Interface Module on the SRX Series Services Gateway | 253

Removing a Gigabit-Backplane Physical Interface Module from the SRX Series Services Gateway | 258

Replacing Mini-Physical Interface Modules

IN THIS CHAPTER

- Removing a Blank Mini-Physical Interface Module Faceplate from the SRX Series Services Gateway | 246
- Installing a Mini-Physical Interface Module in the SRX Series Services Gateway | 247
- Removing a Mini-Physical Interface Module from the SRX Series Services Gateway | 249

Removing a Blank Mini-Physical Interface Module Faceplate from the SRX Series Services Gateway

Before you begin, power-off the services gateway.



CAUTION: The Mini-PIMs available on the SRX Series Services Gateway are not hot-swappable. You must power off the services gateway before removing or installing Mini-PIMs.

To maintain proper airflow through the services gateway, cover any empty Mini-Physical Interface Module (Mini-PIM) slot with a blank faceplate.



CAUTION: Do not remove a blank faceplate unless you are installing a mini-pim in the empty slot.

To remove a blank faceplate from the SRX Series Services Gateway:

1. Attach an electrostatic discharge (ESD) grounding strap to your bare wrist, and connect the strap to the ESD point on the services gateway.
2. If the device is powered on, power off the device. Verify that the Power LED is off.
3. Loosen the screws on each side of the faceplate.

- On faceplates with handles, use a 1/8-in. (3-mm) flat-blade (-) screwdriver to loosen but not remove the captive screws.
 - On faceplates without handles, use a Phillips number 1 screwdriver to remove the noncaptive screws.
4. Remove the faceplate. See [Figure 41 on page 247](#).

Figure 41: Removing a Blank Mini-PIM Faceplate from an SRX Series Services Gateway

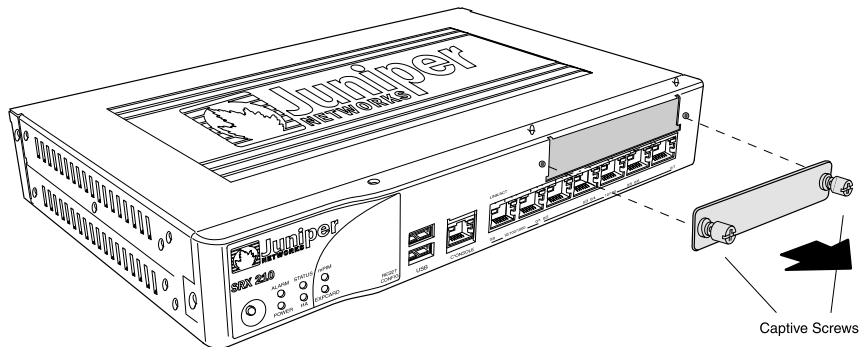

RELATED DOCUMENTATION

[Required Tools and Parts for Replacing a Mini-Physical Interface Module | 242](#)

[Installing a Mini-Physical Interface Module in the SRX Series Services Gateway | 247](#)

[Removing a Mini-Physical Interface Module from the SRX Series Services Gateway | 249](#)

[SRX Series Services Gateway Mini-Physical Interface Modules Overview | 6](#)

Installing a Mini-Physical Interface Module in the SRX Series Services Gateway

Before you begin, power off the services gateway.



CAUTION: The Mini-PIMs available on the SRX Series Services Gateway are not hot-swappable. You must power off the services gateway before removing or installing Mini-PIMs.

To install a Mini-Physical Interface Module (Mini-PIM) in the SRX Series Services Gateway:

1. Attach an electrostatic discharge (ESD) grounding strap to your bare wrist, and connect the strap to the grounding point on the back of the services gateway.
2. Power off the services gateway by briefly pressing the Power button on the front panel. Wait for the Power LED to turn off before proceeding.
3. Disconnect the services gateway from its power source:
 - For SRX210 or SRX220 Services Gateway, either unplug the power adapter from the AC power outlet, or disconnect the power adapter from the power connector on the rear panel of the device.
 - For SRX240 Services Gateway, either unplug the AC power cord from the AC power outlet, or disconnect the AC power cord from the AC power connector on the rear panel of the device.
4. Remove the Mini-PIM from the electrostatic bag.
5. Grasp the screws on each side of the Mini-PIM faceplate and align the notches in the connector at the rear of the Mini-PIM with the notches in the Mini-PIM slot in the device.



CAUTION: Slide the Mini-PIM straight into the slot to avoid damaging the components on the Mini-PIM.

6. Slide the Mini-PIM in until it lodges firmly in the services gateway. See [Figure 42 on page 248](#).

Figure 42: Installing a Mini-PIM in an SRX Series Services Gateway

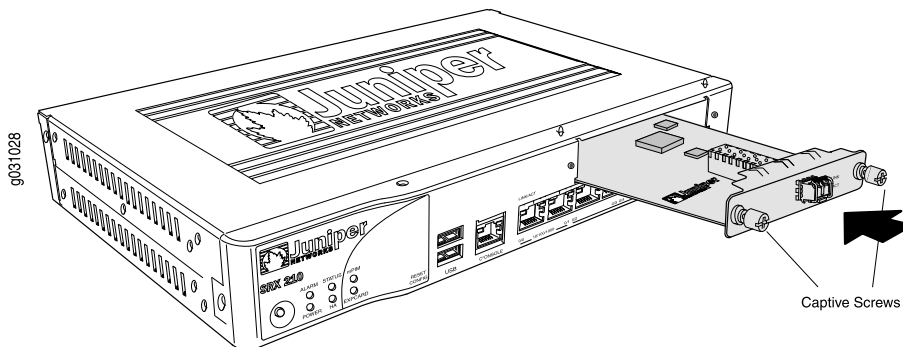

7. Using a 1/8-in. (3-mm) flat-blade (-) screwdriver, tighten the screws on each side of the Mini-PIM faceplate.
8. Insert the appropriate cables into the cable connectors on the Mini-PIM.

9. If necessary, arrange the cables to prevent them from dislodging or developing stress points:
 - Secure the cables so that they are not supporting their own weight as they hang to the floor.
 - Place any excess cables out of the way in neatly coiled loops.
 - Use fasteners to maintain the shape of the cable loops.
10. Reconnect the power adapter to the services gateway. Verify that the Power LED glows steadily green after you press the power button.
11. Verify that the Mini-PIM LED on the system dashboard glows steadily green to confirm that the Mini-PIM is online.

RELATED DOCUMENTATION

[Required Tools and Parts for Replacing a Mini-Physical Interface Module | 242](#)

[Removing a Mini-Physical Interface Module from the SRX Series Services Gateway | 249](#)

[Removing a Blank Mini-Physical Interface Module Faceplate from the SRX Series Services Gateway | 246](#)

[SRX Series Services Gateway Mini-Physical Interface Modules Overview | 6](#)

Removing a Mini-Physical Interface Module from the SRX Series Services Gateway

Before you begin, power off the services gateway.



CAUTION: The Mini-PIMs available on the SRX Series Services Gateway are not hot-swappable. You must power off the services gateway before removing or installing Mini-PIMs.

To remove a Mini-PIM from the SRX Series Services Gateway:

1. Place an electrostatic bag or antistatic mat on a flat, stable surface on which you intend to place the Mini-PIM.
2. Attach an ESD grounding strap to your bare wrist, and connect the strap to the grounding point on the back of the device.
3. Unplug the power adapter from the services gateway. Verify that the Power LED is off.

4. Label the cables connected to the Mini-PIM so that you can later reconnect each cable to the correct Mini-PIM.
5. Disconnect the cables from the Mini-PIM.
6. If necessary, arrange the cables to prevent them from dislodging or developing stress points.
7. Remove the screws on each side of the Mini-PIM faceplate using a 1/8-in. (3-mm) flat-blade (-) screwdriver.
8. Grasp the screws on each side of the Mini-PIM faceplate and slide the Mini-PIM out of the services gateway. See [Figure 43 on page 250](#).

Figure 43: Removing a Mini-PIM from the SRX Series Services Gateway

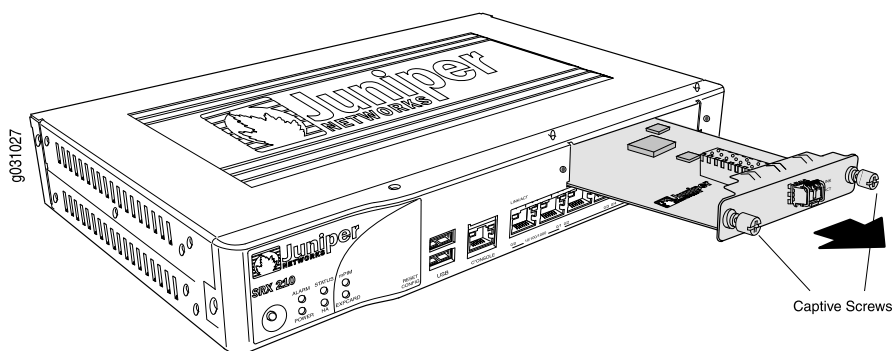

9. Place the Mini-PIM in the electrostatic bag or on the antistatic mat.
10. If you are not reinstalling a Mini-PIM into the empty slot, install a blank faceplate over the slot to maintain proper airflow.

NOTE: When installing a blank Mini-PIM faceplate, make sure that the padded side of the faceplate is facing up.

RELATED DOCUMENTATION

[Required Tools and Parts for Replacing a Mini-Physical Interface Module | 242](#)

[Removing a Blank Mini-Physical Interface Module Faceplate from the SRX Series Services Gateway | 246](#)

Installing a Mini-Physical Interface Module in the SRX Series Services Gateway | 247

SRX Series Services Gateway Mini-Physical Interface Modules Overview | 6

Replacing Gigabit-Backplane Physical Interface Modules

IN THIS CHAPTER

- [Installing a Blank Gigabit-Backplane Physical Interface Module Faceplate on the SRX Series Services Gateway | 252](#)
- [Removing a Blank Gigabit-Backplane Physical Interface Module Faceplate from the SRX Series Services Gateway | 253](#)
- [Installing a Gigabit-Backplane Physical Interface Module on the SRX Series Services Gateway | 253](#)
- [Installing a Double-High, Double-Wide Gigabit-Backplane Physical Interface Module on the SRX Series Services Gateway | 256](#)
- [Removing a Gigabit-Backplane Physical Interface Module from the SRX Series Services Gateway | 258](#)

Installing a Blank Gigabit-Backplane Physical Interface Module Faceplate on the SRX Series Services Gateway

To maintain proper airflow through the services gateway, install blank faceplates in slots that do not contain Gigabit-Backplane Physical Interface Modules (GPIMs).

To install a blank faceplate:

1. Align the captive screws on the blank faceplate with the screw holes on the chassis.
2. Using a Phillips (+) screwdriver, tighten the captive screws on each side of the blank faceplate until the faceplate is flush with the chassis.

RELATED DOCUMENTATION

[Removing a Blank Gigabit-Backplane Physical Interface Module Faceplate from the SRX Series Services Gateway | 253](#)

Removing a Blank Gigabit-Backplane Physical Interface Module Faceplate from the SRX Series Services Gateway

To maintain proper airflow through the services gateway, leave blank faceplates in place over slots that do not contain Gigabit-Backplane Physical Interface Modules (GPIMs). Do not remove a blank faceplate unless you are immediately installing a GPIM in the empty slot.

To remove a blank faceplate:

1. Using a Phillips (+) screwdriver, loosen the captive screws on each side of the blank faceplate.
2. Using a flat-blade (-) screwdriver, gently pry out one side of the faceplate and pull it off.

NOTE: When installing a blank GPIM faceplate, make sure that the padded side of the faceplate is facing up.

RELATED DOCUMENTATION

[Installing a Gigabit-Backplane Physical Interface Module on the SRX Series Services Gateway | 253](#)

[Installing a Double-High, Double-Wide Gigabit-Backplane Physical Interface Module on the SRX Series Services Gateway | 256](#)

[Removing a Gigabit-Backplane Physical Interface Module from the SRX Series Services Gateway | 258](#)

[Required Tools and Parts for Replacing a Gigabit-Backplane Physical Interface Module | 243](#)

Installing a Gigabit-Backplane Physical Interface Module on the SRX Series Services Gateway

Before you begin:

- Ensure that the services gateway is powered off.

NOTE: This step is applicable only for the SRX550 Services Gateway as it does not support hot-swappable functionality for GPIMs. The SRX650 Services Gateway supports hot-swappable functionality for GPIMs.

- Ensure that the GPIM is installed in the appropriate GPIM slot. For information about the appropriate GPIM slots, see [“SRX Series Services Gateway Gigabit-Backplane Physical Interface Modules Overview” on page 8](#).

NOTE: To maintain proper airflow through the services gateway, leave blank faceplates in place over slots that do not contain GPIMs. Do not remove a blank faceplate unless you are immediately installing a GPIM in the empty slot. For more information about removing a blank faceplate, see [“Removing a Blank Gigabit-Backplane Physical Interface Module Faceplate from the SRX Series Services Gateway” on page 253](#).

NOTE: Installing a GPIM on the SRX550 Services Gateway is similar to installing a GPIM on the SRX650 Services Gateway.

To install a GPIM:

1. Attach an electrostatic discharge (ESD) grounding strap to your bare wrist, and connect the strap to one of the ESD points on the chassis. For more information about ESD, see [“Preventing Electrostatic Discharge Damage to the SRX Series Services Gateway” on page 244](#).
2. Grasp the handles on each side of the GPIM faceplate, and align the edges of the GPIM circuit board with the guide rails at each side of the GPIM slot.

NOTE: If you are installing a double-high, double-wide GPIM such as the 24-Port Ethernet XPIM, you must remove the center GPIM slot bracket.

3. Slide the GPIM into the services gateway until it seats firmly in the device. See [Figure 44 on page 255](#) for information.



CAUTION: Slide the GPIM straight into the slot to avoid damaging the components on the GPIM.

Figure 44: Installing a Single-High, Single-Wide GPIM in an SRX650 Services Gateway

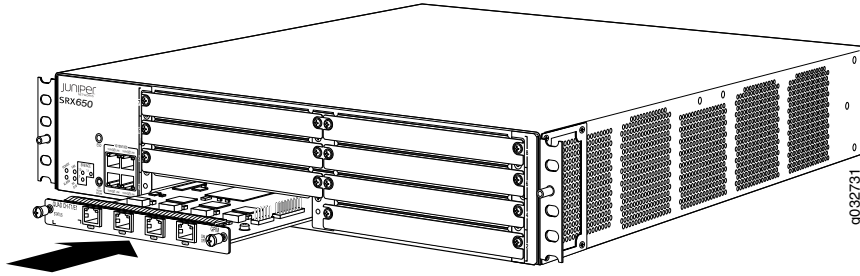

4. Using a Phillips (+) screwdriver, tighten the captive screws on each side of the GPIM faceplate.
5. Insert the appropriate cables into the cable connectors on the GPIM.
6. If necessary, arrange the cables to prevent them from dislodging or developing stress points:
 - Secure the cable so that it is not supporting its own weight as it hangs to the floor.
 - Place excess cable out of the way in a neatly coiled loop.
 - Use fasteners to maintain the shape of the cable loops.

After the STATUS LED light turns green and glows steadily on, the GPIM is online and functioning normally. See [Figure 45 on page 255](#) and [Table 103 on page 255](#) for hot-swappable components and their descriptions.

Figure 45: GPIM Example with Hot-Swappable Components

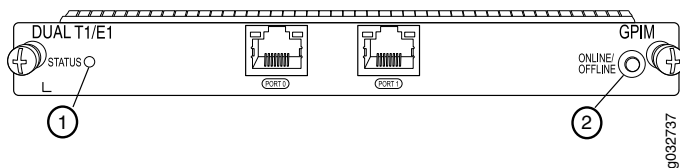

Table 103: Hot-Swappable Component Descriptions for GPIMs

Number	Component	Description
1	STATUS LED	<p>The STATUS LED has the following indicator colors:</p> <ul style="list-style-type: none"> • Green and steadily on indicates that the GPIM is functioning normally. • Yellow and steadily on indicates that the GPIM is starting up, running diagnostics, or going offline. • Red and steadily on indicates that the GPIM has failed. • Off indicates that the GPIM is not powered on, is offline, or is not configured.

Table 103: Hot-Swappable Component Descriptions for GPIMs (continued)

Number	Component	Description
2	ONLINE/OFFLINE button	NOTE: You need not press this button when installing a GPIM. The services gateway automatically recognizes when a GPIM has been inserted into its slots.

RELATED DOCUMENTATION

[Removing a Gigabit-Backplane Physical Interface Module from the SRX Series Services Gateway | 258](#)

[Required Tools and Parts for Replacing a Gigabit-Backplane Physical Interface Module | 243](#)

Installing a Double-High, Double-Wide Gigabit-Backplane Physical Interface Module on the SRX Series Services Gateway

Before you begin:

- Ensure that the services gateway is powered off.

NOTE: This step is applicable only for the SRX550 Services Gateway as it does not support hot-swappable functionality for GPIMs. The SRX650 Services Gateway supports hot-swappable functionality for GPIMs.

- Ensure that the GPIM is installed in the appropriate GPIM slot. For information about the appropriate GPIM slots, see “[SRX Series Services Gateway Gigabit-Backplane Physical Interface Modules Overview](#)” on page 8.

The SRX550 and SRX650 Services Gateway chassis can hold interface modules that use four standard Gigabit-Backplane Physical Interface Module (GPIM) slots each. These GPIMs must be installed in specific groups of four standard slots as shown in [Table 104 on page 257](#).

NOTE: Installing a GPIM on the SRX550 Services Gateway is similar to installing a GPIM on the SRX650 Services Gateway.

Table 104: Slot Groups for Double-High, Double-Wide GPIMs

Device	Slot Groups for Double-High, Double-Wide GPIMs
SRX550	Top four standard slots (slots 5, 6, 7, and 8)
SRX650	Bottom four standard slots (slots 1, 2, 3, and 4) and top four standard slots (slots 5, 6, 7, and 8)

Before installing the double-high, double-wide GPIM, you must first remove the center GPIM guide-rail bracket:

1. Remove the four blank GPIM slot covers from the slots into which you will install the double-high, double-wide GPIM. [“Removing a Blank Gigabit-Backplane Physical Interface Module Faceplate from the SRX Series Services Gateway” on page 253](#)
2. Using a number 2 Phillips (+) screwdriver, remove the screw from the center GPIM guide-rail bracket, as shown in [Figure 46 on page 257](#), and remove the guide-rail bracket.
3. Store the guide-rail bracket for later use. The guide-rail bracket can be stored on the rack-mount bracket, as shown in [Figure 46 on page 257](#).

Figure 46: GPIM Slot Bracket

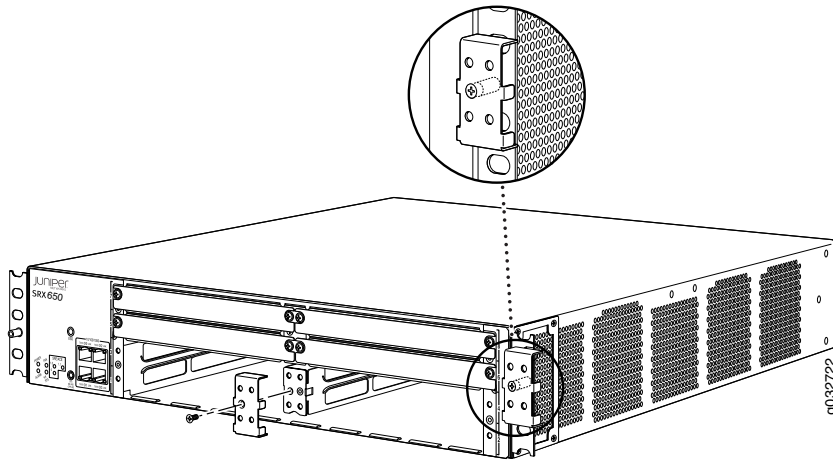

4. To continue with the GPIM installation, see [“Installing a Gigabit-Backplane Physical Interface Module on the SRX Series Services Gateway” on page 253](#).



CAUTION: If you remove a double-high, double-wide GPIM, replace the bracket before you install blank faceplates or other GPIMs. This is necessary for maintaining radio frequency compliance.

RELATED DOCUMENTATION

[Removing a Blank Gigabit-Backplane Physical Interface Module Faceplate from the SRX Series Services Gateway | 253](#)

[Installing a Gigabit-Backplane Physical Interface Module on the SRX Series Services Gateway | 253](#)

[Removing a Gigabit-Backplane Physical Interface Module from the SRX Series Services Gateway | 258](#)

[Required Tools and Parts for Replacing a Gigabit-Backplane Physical Interface Module | 243](#)

Removing a Gigabit-Backplane Physical Interface Module from the SRX Series Services Gateway



CAUTION: This step is applicable only for the SRX550 Services Gateway as it does not support hot-swappable functionality for GPIMs. The SRX650 Services Gateway supports hot-swappable functionality for GPIMs.

To remove a GPIM from the SRX Series Services Gateway:

NOTE: This procedure is applicable for the following GPIMs:

- Single-high, single-wide GPIMs
- Double-high, single-wide GPIMs
- Double-high, double-wide GPIMs

1. Attach an electrostatic discharge (ESD) grounding strap to your bare wrist, and connect the strap to one of the ESD points on the chassis. For more information about ESD, see [“Preventing Electrostatic Discharge Damage to the SRX Series Services Gateway”](#) on page 244.
2. Push the OFFLINE button to turn the GPIM offline. After the STATUS LED light turns off, it is safe to remove the GPIM. See [Figure 47](#) on page 259 and [Table 105](#) on page 259 for a description of LED indications for hot-swappable GPIM components.

Figure 47: GPIM Example with Hot-Swappable Components

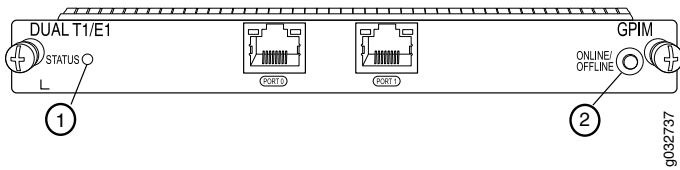

Table 105: LED Indications for Hot-Swappable GPIM Components

Number	Component	Description
1	STATUS LED	<p>The STATUS LED has the following indicator colors:</p> <ul style="list-style-type: none"> • Green and steadily on indicates that the GPIM is functioning normally. • Yellow and steadily on indicates that the GPIM is starting up, running diagnostics, or going offline. • Red and steadily on indicates that the GPIM has failed. • Off indicates that the GPIM is not powered on, is offline, or is not configured.
2	ONLINE/OFFLINE button	Push button to turn the GPIM offline. After the STATUS LED light goes off, it is safe to remove the GPIM from the services gateway.

3. Label the cables connected to the GPIM so that you can later reconnect each cable to the correct GPIM.
4. Disconnect the cables from the GPIM.
5. If necessary, arrange the cables to prevent them from dislodging or developing stress points.

NOTE: If you are removing a double-high, double-wide GPIM such as the 24-Port Ethernet XPIM, you must reinstall the center GPIM slot bracket.

6. Using a Phillips (+) screwdriver, loosen the captive screws on each side of the GPIM faceplate.
7. Grasp the handles on each side of the GPIM faceplate, and slide the GPIM out of the services gateway.
8. Place the GPIM in an electrostatic bag or on an antistatic mat.
9. If you are not reinstalling a GPIM into an empty slot, install a blank GPIM faceplate over the empty slot to maintain proper airflow. If you are reinstalling another GPIM into the empty slot, see [“Installing a Gigabit-Backplane Physical Interface Module on the SRX Series Services Gateway”](#) on page 253.

NOTE: When installing a blank GPIM faceplate, make sure that the padded side of the faceplate is facing up.

RELATED DOCUMENTATION

[Removing a Blank Gigabit-Backplane Physical Interface Module Faceplate from the SRX Series Services Gateway | 253](#)

[Installing a Gigabit-Backplane Physical Interface Module on the SRX Series Services Gateway | 253](#)

[Required Tools and Parts for Replacing a Gigabit-Backplane Physical Interface Module | 243](#)

Contacting Customer Support and Returning Components

IN THIS CHAPTER

- Contacting Customer Support | 261
- Return Procedure for SRX Series Services Gateway Hardware Components | 262
- Locating the SRX Series Services Gateway Hardware Component Mini-PIM or GPIM Serial Number Label | 263
- Information You Might Need to Supply to JTAC | 263
- Required Tools and Parts for Packing the SRX Series Services Gateway Hardware Components | 264
- Packing the SRX Series Services Gateway Hardware Components for Shipment | 264

Contacting Customer Support

Once you have located the serial numbers of the services gateway or component, you can return them for repair or replacement. For this, you need to contact Juniper Networks Technical Assistance Center (JTAC).

You can contact JTAC 24 hours a day, 7 days a week, using any of the following methods:

- On the Web: Using the Service Request Manager link at <https://support.juniper.net/support/>
- By telephone:
 - From the US and Canada: 1-888-314-JTAC
 - From all other locations: 1-408-745-9500

NOTE: If contacting JTAC by telephone, enter your 12-digit service request number followed by the pound (#) key if this is an existing case, or press the star (*) key to be routed to the next available support engineer.

RELATED DOCUMENTATION

Return Procedure for SRX Series Services Gateway Hardware Components

Locating the SRX Series Services Gateway Hardware Component Mini-PIM or GPIM Serial Number Label

[Information You Might Need to Supply to JTAC | 263](#)

Packing the SRX Series Services Gateway Hardware Components for Shipment

Return Procedure for SRX Series Services Gateway Hardware Components

Follow the tasks list provided in [Table 106 on page 262](#) to return an SRX services gateways or component to Juniper Networks for repair or replacement.

Table 106: Return Procedure for SRX Series Services Gateways Component

Step	Task	For more information, see
1	Determine the part number and serial number of the services gateway or component.	<i>Locating the SRX Series Services Gateway Hardware Component Mini-PIM or GPIM Serial Number Label</i>
2	Obtain a Return Materials Authorization (RMA) number from JTAC.	<i>Contacting Customer Support</i>
3	Pack the SRX Series Services Gateway component for shipping.	<i>Packing the SRX Series Services Gateway Hardware Components for Shipment</i>

NOTE: Do not return the services gateway or any component to Juniper Networks unless you have first obtained an RMA number. Juniper Networks reserves the right to refuse shipments that do not have an RMA. Refused shipments are returned to the customer via collect freight.

For more information about return and repair policies, see the customer support Web page at <https://www.juniper.net/support/guidelines.html>.

For product problems or technical support issues, open a support case using the Case Manager link at <https://www.juniper.net/support/> or call 1-888-314-JTAC (within the United States) or 1-408-745-9500 (outside the United States).

Locating the SRX Series Services Gateway Hardware Component Mini-PIM or GPIM Serial Number Label

IN THIS SECTION

- [SRX Series Services Gateway Mini-PIM Serial Number Label | 263](#)
- [SRX Series Services Gateway GPIM Serial Number Label | 263](#)

This topic includes the following sections:

SRX Series Services Gateway Mini-PIM Serial Number Label

Mini-Physical Interface Modules (Mini-PIMs) are field-replaceable on the SRX Series Services Gateway. Each Mini-PIM has a unique serial number. The serial number label is located on the right side of the Mini-PIM, when the Mini-PIM is horizontally oriented (as it would be installed on the device). The exact location might be slightly different on different Mini-PIMs, depending on the placement of components on the Mini-PIM.

SRX Series Services Gateway GPIM Serial Number Label

Gigabit-Backplane Physical Interface Modules (GPIMs) are hot-swappable and field-replaceable on the SRX Series Services Gateway. Each GPIM has a unique serial number. The exact location might be slightly different on different GPIMs (XPIMs or GPIMs), depending on the placement of the components on the GPIM.

NOTE: Only the SRX650 Services Gateway supports hot-swappable functionality for GPIMs. The SRX550 Services Gateway does not support hot-swappable functionality for GPIMs.

Information You Might Need to Supply to JTAC

If you are returning a hardware component to Juniper Networks for repair or replacement, obtain a Return Materials Authorization (RMA) number from Juniper Networks Technical Assistance Center (JTAC).

When requesting support from JTAC by telephone, be prepared to provide the following information:

- Your existing case number, if you have one
- Details of the failure or problem
- Type of activity being performed on the services gateway component when the problem occurred
- Configuration data displayed by one or more **show** commands
- Your name, organization name, telephone number, fax number, and shipping address

RELATED DOCUMENTATION

Return Procedure for SRX Series Services Gateway Hardware Components

Locating the SRX Series Services Gateway Hardware Component Mini-PIM or GPIM Serial Number Label

[Contacting Customer Support | 261](#)

Required Tools and Parts for Packing the SRX Series Services Gateway Hardware Components

The following tools and parts are required to pack the SRX Series Services Gateway Hardware Components:

- Blank panel to cover empty Mini-PIM slot
- Electrostatic bag or antistatic mat, for each component
- Electrostatic discharge (ESD) grounding wrist strap
- Flat-blade screwdriver, approximately 1/4 in (6 mm)
- Phillips (+) screwdrivers, numbers 1 and 2

Packing the SRX Series Services Gateway Hardware Components for Shipment

IN THIS SECTION

- [Packing the Hardware Components for Shipment | 265](#)

This topic includes the following section:

Packing the Hardware Components for Shipment

Follow these guidelines for packing and shipping individual components of the services gateway:

- When you return a component, make sure that it is adequately protected with packing materials and packed so that the pieces are prevented from moving around inside the carton.
- Use the original shipping materials if they are available.
- Place individual Mini-Physical Interface Modules (Mini-PIMs) in electrostatic bags.
- Write the Return Materials Authorization (RMA) number on the exterior of the box to ensure proper tracking.



CAUTION: Do not stack any of the services gateway components during packing.