

REVISIONS		
Rev	DESCRIPTION	DATE
A	INITIAL RELEASE	2014.08.22

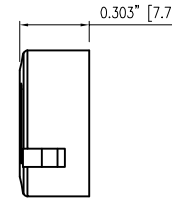

SUGGESTED MOUNTING CUTOUT

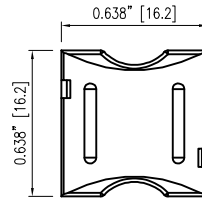
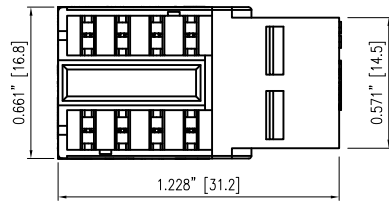
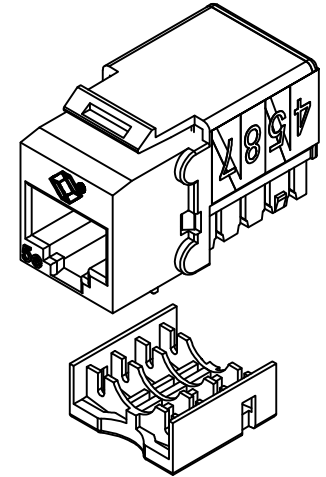
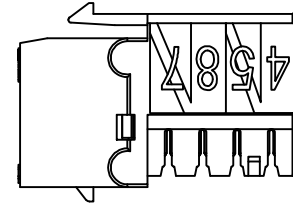
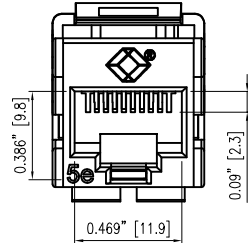
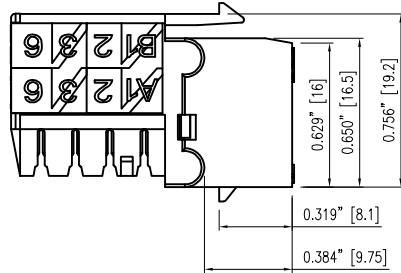
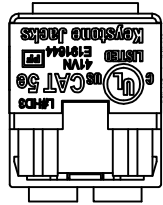
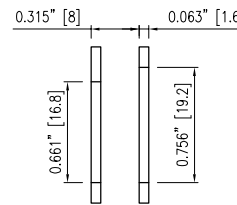
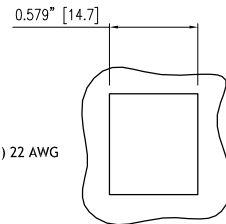

PIN ASSIGNMENTS	T568B	T568A
	1	WHITE/ORANGE
2	ORANGE	GREEN
3	WHITE/GREEN	WHITE/ORANGE
4	BLUE	BLUE
5	WHITE/BLUE	WHITE/BLUE
6	GREEN	ORANGE
7	WHITE/BROWN	WHITE/BROWN
8	BROWN	BROWN

MATERIAL
Housing: High-impact Acrylonitrile Butadiene Styrene (ABS resin), UL 94 V-0 rated
Jack Contacts: Phosphor Bronze flat wire, plated with 50 µm (1.27 µm) thick hard gold over nickel underplate
PCB: FR4
IDC Terminals: Phosphor Bronze, plated with tin over nickel underplate
IDC Block: High-impact Polycarbonate (PC resin), UL 94 V-0 rated
RoHS 2 compliant

WIRE RANGE
Conductor Diameters: 0.020 in (0.51 mm) 24 AWG - 0.025 in (0.64 mm) 22 AWG
Insulation Diameters: 0.032 in (0.8 mm) - 0.039 in (1.0 mm)
Cable Diameters: 0.197 in (5 mm) - 0.354 in (9 mm)

PERFORMANCE
Rating: TIA-568-C.2, Category 5e
MHz Rating: 1 - 100 MHz
Bandwidth Support: 10/100/1000 Mbps
Compliant: Meets TIA-568-C.2 Category 5e
Connecting Hardware Requirement for Component Level
Insertion Cycles: 750 Times for 8P Modular Plug
Cable Re-termination Cycles: 20 Times



DIMENSIONS ARE IN[MM]			
TOLERANCES:			
-0.787 [20]	-1.969 [50]	-5.906 [150]	5.906 [150]
±0.008 [0.2]	±0.016 [0.4]	±0.020 [0.5]	±0.059 [1.5]
3rd Angle Projection			

The information contained in this document is the sole property of Black Box Corporation of Pennsylvania. Any reproduction in part or whole without the written permission of Black Box Corp. is prohibited.
©Copyright 2012 Black Box Corporation of Pennsylvania d/b/a Black Box Network Services. All Rights Reserved.

UNLESS OTHERWISE SPECIFIED:
DIMENSIONS ARE IN INCHES
TOLERANCES:
FRACTIONAL: ±
ANGULAR: MACH ± BEND ±
TWO PLACE DECIMAL ±
THREE PLACE DECIMAL ±

INTERPRET GEOMETRIC TOLERANCING PER:
MATERIAL
FINISH
DO NOT SCALE DRAWING

BLACK BOX
NETWORK SERVICES

NAME	DATE	TITLE:
DRAWN Rita Lee	2014.08.22	GigaBase2 Universal Jack Category 5e, Gray
ENG APPR. Kihai Lee	2014.08.22	
CHECKED Max Wang	2014.08.22	SIZE DWG. NO. REV
COMMENTS:		B FMT923-R2 A
SCALE: X		SHEET 1 OF 1