

E26237

First Edition / May 2025

IN SEARCH OF INCREDIBLE



Service Manual

ASUS

COPYRIGHT INFORMATION

No part of this manual, including the products and software described in it, may be reproduced, transmitted, transcribed, stored in a retrieval system, or translated into any language in any form or by any means, except documentation kept by the purchaser for backup purposes, without the express written permission of ASUSTeK COMPUTER INC. ("ASUS").

ASUS PROVIDES THIS MANUAL "AS IS" WITHOUT WARRANTY OF ANY KIND, EITHER EXPRESS OR IMPLIED, INCLUDING BUT NOT LIMITED TO THE IMPLIED WARRANTIES OR CONDITIONS OF MERCHANTABILITY OR FITNESS FOR A PARTICULAR PURPOSE. IN NO EVENT SHALL ASUS, ITS DIRECTORS, OFFICERS, EMPLOYEES OR AGENTS BE LIABLE FOR ANY INDIRECT, SPECIAL, INCIDENTAL, OR CONSEQUENTIAL DAMAGES (INCLUDING DAMAGES FOR LOSS OF PROFITS, LOSS OF BUSINESS, LOSS OF USE OR DATA, INTERRUPTION OF BUSINESS AND THE LIKE), EVEN IF ASUS HAS BEEN ADVISED OF THE POSSIBILITY OF SUCH DAMAGES ARISING FROM ANY DEFECT OR ERROR IN THIS MANUAL OR PRODUCT.

Products and corporate names appearing in this manual may or may not be registered trademarks or copyrights of their respective companies, and are used only for identification or explanation and to the owners' benefit, without intent to infringe.

SPECIFICATIONS AND INFORMATION CONTAINED IN THIS MANUAL ARE FURNISHED FOR INFORMATIONAL USE ONLY, AND ARE SUBJECT TO CHANGE AT ANY TIME WITHOUT NOTICE, AND SHOULD NOT BE CONSTRUED AS A COMMITMENT BY ASUS. ASUS ASSUMES NO RESPONSIBILITY OR LIABILITY FOR ANY ERRORS OR INACCURACIES THAT MAY APPEAR IN THIS MANUAL, INCLUDING THE PRODUCTS AND SOFTWARE DESCRIBED IN IT.

Copyright © 2025 ASUSTeK COMPUTER INC. All Rights Reserved.

LIMITATION OF LIABILITY

Circumstances may arise where because of a default on ASUS' part or other liability, you are entitled to recover damages from ASUS. In each such instance, regardless of the basis on which you are entitled to claim damages from ASUS, ASUS is liable for no more than damages for bodily injury (including death) and damage to real property and tangible personal property; or any other actual and direct damages resulted from omission or failure of performing legal duties under this Warranty Statement, up to the listed contract price of each product.

ASUS will only be responsible for or indemnify you for loss, damages or claims based in contract, tort or infringement under this Warranty Statement.

This limit also applies to ASUS' suppliers and its reseller. It is the maximum for which ASUS, its suppliers, and your reseller are collectively responsible.

UNDER NO CIRCUMSTANCES IS ASUS LIABLE FOR ANY OF THE FOLLOWING: (1) THIRD-PARTY CLAIMS AGAINST YOU FOR DAMAGES; (2) LOSS OF, OR DAMAGE TO, YOUR RECORDS OR DATA; OR (3) SPECIAL, INCIDENTAL, OR INDIRECT DAMAGES OR FOR ANY ECONOMIC CONSEQUENTIAL DAMAGES (INCLUDING LOST PROFITS OR SAVINGS), EVEN IF ASUS, ITS SUPPLIERS OR YOUR RESELLER IS INFORMED OF THEIR POSSIBILITY.

SERVICE AND SUPPORT

Visit our multi-language website at <https://www.asus.com/support/>

Table of Contents

Chapter 1: Introduction

Disclaimer	6
Safety precautions.....	6
Pre-repair checklist.....	8
Installation tool.....	9
Diagnostic tools.....	9
Major components	10

Chapter 2: Service Procedures

Side covers.....	12
Removal.....	13
Installation.....	16
Graphics card.....	19
Removal (SKUs with RTX50x0)	20
Installation.....	21
Removal (SKUs with RTX4060/4070).....	23
Installation.....	24
RAM module	25
Removal.....	26
Installation.....	27
CPU fan module.....	29
Removal.....	30
Installation.....	31
Chassis fan module.....	32
Removal.....	33
Installation.....	35
M.2 SSD module	37
Removal.....	38
Installation.....	39
M.2 Wi-Fi module.....	40

Removal.....	41
Installation.....	42
Power supply unit (PSU) module.....	43
Removal.....	44
Installation.....	45
Motherboard	46
Removal.....	47
Installation.....	48
Appendices	
Wiring and connection diagrams.....	50

Chapter 1: ***Introduction***

Disclaimer

ASUS is not responsible for direct, indirect, intentional or unintentional damages resulting from improper installation and operation.

Safety precautions

- Before handling components, use a grounded wrist strap or touch a safely grounded object to avoid damaging them due to static electricity.
- Keep liquids or moisture away from your Desktop PC to avoid short circuits.
- Remove rings, watches, and any other metal objects from your hands.
- Hold components by the edges to avoid touching the ICs.
- Properly install all components before connecting the AC power.
- Do not use power adapters or batteries from other devices to reduce the risk of injury to persons due to fire or explosion. Use only certified power adapters or batteries supplied by the manufacturer or authorized retailers.
- Detach all clips or flaps before removing cables to prevent damage.

- Disconnect cables, connectors, and power plugs by pulling the plug evenly to avoid damage.
- Use the correct screw models on your Desktop PC to prevent damage.
- Confirm that the cable orientation is correct before connecting any cables.
- Fully remove all adhesive residue after removing and before installing any components.
- Photograph the appearance of cables, cable routing, connectors, and screws for later reference before proceeding with each step.

Pre-repair checklist

- Read the entire manual before starting any service procedures and follow all instructions.
- Back up the data on your Desktop PC.
- Place your Desktop PC on a clean and stable surface.
- Turn off your Desktop PC.
- Disconnect all connected peripherals and cables.
- Disconnect all power cables and remove the battery pack (if applicable).

IMPORTANT!

- If you are uncertain about performing the described service procedures, stop and contact an authorized service center for assistance.
- Purchase replacement components from authorized retailers of this Desktop PC to ensure maximum compatibility and reliability.

NOTES:

- The illustrations are for reference only.
 - The service procedures described in this manual depend on the model configuration and may not reflect the entire servicing process. To service components that are not covered in this manual, please visit an authorized service center for further assistance.
 - Keep all adhesive tape, insulating materials, screws, and other removable items in a safe place until the service procedure is completed, as they may be needed during installation.
-

Installation tool



Screwdriver

Diagnostic tools

Use ASUS System Diagnostics after completing any service procedures to ensure that all components are working properly.

For more information, visit www.asus.com/support/FAQ/1048490/.

Major components

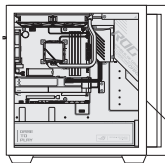

Side cover

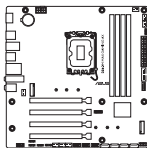

Motherboard



RAM module

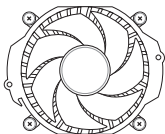

CPU fan module



Chassis fan module



M.2 SSD module

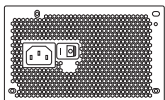

PSU

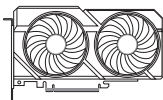

Graphics card

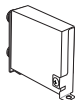

M.2 Wi-Fi module

NOTE: The illustrations in this manual are for reference only. Actual components may vary per model.

Chapter 2: ***Service Procedures***

Side covers

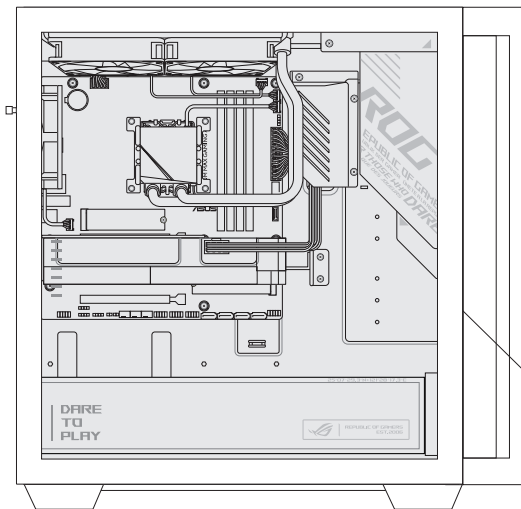

Before you begin

Read the **Safety Precautions** and complete the **Pre-repair Checklist**.

Screw list

- ⊕ Retention screws (2 pcs)

Removal

Remove the screw from the chassis, pull the side cover outward a bit to disassemble.

NOTE: The screw is non-removable from the side cover.

Left side

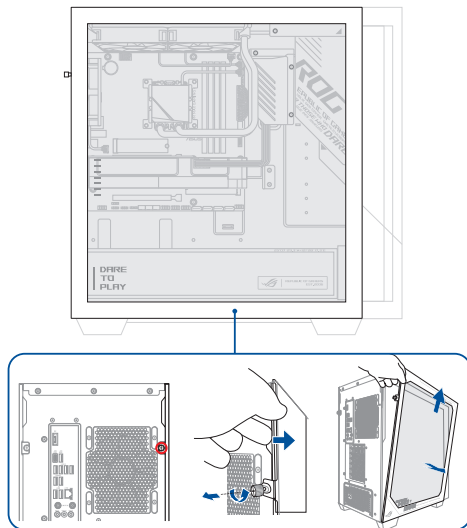

Right side

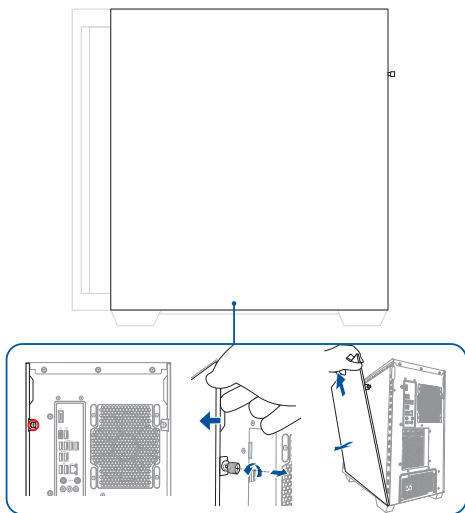

1. Stand the chassis upright.
2. With one hand applying pressure to the top, locate the groove on the bottom of the front bezel and gently pull it outwards to detach with the other hand.

Front side

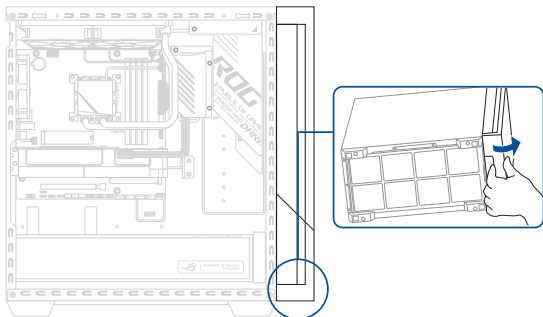

Installation

1. Put the side cover on the chassis and align the screw hole.
2. Secure the side cover using the screw you removed earlier.

Left side

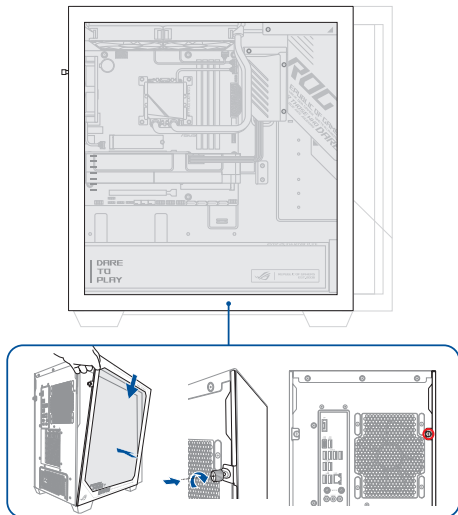

Right side

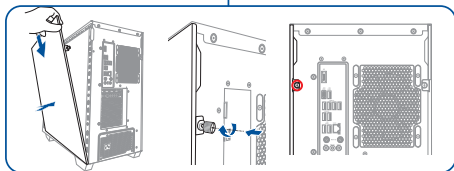
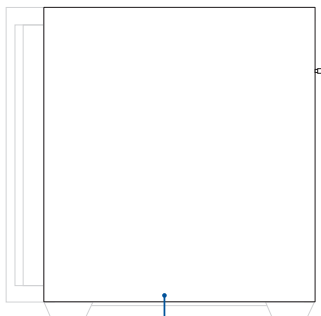

1. Stand the chassis upright.
2. Align and insert the front bezel to the chassis.

Front side

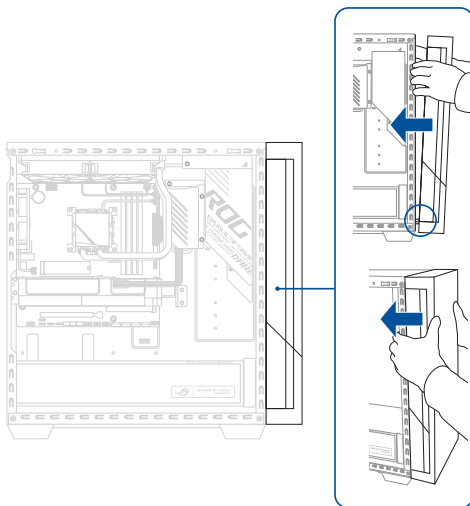

Graphics card

Before you begin

1. Read the **Safety Precautions** and **Pre-repair Checklist**.
2. Remove the following component:
 - Left side cover
 - Right side cover (SKU with RTX50x0 series)

SKU with RTX50x0

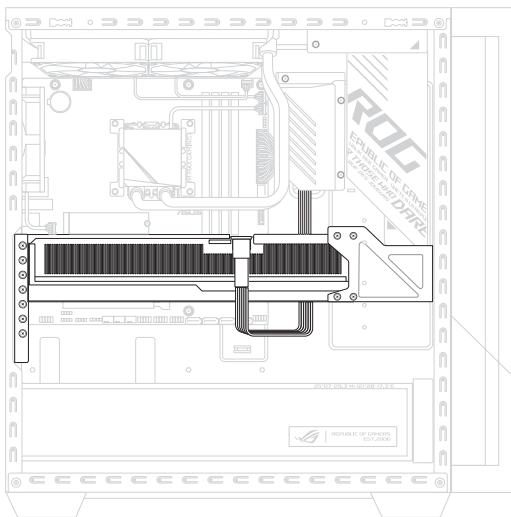

Screw list

- ⊕ #6-32 6.3L (7 pcs)
- ⊕ #6-32 6.3L (10 pcs)
- ⊕ M3.0 * 6.0L (3 pcs)

Removal (SKUs with RTX50x0)

1. Remove the front bezel of the chassis (SKUs with RTX5090 only).
2. Disconnect the ATX cable from the graphics card.
3. Remove the seven screws marked in red and the ten screws marked in blue and take out the VGA I/O bracket and the VGA extended bracket.
4. Press the retaining clip of the PCI Express slot outward to unlock and reject the graphics card.
5. Remove the three screws marked in green to detach the VGA bracket from the graphics card.

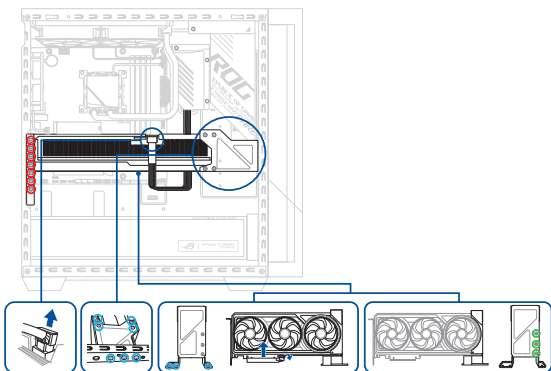

Installation

1. Install the VGA bracket to the side of the graphics card using the three screws marked in green.
2. Install the VGA support jig to the right side of the chassis. Then, carefully lay the chassis down so the left side is facing upwards.
3. Firmly insert the graphics card into the PCI Express slot until the retaining clip snaps back in place.
4. Install the VGA bracket with the seven screws marked in red and the ten screws marked in blue.
5. Remove the VGA support jig.
6. Connect the ATX cable to the graphics card.
7. Install the front bezel (SKUs with RTX5090 only).
8. Install the component you removed in the **Before you begin** section.

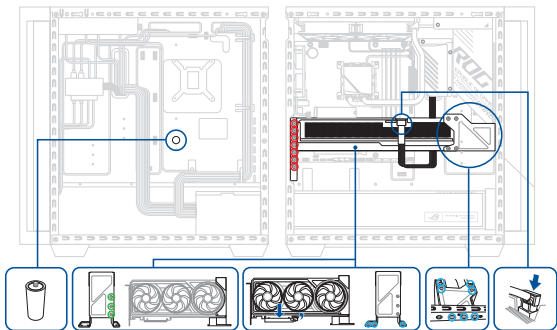

SKUs with RTX4060/4070

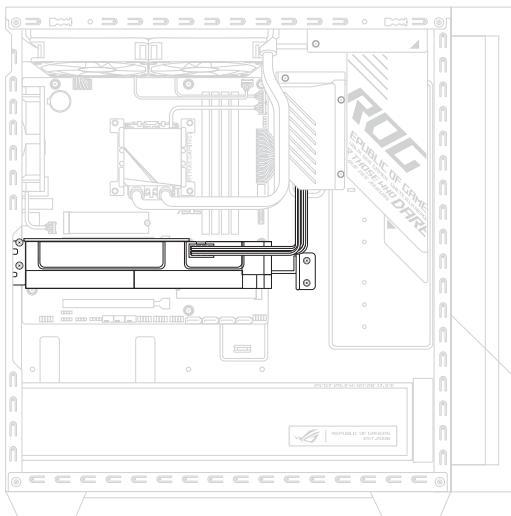

Screw list

- ⊕ #6-32 6.3L (4 pcs)
- ⊕ #6-32 6.3L (2 pcs)
- ⊕ M3.0 * 4.0L (2 pcs)

Removal (SKUs with RTX4060/4070)

1. Disconnect the ATX cable from the graphics card.
2. Remove the four screws marked in red.
3. Press the retaining clip of the PCI Express slot outward to unlock and reject the graphics card.
4. Take out the VGA card, and then remove the screws to detach the VGA bracket from the graphics card.

NOTE: RTX4060TI & RTX4060 has two VGA brackets and RTX4070 has only one VGA bracket.

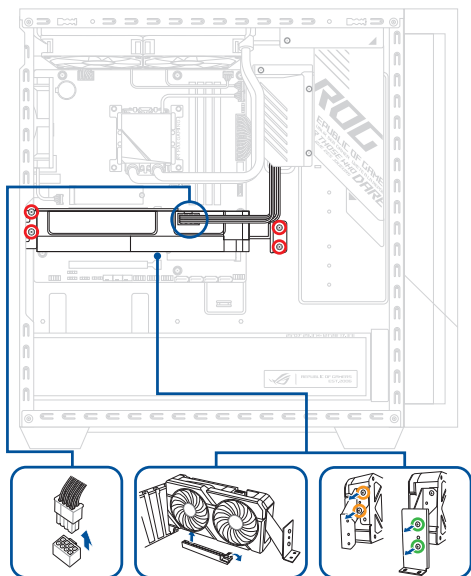

Installation

1. Install the VGA bracket to the side of the graphics card using the screws marked in green and yellow.
2. Firmly insert the graphics card into the PCI Express slot until the retaining clip snaps back in place.
3. Install the VGA bracket with the screws marked in red.
4. Connect the ATX cable to the graphics card.
5. Install the component you removed in the **Before you begin** section.

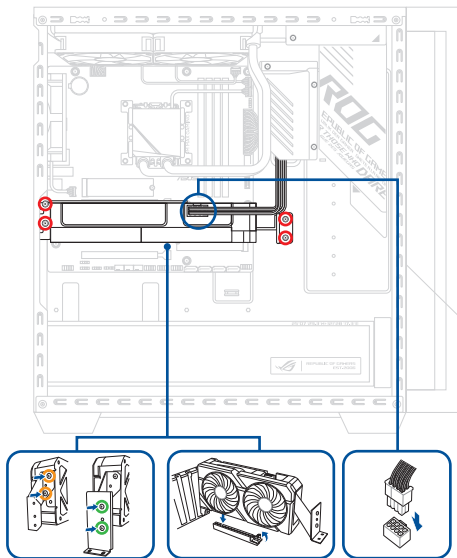

RAM module

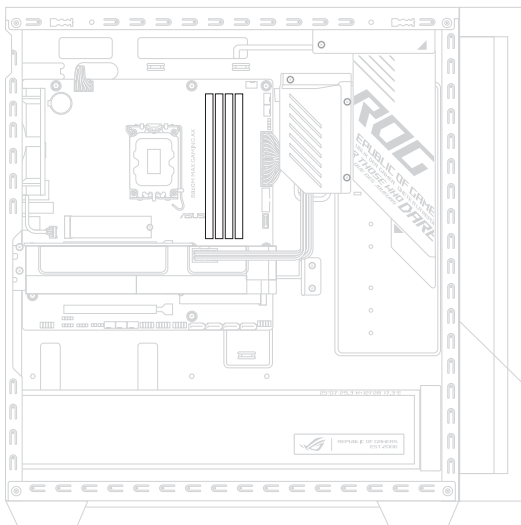

Before you begin

NOTE: The orientation of this component may vary by model.

1. Read the **Safety Precautions** and **Pre-repair Checklist**.
2. Remove the following component:

NOTE: The screw is non-removable from the side cover.

Removal

Press the clip(s) outwards to remove the RAM module(s).

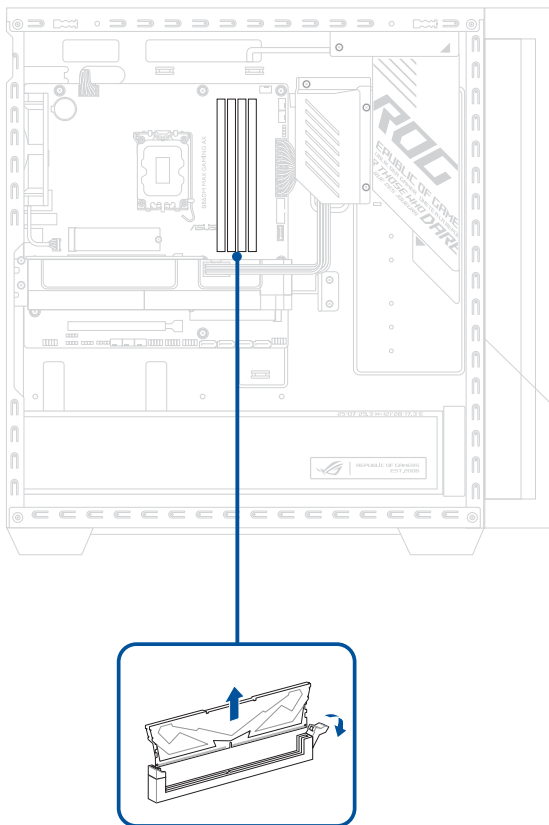

Installation

1. Align and insert the memory module(s) into the slot(s) and press down until securely seated in place.
2. Install the component you removed in the **Before you begin** section.

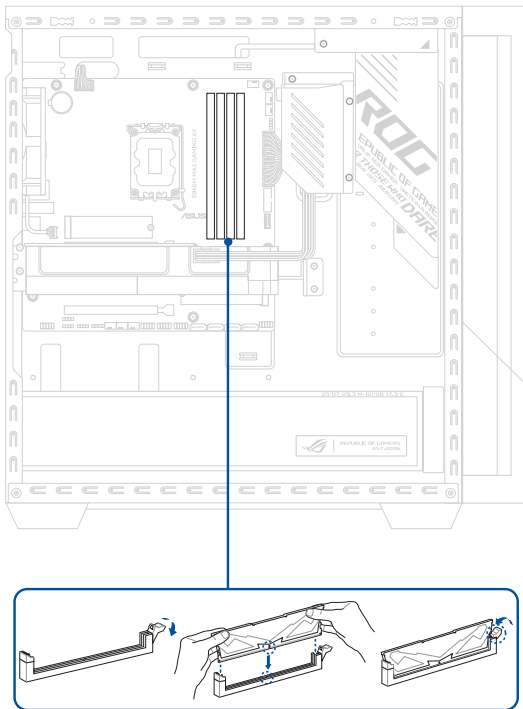

Recommended memory configurations

- Follow the installation sequence below to ensure system stability and avoid possible booting up failure.

	DIMM_B1	DIMM_B2	DIMM_A1	DIMM_A2
1 x DIMM	x	x	x	✓
2 x DIMM	x	✓	x	✓
4 x DIMM	✓	✓	✓	✓

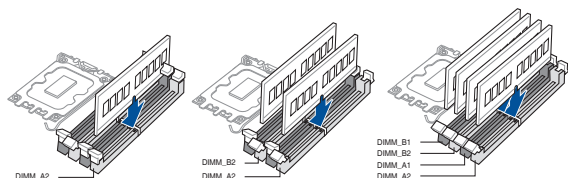

- Install DIMMs with the same capacity from the same manufacturer in the slots of the same channel.

Total memory capacity	Single memory capacity			
	DIMM_B1	DIMM_B2	DIMM_A1	DIMM_A2
8GB				8GB
16GB				16GB
16GB		8GB		8GB
32GB				32GB
32GB		16GB		16GB
32GB	8GB	8GB	8GB	8GB
64GB		32GB		32GB
64GB	16GB	16GB	16GB	16GB
128GB	32GB	32GB	32GB	32GB

CPU fan module

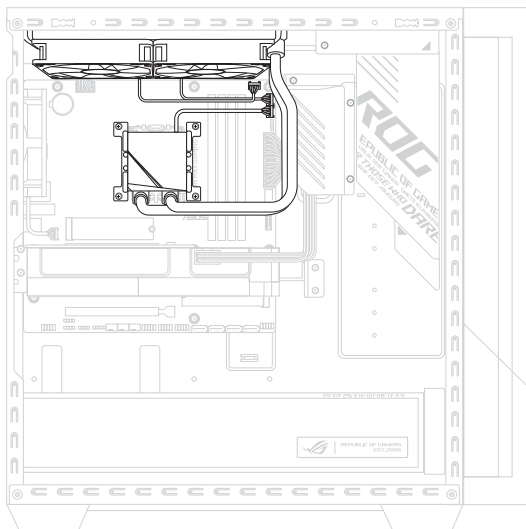

Before you begin

1. Read the **Safety Precautions** and **Pre-repair Checklist**.
2. Remove the following component:
 - Left side cover

Screw list

- ⊕ Screw with liquid cooler (4 pcs)
- ⊕ #6-32 6.3L (8 pcs)

Removal

1. Disconnect the three fan headers and take out the fan hub cover.
2. Remove the tape and disconnect the ARGB header.
3. Remove the four screws (marked in green) that secure the liquid cooler.
4. Remove the anti-dust top cover.
5. Remove the eight screws marked in red and take out the CPU fan module.

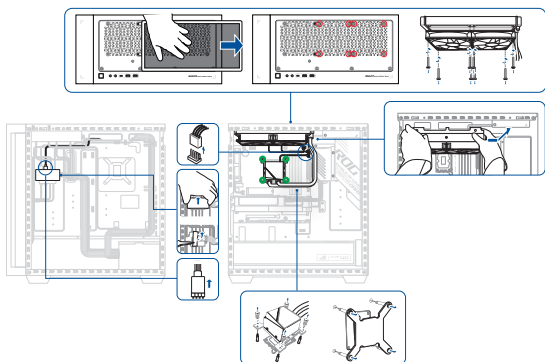

Chassis fan module

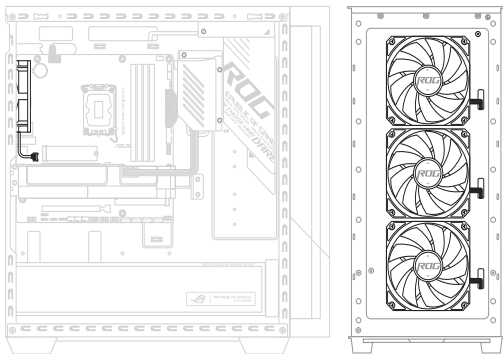

Before you begin

1. Read the **Safety Precautions** and **Pre-repair Checklist**.
2. Remove the following component:
 - Left side cover

Screw list

- ⊕ Rear fan screw (4pcs)
- ⊕ Front fan screw (12pcs)

Removal

1. Disconnect the chassis fan header.
2. Remove the screws on the rear side of the chassis and remove the chassis fan.

Rear fan

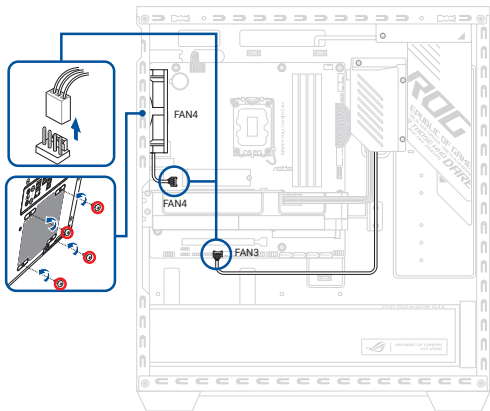

1. Remove the screws marked in red.
2. Remove the acetate tape from the fan hub.
3. Disconnect the fan headers.
4. Cut off the two black ties and then take out the four system fans.

Front fan

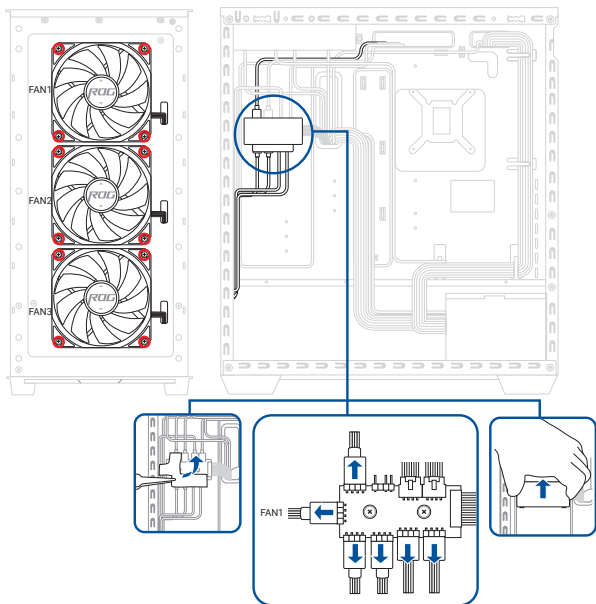

Installation

1. Align the screw holes of the fan and the chassis.
2. Secure with the screws you removed earlier.
3. Reconnect the chassis fan header.
4. Use a cable tie to bundle the cables together.
5. Install the component you removed in the **Before you begin** section.

Rear fan

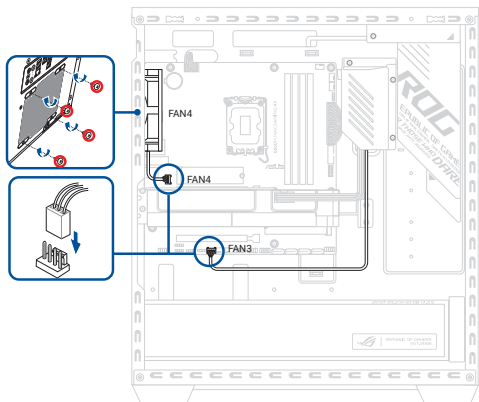

1. Align the screw holes of the fan and the chassis.
2. Secure with the screws you removed earlier.
3. Reconnect the chassis fan header.
4. Paste new acetate tape onto the fan hub.
5. Install the component you removed in the **Before you begin** section.

Front fan

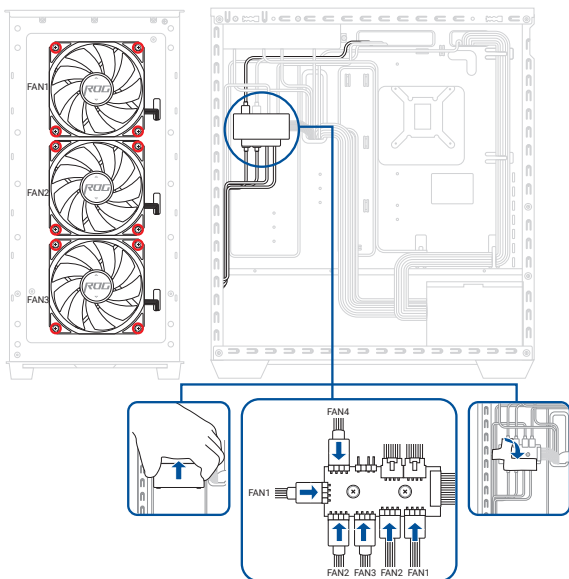

M.2 SSD module

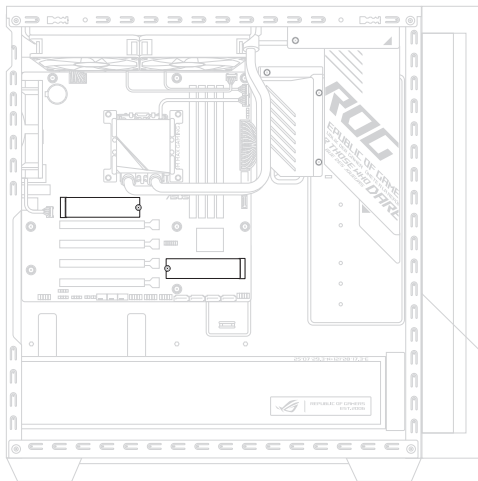

Before you begin

1. Read the **Safety Precautions** and **Pre-repair Checklist**.
2. Remove the following component:
 - Left side cover
 - Graphics card

Screw list

- ⊕ M2.0 * 2.0L (1pc)

Removal

1. Remove the screw(s) marked in green.
2. Remove the M.2 SSD.

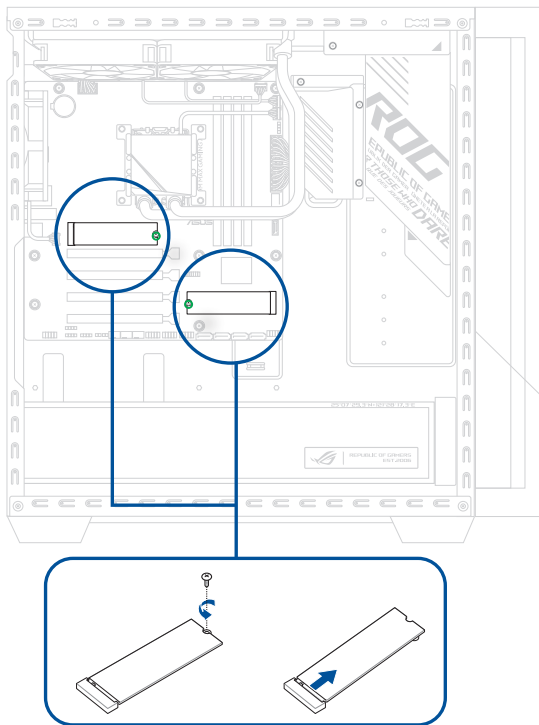

Installation

1. Insert the SSD module(s) into the M.2 slot(s) and secure with the screw(s) marked in green.
2. Install the components you removed in the **Before you begin** section.

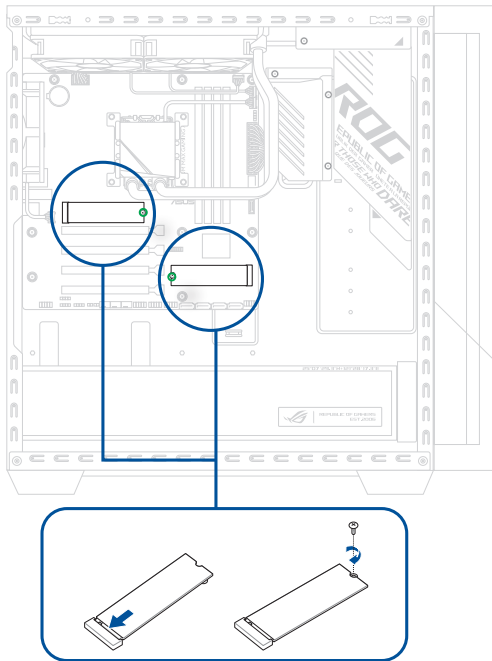

M.2 Wi-Fi module

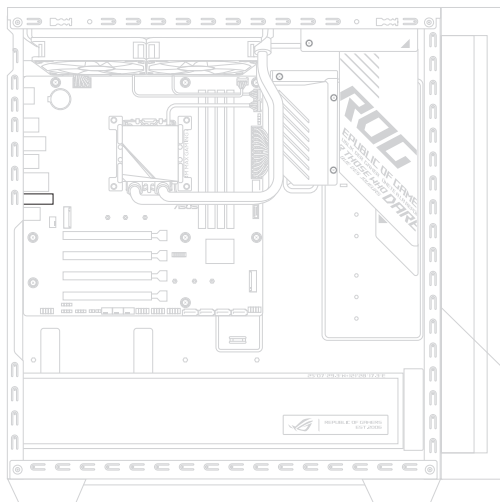

Before you begin

1. Read the **Safety Precautions** and **Pre-repair Checklist**.
2. Remove the following components:
 - Left side cover
 - Graphics card
 - Motherboard

Screw list

- ⊕ M2.0 * 4.0L (2pcs)
- ⊕ M2.0 * 3.0L (1pc)
- ⊕ M2.0 * 3.0L (1pc)

Removal

1. Remove the screws (marked in red) that secures the WiFi module from the bottom side of the motherboard.
2. Uninstall the WiFi module from the M.2 WiFi slot.
3. Remove the screw marked in green to detach the shielding for Z690 WiFi.
4. Disconnect two RF cables from the M.2 WiFi card.
5. Remove the screw (marked in blue) that secures the M.2 WiFi card.

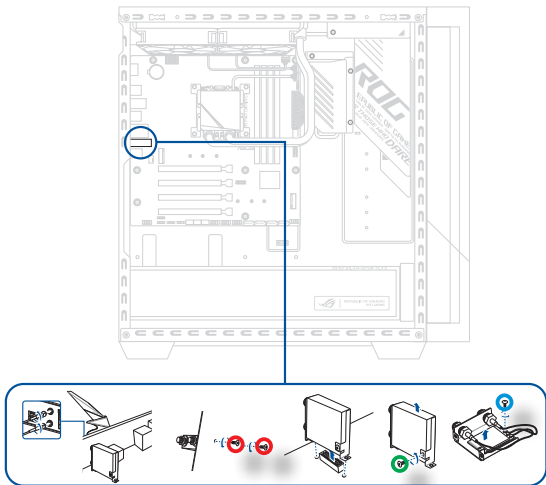

Installation

1. Assemble the nuts to two RF cables.
2. Secure the WiFi card to the module with the screw marked in blue and onnect the two RF cables to the M.2 WiFi card.
3. Assemble the shielding for Z690 WiFi and secure with the screw marked in green.
4. Install the WiFi module to the M.2 WiFi slot and secure with two screws (marked in red) on the bottom side of the motherboard.
5. Install the components you removed in the **Before you begin** section.

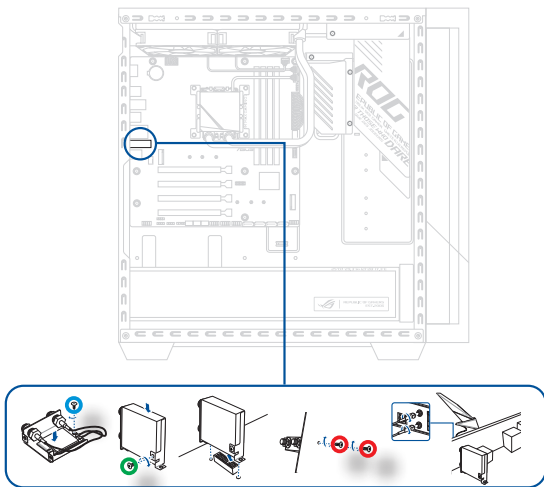

Power supply unit (PSU) module

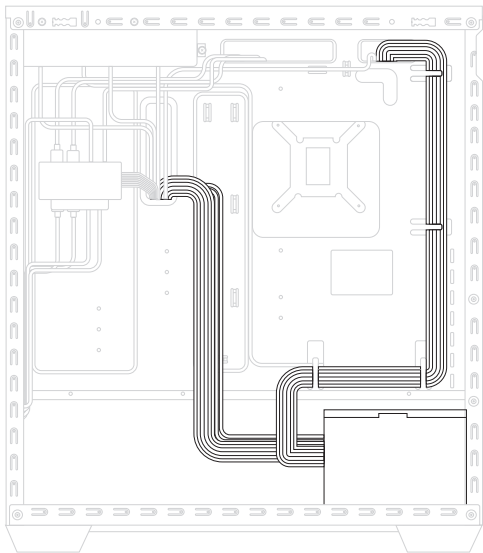

Before you begin

1. Read the **Safety Precautions** and **Pre-repair Checklist**.
2. Remove the following component:
 - Left side cover
 - Right side cover

Screw list

- ⊕ #6-32 * 6.3L, L7.3 * H2.45 (4pcs)

Removal

1. Disconnect the (4+4)-pin and 24-pin power connectors from the motherboard.
2. Disconnect all the cables of power supply unit from other components.
3. Release the cable ties.
4. Remove the screws on the rear side of the chassis marked in red.
5. Take out the power supply unit from the right side of the chassis.

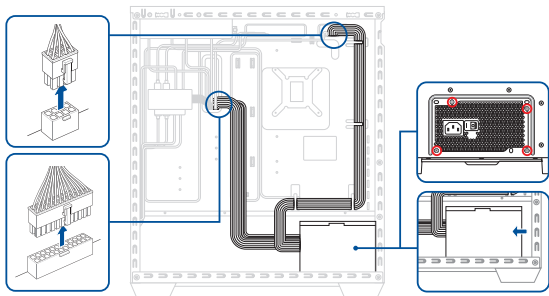

Installation

1. From the right side of the chassis, put the power supply into the lower right corner and align the screw holes.
2. Secure the PSU to the rear side of the chassis using the screws you removed earlier.
3. Route the power cable properly with the cable ties.
4. Plug the (4+4)-pin and the 24-pin power connectors to the motherboard.
5. Connect the cables of power supply unit to other components.
6. Install the component you removed in the **Before you begin** section.

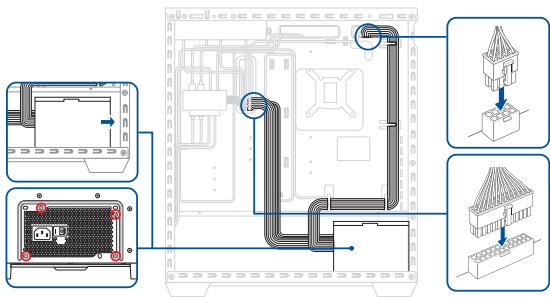

Motherboard

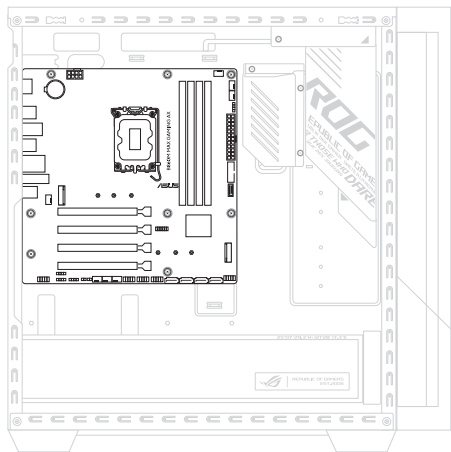

Before you begin

1. Read the **Safety Precautions** and **Pre-repair Checklist**.
2. Remove the following components:
 - Left side cover
 - HDD module
 - Graphics card
 - CPU fan module
 - M.2 SSD module
 - M.2 Wi-Fi module

Screw list

- ⊕ M3.0 * 4.0L (8pcs)
- ⊕ M2.0 * 2.5L (2pcs)

Removal

1. Disconnect the cables from the motherboard.
2. Remove the screws marked in green, then take out the motherboard from the chassis.
3. (For B860M MAX GAMING AX) Remove the two screws marked in red to disassemble the I/O shield.

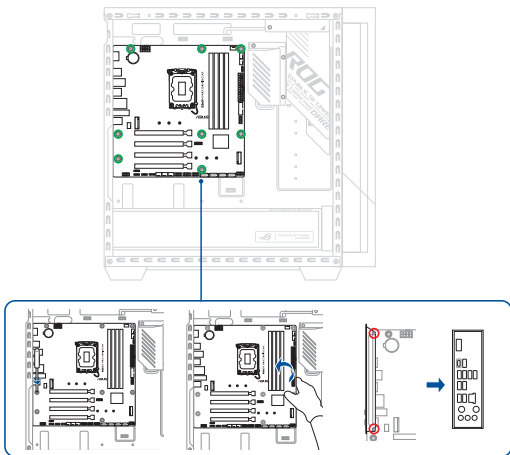

Installation

1. (For B860M MAX GAMING AX) Assemble the I/O shield to the motherboard with the screws marked in red.
2. Align and install the motherboard, then secure the motherboard using the screws you removed earlier.
3. Reconnect the cable(s) to the motherboard.
4. Install the front I/O using the two screws you removed earlier.
5. Install the components you removed in the **Before you begin** section.

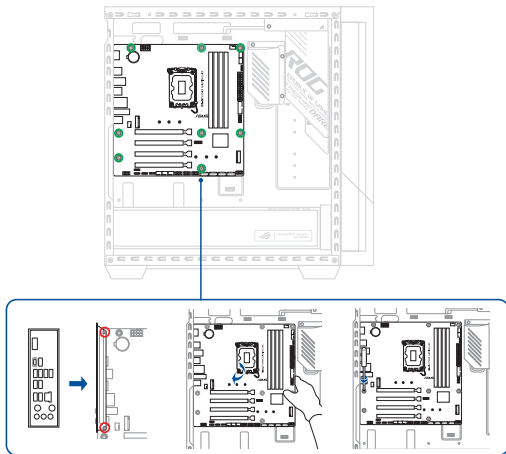

Appendix

Wiring and connection diagrams

Motherboard View

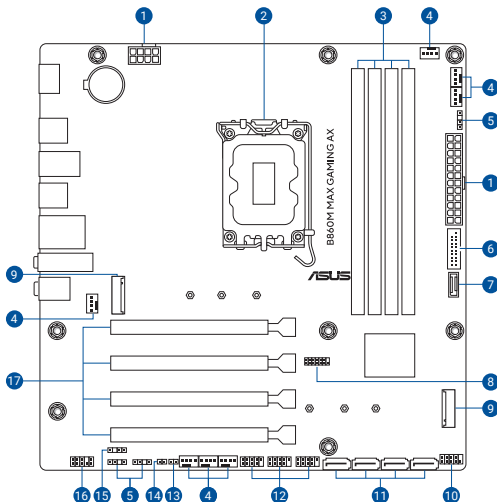

- | | |
|---------------------------------|--------------------------------|
| 1. Power connectors | 10. Front Panel System header |
| 2. CPU socket | 11. SATA portsFront LED header |
| 3. DIMM slots | 12. USB 2.0 headers |
| 4. Fan headers | 13. Chassis Intrusion header |
| 5. Addressable Gen2 headers | 14. Clear CMOS header |
| 6. USB 5Gbps header | 15. S/PDIF Out header |
| 7. USB 10Gbps Type-C® connector | 16. Front Panel Audio header |
| 8. TPM header | 17. Expansion slots |
| 9. M.2 SSD slots | |