



## **Cisco Wireless Phone 840 and 860 User Guide**

**First Published:** 2021-01-08

**Last Modified:** 2023-10-16

### **Americas Headquarters**

Cisco Systems, Inc.  
170 West Tasman Drive  
San Jose, CA 95134-1706  
USA  
<http://www.cisco.com>  
Tel: 408 526-4000  
800 553-NETS (6387)  
Fax: 408 527-0883

THE SPECIFICATIONS AND INFORMATION REGARDING THE PRODUCTS IN THIS MANUAL ARE SUBJECT TO CHANGE WITHOUT NOTICE. ALL STATEMENTS, INFORMATION, AND RECOMMENDATIONS IN THIS MANUAL ARE BELIEVED TO BE ACCURATE BUT ARE PRESENTED WITHOUT WARRANTY OF ANY KIND, EXPRESS OR IMPLIED. USERS MUST TAKE FULL RESPONSIBILITY FOR THEIR APPLICATION OF ANY PRODUCTS.

THE SOFTWARE LICENSE AND LIMITED WARRANTY FOR THE ACCOMPANYING PRODUCT ARE SET FORTH IN THE INFORMATION PACKET THAT SHIPPED WITH THE PRODUCT AND ARE INCORPORATED HEREIN BY THIS REFERENCE. IF YOU ARE UNABLE TO LOCATE THE SOFTWARE LICENSE OR LIMITED WARRANTY, CONTACT YOUR CISCO REPRESENTATIVE FOR A COPY.

The following information is for FCC compliance of Class A devices: This equipment has been tested and found to comply with the limits for a Class A digital device, pursuant to part 15 of the FCC rules. These limits are designed to provide reasonable protection against harmful interference when the equipment is operated in a commercial environment. This equipment generates, uses, and can radiate radio-frequency energy and, if not installed and used in accordance with the instruction manual, may cause harmful interference to radio communications. Operation of this equipment in a residential area is likely to cause harmful interference, in which case users will be required to correct the interference at their own expense.

The following information is for FCC compliance of Class B devices: This equipment has been tested and found to comply with the limits for a Class B digital device, pursuant to part 15 of the FCC rules. These limits are designed to provide reasonable protection against harmful interference in a residential installation. This equipment generates, uses and can radiate radio frequency energy and, if not installed and used in accordance with the instructions, may cause harmful interference to radio communications. However, there is no guarantee that interference will not occur in a particular installation. If the equipment causes interference to radio or television reception, which can be determined by turning the equipment off and on, users are encouraged to try to correct the interference by using one or more of the following measures:

- Reorient or relocate the receiving antenna.
- Increase the separation between the equipment and receiver.
- Connect the equipment into an outlet on a circuit different from that to which the receiver is connected.
- Consult the dealer or an experienced radio/TV technician for help.

Modifications to this product not authorized by Cisco could void the FCC approval and negate your authority to operate the product.

The Cisco implementation of TCP header compression is an adaptation of a program developed by the University of California, Berkeley (UCB) as part of UCB's public domain version of the UNIX operating system. All rights reserved. Copyright © 1981, Regents of the University of California.

NOTWITHSTANDING ANY OTHER WARRANTY HEREIN, ALL DOCUMENT FILES AND SOFTWARE OF THESE SUPPLIERS ARE PROVIDED "AS IS" WITH ALL FAULTS. CISCO AND THE ABOVE-NAMED SUPPLIERS DISCLAIM ALL WARRANTIES, EXPRESSED OR IMPLIED, INCLUDING, WITHOUT LIMITATION, THOSE OF MERCHANTABILITY, FITNESS FOR A PARTICULAR PURPOSE AND NONINFRINGEMENT OR ARISING FROM A COURSE OF DEALING, USAGE, OR TRADE PRACTICE.

IN NO EVENT SHALL CISCO OR ITS SUPPLIERS BE LIABLE FOR ANY INDIRECT, SPECIAL, CONSEQUENTIAL, OR INCIDENTAL DAMAGES, INCLUDING, WITHOUT LIMITATION, LOST PROFITS OR LOSS OR DAMAGE TO DATA ARISING OUT OF THE USE OR INABILITY TO USE THIS MANUAL, EVEN IF CISCO OR ITS SUPPLIERS HAVE BEEN ADVISED OF THE POSSIBILITY OF SUCH DAMAGES.

Any Internet Protocol (IP) addresses and phone numbers used in this document are not intended to be actual addresses and phone numbers. Any examples, command display output, network topology diagrams, and other figures included in the document are shown for illustrative purposes only. Any use of actual IP addresses or phone numbers in illustrative content is unintentional and coincidental.

All printed copies and duplicate soft copies of this document are considered uncontrolled. See the current online version for the latest version.

Cisco has more than 200 offices worldwide. Addresses and phone numbers are listed on the Cisco website at [www.cisco.com/go/offices](http://www.cisco.com/go/offices).

Cisco and the Cisco logo are trademarks or registered trademarks of Cisco and/or its affiliates in the U.S. and other countries. To view a list of Cisco trademarks, go to this URL: <https://www.cisco.com/c/en/us/about/legal/trademarks.html>. Third-party trademarks mentioned are the property of their respective owners. The use of the word partner does not imply a partnership relationship between Cisco and any other company. (1721R)

© 2025 Cisco Systems, Inc. All rights reserved.



# CONTENTS

---

## CHAPTER 1

### Your phone 1

Cisco Wireless Phone 840 and 860	1
Ingress Protection	4
Phone model numbers	5
Feature support	5
New and changed information	5
New and changed information for release 1.10(0)	5
New and changed information for release 1.9(0)	6
New and changed information for release 1.8(0)	6
New and changed information for release 1.7(0)	6
New and changed information for release 1.6(0)	6
New and changed information for release 1.5(0)	7
New and changed information for release 1.4(0)	7
New and changed information for release 1.3(0)	8
Getting started	12
Turn on your phone	13
Unlock your phone	13
Lock your phone	14
Turn off your phone	14
Self Care portal	15
Hardware, buttons, screen, and apps	15
Hardware and buttons	15
Launcher screen	20
Status bar	21
Status bar icons	22
View notification details	25

- Open quick settings 26
- Rearrange, remove, or add quick settings tiles 26
- Widgets and apps 27
  - Customize your launcher screen with widgets and apps 27
  - Cisco apps 28
  - Common Android apps 29
  - Access the overflow menu of a Cisco app 30
- Navigation control 31
- Software updates 32
  - Apply software updates 32
- Care of your phone 32
  - Maintenance schedule 33
  - Maintain your phone 34
    - Disinfectants 35
    - UV disinfection 36
  - Dry your phone 37
- More help and information 37
  - Accessibility 37
  - Cisco one-year limited hardware warranty terms 38
  - Battery warranty 38
  - Chargers and Battery packs 38

---

**CHAPTER 2**

**Phone setup 39**

- Phone battery installation 39
  - Install the battery 39
  - Remove the battery 41
  - Hot swap the battery for Cisco Wireless Phone 860 and 860S 42
- Battery contact damage prevention 43
- Phone battery charging 44
  - Charge the battery with the AC power supply 45
  - Charge the battery with the USB cable and a USB port on your computer 46
- Phone configuration 46
  - Wi-Fi profile configuration 47
    - Add the phone to a broadcasted Wi-Fi network 47

---

	Add the phone to a nonbroadcast Wi-Fi network	48
	Configure a TFTP server	49
	Configure a Call server mode	50
<b>CHAPTER 3</b>	<b>Cisco Phone app</b>	<b>51</b>
	Cisco Phone app overview	51
	Access the Cisco Phone app	52
	Cisco Phone app tabs	52
	Make calls	53
	Make a call from the Keypad tab	53
	Make a call from the Calls, Contacts, or Voicemail tab	53
	Make an emergency call from a locked screen	54
	Dial an emergency number	54
	Select a programmed emergency number	55
	Program emergency medical information	55
	Answer calls	55
	Answer a call	56
	Decline a call	56
	Ignore a call	57
	End a call	57
	Mute your microphone	57
	Change your audio option	58
	Hold calls	58
	Hold a call	58
	Swap between active and held calls	59
	Send a call to voicemail	59
	Call park	59
	Park a call	60
	Retrieve a call from call park	60
	Transfer a call to another person	60
	Call recording	61
	Conference calls	62
	Add a call to create a conference	62
	End a conference call	63

Speed dial	63
Set up speed dial	63
Make a call using speed dial	64
Make multiple calls	64
Access other apps during an active call	65
Turn on call forward	65
Turn off call forward	66
Log in and log out of hunt group	67
Turn Do Not Disturb on and off	67
Set Do Not Disturb options	68
Calls log	68
View your recent or missed calls	69
Add a recent caller to your contacts	69
Clear the call log	69
Contacts	70
Log in to your personal directory	70
Search for contacts	71
View details about your contacts	71
Add a new local or personal directory contact	72
Edit a local or personal directory contact	72
Add a contact to your favorites	73
Remove a contact from your favorites	73
Delete a local or personal directory contact	74
Voicemail	74
Access voicemail messages	75
Access visual voicemail	75
Multiple phone lines	76
View registered lines	77
Switch the active line	77
Shared phone lines	78
Add yourself to a call on a shared line	79
Resume a held call on a shared line	79
View multiple shared lines in use	79
Enable privacy on a shared line	80

- Enable limited privacy on a shared line 80
- Extension mobility 81
  - Log in to extension mobility 81
  - Log out of extension mobility 82

---

**CHAPTER 4****Emergency app 83**

- Emergency app overview 83
- Emergency motion conditions 84
  - Cancel motion conditions warning 84
  - Cancel motion conditions alarm 85
  - Suspend motion conditions monitoring 85
- Emergency and panic button 86
  - Activate the panic alarm 86
  - Cancel the panic alarm 87

---

**CHAPTER 5****Push to Talk app 89**

- Push to Talk overview 89
- Access PTT app 90
  - PTT app tabs 90
- Change the default PTT channel 91
- Change channel subscriptions 92
- Send a PTT broadcast 92
- Change the PTT volume 93
- Ignore a PTT broadcast 93
- Answer a phone call during a PTT broadcast 93
- Start a phone call during PTT broadcast 94

---

**CHAPTER 6****Battery Life app 95**

- Battery Life app overview 95
- Adjust the Battery Life alarm volume 96
- Stop the Battery Life alarm 96

---

**CHAPTER 7****Buttons app 99**

- Buttons app overview 99

- Programmable buttons 99
  - Actions for the programmable buttons 101
- Access Buttons app 101
  - Default button settings 102
- Change button function 102

---

**CHAPTER 8****Barcode app 103**

- Barcode app 103
- Test scan a barcode 104
- Scan a barcode 105
- Clean the scanner window 106

---

**CHAPTER 9****Settings 107**

- Access user settings for the Cisco Phone app 107
  - Change the ringtone 107
  - Set hearing aid compatibility mode 108
  - Set automatic noise cancellation 109
  - Set the phone to vibrate before it rings 109
  - Set the phone to fade in ring 110
  - Set the phone to autodial 110
- Adjust the volume during a call 111
- Access the Settings app 111
  - Turn on Bluetooth wireless technology 112
    - Pair a Bluetooth device 112
    - Connect a Bluetooth device 112
    - Rename a connected Bluetooth device 113
    - Disconnect a Bluetooth device 113
    - Forget a Bluetooth device 113
  - Adjust the phone ringer volume 114
  - Adjust the screen brightness 114
  - Change the screen display timeout 115
  - Change the font and display size 115
  - Set the screen to rotate automatically 116

---

**CHAPTER 10****Accessories 117**

- Supported accessories 117
- Headsets 118
  - Important headset safety information 118
  - Standard headsets 119
  - Bluetooth headsets 119
- Desktop chargers 119
  - Set up the desktop chargers 120
    - Charge your phone and battery with desktop dual charger 121
    - Charge your spare 860 batteries with desktop battery charger 122
- Multichargers 123
  - Assemble the Cisco Wireless Phone 860 Multicharger Base 125
  - Charge phones and batteries with multicharger 126
- Charger care 127
- Scanner handle for the Cisco Wireless Phone 840S 128
  - Install the Cisco Wireless Phone 840S in the scanner handle 128
- Clips 129
- Cisco accessory part numbers 129

---

**CHAPTER 11****Troubleshooting 133**

- General troubleshooting 133
- Find call server registration information 134
- Capture a screenshot on the phone 134
- Create a problem report from the phone 135

---

**CHAPTER 12****Product Safety and Security 137**

- Safety and Performance Information 137
  - Safety Guidelines 138
  - Battery Safety Notices 138
  - Power Outage 139
  - Regulatory Domains 139
  - Health-Care Environments 139
  - External Devices Usage 139

- Phone Behavior During Times of Network Congestion 140
- SAR 140
- Product Label 140
- Compliance Statements 141
  - Compliance Statements for the European Union 141
    - CE Marking 141
    - RF Exposure Statement for the European Union 141
  - Compliance Statements for the USA 141
    - SAR Statement 141
    - RF Exposure Information 141
    - General RF Exposure Compliance 143
    - Part 15 Radio Device 143
  - Compliance Statements for Canada 143
    - Canadian RF Exposure Statement 144
  - Compliance Statements for New Zealand 145
    - Additional Delay Warning 145
    - Permit to Connect (PTC) General Warning 145
    - Use of IP Networks with the PSTN 145
    - The Use of Voice Compression Through the PSTN 145
    - Echo Cancellation 145
  - Compliance Statement for Brazil 145
  - Compliance Statement for Singapore 146
- Cisco Product Security Overview 146
- Important Online Information 146



# CHAPTER 1

## Your phone

---

- [Cisco Wireless Phone 840 and 860, on page 1](#)
- [Feature support, on page 5](#)
- [New and changed information, on page 5](#)
- [Getting started, on page 12](#)
- [Self Care portal, on page 15](#)
- [Hardware, buttons, screen, and apps, on page 15](#)
- [Software updates, on page 32](#)
- [Care of your phone, on page 32](#)
- [More help and information, on page 37](#)

## Cisco Wireless Phone 840 and 860

The Cisco Wireless Phone 840 and 860 are wireless smartphones. These phones provide voice communication over your organization's wireless network using Cisco Unified Communications Manager and access points (APs). They work within the Wi-Fi range set by your organization.

Like other devices powered by Android, your phone is app-driven, not menu-driven. You tap icons to open applications. Your phone may include several different Cisco apps that allow you to:

- Place and receive phone calls.
- Put calls on hold.
- Transfer calls.
- Have conference calls.
- Forward your calls.
- Monitor your phone battery life.
- Customize your phone buttons.
- If configured, provide emergency safety features such as alarms and motion monitoring.
- If configured, send group broadcasts.

Like other network devices, the administrator configures and manages these phones. Based on the needs of your organization, the administrator may limit certain apps, features, or settings that may be available on consumer-grade Android devices.

Contact your administrator for information about the configured capabilities of your phone within your organization.

The following figure shows the Cisco Wireless Phone 840 on the left and the Cisco Wireless Phone 840S on the right. The Cisco Wireless Phone 840S includes a barcode scanner.

**Figure 1: Cisco Wireless Phone 840 and Cisco Wireless Phone 840S**



The following figure shows the Cisco Wireless Phone 860 on the left and the Cisco Wireless Phone 860S on the right. The Cisco Wireless Phone 860S includes a barcode scanner.

**Figure 2: Cisco Wireless Phone 860 and Cisco Wireless Phone 860S**



The Cisco Wireless Phone 860 and Cisco Wireless Phone 860S, though larger in size than the Cisco Wireless Phone 840 and Cisco Wireless Phone 840S, are similar in appearance and functionality.

Some physical characteristics of the Cisco Wireless Phone 840 and 860 include:

- 4.0 in. (10.2 cm) touchscreen for the 840 phones
- 5.2 in. (13.2 cm) touchscreen for the 860 phones
- 8 MP rear and 5 MP front camera for the 840 phones
- 13 megapixel (MP) rear and 8 MP front camera for the 860 phones
- Damage resistant Gorilla™ glass
- Recessed display for screen protection
- Tolerance of antibacterial and alcohol-based wipes
- Latex- and lead-free
- Shockproof and vibration-proof
- USB-C interface
- USB On-the-Go (OTG) 2.0 interface for use with a desktop charger or multicharger
- Cisco Wireless Phone 840 has Ingress Protection 65 (IP65) with resistance to dust and water spray from a nozzle
- Cisco Wireless Phone 860 has Ingress Protection 68 (IP68) with resistance to dust, drops, and liquids
- Chargeable with a USB, desktop charger, or multicharger

For more details about the phones, see the [product data sheet](#).

If configured, your phone provides enhanced productivity features that extend your call-handling capabilities, such as:

- Bluetooth® wireless headsets, including some hands-free call features
- Wireless access to your phone number and the corporate directory
- Access to network data, Android apps, and web-based services
- Online customization of the call forward feature from the Self Care portal

To prevent device damage:

- Don't intentionally submerge the phone or battery in water.
- Don't expose the phone to pressurized water or high velocity water, such as when showering, cleaning, or hand washing.
- Don't bathe or swim with the phone.
- Don't use the phone in a sauna or steam room.
- Don't use the phone in corrosive environments.
- Don't operate or store the phone, batteries, and accessories outside the suggested temperature ranges or in extremely humid, hot, or cold conditions.
- Don't intentionally drop the phone or subject it to other impacts.
- Don't disassemble the phone; don't remove any screws.
- Don't use harsh cleaning agents, like bleach and other chemicals, to clean the phone exterior.
- Don't use a broken battery.

Minimize the exposure of your phone to soap, detergent, acids or acidic foods, and any liquids; for example, salt water, soapy water, pool water, perfume, insect repellent, lotions, sun screen, oil, adhesive remover, hair dye, soft drinks, and solvents. For more information, see [Care of your phone, on page 32](#).

#### Related Topics

[Ingress Protection](#), on page 4

## Ingress Protection

The Cisco Wireless Phone 840 and 860 are tested under controlled laboratory conditions.

The Cisco Wireless Phone 840 and 840S have a rating of IP65 in ordinary locations. IP65 indicates that the phones can withstand dust and are resistant to water spray from a nozzle.

The Cisco Wireless Phone 860 and 860S have a rating of IP68 in ordinary locations. IP68 indicates that the phones can withstand dust and are resistant to brief submersion in shallow fresh water.

Due to normal wear, the resistance of the phone to dust and water may decrease. Therefore, it's important to take care of your phone and not deliberately expose the phone to a hostile environment of dust or water.

## Phone model numbers

Each phone has a model number. If you're unsure which model you have, you can locate the model number on the back of the phone after you remove the battery.



**Note** You can also find the model number through **Settings > About Phone > Model & hardware**.

*Table 1: Cisco Wireless Phone 840 and 860 model numbers*

Phone	Model number
Cisco Wireless Phone 840	CP-840
Cisco Wireless Phone 840S	CP-840S
Cisco Wireless Phone 860	CP-860
Cisco Wireless Phone 860S	CP-860S

### Related Topics

[Phone battery installation](#), on page 39

[Access the Settings app](#), on page 111

## Feature support

This document describes all the features that the device supports. However, not all features may be supported with your current configuration. For information on supported features, contact your administrator.

## New and changed information

The following section describes changes to this book to support new releases.

### New and changed information for release 1.10(0)

The following table describes changes to this book to support release 1.10(0).

*Table 2: New and changed information for release 1.10(0)*

Feature	New or changed information
Third Party Application Conflicts	<b>Updated:</b> <ul style="list-style-type: none"> <li><a href="#">General troubleshooting</a></li> </ul>

## New and changed information for release 1.9(0)

The following table describes changes to this book to support release 1.9(0).

*Table 3: New and changed information for release 1.9(0)*

Feature	New or changed information
Diagnostics Application	Updated: <ul style="list-style-type: none"> <li>• <a href="#">Cisco apps</a></li> </ul>
Push Custom Ringtone	Updated: <ul style="list-style-type: none"> <li>• <a href="#">Change the ringtone</a></li> </ul>

## New and changed information for release 1.8(0)

The following table describes changes to this book to support release 1.8(0).

*Table 4: New and changed information for release 1.8(0)*

Feature	New or changed information
Call recording	Updated: <ul style="list-style-type: none"> <li>• <a href="#">Call recording</a></li> </ul>

## New and changed information for release 1.7(0)

The following table describes changes to this book to support release 1.7(0).

*Table 5: New and changed information for release 1.7(0)*

Feature	New or changed information
Ringtones per Line	Updated: <ul style="list-style-type: none"> <li>• <a href="#">Change the ringtone</a></li> </ul>

## New and changed information for release 1.6(0)

The following table describes changes to this book to support release 1.6(0).

**Table 6: New and changed information for release 1.6(0)**

Feature	New or changed information
Call recording	<b>New:</b> <ul style="list-style-type: none"> <li>• <a href="#">Call recording</a></li> </ul>
Configure a Call server mode	<b>New:</b> <ul style="list-style-type: none"> <li>• <a href="#">Configure a Call server mode</a></li> </ul>

## New and changed information for release 1.5(0)

The following table describes changes to this book to support release 1.5(0).

**Table 7: New and changed information for release 1.5(0)**

Feature	New or changed information
New smart launcher screen with either a single app or multiple apps	<b>Updated:</b> <ul style="list-style-type: none"> <li>• <a href="#">Cisco Wireless Phone 840 and 860, on page 1</a></li> <li>• <a href="#">Turn on your phone, on page 13</a></li> <li>• <a href="#">Unlock your phone, on page 13</a></li> <li>• <a href="#">Launcher screen, on page 20</a></li> <li>• <a href="#">Status bar icons, on page 22</a></li> <li>• <a href="#">Open quick settings, on page 26</a></li> <li>• <a href="#">Widgets and apps, on page 27</a></li> <li>• <a href="#">Customize your launcher screen with widgets and apps, on page 27</a></li> <li>• <a href="#">Cisco apps, on page 28</a></li> <li>• <a href="#">Access the Cisco Phone app , on page 52</a></li> <li>• <a href="#">Access the Settings app, on page 111</a></li> <li>• <a href="#">Adjust the phone ringer volume, on page 114</a></li> <li>• <a href="#">Adjust the screen brightness, on page 114</a></li> </ul>

## New and changed information for release 1.4(0)

The following table describes changes to this book to support release 1.4(0).

Table 8: New and changed information for release 1.4(0)

Feature	New or changed information
Extension mobility cross cluster (EMCC)	<p><b>Updated:</b></p> <ul style="list-style-type: none"> <li>• <a href="#">Extension mobility</a>, on page 81</li> <li>• <a href="#">Log in to extension mobility</a> , on page 81</li> <li>• <a href="#">Log out of extension mobility</a>, on page 82</li> </ul>
Personal directory is available with contacts that synchronize through Cisco Unified Communications Manager	<p><b>New:</b></p> <ul style="list-style-type: none"> <li>• <a href="#">Log in to your personal directory</a>, on page 70</li> <li>• <a href="#">Delete a local or personal directory contact</a>, on page 74</li> </ul> <p><b>Updated:</b></p> <ul style="list-style-type: none"> <li>• <a href="#">Self Care portal</a>, on page 15</li> <li>• <a href="#">Contacts</a>, on page 70</li> <li>• <a href="#">Search for contacts</a>, on page 71</li> <li>• <a href="#">View details about your contacts</a>, on page 71</li> <li>• <a href="#">Add a new local or personal directory contact</a>, on page 72</li> <li>• <a href="#">Edit a local or personal directory contact</a>, on page 72</li> </ul>
New test scan is available in the <b>Barcode</b> app	<p><b>New:</b></p> <p><a href="#">Test scan a barcode</a>, on page 104</p> <p><b>Updated:</b></p> <ul style="list-style-type: none"> <li>• <a href="#">Barcode app</a>, on page 103</li> <li>• <a href="#">Scan a barcode</a>, on page 105</li> </ul>
Extension mobility log in with no directory number (DN)	<p><b>Updated:</b></p> <p><a href="#">Log in to extension mobility</a> , on page 81</p>
Updates to the user interface with new Webex branding color and style	<p><b>Updated:</b></p> <p>With this release, you'll notice some minor changes to user interface elements, such as button colors and icon shapes.</p> <p>The only icon that looks different is on the <b>Call Quality Settings</b>  app.</p>

## New and changed information for release 1.3(0)

The following table describes changes to this book to support release 1.3(0).

*Table 9: New and changed information for release 1.3(0)*

Feature	New or changed information
Multiple lines	

Feature	New or changed information
	<p><b>New:</b></p> <ul style="list-style-type: none"> <li>• Multiple phone lines, on page 76</li> <li>• View registered lines, on page 77</li> <li>• Switch the active line, on page 77</li> </ul> <p><b>Updated:</b></p> <ul style="list-style-type: none"> <li>• Access the overflow menu of a Cisco app, on page 30</li> <li>• Access the About option for a Cisco app, on page 31</li> <li>• Configure a TFTP server, on page 49</li> <li>• Make a call from the Keypad tab, on page 53</li> <li>• Make a call from the Calls, Contacts, or Voicemail tab, on page 53</li> <li>• Answer calls, on page 55</li> <li>• Answer a call, on page 56</li> <li>• Set up speed dial, on page 63</li> <li>• Make a call using speed dial, on page 64</li> <li>• Turn on call forward, on page 65</li> <li>• Turn off call forward, on page 66</li> <li>• Log in and log out of hunt group, on page 67</li> <li>• Calls log, on page 68</li> <li>• Clear the call log, on page 69</li> <li>• Voicemail, on page 74</li> <li>• Access voicemail messages, on page 75</li> <li>• Access visual voicemail, on page 75</li> <li>• Access user settings for the Cisco Phone app, on page 107</li> <li>• Change the ringtone, on page 107</li> <li>• Set hearing aid compatibility mode, on page 108</li> <li>• Set automatic noise cancellation, on page 109</li> <li>• Set the phone to vibrate before it rings, on page 109</li> <li>• Set the phone to fade in ring, on page 110</li> <li>• Set the phone to autodial, on page 110</li> <li>• Find call server registration information, on page 134</li> <li>• Create a problem report from the phone, on page 135</li> </ul>

Feature	New or changed information
Shared lines	<p><b>New:</b></p> <ul style="list-style-type: none"> <li>• <a href="#">Shared phone lines, on page 78</a></li> <li>• <a href="#">Add yourself to a call on a shared line, on page 79</a></li> <li>• <a href="#">Resume a held call on a shared line, on page 79</a></li> <li>• <a href="#">View multiple shared lines in use, on page 79</a></li> </ul> <p><b>Updated:</b></p> <ul style="list-style-type: none"> <li>• <a href="#">Turn on call forward, on page 65</a></li> <li>• <a href="#">Turn off call forward, on page 66</a></li> </ul>
Privacy on shared lines	<p><b>New:</b></p> <ul style="list-style-type: none"> <li>• <a href="#">Enable privacy on a shared line, on page 80</a></li> <li>• <a href="#">Enable limited privacy on a shared line, on page 80</a></li> </ul>
Cisco Extension Mobility	<p><b>New:</b></p> <ul style="list-style-type: none"> <li>• <a href="#">Extension mobility, on page 81</a></li> <li>• <a href="#">Log in to extension mobility , on page 81</a></li> <li>• <a href="#">Log out of extension mobility, on page 82</a></li> </ul>
Auto answer	<p><b>Updated:</b></p> <ul style="list-style-type: none"> <li>• <a href="#">Answer calls, on page 55</a></li> </ul>
Line text label	<p><b>New:</b></p> <ul style="list-style-type: none"> <li>• <a href="#">View registered lines, on page 77</a></li> </ul>
PTT broadcast on a locked phone	<p><b>Updated:</b></p> <ul style="list-style-type: none"> <li>• <a href="#">Send a PTT broadcast, on page 92</a></li> </ul>
<p>Administrator can control the following phone settings:</p> <ul style="list-style-type: none"> <li>• Font size</li> <li>• Display size</li> <li>• System navigation</li> </ul>	<p><b>Updated:</b></p> <ul style="list-style-type: none"> <li>• <a href="#">Change the font and display size, on page 115</a></li> <li>• <a href="#">Navigation control, on page 31</a></li> </ul>

Feature	New or changed information
More information about model numbers and accessories	<p><b>New:</b></p> <ul style="list-style-type: none"> <li>• <a href="#">Phone model numbers, on page 5</a></li> <li>• <a href="#">Cisco accessory part numbers, on page 129</a></li> </ul> <p><b>Updated:</b></p> <ul style="list-style-type: none"> <li>• <a href="#">Phone battery charging, on page 44</a></li> <li>• <a href="#">Charge the battery with the AC power supply, on page 45</a></li> <li>• <a href="#">Charge the battery with the USB cable and a USB port on your computer, on page 46</a></li> <li>• <a href="#">Supported accessories, on page 117</a></li> <li>• <a href="#">Desktop chargers, on page 119</a></li> <li>• <a href="#">Multichargers, on page 123</a></li> <li>• <a href="#">Clips, on page 129</a></li> </ul>

## Getting started

You must read [Product Safety and Security](#), before you install or charge the battery, or use the phone.

A rechargeable Lithium ion battery powers your phone. Before you can use your phone, install and charge the battery.

Your phone needs to connect to the corporate wireless network and the IP telephony network. Your administrator might set up your new wireless phone, or you might have to set it up. After the phone is set up, you can use the phone.

Make sure that you know how to turn your phone on and off and learn the available options of the phone. To comply with security standards, your organization may require you to sign in with unique credentials.

Your organization may allow some functions when the phone is locked. For example, you may be able to answer a call, place an emergency call, and see certain notifications. Check with your administrator if you have any questions about security.



### Note

Don't use the Android **Battery Saver**  mode. It curtails functionality to conserve battery life. In **Battery Saver** mode, features that you rely on may not work. If you require more than one charge per shift, contact your administrator for a second battery.

For your Cisco Wireless Phone 860 and 860S, you can use the hot swap battery change technique to maintain connectivity without loss of functionality.

The Cisco Wireless Phone 840 and 840S do not have an internal battery, so they do not support the hot swap feature.

**Related Topics**

[Phone setup](#), on page 39

[Make an emergency call from a locked screen](#), on page 54

[Hot swap the battery for Cisco Wireless Phone 860 and 860S](#), on page 42

## Turn on your phone

Generally, your administrator deploys your phone with multiple other phones and sets up the phone parameters before you receive the phone. In this case, the phone registers with the system and is ready for you to use when you turn it on. If your phone doesn't work when you turn it on, contact your administrator.

After you power on your phone, allow the screens to cycle through a bootup screen, the Cisco splash screen, and the Android screen. If your organization requires a PIN or password, the lock screen displays. If your phone doesn't need a password, the launcher screen automatically appears when you turn on the phone.

**Before you begin**

To maximize the storage capacity and lifespan of the battery, fully charge the battery before the first use of the phone.



---

**Note** To check the battery status while the phone is plugged into the charger, briefly press the **Power** button. When the battery life indicator is solid, the battery charge is full.

---

**Procedure**

---

Press and hold the **Power** button until the phone vibrates and the first screen displays.

---

**Related Topics**

[Phone battery charging](#), on page 44

[Hardware and buttons](#), on page 15

## Unlock your phone

To unlock your phone screen, you may need a password. Contact your administrator for more instructions. If available, the screen lock options are None, Swipe, Pattern, PIN, or Password.

User preferences and critical alerts display only after you unlock the phone.

If the phone is inactive for a set amount of time, the screen turns black and the phone goes into sleep mode.



---

**Note** You, or someone else, can make an emergency call from a locked phone screen using the **Emergency** call button.

---



---

**Note** If set up on your Cisco Wireless Phone 860 or 860S, you can use the fingerprint button to unlock the phone. However, on power-up you must use a PIN if your phone has a password.

The Cisco Wireless Phone 840 and 840S don't have a fingerprint scanner button.

---

## Procedure

---

**Step 1** If the phone is in sleep mode, briefly press the **Power** button.

**Step 2** If necessary, swipe up on the **Lock**  screen.

**Step 3** If necessary, enter your PIN or password and tap **Enter** .

---

### Related Topics

[Hardware and buttons](#), on page 15

[Make an emergency call from a locked screen](#), on page 54

## Lock your phone

It's best practice to turn off your screen whenever you're not using your phone. Turning off the screen:

- Locks the phone, keeping it secure.
- Prevents accidentally activating a button when you store the phone in a pocket or other place.
- Helps extend the battery life.

## Procedure

---

Briefly press the **Power** button.

---

### Related Topics

[Hardware and buttons](#), on page 15

## Turn off your phone

Power off the phone when you don't need it.



---

**Note** Don't remove the battery to power off the phone.

To replace the battery, power off the phone and then remove the battery, or for Cisco Wireless Phone 860, use the hot swap technique.

---

## Procedure

---

**Step 1** Press and hold the **Power** button.

**Step 2** Tap **Power off** .

---

### Related Topics

[Hardware and buttons](#), on page 15

[Hot swap the battery for Cisco Wireless Phone 860 and 860S](#), on page 42

## Self Care portal

The Self Care portal is part of your organization's Cisco Unified Communications Manager. You access the Self Care portal from your computer browser. Your administrator gives you the URL to access the Self Care portal, and provides your user ID and password.

On the Self Care portal website, you can:

- Customize your call forward.
- Manage your personal directory contacts.

To customize all other features, use your phone.

## Hardware, buttons, screen, and apps

Your phone's hardware, buttons, screens, and apps are similar to that of a consumer-grade smartphone or other Android device. However, since your phone is a managed device, your organization may configure certain limitations or allowances on the phone.

### Hardware and buttons

Your wireless phone has many hardware features and buttons that you use regularly.

Although the Cisco Wireless Phone 840 and Cisco Wireless Phone 860 are different sizes, the hardware and buttons perform the same actions. However, the hardware features and buttons are not in the same location on the phones. Another difference between the phones is that the Cisco Wireless Phone 840 doesn't have a fingerprint button.

#### Cisco Wireless Phone 840 hardware and buttons

The following figure shows the Cisco Wireless Phone 840 and 840S with a barcode scanner.

Figure 3: Cisco Wireless Phone 840 and 840S

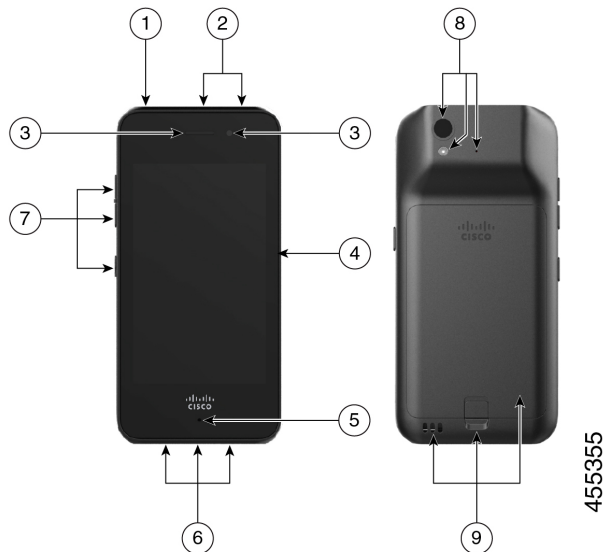

Table 10: Cisco Wireless Phone 840 and 840S hardware and buttons

Group number	Hardware or buttons in group
1	On the top left of the phone is the round <b>Power</b> button, which turns the power on and off, and locks and unlocks the screen.
2	On the top center of the Cisco Wireless Phone 840S is the barcode scanner, and on the top right is a round red <b>Programmable Emergency</b> alarm button. <ul style="list-style-type: none"> <li>• Barcode scanner—If the phone is an 840S, scans a barcode.</li> <li>• <b>Programmable Emergency</b> button—By default this programmable button is set as an <b>Emergency</b> button. If configured, the button sends a preprogrammed emergency panic alert.</li> </ul>
3	On the top front of the phone is the receive speaker in the middle, and the front camera on the right. <ul style="list-style-type: none"> <li>• Receive speaker—Receives audio.</li> <li>• Front camera—Captures images.</li> </ul>
4	On the right side of the phone is the <b>Programmable PTT</b> button. By default this programmable button is set to activate PTT. If enabled, PTT sends broadcast messages over preprogrammed channels like a walkie-talkie.
5	On the bottom front of the phone is the microphone, which captures your audio to send.

Group number	Hardware or buttons in group
6	<p>On the bottom of the phone is the headset jack on the left, the USB charging port in the middle, and the speaker on the right.</p> <ul style="list-style-type: none"> <li>• Headset jack—Supports a headset with a 3.5-mm audio plug.</li> <li>• USB charging port—Supports a USB cable to charge the phone.</li> <li>• Speaker—Receives audio you can hear.</li> </ul>
7	<p>On the left side of the phone are three programmable buttons. By default, the top and middle buttons are set as <b>Volume up</b> and <b>Volume down</b> respectively. By default, the bottom button is not set.</p> <ul style="list-style-type: none"> <li>• <b>Programmable Volume up</b> button—By default, this programmable button is set to turn up the volume.</li> <li>• <b>Programmable Volume down</b> button—By default, this programmable button is set to turn down the volume.</li> <li>• <b>Programmable</b> button—By default, this programmable button is set as the barcode scanner on the 840S phones.</li> </ul>
8	<p>On the upper left back of the phone is the rear camera above the flash lens or torch, with the rear microphone to the right.</p> <ul style="list-style-type: none"> <li>• Rear camera—Captures images.</li> <li>• Flash lens or torch—Emits light for a camera flash, or torch flashlight.</li> <li>• Rear microphone—Cancels noise.</li> </ul>
9	<p>On the lower back of the phone are the charger contacts on the left, the battery latch in the middle lower edge of the battery, and the battery.</p> <ul style="list-style-type: none"> <li>• Charger contacts—Connects with the contacts on a desktop charger or multicharger to charge the battery.</li> <li>• Battery latch—Releases and catches the battery in the phone.</li> <li>• Rechargeable battery—Powers the phone.</li> </ul>

### Cisco Wireless Phone 860 hardware and buttons

The following figure shows the Cisco Wireless Phone 860 and 860S with a barcode scanner.

Figure 4: Cisco Wireless Phone 860 and 860S

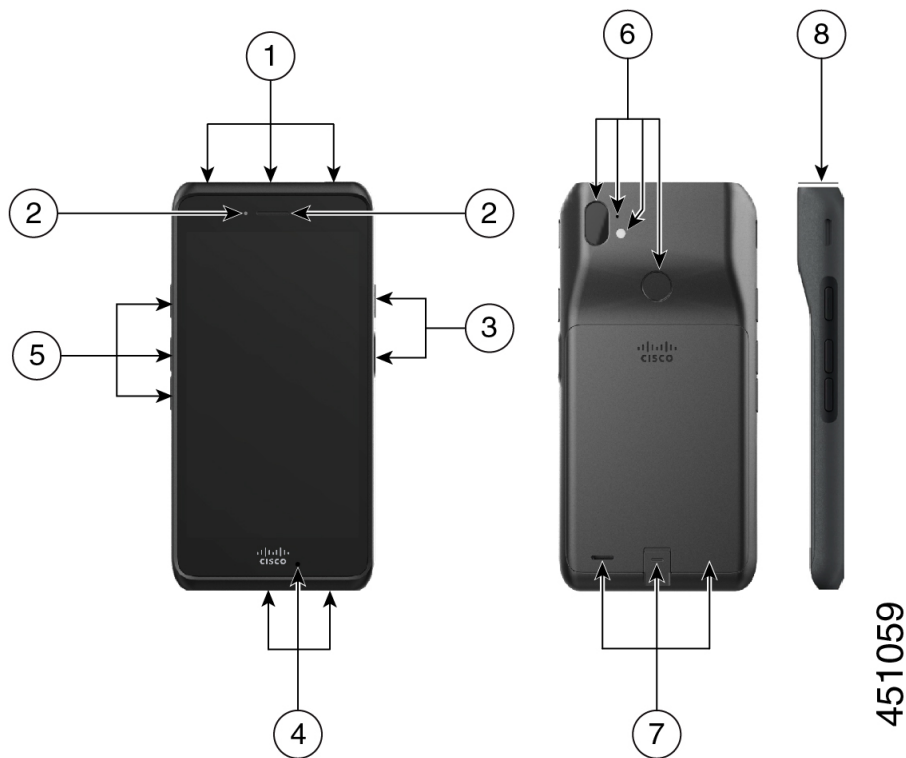

451059

Table 11: Cisco Wireless Phone 860 and 860S hardware and buttons

Group number	Hardware or buttons in group
1	<p>On the top of the phone is the headset jack on the left, the bar code scanner for 860S phones in the middle, and a red <b>Programmable Emergency</b> alarm button on the right.</p> <ul style="list-style-type: none"> <li>• Headset jack—Supports a headset with a 3.5-mm audio plug.</li> <li>• Barcode scanner—If the phone is an 860S, scans a barcode.</li> <li>• <b>Programmable Emergency</b> button—By default this programmable button is set as an <b>Emergency</b> button. If configured, the button sends a preprogrammed emergency panic alert.</li> </ul>
2	<p>On the top front left of the phone is the front camera, with the receive speaker to the right.</p> <ul style="list-style-type: none"> <li>• Front camera—Captures images.</li> <li>• Receive speaker—Receives audio.</li> </ul>

Group number	Hardware or buttons in group
3	<p>On the right side of the phone is the <b>Programmable Push to Talk (PTT)</b> button on the top, and the <b>Power</b> button on the bottom.</p> <ul style="list-style-type: none"> <li>• <b>Programmable PTT</b> button—By default this programmable button is set to activate PTT. If enabled, PTT sends broadcast messages over preprogrammed channels like a walkie-talkie.</li> <li>• <b>Power</b> button—Turns the power on and off, and locks and unlocks the screen. A raised edge protects the power button, so it's not easy to press by accident.</li> </ul>
4	<p>On the bottom of the phone is the USB charging port on the left, the microphone in the middle, and the charger contacts on the right.</p> <ul style="list-style-type: none"> <li>• <b>USB charging port</b>—Supports a USB cable to charge the phone.</li> <li>• <b>Microphone</b>—Captures your audio to send.</li> <li>• <b>Charger contacts</b>—Connects with the contacts on a desktop charger to charge the battery.</li> </ul>
5	<p>On the left side of the phone are three programmable buttons. By default, the top button is set as the <b>Scanner</b> for 860S phones. By default, the middle and bottom buttons are set as <b>Volume up</b> and <b>Volume down</b> respectively.</p> <ul style="list-style-type: none"> <li>• <b>Programmable</b> button—By default, this programmable button is set as the barcode scanner on the 860S phones.</li> <li>• <b>Programmable Volume up</b> button—By default, this programmable button is set to turn up the volume.</li> <li>• <b>Programmable Volume down</b> button—By default, this programmable button is set to turn down the volume.</li> </ul>
6	<p>On the top back of the phone is the rear camera on the far left, and the rear microphone above the flash lens or torch. In the upper middle of the phone is a <b>Programmable Fingerprint</b> scanner button.</p> <ul style="list-style-type: none"> <li>• <b>Rear camera</b>—Captures images.</li> <li>• <b>Rear microphone</b>—Cancels noise.</li> <li>• <b>Flash lens or torch</b>—Emits light for a camera flash, or torch flashlight.</li> <li>• <b>Programmable Fingerprint</b> scanner button—By default, this programmable button is set to act as a fingerprint scanner to unlock the phone.</li> </ul>
7	<p>On the lower back of the phone is the rear speaker on the left, the battery latch in the middle lower edge of the battery, and the battery.</p> <ul style="list-style-type: none"> <li>• <b>Rear speaker</b>—Receives audio you can hear.</li> <li>• <b>Battery latch</b>—Releases and catches the battery in the phone.</li> <li>• <b>Rechargeable battery</b>—Powers the phone.</li> </ul>

Group number	Hardware or buttons in group
8	This side view of the 860S highlights the barcode scanner on the top of the phone.



**Note** If you use an incorrect cable to connect to the phone USB port, third-party accessories such as keyboards or a mouse may not work. When buying these products, look for Benson Approved and OTG cables. Any cables or adapters must be USB certified and built to the USB-C specification.



**Note** If available, you can reprogram the **Programmable** buttons with the **Buttons**  app.

### Related Topics

[Change button function](#), on page 102

## Launcher screen

The launcher screen is the first screen that you see after you turn on or unlock the phone. It differs based on how the administrator customizes the phones, but contains the following general areas:

- **Top of the screen**—Contains the status bar, which displays the time and icons that give you information about the status of your phone and notifications.
- **Body of the screen**—Contains the apps and widgets that the administrator installs on the phone. The administrator may use a smart launcher to display a limited number of apps, so what you see can vary from a:
  - Launcher screen with all the factory default apps and widgets such as a phone, web browser, camera, and collection of Android and custom **Cisco** apps.
  - Smart launcher screen with multiple selected apps.
  - Smart launcher screen with a single, open app.
- **Bottom of the screen**—Contains navigation controls.



**Note** The smart launchers in this guide show what you may see if the administrator uses the Cisco Wireless Phone Configuration Management tool to set up your phone. Your phone may not look or act exactly as described in this guide if set up with another tool, such as an Enterprise Mobility Management (EMM) application.

**Figure 5: Sample launcher screens: factory default launcher, smart launcher with multiple apps, and smart launcher with a single open app**

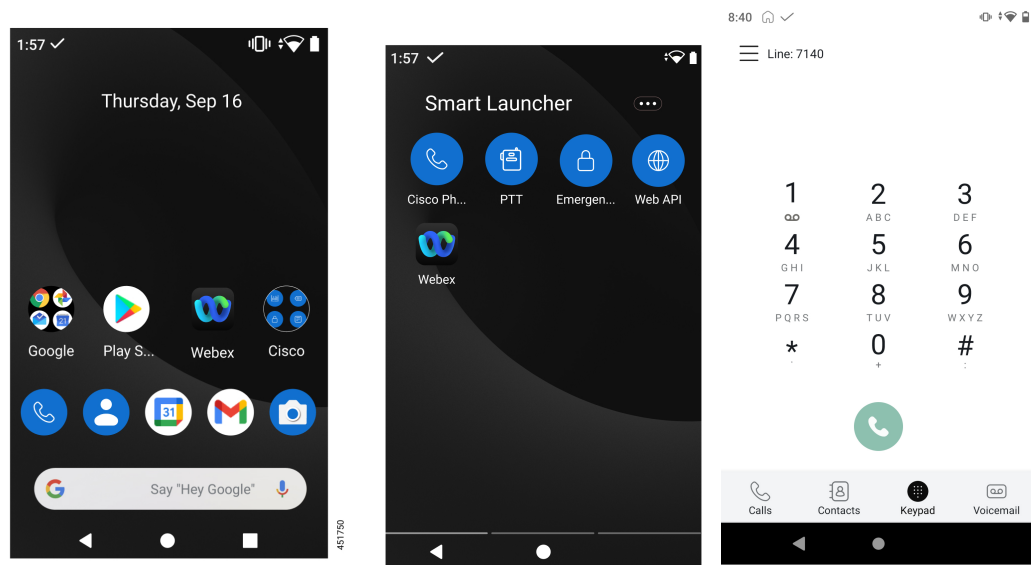

### Related Topics

[Widgets and apps](#), on page 27

[Cisco apps](#), on page 28

[Navigation control](#), on page 31

## Status bar

The status bar is dynamically populated to provide current information about your phone.

The status bar permanently displays the:

1. **Current time**—Displays the time. Contact your administrator if the displayed time is incorrect.
2. **Wi-Fi connection**—Indicates the signal strength of the connection. Low signal strength prevents proper phone operation. Contact your administrator if you don't have sufficient signal strength as indicated by an x or no bars on this icon.
3. **Battery health**—Represents the amount of charge remaining in the battery. If the battery charge is low, replace or charge the battery.

The status bar also displays icons for notifications, phone status, and settings. For example, the check mark ✓ signifies that the phone is registered to the call control system and able to make or receive calls.

Figure 6: Status bar

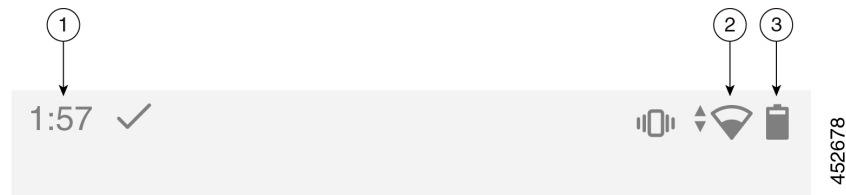

## Status bar icons

The status bar displays many icons. The following tables interpret some of these icons.

Table 12: Android notifications

Icon	Description
	Gmail notification
	Sign in attempted
	System certificate notification
	Notification

Table 13: Quick settings

Icon	Description
	Strong Wi-Fi signal strength
	Very good Wi-Fi signal strength
	Good Wi-Fi signal strength
	Weak Wi-Fi signal strength
	Wi-Fi connection without internet
	Bluetooth® connection
	Do Not Disturb
	Hotspot
	Data saver





















Icon	Description
	Mobile data
	Airplane mode
	Location

Table 14: Phone status

Icon	Description
	Managed system
	<p>Battery saver mode</p> <p><b>Caution</b></p> <p>Don't use the Android <b>Battery Saver</b>  mode. It curtails functionality to conserve battery life. In <b>Battery Saver</b> mode, features that you rely on may not work. If you require more than one charge per shift, contact your administrator for a second battery.</p> <p>For your Cisco Wireless Phone 860 and 860S, you can hot swap the battery to maintain connectivity without loss of functionality.</p> <p>The Cisco Wireless Phone 840 and 840S do not have an internal battery, so they do not support the hot swap feature.</p>
	Battery full
	Battery half full
	Battery charging
	Battery full and on charger
	Phone on vibrate only mode
	Phone transmitting and receiving

**Table 15: Cisco Phone app status**

Icon	Description
	SIP registration in process
	SIP registration success
	SIP registration failed
	In a call
	In a Cisco secure call with Transport Layer Security (TLS) and Secure Real-Time Transport Protocol (SRTP)
	In a Cisco secure call with TLS but not SRTP
	Missed call
	Voicemail message

**Table 16: Smart launcher status**

Icon	Description
	Smart launcher notification

**Table 17: System Updater app status**









Icon	Description
	System update downloading

**Table 18: PTT app status**

Icon	Description
	Active Push to Talk (PTT) call

**Table 19: Emergency app status**



Icon	Description
	Charging, motion sensor monitoring paused but the Panic Button is enabled and operational.

Icon	Description
	Charging, motion sensor monitoring paused and the Panic Button is disabled.
	Charging, motion sensor monitoring disabled but the Panic Button is enabled and operational.
	Motion sensors are monitoring, but the Panic Button is disabled.
	Motion sensors are monitoring, and the Panic Button is enabled.
	Motion sensor monitoring is disabled, but the Panic Button is enabled and operational.
	WARNING: Motion sensor monitoring threshold is exceeded. The Panic Button is enabled but not alarming.  <b>Note</b> The Panic Button never goes to the warning state.
	WARNING with Panic Button disabled.
	ALARMING due to motion sensor trigger.
	ALARMING due to Panic Button press.

### Related Topics

[Hot swap the battery for Cisco Wireless Phone 860 and 860S](#), on page 42

## View notification details

Notification icons appear on the left side of the status bar. These notifications let you know the status of the phone and also when you may have missed something. For example, the **SIP registration success**  icon indicates that the phone is registered and that you can make calls. **Missed call**  and **Voicemail**  notifications are also common notification examples.

If configured, an LED blinks to let you know that you have a notification when your phone is in sleep mode.



**Note** The Android operating system and the apps installed by your administrator produce and control the notifications that you receive on your phone. If available, you may be able to control some notification options from the **Apps & notifications** setting in the **Settings**  app.

To access more details about your notifications, you can open the quick settings and notification drawer.

## Procedure

- 
- Step 1** From an unlocked screen, swipe down on the status bar.
- Step 2** To clear the notification drawer, tap **CLEAR ALL**.
- 

## Open quick settings

If enabled by your administrator, you can quickly access frequently used settings such as **Flashlight** or **Do Not Disturb** in the quick settings on your phone. You can even access these quick settings from a locked phone.

The quick setting tiles vary depending on how the administrator sets up the phone. For example, your administrator may turn off **Wi-Fi** and **Airplane mode** in the quick settings, but allow them to be available in the Android settings menus. Or, if your administrator set up your phone with a smart launcher, then the flashlight, volume, and screen brightness quick settings are always available.

Contact your administrator if you have any questions about your quick setting options.



---

**Note** If your phone has the smart launcher with multiple apps, open the quick settings from the smart launcher **Overflow**  menu.

---

## Procedure

- 
- Step 1** Swipe down from the status bar at the top of the screen.
- Step 2** If your phone has the smart launcher with a single app, tap **Quick Settings**.
- Step 3** If available, swipe down again to display more settings and options.
- Step 4** (Optional) Choose from the following:
- Tap a setting tile to turn it on or off.
  - Touch and hold a setting tile for more options for the setting.

**Note**

Unlock the phone to access more options for the setting.

---

## Rearrange, remove, or add quick settings tiles

If enabled, you can rearrange the quick settings tiles so that the tiles that you use frequently are on top. You may also be able to remove or add quick settings tiles depending on the settings that the administrator enables.

**Before you begin**

Unlock your phone.

## Procedure

- Step 1** From the top of your screen, swipe down twice to fully open the quick settings.
- Step 2** Tap **Edit** .
- Step 3** To rearrange the quick settings tiles, touch and hold a tile and drag it to where you want it.
- To remove a tile, drag it down to the **DRAG HERE TO REMOVE** section.
  - To add a tile, drag it up from the **HOLD AND DRAG TO ADD TILES** section.

## Widgets and apps

At the factory, they load your phone with several widgets and apps. However, the widgets and apps on your phone may vary based on what your administrator installs.

- Widgets provide standard smartphone features such as the date and weather.
- Android apps provide standard smartphone features such as a calendar and camera.
- Cisco apps provide specialized features, such as battery life tracking and programmable buttons. They also allow the administrator to program your phone to work better in your controlled environment. Unless otherwise customized for your organization, some Cisco apps appear on the launcher screen in a **Cisco** apps collection folder, as shown in the following illustrations. Other apps are in the launcher.

**Figure 7: Widgets and apps**

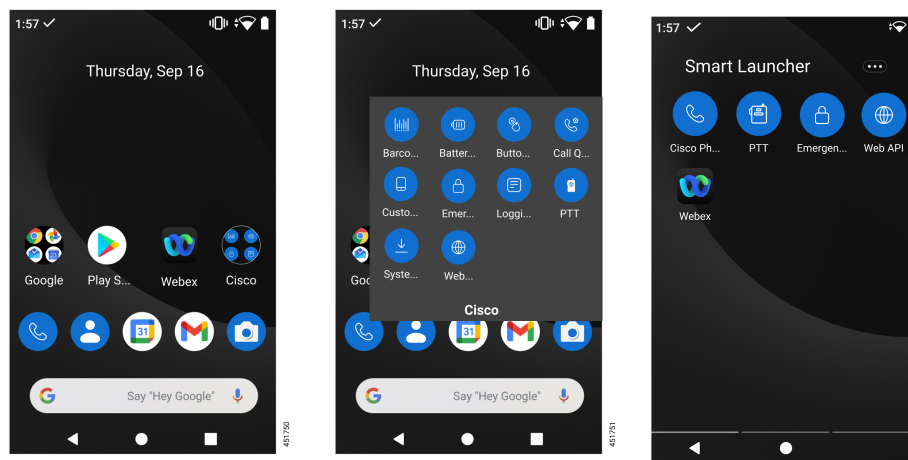

## Customize your launcher screen with widgets and apps

If available, you may be able to customize your launcher screen with widgets and apps. Your administrator may have also programmed a widget box for quick access to certain sites.







## Procedure









- 
- Step 1** (If available) Do one of the following:
- To open the widgets launcher, long press the launcher screen, and tap **Widgets**.
  - To open the apps launcher, swipe up on the screen.
- Step 2** Drag the desired widget or app to the desired location on a launcher screen.
- 

## Cisco apps

These Cisco apps may be available on your phone.

*Table 20: Cisco apps*







Cisco app	Description
	The <b>Cisco Phone</b> app allows you to use full SIP phone call functionality.
	The <b>Barcode</b> app allows you to use the barcode scanner on your 800S phone.
	The <b>Battery Life</b> app displays the current condition of the battery and allows you to adjust the battery alarm volume.
	The <b>Buttons</b> app allows you to program the buttons on your device.
	The <b>Call Quality Settings</b> app allows the administrator to optimize audio and video calls from Cisco dialers or other third-party dialers.
	The <b>Custom Settings</b> app allows the administrator to provide extra controls for the phone.

Cisco app	Description
	The <b>Emergency</b> app allows you to use personal monitoring alarms and emergency calling. Deploy this app in lone worker environments or where you need extra security.
	The <b>Logging</b> app allows the administrator to access various debug options on the phone.
	The <b>PTT</b> app allows you to use a radio multicast app on your device.
	The <b>System Updater</b> app allows you to see the current and available firmware versions for the phone. However, the administrator manages and pushes firmware updates to the phone through the Cisco Unified Communications Manager.
	The <b>Web API</b> app allows developers to interface with external services and provide links to frequently used websites.
	The <b>Smart Launcher</b> app allows the administrator to specify which apps to display on the launcher screen.
	The <b>Device Policy Controller</b> app allows the administrator to specify which apps aren't allowed on the phone.
	The <b>Diagnostics</b> app allows the administrator to perform diagnostics tests quickly and efficiently to verify phone's hardware components.

## Common Android apps

Your phone may include some of these common Android apps, unless the administrator removes them, or turns them off.



Table 21: Common Android apps

Android app	Description
	Contacts
	Gmail
	Calendar
	Camera
	Google Play Store
	Collection of Google apps such as Google, Chrome, Maps, YouTube

## Access the overflow menu of a Cisco app

Each Cisco app uses an overflow menu to display more actions.



### Procedure

- 
- Step 1** Tap the desired app.
- Step 2** Choose one of the following based on your phone's software version:
- For release 1.2(0), tap the **Overflow**  menu.
  - For release 1.3(0) or later, tap the **Drawer**  menu.
- Step 3** Tap the desired menu option.
-

## Access the About option for a Cisco app

The **About** menu option provides information about the app itself, including the version number. You might need to provide this information to the administrator from time to time.

### Procedure

- 
- Step 1** Tap the desired app.
- Step 2** Choose one of the following based on your phone's software version:
- For release 1.2(0), tap the **Overflow**  menu.
  - For release 1.3(0) or later, tap the **Drawer**  menu.
- Step 3** Tap **About**.
- 

## Navigation control

By default, the Cisco Wireless Phone 840 uses gesture navigation control.

By default, the Cisco Wireless Phone 860 uses 3-button navigation control.





**Note** Unless your administrator turns off this setting, you can change the navigation control through **Settings > System > Gestures > System navigation**.

*Table 22: Gesture navigation control for the Cisco Wireless Phone 840*

If you want to...	Action
Return to the home launcher screen from any app.	From the bottom of the screen, swipe up.
View all open apps.	From the bottom of the screen, swipe up one quarter of the screen and pause. Swipe right and left to view all open apps. Tap an app to go to it, swipe up on an app to close it, or tap <b>Clear all</b> to close all apps.

*Table 23: 3-button navigation control for the Cisco Wireless Phone 860*

If you want to...	Action
Go back to the previous screen or app.	Tap <b>Back</b>  .
Return to the home launcher screen from any app.	Tap <b>Home</b>  .

If you want to...	Action
View all open apps.	Tap <b>Recent apps</b> ■. Swipe right and left to view all open apps. Tap an app to go to it, swipe up on an app to close it, or tap <b>Clear all</b> to close all apps.

**Related Topics**

[Access the Settings app](#), on page 111

## Software updates

Unlike consumer-grade Android phones, your administrator manages software updates of both the phone version and of the apps.

- If the administrator sees that your phone software is out of date, they may be able to force an update. A forced update closes all active applications and reboots the phone.
- If the administrator updates an app version, you may notice that app features change without warning. These changes in the app occur because only one version of an app can run at a time.

## Apply software updates

Periodically, your phone connects to a server and downloads an available software update. If your administrator doesn't set your phone to automatically reboot after a software update, you receive a notification to reboot your phone. When you tap **Reboot**, your phone automatically closes all active applications and reboots the phone. You may defer the reboot for a set amount of time.

When the phone connects with the server after the update, the server identifies that the phone update is complete.

### Procedure

---

Tap **Reboot**.

---

## Care of your phone

Your phone is rugged and made for use in tough environments. It's built out of strong and resilient plastics. All components are durable and reliable.

We've extensively tested the phones and warranty them for normal use under rigorous conditions. The Cisco Wireless Phone 840 has an IP65 rating and the Cisco Wireless Phone 860 has an IP68 rating. However, accidental, or inadvertent exposure to various substances can cause the phone to perform poorly or fail completely.

There are many substances that you can't clean off without damaging the device beyond repair. For instance, if you drop your phone into glue or paint, even if you carefully clean the phone, it may not function properly. Also, oil-based substances, such as make-up or lotion, can leave a sticky residue on the phone that attracts and binds particles. This can jam key components such as the camera, microphone, speaker, or headset jack. We don't cover damage from such conditions under warranty. You can prevent or remedy such damage through careful use and proper care and maintenance.



**Warning** There are no serviceable parts in the phone, batteries, or chargers. Don't open or disassemble the phone case, battery, or charger. You void your warranty if you disassemble any of these items.



**Caution** Don't roughly handle the battery contacts when you clean the phone, or you may bend them. If you bend the battery contacts, the phone may not turn on or it may display a battery error.

## Maintenance schedule

It's important to clean your phone regularly so that it functions properly. To set an effective maintenance schedule for your phone, consider the following degrees of exposure and types of substances that may be present in your organization.

**Table 24: Sample exposure levels**

Exposure level	Typical work setting	Potential substances
Light exposure	Normal office settings with desks and chairs and moderately mobile workers.	<ul style="list-style-type: none"> <li>• Paper and fiber lint.</li> <li>• Light soil, dust, and pet hair and dander</li> <li>• Food residue and spills.</li> <li>• Human residue from coughs, sneezes, makeup, lotion, or hair products.</li> </ul>
Medium exposure	Interactive work settings with lots of human contact, such as medical outpatient facilities, restaurants, hotels, light manufacturing, schools, and retail.	<ul style="list-style-type: none"> <li>• All the substances from the light exposure list, in larger quantities.</li> <li>• Possibly some substances from the heavy exposure list.</li> </ul>
Heavy exposure	Highly interactive work with much more human contact and exposure to different types of substances.	<ul style="list-style-type: none"> <li>• All the substances from the light and medium exposure list.</li> <li>• Manufacturing materials such as metal lint and other particulates, various types of fluids, glues and solutions, and waste products.</li> <li>• In-patient medical exposures include body fluids and waste, medical chemicals, drugs, and various residue from medical processes.</li> </ul>

## Maintain your phone

To avoid substances building up on your phone, follow these steps to maintain your phone. How frequently you follow these steps depends on your work environment and exposure to various substances.



---

**Warning**

- Never bend battery contacts.
  - Never submerge your phone into any cleaning solution.
  - Never allow a cleaning solution to pool on the phone or in an orifice.
  - Never spray any solution directly onto the phone.
  - Never mix cleaning agents. The combined effects of cleaning agents are unknown. Mixing chemical agents could seriously degrade the construction of the phone and make it susceptible to damage, even with normal use.
  - Never use furniture polishes, waxes, or plasticizer-based cleaners (ArmorAll®, and so on).
  - Never use lanolin, aloe, glycerin, or other skin care products.
  - Never use hand sanitizers to clean your phone or handle your phone when hands are wet with sanitizer solution.
  - Never apply any solvent such as acetone, mineral spirits, and so on
  - Don't exert undue pressure on the battery contacts on the bottom of the phone and inside the battery compartment. Don't rub, scrub, or use bleach.
- 

### Procedure

---

**Step 1** Turn off the phone and remove the clip and battery.

**Step 2** Spray canned air into crevices and orifices to blow out any lint or dirt.

Always point canned air at an angle away from your face and eyes.

**Warning**

Always wear safety goggles or glasses.

Never insert any instrument into any orifice including the microphone, earpiece, headphone jack, USB plug, reset pin hole, or battery contacts.

**Step 3** Clean surface dirt with soap and water with a damp, lint-free cloth.

You may scrub stubborn spots.

**Warning**

Don't scrub or bend battery contacts.

Don't squeeze water or any liquid into orifices, or a sticky plug can form that blocks the opening. The result may be a significant deterioration in performance.

- Step 4** Wipe off soap film with a different clean damp cloth.
- Step 5** Dry with yet another clean dry cloth.
- Step 6** Wipe battery contacts with a cotton swab dampened with alcohol to remove any lint.
- Step 7** Polish the glass screen, photo lenses, flashlight, fingerprint scanner, and barcode reader (if present) with glass cleaner towelettes.
- Caution**  
Don't exert too much pressure on the glass screen.
- Step 8** Clean the clip and battery separately.
- Step 9** When the phone and battery are completely dry, reinstall the battery and replace the clip.
- Step 10** Use an approved disinfectant to sanitize the device.

---

### Related Topics

[Maintenance schedule](#), on page 33

## Disinfectants

Products listed here are often used to clean and disinfect in medical environments. They are considered safe when used according to solution strength and manufacturer instructions. New products are introduced constantly and generally have similar ingredients. Always follow the manufacturer guidelines for a cleaning or disinfecting product.

**Table 25: Generic liquid products**

Product	Solution strength
Hydrogen peroxide	Use a 3% solution
Bleach	Use a 10% solution (Sodium Hypochlorite 0.55%) <b>Warning</b> Don't use on metal charging contacts.
Isopropyl alcohol	Up to 91% solution

Here are some brand name products that you can use:

- AZOWIPE™
- Brulin BruTab 6S® Tablets
- Clinell© Universal Wipes
- Clorox© Dispatch Hospital Cleaner Disinfectant Towels with Bleach
- Clorox© Formula 409® Glass and Surface Cleaner
- Clorox© Healthcare Bleach Germicidal Wipes
- Clorox© Healthcare Hydrogen Peroxide Wipes
- Clorox© Healthcare Multi-Surface Quat Alcohol WipesDispatch® Hospital Cleaner with Bleach

- Diversey<sup>®</sup> D10<sup>®</sup> Concentrate Detergent Sanitizer
- Diversey<sup>®</sup> Dimension 256 Neutral Disinfectant Cleaner
- Diversey<sup>®</sup> Oxivir<sup>®</sup> Tb Wipes
- Diversey<sup>®</sup> Virex II<sup>®</sup> 256 One-Step Disinfectant Cleaner
- Medipal<sup>®</sup> Alcohol Wipes
- Metrex<sup>®</sup> CaviCide<sup>®</sup>
- Metrex<sup>®</sup> CaviCide I<sup>®</sup>
- Metrex<sup>®</sup> CaviWipes<sup>™</sup>
- Metrex<sup>®</sup> CaviWipes I<sup>®</sup>
- Oxivir<sup>®</sup>
- PDI<sup>®</sup> Easy Screen<sup>®</sup> Cleaning Wipe
- PDI<sup>®</sup> Sani-Cloth AF3<sup>®</sup> Germicidal Disposable Wipe
- PDI<sup>®</sup> Sani-Cloth<sup>®</sup> Bleach Germicidal Disposable Wipe
- PDI<sup>®</sup> Sani-Cloth<sup>®</sup> HB Sani-Germicidal Disposable Wipe
- PDI<sup>®</sup> Sani-Cloth<sup>®</sup> Plus Germicidal Disposable Cloth
- PDI<sup>®</sup> Super Sani-Cloth<sup>®</sup> Germicidal Wipe
- Progressive<sup>®</sup> Products Wipes Plus
- Sani<sup>®</sup> Professional Disinfecting Multi-Surface Wipes
- Sani-Hands<sup>®</sup> Instant Hand Sanitizing Wipes
- SC Johnson<sup>®</sup> Windex<sup>®</sup> Original Glass Cleaner with Ammonia-D
- Spartan<sup>®</sup> Hepacide<sup>®</sup> Quat II
- Sterets<sup>®</sup> Alcowipe<sup>®</sup>
- Steris<sup>®</sup> Coverage Plus Germicidal Surface Wipes
- Veridien<sup>®</sup> Viraguard
- Windex<sup>®</sup> Glass Cleaner

## UV disinfection

Ultraviolet (UV) light from the C spectrum has germicidal properties and is used within specially built chambers to disinfect devices. It is best to use UV-C chambers after you clean a device. In a medical environment, germicidal UV-C is employed as an extra safeguard against Healthcare-Associated Infections or Hospital Acquired Infections (HAIs). Although ultraviolet light destroys viruses, bacteria, and spores it can damage plastics.

Labs conducted extensive testing to determine the durability of Cisco Wireless Phone 840 and 860 when exposed to UV-C. The phones were tested against a UV-C chamber, the AUVS KR615, designed for disinfecting

mobile devices under hospital disinfection protocols. Commonly known as **The UV Box**, the KR615 was developed and is manufactured by Advanced Ultra-Violet Systems and is available through Safety Net.

Due to its superior plastic enclosure and precision manufacturing, the phones exceeded performance expectations and retained full functionality and integrity throughout the tests. We therefore approve germicidal UV-C for disinfecting Cisco Wireless Phone 840 and 860 when used according to both Cisco and UV-C device manufacturer guidelines. For more information about **The UV Box**, visit [Safety Net](#).

## Dry your phone

If your phone is dropped into water or the interior gets wet, you need to take steps to dry your phone.



---

**Warning** Use of an oven or dryer on the phone to speed up drying can damage the phone and voids the warranty.

---



---

**Note** If the phone doesn't work after these steps, contact your administrator.

---

### Procedure

- 
- Step 1** Immediately power off the phone and remove the battery.
  - Step 2** Shake excess liquid from the phone.
  - Step 3** Place the phone and battery in an area that is at room temperature and has good airflow.
  - Step 4** Let the phone and battery dry for 72 hours before you reconnect the battery and power on the phone.
- 

## More help and information

If you have questions about the functions available on your phone, contact your administrator.

For more information about the phones and call control systems, see the [Cisco website](#).

- For quick reference and user guides in English, see the [End-User Guides](#) list.
- For guides in languages other than English, see the [Translated End-User Guides](#) list.

## Accessibility

The phones are hearing aid compatible (HAC) . They support all Android accessibility features. For more information about Android accessibility features, see: [Android Accessibility](#).

## Cisco one-year limited hardware warranty terms

Special terms apply to your hardware warranty and services that you can use during the warranty period.

Your formal Warranty Statement, including the warranties and license agreements applicable to Cisco software, is available at: [Product Warranties](#).

## Battery warranty

There's no warranty for batteries.



---

**Note** If the batteries arrive dead, charge the batteries for at least 8 hours. If they are still dead, submit a request for a return merchandise authorization (RMA).

---

### Related Topics

[Phone battery charging](#), on page 44

## Chargers and Battery packs

### Charging inputs

The Cisco Wireless Phone 860 and 860S are capable of charging at:

- 5VDC at 3A
- 9VDC at 2A
- 12VDC at 1.5A

### Use guidelines

- Do not expose batteries to freezing temperatures or direct sunlight.



## CHAPTER 2

# Phone setup

- [Phone battery installation, on page 39](#)
- [Battery contact damage prevention, on page 43](#)
- [Phone battery charging, on page 44](#)
- [Phone configuration, on page 46](#)

## Phone battery installation

You must read the information in the Product Safety and Security chapter of the User Guide, before you install or charge the battery, or use the phone.

Before you can use your phone, you must install and charge the battery. The battery may already be installed in your phone, or you may have to install it yourself.

To maximize the battery storage capacity and lifespan, fully charge the battery before you turn on and set up the phone.

### Related Topics

[Product Safety and Security](#), on page 137

## Install the battery

Don't install the battery in a dusty or wet environment.

The steps to install the battery are the same for both the Cisco Wireless Phone 840 and Cisco Wireless Phone 860. However, the battery contacts are in different locations on these models, as shown in the following illustration. The illustrations in the steps are of the Cisco Wireless Phone 860.

**Figure 8: Battery contact location on the Cisco Wireless Phone 840 and Cisco Wireless Phone 860**

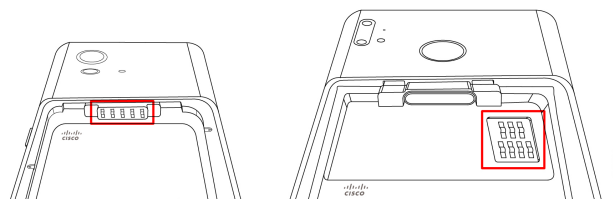

**Warning**

Take care not to damage the battery contacts within the handset when you remove the battery from the handset. Take special care not to touch, compress, or come into contact with the battery contacts in any way or damage may occur.

**Warning**

Use only the Cisco-branded batteries for this phone. If you attempt to use a third-party battery, you will receive an error and the battery will not work. We don't support damage from attempting to use third-party batteries.

**Procedure**

- Step 1** Locate the two battery tabs on the top edge of the battery.

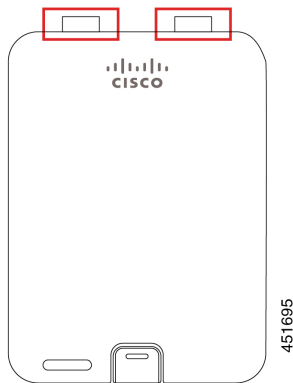

- Step 2** Locate the two slots in the wall at the top of the phone battery compartment.

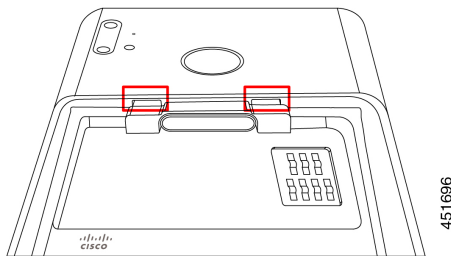

- Step 3** Position the battery at an angle approximately 45–60 degrees to the phone battery compartment. Point the battery edge with the two plastic tabs toward the two slots in the battery compartment.

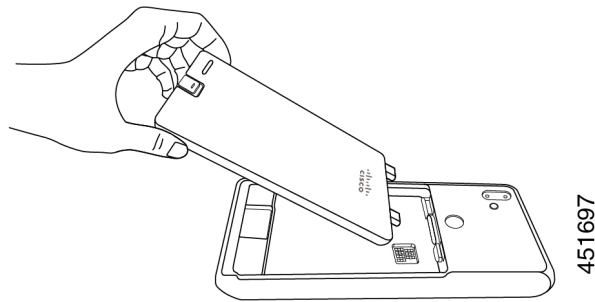

**Step 4** Insert the two plastic battery tabs directly into the two battery compartment slots.

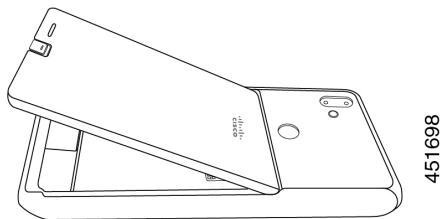

**Step 5** Use the tab and slot contact point as a pivot to lower the battery into the compartment.

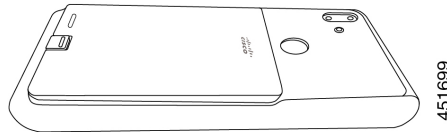

**Step 6** Use your finger to press down until you feel and hear the battery clip snap into place.

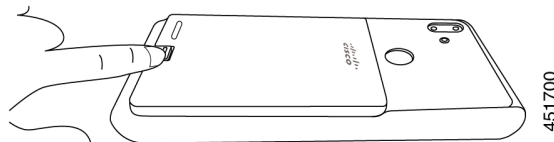

### Related Topics

[Phone battery charging](#), on page 44

## Remove the battery

Battery removal follows a reversed but similar procedure to battery insertion.

The steps to remove the battery are the same for both the Cisco Wireless Phone 860 and Cisco Wireless Phone 840. However, the battery contacts are in different locations on these models. The illustrations in the following steps are of the Cisco Wireless Phone 860.

## Procedure

**Step 1** To disengage the battery clip, gently use a fingernail to depress the clip towards the top of the phone.

**Caution**

Don't pull up on or twist the clip. Don't use a tool, such as letter opener or screwdriver, to pry the clip open. An incorrect prying action with a tool can break the battery clip.

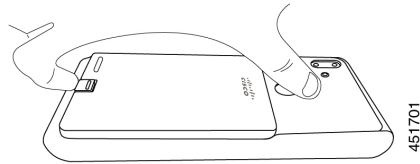

**Step 2** Use your fingernail to lift the battery gently about an eighth of an inch (a few millimeters) out of the battery compartment.

**Step 3** Release the battery clip and grab the battery with your fingers.

**Step 4** Use the battery tabs and battery compartment slots as a pivot point to raise the battery edge out the battery compartment.

**Warning**

Don't slide the battery across the battery compartment because this action may damage the contacts.

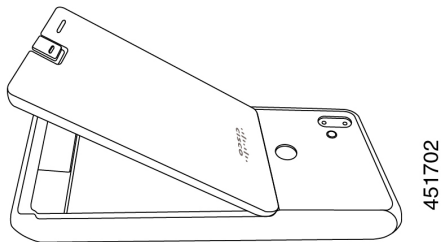

**Step 5** Gently withdraw the battery tabs from the battery compartment slots and lift the battery out of the battery compartment.

**Warning**

Make sure that no part of the battery drags across the battery contacts in the phone.

## Hot swap the battery for Cisco Wireless Phone 860 and 860S

The Cisco Wireless Phone 860 and 860S have a hot swap feature that allows you to continue to use your phone while you change a low battery. During a hot swap, the internal phone battery provides minimum power to allow the phone to remain on.

You can perform a battery hot swap under most normal operations, such as during a voice call or other activity on an active phone screen. Active use of the phone or anything that increases the power draw during a hot swap may, in rare situations, cause the phone to power off.



---

**Caution** If the new battery that you use during the hot swap doesn't have a proper charge, a low battery alert displays and the phone shuts down.

If the internal phone battery isn't awake and charged, the battery hot swap may fail. If the phone was in sleep mode or if you just turned on the phone, the internal battery may not be awake and charged.

---



---

**Note** The Cisco Wireless Phone 840 and 840S don't have an internal battery, so they don't support the hot swap feature.

---

### Before you begin

- Make sure that the new battery that you use during the hot swap has a proper charge.
- If the phone was in sleep mode or if you just turned on the phone, wake and charge the internal battery:
  1. Choose one of the following:
    - If the phone screen was in sleep mode, unlock the phone and wait for 30 seconds.
    - If you just turned on the phone, unlock the phone and wait for 3-5 minutes.
  2. Briefly press the **Power** button to turn off the phone screen and wait for 3-5 seconds.

### Procedure

- 
- Step 1** Remove the battery.
- Step 2** Within 60 seconds, install the new battery.
- 

### Related Topics

- [Install the battery](#), on page 39
- [Remove the battery](#), on page 41
- [Turn on your phone](#), on page 13
- [Unlock your phone](#), on page 13

## Battery contact damage prevention

If you slide or drag part of the battery over the battery contacts during insertion or removal, it may damage the battery contacts.

Damaged battery contacts that can't make proper contact with the contacts in the phone, may cause issues such as:

- The phone won't power on.
- The phone shuts down randomly.
- The phone displays an **Invalid Battery Shutdown** message before it shuts down.

In these failure scenarios, remove the battery from the phone and examine the battery contact fingers and pads.



---

**Note** The battery contacts are in different locations on the Cisco Wireless Phone 840 and Cisco Wireless Phone 860.

---

- Check that the contacts aren't dirty or covered with any substances, or it may prevent a proper electrical connection.
- Check that the contact fingers on the phone are straight relative to the contact base, with all fingers at the same height.

In the following image of the Cisco Wireless Phone 860 battery compartment, the finger on the top left illustrates damage from incorrect battery insertion.

**Figure 9: Cisco Wireless Phone 860 battery contact damage**

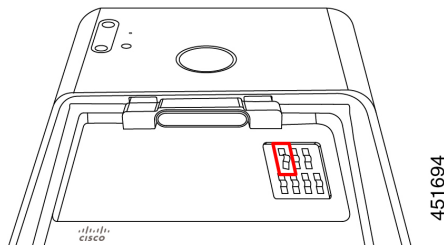

## Phone battery charging



---

**Warning** Explosion hazard: Don't charge the phone battery in a potentially explosive atmosphere. Statement 431

---

You can charge the battery using any of the following options:

- USB cable—You can charge the phone with an Cisco Unified Communications Manager Attendant Console power adapter or your computer.
- Desktop chargers—You can charge a phone and spare battery.
- Multicharger—You can charge several phones or batteries at the same time.

The length of time to charge a phone and battery varies depending on the charge method.

- It takes about 3 hours to charge a phone using the USB cable and AC plug.
- It takes about 8 hours to charge a phone using the USB cable and your computer.
- Under normal conditions, a discharged battery charges fully in approximately 3 hours in a desktop or multicharger.
- If both a phone and battery are in a desktop charger, the phone takes priority. So it takes longer to charge the battery.



---

**Note** Charge your phone batteries in an ambient temperature of 50–86°F (10–30°C) for the best results. If you charge the batteries outside of this temperature range, it results in longer charge times or incomplete charge cycles.

Store the batteries in dry conditions at approximately 65° F (20° C).

---



---

**Caution** Don't let the main battery or the internal battery of your Cisco Wireless Phone 860 or 860S fully deplete for extended periods. If you must store the phone or battery for longer than one month, then we recommend that you fully charge the battery installed in the phone to 100% every six months. Never store a phone without the main battery for longer than one month.

---



---

**Note** Severely damaged battery contact pins are not repairable and not covered under the Cisco warranty. Minor deformation may be remediated by carefully bending the battery contact pins back to the correct position using appropriate tools. Cisco is not responsible for any damage that is caused during this action.

---

#### Related Topics

[Desktop chargers](#), on page 119

[Multichargers](#), on page 123

## Charge the battery with the AC power supply

If you don't have a desktop charger or multicharger, you can charge your phone battery using the USB cable and AC power adapter.



---

**Caution** Use only the approved USB cable and power adapter for the Cisco Wireless Phone 840 and 860.

---

### Procedure

- 
- Step 1** Plug the USB cable into the bottom of the phone with the pins aligned.
  - Step 2** Plug the USB cable into the power adapter.

**Step 3** Plug the power adapter into the electrical outlet.

---

**Related Topics**

[Cisco accessory part numbers](#), on page 129

## Charge the battery with the USB cable and a USB port on your computer

If you don't have a desktop charger, multicharger, or USB cable and AC power adapter, you can charge your phone with a USB cable and computer. However, this method takes more time to charge your phone than the other methods.



---

**Caution** Use only the approved USB cable for the Cisco Wireless Phone 840 and 860.

---

### Procedure

---

**Step 1** Plug the USB cable into the bottom of the phone with the pins aligned.

**Step 2** Plug the USB cable into a USB port on a computer.

---

**Related Topics**

[Cisco accessory part numbers](#), on page 129

## Phone configuration

For your phone to work, it must connect to your organization's Wi-Fi network and call control system.

Phone configuration uses one of these methods:

- Your administrator sets up the phone—You don't need to do any manual configuration. Your administrator may even lock your access to the configuration menus.
- You set up the phone for your Wi-Fi network and connect to the call control system—Your administrator gives you the information that you need to add your phone to the Wi-Fi network and call control system.



---

**Note** If your organization's Wi-Fi network does not contain DHCP Option 150 to direct your phone to the call control system, then you can manually point the phone to the TFTP server for your call control system environment.

---

Once your phone is connected to the Wi-Fi network and call control system, you may want to:

- Configure **Cisco Phone**  app **User settings**, such as ringtones and automatic noise cancellation.
- Pair your Bluetooth® device to the phone.

See [Settings](#) for detailed directions.

## Wi-Fi profile configuration

For an out of box or factory reset phone, you configure the Wi-Fi network through the startup wizard or select **Set up offline**. How you configure the phone offline depends on whether the Wi-Fi network is either:

- Broadcasted
- Nonbroadcast or hidden

### Add the phone to a broadcasted Wi-Fi network

You add the phone to a broadcasted Wi-Fi network through the startup wizard, or offline through the **Settings**  app.

#### Before you begin

Get the following information about the Wi-Fi network from your administrator:

- Network name or Service Set Identifier (SSID)
- Network security mode:
  - None
  - Pre-shared key (PSK)
  - Protected Extensible Authentication Protocol (PEAP)
  - Extensible Authentication Protocol (EAP) Transport Layer Security (EAP-TLS)
  - EAP Tunneled Transport Layer Security (EAP-TTLS)
- PIN or passkey for the security mode, if you use one

Check with your administrator to see if you need any certificates and arrange to install the certificates on your phone.

#### Procedure

- 
- Step 1** Swipe up from the bottom of the phone's display to show the installed applications.
  - Step 2** Tap the **Settings**  app.
  - Step 3** Select **Network & internet > Wi-Fi**.
  - Step 4** Tap the desired Wi-Fi network name.  
If the network doesn't have a security mode, the phone automatically connects to the Wi-Fi network.  
If the network security mode is PSK, enter the 8–63 ASCII or 64 Hex Passphrase.
  - Step 5** For a network with a PEAP, EAP-TLS, or EAP-TTLS security mode, select the **EAP method**: PEAP, TLS, or TTLS.

- Step 6** For a network with an EAP-TLS security mode, select the desired **CA certificate** and **User certificate**.
- Step 7** For a network with an EAP-TTLS or PEAP security mode, select the **Phase 2 authentication** method and **CA certificate** option to use, and then enter the **Identity** and **Password**.
- Step 8** Tap **Connect**.
- 

## Add the phone to a nonbroadcast Wi-Fi network

Follow these steps to add your phone to a Wi-Fi network that is hidden or not broadcast.

### Before you begin

Get the following information about the Wi-Fi network from your administrator:

- Network name or Service Set Identifier (SSID)
- Network security mode:
  - None
  - Wi-Fi Protected Access II (WPA2)-Personal: Pre-shared key (PSK)
  - WPA2-Enterprise with EAP method:
    - Protected Extensible Authentication Protocol (PEAP)
    - Extensible Authentication Protocol (EAP) Transport Layer Security (EAP-TLS)
    - EAP Tunneled Transport Layer Security (EAP-TTLS)
- PIN or passkey for the security mode, if you use one

Check with your administrator to see if you need any certificates and arrange to install the certificates on your phone.

### Procedure

---

- Step 1** Swipe up from the bottom of the phone's display to show the installed applications.
- Step 2** Tap the **Settings**  app.
- Step 3** Select **Network & internet** > **Wi-Fi**.
- Step 4** Tap **Add Network**.
- Step 5** Enter the desired Wi-Fi **Network name**.
- Step 6** Select the desired **Security**:
- For an open network, select **None**.
  - For a PSK enabled Wi-Fi network, select **WPA2- Personal** and enter the 8-63 ASCII or 64 HEX **Password**.
  - For an EAP enabled Wi-Fi network, select **WPA2-Enterprise**.

- Step 7** For a WPA2-Enterprise network, select the **EAP method**: PEAP, TLS, or TTLS.
- Step 8** For a network with an EAP-TLS security mode, select the desired **CA certificate** and **User certificate**.
- Step 9** For a network with an EAP-TTLS or PEAP security mode, select the **Phase 2 authentication** method and **CA certificate** option to use, and then enter the **Identity** and **Password**.
- Step 10** Under **Advanced options**, set **Hidden network** to **Yes**.  
You can also set the **Proxy** and **IP settings** as required.
- Step 11** Tap **Save**.

## Configure a TFTP server

You must configure a TFTP server if your network doesn't provide DHCP option 150 or 66 for the Cisco Unified Communications Manager that you want to register to.







**Note** Configure the DHCP pool with option 150 or 66 if you want to use the automatic configuration method.

### Before you begin

You need the following information:

- **Local Phone Unlock Password**, if the default password was updated
- IP address of the TFTP server

### Procedure

- Step 1** Access the **Cisco Phone**  app.
- Step 2** Choose one of the following based on your phone's software version:
- For release 1.2(0), tap the **Overflow**  menu.
  - For release 1.3(0) or later, tap the **Drawer**  menu.
- Step 3** Choose one of the following based on your phone's software version:
- For release 1.2(0), select **Settings** > **Phone information** > **Security**.
  - For release 1.3(0) or later, select **User settings** > **Phone information** > **Security**.
- Step 4** Enter the **Local Phone Unlock Password**.  
The default password is **\*\*#**.
- Step 5** To enable alternate TFTP servers, swipe the **Alternate TFTP** slider to the right .
- Step 6** Enter the TFTP server addresses and tap **OK**.

- Step 7** Tap the back arrow in the upper left corner twice to save your changes and exit the menu.
- 

## Configure a Call server mode

Cisco Wireless Phone 840 and 860 can operate in either UCM or WxC mode. The phone can be configured both automatically and manually. You can manually select the **UCM** or **WxC** in call server mode and for automatic configuration select **Auto detect**.

Usually, when you select **Auto detect** in Call server mode, the phone tries to connect to UCM using the pre-existing behavior. If the phone gets configuration from a UCM, the phone operates in UCM mode and WxC mode will be disabled. If the phone cannot get configuration from a UCM, the phone tries to get WxC configuration. UCM mode will be disabled if WxC configuration is received. If the phone cannot get configuration for either CUCM or WxC, the phone will retry the auto detection process with a preset backoff schedule.



### Before you begin

You need the following information:

- **Local Phone Unlock Password**, if the default password was updated

### Procedure

---

- Step 1** Access the **Cisco Phone**  app.
- Step 2** For release 1.6(0) or later, tap the **Drawer**  menu.
- Step 3** Select **User settings > Phone information > Security**.
- Step 4** Enter the **Local Phone Unlock Password**.  
The default password is **\*\*#**.
- Step 5** Choose one of the following options in the Call server mode.
- **Auto detect**
  - **UCM**
  - **WxC**
- Step 6** Tap the back arrow in the upper left corner twice to save your changes and exit the menu.
-



## CHAPTER 3

# Cisco Phone app

---

- Cisco Phone app overview, on page 51
- Make calls, on page 53
- Answer calls, on page 55
- End a call, on page 57
- Mute your microphone, on page 57
- Change your audio option, on page 58
- Hold calls, on page 58
- Transfer a call to another person, on page 60
- Call recording, on page 61
- Conference calls, on page 62
- Speed dial, on page 63
- Make multiple calls, on page 64
- Access other apps during an active call, on page 65
- Turn on call forward, on page 65
- Log in and log out of hunt group, on page 67
- Turn Do Not Disturb on and off, on page 67
- Calls log, on page 68
- Contacts, on page 70
- Voicemail, on page 74
- Multiple phone lines, on page 76
- Shared phone lines, on page 78
- Extension mobility, on page 81

## Cisco Phone app overview

The **Cisco Phone** app  provides phone call functionality.



### Caution

Your phone may not function if there is a power failure, since the phone relies on the Wi-Fi network to transmit calls. If the wireless system is down, the Wi-Fi icon on your phone grays out. There may be a time delay between the system failure and the appearance of the registration failure icon. Check with your administrator to see if the wireless system has any protection from power outages.

## Access the Cisco Phone app

You can quickly access the **Cisco Phone**  app from the home launcher screen.



**Note** If the **Cisco Phone** app is the only app on your smart launcher, then it automatically opens when you turn on the phone.





### Procedure

From the home launcher screen, tap the **Cisco Phone**  app.

## Cisco Phone app tabs

When you open the **Cisco Phone**  app, the **Keypad**  tab opens by default.

*Table 26: Cisco Phone app tabs*

Tab	Description
<b>Calls</b> 	Use to view recent and missed calls.
<b>Contacts</b> 	Use to access and add contacts.
<b>Keypad</b> 	Use to make calls.
<b>Voicemail</b> 	Use to access your voicemail messages. This tab appears only if the administrator enables visual voicemail.  <b>Note</b> If the administrator enables and then disables visual voicemail, the <b>Voicemail</b> tab remains on the <b>Cisco Phone</b> app; however, it will not function.

# Make calls

There are multiple ways to quickly make calls with your phone.

## Make a call from the Keypad tab

You can make calls using the **Keypad** .





**Note** When you start entering the first few digits of a phone number, the **Keypad** automatically populates a list of similar phone numbers from your call log and contacts. You can simply select a phone number from the list, rather than entering the rest of the digits in the keypad.

### Before you begin

If you have multiple lines on your phone, outgoing calls are sent from your active line. If you want to make a call from a line other than the currently active line, switch the active line.

### Procedure

- Step 1** Access the **Cisco Phone**  app.
- Step 2** Tap **Keypad** .
- Step 3** Enter a phone number.
- Step 4** Tap **Answer/Call** .

### Related Topics

[Switch the active line](#), on page 77

## Make a call from the Calls, Contacts, or Voicemail tab





You can quickly call a number from either the **Calls** , **Contacts** , or **Voicemail**  tab in the **Cisco Phone**  app.

If your phone has multiple lines, when you dial a number from the **Calls** log, the phone dials the number from the line that originally made or received the call.



**Note** You can set your **Cisco Phone** app to autodial numbers with a single tap.

## Procedure

- 
- Step 1** Access the **Cisco Phone**  app.
  - Step 2** Tap the **Calls** , **Contacts** , or **Voicemail**  tab.
  - Step 3** Tap the desired entry.
  - Step 4** If required, tap **Answer/Call** .
- 

### Related Topics

[Set the phone to autodial](#), on page 110

## Make an emergency call from a locked screen

You can make an emergency call on your phone as long as it's registered to the Wi-Fi network.

If a lock option requires a swipe, pattern, PIN, or password you may be able to make an emergency call without unlocking the phone. However, the administrator can disable emergency calling from the lock screen. Check with your administrator if you have any questions about how your organization deploys emergency calling.

Contact your administrator for more information about the numbers to call in an emergency situation, and how to access them with your phone.

### Related Topics

[Dial an emergency number](#), on page 54

[Select a programmed emergency number](#), on page 55

## Dial an emergency number

When you tap **EMERGENCY** on a locked screen, it opens a Google Dialer where you can enter an emergency number manually. For the call to work, the emergency number you enter must be on the list of preprogrammed emergency numbers that the administrator defines.

These steps bypass the **EMERGENCY INFORMATION** banner and allow you to enter an emergency number. Only emergency numbers are active here.

## Procedure

- 
- Step 1** From the lock screen, tap **EMERGENCY**.
  - Step 2** Enter the emergency number.
  - Step 3** Tap **Answer/Call** .
-

## Select a programmed emergency number

If the administrator has programmed emergency numbers, they are available through the **EMERGENCY INFORMATION** banner.



### Procedure

- 
- Step 1** From the lock screen, tap **EMERGENCY**.
  - Step 2** Tap **EMERGENCY INFORMATION** two times.
  - Step 3** From **Emergency contacts**, tap the desired emergency number.
- 

## Program emergency medical information

You can enter **Medical information** about yourself that may help emergency responders, such as your blood type, allergies, and medication. This information displays on the **Emergency information** screen.

### Procedure

- 
- Step 1** From the lock screen, tap **EMERGENCY**.
  - Step 2** Tap **EMERGENCY INFORMATION** two times.
  - Step 3** Tap **Edit** .
  - Step 4** Enter your PIN or password and tap **Enter** .
  - Step 5** Tap **Add information**.
  - Step 6** Enter your medical information.
- 

## Answer calls

It's easy to answer calls on your phone, regardless of what you are currently doing on the phone. If you receive a call while, you're:

- On the **Cisco Phone**  app, home screen, or if your phone is in sleep mode, your ringtone sounds and an incoming call screen displays.
- On an active call, an in-ear tone sounds and a heads-up notification appears.
- On an active app screen, a heads-up notification appears to ensure that the incoming call doesn't interrupt your current work.



---

**Note** A superscript number 1 or 2 on the phone icon indicates whether the call is on Registration 1 or Registration 2. This indication can help you prioritize your calls. For example, your organization may use Registration 2 for all urgent call alerts.

---

If your phone uses release 1.3(0) or later, your administrator may configure your phone to automatically answer calls after a ring or two. Check with your administrator for more information.

## Answer a call

If you're on an active call and a second call comes in, you can answer the second call. Answering the second call automatically places the first call on hold.



---

**Note** If your phone has multiple lines, the incoming call notification displays the caller and which line they are calling.

---

### Procedure

---

Do one of the following actions:

- From an incoming call screen, swipe **Answer/Call**  to the right.
  - From an incoming call notification, tap **Answer**.
- 

## Decline a call

If you don't want to answer an incoming call, you can decline the call. Declined calls appear in the missed calls log, and go to voicemail, if configured.

### Procedure

---

Do one of the following:

- From an incoming call screen, swipe **Decline**  to the left.
  - From an incoming call notification, tap **Decline**.
-

## Ignore a call

If you're too busy to answer or decline an incoming call, you can simply ignore the call. Ignored calls appear in the missed calls log, and, if configured, go to voicemail.



**Note** If you swipe up to ignore an incoming call notification, new heads up notifications don't appear for several minutes. To avoid this scenario, use the **Answer** or **Decline**  option.

### Procedure

---

Ignore the incoming call screen or notification.

---

## End a call

### Procedure

---



From the active call screen, tap **End** .

---

## Mute your microphone

During an active call, the action bar displays the **Mute**  button. When you mute your microphone, the color of the **Mute** button changes to blue.



### Procedure

- 
- Step 1** From the active call screen, tap **Mute** .
- Step 2** To unmute your microphone, tap **Mute**  again.
-

# Change your audio option

The **Phone**  receiver speaker is the default audio speaker that you use when you hold the phone to your ear. You can switch the audio option while on an active call.

The following audio options are also available:

- **Headphones** 
- **Speaker** 
- **Bluetooth** 

## Before you begin

If you plan on using a Bluetooth® device, connect the Bluetooth device to your phone.

## Procedure

---

**Step 1** From the active call screen, tap **Audio options** .

**Step 2** Select the desired available audio option:

- **Headphones** 
- **Speaker** 
- **Bluetooth** 
- **Phone** 

---

## Related Topics

[Pair a Bluetooth device](#), on page 112



# Hold calls

You can put an active call on hold and then resume the held call when you're ready.

## Hold a call

During an active call, you may need to put a caller on hold. When you put a caller on hold, the color of the **Hold** button changes to blue.

## Procedure

- 
- Step 1** From the active call screen, tap **Hold** .
- Step 2** To return to the held call, tap **Hold** .
- 

## Swap between active and held calls

You can have up to four calls on your phone line. However, only one call can be active at a time, with the other calls on hold.

When you're on an active call, you can access a held call. The phone places the original call on hold.

## Procedure

---

From the **Cisco Phone**  app, tap the desired held call.

---

## Send a call to voicemail

There may be times that you want to send the person you're talking with to your voicemail. If enabled by your administrator, you may divert an active call to your voicemail. When diverted, your line becomes available to make or receive calls.

## Procedure

- 
- Step 1** From the active call, tap the **Overflow**  menu.
- Step 2** Tap **Send call to voicemail**.
- 

## Call park

If enabled by your administrator, you can temporarily store, or park, a call and pick it up on another phone in your call control system.

When you park a call, a pop-up on your phone confirms that the call is parked and includes the call extension and call park number. You need the call park extension number to pick the call up on another phone.

The parked number displays as a notification on your phone until:

- Someone retrieves the call.
- The caller abandons the call.

- The Forward No Retrieve feature redirects the call.

## Park a call

You can park an active call on your phone and then use another phone in the call control system to retrieve the call. You can park only one call at the call park number.

### Procedure

---

- Step 1** From an active call, tap the **Overflow**  menu.
- Step 2** Tap **Park call**.
- 

## Retrieve a call from call park

You, or someone else, can retrieve a call from call park from any eligible phone.

### Before you begin

You need the call park extension number.

### Procedure

---

Do one of the following:

- From the phone that parked the call, tap the parked call notification.
  - From another phone that is eligible to pick up the parked call, use the **Cisco Phone**  app to dial the call park extension number.
- 

## Transfer a call to another person

During an active call, you may want to transfer the caller to someone else. When you transfer a call to someone else, it automatically puts the original call on hold.

If the call transfers successfully, meaning the other person answers the call:

- The original call connects to the other person, without you.
- You're dropped from the call automatically and go back to the screen that you were on before the original call.

If the call doesn't transfer successfully, the first call is still on hold.



**Note** To consult with the transferee before handing off the call, or to introduce the two parties, follow the steps to create a conference call.

## Procedure

- 
- Step 1** From the active call screen, tap **More**
- Step 2** Tap **Transfer to number**
- Step 3** Enter the number to call or select an entry from your recent **Calls**.
- Step 4** Tap **Transfer**
- 

# Call recording

Call recording allows you to record a voice conversation over a phone. Call recording behaves the same as other Cisco IP phones and recordings are saved to the Dubber. Currently call recording is only supported when your phone is registered to WebEx.

There are three modes for call recording. There is the always record option, never record option, on-demand option. Also with or without announcements.

- **Always**—Records every incoming and outgoing call.
- **Never**—Records no call.
- **On Demand**—Allows you to manually record phone calls at any time with the press of a button.

For release 1.8(0) or later, There are three modes for call recording. They are automatic, disabled, and selective.

- **Automatic**—Records every incoming and outgoing call.
- **Disabled**—Records no call.
- **Selective**—Allows you to manually record phone calls at any time with the press of a button.

## Procedure

- 
- Step 1** Access the **Cisco Phone** app.
- Step 2** For release 1.6(0) or later, tap the **Drawer** menu.
- Step 3** Select **Features** > **Call recording**.
- Step 4** Choose one of the following based on your phone's software version:
- For release 1.6(0) or later, choose one of the following call recording options.

- **Always**
  - **Never**
  - **On Demand**
- For release 1.8(0) or later, choose one of the following call recording options.
    - **Automatic**
    - **Disabled**
    - **Selective**

**Step 5** Tap the back arrow in the upper left corner twice to save your changes and exit the menu.

---

## Conference calls



A conference call is when you and at least two other parties can converse at once. Your administrator sets the maximum number of conference call participants. Contact your administrator to find out how many conference call participants that you can have on a call. By default, your phone supports a maximum number of four participants in a conference call—you and three others.

### Add a call to create a conference

During an active call, you can add more callers to create a conference call. When you add a new call, the active call is automatically held.

#### Procedure

---

- Step 1** From the active call screen, tap **More** .
  - Step 2** Tap **Add call**.
  - Step 3** Enter a number to call.
  - Step 4** Tap **Add** .
  - Step 5** After the person answers, tap **More**.
  - Step 6** Tap **Merge** .
  - Step 7** Tap the held call that you want to join into the conference.
  - Step 8** Tap **Merge**.
  - Step 9** Repeat steps 1–8 for each additional participant.
-

## End a conference call



There are two ways to end a conference call.

- You can hang up on both called parties at once.
- You can split the conference call into two separate calls, both on hold. Split the call if you want to end the call with one participant and continue the call with the other party. Or you can carry on separate conversations alternately or merge them back into a conference call.

### Procedure

---

Do one of the following:

- To end the call with both active callers, tap **End** .
  - To split the conference call into two separate calls, tap **More** , and then tap **Split**.
- 

## Speed dial

Speed dial allows you to quickly dial phone numbers that you frequently call.

### Set up speed dial

You can set up to nine numbers as speed dial numbers. You can change your speed dial numbers as often as you like.



If configured, the administrator may assign voicemail to number **1** .

#### Before you begin

To add a number to speed dial, the number must be in your contacts list.

### Procedure

---

- Step 1** Access the **Cisco Phone**  app.
- Step 2** Choose one of the following based on your phone's software version:
- For release 1.2(0), tap the **Overflow**  menu.
  - For release 1.3(0) or later, tap the **Drawer**  menu.
- Step 3** Choose one of the following based on your phone's software version:
- For release 1.2(0), tap **Speed dial**.

- For release 1.3(0) or later, select **Features > Speed dial**.

**Step 4** Tap a speed dial number to assign.

**Step 5** From the contacts list, tap the contact that you want to assign to the speed dial number.

---

#### Related Topics

[Add a contact to your favorites](#), on page 73

## Make a call using speed dial

Use these steps to call a contact on your speed dial list.

#### Before you begin

- Add a contact number to your speed dial list.
- If you have multiple lines on your phone, ensure that the line that you want to call from is active.

#### Procedure

---

**Step 1** Access the **Cisco Phone**  app.

**Step 2** Tap **Keypad** .

**Step 3** Long-press the desired speed dial number.

---

#### Related Topics

[Switch the active line](#), on page 77

[Set up speed dial](#), on page 63

## Make multiple calls

If permitted in your organization, you can have up to four calls on your phone line. However, only one call can be active at once, with the other calls on hold. When you add a call from an active call, the active call is automatically held.

#### Procedure

---

**Step 1** While in an active call, tap **More** .

**Step 2** Tap **Add call** .

**Step 3** Use any method to populate the keypad dialer for a call to the target party.

**Step 4** Tap **Answer/Call** .

---

## Access other apps during an active call

You may want to do something else on your phone while in an active call. For instance, if available, you might want to check your calendar or email or browse for an address. You can do any of these activities and continue the conversation with your active call.

### Procedure

---

- Step 1** Navigate away from the active call screen.
- Step 2** Access and use the desired app.
- Step 3** To return to the active call screen, do one of the following:
- Swipe down on the status bar and tap the active call notification.
  - Access the **Cisco Phone**  app and tap the green active call notification bar.
- 

### Related Topics

[Navigation control](#), on page 31

## Turn on call forward

You can use call forward to redirect calls to another number. When enabled, the call forward feature routes all your incoming calls to a different number and your phone doesn't ring at all. A call forward notification appears in the line label when call forward is on.

The call server tracks the call forwarding status of your extension. Therefore, call forward works even if your phone is off or out of range.

If you forward calls on a shared line, it forwards all calls to that line. Anyone with the shared line can turn off call forward at any time.



---





**Note** The administrator can disable call forward. If you don't see the **Call forward** option, check with your administrator.

---

### Before you begin

If you have multiple lines on your phone, ensure that you set the desired line to active.

## Procedure

- 
- Step 1** Access the **Cisco Phone**  app.
- Step 2** Choose one of the following based on your phone's software version:
- For release 1.2(0), tap the **Overflow**  menu.
  - For release 1.3(0) or later, tap the **Drawer**  menu.
- Step 3** Select **Features** > **Call forward**
- Step 4** Swipe the **Enable call forward**  slider to the right.
- Step 5** Enter the number to receive your calls, or select an entry from your **Contacts** list.
- Step 6** Tap **Save**.

---

### Related Topics

[Switch the active line](#), on page 77

## Turn off call forward





Turn off call forward when you want to receive calls again.

If call forward is on a shared line, anyone with that shared line can turn off call forward.

### Before you begin

If you have multiple lines on your phone, ensure that you set the desired line to active.

## Procedure

- 
- Step 1** Access the **Cisco Phone**  app.
- Step 2** Choose one of the following based on your phone's software version:
- For release 1.2(0), tap the **Overflow**  menu.
  - For release 1.3(0) or later, tap the **Drawer**  menu.
- Step 3** Select **Features** > **Call forward**.
- Step 4** Swipe the **Enable call forward**  slider to the left.
- Step 5** Tap **Save**.

---

### Related Topics

[Switch the active line](#), on page 77

## Log in and log out of hunt group

Hunt groups, also known as line groups, allow organizations that receive many incoming calls to share the call load. Your administrator sets up a hunt group with a series of directory numbers. Phones ring based on the hunt sequence that your administrator specifies for a hunt group. If you're a member of a hunt group, you can:

- Log in to the hunt group when you want to receive hunt group calls.
- Log out of the hunt group when you no longer want to receive hunt group calls.



---



**Note** **Hunt group** appears on the **Features** menu only if the administrator enables the hunt group log in and log out feature. If you're unsure whether your extension is in a hunt group, check with your administrator.

---

### Before you begin

If you have multiple lines on your phone, ensure that you set the desired line to active.

### Procedure

- 
- Step 1** Access the **Cisco Phone**  app.
- Step 2** Choose one of the following based on your phone's software version:
- For release 1.2(0), tap the **Overflow**  menu.
  - For release 1.3(0) or later, tap the **Drawer**  menu.
- Step 3** Select **Features** > **Hunt group** to toggle between logged in and logged out.

---

### Related Topics

[Switch the active line](#), on page 77

## Turn Do Not Disturb on and off

If you don't want your phone to disturb you, you can enable **Do Not Disturb**. **Do Not Disturb** silences all alerts and notifications, and send calls to voicemail, if enabled.

### Procedure

- 
- Step 1** Swipe down on the status bar to open the quick settings.

**Step 2** Tap **Do Not Disturb**  to turn this feature on and off.

---

## Set Do Not Disturb options

If enabled, you can set various **Do Not Disturb** options. For example, you can allow:

- Audio for sounds, media, or touch sounds
- Calls or messages from certain people in your contacts or favorites
- Calls from repeat callers
- Task or event alerts
- App reminders

Check with your administrator if **Do Not Disturb** option settings aren't available to you.



### Note



You can also access the **Do Not Disturb** settings from the **Settings**  app, under **Sound**.

---

## Procedure

- 
- Step 1** Swipe down on the status bar.
- Step 2** Tap and hold **Do Not Disturb**  for a second or two.
- Step 3** Set your desired **Do Not Disturb** settings.
- 

## Calls log

The **Calls**  log tab on the **Cisco Phone**  app displays your **Recent** incoming and outgoing calls and **Missed** calls. From the **Calls** log tab, you can quickly call a recent caller and add a recent caller to your contacts.



If your phone has multiple lines, when you view the **Calls** log, there is a numbered, round color code that is associated with each call. This color coding shows which line made or received each call.

## View your recent or missed calls



**Note** If a recent caller is already in your Contacts list, you can access the Contact details from the **Calls** log entry. To view the Contact details, long-press the entry and tap the **Show contact** popup.

### Procedure

- Step 1** Access the **Cisco Phone**  app.
- Step 2** Tap **Calls** .
- Step 3** Tap **Recents** or **Missed**.

### Related Topics

[Make a call from the Calls, Contacts, or Voicemail tab](#), on page 53

## Add a recent caller to your contacts

### Before you begin

From the **Cisco Phone**  app, tap the **Calls**  log.



### Procedure

- Step 1** Long press the desired **Calls** log entry.
- Step 2** Tap **Add to contacts**.

## Clear the call log

You can clear all of the recent and missed calls from your **Calls**  log.

### Procedure



- Step 1** Access the **Cisco Phone**  app.
- Step 2** Choose one of the following based on your phone's software version:
  - For release 1.2(0), tap the **Overflow**  menu.

- For release 1.3(0) or later, tap the **Drawer**  menu.

**Step 3** Tap **Clear call log**.

**Step 4** Tap **OK**.

## Contacts

The **Contacts**  tab on the **Cisco Phone**  app displays all your contacts, so that you can quickly make calls. The **Contacts** tab may include these lists:

- **Favorites**—Add contacts who you frequently call to your favorites list.
- **Local contacts**—Add contacts directly to your phone. Use this list if you don't have a personal or corporate directory. However, if you share a phone, your local contacts stay on the phone even after you log out.
- **Personal directory**—If enabled, add contacts to your personal directory on the call control system, instead of locally on the phone. So, if you share phones, you can access your personal directory contacts from any phone in your network. When you log out, the contacts are no longer on the phone.

Although not listed on the **Contacts** tab, if enabled you can search for contacts in the **Corporate directory**. The corporate directory includes all the contacts in your company. The call control system stores these contacts, so that you can access them from any phone in your network.

### Related Topics

[Search for contacts](#), on page 71

## Log in to your personal directory

When you log in to your personal directory, the phone stores all your personal directory contacts until you log out of the personal directory. When you log out of your personal directory, it removes the personal contacts from the phone.



**Note** Your personal contacts automatically update from the server every two hours. If you add a personal contact through the Self Care portal and want it to immediately appear on the phone, tap **SYNC NOW** from your **Personal directory** on the phone.

### Before you begin

Get your user ID and PIN for your personal directory from your administrator.

### Procedure

**Step 1** Access the **Cisco Phone**  app.

**Step 2** Tap **Contacts** .

**Step 3** Tap **Personal directory**.

**Note**

If the personal directory login prompt doesn't appear, tap **Personal directory** again to expand.

**Step 4** Enter your user ID and PIN.

**Step 5** Tap **Login**.

Your phone pulls all your personal contacts from the server to the phone.

---

## Search for contacts

You can search for people from your **Calls** log, your local contacts, and if configured, your personal and corporate directories.

### Procedure

---

**Step 1** Access the **Cisco Phone**  app.

**Step 2** Tap **Contacts** .

**Step 3** Tap **Search** .

**Step 4** Enter your search criteria (full or partial name or number).

**Step 5** From the search results list, tap the desired contact.

---

## View details about your contacts

You can look up details about your contacts.

### Procedure

---

**Step 1** Access the **Cisco Phone**  app.

**Step 2** Tap **Contacts** .

**Step 3** Tap the desired contact from your **Favorites**, **Local contacts**, **Personal directory**, or **Corporate directory**.

---



## Add a new local or personal directory contact

You may have many contacts who you call frequently who aren't part of your organization or corporate directory. You can add those people to your:

- **Local contacts**—Stores your personal contacts on your phone.
- **Personal directory**—If enabled, stores your personal contacts on the call control system.





### Note

You can also create a new local or personal directory contact from the **Cisco Phone**  app **Calls**  or **Keypad**  tabs.

### Before you begin

Log in to your personal directory if you want to add a contact there.

### Procedure

- 
- Step 1** Access the **Cisco Phone**  app.
- Step 2** Tap **Contacts** .
- Step 3** Tap **Add** .
- Step 4** If you're logged in to your personal directory, choose one of the following at the **Create contact in** prompt.
- To create a local contact, tap **Local contacts**.
  - To create a personal directory contact, tap **Personal directory**.

- Step 5** Enter the contact information.

### Note

Include a phone number to save a local contact. If you don't include a name, the phone number displays in the local contact list.

Include both a display name and phone number to save a contact in your personal directory.

- Step 6** Tap **Save**.

### Related Topics

[Log in to your personal directory](#), on page 70

## Edit a local or personal directory contact

Edit your local or personal directory contacts if their contact information changes.



### Before you begin

To edit a personal directory contact, log in to your personal directory.



**Note** If the personal directory login prompt doesn't appear, tap **Personal directory** again to expand.

### Procedure

- 
- Step 1** Access the **Cisco Phone**  app.
  - Step 2** Tap **Contacts** .
  - Step 3** Tap the desired contact.
  - Step 4** Tap **Edit** .
  - Step 5** Edit the desired contact information.
  - Step 6** Tap **Save**.

---



#### Related Topics

[Log in to your personal directory](#), on page 70

## Add a contact to your favorites

You can set up to 10 contacts as your Favorites. The **Favorites** list appears at the top of the **Contacts**  tab for quick access.



### Procedure

- 
- Step 1** Access the **Cisco Phone**  app.
  - Step 2** Tap **Contacts** .
  - Step 3** Tap the desired contact.
  - Step 4** Tap **Add favorite**.
- 

## Remove a contact from your favorites

It's easy to remove a contact from your **Favorites** list.

## Procedure

- 
- Step 1** Access the **Cisco Phone**  app.
  - Step 2** Tap **Contacts** .
  - Step 3** Tap the desired contact.
  - Step 4** Tap **Remove favorite**.
- 





## Delete a local or personal directory contact

You can delete local or personal directory contacts if you don't need them anymore.

### Before you begin

To delete a personal directory contact, log in to your personal directory.

## Procedure

- 
- Step 1** Access the **Cisco Phone**  app.
  - Step 2** Tap **Contacts** .
  - Step 3** Tap the desired contact.
  - Step 4** Tap **Edit** .
  - Step 5** Tap the **Overflow**  menu.
  - Step 6** Tap **Delete contact**.
  - Step 7** Tap **Delete**.
- 

## Voicemail

If your organization enables voicemail, you receive new voicemail notifications in the status bar.

If your organization enables visual voicemail, your **Cisco Phone**  app includes a **Voicemail**  tab where you can manage your voicemail messages.





---

**Note** If your organization enables and then disables visual voicemail, the **Voicemail** tab remains on the phone, although it is not active.

---

If your phone has multiple phone lines with voicemail configured, you can access voicemail on all lines. However, visual voicemail is available only for your first line.

## Access voicemail messages

When you receive a voicemail message, the voicemail icon  appears in the status bar.

### Before you begin

If you have multiple lines on your phone, switch to the desired phone line before you use the **Keypad**  to check voicemail.



### Procedure

---

**Step 1** Choose one of the following:

- Swipe down on the status bar and tap the **Voicemail waiting** notification.

**Note**

If your organization enables visual voicemail and you tap the **Voicemail waiting** notification, the dialer opens rather than the **Voicemail**  tab. If you want to use visual voicemail to manage the message, access the **Voicemail** tab on the **Cisco Phone**  app.

- If configured, long press **1**  on the **Cisco Phone**  app **Keypad**  to dial the voicemail retrieval number.



**Step 2** Follow the prompts to retrieve the voicemail.

---

### Related Topics

[Switch the active line](#), on page 77

## Access visual voicemail

If the administrator enables visual voicemail on your phone, a **Voicemail**  tab in the **Cisco Phone**  app provides a list of your voicemail messages.



---

**Note** If you have multiple lines, visual voicemail is available only for your first line.

---

The messages display in order with the newest messages on top. Sender extension number and duration of message display. You can play, save, or delete each message. Unheard messages display in bold type. Played messages display in regular type. Leave the message on the list to save it on your phone.



---

**Note** If the administrator enables and then disables visual voicemail, the **Voicemail** tab remains on the **Cisco Phone** app; however, it will not function.

---

## Procedure

---

**Step 1** Access the **Cisco Phone**  app.

**Step 2** Tap the **Voicemail**  tab.

**Step 3** Tap the desired message.

**Step 4** To play the message audio through a media player with sound options, tap **Play** .

**Note**

If desired, you can also pause  the message, or use the slider to move to a certain place in the message.

**Step 5** To delete the message, tap **Delete** .

---

## Multiple phone lines

If you are responsible for, or rotate between, multiple departments in your organization, you may need access to multiple lines on your phone. If your phone uses release 1.3(0) or later, you can have up to six separate lines on your phone. You can make and receive calls on all your lines.

Each phone line has a different numbered and colored circle that is associated with it. The extension number appears to the right of the circle. If configured, line names appear with the extension number.

If your phone has a secondary registration line, it appears with **R2**  in the colored circle.

**Figure 10: Multiple lines**

## View registered lines

You can view details about your registered phone lines from the notification drawer.

The notification drawer lists all primary line numbers under the heading **UCM - SIP registered** and if you have a secondary registration, it lists the line after the heading **R2: SIP registered**.

You can also access more details about your phone lines, such as any line text labels and whether you have multiple or shared lines.



### Before you begin



Ensure that you register your phone to the call control system; and the check mark ✓ appears in the status bar.

### Procedure

- 
- Step 1** Swipe down on the status bar to view the notification drawer.
  - Step 2** Tap the registration notification to view more details about each line.
- 

## Switch the active line

If you have multiple lines on your phone, only one line is active at a time. The active line appears to the right of the **Drawer**  menu on the **Cisco Phone**  app.

When you make a call from the **Keypad**  or **Contacts**  tab, the phone sends the call from the active line. To make a call from another line, first switch the active line.



**Note** When you switch lines to make an outgoing call, that line remains the active line for outgoing calls unless you switch lines again.

The active line for outgoing calls has a check mark ✓ next to it.



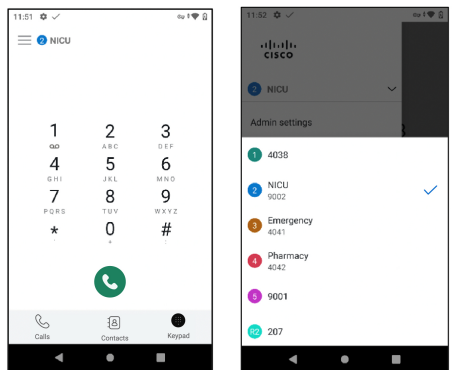

**Note** Another way to quickly view all lines is to swipe right on any tab in the **Cisco Phone** app.

**Figure 11: Active line among multiple lines**



## Procedure

- Step 1** Access the **Cisco Phone**  app.
- Step 2** Tap the **Drawer**  menu.
- Step 3** Tap the up arrow  to the right of the active line to view the other lines on the phone.
- Step 4** Tap the line number that you want to make active.

### Note

To exit this screen without changing the active line, tap the down arrow  to the right of the active line, or tap outside of the screen.

## Shared phone lines

If your phone uses release 1.3(0) or later, you can share the same phone number with one or more of your coworkers. For example, as a nurse, you may share a phone line with all the other nurses in your unit.

When someone calls a shared line, all the phones that share the line ring, and anyone with that shared line can answer the call. When someone answers the call, a **Shared line is in use** notification appears on the other phones.

You may also have multiple shared lines on your phone. A **Shared line** label appears next to each shared line under your registered accounts.

## Add yourself to a call on a shared line

If a coworker answers a call on a shared line, you or others on the shared line can also join the call. The call then becomes a conference call.

However, if the privacy settings on the phone of the person who first answered the call are on, no one else can join the call.

### Procedure

---

- Step 1** Access the **Cisco Phone**  app.
  - Step 2** Tap **CBARGE** on the **Shared line is in use** notification.
- 

## Resume a held call on a shared line

If a coworker answers a call on a shared line and then puts the caller on hold, you or others on the shared line can pick up the call.

However, if the privacy settings on the phone of the person who first answered the call are on, no one else can pick up the held call.

### Procedure

---

- Step 1** Access the **Cisco Phone**  app.
  - Step 2** Tap **RESUME** on the **Shared line is in use** notification.
- 

## View multiple shared lines in use

When multiple shared lines are in use on a phone, you can see the message **Shared line has multiple active calls** from the **Cisco Phone**  app.

## Procedure

- 
- Step 1** Access the **Cisco Phone**  app.
- Step 2** Tap **SHOW ALL** on the **Shared line has multiple active calls** notification.
- 



## Enable privacy on a shared line

If you have a shared line on your phone, you can enable privacy settings so that if you answer a call, your coworkers who share the line can't:

- Join the call through **CBARGE** or **RESUME**.
- See who is on the call.

This privacy feature is useful if you are expecting a private call to a shared line. When enabled, a check mark appears next to the **Privacy** feature in the **Cisco Phone**  app.

## Procedure

- 
- Step 1** Access the **Cisco Phone**  app.
- Step 2** Tap the **Drawer**  menu.
- Step 3** Select the desired shared line.
- Step 4** Select **Features** > **Privacy**.
- Step 5** (Optional) Repeat steps 1–3 to disable the privacy feature.
- 

## Enable limited privacy on a shared line

From an active call on a shared line, you can enable a limited privacy setting that prevents your coworkers from picking up a call when you put it on hold. This setting is a useful way to let your coworkers on the shared line know that you don't want them to pick up the call when you put it on hold. The call notification on your coworkers' phones doesn't include **RESUME**.

However, while you are on the call, others may still join with **CBARGE**.





---

**Note** Follow these steps before you place the call on hold.

---

## Procedure

- 
- Step 1** From an active call on a shared line, tap the **Overflow**  menu.
- Step 2** Tap **Select**.
- 

## Extension mobility

If your phone uses release 1.3(0) or later, your administrator may enable the extension mobility feature. Through a log in process, extension mobility allows you to access your phone lines, features, and settings on different phones. This feature allows workers who are on different shifts to share the same physical phone, yet keep their own profile settings.

If your phone uses release 1.4(0) or later, your administrator may enable extension mobility across phone clusters, also known as extension mobility cross cluster (EMCC). EMCC allows you to log in to a phone on another remote cluster, such as a different location within your organization, and keep your phone settings.



## Log in to extension mobility

When you log in to extension mobility or extension mobility cross cluster (EMCC) on a phone, the phone adopts your user profile, including your phone lines, features, and settings.



- 
- Note** For release 1.4(0) or later, if your phone doesn't have a directory number (DN), but has extension mobility services, when you open the phone app, the login prompt for extension mobility services appears.
- 

## Procedure



- 
- Step 1** Access the **Cisco Phone**  app.
- Step 2** Tap the **Drawer**  menu.
- Step 3** Select **Features** > **Applications**.
- Step 4** Tap the extension mobility service.
- Step 5** Enter your user ID and PIN.
- Step 6** (Optional) Select the desired device profile, if multiple profiles exist.
- Step 7** Tap **Submit**.
-

## Log out of extension mobility

When you log out of extension mobility or extension mobility cross cluster (EMCC), the phone returns to the default profile configuration settings.

### Procedure

---

- Step 1** Access the **Cisco Phone**  app.
  - Step 2** Tap the **Drawer**  menu.
  - Step 3** Select **Features > Applications**.
  - Step 4** Tap the extension mobility service.
  - Step 5** Tap **Yes** to log out of extension mobility.
-



## CHAPTER 4

# Emergency app

---

- [Emergency app overview, on page 83](#)
- [Emergency motion conditions, on page 84](#)
- [Emergency and panic button, on page 86](#)

## Emergency app overview

The **Emergency**  app is a personal safety application that can help you get help during any incident where you may require immediate attention. If used in your organization, the **Emergency** app can:

- Monitor your motion and automatically alarm if your movement indicates that you may need assistance.
- Provide a **Panic Button** that you can easily use to signal that you need emergency assistance.

The **Emergency** app motion condition monitoring and **Panic Button** can also work with a security alarm application program. Security alarm application programs can receive alarms and identify the phone, the user, and the location of the phone with the alarm.



---

**Caution** It's critical that you know what the **Emergency** app and **Panic Button** do when you activate them, either intentionally or unintentionally. You can't permanently disable or turn the **Emergency** app on or off. For information about the setup of the **Emergency** app in your organization, contact your administrator.

---

**Warning**

The effectiveness of the **Emergency** app depends on many factors, so it's critical that the administrator thoroughly tests the system. The **Emergency** app depends on the functionality and reliability of the physical infrastructure:

- Wireless LAN
- LAN
- Call server
- Application management server
- Server hosting the location services
- Central security system and its servers

The **Emergency** app also depends on the correct configuration of the phones, configuration and installation of the **Emergency** app, and appropriate training.

## Emergency motion conditions

Based on your facility requirements, your administrator may configure your phone to monitor the following three **Emergency** motion conditions by sensitivity level.

- **Running**—The phone detects shaking when you run for a configurable number of seconds.
- **Tilt**—The phone isn't vertical for a configurable number of seconds.
- **No movement**—The phone is still for a configurable number of seconds, potentially indicating that you're no longer moving.

If any of the **Emergency** motion conditions occur, the phone first warns you about an impending alarm. If you don't cancel the warning within a configurable number of seconds, the phone:

- Starts to alarm.
- If configured, places an emergency call.

**Note**

An emergency call ends any active call.

## Cancel motion conditions warning

If the phone detects an Emergency motion event, the phone goes into a warning state and displays a yellow **Warning** screen. The **Warning** screen shows the type of event and sounds an alert, increasing the volume as the warning timeout counts down.

If you cancel the warning, the phone turns off the audio alert, doesn't send an alarm, and resumes monitoring motion.



---

**Note** While in the warning state, you can still use the phone for any other operation. However, the warning continues until you cancel it. To return to the warning screen, pull down the Notification Bar and tap the notification.

---

### Procedure

---

To cancel the warning and impending alarm, swipe across the yellow **Warning** screen from left to right over the arrows.

---

## Cancel motion conditions alarm

If you don't cancel an Emergency motion conditions warning, the phone goes into the alarm state. The alarm sounds and a red **Alarm** screen appears. If configured, the phone generates and sends an alarm notification to a security application, and places an emergency call.

If an emergency call is placed because of the alarm, you or the other party can end the call. However, the phone remains in the alarm state until you manually cancel the alarm.



---

**Note** While in the alarm state, you can still use the phone for any other operation. However, the alarm continues until you cancel it. To return to the alarm screen, pull down the Notification Bar and tap the notification.

---

### Procedure

---

To cancel the motion conditions alarm, swipe across the red **Alarm** screen from left to right over the arrows.

---

## Suspend motion conditions monitoring

You can't disable or change Emergency motion conditions set by the administrator. However, if the administrator enables the snooze feature, you can temporarily suspend Emergency motion conditions monitoring. This snooze feature is helpful if you must run, tilt, or stay still for a period longer than normal.



---

**Note** The **Emergency** notification displays the amount of available snooze time in brackets.

---

## Procedure

- 
- Step 1** Swipe down on the notification bar.
- Step 2** To **Start snoozing**, tap the **Emergency** notification.
- Step 3** To see how much snooze time remains, swipe down on the notification bar again.
- Step 4** To **Stop snoozing**, swipe down on the notification bar and tap the **Emergency** notification again.
- 

# Emergency and panic button

Based on your organization requirements, your administrator may configure the Emergency button and **Panic Button** for use in case of emergency.

When you activate the **Panic Button**, the phone enters an alarm state. What happens in the alarm state depends on how the administrator configures the Emergency button and **Panic Button**. A loud warning tone may sound and your phone may automatically call an emergency number.



---

**Note** If the phone calls an emergency number from the alarm state, any active call you may be on automatically ends.

---

## Activate the panic alarm

Your administrator can configure the programmed red Emergency button on the top of your phone and the **Panic Button** in the **Emergency**  app to activate in several different ways:

- Long press
- Two short presses
- Either a long press or two short presses

Contact your administrator to understand how to activate the panic alarm with your phone.



---

**Note** If you press the red Emergency button or **Panic Button** incorrectly, a pop-up tells you how to trigger a panic alarm.

---

Your administrator configures the actions that happen when you activate the **Panic Button**. For example, the **Panic Button** may automatically:

- Place an emergency call.
- Activate the speakerphone.
- Place an emergency call using the speakerphone.

## Procedure

---

Do one of the following:

- If programmed, press the red **Emergency** button on the top right of the phone, as directed.
  - From the **Emergency**  app, tap the red **Panic Button** as directed.
- 

## Cancel the panic alarm

If a Panic alarm is active, you can end the emergency call when you're ready. However, the phone remains in the alarm state until you manually cancel the alarm.

## Procedure

---

To cancel the Panic alarm, swipe across the red **Panic** screen from left to right over the arrows.

---





## CHAPTER 5

# Push to Talk app

---

- [Push to Talk overview, on page 89](#)
- [Access PTT app, on page 90](#)
- [Change the default PTT channel, on page 91](#)
- [Change channel subscriptions, on page 92](#)
- [Send a PTT broadcast, on page 92](#)
- [Change the PTT volume, on page 93](#)
- [Ignore a PTT broadcast, on page 93](#)
- [Answer a phone call during a PTT broadcast, on page 93](#)
- [Start a phone call during PTT broadcast, on page 94](#)

## Push to Talk overview

If enabled by the administrator, your phone can operate in a group broadcast mode that is called Push to Talk (PTT). In PTT mode, the phones behave like walkie-talkies. Your phone transmits audio over a built-in speakerphone and recipients can respond to your message.

The administrator subscribes you and others to any of the 25 normal channels that are available. The administrator may give you permission to receive, and optionally send, PTT broadcasts in your subscribed channels. The administrator creates a label for channels to help you identify PTT channels. The default label for channel 1 is ALL. Examples of normal channels in a hospital setting may be: Channel 2: Maintenance, Channel 3: Hospital Admitting, and Channel 4: IT Helpdesk.

Your phone alerts you to PTT transmissions from normal channels, the priority channel, and the emergency channel. Your phone receives PTT transmissions differently depending on whether you are on an active call.

- If you are not in a call, you automatically hear the PTT beep and the audio broadcast.
- If you are in a phone call, you do not hear the PTT beep or audio broadcast.







---

**Note** If you are on a call and see the PTT notification, you may join the broadcast, which would put your call on hold.

---

## Access PTT app

When you open the **PTT**  app, it displays the current channel and either the **Transmit**  tab, **Activity**  tab, or the **Channels**  tab, depending on which tab you last viewed.



**Note** A quick way to open the **PTT** app is to press and quickly release the programmed **PTT** button.



**Note** If the administrator doesn't enable PTT, when you access the **PTT** app you receive a notice that PTT is disabled and to contact your administrator.

### Procedure

- Step 1** Access the **PTT**  app.
- Step 2** Tap the desired tab: **Transmit** , **Activity** , or **Channels** .

### Related Topics

[Change button function](#), on page 102

## PTT app tabs

The **PTT**  app uses three tabs to manage available features.

*Table 27: PTT tabs*





Tab icons	Description
	The <b>Transmit</b> icon displays the PTT soft button. Use either this soft button or the designated hardware button to transmit broadcasts.
	The <b>Activity</b> icon opens the list of most recent broadcasts, any caller ID, and the current status of each listed channel.
	The <b>Channels</b> icon opens a list of all subscribed channels and indicates which is the default, which one is currently selected, any other active channels, inactive channels, and which channels you can use to transmit broadcasts.

Table 28: PTT app tab details

Icon or item	Description
Channel bar	Indicates active channel.
Star icon	Indicates the default channel.
Orange text	Indicates the currently selected channel. When you transmit through the <b>Talk</b> button, this is the channel that you transmit on.
Blue text	Indicates a channel other than your selected channel that has current PTT activity. You can't hear or contribute to this activity unless you switch to this channel.
Gray text	Indicates a channel other than your selected channel that no longer has current PTT activity (Activity tab) or is currently inactive (Channels tab).
Strikethrough microphone	Indicates transmit not allowed.
Microphone	Indicates transmit allowed.
Caller ID	Indicates caller ID.



## Change the default PTT channel

Your default PTT channel is the one that you automatically transmit on when there are no ongoing conversations on another PTT channel. In the **PTT**  app, the default channel has a star icon next to it and has orange text.

### Before you begin

Ensure that you have transmission permissions on your desired default channel.

### Procedure

- 
- Step 1** Access the **PTT**  app.
  - Step 2** Click the **Channels**  tab.
  - Step 3** Tap and hold the channel button that you want to be your default channel.
  - Step 4** Tap **Set as Default Channel**.
-

## Change channel subscriptions

Only the channels that you're subscribed to display in your **PTT** app. Only the administrator can change what channels display.



**Note** Your administrator controls PTT channel subscriptions. You can see which channels you're subscribed to and which you can transmit on, but you can't change or add to the list.

### Procedure

Contact your administrator to change your subscriptions and transmission permissions.

## Send a PTT broadcast

You can send PTT broadcasts over your default PTT channel, or over a different channel. For example, you may want to send a broadcast over an active PTT session that is on a different channel than your default channel.

When you're done speaking and release the **PTT** button, the phone enters a ten-second wait period. During this time, the channel is open to receive or send more broadcasts. If no activity occurs within the wait period, the PTT session closes. The wait period keeps the channel open and gives anyone subscribed to that channel time to join the conversation.



### Before you begin

If your phone is password-protected, unlock your phone to send a PTT broadcast.



**Note** For release 1.3(0) or later, your administrator may change the settings so that you can send a PTT broadcast without unlocking your password-protected phone. Check with your administrator for more details.

### Procedure

- Step 1** If you're not on the desired channel, access the **PTT**  app and tap the desired channel from the **Channels**  tab or click a leg of a conversation from the **Activity**  tab.
- Step 2** Press and hold the programmed **PTT** button.
- Step 3** After you hear a beep, hold the phone microphone approximately 2 inches (5 centimeters) from your mouth and speak.

**Step 4** Release the programmed **PTT** button.

---

**Related Topics**

[Change the default PTT channel](#), on page 91

## Change the PTT volume

If the PTT broadcast audio is too low or too high, you can raise or lower the volume on your phone.

**Procedure**

---

Press the programmed **Volume up** or **Volume down** buttons on the phone.

---

## Ignore a PTT broadcast

If you receive a PTT broadcast that you don't want to hear, you can prevent further PTT interruptions from that particular broadcast.

**Note**

You can also open the **PTT**  app and tap **Ignore**.

---

**Procedure**

---

**Step 1** Pull down the notification drawer.

**Step 2** Tap the **Ignore** option.

---

## Answer a phone call during a PTT broadcast

If a call comes in while a PTT broadcast is active, you can still answer the phone. When you answer the phone, the PTT broadcast automatically mutes.

**Procedure**

---

Follow the steps to answer a call.

---

**Related Topics**

[Answer a call](#), on page 56

# Start a phone call during PTT broadcast

You can still call someone during a PTT broadcast. When you start a call, the PTT audio automatically mutes.

**Procedure**

- 
- Step 1** Access the **Cisco Phone**  app.
- Step 2** Follow the steps to make a call.
- 

**Related Topics**

[Make calls](#), on page 53



## CHAPTER 6

# Battery Life app

---

- [Battery Life app overview, on page 95](#)
- [Adjust the Battery Life alarm volume, on page 96](#)
- [Stop the Battery Life alarm, on page 96](#)

## Battery Life app overview

When the administrator enables battery monitoring, the **Battery Life**  app:

- Displays the current conditions of the phone's battery.
- Enables an alarm that indicates when the battery is low.

If you do not see any **Battery Life** details, contact your administrator.



---

**Note** The Cisco Wireless Phone 860 and 860S have an internal secondary battery, which operates the phone during a hot swap. The **Battery Life** app dashboard displays the general status of the internal battery. For more information about the secondary battery, you can tap **Open additional metrics and options**.

---



**Caution**

Don't use the Android **Battery Saver**  mode. It curtails functionality to conserve the life of the battery. In **Battery Saver** mode, features that you rely on may not work. If you require more than one charge per shift, contact your administrator for a second battery.

For your Cisco Wireless Phone 860 and 860S, you can hot swap the battery to maintain connectivity without loss of functionality.



The Cisco Wireless Phone 840 and 840S don't have an internal battery, so they don't support the hot swap feature.

---

## Adjust the Battery Life alarm volume

The administrator controls the **Battery Life** alarm settings such as the alarm sound, tone, and vibration. However, you can adjust the volume of the **Battery Life** alarm.

### Procedure

- 
- Step 1** Access the **Battery Life**  app
  - Step 2** Tap the **Overflow**  menu.
  - Step 3** Tap **Settings**.
  - Step 4** Swipe the **Alarm volume** slider.
- 

## Stop the Battery Life alarm

If the administrator enables battery monitoring with an audible alarm, an alarm sounds if your battery falls below the set low battery threshold.

When the battery alarm sounds, you can temporarily snooze the alarm. However, the alarm continues until the battery is above the set low battery threshold.



---

**Note** If you're in a call, the alarm activates in vibrate mode with a visual alert. When the call ends, if you didn't snooze the alarm, the audible alert begins.

---



---

**Note** If you set your phone to **Do Not Disturb** mode and the low battery alarm triggers, it overrides Do Not Disturb and sounds the alarm. After you snooze the alarm, the phone goes into normal mode and remains in normal mode, in effect canceling Do Not Disturb.

---

### Procedure

- 
- Step 1** To snooze the battery alarm, swipe the alarm.
  - Step 2** To stop the battery alarm, either plug the phone into a charger or change the battery to one with more charge than the low battery threshold.
- 

#### Related Topics

[Phone battery charging](#), on page 44

[Install the battery](#), on page 39

[Remove the battery](#), on page 41

[Hot swap the battery for Cisco Wireless Phone 860 and 860S](#), on page 42





## CHAPTER 7

# Buttons app

---

- [Buttons app overview, on page 99](#)
- [Programmable buttons, on page 99](#)
- [Access Buttons app, on page 101](#)
- [Change button function, on page 102](#)

## Buttons app overview

You can define the action for the programmable hard buttons on your phone with the **Buttons**  app.



---

**Note** In some organizations, administrators set the buttons for specific application purposes and don't allow you to change these buttons. Check with your administrator if you can't make button assignment changes.

---

## Programmable buttons

The following illustrations and table show the programmable buttons on the phone.



---

**Note** The programmable buttons for the Cisco Wireless Phone 840 and Cisco Wireless Phone 860 are not in the same location. Also, the Cisco Wireless Phone 840 and 840S don't have a Fingerprint button.

---

Figure 12: Programmable buttons on the Cisco Wireless Phone 840 and 840S

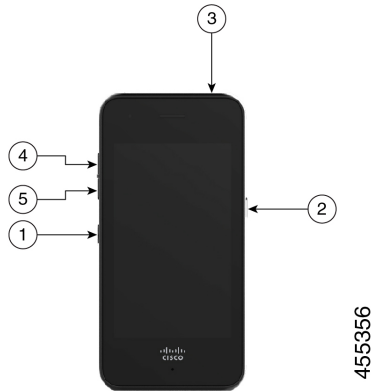

Figure 13: Programmable buttons on the Cisco Wireless Phone 860 and 860S

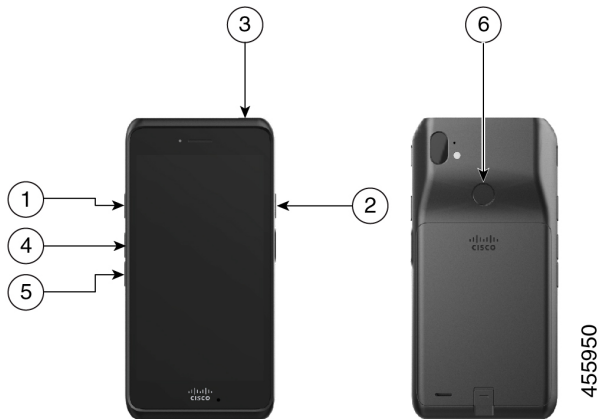

Table 29: Programmable buttons

Callout	Programmable button
1	Left button
2	Right button
3	Top
4	Volume up
5	Volume down
6	Fingerprint—For Cisco Wireless Phone 860 and 860S only.

## Actions for the programmable buttons

The following are the potential actions for the programmable buttons.



---

**Note** Not all actions are available for all programmable buttons.

---

- No action
- Home key
- Back key
- Menu key
- PTT
- Emergency
- Volume up
- Volume down
- Run application
- Open URL
- Scanner—Available only for barcode scanner phones.
- Fingerprint—Available only for the Fingerprint button on the Cisco Wireless Phone 860 and 860S.
- Custom 1—Contact your app programmer to create custom actions.
- Custom 2
- Custom 3
- Custom 4

## Access Buttons app

You can open the **Buttons**  app on your phone to view and change the programmable button actions. The application screen displays the programmable buttons with their current actions.

### Procedure

---

Access the **Buttons**  app.

---

## Default button settings

The following are the default button settings.

*Table 30: Default programmable button settings*

Programmable button	Default setting
Left button	No action (for Cisco Wireless Phone 840 and 860) Scanner (for Cisco Wireless Phone 840S and 860S only)
Right button	PTT
Top	Emergency
Fingerprint (for Cisco Wireless Phone 860 and 860S only)	Fingerprint
Volume up	Volume up
Volume down	Volume down

## Change button function

You can change the default actions of the buttons on your phone. After you choose the action for a button, the changes automatically save.

If you're unable to change the action of the buttons, contact your administrator.

### Procedure

- 
- Step 1** Access the **Buttons**  app.
  - Step 2** From the **Buttons settings** screen, tap the desired button.
  - Step 3** Tap the desired action from the list.
-



## CHAPTER 8

# Barcode app

---

- [Barcode app](#), on page 103
- [Test scan a barcode](#), on page 104
- [Scan a barcode](#), on page 105
- [Clean the scanner window](#), on page 106

## Barcode app

If you have a Cisco Wireless Phone 840S or Cisco Wireless Phone 860S, it includes a barcode scanner and **Barcode**  app.

Your administrator controls the settings for the **Barcode** app. Among other features, the administrator controls the symbols set up, the intensity of the scan light, and the audible sounds with scan completion.

Your administrator may also do a test scan of a barcode.



---

**Caution** The LED light is bright, but not a laser. Don't stare at the light or let it shine into the eyes.

---

Figure 14: Barcode scanner on the Cisco Wireless Phone 860S



#### Related Topics

[Test scan a barcode](#), on page 104

## Test scan a barcode

Before you use the barcode scanner for the first time, check that the scanner is properly configured to scan your barcode type.

**Before you begin**

- Use the small tab to remove the plastic cover on the barcode scanner.
- Use the **Buttons**  app to program a button as the **Scanner**.







---

**Note** By default, the top-left button of the Cisco Wireless Phone 860S is set to **Scanner**.  
By default, the bottom-left button of the Cisco Wireless Phone 840S is set to **Scanner**.

---

**Procedure**

- 
- Step 1** Access the **Barcode**  app.
- Step 2** Tap the **Overflow**  menu.
- Step 3** Tap **Test scan**.
- Step 4** From the Barcode screen, tap the barcode scanner  button.
- Step 5** Point the barcode reader 1–18 inches (2.5–46 centimeters) from the barcode that you want to scan.
- Step 6** Press and hold the programmed **Scanner** button with the light shining across the entire barcode symbol until the light turns off and you hear a beep.
- The **Barcode type** and the **Scanned barcode data** appear on the Barcode screen. The barcode search  button is enabled.
- Step 7** Tap the barcode search  button to find data about the scanned barcode.  
The search results appear in the default browser on your phone.
- 

## Scan a barcode

The barcode reader is on the top rear of the handset. It takes longer to scan large 2D barcodes. For example, it may take the scanner several seconds to read a large 3000 character barcode.

The scanner lights for the Cisco Wireless Phone 840S are white and green.

The scanner lights for the Cisco Wireless Phone 860S are red.

**Before you begin**

- Before first use, use the small tab to remove the plastic cover on the barcode scanner.
- If not already done, use the **Buttons**  app to program a button as the **Scanner**.



---

**Note** By default, the top-left button of the Cisco Wireless Phone 860S is set to **Scanner**.

By default, the bottom-left button of the Cisco Wireless Phone 840S is set to **Scanner**.

---

- If not already done, and if available, perform a test scan of a barcode.

## Procedure

- 
- Step 1** If your phone is password protected, unlock the phone.
- Step 2** Point the barcode reader 1–18 inches (2.5–46 centimeters) from the barcode that you want to scan.
- Step 3** Press and hold the programmed **Scanner** button with the light shining across the entire barcode symbol until the light turns off and you hear a beep.
- 

### Related Topics

[Change button function](#), on page 102

[Test scan a barcode](#), on page 104

## Clean the scanner window

If the scanner isn't working properly, clean the scanner window.



---

**Caution** Don't spray cleaner directly on the scanner window.

---



---

**Note** You may also clean the scanner with a monitor wipe.

---

## Procedure

- 
- Step 1** Spray glass cleaner onto a soft cloth.
- Step 2** Wipe the scanner window.
-



## CHAPTER 9

# Settings

---



- [Access user settings for the Cisco Phone app, on page 107](#)
- [Adjust the volume during a call, on page 111](#)
- [Access the Settings app, on page 111](#)

## Access user settings for the Cisco Phone app

The **User settings** allow you to control certain calling features.

### Procedure

---

- Step 1** Access the **Cisco Phone**  app.
- Step 2** Choose one of the following based on your phone's software version:
- For release 1.2(0), tap the **Overflow**  menu.
  - For release 1.3(0) or later, tap the **Drawer**  menu.
- Step 3** Choose one of the following based on your phone's software version:
- For release 1.2(0), tap **Settings**.
  - For release 1.3(0) or later, tap **User settings**.
- 

## Change the ringtone

If enabled by your administration, you can change the ringtone for each registration. These ringtone settings are active only when the phone is on and unlocked. If the phone is locked, the default ringtone from the **Settings > Sound** menu sounds.



---

**Note** The administrator can specify a ringtone in the call server. This configuration takes precedence over any setting at the user level.

---



---

**Note** You can also set a custom ringtone for a contact, through the **Set ringtone** option for the contact.

---



---

**Note** For release 1.7(0) or later, you can configure a ringtone for each line from the Cisco Phone application on the Cisco Wireless Phone 840 or 860. Default line ringtone is Flutey Phone.

---







---

**Note** For release 1.9(0) or later, you are not allowed to change the Line 1 ringtone and Line 2 ringtone. They are locked by the administrator and they will appear as "Specified by the Admin" in **User Settings**.

---

## Procedure



- 
- Step 1** Access the **Cisco Phone**  app.
- Step 2** Choose one of the following based on your phone's software version:
- For release 1.2(0), tap the **Overflow**  menu.
  - For release 1.3(0) or later, tap the **Drawer**  menu.
- Step 3** Choose one of the following based on your phone's software version:
- For release 1.2(0), tap **Settings**.
  - For release 1.3(0) or later, tap **User settings**.
- Step 4** Tap the desired registration line ringtone.
- Step 5** Choose the desired ringtone.
- Step 6** Tap **OK**.
- 

## Set hearing aid compatibility mode

The **Cisco Phone**  app includes a hearing aid compatibility mode. If you have a telecoil inductive pickup for your hearing aid, the phone can adjust the frequency response of the phone. Acoustic pickup hearing aids don't respond to this adjustment.

## Procedure

- 
- Step 1** Access the **Cisco Phone**  app.
- Step 2** Choose one of the following based on your phone's software version:

- For release 1.2(0), tap the **Overflow**  menu.
- For release 1.3(0) or later, tap the **Drawer**  menu.

**Step 3** Choose one of the following based on your phone's software version:

- For release 1.2(0), tap **Settings**.
- For release 1.3(0) or later, tap **User settings**.

**Step 4** To enable hearing aid compatibility mode, slide the **Hearing aid compatibility** slider to the right .

**Step 5** To disable hearing aid compatibility mode, slide the **Hearing aid compatibility** slider to the left .

---

## Set automatic noise cancellation



If you work in a noisy environment, you can set your **Cisco Phone** app to automatically cancel background noise.

### Procedure

---

**Step 1** Access the **Cisco Phone**  app.

**Step 2** Choose one of the following based on your phone's software version:

- For release 1.2(0), tap the **Overflow**  menu.
- For release 1.3(0) or later, tap the **Drawer**  menu.

**Step 3** Choose one of the following based on your phone's software version:

- For release 1.2(0), tap **Settings**.
- For release 1.3(0) or later, tap **User settings**.

**Step 4** To enable automatic noise cancellation, slide the **Automatic noise cancellation** slider to the right .

**Step 5** To disable automatic noise cancellation, slide the **Automatic noise cancellation** slider to the left .

---





## Set the phone to vibrate before it rings

You can set the **Cisco Phone** app to vibrate before it starts to ring.

### Procedure

---

**Step 1** Access the **Cisco Phone**  app.





- Step 2** Choose one of the following based on your phone's software version:
- For release 1.2(0), tap the **Overflow**  menu.
  - For release 1.3(0) or later, tap the **Drawer**  menu.
- Step 3** Choose one of the following based on your phone's software version:
- For release 1.2(0), tap **Settings**.
  - For release 1.3(0) or later, tap **User settings**.
- Step 4** Use the **Vibrate before ring** slider to either enable  or disable  the vibrate before ring feature.
- 

## Set the phone to fade in ring

You can set the **Cisco Phone** app ring tone to become gradually louder as the phone rings.

### Procedure

---

- Step 1** Access the **Cisco Phone**  app.
- Step 2** Choose one of the following based on your phone's software version:
- For release 1.2(0), tap the **Overflow**  menu.
  - For release 1.3(0) or later, tap the **Drawer**  menu.
- Step 3** Choose one of the following based on your phone's software version:
- For release 1.2(0), tap **Settings**.
  - For release 1.3(0) or later, tap **User settings**.
- Step 4** To set the ring tone to become gradually louder, slide the **Fade in ring** slider to the right .
- Step 5** To turn off this feature, slide the **Fade in ring** slider to the left .
- 



## Set the phone to autodial

You can set the **Cisco Phone** app to automatically dial a number.

### Procedure



---

- Step 1** Access the **Cisco Phone**  app.
- Step 2** Choose one of the following based on your phone's software version:

- For release 1.2(0), tap the **Overflow**  menu.
- For release 1.3(0) or later, tap the **Drawer**  menu.

**Step 3** Choose one of the following based on your phone's software version:

- For release 1.2(0), tap **Settings**.
- For release 1.3(0) or later, tap **User settings**.

**Step 4** Use the **Enable autodial** slider to either enable  or disable  the autodial feature.

## Adjust the volume during a call

If the sound in your handset, headset, or speakerphone is too loud or too soft, you can change the volume while you are on a call. When you change the volume during a call, the change only affects the speaker you're using at the time. For example, if you adjust the volume while you're using a headset, the handset volume doesn't change.

### Procedure

Press the programmed **Volume up** and **Volume down** buttons to adjust the volume while you are on a call.

## Access the Settings app

If enabled by the administrator, your phone has a **Settings**  app that lets you customize settings such as Bluetooth® connections, sound, and display.

If your administrator set up the phone with a smart launcher, then the **Settings** app isn't available. However, you can still access some volume and display settings from the quick settings.



**Note** If enabled, to access the **Settings** app from any screen, swipe down on the status bar at the top of the screen and tap the **Settings**  gear icon.

If enabled, you can also access the **Settings**  app from the Launcher screen. Swipe up to open the Launcher.

### Procedure

Access the **Settings**  app.

## Turn on Bluetooth wireless technology

You can connect Bluetooth® headsets and Bluetooth speakers to your phone. The phone does not support other Bluetooth devices.

Before you can use a Bluetooth device with your phone, you must turn on the Bluetooth wireless technology.

### Procedure

---

- Step 1** Access the **Settings**  app.
  - Step 2** Select **Connected devices** > **Connection Preferences** > **Bluetooth**.
  - Step 3** Swipe the **On** slider to the right.
- 

## Pair a Bluetooth device

You can pair up to five Bluetooth® devices with your phone. Once the phone pairs with a device, it connects to that device.

### Before you begin

Ensure that the Bluetooth wireless technology is on.

### Procedure

---

- Step 1** Access the **Settings**  app.
  - Step 2** Select **Connected devices** > **Connection Preferences** > **Bluetooth**.
  - Step 3** Tap **Pair new device**.  
The phone searches for any Bluetooth devices in range. This scan can take a couple of minutes.
  - Step 4** From the list of **Available devices**, select the desired device and tap **Pair**.
  - Step 5** If necessary, enter the device pin code.
- 

## Connect a Bluetooth device

After you pair and connect a Bluetooth® device to your phone, the device automatically connects when it is turned on and close to your phone. Only one Bluetooth device can connect to the phone at a time. So, if you have two paired Bluetooth devices turned on, the phone uses the most recently connected device. You can change which Bluetooth device is actively connected to your phone.

### Before you begin

Ensure that the Bluetooth wireless technology is on.

## Procedure

---

- Step 1** Access the **Settings**  app.
- Step 2** Select **Connected devices** > **Connection Preferences** > **Bluetooth**.
- Step 3** From the **Available media devices** list, select the desired device.
- 

## Rename a connected Bluetooth device



You may want to rename your connected Bluetooth® devices so they are easier to identify.

### Before you begin

Ensure that the Bluetooth wireless technology is on.

## Procedure

---

- Step 1** Access the **Settings**  app.
- Step 2** Tap **Connected devices**.
- Step 3** Choose from the following:
- For a **Currently connected** device, tap the device name.
  - For **Available media devices** or **Previously connected devices**, tap **Settings**  next to the device.
- Step 4** Tap **Edit**.
- Step 5** Edit the **Device name** and tap **Rename**.
- 

## Disconnect a Bluetooth device

You can disconnect the Bluetooth® device that is currently paired with your phone.

## Procedure

---

- Step 1** Access the **Settings**  app.
- Step 2** Select **Connected devices** > **Connection Preferences** > **Bluetooth**.
- Step 3** Select the connected device and tap **Disconnect**.
- 

## Forget a Bluetooth device

If you no longer want your phone to pair with a Bluetooth® device, you can forget the device.

## Procedure

- 
- Step 1** Access the **Settings**  app.
  - Step 2** Select **Connected devices** > **Connection Preferences** > **Bluetooth**.
  - Step 3** Select the device and tap **Forget**.
- 

## Adjust the phone ringer volume

Like other devices powered by Android, you may be able to customize your phone ring tones and volumes, through a Settings application. In some organizations, the administrator may turn off the **Settings** app.

You can find the **Settings**  app on one of your home screens or in the launcher screen. Tap the up arrow or swipe up to open the launcher.



---

**Note** If the **Settings** app isn't available because your administrator set up the phone with a smart launcher, you may be able to access the **Ring volume** setting under **Volume** in the quick settings.

---

## Procedure

- 
- Step 1** Tap the **Settings**  app.
  - Step 2** Tap **Sound**.
  - Step 3** Slide to adjust the **Ring volume**.
- 

## Adjust the screen brightness

By default the screen brightness automatically adjusts based on the current light conditions, making it easy to see when moving between dark and light spaces. If the administrator hasn't turned off the **Settings**  app, you can also manually adjust the brightness level of the screen.



---

**Note** If the **Settings** app isn't available because your administrator set up the phone with a smart launcher, you may be able to access the **Ring volume** setting under **Volume** in the quick settings.

---

## Procedure

- 
- Step 1** Access the **Settings**  app.
  - Step 2** Tap **Display**.
  - Step 3** Tap **Brightness level**.
  - Step 4** Swipe the **Brightness level** slider to adjust the screen brightness.
  - Step 5** If desired, turn on **Adaptive brightness** to automatically adjust the screen brightness based on the environment.
- 

## Change the screen display timeout

When inactive for a while, the phone screen turns off and enters sleep mode. If the administrator hasn't turned off the **Settings**  app, you can adjust the amount of inactive time before the phone enters sleep mode.

To avoid unintentional phone operation, only the Power button and assigned buttons (other than the volume buttons) turn the phone screen back on.

## Procedure

- 
- Step 1** Access the **Settings**  app.
  - Step 2** Tap **Display**.
  - Step 3** Tap **Advanced**.
  - Step 4** Tap **Screen Timeout**.
  - Step 5** Select the desired amount of time.
- 

## Change the font and display size

If the administrator hasn't turned off the **Settings**  app, you can change the size of either just the text font, or of the entire display. The display size includes all interface elements such as text and images.

## Procedure

- 
- Step 1** Access the **Settings**  app.
  - Step 2** Tap **Display**.
  - Step 3** Tap **Advanced**.
  - Step 4** Tap **Font size** or **Display size**.

**Step 5** Use the **Font size** or **Display size** sliders to adjust the font size and display size respectively.

---

## Set the screen to rotate automatically

If available, you can use the **Auto-rotate screen** setting to automatically change the screen display to landscape for some applications.

Screen rotation doesn't work while you hot swap a Cisco Wireless Phone 860 battery.



**Note** You can also access the automatic screen rotation feature from the quick settings. Swipe down on the status bar at the top of the screen and tap **Auto-rotate**  to toggle automatic screen rotation on and off.

---

### Procedure

---

- Step 1** Access the **Settings**  app.
  - Step 2** Tap **Accessibility**.
  - Step 3** Tap **Auto-rotate screen** to toggle this feature on and off.
-



# CHAPTER 10

## Accessories

---

- [Supported accessories, on page 117](#)
- [Headsets, on page 118](#)
- [Desktop chargers, on page 119](#)
- [Multichargers, on page 123](#)
- [Charger care, on page 127](#)
- [Scanner handle for the Cisco Wireless Phone 840S, on page 128](#)
- [Clips, on page 129](#)
- [Cisco accessory part numbers, on page 129](#)

## Supported accessories

You can use several accessories with your phone. For part numbers of the approved accessories, see [Cisco accessory part numbers, on page 129](#).



---

**Caution** Use only the approved chargers and power supplies for your phone.

---

- **Headsets**—Standard headsets that use a 3.5-mm jack or Bluetooth® headsets.



---

**Note** The phones don't support Apple headsets. The phones can connect to Bluetooth headsets and speakers only. They don't support any other type of Bluetooth device.

---

- **Desktop chargers**—Use the approved power supply.
  - Cisco Wireless Phone 840 Desktop Charger
  - Cisco Wireless Phone 840 Desktop Dual Charger
  - Cisco Wireless Phone 860 Desktop Dual Charger Module
  - Cisco Wireless Phone 860 Desktop Battery Charger Module
- **Multichargers**—Use the approved power supply.

- Cisco Wireless Phone 840 Multicharger
- Cisco Wireless Phone 840 Battery Multicharger
- Cisco Wireless Phone 860 Multicharger Base—Holds up to four 860 Desktop Charger Modules (in any configuration: Dual or Battery).
- **USB charger**—Use the approved power supply.
- **Spare batteries**
- **Scanner handle**—For the Cisco Wireless Phone 840S only.
- **Clips**
- **Cases**—For the Cisco Wireless Phone 860 and 860S only.

#### Related Topics

[Cisco accessory part numbers](#), on page 129

[Charge the battery with the AC power supply](#), on page 45

[Charge the battery with the USB cable and a USB port on your computer](#), on page 46

## Headsets

You can use wired and Bluetooth® headsets with your phone.

Although we perform some internal testing of third-party wired and Bluetooth wireless headsets for use with the Cisco Wireless Phone 840 and 860, we don't certify or support products from headset or handset vendors. Because of the inherent environmental and hardware inconsistencies in the locations where phones are deployed, there's not a single "best" solution that is optimal for all environments. We recommend that customers test the headsets that work best in their environment before deploying many units in their network.



---

**Note** The Cisco Wireless Phone 840 and 860 hasn't been tested for wired and Bluetooth headsets in hazardous locations.

---

We recommend the use of good quality external devices, like headsets that are screened against unwanted radio frequency (RF) and audio frequency (AF) signals. Depending on the quality of these devices and their proximity to other devices such as cell phones and two-way radios, some audio noise may still occur.

The primary reason that a particular headset would be inappropriate for the phone is the potential for an audible hum. This hum can be heard by either the remote party or by both the remote party and you, the phone user. Some potential humming or buzzing sounds can be caused by a range of outside sources, for example, electric lights, electric motors, or large PC monitors. In some instances, the mechanics or electronics of various headsets can cause remote parties to hear an echo of their own voice when they speak to phone users.

## Important headset safety information



**High Sound Pressure**—Avoid listening to high volume levels for long periods to prevent possible hearing damage.

When you plug in your headset, lower the volume of the headset speaker before you put the headset on. If you remember to lower the volume before you take the headset off, the volume will start lower when you plug in your headset again.

Be aware of your surroundings. When you use your headset, it may block out important external sounds, particularly in emergencies or in noisy environments. Don't use the headset while driving. Don't leave your headset or headset cables in an area where people or pets can trip over them. Always supervise children who are near your headset or headset cables.

## Standard headsets

You can use a wired headset with your phone. The headset requires a 3.5 mm, 3-band, 4-connector plug.

We recommend the Cisco Headset 520 Series. These headsets offer outstanding audio performance. For more information about the headset, see [Cisco Headset 500 Series](#).

If you plug a headset into the phone during an active call, the audio path automatically changes to the headset.

## Bluetooth headsets

You can use a Bluetooth® headset with your phone. When you use a Bluetooth wireless headset, the headset usually increases battery power consumption on your phone and may result in reducing battery life.

For a Bluetooth wireless headset to work, it does not need to be within direct line-of-sight of the phone, but some barriers, such as walls or doors, and interference from other electronic devices, can affect the connection.

We recommend the Cisco Headset 560 Series and Cisco Headset 730. These headsets offer outstanding audio performance. For more information about the headsets, see [Cisco Headset 500 Series](#) and [Cisco Headset 700 Series](#).

## Desktop chargers

The following desktop chargers are compatible with your phone.

However, the desktop chargers for the Cisco Wireless Phone 840 and Cisco Wireless Phone 860 are not interchangeable.



---

**Caution** Use only the approved chargers and power supplies for your phone.

---

### Cisco Wireless Phone 840 and 840S

The Cisco Wireless Phone 840 and 840S also have two types of desktop chargers.

*Table 31: Desktop chargers*

Charger name	Charger capacity
Cisco Wireless Phone 840 Desktop Charger	One 840 phone
Cisco Wireless Phone 840 Desktop Dual Charger	One 840 phone and one 840 battery

**Figure 15: Cisco Wireless Phone 840 Desktop Charger and Cisco Wireless Phone 840 Desktop Dual Charger**

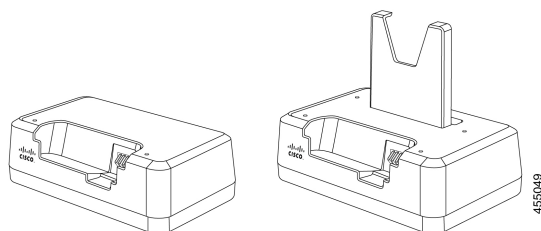

### Cisco Wireless Phone 860 and 860S

The Cisco Wireless Phone 860 and 860S have two types of desktop chargers.

**Table 32: Desktop chargers**

Charger name	Charger capacity
Cisco Wireless Phone 860 Desktop Dual Charger Module	One 860 phone and one 860 battery
Cisco Wireless Phone 860 Desktop Battery Charger Module	Two 860 batteries

**Figure 16: Cisco Wireless Phone 860 Desktop Dual Charger Module and Cisco Wireless Phone 860 Desktop Battery Charger Module**

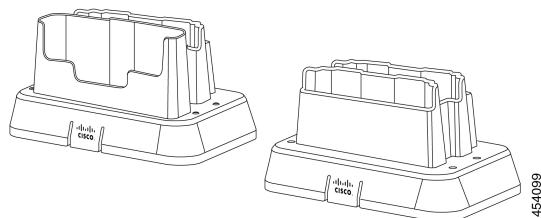

### Related Topics

[Cisco accessory part numbers](#), on page 129

## Set up the desktop chargers

Follow these steps for all Cisco Wireless Phone 840 and 860 desktop chargers.

The following illustration is of the Cisco Wireless Phone 860 Desktop Dual Charger Module.



---

**Caution** Use only the approved chargers and power supplies for your phone.

---

### Before you begin

Ensure that the power supply has the correct plug for your area.

## Procedure

**Step 1** Place the module on a flat surface within reach of a power outlet.

**Step 2** Plug the power supply into the module.

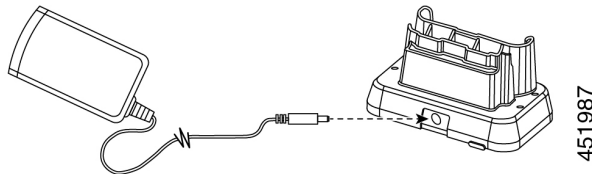

**Step 3** Plug the other end of the power supply into a power outlet.

### Related Topics

[Cisco accessory part numbers](#), on page 129

## Charge your phone and battery with desktop dual charger

You can charge your phone and one spare battery with the desktop dual charger.

If both the phone and battery are in the charger, the phone takes priority. So it may take longer to charge the battery.

There are two LEDs: one for the phone and one for the battery. The LEDs turn on when you properly seat the phone and battery.

- A solid red LED indicates that the item is charging.
- A solid green LED indicates that the item is fully charged.
- An LED that is off indicates an empty slot or an error condition.



**Note** These steps are the same for both the Cisco Wireless Phone 840 Desktop Dual Charger and Cisco Wireless Phone 860 Desktop Dual Charger Module. The illustration is of the Cisco Wireless Phone 860 Desktop Dual Charger Module.

### Before you begin

Ensure that you properly set up the desktop charger.



**Caution** Use only the approved chargers and power supplies for your phone.

## Procedure

- 
- Step 1** With the battery charging contacts down, insert a spare battery into the dual charger rear slot.
- Step 2** Insert your phone face forward into the dual charger front slot.

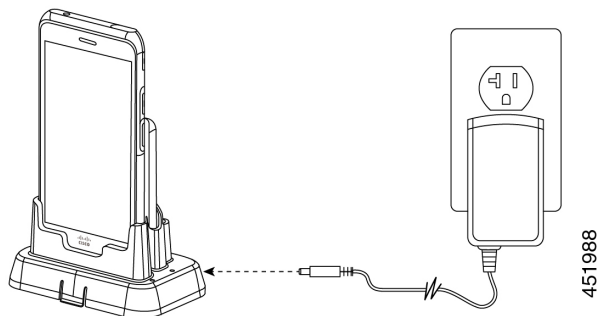

---

### Related Topics

[Set up the desktop chargers](#), on page 120

[Cisco accessory part numbers](#), on page 129

## Charge your spare 860 batteries with desktop battery charger

You can charge up to two spare 860 batteries at a time in the Cisco Wireless Phone 860 Desktop Battery Charger Module.



---

**Caution** You can't use this charger for 840 batteries.

---

There are two LEDs: one for each battery. The LEDs turn on when you properly seat the batteries.

- A solid red LED indicates that the item is charging.
- A solid green LED indicates that the item is fully charged.
- An LED that is off indicates an empty slot or an error condition.

### Before you begin

Ensure that you properly set up the Cisco Wireless Phone 860 Desktop Battery Charger Module.



---

**Caution** Use only the approved chargers and power supplies for your phone.

---

## Procedure

With the battery charging contacts facing down, insert a spare battery into each charger slot.

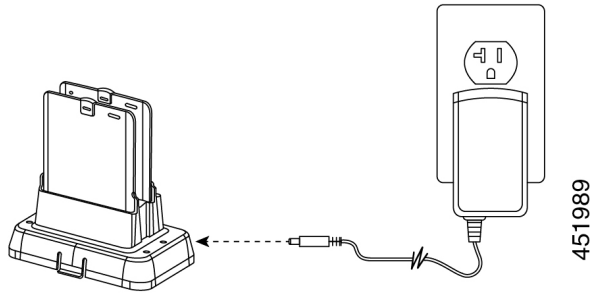

## Related Topics

[Cisco accessory part numbers](#), on page 129

# Multichargers

The following multichargers are compatible with your phone.

However, the multichargers for the Cisco Wireless Phone 840 and Cisco Wireless Phone 860 are not interchangeable.



**Caution** Use only the approved chargers and power supplies for your phone.

## Cisco Wireless Phone 840 and 840S

The Cisco Wireless Phone 840 and 840S have two standalone multichargers:

**Table 33: Multichargers**

Charger name	Charger capacity
Cisco Wireless Phone 840 Multicharger	Six 840 phones
Cisco Wireless Phone 840 Battery Multicharger	Six 840 batteries

**Figure 17: Cisco Wireless Phone 840 Multicharger and Cisco Wireless Phone 840 Battery Multicharger**

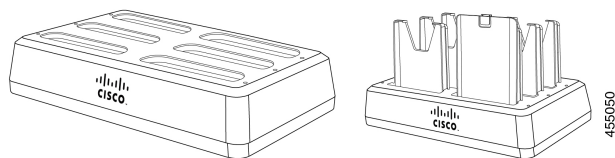

### Cisco Wireless Phone 860 and 860S

The Cisco Wireless Phone 860 and 860S multicharger includes a Cisco Wireless Phone 860 Multicharger Base that holds up to four of the following 860 desktop charger modules in any configuration:

- Cisco Wireless Phone 860 Desktop Dual Charger Module
- Cisco Wireless Phone 860 Desktop Battery Charger Module

**Table 34: Sample multicharger configuration**

Cisco Wireless Phone 860 Multicharger Base configuration	Charger capacity
With four Cisco Wireless Phone 860 Desktop Dual Charger Modules	Four phones and four batteries
With two Cisco Wireless Phone 860 Desktop Dual Charger Modules and two Cisco Wireless Phone 860 Desktop Battery Charger Modules	Two phones and six batteries
With four Cisco Wireless Phone 860 Desktop Battery Charger Modules	Eight batteries

**Figure 18: Cisco Wireless Phone 860 Multicharger Base with 860 Desktop Charger Modules**

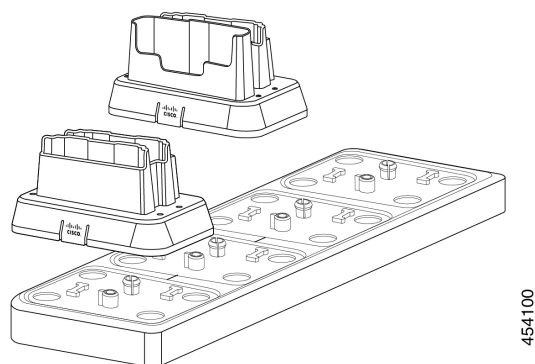

### Related Topics

[Cisco accessory part numbers](#), on page 129

## Assemble the Cisco Wireless Phone 860 Multicharger Base

You can insert up to four desktop charger modules into the multi charger base. You can use any combination of the Cisco Wireless Phone 860 Desktop Dual Charger Modules and Cisco Wireless Phone 860 Desktop Battery Charger Modules as desired.



**Caution** Use only the power supply that comes with the multicharger base.

Red and green LEDs blink at powerup.

### Before you begin

Ensure that the power supply has the correct plug for your area.

### Procedure

**Step 1** Place the multicharger base on a flat surface within reach of power outlet.

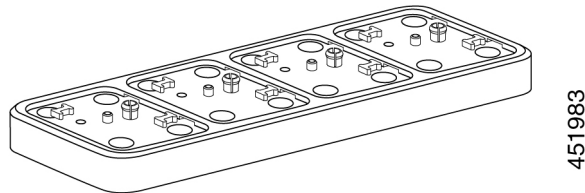

**Step 2** Insert the tabs on the back of the desktop charger module into the slots on the base.

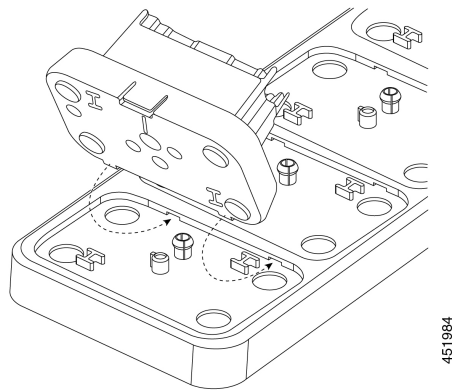

**Step 3** Rock the desktop charger module forward and use the front tab to snap it into place.

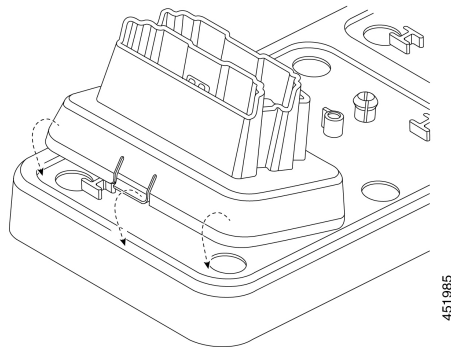

**Step 4** Plug the multicharger base power supply into the base and a power outlet.

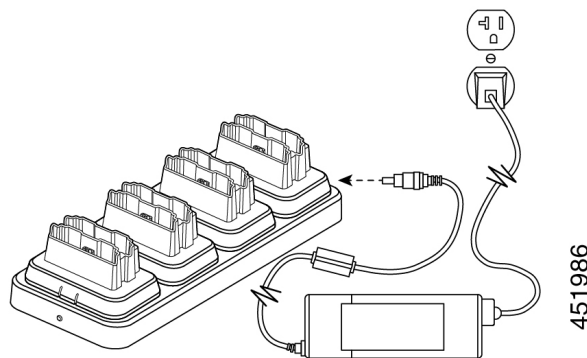

### Related Topics

[Cisco accessory part numbers](#), on page 129

## Charge phones and batteries with multicharger

With the 840 multichargers, you can charge up to six phones or batteries at a time. Each slot has an LED.

With the 860 multicharger, you can charge up to eight items at a time. Each desktop module has two LEDs, one for each slot.

- Solid red LED indicates that the item is charging.
- Solid green LED indicates that the item is fully charged.
- LED that is off indicates an empty slot or an error condition.

### Before you begin

For the 840 phones, ensure that you plug in the multicharger.

For the 860 phones, ensure that you properly set up the Cisco Wireless Phone 860 Multicharger Base and install up to four desktop charger modules.



---

**Caution** Use only the approved chargers and power supplies for your phone.

---

## Procedure

---

Insert the phones and batteries into the slots.

---

### Related Topics

[Assemble the Cisco Wireless Phone 860 Multicharger Base](#), on page 125

[Charge your phone and battery with desktop dual charger](#), on page 121

[Cisco accessory part numbers](#), on page 129

## Charger care

Although you don't handle the chargers as much as the phones, they can get dirty, so it's important to periodically clean them.



---

**Caution** The plastic in the charger is different from the plastic in the phone, so it doesn't withstand rigorous disinfection.

---

Follow the same steps to clean the charger as you do for the phones, but pay special attention to the following:

- Remove the phone and battery from the charger. Unplug the charger.
- Never immerse the charger in liquid.
- Don't spray any solution directly onto the charger. Dampen a cloth and wipe instead. Do not allow liquid to pool on or in the plastic.
- Don't use a bleach solution on battery contacts.
- Don't exert undue pressure on electrical contacts inside the charger compartment. Do not bend the contacts.
- For light to heavy soil—Wipe the charger surface with a water-dampened cloth or paper towel to remove most films or residue. If the soiling is too stubborn for plain water, use a mild detergent solution, Lysol<sup>®</sup>, isopropyl alcohol, or diluted bleach (10 percent or less).
- Wipe battery contacts with a cotton swab dampened with alcohol to remove any lint.
- Never use the following products to clean your charger:
  - Don't use furniture polishes, waxes, or plasticizer-based cleaners such as ArmorAll<sup>®</sup>.
  - Don't use lanolin, aloe, glycerin, or other skin care products.
  - Don't use hand sanitizers to clean chargers or handle the charger when your hands are wet with sanitizer solution.
  - Don't apply any solvent such as acetone, mineral spirits, and so on.

- Allow the charger to air dry. You may wipe the charger with a soft dry cloth to hasten dry time. Be sure that electrical contacts are completely dry and lint-free. When fully dry, you may plug in the charger and reinsert the battery and phone.

## Scanner handle for the Cisco Wireless Phone 840S

There is a scanner handle available for the Cisco Wireless Phone 840S. Use the scanner handle to easily scan multiple barcodes.

*Figure 19: Cisco Wireless Phone 840S with scanner handle*



## Install the Cisco Wireless Phone 840S in the scanner handle

*Figure 20: Cisco Wireless Phone 840S in the scanner handle*

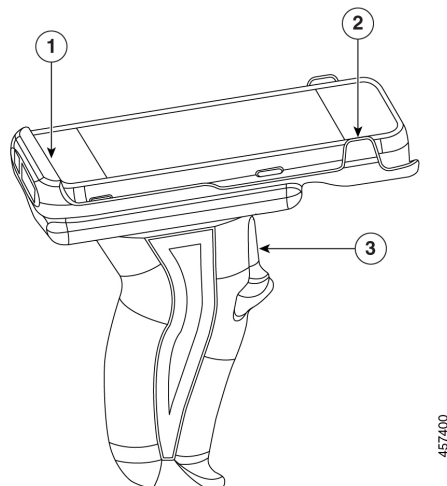

## Procedure

- 
- Step 1** Insert the bottom end of the Cisco Wireless Phone 840S in the scanner handle.
  - Step 2** Press down on the top end of the phone to snap it in place on the scanner handle.
  - Step 3** Scan a barcode with the trigger on the scanner handle to test that it works.
- 

### Related Topics

[Scan a barcode](#), on page 105

## Clips

There are clips available for the Cisco Wireless Phone 840 and 860.

The following illustration is of the rotating belt clip holsters for the Cisco Wireless Phone 840 and 840S. The belt clips for the Cisco Wireless Phone 860 and 860S don't have a holster and aren't interchangeable with the 840 clips.

*Figure 21: Cisco Wireless Phone 840 and 840S and clips*



## Cisco accessory part numbers

The following tables provide the part numbers for the approved Cisco accessories for the Cisco Wireless Phone 840 and 860. For more information, see the [Cisco Wireless Phone Data Sheet](#).



---

**Caution** Use only the approved chargers and power supplies for your phone.

---

**Table 35: Desktop chargers and power supplies**

<b>Accessory</b>	<b>Part number</b>	<b>Power supply model number</b>
Cisco Wireless Phone 840 Desktop Charger	CP-840-PH-DCHR=	—
Cisco Wireless Phone 840 Desktop Dual Charger	CP-840-DUAL-DCHR=	—
Cisco Wireless Phone 840 Desktop Charger and Cisco Wireless Phone 840 Desktop Dual Charger power supply for Australia	CP-840-DCHR-PS-AU=	SK01T8-0570260S
Cisco Wireless Phone 840 Desktop Charger and Cisco Wireless Phone 840 Desktop Dual Charger power supply for the European Union	CP-840-DCHR-PS-EU=	SK01T8-0570260V
Cisco Wireless Phone 840 Desktop Charger and Cisco Wireless Phone 840 Desktop Dual Charger power supply for North America	CP-840-DCHR-PS-NA=	SK01T8-0570260U
Cisco Wireless Phone 840 Desktop Charger and Cisco Wireless Phone 840 Desktop Dual Charger power supply for the United Kingdom	CP-840-DCHR-PS-UK=	SK01T8-0570260B
Cisco Wireless Phone 860 Desktop Dual Charger Module	CP-860-DCHR=	—
Cisco Wireless Phone 860 Desktop Battery Charger Module	CP-860-BAT-DCHR=	—
Cisco Wireless Phone 860 Desktop Dual Charger Module and Cisco Wireless Phone 860 Desktop Battery Charger Module power supply	CP-860-DCHR-PSU=	HK-AY-120A200-CP

**Table 36: Multichargers and power supplies**

<b>Accessory</b>	<b>Part number</b>	<b>Power supply model number</b>
Cisco Wireless Phone 840 Multicharger with power supply	CP-840-PH-MCHR=	KT090A1200667B3
Cisco Wireless Phone 840 Battery Multicharger with power supply	CP-840-BAT-MCHR=	KT090A1200667B3
Cisco Wireless Phone 860 Multicharger Base with power supply	CP-860-MCHR=	FSP090-ABAN3

**Table 37: USB cable and power adapter**

Accessory	Part number	Power adapter model number
Cisco Wireless Phone 840 and 860 USB cable and power adapter wall plug	CP-800-USBCH=	IN-CA-310Q

**Table 38: Spare batteries**

Accessory	Part number
Cisco Wireless Phone 840 and 840S spare battery	CP-840-BAT=
Cisco Wireless Phone 860 and 860S spare battery	CP-860-BAT=

**Table 39: Scanner handle**

Accessory	Part number
Cisco Wireless Phone 840S scanner handle	CP-840S-HANDLE=

**Table 40: Clips**

Accessory	Part number
Cisco Wireless Phone 840 rotating belt clip holster	CP-840-CLIP=
Cisco Wireless Phone 840S rotating belt clip holster	CP-840S-CLIP=
Cisco Wireless Phone 860 belt clip	CP-860-CLIP=
Cisco Wireless Phone 860S belt clip	CP-860S-CLIP=

**Table 41: Cases**

Accessory	Part number
Cisco Wireless Phone 860 case	CP-860-CASE=
Cisco Wireless Phone 860S case	CP-860S-CASE=





# CHAPTER 11

## Troubleshooting

- General troubleshooting, on page 133
- Find call server registration information, on page 134
- Capture a screenshot on the phone, on page 134
- Create a problem report from the phone, on page 135

## General troubleshooting

### General troubleshooting

The following table provides general troubleshooting information.

*Table 42: General troubleshooting tips*



Problem	Solution
You're not in a call and the phone goes black and displays the message: <b>Close proximity detected</b> .	Your phone has a proximity sensor at the top right. When this sensor is blocked, the phone screen is black. The sensor is normally blocked by the face when the earpiece is used to listen to a caller.  If you're not in a call and you see the message: <b>Close proximity detected</b> . The sensor may be covered with a finger or paper or something else that blocks light. If there's no apparent blockage, clean the area of the sensor.
While using a standard headset, you experience a scratchy or intermittent signal.	The headset connector may be dirty. If available, blow canned air into the connector to clear debris. Always point canned air orientation at glancing angles away from your face and eyes and always wear safety goggles or glasses when performing this procedure.  Do not use air compressors on the connectors, since they apply too much force.
Third Party Application Conflicts	Third party application interference can be eliminated by factory reset and reregistration of a problematic phone. For more details about the factory reset, see Restoring Factory Defaults in the <a href="#">Cisco Wireless Phone 840 and 860 Deployment Guide</a> .

## Find call server registration information

The **Cisco Phone status** screen gives you call server registration information. Your administrator may ask you for this information when you call for support.

### Procedure

---

- Step 1** Access the **Cisco Phone**  app.
- Step 2** Choose one of the following based on your phone's software version:
- For release 1.2(0), tap the **Overflow**  menu.
  - For release 1.3(0) or later, tap the **Drawer**  menu.
- Step 3** Tap **Cisco Phone status**.
- 

## Capture a screenshot on the phone

When troubleshooting, it may be helpful to have a screenshot of the phone.



- Note** An alternate way to capture a screenshot on the phone is to press the **Power** and **Volume down** buttons at the same time.
- 

### Procedure

---

- Step 1** Press and hold the **Power** button.
- Step 2** Tap **Screenshot**.  
A notification briefly pops to the foreground and then appears in the notification drawer.
- Step 3** Tap the notification to **Share**, **Edit**, or **Delete** the screenshot.

**Note**

Unless you delete a screenshot, you can also locate it in the **Files**  app, if available.

---

# Create a problem report from the phone

If you experience a problem with your phone, you can create a bundle of log reports that can help the administrator troubleshoot the issue. It may take several minutes to generate the problem report and log files. You'll know that the report is complete when the phone vibrates twice.





---

**Note** If your phone's web browser is enabled, you can download the log bundle files to give to the administrator.

---

## Procedure

- 
- Step 1** Access the **Cisco Phone**  app.
- Step 2** Choose one of the following based on your phone's software version:
- For release 1.2(0), tap the **Overflow**  menu.
  - For release 1.3(0) or later, tap the **Drawer**  menu.
- Step 3** Choose one of the following based on your phone's software version:
- For release 1.2(0), select **Settings > Phone information > Report problem**.
  - For release 1.3(0) or later, tap **Report problem**.
- Step 4** After the phone vibrates twice, contact your administrator to provide a description of the issue and approximate time.
- Step 5** If your phone's web browser is enabled, download the log bundle from the **Device Logs** tab to provide to the administrator.
-





# CHAPTER 12

## Product Safety and Security

- [Safety and Performance Information, on page 137](#)
- [Compliance Statements, on page 141](#)
- [Cisco Product Security Overview, on page 146](#)
- [Important Online Information, on page 146](#)

### Safety and Performance Information

Read the following safety notices before installing or using your IP phone.



---

**Warning** IMPORTANT SAFETY INSTRUCTIONS

This warning symbol means danger. You are in a situation that could cause bodily injury. Before you work on any equipment, be aware of the hazards involved with electrical circuitry and be familiar with standard practices for preventing accidents. Use the statement number provided at the end of each warning to locate its translation in the translated safety warnings that accompanied this device. Statement 1071

SAVE THESE INSTRUCTIONS

---



---

**Warning** Read the installation instructions before using, installing, or connecting the system to the power source. Statement 1004

---



---

**Warning** Voice over IP (VoIP) service and the emergency calling service do not function if power fails or is disrupted. After power is restored, you might have to reset or reconfigure equipment to regain access to VoIP and the emergency calling service. In the USA, this emergency number is 911. You need to be aware of the emergency number in your country. Statement 361

---



---

**Warning** Ultimate disposal of this product should be handled according to all national laws and regulations. Statement 1040

---

**Warning**

The plug-socket combination must be accessible at all times because it serves as the main disconnecting device. Statement 1019

## Safety Guidelines

- Do not use this product as the primary communications tool in healthcare environments, as it may use an unregulated frequency band that is susceptible to interference from other devices or equipment.
- The use of wireless devices in hospitals is restricted to the limits set forth by each hospital.
- The use of wireless devices in hazardous locations is limited to the constraints posed by the safety directors of such environments.
- The use of wireless devices on airplanes is governed by the Federal Aviation Administration (FAA).

## Battery Safety Notices

**Warning**

There is the danger of explosion if the battery is replaced incorrectly. Replace the battery only with the same or equivalent type recommended by the manufacturer. Dispose of used batteries according to the manufacturer's instructions. Statement 1015

**Warning**

Do not touch or bridge the metal contacts on the battery. Unintentional discharge of the batteries can cause serious burns. Statement 341

**Warning**

Explosion Hazard: Do not charge the phone battery in a potentially explosive environment. Statement 431

**Warning**

Lithium ion batteries have limited lifetimes. Any lithium ion battery that shows any signs of damage, including swelling, should be properly discarded immediately.

**Caution**

- Do not dispose of the battery pack in fire or water. The battery may explode if placed in a fire.
- Do not disassemble, crush, puncture, or incinerate the battery pack.
- Handle a damaged or leaking battery with extreme care. If you come in contact with the electrolyte, wash the exposed area with soap and water. If the electrolyte has come in contact with the eye, flush the eye with water for 15 minutes and seek medical attention.
- Do not charge the battery pack if the ambient temperature exceeds 104 degrees Fahrenheit (40 degrees Celsius).
- Do not expose the battery pack to high storage temperatures (above 140 degrees Fahrenheit, 60 degrees Celsius).
- When discarding a battery pack, contact your local waste disposal provider regarding local restrictions on the disposal or recycling of batteries.

To obtain a battery, contact your local dealer. Use only the batteries that have a Cisco part number.

## Power Outage

The ability to access emergency service through the phone depends on the wireless access point being powered. If there is an interruption in the power supply, Service and Emergency Calling Service dialing will not function until power is restored. In the case of a power failure or disruption, you may need to reset or reconfigure equipment before using the Service or Emergency Calling Service dialing.

## Regulatory Domains

The radio frequency (RF) for this phone is configured for a specific regulatory domain. If you use this phone outside of the specific regulatory domain, the phone will not function properly, and you might violate local regulations.

## Health-Care Environments

This product is not a medical device and uses an unlicensed frequency band that is susceptible to interference from other devices or equipment.

## External Devices Usage

Cisco recommends the use of good quality external devices (such as headsets) that are shielded against unwanted radio frequency (RF) and audio frequency (AF) signals.

Depending on the quality of these devices and their proximity to other devices such as mobile phones or two-way radios, some audio noise may still occur. In these cases, Cisco recommends that you take one or more of the following actions:

- Move the external device away from the source of the RF or AF signals.
- Route the external device cables away from the source of the RF or AF signals.

- Use shielded cables for the external device, or use cables with a better shield and connector.
- Shorten the length of the external device cable.
- Apply ferrites or other such devices on the cables for the external device.

Cisco cannot guarantee the performance of the system because Cisco has no control over the quality of external devices, cables, and connectors. The system will perform adequately when suitable devices are attached using good quality cables and connectors.



**Caution** In European Union countries, use only external headsets that are fully compliant with the EMC Directive [89/336/EC].

## Phone Behavior During Times of Network Congestion

Anything that degrades network performance can affect phone audio and video quality, and in some cases, can cause a call to drop. Sources of network degradation can include, but are not limited to, the following activities:

- Administrative tasks, such as an internal port scan or security scan.
- Attacks that occur on your network, such as a Denial of Service attack.

## SAR

	<p>This product meets applicable national SAR limits of 1.6W/kg. The specific maximum SAR values can be found in <a href="#">Compliance Statements, on page 141</a>.</p> <p>When carrying the product or using it while worn on your body, either use an approved accessory such as a holster or otherwise maintain a distance of 5 mm from the body to ensure compliance with RF exposure requirements. Note that the product may be transmitting even if you are not making a phone call.</p>
---	---

## Product Label

The product label is located in the battery compartment of the device.

The label on the bottom of the charger base has the regulatory information.

# Compliance Statements

## Compliance Statements for the European Union

### CE Marking

The following CE mark is affixed to the equipment and packaging.



### RF Exposure Statement for the European Union

This device has been evaluated and found compliant in accordance with EU EMF Directive 2014/53/EU.

## Compliance Statements for the USA

### SAR Statement

The Cisco Wireless Phone 840 and 860 handsets have been tested for body-worn Specific Absorption Rate (SAR) compliance using the specific belt-clip/holster configuration provided with the handset. The FCC has established the detailed body-worn SAR requirements and has established that these requirements have been met with the specific belt-clip/holster provided with the handset. Other belt-clip/holsters or similar accessories that have not been tested may not comply and therefore should be avoided.

### RF Exposure Information

The radio module has been evaluated found to be compliant to the requirements as set forth in 47 CFR Sections 2.1091, 2.1093, and 15.247 (b) (4) addressing RF Exposure from radio frequency devices. This model meets the applicable government requirements for exposure to radio frequency waves.

#### THIS DEVICE MEETS THE LIMITS AS REFERENCED BY ISED RSS-102 R5 FOR EXPOSURE TO RADIO WAVES

Your Cisco Wireless Phone 840 and 860 device includes a radio transmitter and receiver. It is designed not to exceed the General populace (uncontrolled ) limits for exposure to radio waves (radio frequency electromagnetic fields) as referenced in RSS-102 which references Health Canada Safety Code 6 and include a substantial safety margin designed to assure the safety of all persons, regardless of age and health.

As such the systems are designed to be operated as to avoid contact with the antennas by the end user. It is recommended to set the system in a location where the antennas can remain at least a minimum distance as specified from the user in accordance to the regulatory guidelines which are designed to reduce the overall exposure of the user or operator.

The device has been tested and found compliant with the applicable regulations as part of the radio certification process.

<b>Maximum SAR for this Model and Conditions Under Which it was Recorded</b>		
<b>Head SAR</b>	WLAN 5GHz	0.63 W/kg
<b>Body-worn SAR</b>	WLAN 5GHz	0.67 W/kg

This wireless phone contains a radio transceiver. The radio transceiver and antenna have been designed to meet the RF emission requirements for human exposure as specified by the FCC as well as by other agencies from other countries. These guidelines were developed by the industry based on guidance from the World Health Organization (WHO). These industry standards have been developed to include additional safety margins to ensure that the user is exposed to the least amount of RF radiation.

The radio transceiver uses a non ionization type of radiation as opposed to an ionized radiation such as an X-Ray wave.

The exposure standard for these devices references a unit of measure known as SAR. The limit as set by the FCC is 1.6W/kg. The tests for this emission level is done in an independent laboratory who employs test methods and operating positions reviewed by the FCC and other agencies.

Before the phone was placed on the market, the product was tested and certified in accordance with the FCC regulations to verify that the product did not exceed the FCC SAR requirements.

Additional information on SAR and RF Exposure can be obtained off the FCC website at: <http://www.fcc.gov/oet/rfsafety>

There is no conclusive proof that these mobile phones are or are not a health risk. The FDA and numerous researchers are continuing studies of RF radiation and health issues. Additional information on this subject can be obtained from the FDA web site at: <http://www.fda.gov>

The Cisco Wireless Phone 840 and 860 operates at power levels that are 5 to 6 times lower than most standard cellular, Personal Communications Service (PCS), or Global System for Mobile Communication (GSM) phones. This lower power coupled with a lower transmitter duty cycle reduces the user's exposure to the RF fields.

There are several suggested methods to reduce exposure for the user. Among those include:

1. Using a hands-free handset to increase the distance between the antenna and the head of the user.
2. Orienting the antenna away from the user.

Additional information can be obtained from the following documentation:

- Cisco Systems Spread Spectrum Radios and RF Safety white paper at the following location: [http://www.cisco.com/warp/public/cc/pd/witc/ao340ap/prodlit/rfhr\\_wi.htm](http://www.cisco.com/warp/public/cc/pd/witc/ao340ap/prodlit/rfhr_wi.htm)
- FCC Bulletin 56: Questions and Answers about Biological Effects and Potential Hazards of Radio Frequency Electromagnetic Fields
- FCC Bulletin 65: Evaluating Compliance with the FCC guidelines for Human Exposure to Radio Frequency Electromagnetic Fields

Additional information can also be obtained from the following organizations:

- World Health Organization Internal Commission on Non-Ionizing Radiation Protection at <http://www.who.int/emf>
- United Kingdom, National Radiological Protection Board at <http://www.nrpb.org.uk>

- Cellular Telecommunications Association at <http://www.wow-com.com>

## General RF Exposure Compliance

This device has been evaluated and found compliant to the ICNIRP (International Committee on Non-Ionizing Radiation Protection) limits for Human Exposure of RF Exposure.

## Part 15 Radio Device

**Caution**

The Part 15 radio device operates on a non-interference basis with other devices operating at this frequency. Any changes or modification to said product not expressly approved by Cisco, including the use of non-Cisco antennas, could void the user's authority to operate this device.

## Compliance Statements for Canada

This device complies with Industry Canada license-exempt RSS standard(s). Operation is subject to the following two conditions: (1) this device may not cause interference, and (2) this device must accept any interference, including interference that may cause undesired operation of the device. Privacy of communications may not be ensured when using this phone.

This product meets the applicable Innovation, Science and Economic Development Canada technical specifications.

### Avis de Conformité Canadien

Cet appareil est conforme aux normes RSS exemptes de licence RSS d'Industry Canada. Le fonctionnement de cet appareil est soumis à deux conditions : (1) ce périphérique ne doit pas causer d'interférence et (2) ce périphérique doit supporter les interférences, y compris celles susceptibles d'entraîner un fonctionnement non souhaitable de l'appareil. La protection des communications ne peut pas être assurée lors de l'utilisation de ce téléphone.

Le présent produit est conforme aux spécifications techniques applicables d'Innovation, Sciences et Développement économique Canada.

The device meets the exemption from the routine evaluation limits in section 2.5 of RSS 102 and compliance with RSS-102 RF exposure, users can obtain Canadian information on RF exposure and compliance. Le dispositif rencontre l'exemption des limites courantes d'évaluation dans la section 2.5 de RSS 102 et la conformité à l'exposition de RSS-102 rf, utilisateurs peut obtenir l'information canadienne sur l'exposition et la conformité de rf.

This transmitter must not be co-located or operating in conjunction with any other antenna or transmitter. This equipment should be installed and operated with a minimum distance of 20 centimeters between the radiator and your body.

Cet émetteur ne doit pas être Co-placé ou ne fonctionnant en même temps qu'aucune autre antenne ou émetteur. Cet équipement devrait être installé et actionné avec une distance minimum de 20 centimètres entre le radiateur et votre corps.

the device for operation in the band 5150–5250 MHz is only for indoor use to reduce the potential for harmful interference to co-channel mobile satellite systems;

for devices with detachable antenna(s), the maximum antenna gain permitted for devices in the bands 5250-5350 MHz and 5470-5725 MHz shall be such that the equipment still complies with the e.i.r.p. limit;

for devices with detachable antenna(s), the maximum antenna gain permitted for devices in the band 5725-5850 MHz shall be such that the equipment still complies with the e.i.r.p. limits specified for point-to-point and non-point-to-point operation as appropriate.

les dispositifs fonctionnant dans la bande 5150-5250 MHz sont réservés uniquement pour une utilisation à l'intérieur afin de réduire les risques de brouillage préjudiciable aux systèmes de satellites mobiles utilisant les mêmes canaux;

le gain maximal d'antenne permis pour les dispositifs utilisant les bandes 5250-5350 MHz et 5470-5725 MHz doit se conformer à la limite de p.i.r.e.;

le gain maximal d'antenne permis (pour les dispositifs utilisant la bande 5725-5850 MHz) doit se conformer à la limite de p.i.r.e. spécifiée pour l'exploitation point à point et non point à point, selon le cas.

## Canadian RF Exposure Statement

### THIS DEVICE MEETS THE LIMITS AS REFERENCED BY ISSED RSS-102 R5 FOR EXPOSURE TO RADIO WAVES

Your device includes a radio transmitter and receiver. It is designed not to exceed the General populace (uncontrolled) limits for exposure to radio waves (radio frequency electromagnetic fields) as referenced in RSS-102 which references Health Canada Safety Code 6 and include a substantial safety margin designed to assure the safety of all persons, regardless of age and health.

As such the systems are designed to be operated as to avoid contact with the antennas by the end user. It is recommended to set the system in a location where the antennas can remain at least a minimum distance as specified from the user in accordance to the regulatory guidelines which are designed to reduce the overall exposure of the user or operator.

The device has been tested and found compliant with the applicable regulations as part of the radio certification process.

### **Déclaration d'Exposition aux RF Canadienne**

### CE PÉRIPHÉRIQUE RESPECTE LES LIMITES DÉCRITES PAR LA NORME RSS-102 R5 D'EXPOSITION À DES ONDES RADIO

Votre appareil comprend un émetteur et un récepteur radio. Il est conçu pour ne pas dépasser les limites applicables à la population générale (ne faisant pas l'objet de contrôles périodiques) d'exposition à des ondes radio (champs électromagnétiques de fréquences radio) comme indiqué dans la norme RSS-102 qui sert de référence au règlement de sécurité n°6 sur l'état de santé du Canada et inclut une marge de sécurité importantes conçue pour garantir la sécurité de toutes les personnes, quels que soient leur âge et état de santé.

En tant que tels, les systèmes sont conçus pour être utilisés en évitant le contact avec les antennes par l'utilisateur final. Il est recommandé de positionner le système à un endroit où les antennes peuvent demeurer à au moins une distance minimum préconisée de l'utilisateur, conformément aux instructions des réglementations qui sont conçues pour réduire l'exposition globale de l'utilisateur ou de l'opérateur.

Le périphérique a été testé et déclaré conforme aux réglementations applicables dans le cadre du processus de certification radio.

## Compliance Statements for New Zealand

### Additional Delay Warning

The Cisco Wireless Phone 840 and 860 introduces additional delay in its speech path.

### Permit to Connect (PTC) General Warning

The grant of a Telepermit for any item of terminal equipment indicates only that Spark NZ has accepted that the item complies with minimum conditions for connection to its network. It indicates no endorsement of the product by Spark NZ, nor does it provide any sort of warranty. Above all, it provides no assurance that any item will work correctly in all respects with another item of Telepermitted equipment of a different make or model, nor does it imply that any product is compatible with all of Spark NZ network services.

### Use of IP Networks with the PSTN

Internet Protocol (IP) by its nature introduces delay into speech signals as each data packet is formulated and addressed. Spark NZ Access Standards recommends that suppliers, designers and installers using this technology for calls to or from the PSTN refer to ITU E Model requirements in the design of their networks. The overall aim is to minimise delay, distortion and other transmission impairments, particularly for those calls involving cellular and international networks, which already suffer extensive delay.

### The Use of Voice Compression Through the PSTN

Because of the extensive delay already experienced when calling cellular and international networks, some of which is already caused by their use of voice compression technologies. Spark NZ Access Standards will only approve G711 voice technology for use on the PSTN. G711 is an ‘instantaneous speech-encoding technique’ whereas G729 and all its variants are considered ‘near instantaneous’ introducing additional delay into the speech signal.

### Echo Cancellation

Echo cancelers are not normally required in the Spark NZ PSTN because geographic delays are acceptable where CPE return loss is maintained within Telepermit limits. However, those private networks that make use of Voice-over-IP (VoIP) technology are required to provide echo cancellation for all voice calls. The combined effect of audio/VoIP conversion delay and IP routing delay can cause the echo cancellation time of 64 mS to be required.

## Compliance Statement for Brazil

This section contains information about wireless operations in Brazil.

Este equipamento não tem direito à proteção contra interferência prejudicial e não pode causar interferência em sistemas devidamente autorizados.

This equipment is not entitled to protection from harmful interference and may not cause interference with duly authorized systems.

#### Informações sobre exposição a RF

Para países que adotam o limite SAR de 2,0 W/kg acima de 10 gramas de tecido. O dispositivo está em conformidade com as especificações de radiofrequência quando utilizado encostado junto do ouvido e dos membros do corpo.

CP-840S: O valor SAR mais alto registrado: SAR na 0,312W/Kg cabeça e 0,582W/Kg corpo

#### **RF Exposure Information**

For countries with a SAR limit of 2.0 W/kg above 10 grams of tissue. The device complies with RF specifications when used against the ear and body.

CP-840S: Highest SAR value recorded: SAR at 0,312W/Kg head and 0,582W/Kg body.

ANATEL: 10295-24-01086

## **Compliance Statement for Singapore**

**Complies with  
IMDA Standards  
DB101992**

## **Cisco Product Security Overview**

This product contains cryptographic features and is subject to U.S. and local country laws that govern import, export, transfer, and use. Delivery of Cisco cryptographic products does not imply third-party authority to import, export, distribute, or use encryption. Importers, exporters, distributors, and users are responsible for compliance with U.S. and local country laws. By using this product, you agree to comply with applicable laws and regulations. If you are unable to comply with U.S. and local laws, return this product immediately.

Further information regarding U.S. export regulations can be found at <https://www.bis.gov/ear>.

## **Important Online Information**

#### **End User License Agreement**

The End User License Agreement (EULA) is located here: <https://www.cisco.com/go/eula>

#### **Regulatory Compliance and Safety Information**

Regulatory Compliance and Safety Information (RCSI) is located here:

[https://www.cisco.com/c/dam/en/us/td/docs/voice\\_ip\\_comm/cuipph/800-series/RCSI/rcsi-0166-book.pdf](https://www.cisco.com/c/dam/en/us/td/docs/voice_ip_comm/cuipph/800-series/RCSI/rcsi-0166-book.pdf)