



Maintenance and Service Guide

SUMMARY

This guide provides maintenance information about such topics as spare parts, removal and replacement of parts, security, and backing up.

Legal information

© Copyright 2023 HP Development Company, L.P.

AMD, Freesync, Optimus, Radeon, and Ryzen are trademarks of Advanced Micro Devices, Inc. Bluetooth is a trademark owned by its proprietor and used by HP Inc. under license. The terms HDMI, HDMI High-Definition Multimedia Interface, and the HDMI Logo are trademarks or registered trademarks of HDMI Licensing Administrator, Inc. Microsoft and Windows are either registered trademarks or trademarks of Microsoft Corporation in the United States and/or other countries. Realtek is a trademark of Realtek Semiconductor Corporation. USB Type-C and USB-C are registered trademarks of USB Implementers Forum. Miracast and Wi-Fi are registered trademarks of Wi-Fi Alliance.

The information contained herein is subject to change without notice. The only warranties for HP products and services are set forth in the express warranty statements accompanying such products and services. Nothing herein should be construed as constituting an additional warranty. HP shall not be liable for technical or editorial errors or omissions contained herein.

First Edition: March 2023

Document Part Number: N33469-001

Product notice

This guide describes features that are common to most models. Some features may not be available on your computer.

Not all features are available in all editions or versions of Windows. Systems may require upgraded and/or separately purchased hardware, drivers, software or BIOS update to take full advantage of Windows functionality. Windows is automatically updated, which is always enabled. High-speed internet and Microsoft account required. ISP fees may apply and additional requirements may apply over time for updates. See <http://www.windows.com>.

If your product ships with Windows in S

Mode: Windows in S Mode works exclusively with apps from the Microsoft Store within Windows. Certain default settings, features, and apps cannot be changed. Some accessories and apps that are compatible with Windows may not work (including some antivirus, PDF writers, driver utilities, and accessibility apps), and performance may vary, even if you switch out of S Mode. If you switch to Windows, you cannot switch back to S Mode. Learn more at Windows.com/SmodeFAQ.

To access the latest user guides, go to <http://www.hp.com/support>, and follow the instructions to find your product. Then select **Manuals**.

Software terms

By installing, copying, downloading, or otherwise using any software product preinstalled on this computer, you agree to be bound by the terms of the HP End User License Agreement (EULA). If you do not accept these license terms, your sole remedy is to return the entire unused product (hardware and software) within 14 days for a full refund subject to the refund policy of your seller.

For any further information or to request a full refund of the price of the computer, please contact your seller.

Safety warning notice

Reduce the possibility of heat-related injuries or of overheating the computer by following the practices described.

⚠ WARNING! To reduce the possibility of heat-related injuries or of overheating the computer, do not place the computer directly on your lap or obstruct the computer air vents. Use the computer only on a hard, flat surface. Do not allow another hard surface, such as an adjoining optional printer, or a soft surface, such as pillows or rugs or clothing, to block airflow. Also, do not allow the AC adapter to come into contact with the skin or a soft surface, such as pillows or rugs or clothing, during operation. The computer and the AC adapter comply with the user-accessible surface temperature limits defined by applicable safety standards.

Table of contents

1 Product description	1
2 Getting to know your computer	5
Right side	5
Left side	5
Display	6
Low blue light mode (select products only)	7
Wake-on-voice (select products only)	7
Keyboard area	8
Touchpad settings and components	8
Touchpad settings	8
Adjusting touchpad settings	8
Turning on the touchpad	8
Touchpad components	9
Lights	9
Power button and fingerprint reader	10
Special keys	12
Bottom	13
Labels	14
3 Illustrated parts catalog	16
Computer major components	16
Display assembly subcomponents	18
Miscellaneous parts	20
4 Removal and replacement procedures preliminary requirements	23
Tools required	23
Service considerations	23
Plastic parts	23
Cables and connectors	23
Drive handling	23
Electrostatic discharge information	24
Generating static electricity	24
Preventing electrostatic damage to equipment	25
Personal grounding methods and equipment	25
Grounding the work area	26
Recommended materials and equipment	26
Cleaning your computer	27
Enabling HP Easy Clean (select products only)	27
Removing dirt and debris from your computer	27
Cleaning your computer with a disinfectant	28

Caring for wood veneer (select products only)	29
Packaging and transporting guidelines.....	29
Accessing support information	30
5 Removal and replacement procedures for authorized service provider parts.....	32
Component replacement procedures	32
Preparation for disassembly.....	32
Bottom cover	32
Battery.....	33
Solid-state drive.....	35
Memory modules (select products only).....	36
WLAN module.....	37
Speakers.....	39
Heat sink	40
Fan.....	41
Fingerprint reader (select products only).....	42
USB board.....	43
Power connector cable	44
System board	45
Touchpad	47
Display assembly.....	49
Top cover with keyboard	55
6 Using Setup Utility (BIOS).....	57
Starting Setup Utility (BIOS).....	57
Updating Setup Utility (BIOS).....	57
Determining the BIOS version.....	57
Preparing for a BIOS update	58
Downloading a BIOS update	58
Installing a BIOS update	58
7 Backing up, restoring, and recovering.....	60
Backing up information and creating recovery media.....	60
Using Windows tools for backing up.....	60
Using the HP Cloud Recovery Download Tool to create recovery media (select products only).....	60
Restoring and recovering your system	60
Creating a system restore	61
Restoring and recovery methods	61
Recovering using HP Recovery media	61
Changing the computer boot order	62
Using HP Sure Recover (select products only).....	62
8 Using HP PC Hardware Diagnostics	63
Using HP PC Hardware Diagnostics Windows (select products only).....	63
Using an HP PC Hardware Diagnostics Windows hardware failure ID code.....	63
Accessing HP PC Hardware Diagnostics Windows	63
Accessing HP PC Hardware Diagnostics Windows from HP Support Assistant	63
Accessing HP PC Hardware Diagnostics Windows from the Start menu (select products only).....	64

Downloading HP PC Hardware Diagnostics Windows.....	64
Downloading the latest HP PC Hardware Diagnostics Windows version from HP	64
Downloading the HP PC Hardware Diagnostics Windows from the Microsoft Store	64
Downloading HP Hardware Diagnostics Windows by product name or number (select products only)	64
Installing HP PC Hardware Diagnostics Windows.....	65
Using HP PC Hardware Diagnostics UEFI	65
Using an HP PC Hardware Diagnostics UEFI hardware failure ID code.....	65
Starting HP PC Hardware Diagnostics UEFI	65
Downloading HP PC Hardware Diagnostics UEFI to a USB flash drive.....	66
Downloading the latest HP PC Hardware Diagnostics UEFI version.....	66
Downloading HP PC Hardware Diagnostics UEFI by product name or number (select products only)	66
Using Remote HP PC Hardware Diagnostics UEFI settings (select products only).....	67
Downloading Remote HP PC Hardware Diagnostics UEFI	67
Downloading the latest Remote HP PC Hardware Diagnostics UEFI version.....	67
Downloading Remote HP PC Hardware Diagnostics UEFI by product name or number	67
Customizing Remote HP PC Hardware Diagnostics UEFI settings.....	67
9 Specifications.....	69
Computer specifications	69
Display specifications.....	69
Solid-state drive specifications	70
10 Statement of memory volatility.....	72
Current BIOS steps	72
Nonvolatile memory usage	74
Questions and answers	74
Using HP Sure Start (select products only).....	76
11 Power cord set requirements.....	77
Requirements for all countries	77
Requirements for specific countries and regions.....	77
12 Recycling.....	79
Index.....	80

1 Product description

This table provides detailed product information.

Table 1-1 Product components and their descriptions

Category	Description
Product Name	HP 255 15.6 inch G10 Notebook PC
Processor	AMD® processors AMD Ryzen™ 7 7730U processor AMD Ryzen 5 7530U processor AMD Ryzen 3 7330U processor AMD Ryzen 5 7520U processor AMD Ryzen 3 7320U processor
Graphics controller	AMD Radeon® Graphics Supports HD decode, DX12, and HDMI Supports Optimus™ Supports GPU Performance Scaling (GPS) Supports FreeSync™ (internal and external, FHD panels only)
Display	39.6 cm (15.6 in), liquid crystal display (LCD), white light-emitting diode (WLED) Full high definition (FHD) (1920 × 1080), antiglare, ultrawide viewing angle (UWVA), sRGB 100%, eDP 1.4 + panel self-refresh (PSR) 2, low blue light, 300 nits FHD, antiglare, eDP 1.2 without PSR, 45% NTSC, antiglare, UWVA, 250 nits FHD, antiglare, eDP 1.2 without PSR, 45% NTSC, antiglare, standard viewing angle (SVA), 250 nits High definition (HD) (1366 × 768), eDP 1.2 without PSR, 45% NTSC, antiglare, SVA, 250 nits

Table 1-1 Product components and their descriptions (continued)

Category	Description
Memory	Models with 7520U, 7320U processors
	Onboard memory supporting up to 16 GB of RAM (not accessible or upgradeable)
	LPDDR5-5500, single channel support
	Supports the following configurations:
	<ul style="list-style-type: none"> • 8 GB
	<ul style="list-style-type: none"> • 4 GB
	Models with 7730U, 7530U, 7330U processors
	Two SODIMM slots supporting up to 16 GB of RAM
	DDR4-3200 dual channel support
	Supports the following configurations:
<ul style="list-style-type: none"> • 16 GB 	
<ul style="list-style-type: none"> • 8 GB 	
<ul style="list-style-type: none"> • 4 GB 	
Primary storage	M.2 solid-state drive, 2280, PCIe, non-volatile memory express (NVMe)
	1 TB
	512 GB
	256 GB
	M.2, 2230, PCIe, NVMe
128 GB	
Audio	Dual speakers
	myHP Audio Control
	Supports Far Field Cortana
Video	HP True Vision HD camera - indicator LED, USB 2.0, HD BSI sensor, f2.0, 76° NFOV
	720p by 30 frames per second (fps)
	Dual-array, digital microphone with appropriate software - beam forming, echo cancellation, noise suppression
	HP True Vision FHD camera - indicator LED, USB 2.0, HD BSI sensor, f2.0, 80° NFOV (available on models with 7730U/7530U/7330U processors)
	1080p by 30 fps
	Dual-array, digital microphone with appropriate software - beam forming, echo cancellation, noise suppression

Table 1-1 Product components and their descriptions (continued)

Category	Description
Wireless	Wireless Local Area Network (WLAN)
	<ul style="list-style-type: none"> Realtek™ Wi-Fi 6 RTL8852BE-VS + Bluetooth® 5.3 (802.11 ax 1 × 1) Realtek Wi-Fi 6 RTL8852BE+ Bluetooth 5.3 (802.11 ax 2 × 2)
	Support for Miracast®
	Turbo Lite WLAN SVTP
	Supports Modern Standby (connected)
Ports	Audio-out (headphone)/audio-in (microphone) combo jack
	AC Smart Pin adapter plug
	HDMI v1.4b + HDCP 2.0 supporting 1080p up to 1920 × 1080 @ 60 Hz
	USB 3.2 Gen 1 Type-A ports (2) (left and right sides)
	USB 3.2 Type-C® Gen1 port, supports data transfer (left side)
Keyboard/pointing devices	Keyboard, island style with numeric keypad
	Textured, backlit, turbo silver
	Textured, not backlit, turbo silver
	Textured, not backlit, dark ash silver
	Clickpad with image sensor
	Supports modern touchpad gestures
	Multitouch gestures enabled
	Precision touchpad supported
Taps enabled as default	
Power requirements	Battery
	3 cell, 41 Whr
	Long life
	Fast charge
	HP Smart AC adapter (4.5 mm, non-power correction factor [nPFC], 1.8 m [6 ft])
	65 W
	45 W
	45 W, for Argentina
	Power cord
	C5, 1.0 m (3.3 ft)
C5, conventional, 1.0 m (3.3 ft)	
Security	Fingerprint reader (select products only)
	Camera privacy cover
	Trusted Platform Module (TPM) 2.0

Table 1-1 Product components and their descriptions (continued)

Category	Description
Operating system	Windows® 11 Home 64
	Windows 11 Home 64 Chinese Market CPPP
	Windows 11 Home 64 High-End Chinese Market CPPP
	Windows 11 Home 64 Plus
	Windows 11 Home 64 Plus Single Language
	Windows 11 Home 64 Plus Single Language Africa Market PPP
	Windows 11 Home 64 Plus Single Language APAC EM PPP
	Windows 11 Home 64 Plus Single Language India Market PPP
	Windows 11 Home 64 Plus Single Language Indonesia Market PPP
	Windows 11 Home 64 Single Language
	Windows 11 Home 64 Single Language Africa Market PPP
	Windows 11 Home 64 Single Language APAC EM PPP
	Windows 11 Home 64 Single Language India Market PPP
	Windows 11 Home 64 Single Language Indonesia Market PPP
	Windows 11 Home 64 Single Language Value Africa Market PPP
	Windows 11 Home 64 Single Language Value APAC EM PPP
	Windows 11 Home 64 Single Language Value India Market PPP
	Windows 11 Home 64 Single Language Value Indonesia Market PPP
	Windows 11 Home 64 Value Single Language
	Windows 11 Home 64 StF MSNA for Higher Education Strategic
	Windows 11 Home Pro 64
	Windows 11 Home Pro 64 Chinese Market
	Windows 11 Home Pro 64 StF MSNA Standard
	Windows 11 Home Pro 64 StF MSNA Strategic
	Windows 11 Home Pro 64 Value
	Windows 11 Home Pro 64 Value Chinese Market
	FreeDOS 3.0
Serviceability	AC adapter

2 Getting to know your computer

Your computer features top-rated components. This chapter provides details about your components, where they are located, and how they work.

Right side

Identify the components on the right side of the computer.

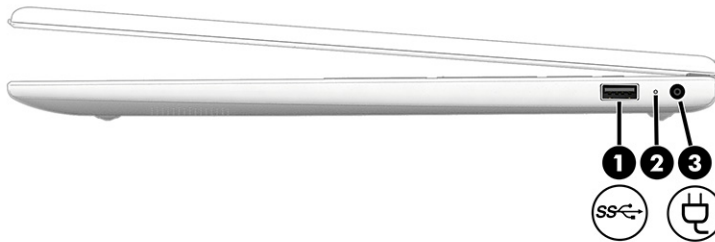



Table 2-1 Right-side components and their descriptions

Component	Description
(1)  USB SuperSpeed port	<p>Connects a USB device, provides high-speed data transfer, and (for select products) charges small devices (such as a smartphone) when the computer is on or in Sleep mode.</p> <p>NOTE: Use a standard USB Type-A charging cable or cable adapter (purchased separately) when charging a small external device.</p>
(2)	<p>AC adapter and battery light</p> <ul style="list-style-type: none">• White: The AC adapter is connected and the battery is fully charged.• Blinking amber: The AC adapter is disconnected and the battery has reached a low battery level.• Amber: The AC adapter is connected and the battery is charging.• Off: The battery is not charging.
(3) 	<p>Power connector</p> <p>Connects an AC adapter.</p>

Left side

Identify the components on the left side of the computer.

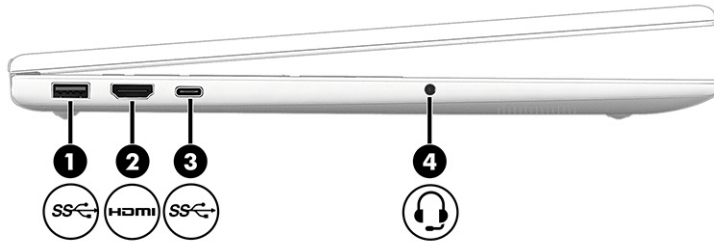





Table 2-2 Left-side components and their descriptions

Component	Description
<p>(1)</p>  <p>USB SuperSpeed port</p>	<p>Connects a USB device, provides high-speed data transfer, and (for select products) charges small devices (such as a smartphone) when the computer is on or in Sleep mode.</p> <p>NOTE: Use a standard USB Type-A charging cable or cable adapter (purchased separately) when charging a small external device.</p>
<p>(2)</p>  <p>HDMI® port</p>	<p>Connects an optional video or audio device, such as a high-definition television, any compatible digital or audio component, or a high-speed High-Definition Multimedia Interface® (HDMI) device.</p>
<p>(3)</p>  <p>USB Type-C® SuperSpeed port</p>	<p>Connects a USB device, provides high-speed data transfer, and (for select products) charges small devices (such as a smartphone) when the computer is on or in Sleep mode.</p> <p>NOTE: Use a standard USB Type-C charging cable or cable adapter (purchased separately) when charging a small external device.</p>
<p>(4)</p>  <p>Audio-out (headphone)/Audio-in (microphone) combo jack</p>	<p>Connects optional powered stereo speakers, headphones, earbuds, a headset, or a television audio cable. Also connects an optional headset microphone. This jack does not support optional standalone microphones.</p> <p>WARNING! To reduce the risk of personal injury, adjust the volume before putting on headphones, earbuds, or a headset. For additional safety information, see the <i>Regulatory, Safety, and Environmental Notices</i>.</p> <p>To access this guide:</p> <ul style="list-style-type: none"> ■ Select the Search icon in the taskbar, type HP Documentation in the search box, and then select HP Documentation. <p>NOTE: When a device is connected to the jack, the computer speakers are disabled.</p>

Display

The computer display can include essential components such as speakers, antennas, cameras, and microphones.

Low blue light mode (select products only)

Your computer display is shipped from the factory in low blue light mode for improved eye comfort and safety. Also, blue light mode automatically adjusts blue light emissions when you are using the computer at night or for reading.

⚠ WARNING! To reduce the risk of serious injury, read the *Safety & Comfort Guide*. It describes proper workstation setup and proper posture, health, and work habits for computer users. The *Safety & Comfort Guide* also provides important electrical and mechanical safety information. The *Safety & Comfort Guide* is available on the web at <http://www.hp.com/ergo>.

Wake-on-voice (select products only)

Use the wake-on-voice feature to bring the computer out of the Sleep state quickly.

To access the wake-on-voice settings, follow these steps:

1. Select the **Search** icon in the taskbar, type `XiaoWei` in the search box, and then select **XiaoWei**.
2. When the tool opens, scan the QR code with your mobile device, which takes you to the settings page, where you can select your wake-on-voice features.
3. Follow the on-screen instructions.

📝 NOTE: Allow the XiaoWei app to continue running on the computer.

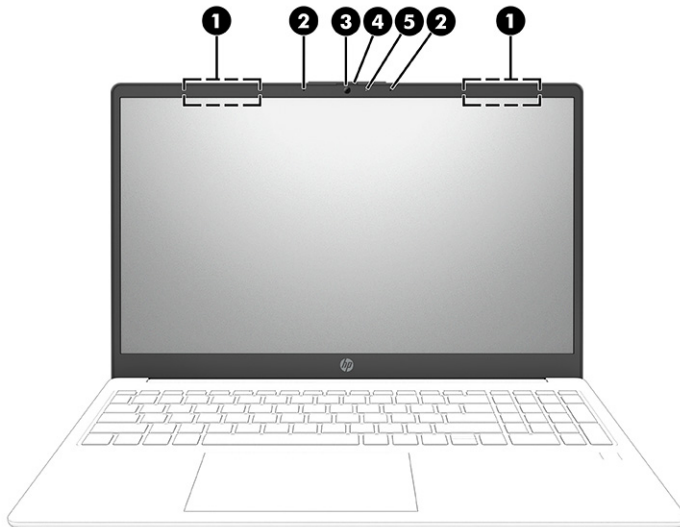

Table 2-3 Display components and their descriptions

Component	Description
(1) WLAN antennas* (2)	Send and receive wireless signals to communicate with wireless local area networks (WLANs).
(2) Internal microphones (2)	Record sound.

Table 2-3 Display components and their descriptions (continued)

Component	Description
(3) Camera	Allows you to video chat, record video, and record still images. Some cameras also allow a facial recognition logon to Windows®, instead of a password logon. NOTE: Camera functions vary depending on the camera hardware and software installed on your product.
(4) Camera privacy cover	By default, the camera lens is uncovered, but you can slide the camera privacy cover to block the camera's view. To use the camera, slide the camera privacy cover in the opposite direction to reveal the lens.
(5) Camera light	On: The camera is in use.

*The antennas are not visible from the outside of the computer. For optimal transmission, keep the areas immediately around the antennas free from obstructions.

For wireless regulatory notices, see the section of the *Regulatory, Safety, and Environmental Notices* that applies to your country or region.

To access this guide:

- Select the **Search** icon in the taskbar, type `HP Documentation` in the search box, and then select **HP Documentation**.

Keyboard area

Keyboards can vary by language.



NOTE: The keyboard area, including the function keys and (select products only) power key, is disabled in stand, tent, and tablet modes. To enable the keyboard, including the power key, change to the clamshell mode.

Touchpad settings and components

Learn the touchpad settings and components.

Touchpad settings

Learn how to adjust touchpad settings.

Adjusting touchpad settings

Use these steps to adjust touchpad settings and gestures.

1. Select the **Search** icon in the taskbar, type `touchpad settings` in the search box, and then press `enter`.
2. Choose a setting.

Turning on the touchpad

Follow these steps to turn on the touchpad.

1. Select the **Search** icon in the taskbar, type `touchpad settings` in the search box, and then press `enter`.

- Using an external mouse, click the **touchpad** button.

If you are not using an external mouse, press the **Tab** key repeatedly until the pointer rests on the **touchpad** button. Then press the **spacebar** to select the button.

Touchpad components

Identify the touchpad components.

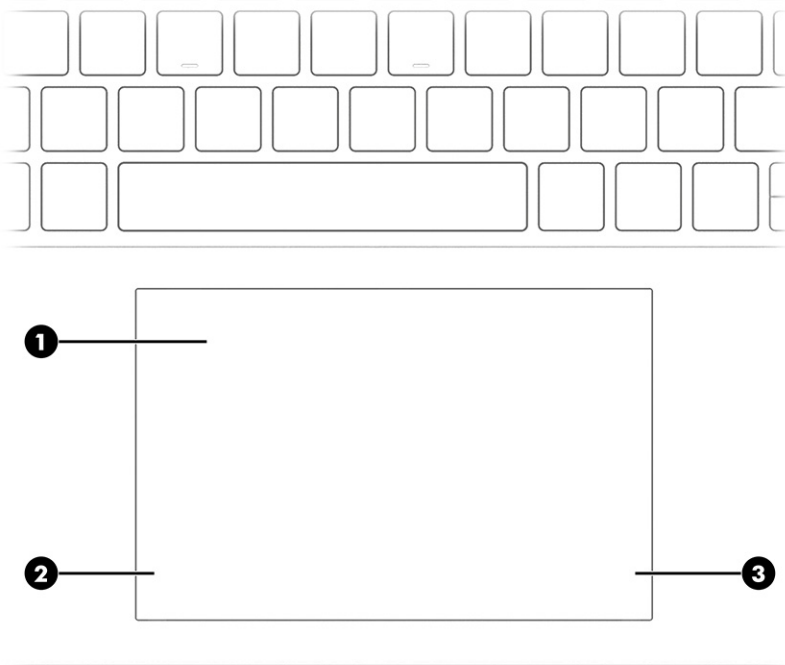

Table 2-4 Touchpad components and their descriptions

Component	Description
(1) Touchpad zone	Reads your finger gestures to move the pointer or activate items on the screen.
(2) Left touchpad button	Functions like the left button on an external mouse.
(3) Right touchpad button	Functions like the right button on an external mouse.

Lights

Identify the lights on the computer.

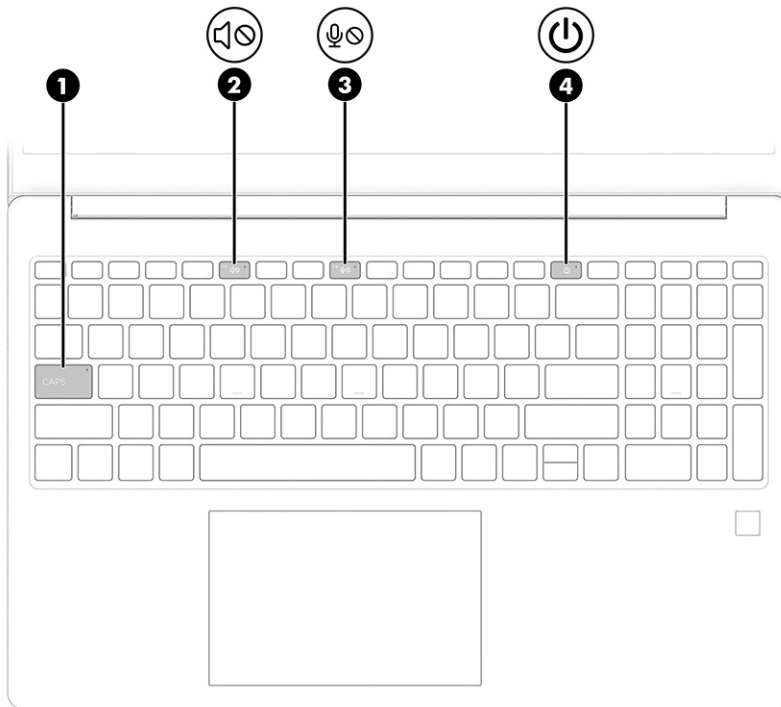



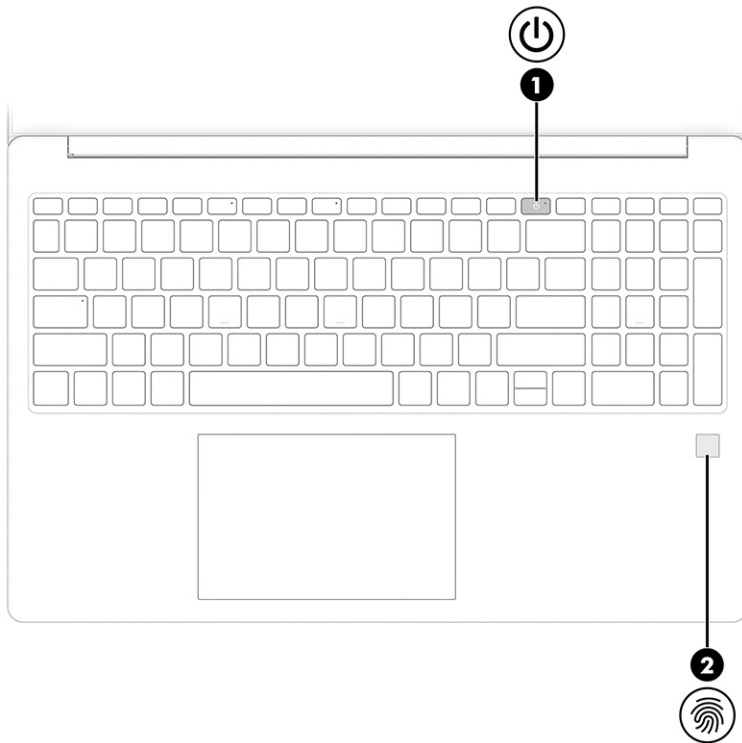

Table 2-5 Lights and their descriptions

Component	Description
(1) Caps lock light	On: Caps lock is on, which switches the key input to all capital letters.
(2)  Mute light	<ul style="list-style-type: none"> On: Computer sound is off. Off: Computer sound is on.
(3)  Microphone mute light	<ul style="list-style-type: none"> On: Microphone is off. Off: Microphone is on.
(4)  Power light	<ul style="list-style-type: none"> On: The computer is on. Blinking (select products only): The computer is in the Sleep state, a power-saving state. The computer shuts off power to the display and other unnecessary components. Off: Depending on your computer model, the computer is off, in Hibernation, or in Sleep. Hibernation is the power-saving state that uses the least amount of power.

Power button and fingerprint reader

Identify the power button (1) and fingerprint reader (2).



Fingerprint readers, which enable a fingerprint logon, can be located on the touchpad, on a side panel of the computer, or on the top cover below the keyboard.





 **IMPORTANT:** To verify that your computer supports fingerprint reader sign-in, select the **Search** icon in the taskbar, type `Sign-in options` in the search box and press `enter`. If **Fingerprint recognition** is not listed as an option, your computer does not include a fingerprint reader.

Table 2-6 Power button and fingerprint reader and their descriptions

Component	Description
<p>(1)  Power button</p>	<ul style="list-style-type: none"> • When the computer is off, press the button briefly to turn on the computer. • When the computer is on, press the button briefly to initiate Sleep. • When the computer is in the Sleep state, press the button briefly to exit Sleep (select products only). • When the computer is in Hibernation, press the button briefly to exit Hibernation. <p>IMPORTANT: Pressing and holding down the power button results in the loss of unsaved information.</p> <p>If the computer has stopped responding and shutdown procedures are ineffective, press and hold the power button down for at least 10 seconds to turn off the computer.</p> <p>To learn more about your power and sleep settings:</p> <ul style="list-style-type: none"> ■ Right-click the Power icon , and then select Power and sleep settings.
<p>(2)  Fingerprint reader (select products only)</p>	<p>Allows a fingerprint logon to Windows, instead of a password logon.</p> <ul style="list-style-type: none"> ■ Touch your finger to the fingerprint reader. <p>IMPORTANT: To prevent fingerprint logon issues, make sure when you register your fingerprint that all sides of your finger are registered by the fingerprint reader.</p>

Special keys

Identify the special keys.

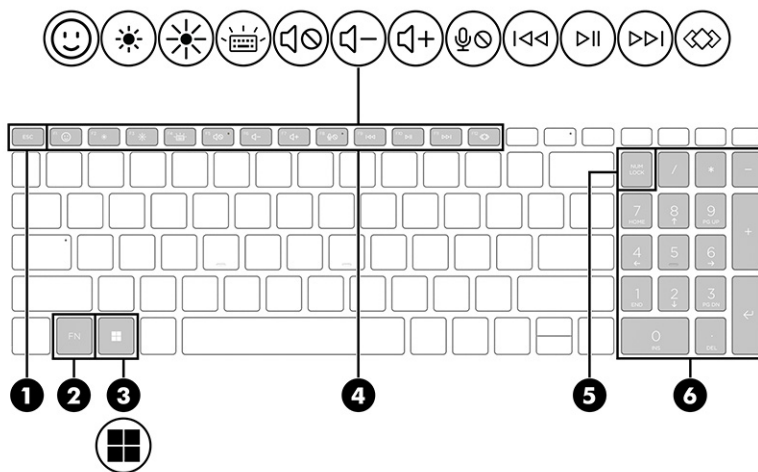



Table 2-7 Special keys and their descriptions

Component	Description
(1) esc key	Displays system information when pressed in combination with the fn key.
(2) fn key	Executes specific functions when pressed in combination with another key.
(3)  Windows key	Opens the Start menu. NOTE: Pressing the Windows key again closes the Start menu.
(4) Action keys	Execute frequently used system functions as defined by the icon symbols on f1 through f12 function keys.
(5) num lock key	Alternates between the navigational and numeric functions on the integrated numeric keypad.
(6) Integrated numeric keypad	A separate keypad to the right of the alphabet keyboard. When num lock is pressed, the keypad can be used like an external numeric keypad. NOTE: If the keypad function is active when the computer is turned off, that function is reinstated when the computer is turned back on.

Bottom

Identify the bottom components.

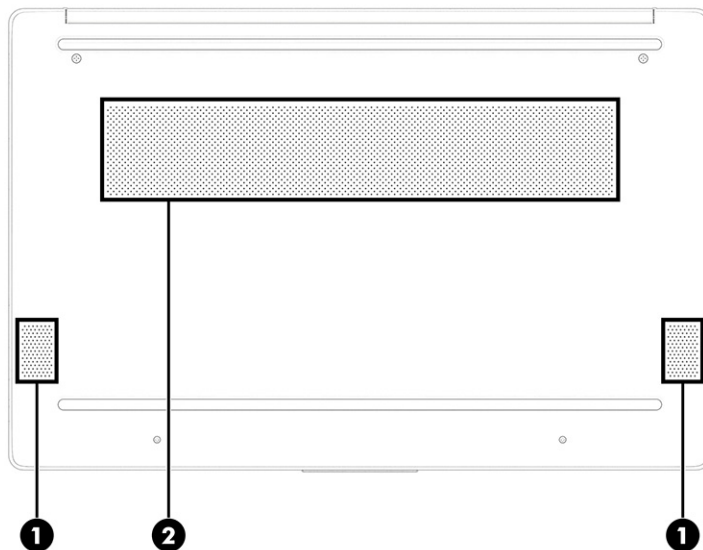

Table 2-8 Bottom components and their descriptions

Component	Description
(1) Speakers (2)	Produce sound.

Table 2-8 Bottom components and their descriptions (continued)

Component	Description
(2) Vent	Enables airflow to cool internal components. NOTE: The computer fan starts up automatically to cool internal components and prevent overheating. It is normal for the internal fan to cycle on and off during routine operation.

Labels

The labels affixed to the computer provide information that you might need when you troubleshoot system problems or travel internationally with the computer. Labels can be in paper form or imprinted on the product.

 **IMPORTANT:** Check the following locations for the labels described in this section: the bottom of the computer, inside the battery bay, under the service door, on the back of the display, or on the bottom of a tablet kickstand.

- Service label—Provides important information to identify your computer. When contacting support, you might be asked for the serial number, the product number, or the model number. Locate this information before you contact support.

Your service label will resemble one of the following examples. Refer to the illustration that most closely matches the service label on your computer.

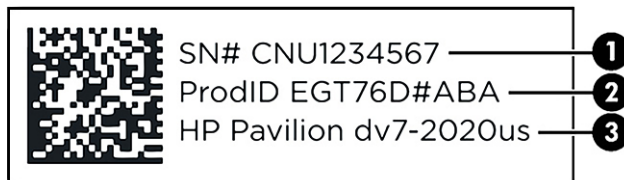

Table 2-9 Service label components

Component
(1) Serial number
(2) Product ID
(3) HP product name and model number

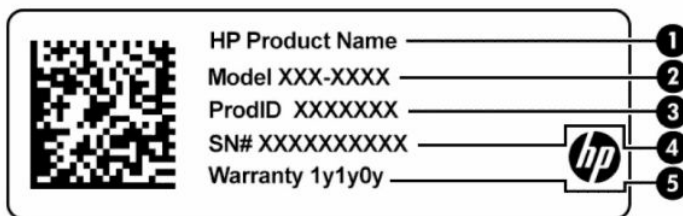

Table 2-10 Service label components

Component	
(1)	HP product name
(2)	Model number
(3)	Product ID
(4)	Serial number
(5)	Warranty period

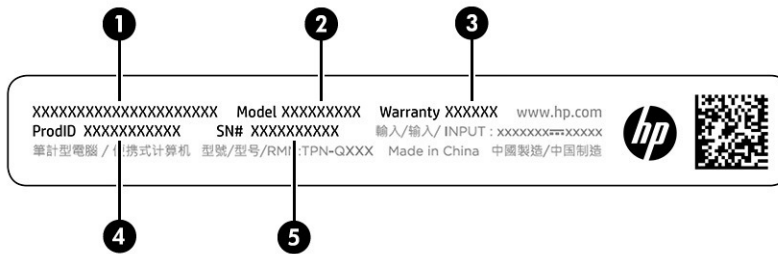

Table 2-11 Service label components

Component	
(1)	HP product name
(2)	Model number
(3)	Warranty period
(4)	Product ID
(5)	Serial number

- Regulatory labels—Provide regulatory information about the computer.
- Wireless certification labels—Provide information about optional wireless devices and the approval markings for the countries or regions in which the devices have been approved for use.

3 Illustrated parts catalog

Use this chapter to determine the spare parts that are available for the computer.

Computer major components

To identify the computer major components, use this illustration and table.

 **NOTE:** HP continually improves and changes product parts. For complete and current information about supported parts for your computer, go to <http://partsurfer.hp.com>, select your country or region, and then follow the on-screen instructions.

 **NOTE:** Details about your computer, including model, serial number, product key, and length of warranty, are on the service tag at the bottom of your computer.

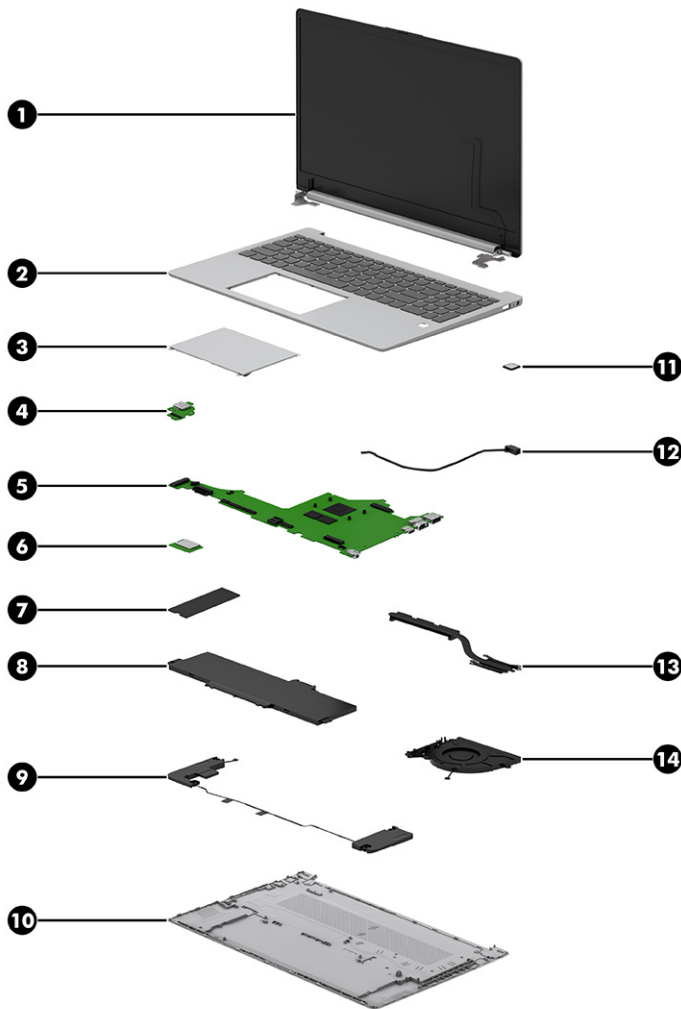

Table 3-1 Computer major component descriptions and part numbers

Item	Component	Spare part number
(1)	Display assembly NOTE: Display spare parts are available only as subcomponents. For spare part information, see Display assembly subcomponents on page 18 .	
(2)	Top cover with keyboard NOTE: For a detailed list of country codes, see Top cover with keyboard on page 55 .	
	Dark ash silver, jet black	N40880-xxx
	Pike silver, flint opaque, not backlit	N40881-xxx
	Pike silver, flint opaque, backlit	N40882-xxx
	Pike silver, flint opaque, not backlit, with fingerprint reader	N40883-xxx
	Pike silver, flint opaque, backlit, with fingerprint reader	N40884-xxx
(3)	Touchpad NOTE: The touchpad cable is available as spare part number N36072-001.	
	Turbo silver	N36069-001
	Dark ash silver	N41346-001
(4)	USB board NOTE: The USB board cable is available as spare part number N36077-001.	N36076-001
(5)	System board All system boards use the following part numbers: xxxxxx-001: Non-Windows operating system xxxxxx-601: Windows operating system NOTE: The system board repair support kit is available as spare part number N46444-888.	
	AMD Ryzen 7 7730U processor	N40869-xxx
	AMD Ryzen 5 7530U processor	N40868-xxx
	AMD Ryzen 3 7330U processor	N40867-xxx
	AMD Ryzen 5 7520U processor and 8 GB of system memory	N40866-xxx
	AMD Ryzen 3 7320U processor and 8 GB of system memory	N40865-xxx
	AMD Ryzen 3 7320U processor and 4 GB of system memory	N40864-xxx
(6)	WLAN module NOTE: The WLAN module Mylar kit is available as spare part number N36080-001.	
	Realtek Wi-Fi 6 RTL8852BE + Bluetooth 5.3	M91238-005
	Realtek Wi-Fi 6 RTL8852BE-VS + Bluetooth 5.3	N26166-005
(7)	Solid-state drive	
	1 TB (M.2 2280)	L85370-005
	512 GB (M.2 2280)	L85364-005

Table 3-1 Computer major component descriptions and part numbers (continued)

Item	Component	Spare part number
	256 GB (M.2 2280)	L85354-005
	128 GB (M.2 2230)	M11040-005
(8)	Battery (3 cell, 41 W/hr)	N21969-005
(9)	Speakers	N36066-001
(10)	Bottom cover	
	Natural silver	N36061-001
	Dark ash silver	N41347-001
(11)	Fingerprint reader module	N36073-001
	NOTE: The fingerprint reader module cable is available as spare part number N36074-001.	
(12)	Power connector cable	N36075-001
(13)	Heat sink assembly	
	25 W	N36067-001
	15 W	N36068-001
(14)	Fan	N36064-001
*	Memory module (DDR4-3200)	
	16 GB	L67710-005
	8 GB	L46598-005
	4 GB	L83673-005
	*not illustrated	

Display assembly subcomponents

To identify the display assembly subcomponents, use this illustration and table.

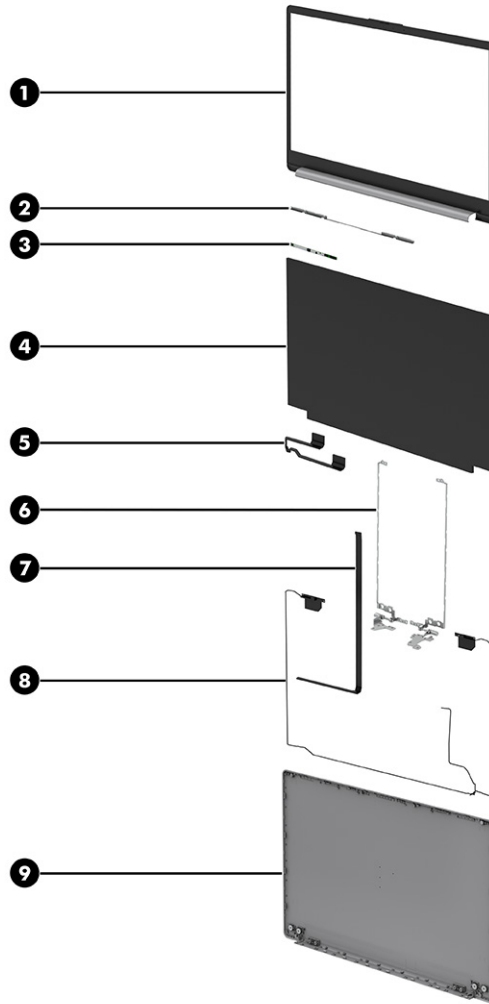

Table 3-2 Display component descriptions and part numbers

Item	Component	Spare part number
(1)	Display bezel	
	NOTE: Display bezel adhesive is available as spare part number N36079-001.	
	Turbo silver, plastic	N41355-001
	Turbo silver, aluminum	N41354-001
	Dark ash silver, plastic	N41356-001
(2)	Camera support bracket	not available as a spare part
(3)	Camera module (includes rubber piece)	
	FHD	N36084-001
	HD	N36085-001
(4)	Display panel	
	NOTE: Display panel adhesive is available as spare part number N36079-001.	

Table 3-2 Display component descriptions and part numbers (continued)

Item	Component	Spare part number
	FHD, antiglare, lower blue light, 300 nits	N41936-001
	FHD, antiglare, SVA, 250 nits	N41934-001
	FHD, antiglare UWVA, 250 nits	N41935-001
	HD, antiglare, 250 nits	N41932-001
(5)	Display cable	N36087-001
(6)	Display hinges (includes left and right hinges)	N36083-001
(7)	Camera cable	N36087-001
(8)	WLAN antenna kit (includes antenna cables and transceivers)	
	Dual	N36081-001
	Single	N36082-001
(9)	Display back cover	
	Turbo silver	
	<ul style="list-style-type: none"> Aluminum finish, 3.2 mm display panel 	N41348-001
	<ul style="list-style-type: none"> Aluminum finish, 2.6 mm display panel 	N41349-001
	<ul style="list-style-type: none"> Plastic finish, 3.2 mm display panel 	N41350-001
	<ul style="list-style-type: none"> Plastic finish, 2.6 mm display panel 	N41351-001
	Dark ash silver	
	<ul style="list-style-type: none"> 3.2 mm display panel 	N41352-001
	<ul style="list-style-type: none"> 2.6 mm display panel 	N41353-001
*	Display panel adhesive	N36079-001
	*not illustrated	

Miscellaneous parts

To identify the miscellaneous parts, use this table.

Table 3-3 Miscellaneous part descriptions and part numbers

Component	Spare part number
AC adapter	
65 W, EM	N31180-001
45 W	741727-001
USB External DVD±RW drive	747080-001
USB 3.0-to-gigabit RJ-45 adapter	M95984-001
USB-C®-to-RJ-45	M95985-001
HDMI-to-VGA adapter	701943-001

Table 3-3 Miscellaneous part descriptions and part numbers (continued)

Component	Spare part number
Adhesive kit (includes display cover tape, top, left, top left, top right)	N36079-001
Screw Kit	N36060-001
Mouse	
HP Wireless Premium Mouse	923947-001
HP Bluetooth Travel Mouse	L62043-001
HP USB Mouse	L95713-001
HP 125 Wired Mouse	M27884-101
HP 128 Laser Wired Mouse	M27885-001
HP 435 Wireless Mouse	M62277-001
HP USB Keyboard US	L95712-001
HP 125 Wired Keyboard US	M27881-001
HP Prelude Pro 15.6 Backpack	M03617-001
HP Prelude Pro 15.6 Top Load Case	M03618-001
HP Prelude 15.6 Backpack	M16116-001
HP Prelude 15.6 Top Load Case	M16117-001
Duck head adapter (for use in Japan)	L33157-001
Power cord (C5, 1.0 m [3.3 ft], conventional with sticker)	
For use in Argentina	L19357-001
For use in Australia	L19358-001
For use in Brazil	L19359-001
For use in Denmark	L19360-001
For use in Europe (bundle)	N16170-001
For use in Europe	L19361-001
For use in India	L19363-001
For use in Italy	L19364-001
For use in Israel	L19362-001
For use in Japan	L19365-001
For use in North America	L19367-001
For use in the People's Republic of China	L19368-001
For use in South Africa	L19369-001
For use in South Korea	L19366-001
For use in Switzerland	L19370-001
For use in Taiwan	L19372-001
For use in Thailand (bundle)	M85418-001

Table 3-3 Miscellaneous part descriptions and part numbers (continued)

Component	Spare part number
For use in Thailand	L19371-001
For use in the United Kingdom	L19373-001

4 Removal and replacement procedures preliminary requirements

Use this information to properly prepare to disassemble and reassemble the computer.

Tools required

You need the following tools to complete the removal and replacement procedures:

- Tweezers
- Nonconductive, nonmarking pry tool
- Magnetic Phillips P1 screwdriver

Service considerations

The following sections include some of the considerations that you must keep in mind during disassembly and assembly procedures.

 **NOTE:** As you remove each subassembly from the computer, place the subassembly (and all accompanying screws) away from the work area to prevent damage.

Plastic parts

Using excessive force during disassembly and reassembly can damage plastic parts.

Cables and connectors

Handle cables with extreme care to avoid damage.

 **IMPORTANT:** When servicing the computer, be sure that cables are placed in their proper locations during the reassembly process. Improper cable placement can damage the computer.

Apply only the tension required to unseat or seat the cables during removal and insertion. Handle cables by the connector whenever possible. In all cases, avoid bending, twisting, or tearing cables. Be sure that cables are routed so that they cannot be caught or snagged as you remove or replace parts. Handle flex cables with extreme care; these cables tear easily.

Drive handling

Note the following guidelines when handling drives.

 **IMPORTANT:** Drives are fragile components. Handle them with care. To prevent damage to the computer, damage to a drive, or loss of information, observe these precautions:

- Before removing or inserting a hard drive, shut down the computer. If you are unsure whether the computer is off or in Hibernation, turn the computer on, and then shut it down through the operating system.

- Before handling a drive, be sure that you are discharged of static electricity. While handling a drive, avoid touching the connector.
 - Before removing an optical drive, be sure that a disc is not in the drive, and be sure that the optical drive tray is closed.
 - Handle drives on surfaces covered with at least 2.54 cm (1 inch) of shock-proof foam.
 - Avoid dropping drives from any height onto any surface.
 - After removing a hard drive or an optical drive, place it in a static-proof bag.
 - Avoid exposing an internal hard drive to products that have magnetic fields, such as monitors or speakers.
 - Avoid exposing a drive to temperature extremes or liquids.
 - If a drive must be mailed, place the drive in a bubble pack mailer or other suitable form of protective packaging, and label the package "FRAGILE."
-

Electrostatic discharge information

A sudden discharge of static electricity from your finger or other conductor can destroy static-sensitive devices or microcircuitry. Often the spark is neither felt nor heard, but damage occurs. An electronic device exposed to electrostatic discharge (ESD) might not appear to be affected at all and can work perfectly throughout a normal cycle. The device might function normally for a while, but it has been degraded in the internal layers, reducing its life expectancy.

Networks built into many integrated circuits provide some protection, but in many cases, the discharge contains enough power to alter device parameters or melt silicon junctions.

 **IMPORTANT:** To prevent damage to the device when you remove or install internal components, observe these precautions:

- Keep components in their electrostatic-safe containers until you are ready to install them.
 - Before touching an electronic component, discharge static electricity by using the guidelines described in [Personal grounding methods and equipment on page 25](#).
 - Avoid touching pins, leads, and circuitry. Handle electronic components as little as possible.
 - If you remove a component, place it in an electrostatic-safe container.
-

Generating static electricity

Follow these static electricity guidelines:

- Different activities generate different amounts of static electricity.
- Static electricity increases as humidity decreases.

Table 4-1 Static electricity occurrence based on activity and humidity

Event	Relative humidity		
	55%	40%	10%
Walking across carpet	7,500 V	15,000 V	35,000 V
Walking across vinyl floor	3,000 V	5,000 V	12,000 V
Motions of bench worker	400 V	800 V	6,000 V
Removing dual in-line packages (DIPs) from plastic tube	400 V	700 V	2,000 V
Removing DIPs from vinyl tray	2,000 V	4,000 V	11,500 V
Removing DIPs from polystyrene foam	3,500 V	5,000 V	14,500 V
Removing bubble pack from PCB (printed circuit board)	7,000 V	20,000 V	26,500 V
Packing PCBs in foam-lined box	5,000 V	11,000 V	21,000 V

Multiple electric components can be packaged together in plastic tubes, trays, or polystyrene foam.



NOTE: As little as 700 V of static electricity can degrade a product.

Preventing electrostatic damage to equipment

Many electronic components are sensitive to ESD. Circuitry design and structure determine the degree of sensitivity.

The following packaging and grounding precautions are necessary to prevent static electricity damage to electronic components:

- To avoid hand contact, transport products in static-safe containers such as tubes, bags, or boxes.
- Protect all electrostatic parts and assemblies with conductive or approved containers or packaging.
- Keep electrostatic-sensitive parts in their containers until they arrive at static-free stations.
- Place items on a grounded surface before removing them from their container.
- Always be properly grounded when touching a sensitive component or assembly.
- Avoid contact with pins, leads, or circuitry.
- Place reusable electrostatic-sensitive parts from assemblies in protective packaging or conductive foam.

Personal grounding methods and equipment

Using certain equipment can prevent static electricity damage to electronic components.

- **Wrist straps** are flexible straps with a maximum of $1\text{ M}\Omega \pm 10\%$ resistance in the ground cords. To provide proper ground, a strap must be worn snug against bare skin. The ground cord must be connected and fit snugly into the banana plug connector on the grounding mat or workstation.
- You can use **heel straps, toe straps, and boot straps** at standing workstations. These straps are compatible with most types of shoes or boots. On conductive floors or dissipative floor mats, use them on both feet with a maximum of $1\text{ M}\Omega \pm 10\%$ resistance between the operator and ground.

Table 4-2 Static shielding protection levels

Static shielding protection levels	
Method	Voltage
Antistatic plastic	1,500
Carbon-loaded plastic	7,500
Metallized laminate	15,000

Grounding the work area

To prevent static damage at the work area, follow these precautions:

- Cover the work surface with approved static-dissipative material.
- Use a wrist strap connected to a properly grounded work surface and use properly grounded tools and equipment.
- Use static-dissipative mats, foot straps, or air ionizers to give added protection.
- Handle electrostatic sensitive components, parts, and assemblies by the case or PCB laminate. Handle them only at static-free work areas.
- Turn off power and input signals before inserting and removing connectors or test equipment.
- Use fixtures made of static-safe materials when fixtures must directly contact dissipative surfaces.
- Keep the work area free of nonconductive materials, such as ordinary plastic assembly aids and polystyrene foam.
- Use conductive field service tools, such as cutters, screwdrivers, and vacuums.
- Avoid contact with pins, leads, or circuitry.

Recommended materials and equipment

HP recommends certain materials and equipment to prevent static electricity:

- Antistatic tape
- Antistatic smocks, aprons, or sleeve protectors
- Conductive bins and other assembly or soldering aids
- Conductive foam
- Conductive tabletop workstations with ground cord of $1\text{ M}\Omega \pm 10\%$ resistance
- Static-dissipative table or floor mats with hard tie to ground
- Field service kits
- Static awareness labels
- Wrist straps and footwear straps providing $1\text{ M}\Omega \pm 10\%$ resistance
- Material handling packages

- Conductive plastic bags
- Conductive plastic tubes
- Conductive tote boxes
- Opaque shielding bags
- Transparent metallized shielding bags
- Transparent shielding tubes

Cleaning your computer

Cleaning your computer regularly removes dirt and debris so that your device continues to operate at its best. Use the following information to safely clean the external surfaces of your computer.

Enabling HP Easy Clean (select products only)

HP Easy Clean helps you to avoid accidental input while you clean the computer surfaces. This software disables devices such as the keyboard, touch screen, and touchpad for a preset amount of time so that you can clean all computer surfaces.

1. Start HP Easy Clean in one of the following ways:
 - Select the **Start** menu, and then select **HP Easy Clean**.
- or -
 - Select the **HP Easy Clean** icon in the taskbar.
- or -
 - Select **Start**, and then select the **HP Easy Clean** tile.
2. Now that your device is disabled for a short period, see [Removing dirt and debris from your computer on page 27](#) for the recommended steps to clean the high-touch, external surfaces on your computer. After you remove the dirt and debris, you can also clean the surfaces with a disinfectant. See [Cleaning your computer with a disinfectant on page 28](#) for guidelines to help prevent the spread of harmful bacteria and viruses.

Removing dirt and debris from your computer

Here are the recommended steps to clean dirt and debris from your computer.

For computers with wood veneer, see [Caring for wood veneer \(select products only\) on page 29](#).

1. Wear disposable gloves made of latex (or nitrile gloves, if you are latex-sensitive) when cleaning the surfaces.
2. Turn off your device and unplug the power cord and other connected external devices. Remove any installed batteries from items such as wireless keyboards.

 **CAUTION:** To prevent electric shock or damage to components, never clean a product while it is turned on or plugged in.

3. Moisten a microfiber cloth with water. The cloth should be moist, but not dripping wet.



IMPORTANT: To avoid damaging the surface, avoid abrasive cloths, towels, and paper towels.

4. Wipe the exterior of the product gently with the moistened cloth.



IMPORTANT: Keep liquids away from the product. Avoid getting moisture in any openings. If liquid makes its way inside your HP product, it can cause damage to the product. Do not spray liquids directly on the product. Do not use aerosol sprays, solvents, abrasives, or cleaners containing hydrogen peroxide or bleach that might damage the finish.

5. Start with the display (if applicable). Wipe carefully in one direction, and move from the top of the display to the bottom. Finish with any flexible cables, like power cord, keyboard cable, and USB cables.
6. Be sure that surfaces have completely air-dried before turning the device on after cleaning.
7. Discard the gloves after each cleaning. Clean your hands immediately after you remove the gloves.

See [Cleaning your computer with a disinfectant on page 28](#) for recommended steps to clean the high-touch, external surfaces on your computer to help prevent the spread of harmful bacteria and viruses.

Cleaning your computer with a disinfectant

The World Health Organization (WHO) recommends cleaning surfaces, followed by disinfection, as a best practice for preventing the spread of viral respiratory illnesses and harmful bacteria.

After cleaning the external surfaces of your computer using the steps in [Removing dirt and debris from your computer on page 27](#), [Caring for wood veneer \(select products only\) on page 29](#), or both, you might also choose to clean the surfaces with a disinfectant. A disinfectant that is within HP's cleaning guidelines is an alcohol solution consisting of 70% isopropyl alcohol and 30% water. This solution is also known as rubbing alcohol and is sold in most stores.

Follow these steps when disinfecting high-touch, external surfaces on your computer:

1. Wear disposable gloves made of latex (or nitrile gloves, if you are latex-sensitive) when cleaning the surfaces.
2. Turn off your device and unplug the power cord and other connected external devices. Remove any installed batteries from items such as wireless keyboards.



CAUTION: To prevent electric shock or damage to components, never clean a product while it is turned on or plugged in.

3. Moisten a microfiber cloth with a mixture of 70% isopropyl alcohol and 30% water. The cloth should be moist, but not dripping wet.



CAUTION: Do not use any of the following chemicals or any solutions that contain them, including spray-based surface cleaners: bleach, peroxides (including hydrogen peroxide), acetone, ammonia, ethyl alcohol, methylene chloride, or any petroleum-based materials, such as gasoline, paint thinner, benzene, or toluene.



IMPORTANT: To avoid damaging the surface, avoid abrasive cloths, towels, and paper towels.

4. Wipe the exterior of the product gently with the moistened cloth.

 **IMPORTANT:** Keep liquids away from the product. Avoid getting moisture in any openings. If liquid makes its way inside your HP product, it can cause damage to the product. Do not spray liquids directly on the product. Do not use aerosol sprays, solvents, abrasives, or cleaners containing hydrogen peroxide or bleach that might damage the finish.

5. Start with the display (if applicable). Wipe carefully in one direction, and move from the top of the display to the bottom. Finish with any flexible cables, like power cord, keyboard cable, and USB cables.
6. Be sure that surfaces have completely air-dried before turning the device on after cleaning.
7. Discard the gloves after each cleaning. Clean your hands immediately after you remove the gloves.

Caring for wood veneer (select products only)

Your product might feature high-quality wood veneer. As with all natural wood products, proper care is important for best results over the life of the product. Because of the nature of natural wood, you might see unique variations in the grain pattern or subtle variations in color, which are normal.

- Clean the wood with a dry, static-free microfiber cloth or chamois.
- Avoid cleaning products containing substances such as ammonia, methylene chloride, acetone, turpentine, or other petroleum-based solvents.
- Do not expose the wood to sun or moisture for long periods of time.
- If the wood becomes wet, dry it by dabbing with an absorbent, lint-free cloth.
- Avoid contact with any substance that might dye or discolor the wood.
- Avoid contact with sharp objects or rough surfaces that might scratch the wood.

See [Removing dirt and debris from your computer on page 27](#) for the recommended steps to clean the high-touch, external surfaces on your computer. After you remove the dirt and debris, you can also clean the surfaces with a disinfectant. See [Cleaning your computer with a disinfectant on page 28](#) for sanitizing guidelines to help prevent the spread of harmful bacteria and viruses.

Packaging and transporting guidelines

Follow these grounding guidelines when packaging and transporting equipment:

- To avoid hand contact, transport products in static-safe tubes, bags, or boxes.
- Protect ESD-sensitive parts and assemblies with conductive or approved containers or packaging.
- Keep ESD-sensitive parts in their containers until the parts arrive at static-free workstations.
- Place items on a grounded surface before removing items from their containers.
- Always be properly grounded when touching a component or assembly.
- Store reusable ESD-sensitive parts from assemblies in protective packaging or nonconductive foam.

- Use transporters and conveyors made of antistatic belts and roller bushings. Be sure that mechanized equipment used for moving materials is wired to ground and that proper materials are selected to avoid static charging. When grounding is not possible, use an ionizer to dissipate electric charges.

Accessing support information

To find the HP support that you need, use this information.

Table 4-3 Support information locations



Service consideration	Path to access information
Records of reported failure incidents stored on the computer	<p>Windows®:</p> <p>Preoperating system failures are logged in the BIOS Event Log. To view the BIOS Event Log:</p> <ol style="list-style-type: none"> 1. Press the power button. 2. Immediately and repeatedly press esc when the power button light turns white. <p>NOTE: If you do not press esc at the appropriate time, you must restart the computer and again repeatedly press esc when the power button light turns white to access the utility.</p> <ol style="list-style-type: none"> 3. Press f10 to enter the BIOS setup. 4. (On commercial products) Under the Main tab, select BIOS event log, and then select View BIOS Event Log. <p>- or -</p> <p>(On consumer products) Under the Main tab, select System Log.</p> <p>Post-operating system failures are logged in the Event Viewer.</p> <ol style="list-style-type: none"> 1. Turn on the computer and allow the operating system to open. 2. Select the search icon  in the taskbar. 3. Type <code>Event Viewer</code>, and then press enter. 4. Select the log from the left panel. Details display in the right panel. <p>Chrome™:</p> <ol style="list-style-type: none"> 1. Go to support.google.com/chrome. 2. Search <code>collect Chrome device logs</code>.
Technical bulletins	<p>To locate technical bulletins:</p> <ol style="list-style-type: none"> 1. Go to www.hp.com. 2. Place the cursor over Problem solving to display more options. 3. Select Support & Troubleshooting. 4. Type the serial number, product number, or product name to go to the product support page. 5. Select Advisories to view technical bulletins.

Table 4-3 Support information locations (continued)

Service consideration	Path to access information
Repair professionals	To locate repair professionals: <ol style="list-style-type: none"><li data-bbox="703 312 932 333">1. Go to www.hp.com.<li data-bbox="703 361 1362 382">2. Place the cursor over Support resources to display more options.<li data-bbox="703 409 1091 430">3. Select Authorized service providers.
Component and diagnosis information, failure detection, and required action	To locate diagnosis information and actions: <ol style="list-style-type: none"><li data-bbox="703 512 1203 533">1. Go to http://www.hp.com/go/techcenter/pcdiags.<li data-bbox="703 560 932 581">2. Select Get Support.<li data-bbox="703 609 1445 653">3. Near the bottom of the window, select Notebook PCs, and then select your location.

5 Removal and replacement procedures for authorized service provider parts

This chapter provides removal and replacement procedures for authorized service provider parts.

 **IMPORTANT:** Only an authorized service provider should access the components described in this chapter. Accessing these parts can damage the computer or void the warranty.

 **NOTE:** Details about your computer, including model, serial number, product key, and length of warranty, are on the service tag at the bottom of your computer.

Component replacement procedures

To remove and replace computer components, use the procedures described in this section.

 **NOTE:** HP continually improves and changes product parts. For complete and current information about supported parts for your computer, go to <http://partsurfer.hp.com>, select your country or region, and then follow the on-screen instructions.

Make special note of each screw size and location during removal and replacement.

Preparation for disassembly

To remove and replace computer components, use these procedures:

For initial safety procedures, see [Removal and replacement procedures preliminary requirements on page 23](#).

1. Turn off the computer. If you are unsure whether the computer is off or in Hibernation, turn the computer on, and then shut it down through the operating system.
2. Disconnect the power from the computer by unplugging the power cord from the computer.
3. Disconnect all external devices from the computer.

Bottom cover

To remove the bottom cover, use this procedure and illustration.

Table 5-1 Bottom cover description and part number

Description	Spare part number
Bottom cover, natural silver models	N36061-001
Bottom cover, dark ash silver models	N41347-001

Before removing the bottom cover, prepare the computer for disassembly (see [Preparation for disassembly on page 32](#)).

Remove the bottom cover:

1. Close the computer and rest it upside down on a flat work surface with the front toward you.
2. Remove the top two Phillips M2.5 × 6.0 screws (1) that secure the bottom cover to the computer.
3. Remove the bottom two Phillips M2.0 × 4.0 screws (2) that secure the bottom cover to the computer.

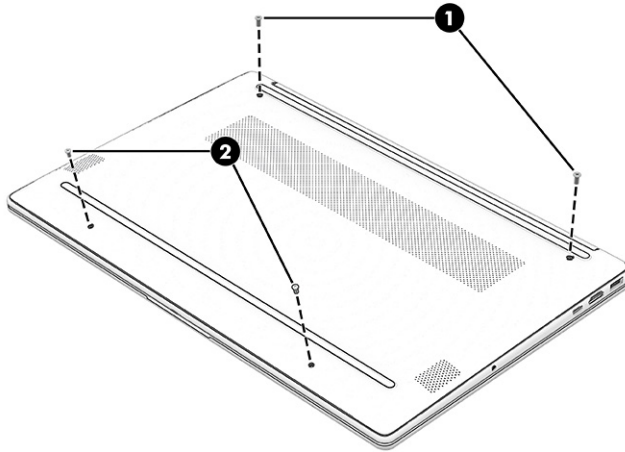

4. Insert a thin, plastic tool in the seam at the top between the bottom cover and computer to release the bottom cover, and then remove the bottom cover from the computer.



To replace the bottom cover, reverse the removal procedures.

Battery

To remove the battery, use this procedure and illustration.

Table 5-2 Battery description and part number

Description	Spare part number
Battery (3 cell, 41 Whr)	N21969-005

 **WARNING!** To avoid personal injury and damage to the product:

- Do *not* puncture, twist, or crack the battery.
- Do *not* cause an external puncture or rupture to the battery, which can cause a short inside the battery, which can result in battery thermal runaway.
- Do *not* handle or touch the battery enclosure with sharp objects such as tweezers or pliers, which might puncture the battery.
- Do *not* compress or squeeze the battery case with tools or heavy objects stacked on top of the case. These actions can apply undue force on the battery.
- Do *not* touch the connectors with any metallic surface or object, such as metal tools, screws, or coins, which can cause shorting across the connectors.

Before removing the battery, follow these steps:

1. Prepare the computer for disassembly (see [Preparation for disassembly on page 32](#)).
2. Remove the bottom cover (see [Bottom cover on page 32](#)).

 **WARNING!** To reduce potential safety issues, use only the user-replaceable battery provided with the computer, a replacement battery provided by HP, or a compatible battery purchased from HP.

 **IMPORTANT:** Removing a battery that is the sole power source for the computer can cause loss of information. To prevent loss of information, save your work or shut down the computer through Windows before you remove the battery.

Remove the battery:

1. Remove the speaker cable from the clips along the bottom of the battery **(1)**.
2. Remove the five Phillips M2.0 × 3.0 screws **(2)** that secure the battery to the computer.

3. Lift the top of the battery up and then pull into the computer to remove it (3).

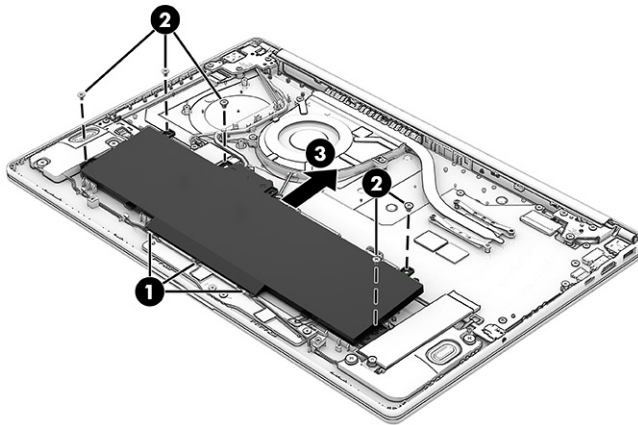

To install the battery, reverse the removal procedures.

Solid-state drive

To remove the M.2 solid-state drive, use this procedure and illustration.

Table 5-3 Solid-state drive descriptions and part numbers

Description	Spare part number
1 TB (M.2 2280)	L85370-005
512 GB (M.2 2280)	L85364-005
256 GB (M.2 2280)	L85354-005
128 GB (M.2 2230)	M11040-005

Before removing the solid-state drive, follow these steps:

1. Prepare the computer for disassembly (see [Preparation for disassembly on page 32](#)).
2. Remove the bottom cover (see [Bottom cover on page 32](#)).
3. Remove the battery (see [Battery on page 33](#)).

Remove the solid-state drive:

- Remove the Phillips M2.0 × 3.0 screw (1) that secures the drive, and then pull the drive away from the socket to remove it (2).

 **NOTE:** The illustration shows the M.2 2280 drive.

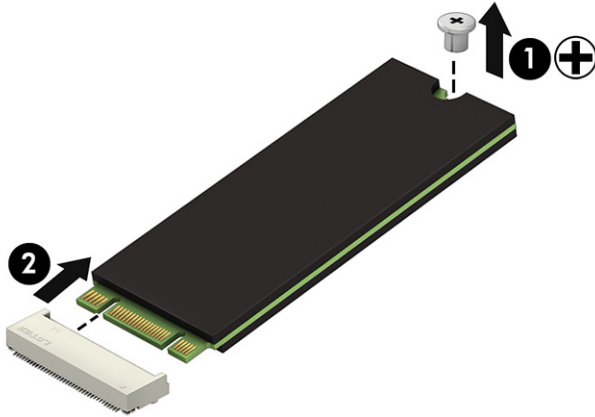

To install the solid-state drive, reverse the removal procedures.

 **NOTE:** Solid-state drives are designed with a notch to prevent incorrect insertion.

Memory modules (select products only)

To remove the memory modules, use this procedure and illustration.

Table 5-4 Memory module descriptions and part numbers

Description	Spare part number
Memory module, 16 GB (DDR4-3200)	L67710-005
Memory module, 8 GB (DDR4-3200)	L46598-005
Memory module, 4 GB (DDR4-3200)	L83673-005

Before removing the memory, follow these steps:

1. Prepare the computer for disassembly ([Preparation for disassembly on page 32](#)).
2. Remove the bottom cover (see [Bottom cover on page 32](#)).
3. Remove the battery (see [Battery on page 33](#)).

If you are replacing a memory module, remove the existing memory module:

- Spread the two retention clips outward (1) until the memory module tilts up at a 45° angle, and then remove the module (2). Use the same procedure to remove all memory modules.

 **IMPORTANT:** To prevent damage to the memory module, hold the memory module by the edges only. Do not touch the components on the memory module.

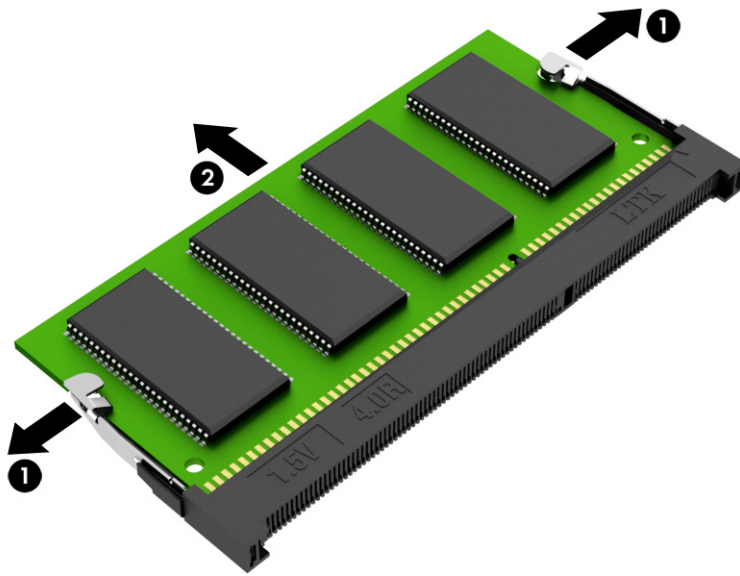

To protect a memory module after removal, place it in an electrostatic-safe container.

To install a memory module:

1. Align the notched edge of the module with the tab in the slot **(1)**, and then press the module into the slot at an angle until it is seated **(2)**.
2. Press down on the module until the side retention clips snap into place **(3)**.

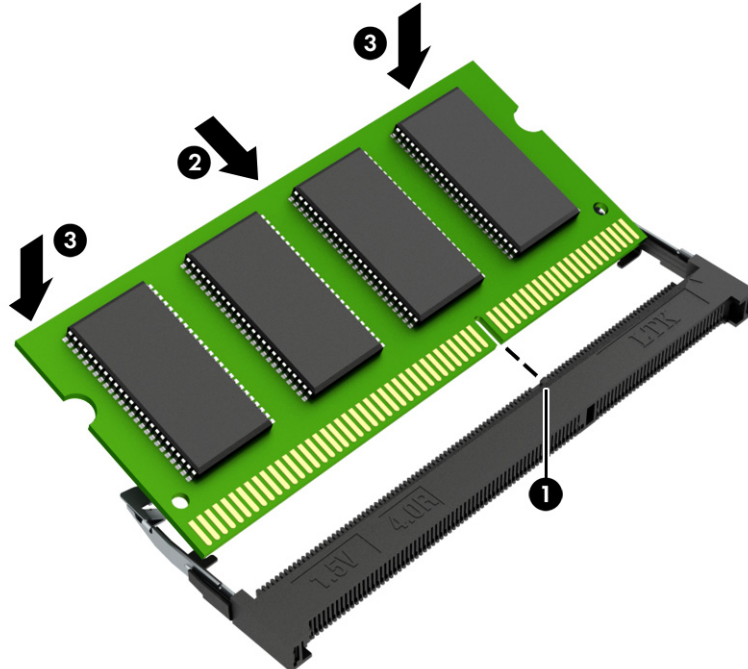

WLAN module

To remove the WLAN module, use this procedure and illustration.

Table 5-5 WLAN module descriptions and part numbers

Description	Spare part number
Realtek Wi-Fi 6 RTL8852BE+ Bluetooth 5.3	M91238-005
Realtek Wi-Fi 6 RTL8852BE-VS+ Bluetooth 5.3	N26166-005
WLAN module Mylar kit	N36080-001

 **IMPORTANT:** To prevent an unresponsive system, replace the wireless module only with a wireless module authorized for use in the computer by the governmental agency that regulates wireless devices in your country or region. If you replace the module and then receive a warning message, remove the module to restore device functionality, and then contact technical support.

Before removing the WLAN module, follow these steps:

1. Prepare the computer for disassembly (see [Preparation for disassembly on page 32](#)).
2. Remove the bottom cover (see [Bottom cover on page 32](#)).
3. Remove the battery (see [Battery on page 33](#)).

Remove the WLAN module:

1. Remove the Mylar that covers the antenna connectors (1).
2. Carefully disconnect the two antenna cables from the module (2).
3. Remove the Phillips M2.0 × 2.3 screw (3), and then pull the module out of the socket to remove it (4).

 **NOTE:** The #1 white WLAN antenna cable connects to the WLAN module #1 Main terminal. The #2 black WLAN antenna cable connects to the WLAN module #1 Aux terminal.

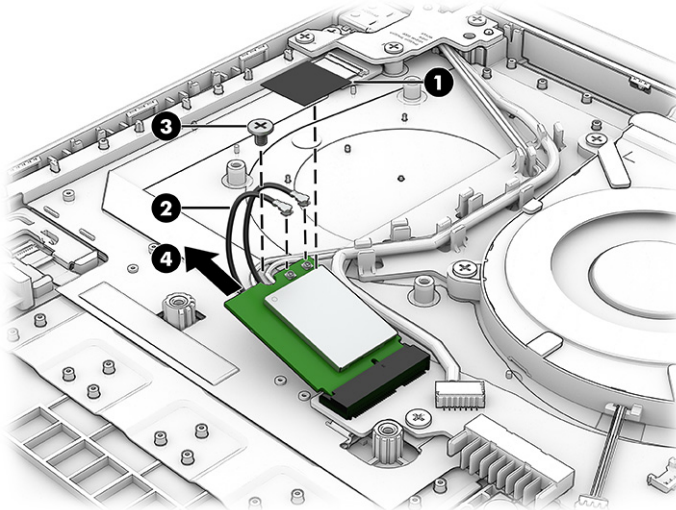

4. If the WLAN antenna is not connected to the terminal on the WLAN module, install a protective sleeve on the antenna connector, as shown in the following illustration.

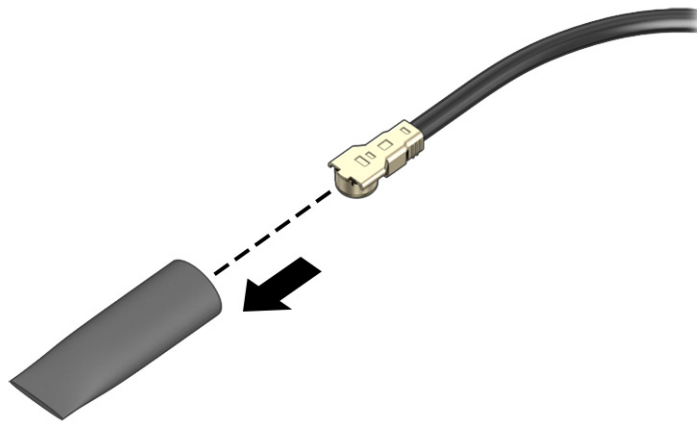

To install the WLAN module, reverse this procedure.

Speakers

To remove the speakers, use this procedure and illustration.

Table 5-6 Speaker description and part number

Description	Spare part number
Speaker Kit	N36066-001

Before removing the speakers, follow these steps:

1. Prepare the computer for disassembly (see [Preparation for disassembly on page 32](#)).
2. Remove the bottom cover (see [Bottom cover on page 32](#)).
3. Remove the battery (see [Battery on page 33](#)).
4. Remove the solid-state drive (see [Solid-state drive on page 35](#)).

Remove the speakers:

1. Disconnect the speaker cable from the system board **(1)**.
2. Remove the cable between the speakers from the clips and tape that secure it to the computer **(2)**.
3. Remove the two Phillips M1.6 × 2.5 screws **(3)** that secure each speaker to the computer.

4. Remove the speakers from the computer (4).

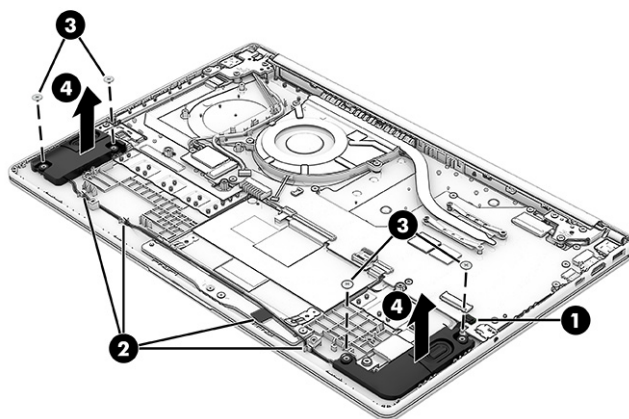

To install the speakers, reverse this procedure.

Heat sink

To remove the heat sink, use this procedure and illustration.

Table 5-7 Heat sink description and part number

Description	Spare part number
Heat sink, 25 W	N36067-001
Heat sink, 15 W	N36068-001

Before removing the heat sink, follow these steps:

1. Prepare the computer for disassembly (see [Preparation for disassembly on page 32](#)).
2. Remove the bottom cover (see [Bottom cover on page 32](#)).
3. Remove the battery (see [Battery on page 33](#)).

Remove the heat sink:

1. Remove the four Phillips M2.0 × 3.5 screws (1) that secure the heat sink to the computer, and then remove the heat sink (2).

 **NOTE:** Heat sink appearance might vary.

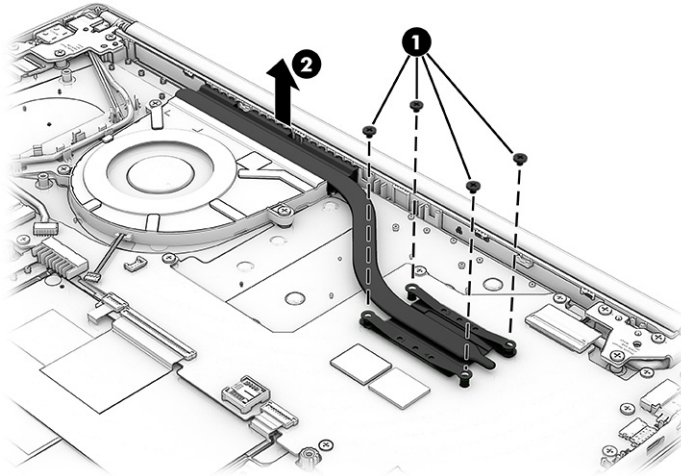

2. Thoroughly clean the thermal material from the surfaces of the heat sink and the system board components each time the heat sink is removed. Replacement thermal material is included with the heat sink and system board spare part kits. The following illustration shows the replacement thermal material location.

Thermal material is used on the heat sink (1).

 **NOTE:** Heat sink appearance might vary.

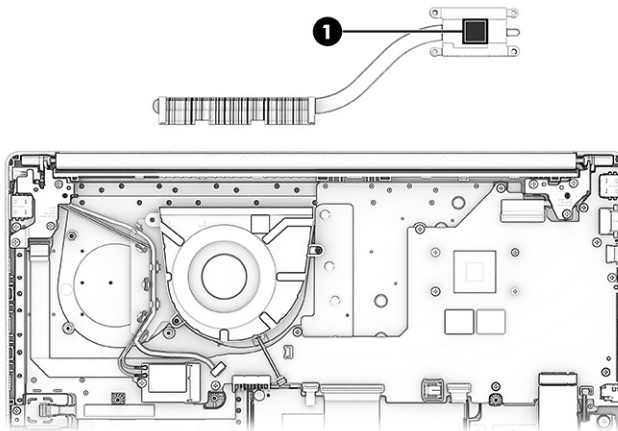

To install the heat sink, reverse this procedure.

Fan

To remove the fan, use this procedure and illustration.

Table 5-8 Fan description and part number

Description	Spare part number
Fan	N36064-001

Before removing the fan, follow these steps:

1. Prepare the computer for disassembly (see [Preparation for disassembly on page 32](#)).
2. Remove the bottom cover (see [Bottom cover on page 32](#)).
3. Remove the battery (see [Battery on page 33](#)).

Remove the fan:

1. Remove the power connector cable and antenna cable from the clips on the side of the fan (1).
2. Disconnect the fan cable from the system board (2).
3. Remove the three Phillips M2.0 × 3.5 screws (3) that secure the fan to the computer, and then remove the fan (4).

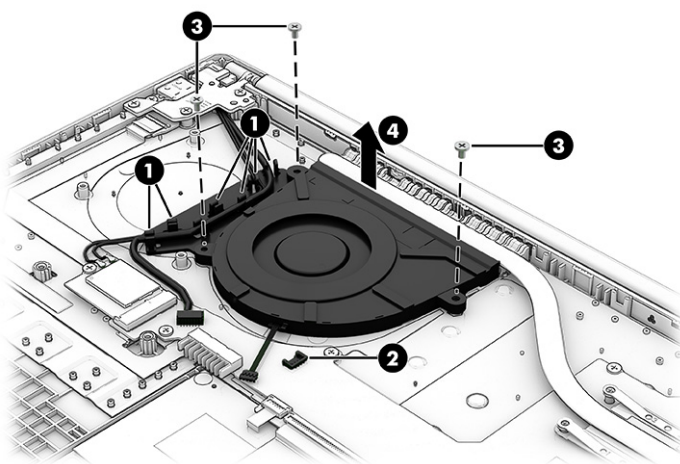

To install the fan, reverse this procedure.

Fingerprint reader (select products only)

To remove the fingerprint reader, use this procedure and illustration.

Table 5-9 Fingerprint reader description and part number

Description	Spare part number
Fingerprint reader	N36073-001
Fingerprint reader cable	N36074-001

Before removing the fingerprint reader, follow these steps:

1. Prepare the computer for disassembly (see [Preparation for disassembly on page 32](#)).
2. Remove the bottom cover (see [Bottom cover on page 32](#)).
3. Remove the battery (see [Battery on page 33](#)).

Remove the fingerprint reader:

1. Disconnect the cable from the ZIF connector on the fingerprint reader (1).

 **NOTE:** To replace the fingerprint reader cable you must remove the system board.

2. Remove the Phillips M2.0 × 2.0 screw (2) from the fingerprint reader bracket, and then remove the bracket (3).
3. Remove the fingerprint reader from the computer (4).

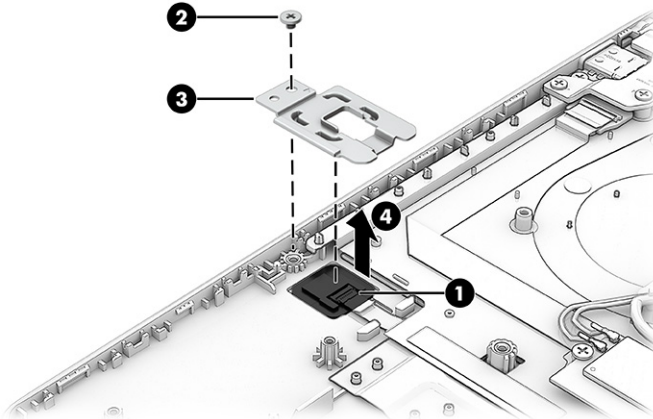

To install the fingerprint reader, reverse this procedure.

 **NOTE:** When replacing the fingerprint reader bracket, insert it into the tab on the computer chassis at an angle (1), press it down into place (2), and then replace the screw (3).

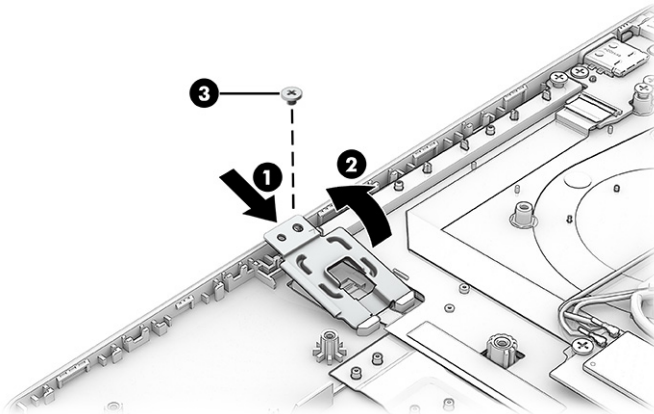

USB board

To remove the USB board, use this procedure and illustration.

Table 5-10 USB board description and part number

Description	Spare part number
USB board	N36076-001
USB board cable	N36077-001

Before removing the USB board, follow these steps:

1. Prepare the computer for disassembly (see [Preparation for disassembly on page 32](#)).
2. Remove the bottom cover (see [Bottom cover on page 32](#)).
3. Remove the battery (see [Battery on page 33](#)).

Remove the USB board:

1. Disconnect the cable from the ZIF connector on the USB board (1).



NOTE: To replace the USB board cable, you must remove the system board.

2. Remove the three Phillips M2.5 × 5.0 screws (2) from the display hinge.
3. Rotate the hinge up and off the USB board (3).
4. Remove the Phillips M2.0 × 3.0 screw (4) and the Phillips M2.0 × 2.0 screw (5) that secures the USB board.
5. Remove the USB board from the computer (6).

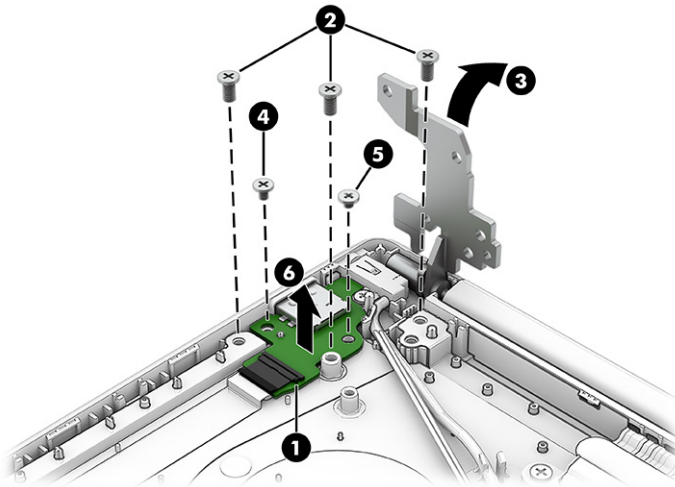

To install the USB board, reverse this procedure.

Power connector cable

To remove the power connector cable, use this procedure and illustration.

Table 5-11 Power connector cable description and part number

Description	Spare part number
Power connector cable	N36075-001

Before removing the power connector cable, follow these steps:

1. Prepare the computer for disassembly (see [Preparation for disassembly on page 32](#)).
2. Remove the bottom cover (see [Bottom cover on page 32](#)).

3. Remove the battery (see [Battery on page 33](#)).

Remove the power connector cable:

1. Disconnect the power connector cable from the system board (1).
2. Remove the cable from the clips along the side of the fan (2).
3. Remove the three Phillips M2.5 × 5.0 screws (3) from the display hinge.
4. Rotate the hinge up and off the power connector (4).
5. Remove the Phillips M2.0 × 2.0 screw (5) from the power connector.
6. Remove the power connector cable from the computer (6).

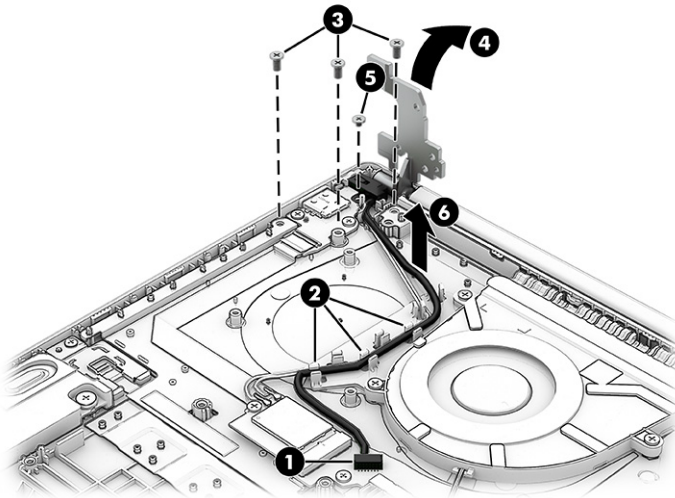

To install the power connector cable, reverse this procedure.

System board

To remove the system board, use these procedures and illustrations.

Table 5-12 System board descriptions and part numbers

Description	Spare part number
System board (includes integrated processor)	
All system boards use the following part numbers:	
xxxxxx-001: Non-Windows operating system	
xxxxxx-601: Windows operating system	
NOTE: The system board repair support kit is available as spare part number N46444-888.	
AMD Ryzen 7 7730U processor	N40869-xxx
AMD Ryzen 5 7530U processor	N40868-xxx
AMD Ryzen 3 7330U processor	N40867-xxx
AMD Ryzen 5 7520U processor and 8 GB of system memory	N40866-xxx

Table 5-12 System board descriptions and part numbers (continued)

Description	Spare part number
AMD Ryzen 3 7320U processor and 8 GB of system memory	N40865-xxx
AMD Ryzen 3 7320U processor and 4 GB of system memory	N40864-xxx

Before removing the system board, follow these steps:

1. Prepare the computer for disassembly (see [Preparation for disassembly on page 32](#)).
2. Remove the bottom cover (see [Bottom cover on page 32](#)).
3. Remove the battery (see [Battery on page 33](#)).
4. Remove the solid-state drive (see [Solid-state drive on page 35](#)).
5. Remove the WLAN module (see [WLAN module on page 37](#)).

Remove the system board:

1. Disconnect the following cables from the system board:
 - Display cable (ZIF) **(1)**
 - Speaker cable **(2)**
 - Touchpad cable (ZIF) **(3)**
 - Keyboard cable (ZIF) **(4)**
 - Backlight cable (ZIF) **(5)**
 - Power connector **(6)**
 - Fan cable **(7)**
 - Fingerprint reader cable (ZIF) **(8)** from the fingerprint reader



NOTE: The fingerprint reader cable connects to the bottom of the system. You must remove the system board to replace the cable.

- Peel the fingerprint reader cable off the computer **(9)**
- USB board cable (ZIF) **(10)** from the USB board



NOTE: The USB board cable connects to the bottom of the system. You must remove the system board to replace the cable.

- Peel the USB cable off the computer **(11)**

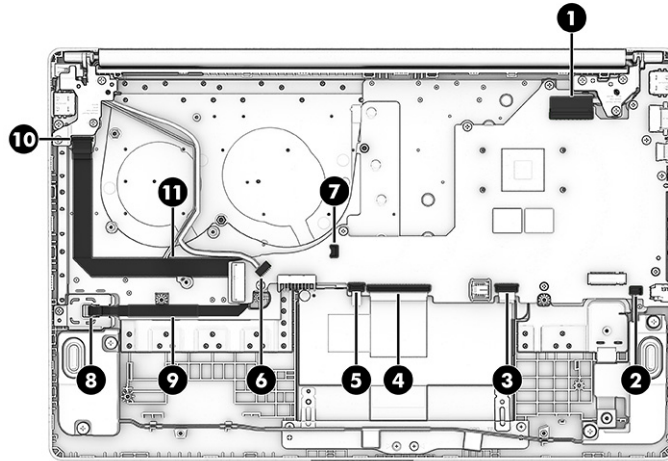

2. Remove the nine Phillips M2.0 × 2.0 screws (1) that secure the system board to the computer.
3. Lift the left edge of the system board, and then pull the board up and to the left to remove it from the computer (2).

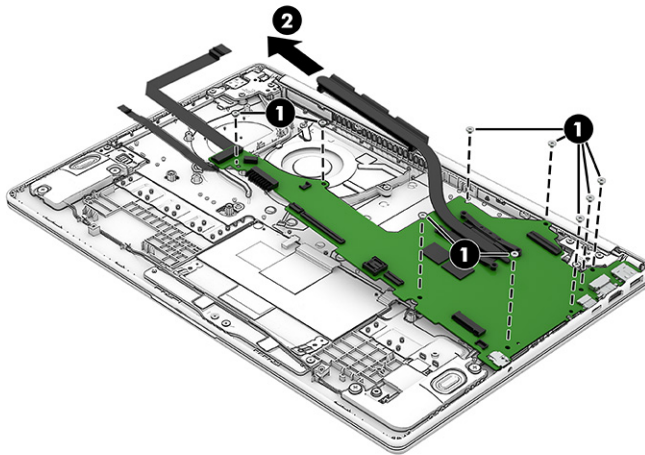

To install the system board, reverse this procedure.

Touchpad

To remove the touchpad, use this procedure and illustration.

Table 5-13 Touchpad description and part number

Description	Spare part number
Touchpad, turbo silver	N36069-001
Touchpad, dark ash silver	N41346-001
Touchpad cable (available in the Cable Kit)	N36072-001

Before removing the touchpad, follow these steps:

1. Prepare the computer for disassembly (see [Preparation for disassembly on page 32](#)).
2. Remove the bottom cover (see [Bottom cover on page 32](#)).
3. Remove the battery (see [Battery on page 33](#)).
4. Remove the system board (see [System board on page 45](#)).

Remove the touchpad:

1. Remove the Mylar that secures the speaker cable, and then remove the cable.
2. Remove the four Phillips M2.0 × 2.5 screws **(1)** that secure the touchpad bracket to the computer, and then remove the bracket **(2)**.

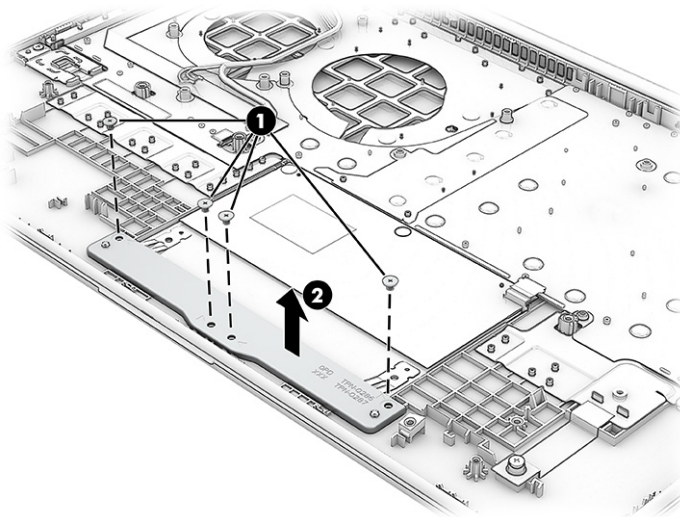

3. Remove the protective tape from the top of the connector on the touchpad **(1)**.
4. Disconnect the cable **(2)** from the touchpad ZIF connector.
5. Peel the large black Mylar off the top of the touchpad **(3)**.
6. Remove the three broadhead Phillips M2.0 × 2.0 screws **(4)** that secure the touchpad to the computer.

7. Remove the touchpad (5).

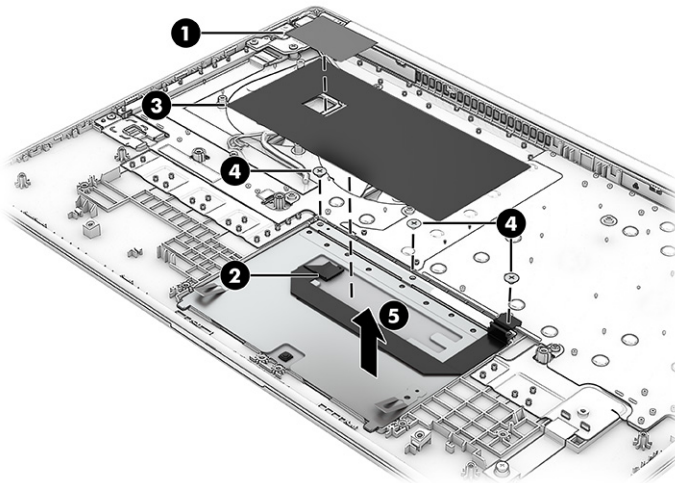

To install the touchpad, reverse this procedure.

Display assembly

To remove and disassemble the display assembly, use these procedures and illustrations.

Full hinge-up displays are not available as spare parts. Spare parts for displays are available only at the subcomponent level.

Before removing the display panel, follow these steps:

1. Prepare the computer for disassembly (see [Preparation for disassembly on page 32](#)).
2. Remove the bottom cover (see [Bottom cover on page 32](#)).
3. Remove the battery (see [Battery on page 33](#)).

Remove the display assembly:

1. Remove the Mylar that covers the connectors on the WLAN module (1).
2. Disconnect the antenna cables (2) from the WLAN module.
3. Remove the antenna cable from the routing clips (3).

The **#1/MAIN** WLAN antenna cable connects to the WLAN module **#1/Main** terminal. The **#2/AUX** WLAN antenna cable connects to the WLAN module **#2/Aux** terminal.

4. Disconnect the display panel cable (4) from the ZIF connector on the system board.

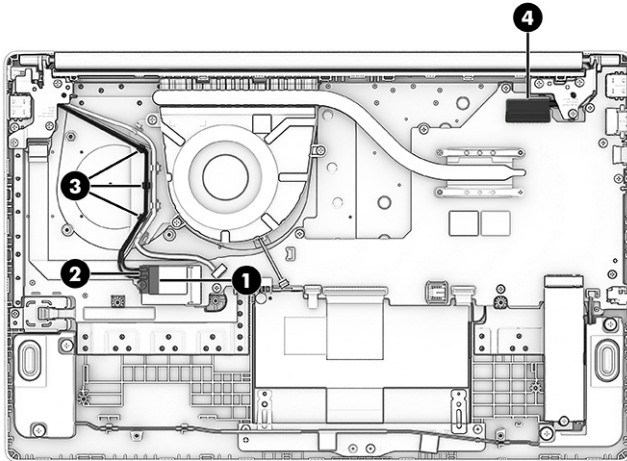

5. Remove the six Phillips M2.5 × 5.0 screws (1) that secure the display assembly to the computer.
6. Open the display to 90° to open the hinges (2).
7. Separate the display from the computer (3).

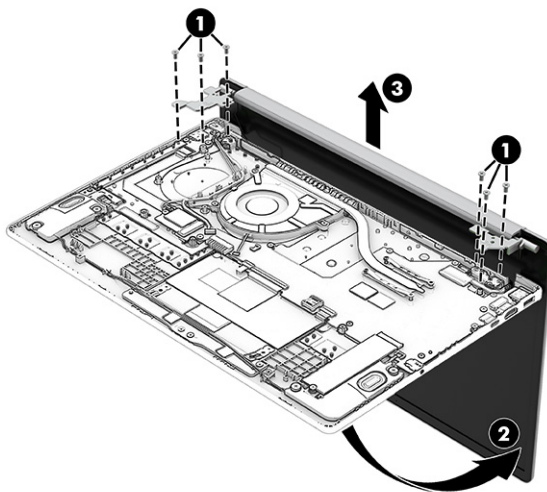

8. To remove the display bezel:
 - a. Release the top, left and right sides of the display bezel (1) from the display assembly.
 - b. Insert a flat, nonmarking tool into the seam at the bottom of the bezel (2) to release the bottom edge of the bezel (3) from the display assembly.
 - c. Remove the display bezel (4) from the display assembly.

Bezel adhesive is available in the Adhesive Kit as spare part number N36079-001.

The bezel is available as the following spare part numbers:

N41354-001: Turbo silver, aluminum

N41355-001: Turbo silver, plastic

N41356-001: Dark ash silver, plastic

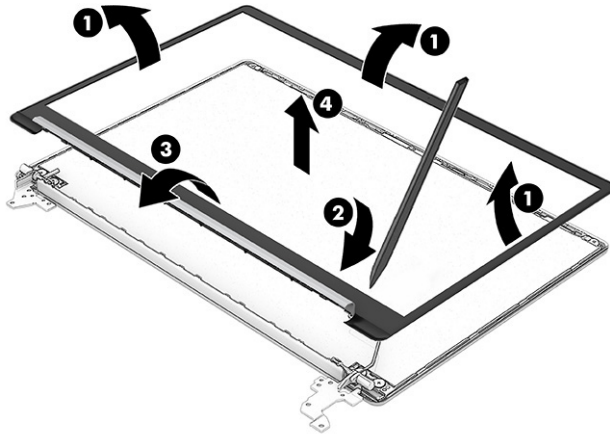

9. To remove the display panel:

- a.** On the bottom left and right sides of the display panel, use tweezers to grasp the ends of the stretchable tape **(1)** that is installed under the panel.
- b.** While turning the tweezers **(2)**, wrap the tape around the tweezers as you continue to pull the tape **(3)** out from behind the display panel.
- c.** Lift the panel and place it next to the display rear cover **(4)**.

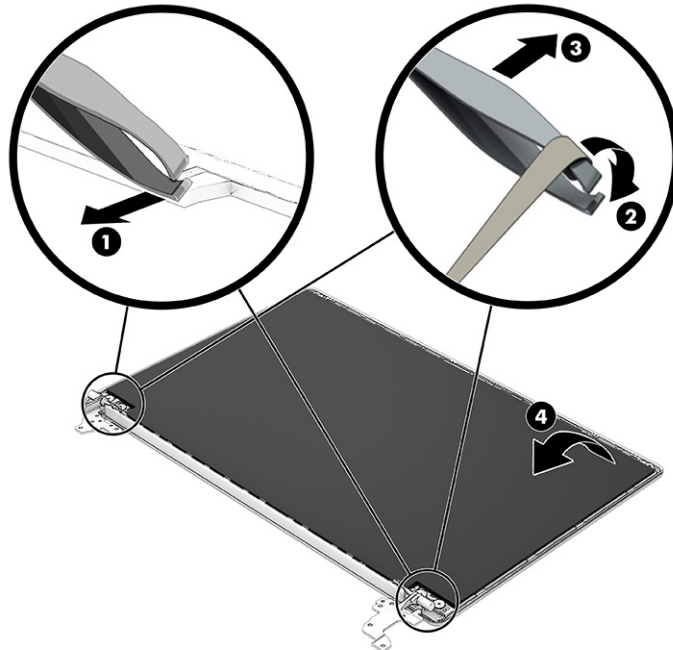

- d.** Remove the tape from on top of the connector on the back of the display panel **(1)**.

- e. Disconnect the cable from the panel (2).

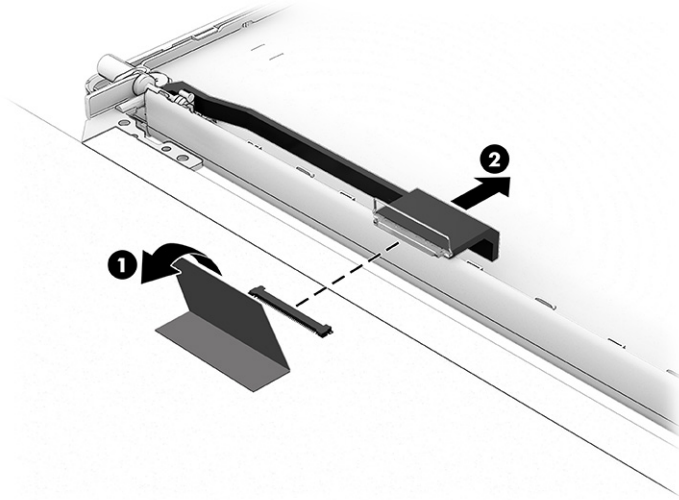

- f. When replacing the display panel, use the following illustration to determine the proper installation locations of the stretchable tape on the display back cover.

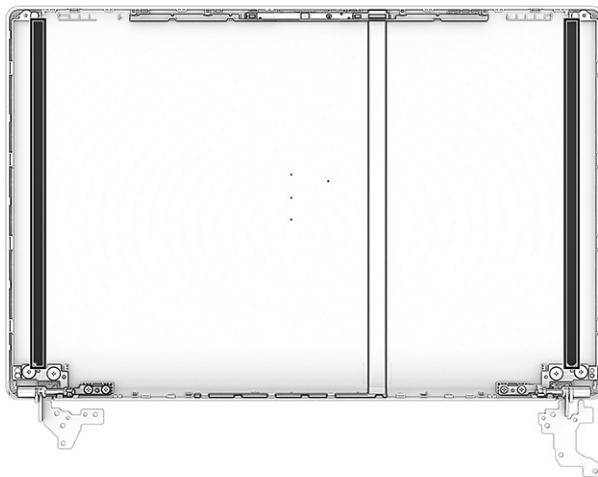

Display panels are available as the following spare part numbers:

N41936-001–FHD, antiglare, low blue light, 400 nits

N41934-001–FHD, SVA, 250 nits

N41935-001–FHD, UWVA, 250 nits

N41932-001–HD, antiglare, 250 nits

Display panel adhesive is available as spare part number N36079-001.

10. To remove the hinges from the display enclosure:
- Remove the two Phillips M2.0 × 2.5 screws (1) that secure the hinges to the display back cover.
 - Remove the four Phillips M2.5 × 3.5 screws (2) that secure each hinge to the display back cover.
 - Remove the four Phillips M2.5 × 2.5 screws (3) that secure each hinge to the display back cover.

- d. Remove the display hinges (4).

The display hinges are available using spare part number N36083-001.

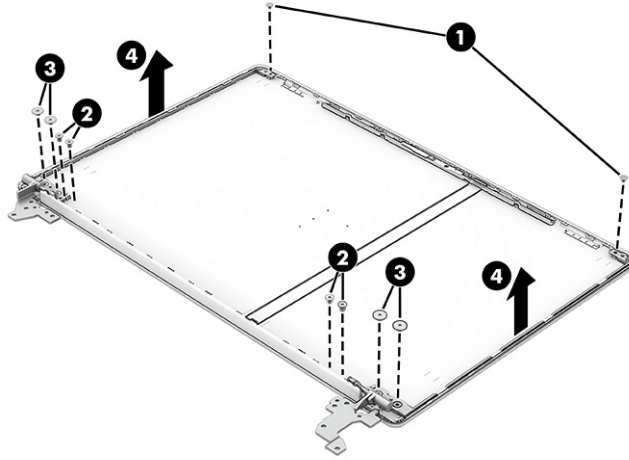

- 11. To remove the camera module:

- a. Lift the camera support bracket straight up and out of the display rear cover.

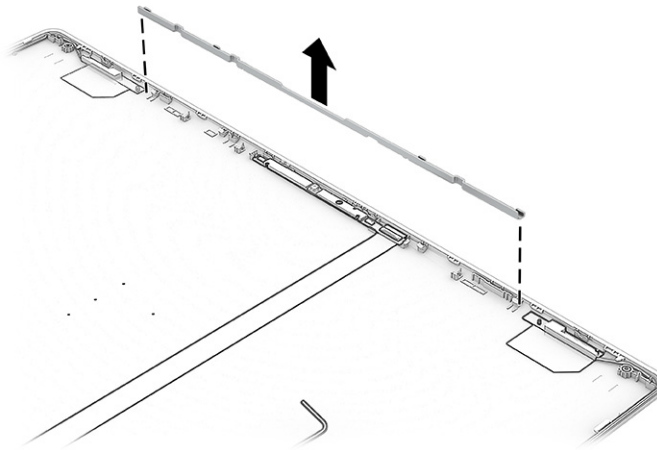

- b. Carefully lift the module to release it from the display back cover (1). (The module is attached to the display back cover with double-sided adhesive.)
- c. Disconnect the cable from the ZIF connector on the module (2). Note that the cable routes underneath the module.

Camera modules are available as spare part number N36084-001 for FHD models and N36085-001 for HD models.

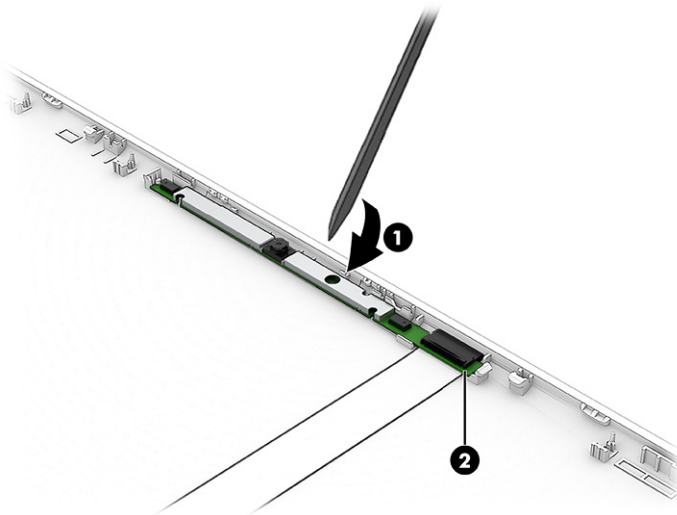

12. To remove the camera cable:

- Peel the cable off the inside of the display rear cover.

The display cable is available as spare part number N36087-001.

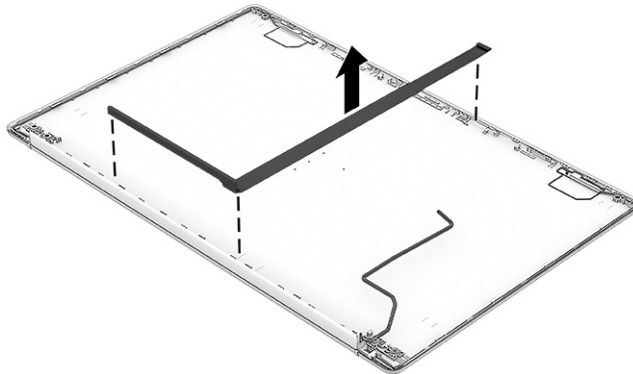

13. To remove the WLAN antennas:

- a. Peel the wireless antennas off the display rear cover (1). (The antennas are attached with double-sided adhesive.)

- b. Release the wireless antenna cables from the retention clips (2) on the display back cover. The wireless antennas are available using spare part number N36081-001 for a dual antenna kit or N36082-001 for a single antenna kit.

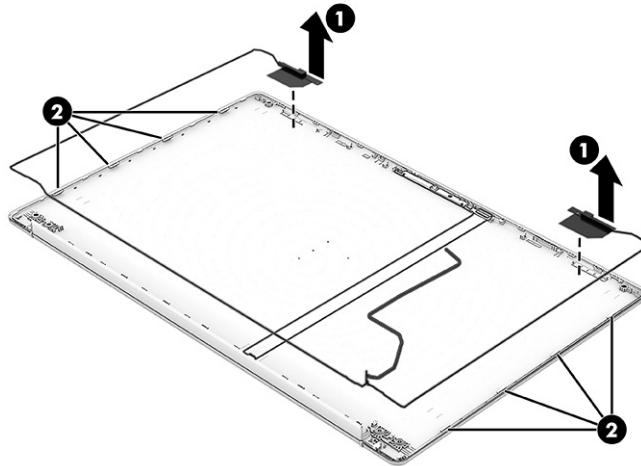

The display back cover with dual antennas is available as the following spare part numbers:

N41348-001: Turbo silver, aluminum finish, 3.2 mm display panel

N41349-001: Turbo silver, aluminum finish, 2.6 mm display panel

N41350-001: Turbo silver, plastic finish, 3.2 mm display panel

N41351-001: Turbo silver, plastic finish, 2.6 mm display panel

N41352-001: Dark ash silver, 3.2 mm display panel

N41353-001: Dark ash silver, 2.6 mm display panel

To reassemble and replace the display assembly, reverse these procedures.

Top cover with keyboard

The top cover with keyboard remains after removing all other spare parts from the computer. In this section, the first table provides the main spare part numbers for the top covers with keyboards. The second table provides the country codes.

Table 5-14 Top cover with keyboard descriptions and part numbers

Description	Spare part number
Top cover with keyboard, dark ash silver, jet black	N40880-xxx
Top cover with keyboard, Pike silver, flint opaque, not backlit	N40881-xxx
Top cover with keyboard, Pike silver, flint opaque, backlit	N40882-xxx
Top cover with keyboard, Pike silver, flint opaque, not backlit, with fingerprint reader	N40883-xxx
Top cover with keyboard, Pike silver, flint opaque, backlit, with fingerprint reader	N40884-xxx

Table 5-15 Spare part country codes

For use in country or region	Spare part number	For use in country or region	Spare part number	For use in country or region	Spare part number
Belgium	-A41	Hungary	-211	Saudi Arabia	-171
Brazil	-201	Iceland	-DD1	Slovenia	-BA1
Bulgaria	-261	India	-D61	South Korea	-AD1
Chile	-161	Israel	-BB1	Spain	-071
Czech Republic/Slovakia	-FL1	Italy	-061	Switzerland	-BG1
Denmark	-081	Japan	-291	Taiwan	-AB1
Denmark, Finland, and Norway	-DH1	The Netherlands	-B31	Thailand	-281
French Canada	-DB1	Northern Africa	-FP1	Turkey	-141
Finland/Sweden	-B71	Norway	-091	Turkey-F	-541
France	-051	Portugal	-131	Ukraine	-BD1
Germany	-041	Romania	-271	United Kingdom	-031
Greece	-151	Russia	-251	United States	-001

6 Using Setup Utility (BIOS)

Setup Utility, or Basic Input/Output System (BIOS), controls communication between all the input and output devices on the system (such as disk drives, display, keyboard, mouse, and printer). Setup Utility (BIOS) includes settings for the types of devices installed, the startup sequence of the computer, and the amount of system and extended memory.

 **NOTE:** To start Setup Utility on convertible computers, your computer must be in notebook mode and you must use the keyboard attached to your notebook.

Starting Setup Utility (BIOS)

You have several ways to access the Setup Utility (BIOS).

 **IMPORTANT:** Use extreme care when making changes in Setup Utility (BIOS). Errors can prevent the computer from operating properly.

- Turn on or restart the computer and quickly press **f10**.

- or -

Turn on or restart the computer, quickly press **esc**, and then press **f10** when the Start menu is displayed.

Updating Setup Utility (BIOS)

Updated versions of Setup Utility (BIOS) might be available on the HP website. Most BIOS updates on the HP website are packaged in compressed files called *SoftPaqs*. Some download packages contain a file named *Readme.txt*, which contains information regarding installing and troubleshooting the file.

Determining the BIOS version

To decide whether you need to update Setup Utility (BIOS), first determine the BIOS version on your computer.

To reveal the BIOS version information (also known as *ROM date* and *System BIOS*), use one of these options.

- HP Support Assistant
 1. Select the **Search** icon in the taskbar, type `support` in the search box, and then select the **HP Support Assistant** app.

- or -

Select the question mark icon in the taskbar.

 2. Under **My notebook**, select **Specifications**.
- Setup Utility (BIOS)
 1. Start Setup Utility (BIOS) (see [Starting Setup Utility \(BIOS\) on page 57](#)).

2. Select **Main**, and then make note of the BIOS version.
 3. Select **Exit**, select one of the options, and then follow the on-screen instructions.
- In Windows, press **ctrl+alt+s**.

To check for later BIOS versions, see [Preparing for a BIOS update on page 58](#).

Preparing for a BIOS update

Be sure to follow all prerequisites before downloading and installing a BIOS update.

 **IMPORTANT:** To reduce the risk of damage to the computer or an unsuccessful installation, download and install a BIOS update only when the computer is connected to reliable external power using the AC adapter. Do not download or install a BIOS update while the computer is running on battery power, docked in an optional docking device, or connected to an optional power source. During the download and installation, follow these instructions:

- Do not disconnect power from the computer by unplugging the power cord from the AC outlet.
- Do not shut down the computer or initiate Sleep.
- Do not insert, remove, connect, or disconnect any device, cable, or cord.

 **NOTE:** If your computer is connected to a network, consult the network administrator before installing any software updates, especially system BIOS updates.

Downloading a BIOS update

After you review the prerequisites, you can check for and download BIOS updates.

1. Select the **Search** icon in the taskbar, type `support` in the search box, and then select the **HP Support Assistant** app.
- or -
Select the question mark icon in the taskbar.
2. Select **Updates**. The **Checking for Updates** window opens, and Windows checks for updates.
3. Follow the on-screen instructions.
4. At the download area, follow these steps:
 - a. Identify the most recent BIOS update and compare it to the BIOS version currently installed on your computer. If the update is more recent than your BIOS version, make a note of the date, name, or other identifier. You might need this information to locate the update later, after it has been downloaded to your hard drive.
 - b. Follow the on-screen instructions to download your selection to the hard drive.

Make a note of the path to the location on your hard drive where the BIOS update is downloaded. You will need to access this path when you are ready to install the update.

Installing a BIOS update

BIOS installation procedures vary. Follow any instructions that appear on the screen after the download is complete. If no instructions appear, follow these steps.

1. Select the **Search** icon in the taskbar, type `file` in the search box, and then select **File Explorer**.

2. Select your hard drive designation. The hard drive designation is typically Local Disk (C:).
3. Using the hard drive path you recorded earlier, open the folder that contains the update.
4. Double-click the file that has an .exe extension (for example, *filename.exe*).

The BIOS installation begins.

5. Complete the installation by following the on-screen instructions.



NOTE: After a message on the screen reports a successful installation, you can delete the downloaded file from your hard drive.

7 Backing up, restoring, and recovering

You can use Windows tools or HP software to back up your information, create a restore point, reset your computer, create recovery media, or restore your computer to its factory state. Performing these standard procedures can return your computer to a working state faster.

 **IMPORTANT:** If you are performing recovery procedures on a tablet, the tablet battery must be at least 70% charged before you start the recovery process.

 **IMPORTANT:** For a tablet with a detachable keyboard, connect the tablet to the keyboard base before beginning any recovery process.

Backing up information and creating recovery media

These methods of creating recovery media and backups are available on select products only.

Using Windows tools for backing up

HP recommends that you back up your information immediately after initial setup. You can do this task either using Windows Backup locally with an external USB flash drive or using online tools.

 **NOTE:** If computer storage is 32 GB or less, Microsoft® System Restore is disabled by default.

Using the HP Cloud Recovery Download Tool to create recovery media (select products only)

You can use the HP Cloud Recovery Download Tool to create HP Recovery media on a bootable USB flash drive.

For details:

- Go to <http://www.hp.com>, search for HP Cloud Recovery, and then select the result that matches the type of computer that you have.

 **NOTE:** If you cannot create recovery media yourself, contact support to obtain recovery discs. Go to <http://www.hp.com/support>, select your country or region, and then follow the on-screen instructions.

 **IMPORTANT:** HP recommends that you follow the [Restoring and recovery methods on page 61](#) to restore your computer before you obtain and use the HP recovery discs. Using a recent backup can return your machine to a working state sooner than using the HP recovery discs. After the system is restored, reinstalling all the operating system software released since your initial purchase can be a lengthy process.

Restoring and recovering your system

You have several tools available to recover your system both within and outside of Windows if the desktop cannot load.

HP recommends that you attempt to restore your system using the [Restoring and recovery methods on page 61](#).

Creating a system restore

System Restore is available in Windows. The System Restore software can automatically or manually create restore points, or snapshots, of the system files and settings on the computer at a particular point.

When you use System Restore, it returns your computer to its state at the time you made the restore point. Your personal files and documents should not be affected.

Restoring and recovery methods

After you run the first method, test to see whether the issue still exists before you proceed to the next method, which might now be unnecessary.

1. Run a Microsoft System Restore.
2. Run Reset this PC.

 **NOTE:** The options **Remove everything** and then **Fully clean the drive** can take several hours to complete and leave no information on your computer. It is the safest way to reset your computer before you recycle it.

3. Recover using HP Recovery media. For more information, see [Recovering using HP Recovery media on page 61](#).

For more information about the first two methods, see the Get Help app:

- Select the **Start** button, select **All apps**, select the **Get Help** app, and then enter the task you want to perform.

 **NOTE:** You must be connected to the internet to access the Get Help app.

Recovering using HP Recovery media

You can use HP Recovery media to recover the operating system and drivers that were installed at the factory. On select products, you can create recovery media on a bootable USB flash drive using the HP Cloud Recovery Download Tool.

For details, see [Using the HP Cloud Recovery Download Tool to create recovery media \(select products only\) on page 60](#).

 **NOTE:** If you cannot create recovery media yourself, contact support to obtain recovery discs. Go to <http://www.hp.com/support>, select your country or region, and then follow the on-screen instructions.

To recover your system:

- Insert the HP Recovery media, and then restart the computer.

 **NOTE:** HP recommends that you follow the [Restoring and recovery methods on page 61](#) to restore your computer before you obtain and use the HP recovery discs. Using a recent backup can return your machine to a working state sooner than using the HP recovery discs. After the system is restored, reinstalling all the operating system software released since your initial purchase can be a lengthy process.

Changing the computer boot order

If your computer does not restart using the HP Recovery media, you can change the computer boot order, which is the order of devices listed in BIOS for startup information. You can select an optical drive or a USB flash drive, depending on the location of your HP Recovery media.

 **IMPORTANT:** For a tablet with a detachable keyboard, connect the tablet to the keyboard base before beginning these steps.

To change the boot order:

1. Insert the HP Recovery media.
2. Access the system **Startup** menu.
 - For computers or tablets with keyboards attached, turn on or restart the computer or tablet, quickly press **esc**, and then press **f9** for boot options.
 - For tablets without keyboards, turn on or restart the tablet, quickly press and hold the volume up button, and then select **f9**.

– or –

Turn on or restart the tablet, quickly press and hold the volume down button, and then select **f9**.
3. Select the optical drive or USB flash drive from which you want to boot, and then follow the on-screen instructions.

Using HP Sure Recover (select products only)

Select computer models are configured with HP Sure Recover, a PC operating system (OS) recovery solution built into the hardware and software. HP Sure Recover can fully restore the HP OS image without installed recovery software.

Using HP Sure Recover, an administrator or user can restore the system and install:

- Latest version of the operating system
- Platform-specific device drivers
- Software applications, in the case of a custom image

To access the latest documentation for HP Sure Recover, go to <http://www.hp.com/support>. Follow the on-screen instructions to find your product and locate your documentation.

8 Using HP PC Hardware Diagnostics

You can use the HP PC Hardware Diagnostics utility to determine whether your computer hardware is running properly. The three versions are HP PC Hardware Diagnostics Windows, HP PC Hardware Diagnostics UEFI (Unified Extensible Firmware Interface), and (for select products only) Remote HP PC Hardware Diagnostics UEFI, a firmware feature.

Using HP PC Hardware Diagnostics Windows (select products only)

HP PC Hardware Diagnostics Windows is a Windows-based utility that allows you to run diagnostic tests to determine whether the computer hardware is functioning properly. The tool runs within the Windows operating system to diagnose hardware failures.

If HP PC Hardware Diagnostics Windows is not installed on your computer, you must download and install it. To download HP PC Hardware Diagnostics Windows, see [Downloading HP PC Hardware Diagnostics Windows on page 64](#).

Using an HP PC Hardware Diagnostics Windows hardware failure ID code

When HP PC Hardware Diagnostics Windows detects a failure that requires hardware replacement, a 24-digit failure ID code is generated for select component tests. For interactive tests, such as keyboard, mouse, or audio and video palette, you must perform troubleshooting steps before you can receive a failure ID.

- You have several options after you receive a failure ID:
 - Select **Next** to open the Event Automation Service (EAS) page, where you can log the case.
 - Scan the QR code with your mobile device, which takes you to the EAS page, where you can log the case.
 - Select the box next to the 24-digit failure ID to copy your failure code and send it to support.

Accessing HP PC Hardware Diagnostics Windows

After HP PC Hardware Diagnostics Windows is installed, you can access it from HP Support Assistant or the Start menu.

Accessing HP PC Hardware Diagnostics Windows from HP Support Assistant

After HP PC Hardware Diagnostics Windows is installed, follow these steps to access it from HP Support Assistant:

1. Complete one of the following tasks:
 - Select the **Search** icon in the taskbar, type `support` in the search box, and then select the **HP Support Assistant** app.
 - Select the question mark icon in the taskbar.
2. Select **Fixes & Diagnostics**.

3. Select **Run hardware diagnostics**, and then select **Launch**.
4. When the tool opens, select the type of diagnostic test that you want to run, and then follow the on-screen instructions.



NOTE: To stop a diagnostic test, select **Cancel**.

Accessing HP PC Hardware Diagnostics Windows from the Start menu (select products only)

After HP PC Hardware Diagnostics Windows is installed, follow these steps to access it from the Start menu:

1. Select the **Start** button, and then select **All apps**.
2. Select **HP PC Hardware Diagnostics Windows**.
3. When the tool opens, select the type of diagnostic test that you want to run, and then follow the on-screen instructions.



NOTE: To stop a diagnostic test, select **Cancel**.

Downloading HP PC Hardware Diagnostics Windows

The HP PC Hardware Diagnostics Windows downloading instructions are provided in English only. You must use a Windows computer to download this tool because only .exe files are provided.

Downloading the latest HP PC Hardware Diagnostics Windows version from HP

To download HP PC Hardware Diagnostics Windows from HP, follow these steps:

1. Go to <http://www.hp.com/go/techcenter/pcdiags>. The HP PC Diagnostics home page is displayed.
2. Select **Download HP Diagnostics Windows**, and then select the specific Windows diagnostics version to download to your computer or a USB flash drive.

The tool downloads to the selected location.

Downloading the HP PC Hardware Diagnostics Windows from the Microsoft Store

You can download the HP PC Hardware Diagnostics Windows from the Microsoft Store:

1. Select the Microsoft Store app on your desktop or select the **Search** icon in the taskbar, and then type `Microsoft Store` in the search box.
2. Type `HP PC Hardware Diagnostics Windows` in the **Microsoft Store** search box.
3. Follow the on-screen directions.

The tool downloads to the selected location.

Downloading HP Hardware Diagnostics Windows by product name or number (select products only)

You can download HP PC Hardware Diagnostics Windows by product name or number.



NOTE: For some products, you might have to download the software to a USB flash drive by using the product name or number.

1. Go to <http://www.hp.com/support>.
2. Select **Software and Drivers**, select your type of product, and then enter the product name or number in the search box that is displayed.
3. In the **Diagnostics** section, select **Download**, and then follow the on-screen instructions to select the specific Windows diagnostics version to be downloaded to your computer or USB flash drive.

The tool downloads to the selected location.

Installing HP PC Hardware Diagnostics Windows

To install HP PC Hardware Diagnostics Windows, navigate to the folder on your computer or the USB flash drive where the .exe file downloaded, double-click the .exe file, and then follow the on-screen instructions.

Using HP PC Hardware Diagnostics UEFI

HP PC Hardware Diagnostics Unified Extensible Firmware Interface (UEFI) allows you to run diagnostic tests to determine whether the computer hardware is functioning properly. The tool runs outside the operating system so that it can isolate hardware failures from issues that are caused by the operating system or other software components.

 **NOTE:** For some products, you must use a Windows computer and a USB flash drive to download and create the HP UEFI support environment because only .exe files are provided. For more information, see [Downloading HP PC Hardware Diagnostics UEFI to a USB flash drive on page 66](#).

If your PC does not start in Windows, you can use HP PC Hardware Diagnostics UEFI to diagnose hardware issues.

Using an HP PC Hardware Diagnostics UEFI hardware failure ID code

When HP PC Hardware Diagnostics UEFI detects a failure that requires hardware replacement, a 24-digit failure ID code is generated.

For assistance in solving the problem:

- Select **Contact HP**, accept the HP privacy disclaimer, and then use a mobile device to scan the failure ID code that appears on the next screen. The HP Customer Support - Service Center page appears with your failure ID and product number automatically filled in. Follow the on-screen instructions.

- or -

Contact support, and provide the failure ID code.

 **NOTE:** To start diagnostics on a convertible computer, your computer must be in notebook mode, and you must use the attached keyboard.

 **NOTE:** If you need to stop a diagnostic test, press **esc**.

Starting HP PC Hardware Diagnostics UEFI

To start HP PC Hardware Diagnostics UEFI, follow this procedure.

1. Turn on or restart the computer, and quickly press **esc**.

2. Press **f2**.

The BIOS searches three places for the diagnostic tools, in the following order:

- a. Connected USB flash drive



NOTE: To download the HP PC Hardware Diagnostics UEFI tool to a USB flash drive, see [Downloading the latest HP PC Hardware Diagnostics UEFI version on page 66](#).

- b. Hard drive

- c. BIOS

3. When the diagnostic tool opens, select the type of diagnostic test that you want to run, and then follow the on-screen instructions.

Downloading HP PC Hardware Diagnostics UEFI to a USB flash drive

Downloading HP PC Hardware Diagnostics UEFI to a USB flash drive can be useful in some situations.

- HP PC Hardware Diagnostics UEFI is not included in the preinstallation image.
- HP PC Hardware Diagnostics UEFI is not included in the HP Tool partition.
- The hard drive is damaged.



NOTE: The HP PC Hardware Diagnostics UEFI downloading instructions are provided in English only, and you must use a Windows computer to download and create the HP UEFI support environment because only .exe files are provided.

Downloading the latest HP PC Hardware Diagnostics UEFI version

To download the latest HP PC Hardware Diagnostics UEFI version to a USB flash drive, follow this procedure:

1. Go to <http://www.hp.com/go/techcenter/pcdiags>. The HP PC Diagnostics home page is displayed.
2. Select **Download HP Diagnostics UEFI**, and then select **Run**.

Downloading HP PC Hardware Diagnostics UEFI by product name or number (select products only)

You can download HP PC Hardware Diagnostics UEFI by product name or number (select products only) to a USB flash drive.



NOTE: For some products, you might have to download the software to a USB flash drive by using the product name or number.

1. Go to <http://www.hp.com/support>.
2. Enter the product name or number, select your computer, and then select your operating system.
3. In the **Diagnostics** section, follow the on-screen instructions to select and download the specific UEFI Diagnostics version for your computer.

Using Remote HP PC Hardware Diagnostics UEFI settings (select products only)

Remote HP PC Hardware Diagnostics UEFI is a firmware (BIOS) feature that downloads HP PC Hardware Diagnostics UEFI to your computer. It can then run the diagnostics on your computer, and it might upload results to a preconfigured server.

For more information about Remote HP PC Hardware Diagnostics UEFI, go to <http://www.hp.com/go/techcenter/pcdiags>, and then select **Find out more**.

Downloading Remote HP PC Hardware Diagnostics UEFI

HP Remote PC Hardware Diagnostics UEFI is also available as a SoftPaq that you can download to a server.

Downloading the latest Remote HP PC Hardware Diagnostics UEFI version

You can download the latest HP PC Hardware Diagnostics UEFI version to a USB flash drive.

1. Go to <http://www.hp.com/go/techcenter/pcdiags>. The HP PC Diagnostics home page is displayed.
2. Select **Download Remote Diagnostics**, and then select **Run**.

Downloading Remote HP PC Hardware Diagnostics UEFI by product name or number

You can download HP Remote PC Hardware Diagnostics UEFI by product name or number.



NOTE: For some products, you might have to download the software by using the product name or number.

1. Go to <http://www.hp.com/support>.
2. Select **Software and Drivers**, select your type of product, enter the product name or number in the search box that is displayed, select your computer, and then select your operating system.
3. In the **Diagnostics** section, follow the on-screen instructions to select and download the **Remote UEFI** version for the product.

Customizing Remote HP PC Hardware Diagnostics UEFI settings

Using the Remote HP PC Hardware Diagnostics setting in Computer Setup (BIOS), you can perform several customizations.

- Set a schedule for running diagnostics unattended. You can also start diagnostics immediately in interactive mode by selecting **Execute Remote HP PC Hardware Diagnostics**.
- Set the location for downloading the diagnostic tools. This feature provides access to the tools from the HP website or from a server that has been preconfigured for use. Your computer does not require the traditional local storage (such as a hard drive or USB flash drive) to run remote diagnostics.
- Set a location for storing the test results. You can also set the user name and password that you use for uploads.
- Display status information about the diagnostics run previously.

To customize Remote HP PC Hardware Diagnostics UEFI settings, follow these steps:

1. Turn on or restart the computer, and when the HP logo appears, press **f10** to enter Computer Setup.
2. Select **Advanced**, and then select **Settings**.
3. Make your customization selections.
4. Select **Exit**, then select **Save Changes and Exit** to save your settings.

Your changes take effect when the computer restarts.

9 Specifications

This chapter provides specifications for your computer system.

Computer specifications

This section provides specifications for your computer. When you travel with your computer, the computer dimensions and weights, as well as input power ratings and operating specifications, provide helpful information.

Table 9-1 Computer specifications

	Metric	U.S.
Dimensions		
Width	359.8 mm	14.17 in
Depth	236 mm	9.29 in
Height	18.6 mm	0.73 in
Weight		
	1598 g	3.52 lb
Input power		
Operating voltage and current	19.5 V dc @ 3.33 A - 65 W	
	19.5 V dc @ 2.31 A - 45 W	
Temperature		
Operating	5°C to 35°C	41°F to 95°F
Nonoperating	-20°C to 60°C	-4°F to 140°F
Relative humidity (noncondensing)		
Operating	10% to 90%	
Nonoperating	5% to 95%	
Maximum altitude (unpressurized)		
Operating	-15 m to 3,048 m	-50 ft to 10,000 ft
Nonoperating	-15 m to 12,192 m	-50 ft to 40,000 ft
NOTE: Applicable product safety standards specify thermal limits for plastic surfaces. The device operates well within this range of temperatures.		

Display specifications

This section provides specifications for your display.

Table 9-2 Display specifications

	Metric	U.S.
Active diagonal size	39.6 cm	15.6 in
Resolution	1920 × 1080 (FHD)	
	1366 × 768 (HD)	
Surface treatment	BrightView	
	Antiglare	
Brightness	300 nits	
	250 nits	
Viewing angle	UWVA	
	SVA	
Backlight	WLED	
Display panel interface	eDP	

Solid-state drive specifications

This section provides specifications for your solid-state drives.

Table 9-3 Solid-state drive specifications

	256 GB*	512 GB*	1 TB*
Dimensions			
Height	1.0 mm	1.0 mm	1.0 mm
Length	50.8 mm	50.8 mm	50.8 mm
Width	28.9 mm	28.9 mm	28.9 mm
Weight	< 10 g	< 10 g	< 10 g
Interface type			
Ready time, maximum (to not busy)	1.0 ms	< 1.0 ms	1.0 ms
Access times, logical	0.1 ms	0.1 ms	0.1 ms
Transfer rate			
Sequential read	up to 2150 MBps	up to 2150 MBps	up to 2150 MBps
Random read	Up to 300,000 IOPs	Up to 300,000 IOPs	Up to 300,000 IOPs
Sequential write	up to 1550 MBps	up to 1550 MBps	up to 1550 MBps
Random write	Up to 100,000 IOPs	Up to 100,000 IOPs	Up to 100,000 IOPs
Total logical sectors	468,883,296	1,000,215,216	1,500,336,388
Operating temperature	0°C to 70°C (32°F to 158°F)		

*1 GB = 1 billion bytes when referring to hard drive storage capacity. Actual accessible capacity is less. Actual drive specifications might differ slightly.

Table 9-3 Solid-state drive specifications (continued)

	256 GB*	512 GB*	1 TB*
NOTE:	Certain restrictions and exclusions apply. Contact support for details.		

10 Statement of memory volatility

For general information regarding nonvolatile memory in HP business computers, and to restore nonvolatile memory that can contain personal data after the system has been turned off and the hard drive has been removed, use these instructions.

HP business computer products that use Intel®-based or AMD®-based system boards contain volatile DDR memory. The amount of nonvolatile memory present in the system depends upon the system configuration. Intel-based and AMD-based system boards contain nonvolatile memory subcomponents as originally shipped from HP, with the following assumptions:

- No subsequent modifications were made to the system.
- No applications, features, or functionality were added to or installed on the system.

Following system shutdown and removal of all power sources from an HP business computer system, personal data can remain on volatile system memory (DIMMs) for a finite period of time and also remains in nonvolatile memory. Use the following steps to remove personal data from the computer, including the nonvolatile memory found in Intel-based and AMD-based system boards.



NOTE: If your tablet has a keyboard base, connect to the keyboard base before beginning steps in this chapter.

Current BIOS steps

Use these instructions to restore nonvolatile memory.

1. Follow these steps to restore the nonvolatile memory that can contain personal data. Restoring or reprogramming nonvolatile memory that does not store personal data is neither necessary nor recommended.
 - a. Turn on or restart the computer, and then quickly press **esc**.



NOTE: If the system has a BIOS administrator password, type the password at the prompt.

- b. Select **Main**, select **Apply Factory Defaults and Exit**, and then select **Yes** to load defaults. The computer restarts.
- c. During the restart, press **esc** while the "Press the ESC key for Startup Menu" message is displayed at the bottom of the screen.



NOTE: If the system has a BIOS administrator password, type the password at the prompt.

- d. Select the **Security** menu, select **Restore Security Settings to Factory Defaults**, and then select **Yes** to restore security level defaults. The computer restarts.
- e. During the restart, press **esc** while the "Press the ESC key for Startup Menu" message is displayed at the bottom of the screen.



NOTE: If the system has a BIOS administrator password, type the password at the prompt.

- f. If an asset or ownership tag is set, select the **Security** menu and scroll down to the **Utilities** menu. Select **System IDs**, and then select **Asset Tracking Number**. Clear the tag, and then make the selection to return to the prior menu.
- g. If a DriveLock password is set, select the **Security** menu, and scroll down to **Hard Drive Utilities** under the **Utilities** menu. Select **Hard Drive Utilities**, select **DriveLock**, and then clear the check box for **DriveLock password on restart**. Select **OK** to proceed.
- h. Select the **Main** menu, and then select **Reset BIOS Security to factory default**. Select **Yes** at the warning message. The computer restarts.
- i. During the restart, press **esc** while the "Press the ESC key for Startup Menu" message is displayed at the bottom of the screen.



NOTE: If the system has a BIOS administrator password, type the password at the prompt.

- j. Select the **Main** menu, select **Apply Factory Defaults and Exit**, select **Yes** to save changes and exit, and then select **Shutdown**.
 - k. Restart the system. If the system has a Trusted Platform Module (TPM), fingerprint reader, or both, one or two prompts will appear—one to clear the TPM and the other to Reset Fingerprint Sensor. Press or tap **f1** to accept or **f2** to reject.
 - l. Remove all power and system batteries for at least 24 hours.
2. Complete one of the following:
- Remove and retain the storage drive.
- or -
 - Clear the drive contents by using a third-party utility designed to erase data from an SSD.
- or -
 - Clear the contents of the drive by using the following BIOS Setup Secure Erase command option steps:



NOTE: If you clear data using Secure Erase, you cannot recover it.

- a. Turn on or restart the computer, and then quickly press **esc**.
- b. Select the **Security** menu and scroll down to the **esc** menu.
- c. Select **Hard Drive Utilities**.
- d. Under **Utilities**, select **Secure Erase**, select the hard drive storing the data you want to clear, and then follow the on-screen instructions to continue.

- or -

Clear the contents of the drive using the following Disk Sanitizer commands steps:

- i. Turn on or restart the computer, and then quickly press **esc**.
- ii. Select the **Security** menu and scroll down to the **Utilities** menu.
- iii. Select **Hard Drive Utilities**.

- iv. Under **Utilities**, select **Disk Sanitizer**, select the hard drive with the data that you want to clear, and then follow the on-screen instructions to continue.

 **NOTE:** The amount of time it takes for Disk Sanitizer to run can take several hours. Plug the computer into an AC outlet before starting.

Nonvolatile memory usage

Use this table to troubleshoot nonvolatile memory usage.

Table 10-1 Troubleshooting steps for nonvolatile memory usage

Description	Volatility description	Storage user data	How to erase
Primary storage device, holds the OS, applications, and application settings	Non-volatile, 8-256 GB of eMMC or NVMe SSD storage, removable	Yes ¹	Follow instructions below under “Erase the Primary Storage Device”
System memory (RAM), holds transient data during system operation	Volatile, SODIMM socket. Removable (4 GB/8 GB/16 GB)	Yes	Unplug unit from power
Permanent system BIOS settings	Non-volatile; 16 KB; stored	No ²	Follow instructions below under “Clearing BIOS Settings”
System boot ROM (BIOS)	Non-volatile memory, 128 Mbit (16 MB) socketed, removable	No	Download the latest BIOS for your model from the HP website and follow the instructions to flash the BIOS that are on the website
RTC (CMOS) RAM	Volatile memory, 256 bytes located in AMD embedded System on Chip (SoC)	No	Unplug unit from main power, remove top cover and press Clear CMOS button
Keyboard/mouse (ROM)	Non-volatile, 2 KB embedded in the super I/O controller (SIO2)	Yes	N/A
Keyboard/mouse (RAM)	Volatile, 256 bytes embedded in the super I/O controller (SIO2)	No	Unplug unit from main power
LOM EEPROM	Non-volatile, 2 MB embedded in LAN controller	No	N/A
Trusted Platform Module (TPM)	Non-volatile; 51 KB ROM for firmware and 38 KB system parametric data	No ³	Follow instructions below under “Clearing TPM”

¹ Under typical operation, the only user data stored on the primary storage device are preferences for device configuration and settings for connections. However, the administrator can configure the system to allow users to store data locally.

² Only user data potentially stored in BIOS Settings are the ownership and asset tags, administrator password, and startup password.

³ The Trusted Platform Module may contain encrypted passwords or certificates generated from user or administrator input.

Questions and answers

Use this section to answer your questions about nonvolatile memory.

1. How can the BIOS settings be restored (returned to factory settings)?



IMPORTANT: The restore defaults feature does not securely erase any information on your hard drive. See question and answer 6 for steps to securely erase information.

The restore defaults feature does not reset the Custom Secure Boot keys. See question and answer 7 for information about resetting the keys.

- a. Turn on or restart the computer, and then quickly press **esc**.
- b. Select **Main**, and then select **Apply Factory Defaults and Exit**.
- c. Follow the on-screen instructions.
- d. Select **Main**, select **Save Changes and Exit**, and then follow the on-screen instructions.

2. What is a UEFI BIOS, and how is it different from a legacy BIOS?

The Unified Extensible Firmware Interface (UEFI) BIOS is an industry-standard software interface between the platform firmware and an operating system (OS). It replaces the older BIOS architecture but supports much of the legacy BIOS functionality.

Like the legacy BIOS, the UEFI BIOS provides an interface to display the system information and configuration settings and to change the configuration of your computer before an OS is loaded. BIOS provides a secure runtime environment that supports a Graphic User Interface (GUI). In this environment, you can use either a pointing device (touch screen, touchpad, pointing stick, or USB mouse) or the keyboard to navigate and make menu and configuration selections. The UEFI BIOS also contains basic system diagnostics.

The UEFI BIOS provides functionality beyond that of the legacy BIOS. In addition, the UEFI BIOS works to initialize the computer's hardware before loading and executing the OS; the runtime environment allows the loading and execution of software programs from storage devices to provide more functionality, such as advanced hardware diagnostics (with the ability to display more detailed system information) and advanced firmware management and recovery software.

HP has provided options in Computer Setup (BIOS) to allow you to run in legacy BIOS, if required by the operating system. Examples of this requirement would be if you upgrade or downgrade the OS.

3. Where is the UEFI BIOS located?

The UEFI BIOS is located on a flash memory chip. You must use a utility to write to the chip.

4. What kind of configuration data is stored on the DIMM Serial Presence Detect (SPD) memory module? How would this data be written?

The DIMM SPD memory contains information about the memory module, such as size, serial number, data width, speed and timing, voltage, and thermal information. This information is written by the module manufacturer and stored on an EEPROM. You cannot write to this EEPROM when the memory module is installed in a computer. Third-party tools do exist that can write to the EEPROM when the memory module is not installed in a computer. Various third-party tools are available to read SPD memory.

5. What is meant by "Restore the nonvolatile memory found in Intel-based system boards"?

This message relates to clearing the Real Time Clock (RTC) CMOS memory that contains computer configuration data.

6. How can the BIOS security be reset to factory defaults and erase the data?



IMPORTANT: Resetting results in the loss of information.

These steps do not reset Custom Secure Boot Keys. See question and answer 7 for information about resetting the keys.

- a. Turn on or restart the computer, and then quickly press **esc**.
- b. Select **Main**, and then select **Reset Security to Factory Defaults**.
- c. Follow the on-screen instructions.
- d. Select **Main**, select **Save Changes and Exit**, and then follow the on-screen instructions.

7. How can the Custom Secure Boot Keys be reset?

Secure Boot is a feature to ensure that only authenticated code can start on a platform. If you enabled Secure Boot and created Custom Secure Boot Keys, disabling Secure Boot does not clear the keys. You must also select to clear the Custom Secure Boot Keys. Use the same Secure Boot access procedure that you used to create the Custom Secure Boot Keys, but select to clear or delete all Secure Boot Keys.

- a. Turn on or restart the computer, and then quickly press **esc**.
- b. Select the **Security** menu, select **Secure Boot Configuration**, and then follow the on-screen instructions.
- c. At the **Secure Boot Configuration** window, select **Secure Boot**, select **Clear Secure Boot Keys**, and then follow the on-screen instructions to continue.

Using HP Sure Start (select products only)

Select computer models are configured with HP Sure Start, a technology that continuously monitors your computer's BIOS for attacks or corruption.

If the BIOS becomes corrupted or is attacked, HP Sure Start restores the BIOS to its previously safe state, without user intervention. Those select computer models ship with HP Sure Start configured and enabled. HP Sure Start is configured and already enabled so that most users can use the HP Sure Start default configuration. Advanced users can customize the default configuration.

To access the latest documentation on HP Sure Start, go to <http://www.hp.com/support>.

11 Power cord set requirements

This chapter provides power cord requirements for countries and regions.

The wide-range input feature of the computer permits it to operate from any line voltage from 100 V AC to 120 V AC, or from 220 V AC to 240 V AC.

The three-conductor power cord set included with the computer meets the requirements for use in the country or region where the equipment is purchased.

Power cord sets for use in other countries or regions must meet the requirements of the country and region where the computer is used.

Requirements for all countries

These power cord requirements are applicable to all countries and regions.

- The length of the power cord set must be at least **1.0 m** (3.3 ft) and no more than **2.0 m** (6.5 ft).
- All power cord sets must be approved by an acceptable accredited agency responsible for evaluation in the country or region where the power cord set will be used.
- The power cord sets must have a minimum current capacity of 10 A and a nominal voltage rating of 125 V AC or 250 V AC, as required by the power system of each country or region.
- The appliance coupler must meet the mechanical configuration of an EN 60 320/IEC 320 Standard Sheet C13 connector for mating with the appliance inlet on the back of the computer.

Requirements for specific countries and regions

To determine power cord requirements for specific countries and regions, use this table.

Table 11-1 Power cord requirements for specific countries and regions

Country/region	Accredited agency	Applicable note number
Argentina	IRAM	1
Australia	SAA	1
Austria	OVE	1
Belgium	CEBEC	1
Brazil	ABNT	1
Canada	CSA	2
Chile	IMQ	1
Denmark	DEMKO	1
Finland	FIMKO	1
France	UTE	1

Table 11-1 Power cord requirements for specific countries and regions (continued)

Country/region	Accredited agency	Applicable note number
Germany	VDE	1
India	BIS	1
Israel	SII	1
Italy	IMQ	1
Japan	JIS	3
Netherlands	KEMA	1
New Zealand	SANZ	1
Norway	NEMKO	1
People's Republic of China	CCC	4
Saudi Arabia	SASO	7
Singapore	PSB	1
South Africa	SABS	1
South Korea	KTL	5
Sweden	SEMKO	1
Switzerland	SEV	1
Taiwan	BSMI	6
Thailand	TISI	1
United Kingdom	ASTA	1
United States	UL	2

1. The flexible cord must be Type HO5VV-F, three-conductor, 0.75 mm² conductor size. Power cord set fittings (appliance coupler and wall plug) must bear the certification mark of the agency responsible for evaluation in the country or region where it will be used.
2. The flexible cord must be Type SVT/SJT or equivalent, No. 18 AWG, three-conductor. The wall plug must be a two-pole grounding type with a NEMA 5-15P (15 A, 125 V AC) or NEMA 6-15P (15 A, 250 V AC) configuration. CSA or C-UL mark. UL file number must be on each element.
3. The appliance coupler, flexible cord, and wall plug must bear a T mark and registration number in accordance with the Japanese Dentori Law. The flexible cord must be Type VCTF, three-conductor, 0.75 mm² or 1.25 mm² conductor size. The wall plug must be a two-pole grounding type with a Japanese Industrial Standard C8303 (7 A, 125 V AC) configuration.
4. The flexible cord must be Type RVV, three-conductor, 0.75 mm² conductor size. Power cord set fittings (appliance coupler and wall plug) must bear the CCC certification mark.
5. The flexible cord must be Type HO5VV-F three-conductor, 0.75 mm² conductor size. KTL logo and individual approval number must be on each element. Approval number and logo must be printed on a flag label.
6. The flexible cord must be Type HVCTF three-conductor, 1.25 mm² conductor size. Power cord set fittings (appliance coupler, cable, and wall plug) must bear the BSMI certification mark.
7. For 127 V AC, the flexible cord must be Type SVT or SJT 3-conductor, 18 AWG, with plug NEMA 5-15P (15 A, 125 V AC), with UL and CSA or C-UL marks. For 240 V AC, the flexible cord must be Type HO5VV-F three-conductor, 0.75 mm² or 1.00 mm² conductor size, with plug BS 1363/A with BSI or ASTA marks.

12 Recycling

When a nonrechargeable or rechargeable battery has reached the end of its useful life, do not dispose of the battery in general household waste. Follow the local laws and regulations in your area for battery disposal.

HP encourages customers to recycle used electronic hardware, HP original print cartridges, and rechargeable batteries. For more information about recycling programs, see the HP website at <http://www.hp.com/recycle>.

Index

- A**
 - AC adapter and battery light, identifying 5
 - AC adapter, spare part number 20
 - action key, identifying 13
 - antenna
 - illustrated 20
 - spare part number 20
 - audio-out (headphone)/audio-in (microphone) combo jack, identifying 6
 - audio, product description 2
- B**
 - backup, creating 60
 - backups 60
 - battery
 - illustrated 18
 - spare part number 18
 - BIOS
 - determining version 57
 - downloading an update 58
 - starting the Setup Utility 57
 - updating 57
 - Bluetooth label 14
 - boot order, changing 62
 - bottom components 13
 - bottom cover
 - illustrated 18
 - removal 32
 - spare part number 32
 - spare part numbers 18
 - buttons
 - left touchpad 8,9
 - power 12
 - right touchpad 8,9
- C**
 - camera
 - identifying 8
 - camera light, identifying 8
 - camera privacy cover, identifying 8
 - camera/microphone module
 - illustrated 19
 - spare part number 19
 - caps lock light 10
 - caring for your computer 27
 - cautions
 - electrostatic discharge 23,24
 - cleaning your computer 27
 - caring for wood veneer 29
 - disinfecting 28
 - HP Easy Clean 27
 - removing dirt and debris 27
 - components
 - bottom 13
 - display 6,7
 - keyboard area 8
 - left side 5
 - lights 9
 - right side 5
 - touchpad 8,9
 - computer major components 16
 - computer specifications 69
 - connectors
 - power 5
 - control zone 8
- D**
 - display
 - specifications 69
 - display assembly
 - subcomponents 18
 - display back cover
 - illustrated 20
 - spare part numbers 20
 - display bezel
 - illustrated 19
 - spare part numbers 19
 - display components 6,7
 - display panel
 - illustrated 19
 - product description 1
 - spare part numbers 19
 - display panel cable
 - illustrated 20
 - spare part number 20
- E**
 - electrostatic discharge (ESD) 23, 24
 - preventing damage 23-25
- esc key, identifying 13
- F**
 - fan
 - illustrated 18
 - removal 41
 - spare part number 41
 - spare part numbers 18
 - fingerprint reader 12
 - illustrated 18
 - removal 42
 - spare part number 18
 - spare part numbers 42
 - fn key, identifying 13
- G**
 - graphics controller, product description 1
 - grounding methods 23-25
 - guidelines
 - packaging 23,29
 - transporting 23,29
 - workstation 23
- H**
 - hard drive
 - product description 2
 - specifications 69
 - HDMI port
 - identifying 6
 - heat sink
 - illustrated 18
 - removal 40
 - spare part number 40
 - spare part numbers 18
 - hinge
 - illustrated 20
 - spare part numbers 20
 - HP PC Hardware Diagnostics UEFI
 - downloading 66
 - failure ID code 65
 - starting 65
 - using 65
 - HP PC Hardware Diagnostics Windows
 - accessing 63,64
 - downloading 64

- failure ID code 63
- installing 65
- using 63
- HP Recovery media recovery 61
- HP Sure Recover 62
- HP Sure Start 72, 76

I

- illustrated parts catalog 16
- integrated numeric keypad, identifying 13
- internal microphones, identifying 7

J

- jacks
 - audio-out (headphone)/audio-in (microphone) 6

K

- keyboard
 - product description 3
- keys
 - action 13
 - esc 13
 - fn 13
 - num lock 13
 - Windows 13

L

- labels
 - Bluetooth 14
 - regulatory 14
 - serial number 14
 - service 14
 - wireless certification 14
 - WLAN 14
- left control zone, identifying 8
- left side components 5
- lights
 - AC adapter and battery 5
 - camera 8
 - caps lock 10
 - microphone mute 10
 - mute 10
 - power 10
 - touchpad 8
- low blue light mode 7

M

- memory
 - nonvolatile 72
 - volatile 72
- memory module
 - illustrated 18
 - product description 2
 - spare part number 18
- memory modules
 - removal 36
 - spare part numbers 36
- microphone
 - product description 2
- microphone mute light, identifying 10
- model name 1
- mute light, identifying 10

N

- nonvolatile memory 72
- num lock key, identifying 13

O

- operating system, product description 4

P

- packaging guidelines 23, 29
- pointing device, product description 3
- ports
 - HDMI 6
 - product description 3
 - USB SuperSpeed 5, 6
 - USB Type-C SuperSpeed 6
- power button, identifying 12
- power connector
 - identifying 5
- power connector cable
 - removal 44
 - spare part number 44
- power cord
 - requirements for all countries 77
 - requirements for specific countries and regions 77
 - set requirements 77
 - spare part numbers 21
- power light, identifying 10
- power requirements, product description 3
- primary storage
 - product description 2

- processor
 - product description 1
- processor, product description 1
- product description
 - audio 2
 - display panel 1
 - graphics controller 1
 - hard drive 2
 - keyboard 3
 - memory module 2
 - microphone 2
 - operating system 4
 - pointing device 3
 - ports 3
 - power requirements 3
 - primary storage 2
 - product name 1
 - security 3
 - serviceability 4
 - solid-state drive 2
 - video 2
 - wireless 3
- product name 1
- product name and number, computer 14

R

- recovery 60
 - discs 61
 - media 61
 - USB flash drive 61
- recovery media 60
 - creating using HP Cloud Recovery Download Tool 60
 - creating using Windows tools 60
- regulatory information
 - regulatory label 14
 - wireless certification labels 14
- Remote HP PC Hardware Diagnostics UEFI settings
 - customizing 67
 - using 67
- removal and replacement procedures 32
- solid-state drive 35
- removing personal data from volatile system memory 72
- restoring 60
- restoring and recovery methods 61
- right control zone, identifying 8
- right side components 5

S

- security, product description 3
- serial number, computer 14
- service labels, locating 14
- serviceability, product description 4
- solid-state drive
 - illustrated 17
 - product description 2
 - removal and replacement 35
 - spare part numbers 17
 - specifications 70
- speaker
 - illustrated 18
 - removal 39
 - spare part number 18, 39
- speakers 13
- special keys
 - identifying 12
 - using 12
- specifications
 - computer 69
 - display 69
 - hard drive 69
 - solid-state drive 70
- static electricity 23, 24
- support information 30
- system board
 - illustrated 17
 - removal 45
 - spare part numbers 17, 45
- system memory, removing
 - personal data from volatile 72
- system restore 61
- system restore point, creating 60

T

- top cover
 - spare part numbers 55
- touchpad
 - illustrated 17
 - removal 47
 - settings 8
 - spare part numbers 17, 47
- touchpad buttons
 - identifying 8, 9
- touchpad components 8
- touchpad light, identifying 8
- touchpad settings, adjusting 8
- touchpad zone, identifying 8, 9
- transporting guidelines 23, 29
- traveling with the computer 14

U

- USB board
 - illustrated 17
 - removal 43
 - spare part number 43
 - spare part numbers 17
- USB SuperSpeed port, identifying 5, 6
- USB Type-C SuperSpeed port, identifying 6

V

- vents, identifying 14
- video, product description 2

W

- wake-on-voice 7
- Windows
 - backup 60
 - recovery media 60
 - system restore point 60
- Windows key, identifying 13
- Windows tools, using 60
- wireless antennas, identifying 7
- wireless certification label 14
- wireless, product description 3
- WLAN antenna kit
 - illustrated 20
 - spare part number 20
- WLAN antennas, identifying 7
- WLAN device 14
- WLAN label 14
- WLAN module
 - removal 37
 - spare part numbers 37
- workstation guidelines 23