





1 Overview – Solutions for high-speed data transfer, extended network reach, and robust reliability

Designed for enhanced connectivity, Brainboxes Industrial 16 Port Ethernet Switches are a cost-effective solution to streamline installations, simplify maintenance and wiring complexity, and improve efficiency whilst reducing potential points of failure.

Available with **Fast** and **Gigabit Ethernet**, and with **SFP**, all Hero Ethernet switches come in an **industrial hardened metal enclosure** for reliable operation in demanding environments.

1.1 Functionality and Features

		WITH SFP	
10/100 ETHERNET	 SW-7016	 SW-7617	<ul style="list-style-type: none"> ✓ Enhanced connectivity and flexibility: Higher port count enables flexible network layout and device placement ✓ Integrated, adjustable DIN-rail mount with grounding ✓ Wide voltage input range (+5V to +30VDC) and dual redundant power inputs - ensures reliability and reduces the risk of power outages ✓ Industrial hardened enclosure and wide operating temperature range (-40°C to +80°C / -40°F to +176°F) - reliable operation in harsh environments
10/100 ETHERNET & GIGABIT TRUNK	 SW-7416	 SW-7717	

1.2 Product Variants

Model	Fast Ethernet	Gigabit	SFP	Enclosure
	10/100 BASE-T (RJ45)	10/100/1000 BASE-T (RJ45) Trunk	1000 BASE-X	
SW-7016	16	-	-	Hardened
SW-7416	14	2	-	Hardened
SW-7617	16	-	1	Hardened
SW-7717	14	2	1	Hardened

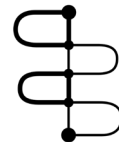

1.3 General Information

Model	Power Consumption	Operating Temp	Product Weight	Product Size	GTIN (barcode)	Package Weight	Package Size
SW-7016	3.8 Watts Max: @+5V to +30VDC	-40°C to +80°C -40°F to 176°F	0.53kg 18.68oz	158 x 102 x 43mm 6.22 x 4.02 x 1.69in	837324005196	0.67kg 23.63oz	200 x 140 x 80mm 7.87 x 5.51 x 3.15in
SW-7416	6 Watts Max: @+5V to +30VDC	-40°C to +80°C -40°F to 176°F	0.64kg 22.64oz	180 x 108 x 43mm 7.09 x 4.25 x 1.69in	837324005202	0.75kg 26.46oz	200 x 140 x 80mm 7.87 x 5.51 x 3.15in
SW-7617	7.5 Watts Max: @+5V to +30VDC	-40°C to +80°C -40°F to 176°F	0.64kg 22.64oz	180 x 108 x 43mm 7.09 x 4.25 x 1.69in	837324005219	0.75kg 26.46oz	200 x 140 x 80mm 7.87 x 5.51 x 3.15in
SW-7717	7.5 Watts Max: @+5V to +30VDC	-40°C to +80°C -40°F to 176°F	0.64kg 22.64oz	180 x 108 x 43mm 7.09 x 4.25 x 1.69in	837324005226	0.75kg 26.46oz	200 x 140 x 80mm 7.87 x 5.51 x 3.15in

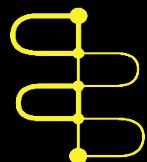

**UK
CA**

**CAGE
8QCY6**

**NCAGE
U0Q96**

AEO
UK Authorised Economic Operator

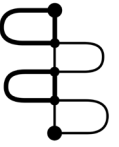

**MADE IN
BRITAIN**

Contents

1	Overview – Solutions for high-speed data transfer, extended network reach, and robust reliability	1
1.1	Functionality and Features.....	1
1.2	Product Variants.....	1
1.3	General Information.....	2
2	Pinouts	4
2.1	Ethernet Ports	4
2.2	Power Terminal	4
3	Enclosures (3D Models Available).....	5
3.1	Hardened (DIN rail mountable metal enclosure).....	5
3.1.1	SW-7016	5
3.1.2	SW-7416	5
3.1.3	SW-7617 & SW-7717	6
4	DIN-Rail Mounting	6
5	Data.....	7
5.1	Power Supply	7
5.2	Environment.....	7
5.3	LED Information	7
5.4	Ethernet	8
6	Approvals & Support.....	8
6.1	Industry Approvals	8
6.2	Company Approvals	8
6.3	Support.....	8
7	Ordering Information.....	9
8	Accessories.....	9
9	Revision History	9

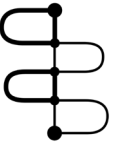

2 Pinouts

2.1 Ethernet Ports

PIN	ETHERNET	
	10/100 Fast Ethernet	10/100/1000 Gigabit Ethernet
1	Tx+ / Rx+	TxRx A+
2	Tx- / Rx-	TxRx A-
3	Rx+ / Tx+	TxRx B+
4		TxRx C+
5		TxRx C-
6	Rx- / Tx-	TxRx B-
7		TxRx D+
8		TxRx D-

2.2 Power Terminal

Pin	Function
1	-V
2	+VA
3	+VB
4	-V
5	FUNC EARTH

Screw Terminals	Wire Thickness	
5 Pin 3.5mm Pitch	Wire Cross Section	0.14mm – 1.5mm
	AWG Value	#28 – #16
	Stripping Length	7mm / 0.27in
	Tightening Torque	0.22Nm – 0.25Nm

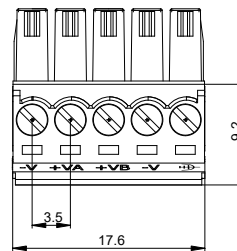
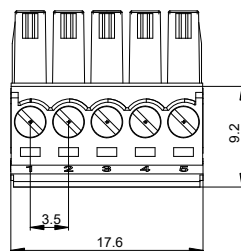
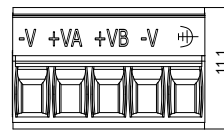
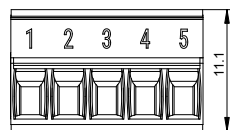

All Dimensions in mm

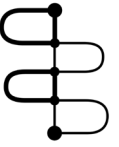

3 Enclosures (3D Models Available)

3.1 Hardened (DIN rail mountable metal enclosure)

3.1.1 SW-7016

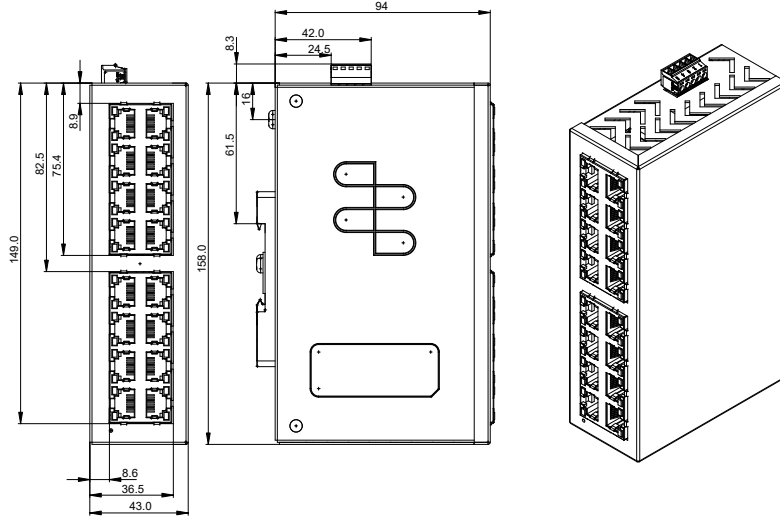

All Dimensions in mm
Tolerance $\pm 0.5\text{mm}$ Unless otherwise stated

3.1.2 SW-7416

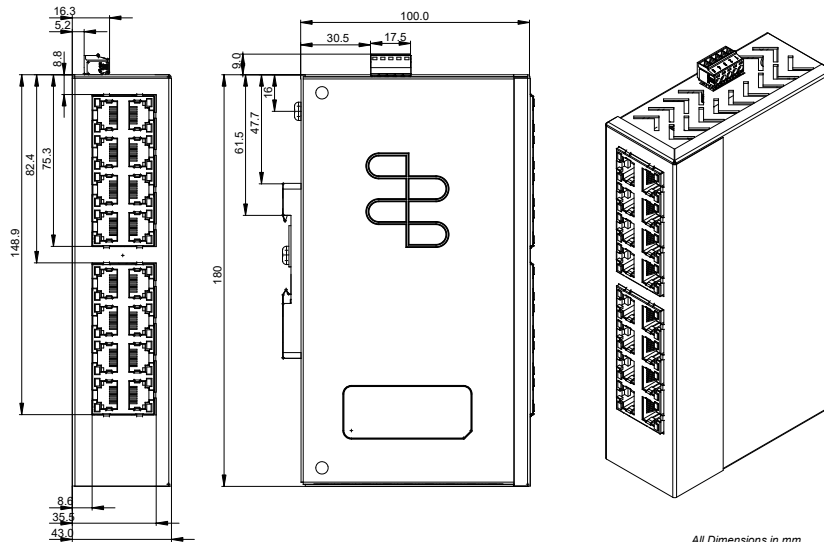

All Dimensions in mm
Tolerance $\pm 0.5\text{mm}$ Unless otherwise stated

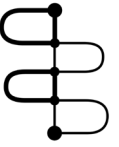

3.1.3 SW-7617 & SW-7717

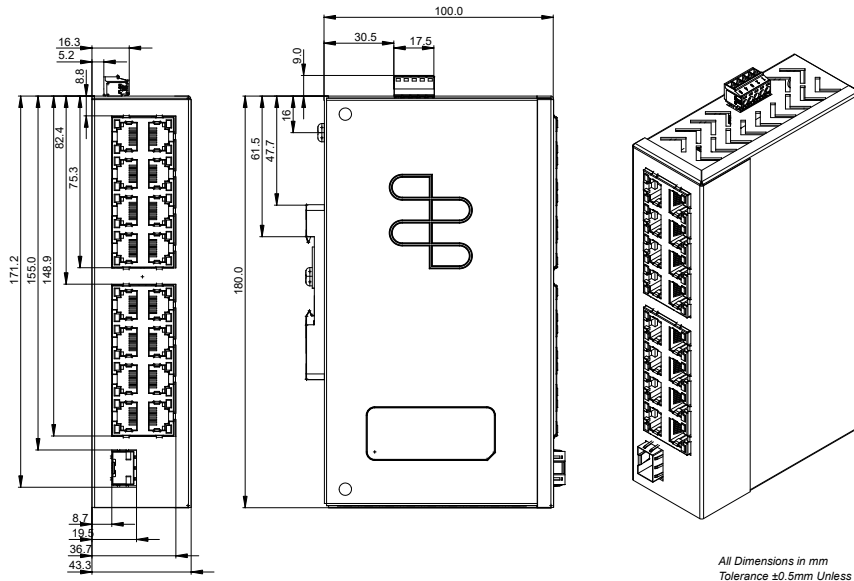

All Dimensions in mm
Tolerance $\pm 0.5\text{mm}$ Unless otherwise stated

4 DIN-Rail Mounting

All 16 Port switch products come with a MK-103 DIN Rail clip, which depending on your requirements, can be repositioned into 2 different mounting locations and rotated 180°:

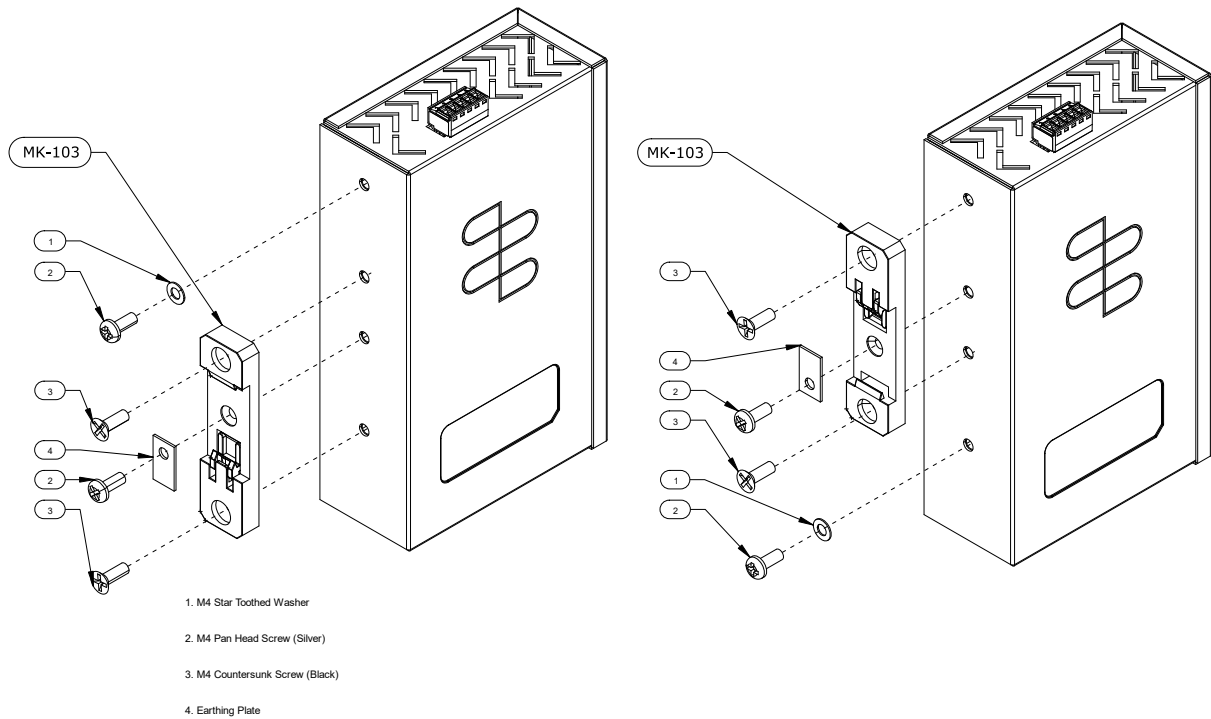

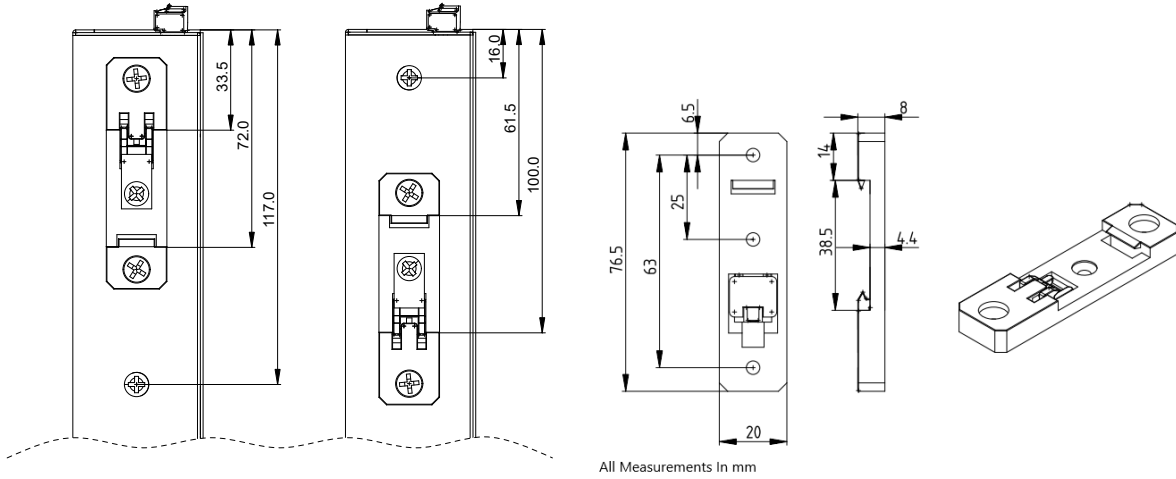
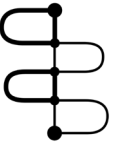

5 Data

SFP Overcurrent Protection	1.15W (360mA) Maximum
-----------------------------------	-----------------------

5.1 Power Supply

Power Consumption	See Table: 1.3 General Information
Power Supply Input	Unregulated +5V to +30 Volts DC Dual Redundant Power Inputs, Reverse Polarity Protection

5.2 Environment

Operating Temperature	-40°C to +80°C / -40°F to +176°F
Storage Temperature	-40°C to +80°C / -40°F to +176°F
Ambient Relative Humidity	5 to 95% (non-condensing)

5.3 LED Information

RJ45 LED	Green	Link/Activity
	Yellow	Port Operating at Max Speed
SFP LED	Green	Power On
	Amber	SFP Plugged In
	Amber Flashing	SFP Link / Activity
	Green/Amber Flashing	SFP Error/Incompatible

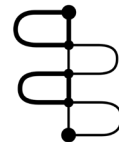

5.4 Ethernet

Ethernet Port	Up to 16x 10/100BASE-T(X) RJ45 ports (Auto MDI-X) Up to 2x 10/100/1000BASE-T RJ45 ports Up to 1x 1000BASE-X SFP port All Ports Work Concurrently
Protection	1500VRMS Magnetic Isolation Between RJ45 (Copper Twisted Pair Only)

6 Approvals & Support

6.1 Industry Approvals

General	WEEE, RoHS, CE, UKCA
UL	METL Complies with UL62368-1
HTS	8517620000
ECCN	5A991.b

6.2 Company Approvals

General	ISO9001, ISO14001, Microsoft Certified Gold Partner, AEO (C-TPAT)
CAGE	8QCY6
NCAGE	U0Q96
GSA Contract Number	47QTCA23D009X

6.3 Support

Warranty	Lifetime - online registration required
Support	Lifetime web, email and phone support from fully qualified, friendly staff who work in and alongside the Product Development Team
OEM option	Available for bulk buy OEM
COO (Country of Origin)	Made in GB, United Kingdom of Great Britain & Northern Ireland
Customisable	Perfect Fit Custom Design policy for volume users

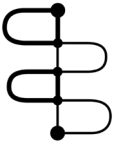

7 Ordering Information

Part Number	Description
SW-7016	Hardened Industrial 16x 10/100 Ethernet Switch
SW-7416	Hardened Industrial 14x 10/100 & 2x 1G Ethernet Switch
SW-7617	Hardened Industrial 16x 10/100 & 1x SFP Ethernet Switch
SW-7717	Hardened Industrial 14x 10/100, 2x 1G & 1x SFP Ethernet Switch

8 Accessories

- [PW-301](#) – 96W Single Output Industrial DIN Power Supply
- [PW-245](#) – 60W Single Output Industrial DIN Power Supply
- [PW-400](#) – Power Adapter 12V 1.5A Terminal Tails UK/EU/US/AUS Pack

9 Revision History

	Approved By
Current Version: 1.0 – 04/07/24	JM
Previous Version:	

Version	Changes	Approved By
1.0	Public Release	JM