

VB-WMK-003**Wall Mount****Quick Start Guide****1****2**

c - 4pcs

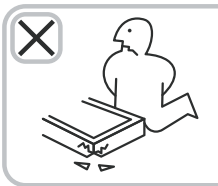

d - 2pcs

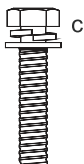
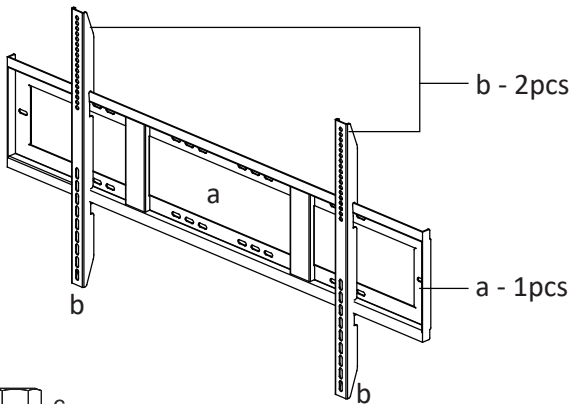

e - 8pcs

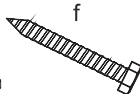

f - 8pcs

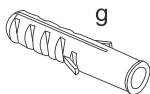

g - 8pcs

3 Installation

A

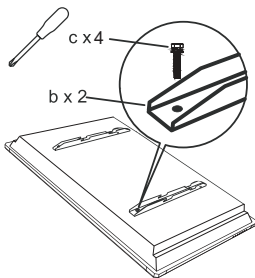

B

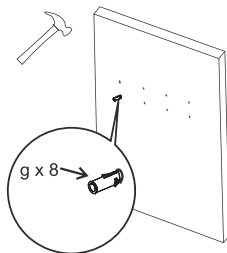

C

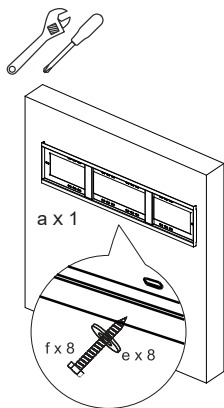

D

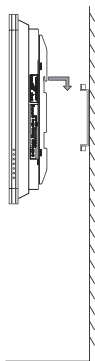

E

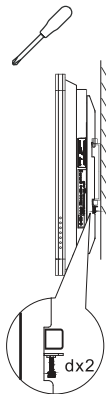

Scan for more information

VB-WMK-003



Scan for more information

Support Center



Scan for more information

www.viewsonic.com