

Rocbolt Universal Switchable Built-in 3-IN-1 Keyed Security Laptop Lock - (2) Keys Included - 6.6 ft 5mm Cable

Y1RB034-B1

**Congratulations!**

Rocstor Rocbolt Universal Switchable Built-in 3-IN-1 Keyed Security Laptop Lock - For Standard K-Slot, Nano, and Noble Wedge Slots - 5mm Carbon Steel Cable - Easy Push-to-lock Feature - 360-Degree Swivel Head Rotation - (2) Keys Included - With 6.6 ft Heavy-duty Cable - TAA Compliant

**Locking Tip Adjustment**

Use a small flathead screwdriver or similar tool to switch the knob.

Adjust the locking tip according to the lock slot specification of your device.

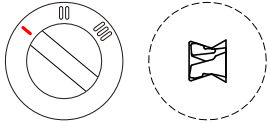
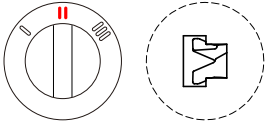
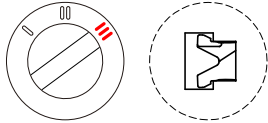
Noble Slot	Nano Slot	Standard Slot
		
<p>⚠ The Knob can only be switched when the lock is unlock.</p>		

**Lock**

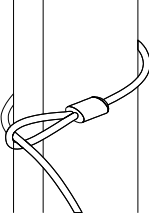
- 

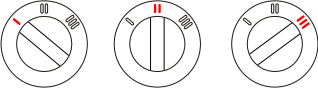
Wrap your cable around an immovable object, by crossing the lock body, through the loop, on the opposite end of the cable.
- 

Noble      Nano      Standard

You must adjust the locking tip **before** inserting the lock into your device.

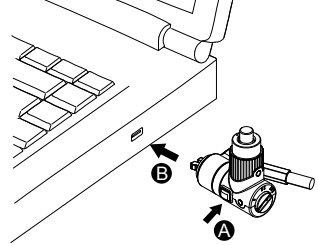
Adjust the locking tip according to the lock slot specification of your device.
- 

Press the release button and insert the locking tip into the slot.

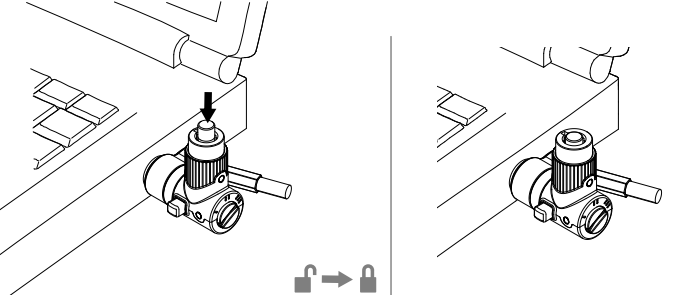
- 

Push the button to lock the device.

**Rocbolt Security Lock Register & Access**  
 Enregistrement et accès au verrou de sécurité Rocbolt  
 Registro y acceso a la cerradura de seguridad Rocbolt

!

0 1 2 3 4 5

locks.rocstor.com

# [ ] [ ] [ ] [ ] [ ] [ ]

## Unlock



## Removable Rubber Grommet

For computers that have a tighter security lock fit it is necessary to remove the grommet on the cable lock.

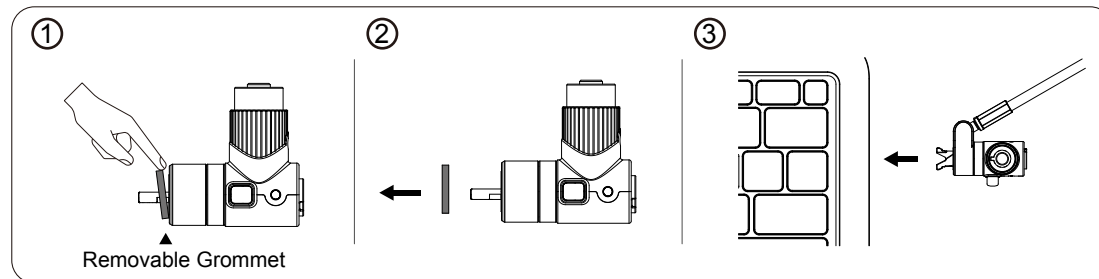

### Technical Support

Technical support is available to all registered users of Rocstor products. Technical Support contact information can be found on [www.rocstor.com](http://www.rocstor.com)

### Telephone Support

There is no charge for technical support except long-distance charges where applicable. Please visit [www.rocstor.com](http://www.rocstor.com) Monday to Friday 9:00 am to 6:00 pm Pacific Standard Time.

### Technical Support

+1 (818) 727-7000 - Office

+1 (818) 875-0002 - Fax

[support@rocstor.com](mailto:support@rocstor.com)

### limited Two Year Warranty

Rocstor warrants this product against defects in material and workmanship for five years. Rocstor will supply, at its option, comparable new and rebuilt replacements for defective parts and will pay the labor charges to repair the product found to be defective. The dated bill of sale as evidence of the original purchase price along with the defective product is required.

©2024 Rocstor, Inc. Rocstor is registered trademark of Rocstor, Inc. Kensington and Nanosaver is a registered trademark of Acco Brands Corporation. Wedge Lock is a trademark of Noble Security, Inc. All other trademarks, service marks, and trade names referenced in this document are the property of their respective owners. We reserve the rights to make changes without further notice to a product or system described herein to improve reliability, function or design.

