

# Inspiron 16 5625

## Service Manual



## Notes, cautions, and warnings

 **NOTE:** A NOTE indicates important information that helps you make better use of your product.

 **CAUTION:** A CAUTION indicates either potential damage to hardware or loss of data and tells you how to avoid the problem.

 **WARNING:** A WARNING indicates a potential for property damage, personal injury, or death.



<b>Chapter 1: Working inside your computer</b> .....	<b>6</b>
Safety instructions.....	6
Before working inside your computer.....	6
Safety precautions.....	7
Electrostatic discharge—ESD protection.....	7
ESD field service kit .....	8
Transporting sensitive components.....	9
After working inside your computer.....	9
<b>Chapter 2: Removing and installing components</b> .....	<b>10</b>
Recommended tools.....	10
Screw list.....	10
Major components of Inspiron 16 5625.....	11
Base cover.....	13
Removing the base cover.....	13
Installing the base cover.....	15
Battery.....	17
Lithium-ion battery precautions.....	17
Removing the 3-cell battery.....	18
Installing the 3-cell battery.....	18
Removing the 4-cell battery.....	19
Installing the 4-cell battery.....	20
Memory modules.....	21
Removing the memory module.....	21
Installing the memory module.....	22
Solid-state drive.....	24
Removing the M.2 2230 solid-state drive.....	24
Installing the M.2 2230 solid-state drive.....	25
Removing the M.2 2280 solid-state drive.....	26
Installing the M.2 2280 solid-state drive.....	27
Wireless card.....	28
Removing the wireless card.....	28
Installing the wireless card.....	29
Fan.....	31
Removing the fan.....	31
Installing the fan.....	31
Coin-cell battery.....	32
Removing the coin-cell battery.....	32
Installing the coin-cell battery.....	33
Heat sink.....	34
Removing the heatsink.....	34
Installing the heatsink.....	36
Display assembly.....	37
Removing the display assembly.....	37

Installing the display assembly.....	39
I/O board.....	40
Removing the I/O board.....	40
Installing the I/O board.....	41
Touchpad.....	42
Removing the touchpad.....	42
Installing the touchpad.....	42
Speakers.....	43
Removing the speakers.....	43
Installing the speakers.....	44
System board.....	46
Removing the system board.....	46
Installing the system board.....	48
Power-button board.....	50
Removing the power-button board.....	50
Installing the power-button board.....	51
Power button with optional fingerprint reader.....	52
Removing the power button with optional fingerprint reader.....	52
Installing the power button with optional fingerprint reader.....	52
Power-adapter port.....	53
Removing the power-adapter port.....	53
Installing the power-adapter port.....	54
Palm-rest and keyboard assembly.....	55
Removing the palm-rest and keyboard assembly.....	55
Installing the palm-rest and keyboard assembly.....	56
<b>Chapter 3: Drivers and downloads.....</b>	<b>58</b>
<b>Chapter 4: BIOS setup.....</b>	<b>59</b>
BIOS overview.....	59
Entering BIOS setup program.....	59
Navigation keys.....	59
One time boot menu.....	60
System setup options.....	60
System and setup password.....	65
Assigning a system setup password.....	65
Deleting or changing an existing system setup password.....	66
Clearing CMOS settings.....	66
Clearing BIOS (System Setup) and System passwords.....	66
Updating the BIOS.....	67
Updating the BIOS in Windows.....	67
Updating the BIOS using the USB drive in Windows.....	67
Updating the BIOS from the F12 One-Time boot menu.....	68
<b>Chapter 5: Troubleshooting.....</b>	<b>69</b>
Handling swollen Lithium-ion batteries.....	69
<b>Locate the Service Tag or Express Service Code of your Dell computer</b> .....	69
System-diagnostic lights.....	70
SupportAssist   On-board Diagnostics.....	71











Recovering the operating system.....	71
Backup media and recovery options.....	72
WiFi power cycle.....	72
Drain residual flea power (perform hard reset).....	72

**Chapter 6: Getting help and contacting Dell..... 73**

# Working inside your computer

## Safety instructions

Use the following safety guidelines to protect your computer from potential damage and to ensure your personal safety. Unless otherwise noted, each procedure included in this document assumes that you have read the safety information that shipped with your computer.

-  **WARNING:** Before working inside your computer, read the safety information that is shipped with your computer. For more safety best practices, see the Regulatory Compliance home page at [www.dell.com/regulatory\\_compliance](http://www.dell.com/regulatory_compliance).
-  **WARNING:** Disconnect your computer from all power sources before opening the computer cover or panels. After you finish working inside the computer, replace all covers, panels, and screws before connecting your computer to an electrical outlet.
-  **CAUTION:** To avoid damaging the computer, ensure that the work surface is flat, dry, and clean.
-  **CAUTION:** To avoid damaging the components and cards, handle them by their edges, and avoid touching the pins and the contacts.
-  **CAUTION:** You should only perform troubleshooting and repairs as authorized or directed by the Dell technical assistance team. Damage due to servicing that is not authorized by Dell is not covered by your warranty. See the safety instructions that is shipped with the product or at [www.dell.com/regulatory\\_compliance](http://www.dell.com/regulatory_compliance).
-  **CAUTION:** Before touching anything inside your computer, ground yourself by touching an unpainted metal surface, such as the metal at the back of the computer. While you work, periodically touch an unpainted metal surface to dissipate static electricity which could harm internal components.
-  **CAUTION:** When you disconnect a cable, pull it by its connector or its pull tab, not the cable itself. Some cables have connectors with locking tabs or thumbscrews that you must disengage before disconnecting the cable. When disconnecting cables, keep them evenly aligned to avoid bending the connector pins. When connecting cables, ensure that the ports and the connectors are correctly oriented and aligned.
-  **CAUTION:** Press and eject any installed card from the media-card reader.
-  **CAUTION:** Exercise caution when handling Lithium-ion batteries in laptops. Swollen batteries should not be used and should be replaced and disposed properly.
-  **NOTE:** The color of your computer and certain components may appear differently than shown in this document.

## Before working inside your computer

### About this task

-  **NOTE:** The images in this document may differ from your computer depending on the configuration you ordered.

### Steps

1. Save and close all open files and exit all open applications.
2. Shut down your computer. Click **Start** >  **Power** > **Shut down**.

 **NOTE:** If you are using a different operating system, see the documentation of your operating system for shut-down instructions.

3. Disconnect your computer and all attached devices from their electrical outlets.
4. Disconnect all attached network devices and peripherals, such as keyboard, mouse, and monitor from your computer.

 **CAUTION:** To disconnect a network cable, first unplug the cable from your computer and then unplug the cable from the network device.

5. Remove any media card and optical disc from your computer, if applicable.

## Safety precautions

The safety precautions chapter details the primary steps to be taken before performing any disassembly instructions.

Observe the following safety precautions before you perform any installation or break/fix procedures involving disassembly or reassembly:

- Turn off the system and all attached peripherals.
- Disconnect the system and all attached peripherals from AC power.
- Disconnect all network cables, telephone, and telecommunications lines from the system.
- Use an ESD field service kit when working inside any to avoid electrostatic discharge (ESD) damage.
- After removing any system component, carefully place the removed component on an anti-static mat.
- Wear shoes with non-conductive rubber soles to reduce the chance of getting electrocuted.

## Standby power

Dell products with standby power must be unplugged before you open the case. Systems that incorporate standby power are essentially powered while turned off. The internal power enables the system to be remotely turned on (wake on LAN) and suspended into a sleep mode and has other advanced power management features.

Unplugging, pressing and holding the power button for 15 seconds should discharge residual power in the system board.

## Bonding

Bonding is a method for connecting two or more grounding conductors to the same electrical potential. This is done through the use of a field service electrostatic discharge (ESD) kit. When connecting a bonding wire, ensure that it is connected to bare metal and never to a painted or non-metal surface. The wrist strap should be secure and in full contact with your skin, and ensure that you remove all jewelry such as watches, bracelets, or rings prior to bonding yourself and the equipment.

## Electrostatic discharge—ESD protection

ESD is a major concern when you handle electronic components, especially sensitive components such as expansion cards, processors, memory DIMMs, and system boards. Very slight charges can damage circuits in ways that may not be obvious, such as intermittent problems or a shortened product life span. As the industry pushes for lower power requirements and increased density, ESD protection is an increasing concern.

Due to the increased density of semiconductors used in recent Dell products, the sensitivity to static damage is now higher than in previous Dell products. For this reason, some previously approved methods of handling parts are no longer applicable.

Two recognized types of ESD damage are catastrophic and intermittent failures.

- **Catastrophic** – Catastrophic failures represent approximately 20 percent of ESD-related failures. The damage causes an immediate and complete loss of device functionality. An example of catastrophic failure is a memory DIMM that has received a static shock and immediately generates a "No POST/No Video" symptom with a beep code emitted for missing or nonfunctional memory.
- **Intermittent** – Intermittent failures represent approximately 80 percent of ESD-related failures. The high rate of intermittent failures means that most of the time when damage occurs, it is not immediately recognizable. The DIMM receives a static shock, but the tracing is merely weakened and does not immediately produce outward symptoms related to the damage. The weakened trace may take weeks or months to melt, and in the meantime may cause degradation of memory integrity, intermittent memory errors, etc.

The more difficult type of damage to recognize and troubleshoot is the intermittent (also called latent or "walking wounded") failure.

Perform the following steps to prevent ESD damage:

- Use a wired ESD wrist strap that is properly grounded. The use of wireless anti-static straps is no longer allowed; they do not provide adequate protection. Touching the chassis before handling parts does not ensure adequate ESD protection on parts with increased sensitivity to ESD damage.
- Handle all static-sensitive components in a static-safe area. If possible, use anti-static floor pads and workbench pads.
- When unpacking a static-sensitive component from its shipping carton, do not remove the component from the anti-static packing material until you are ready to install the component. Before unwrapping the anti-static packaging, ensure that you discharge static electricity from your body.
- Before transporting a static-sensitive component, place it in an anti-static container or packaging.

## ESD field service kit

The unmonitored Field Service kit is the most commonly used service kit. Each Field Service kit includes three main components: anti-static mat, wrist strap, and bonding wire.

### Components of an ESD field service kit

The components of an ESD field service kit are:

- **Anti-Static Mat** – The anti-static mat is dissipative and parts can be placed on it during service procedures. When using an anti-static mat, your wrist strap should be snug and the bonding wire should be connected to the mat and to any bare metal on the system being worked on. Once deployed properly, service parts can be removed from the ESD bag and placed directly on the mat. ESD-sensitive items are safe in your hand, on the ESD mat, in the system, or inside a bag.
- **Wrist Strap and Bonding Wire** – The wrist strap and bonding wire can be either directly connected between your wrist and bare metal on the hardware if the ESD mat is not required, or connected to the anti-static mat to protect hardware that is temporarily placed on the mat. The physical connection of the wrist strap and bonding wire between your skin, the ESD mat, and the hardware is known as bonding. Use only Field Service kits with a wrist strap, mat, and bonding wire. Never use wireless wrist straps. Always be aware that the internal wires of a wrist strap are prone to damage from normal wear and tear, and must be checked regularly with a wrist strap tester in order to avoid accidental ESD hardware damage. It is recommended to test the wrist strap and bonding wire at least once per week.
- **ESD Wrist Strap Tester** – The wires inside of an ESD strap are prone to damage over time. When using an unmonitored kit, it is a best practice to regularly test the strap prior to each service call, and at a minimum, test once per week. A wrist strap tester is the best method for doing this test. If you do not have your own wrist strap tester, check with your regional office to find out if they have one. To perform the test, plug the wrist-strap's bonding-wire into the tester while it is strapped to your wrist and push the button to test. A green LED is lit if the test is successful; a red LED is lit and an alarm sounds if the test fails.
- **Insulator Elements** – It is critical to keep ESD sensitive devices, such as plastic heat sink casings, away from internal parts that are insulators and often highly charged.
- **Working Environment** – Before deploying the ESD Field Service kit, assess the situation at the customer location. For example, deploying the kit for a server environment is different than for a desktop or portable environment. Servers are typically installed in a rack within a data center; desktops or portables are typically placed on office desks or cubicles. Always look for a large open flat work area that is free of clutter and large enough to deploy the ESD kit with additional space to accommodate the type of system that is being repaired. The workspace should also be free of insulators that can cause an ESD event. On the work area, insulators such as Styrofoam and other plastics should always be moved at least 12 inches or 30 centimeters away from sensitive parts before physically handling any hardware components.
- **ESD Packaging** – All ESD-sensitive devices must be shipped and received in static-safe packaging. Metal, static-shielded bags are preferred. However, you should always return the damaged part using the same ESD bag and packaging that the new part arrived in. The ESD bag should be folded over and taped shut and all the same foam packing material should be used in the original box that the new part arrived in. ESD-sensitive devices should be removed from packaging only at an ESD-protected work surface, and parts should never be placed on top of the ESD bag because only the inside of the bag is shielded. Always place parts in your hand, on the ESD mat, in the system, or inside an anti-static bag.
- **Transporting Sensitive Components** – When transporting ESD sensitive components such as replacement parts or parts to be returned to Dell, it is critical to place these parts in anti-static bags for safe transport.

## ESD protection summary

It is recommended that all field service technicians use the traditional wired ESD grounding wrist strap and protective anti-static mat at all times when servicing Dell products. In addition, it is critical that technicians keep sensitive parts separate from all insulator parts while performing service and that they use anti-static bags for transporting sensitive components.

## Transporting sensitive components

When transporting ESD sensitive components such as replacement parts or parts to be returned to Dell, it is critical to place these parts in anti-static bags for safe transport.

## After working inside your computer

### About this task

 **CAUTION: Leaving stray or loose screws inside your computer may severely damage your computer.**

### Steps

1. Replace all screws and ensure that no stray screws remain inside your computer.
2. Connect any external devices, peripherals, or cables you removed before working on your computer.
3. Replace any media cards, discs, or any other parts that you removed before working on your computer.
4. Connect your computer and all attached devices to their electrical outlets.
5. Turn on your computer.

# Removing and installing components

**NOTE:** The images in this document may differ from your computer depending on the configuration you ordered.

## Recommended tools

The procedures in this document may require the following tools:

- Phillips screwdriver #0
- Phillips screwdriver #1
- Plastic scribe









## Screw list

**NOTE:** When removing screws from a component, it is recommended to note the screw type, the quantity of screws, and then place them in a screw storage box. This is to ensure that the correct number of screws and correct screw type is restored when the component is replaced.

**NOTE:** Some computers have magnetic surfaces. Ensure that the screws are not left attached to such surfaces when replacing a component.









**NOTE:** Screw color may vary with the configuration ordered.

**Table 1. Screw list**

Component	Screw type	Quantity	Screw image
Base cover	M2x7.5 - captive screws	2	
Base cover	M2x4	7	
3-cell battery	M2x3	3	
4-cell battery	M2x3	5	
Wireless card	M2x3	1	
Solid-state drive	M2x3	1	
Solid-state drive	M2x1.8	1	
Fan	M2x3	2	
System board	M2x1.8	2	

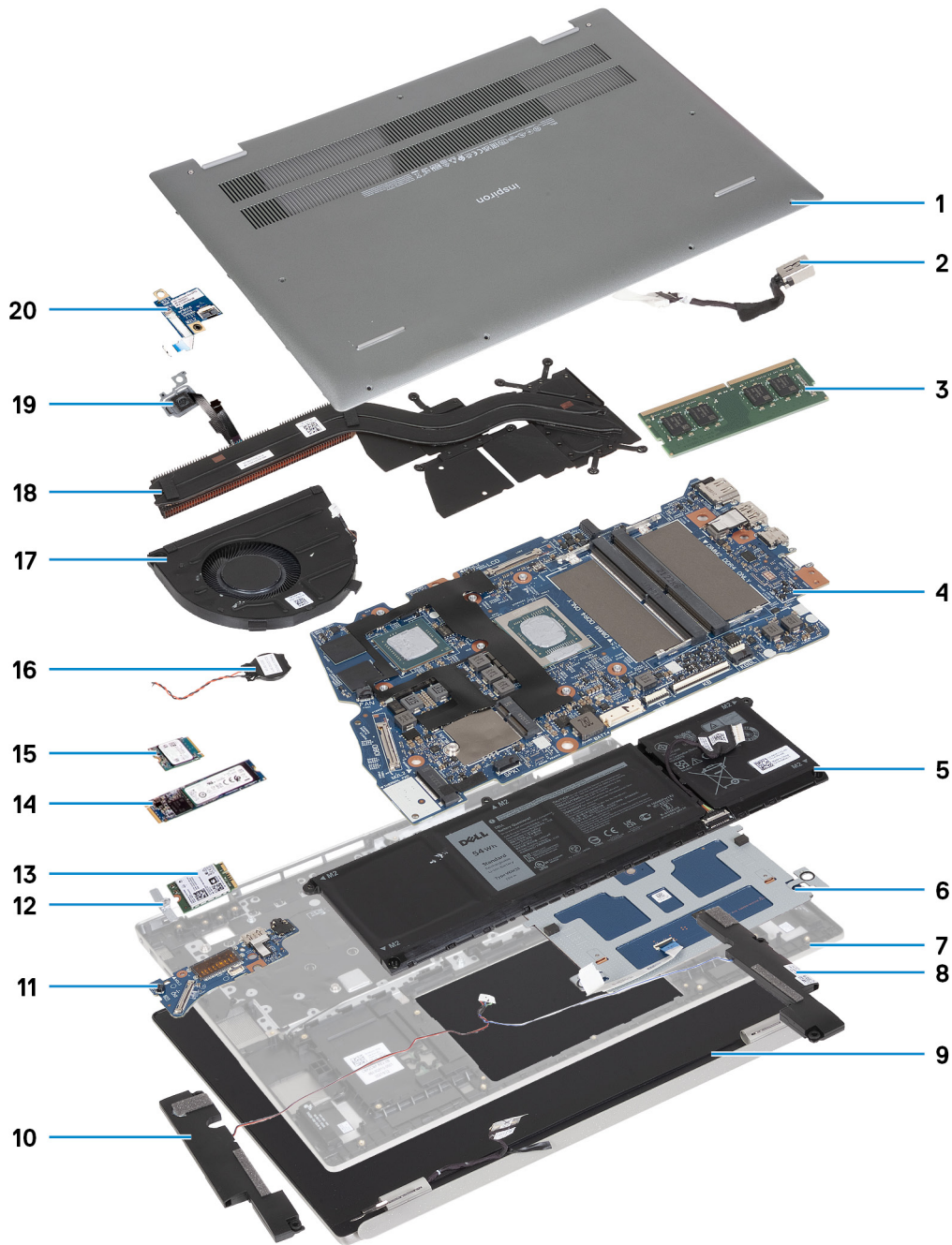

**Table 1. Screw list (continued)**

Component	Screw type	Quantity	Screw image
USB Type-C bracket	M2x4	2	
Power button with optional fingerprint reader	M2x3	1	
Power-button board	M2x3	1	
Power-button board	M2x1.8	1	
I/O board	M2x3	2	
Touchpad	M1.6x2	3	
Touchpad	M2x1.8	2	
Display hinges	M2.5x5	5	

## Major components of Inspiron 16 5625

The following image shows the major components of Inspiron 16 5625.



1. Base cover
2. Power-adaptor port
3. Memory module
4. System board
5. Battery
6. Touchpad
7. Palm-rest and keyboard assembly
8. Left speaker
9. Display assembly
10. Right speaker
11. I/O board
12. Wireless-card bracket
13. Wireless card
14. M.2 2280 solid-state drive
15. M.2 2230 solid-state drive

- 16. Coin-cell battery
- 17. System fan
- 18. Heat sink
- 19. Power button (with fingerprint reader - optional)
- 20. Power-button board

**i** **NOTE:** Dell provides a list of components and their part numbers for the original system configuration purchased. These parts are available according to warranty coverages purchased by the customer. Contact your Dell sales representative for purchase options.

## Base cover

### Removing the base cover

#### Prerequisites

1. Follow the procedure in [Before working inside your computer](#).

#### About this task

**i** **NOTE:** Before removing the base cover, ensure that there is no SD card installed in the SD card slot on your computer.

The following image(s) shows the base cover and provides a visual representation of the removal procedure.

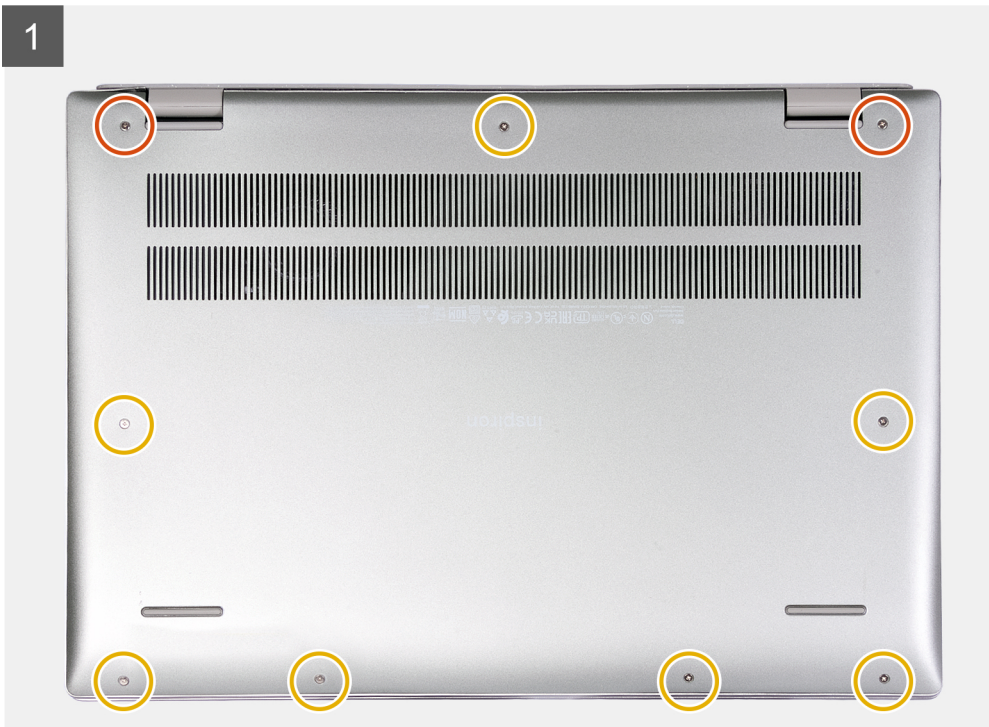
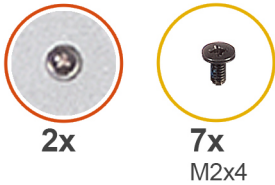

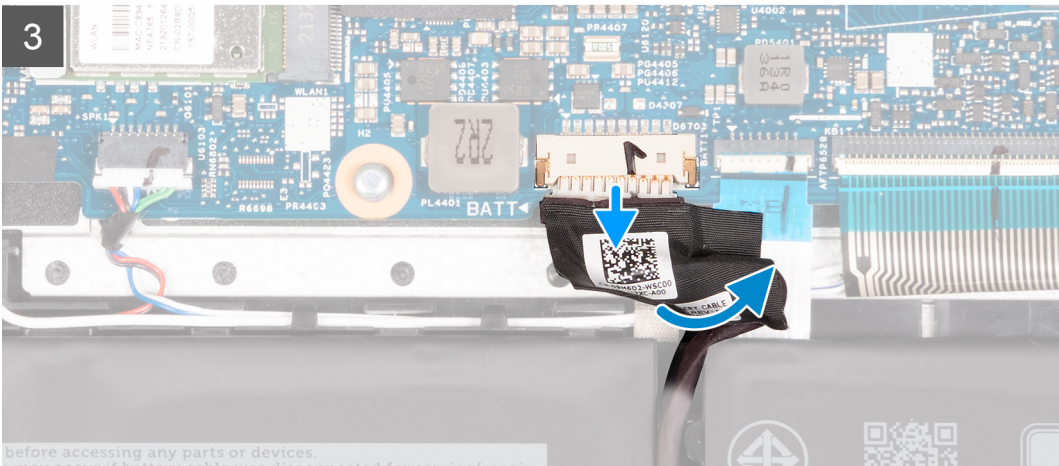
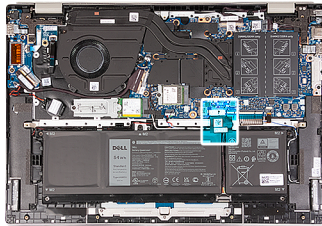
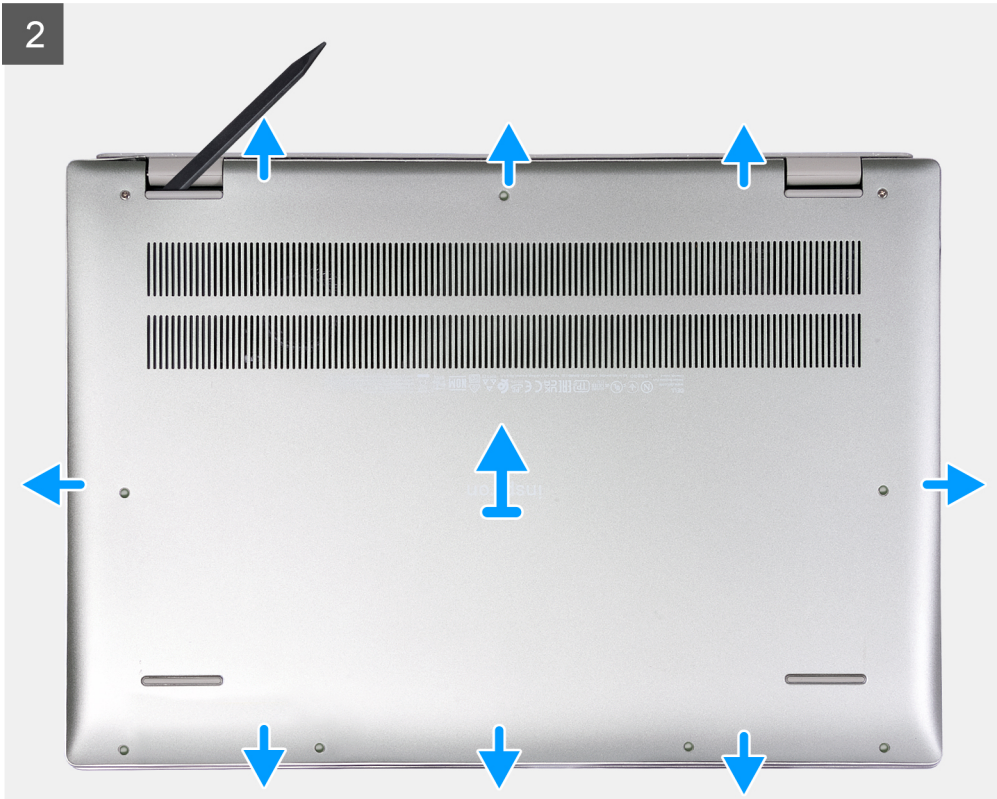



4

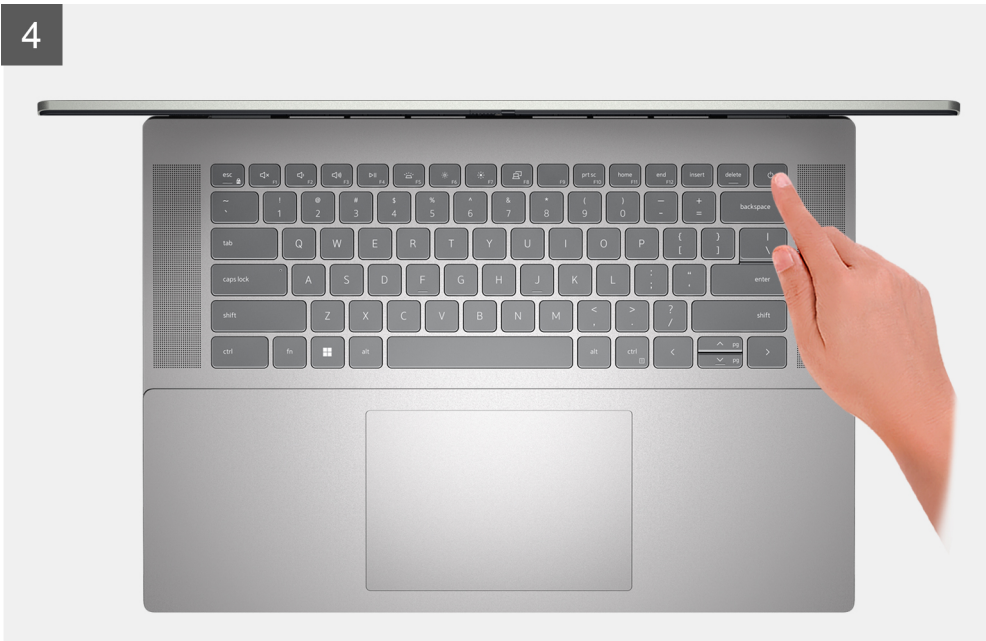

### Steps

1. Remove the seven screws (M2x4) that secure the base cover to the palm-rest and keyboard assembly.
2. Loosen the two captive screws.
3. Using a plastic scribe, pry the base cover from the bottom left and continue to work on the sides to open the base cover.
4. Lift and slide the base cover off the palm-rest and keyboard assembly.
5. Disconnect the battery cable from the system board.
6. Press and hold the power button for 20 seconds to ground the computer and drain the flea power.

## Installing the base cover

### Prerequisites

If you are replacing a component, remove the existing component before performing the installation process.

### About this task

The following image(s) shows the base cover and provides a visual representation of the installation procedure.

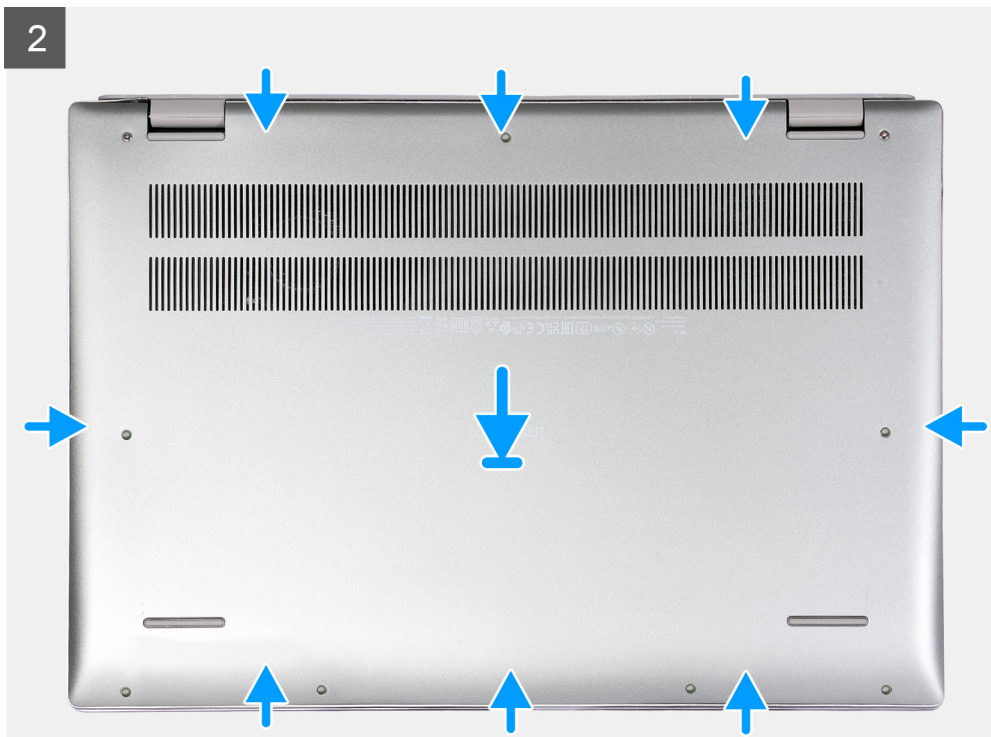
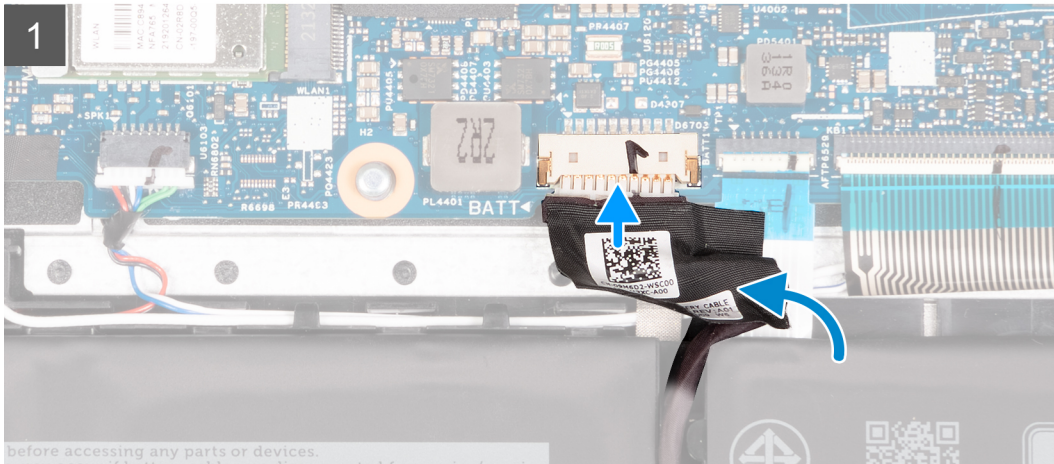
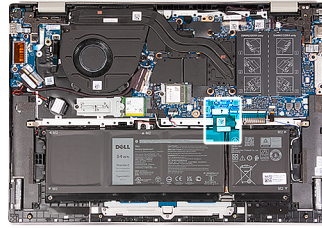
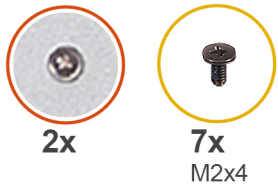

3

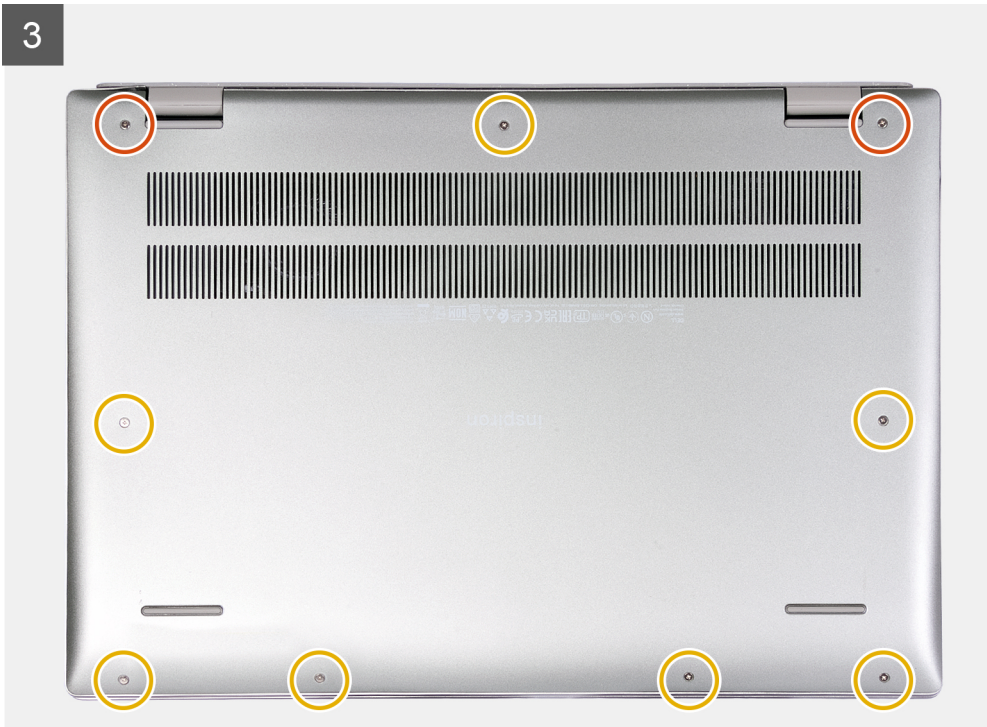

### Steps

1. Connect the battery cable to the system board.
2. Place and snap the base cover into place on the palm-rest and keyboard assembly.
3. Tighten the two captive screws on the base cover.
4. Replace the seven screws (M2x4) that secure the base cover to the palm-rest and keyboard assembly.

### Next steps

1. Follow the procedure in [After working inside your computer](#).

## Battery

### Lithium-ion battery precautions

#### ⚠ CAUTION:

- Exercise caution when handling Lithium-ion batteries.
- Discharge the battery completely before removing it. Disconnect the AC power adapter from the system and operate the computer solely on battery power—the battery is fully discharged when the computer no longer turns on when the power button is pressed.
- Do not crush, drop, mutilate, or penetrate the battery with foreign objects.
- Do not expose the battery to high temperatures, or disassemble battery packs and cells.
- Do not apply pressure to the surface of the battery.
- Do not bend the battery.
- Do not use tools of any kind to pry on or against the battery.
- Ensure any screws during the servicing of this product are not lost or misplaced, to prevent accidental puncture or damage to the battery and other system components.
- If the battery gets stuck inside your computer as a result of swelling, do not try to release it as puncturing, bending, or crushing a lithium-ion battery can be dangerous. In such an instance, contact Dell technical support for assistance. See [www.dell.com/contactdell](http://www.dell.com/contactdell).



- Always purchase genuine batteries from [www.dell.com](http://www.dell.com) or authorized Dell partners and resellers.
- Swollen batteries should not be used and should be replaced and disposed properly. For guidelines on how to handle and replace swollen Lithium-ion batteries, see [Handling swollen Lithium-ion batteries](#).

## Removing the 3-cell battery

### Prerequisites

1. Follow the procedure in [Before working inside your computer](#).
2. Remove the [base cover](#).

### About this task

The following image(s) indicate the location of the 3-cell battery and provides a visual representation of the removal procedure.

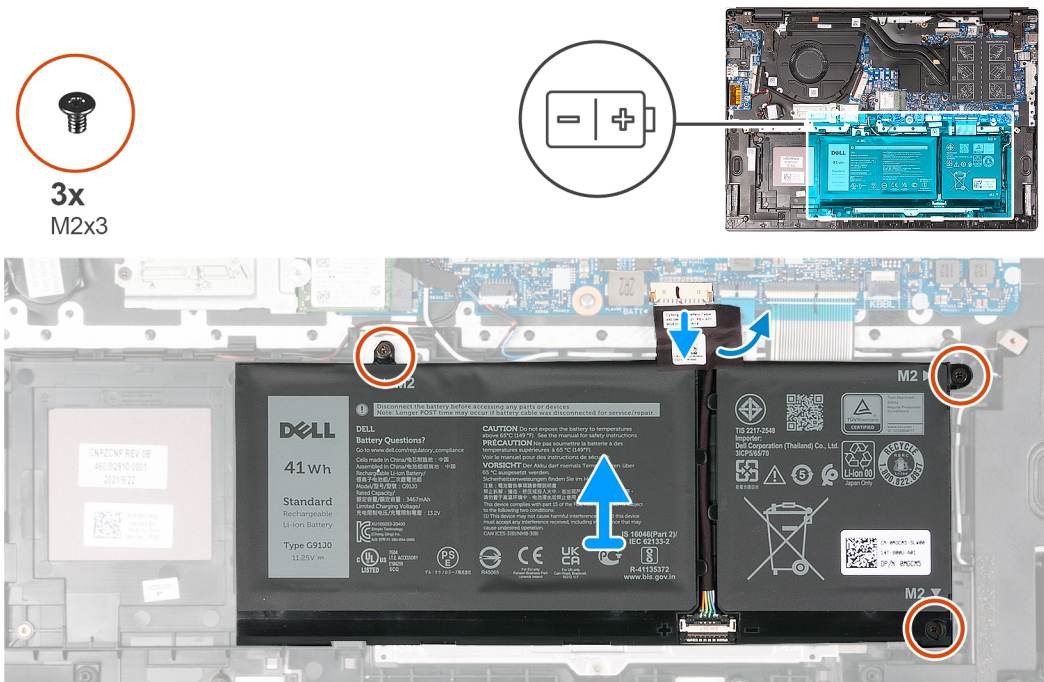

### Steps

1. Peel the tape that secures the battery cable to the battery.
2. Disconnect the battery cable from the system board.
3. Remove the three screws (M2x3) that secure the battery to the palm-rest and keyboard assembly.
4. Lift the battery off the palm-rest and keyboard assembly.

## Installing the 3-cell battery

### Prerequisites

If you are replacing a component, remove the existing component before performing the installation process.

### About this task

The following image(s) indicate the location of the 3-cell battery and provides a visual representation of the installation procedure.





3x  
M2x3

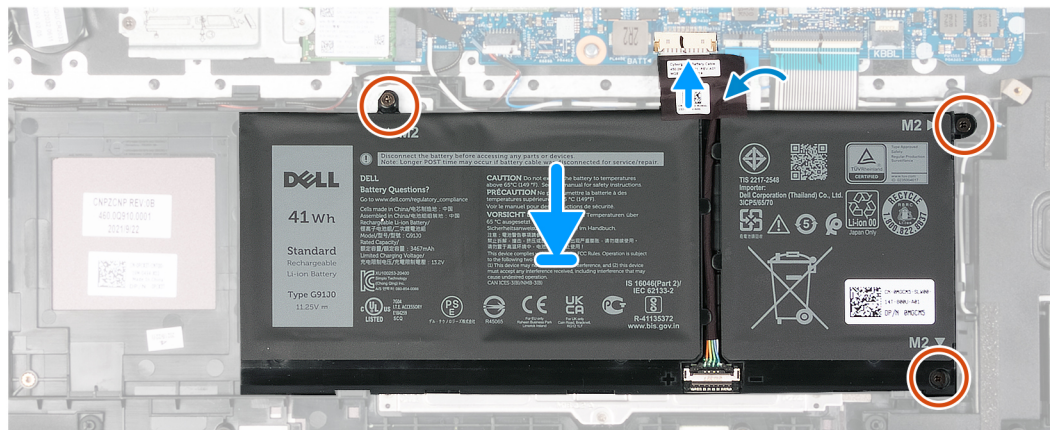
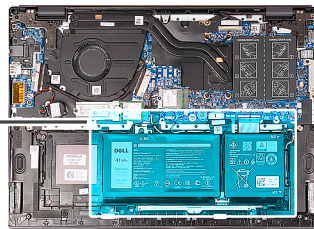
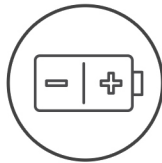

### Steps

1. Align the screw holes on the battery with the screw holes on the palm-rest and keyboard assembly.
2. Replace the three screws (M2x3) that secure the battery to the palm-rest and keyboard assembly.
3. Connect the battery cable to the system board.
4. Adhere the tape that secures the battery cable to the battery.

### Next steps

1. Install the [base cover](#).
2. Follow the procedure in [After working inside your computer](#).

## Removing the 4-cell battery

### Prerequisites

1. Follow the procedure in [Before working inside your computer](#).
2. Remove the [base cover](#).

### About this task

The following image(s) indicate the location of the 4-cell battery and provides a visual representation of the removal procedure.



5x  
M2x3

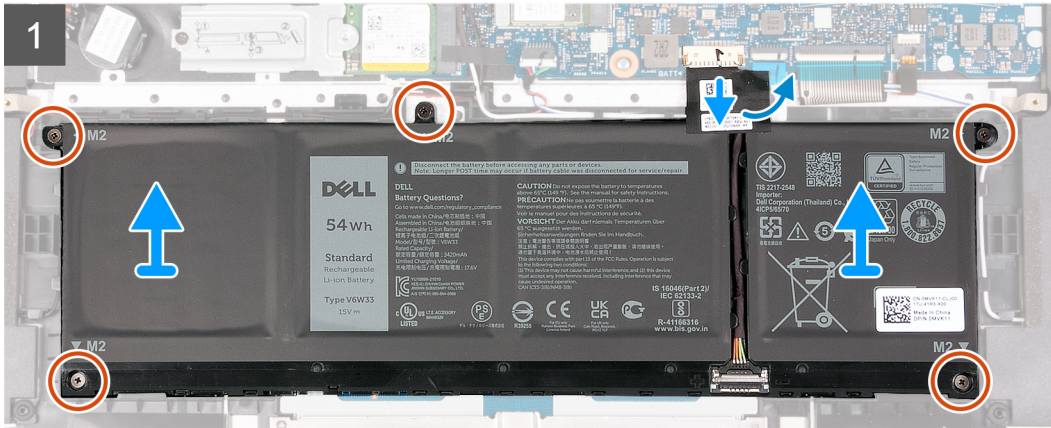
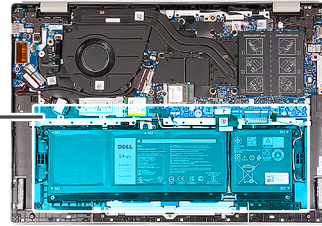
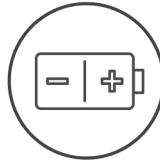

### Steps

1. Peel the tape that secures the battery cable to the battery.
2. Disconnect the battery cable from the system board.
3. Remove the five screws (M2x3) that secure the battery to the palm-rest and keyboard assembly.
4. Lift the battery off the palm-rest and keyboard assembly.

## Installing the 4-cell battery

### Prerequisites

If you are replacing a component, remove the existing component before performing the installation process.

### About this task

The following image(s) indicate the location of the 4-cell battery and provides a visual representation of the installation procedure.



5x  
M2x3

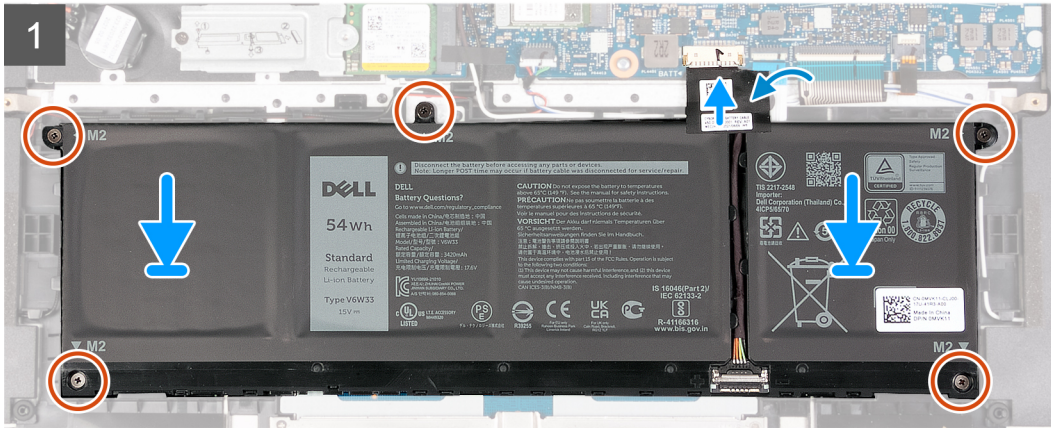
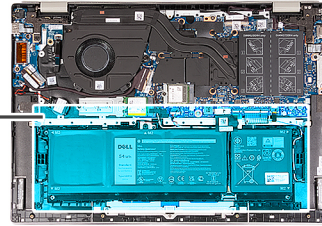
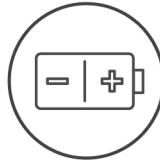

## Steps

1. Align the screw holes on the battery with the screw holes on the palm-rest and keyboard assembly.
2. Replace the five screws (M2x3) that secure the battery to the palm-rest and keyboard assembly.
3. Connect the battery cable to the system board.
4. Adhere the tape that secures the battery cable to the battery.

## Next steps

1. Install the [base cover](#).
2. Follow the procedure in [After working inside your computer](#).

# Memory modules

## Removing the memory module

### Prerequisites

1. Follow the procedure in [Before working inside your computer](#).
2. Remove the [base cover](#).

### About this task

The following image(s) indicate the location of the memory module and provides a visual representation of the removal procedure.



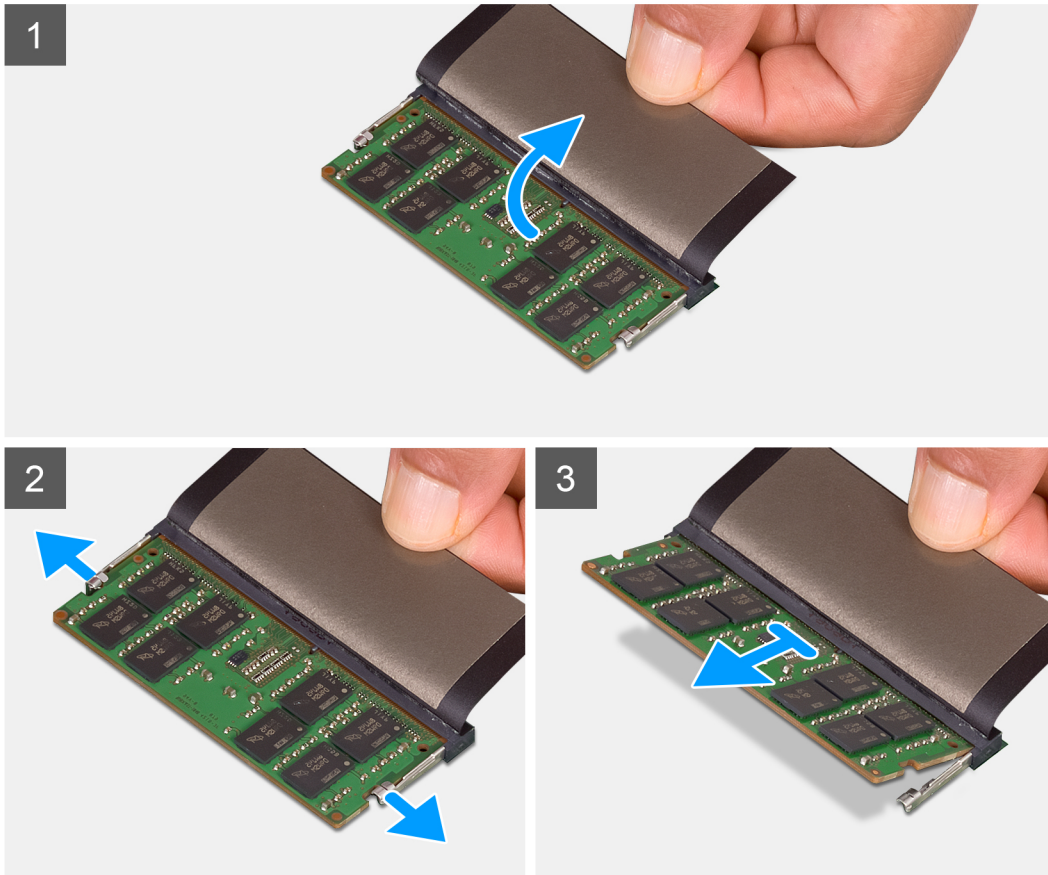
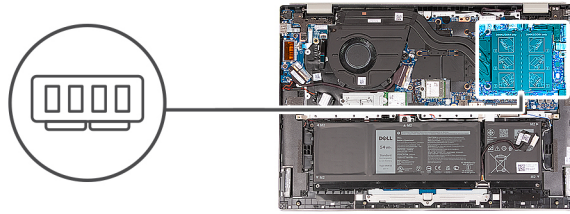

### Steps

1. Lift the mylar covering the memory module.
2. Using your fingertips, carefully spread apart the securing-clips on each end of the memory-module slot until the memory module pops-up.
3. Remove the memory module from the memory-module slot on the system board.

**i** **NOTE:** Your computer has two memory modules installed. Repeat steps 1 to 3 for the memory module installed in the second memory slot.

## Installing the memory module

### Prerequisites

If you are replacing a component, remove the existing component before performing the installation process.

### About this task

The following image(s) indicate the location of the memory module and provides a visual representation of the installation procedure.

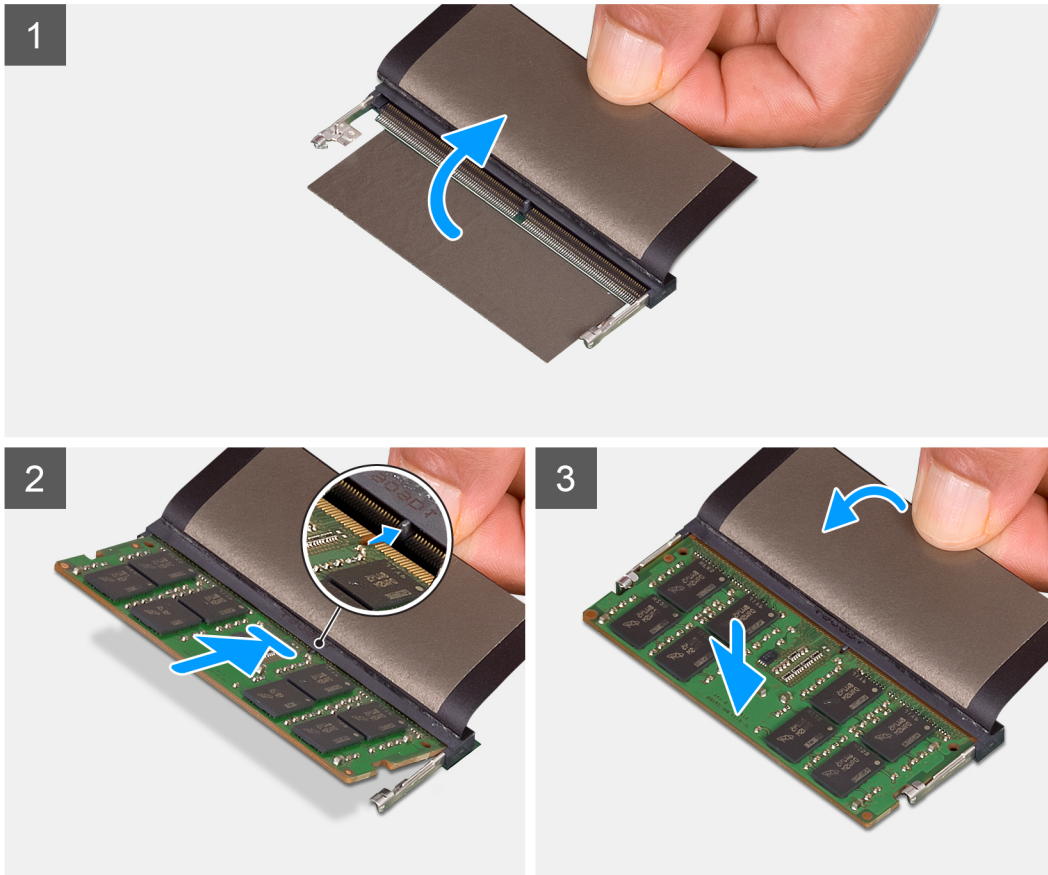
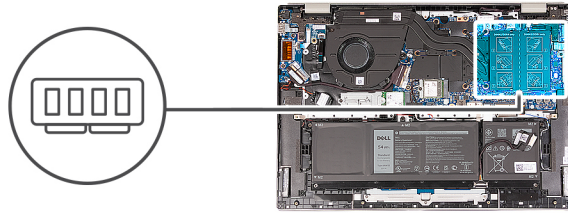

### Steps

1. Lift the mylar covering the memory-module slot.
2. Align the notch on the memory module with the tab on the memory-module slot on the system board.
3. Slide the memory module into the memory-module slot on the system board.
4. Press down on the memory module till the securing clips click, locking the memory module in place.

**i** **NOTE:** Repeat steps 1 to 4 for the second memory module being installed into your computer.

### Next steps

1. Install the [base cover](#).
2. Follow the procedure in [After working inside your computer](#).

# Solid-state drive

## Removing the M.2 2230 solid-state drive

### Prerequisites

1. Follow the procedure in [Before working inside your computer](#).
2. Remove the [base cover](#).

### About this task

**NOTE:** This procedure applies only to computers shipped with an M.2 2230 solid-state drive installed.

**NOTE:** The M.2 solid-state drive installed on your computer depends on the configuration ordered. The M.2 slot supports one of the following solid-state drives:

- M.2 2230 solid-state drive

A mounting bracket for the M.2 2230 solid-state drive is required. The mounting bracket is provided if the M.2 2230 solid-state drive is shipped with the computer.

If you are replacing the M.2 2230 solid-state drive with a new M.2 2230 solid-state drive, use the existing mounting bracket to install the latter.

- M.2 2280 solid-state drive

If you are replacing the M.2 2280 solid-state drive (shipped with the computer) with an M.2 2230 solid-state drive, a mounting bracket for the M.2 2230 solid-state drive is required. Please contact Dell support to purchase the mounting bracket for the M.2 2230 solid-state drive.

The following image(s) indicate the location of the M.2 2230 solid-state drive and provides a visual representation of the removal procedure.

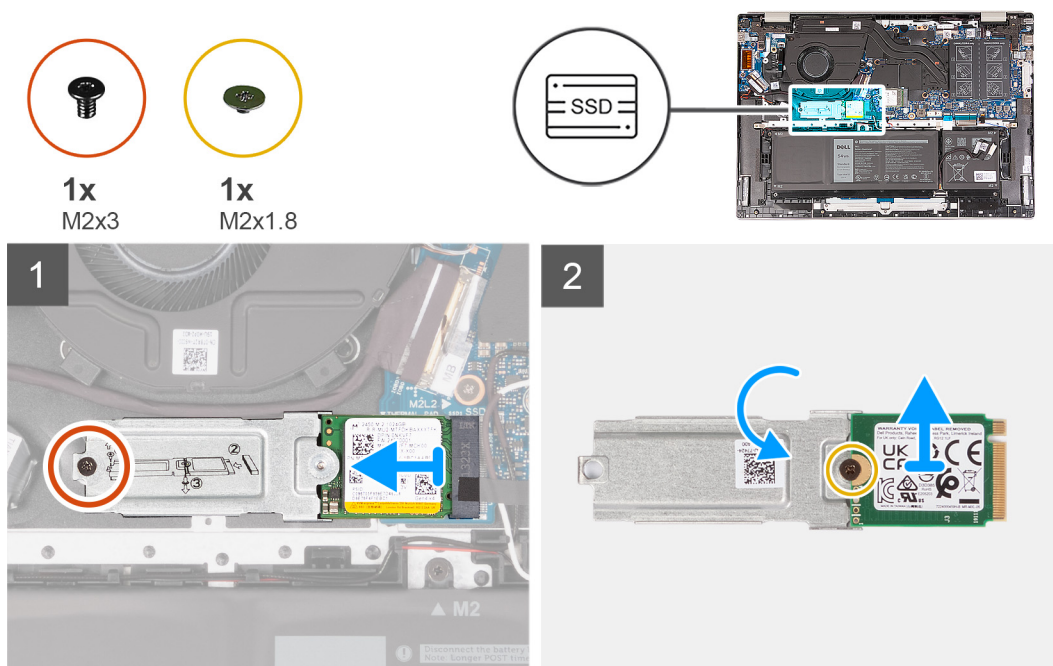

### Steps

1. Remove the screw (M2x3) that secures the M.2 mounting bracket to the palm-rest and keyboard assembly.
2. Slide the M.2 2230 solid-state drive out of the solid-state drive slot.

3. Lift the M.2 2230 solid-state drive assembly off the system board.
4. Turn and place the M.2 2230 solid-state drive assembly on a dry and flat surface.
5. Remove the screw (M2x1.8) that secures the M.2 mounting bracket to the M.2 2230 solid-state drive.

## Installing the M.2 2230 solid-state drive

### Prerequisites

If you are replacing a component, remove the existing component before performing the installation process.

### About this task

- NOTE:** This procedure applies if you are installing an M.2 2230 solid-state drive.
- NOTE:** The M.2 solid-state drive installed on your computer depends on the configuration ordered. The M.2 slot supports one of the following solid-state drives:
  - M.2 2230 solid-state drive
 

A mounting bracket for the M.2 2230 solid-state drive is required. The mounting bracket is provided if the M.2 2230 solid-state drive is shipped with the computer.

If you are replacing the M.2 2230 solid-state drive with a new M.2 2230 solid-state drive, use the existing mounting bracket to install the latter.
  - M.2 2280 solid-state drive
 

If you are replacing the M.2 2280 solid-state drive (shipped with the computer) with an M.2 2230 solid-state drive, a mounting bracket for the M.2 2230 solid-state drive is required. Please contact Dell support to purchase the mounting bracket for the M.2 2230 solid-state drive.

The following image(s) indicate the location of the M.2 2230 solid-state drive and provides a visual representation of the installation procedure.

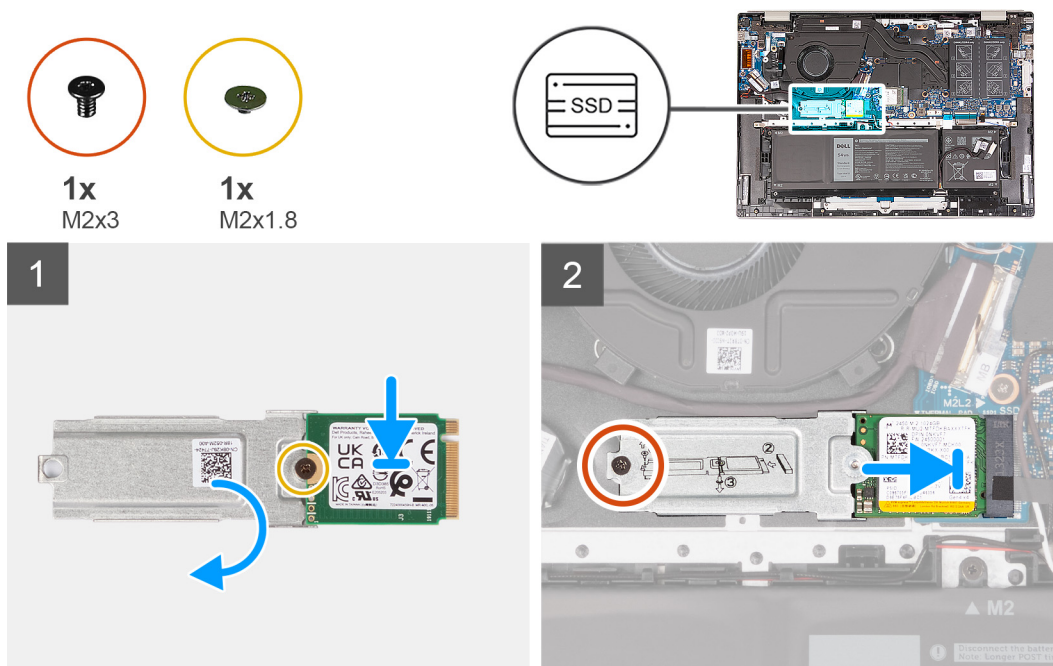

### Steps

1. Align the screw hole on the M.2 2230 solid-state drive with the screw hole on the M.2 mounting bracket.
2. Replace the screw (M2x1.8) that secures the M.2 mounting bracket to the M.2 2230 solid-state drive.

3. Align the notch on the M.2 2230 solid-state drive with the tab on the solid-state drive slot.
4. Slide the M.2 2230 solid-state drive into the solid-state drive slot.
5. Replace the screw (M2x3) that secures the M.2 mounting bracket to the palm-rest and keyboard assembly.

#### Next steps

1. Install the [base cover](#).
2. Follow the procedure in [After working inside your computer](#).

## Removing the M.2 2280 solid-state drive

#### Prerequisites

1. Follow the procedure in [Before working inside your computer](#).
2. Remove the [base cover](#).

#### About this task

**NOTE:** This procedure applies only to computers shipped with an M.2 2280 solid-state drive installed.

**NOTE:** The M.2 solid-state drive installed on your computer depends on the configuration ordered. The M.2 slot supports one of the following solid-state drives:

- M.2 2230 solid-state drive

A mounting bracket for the M.2 2230 solid-state drive is required. The mounting bracket is provided if the M.2 2230 solid-state drive is shipped with the computer.

If you are replacing the M.2 2230 solid-state drive with a new M.2 2230 solid-state drive, use the existing mounting bracket to install the latter.

- M.2 2280 solid-state drive

If you are replacing the M.2 2280 solid-state drive (shipped with the computer) with an M.2 2230 solid-state drive, a mounting bracket for the M.2 2230 solid-state drive is required. Please contact Dell support to purchase the mounting bracket for the M.2 2230 solid-state drive.

The following image(s) indicate the location of the M.2 2280 solid-state drive and provides a visual representation of the removal procedure.





1x  
M2x3

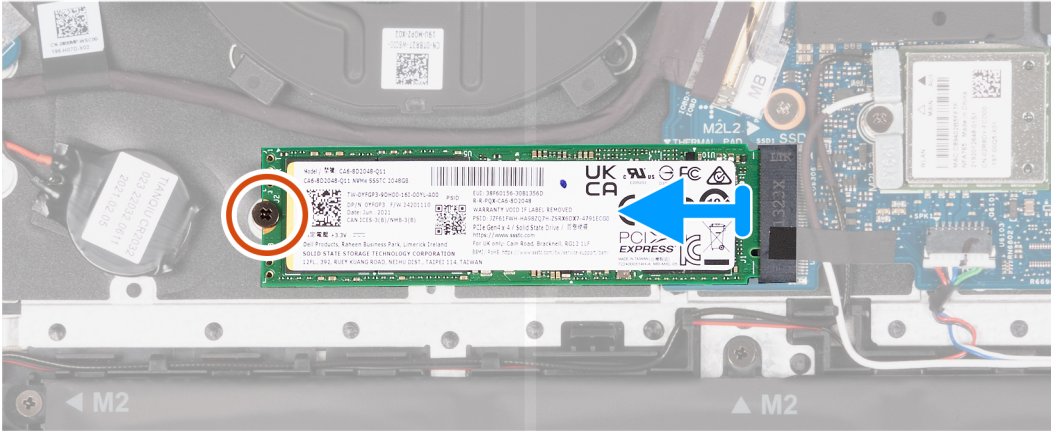
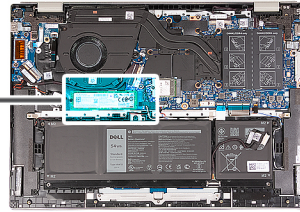

### Steps

1. Remove the screw (M2x3) that secures the M.2 2280 solid-state drive to the palm-rest and keyboard assembly.
2. Slide and lift the M.2 2280 solid-state drive off the solid-state drive slot on the system board.

## Installing the M.2 2280 solid-state drive

### Prerequisites

If you are replacing a component, remove the existing component before performing the installation process.

### About this task

- i** **NOTE:** This procedure applies if you are installing an M.2 2280 solid-state drive.
- i** **NOTE:** The M.2 solid-state drive installed on your computer depends on the configuration ordered. The M.2 slot supports one of the following solid-state drives:
- M.2 2230 solid-state drive  
A mounting bracket for the M.2 2230 solid-state drive is required. The mounting bracket is provided if the M.2 2230 solid-state drive is shipped with the computer.  
If you are replacing the M.2 2230 solid-state drive with a new M.2 2230 solid-state drive, use the existing mounting bracket to install the latter.
  - M.2 2280 solid-state drive  
If you are replacing the M.2 2280 solid-state drive (shipped with the computer) with an M.2 2230 solid-state drive, a mounting bracket for the M.2 2230 solid-state drive is required. Please contact Dell support to purchase the mounting bracket for the M.2 2230 solid-state drive.

The following image(s) indicate the location of the M.2 2280 solid-state drive and provides a visual representation of the installation procedure.



1x  
M2x3

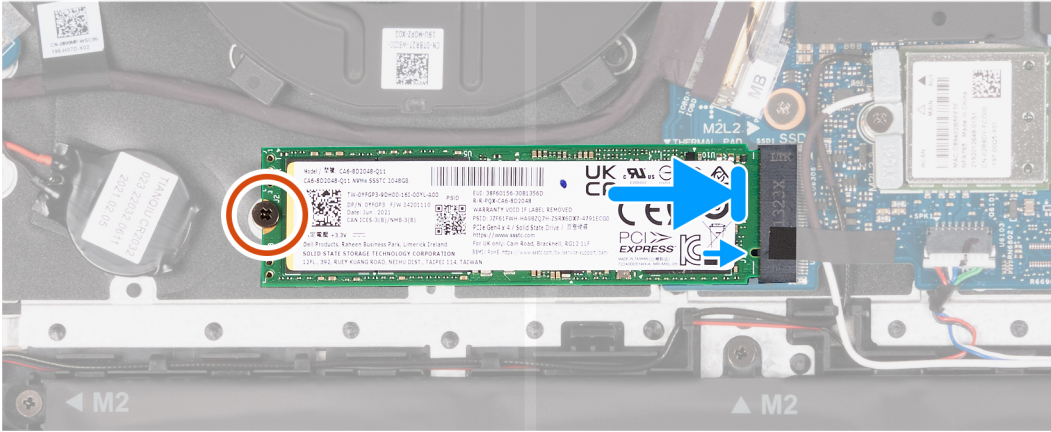
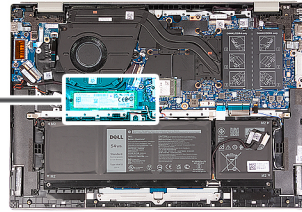

### Steps

1. Align the notch on the M.2 2280 solid-state drive with the tab on the solid-state drive slot.
2. Slide the M.2 2280 solid-state drive into the solid-state drive slot
3. Replace the screw (M2x3) that secures the M.2 2280 solid-state drive to the palm-rest and keyboard assembly.

### Next steps

1. Install the [base cover](#).
2. Follow the procedure in [After working inside your computer](#).

## Wireless card

### Removing the wireless card

#### Prerequisites

1. Follow the procedure in [Before working inside your computer](#).
2. Remove the [base cover](#).

#### About this task

The following image(s) indicate the location of the wireless card and provides a visual representation of the removal procedure.



1x  
M2x3

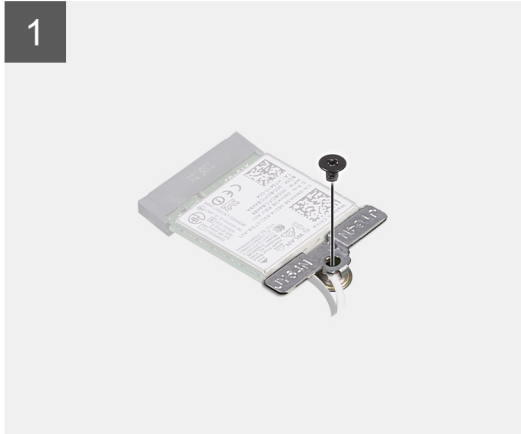
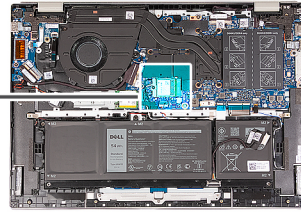

### Steps

1. Remove the screw (M2x3) that secures the wireless-card bracket to the system board and palm-rest and keyboard assembly.
2. Lift the wireless-card bracket off the wireless card.
3. Disconnect the antenna cables from the wireless card.
4. Slide and remove the wireless card from the wireless-card slot.

## Installing the wireless card

### Prerequisites

If you are replacing a component, remove the existing component before performing the installation process.

### About this task

The following image(s) indicate the location of the wireless card and provides a visual representation of the installation procedure.



1x  
M2x3

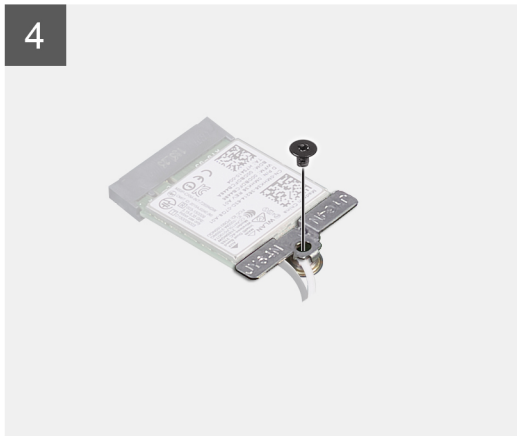
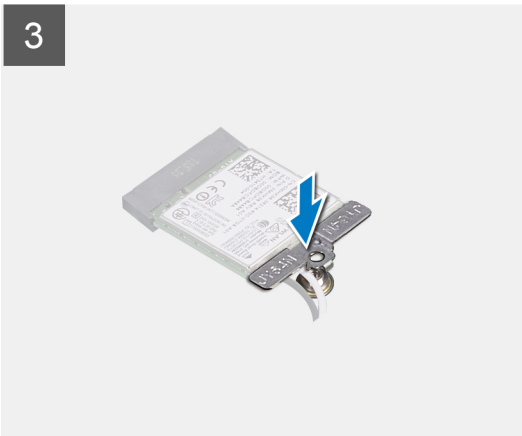
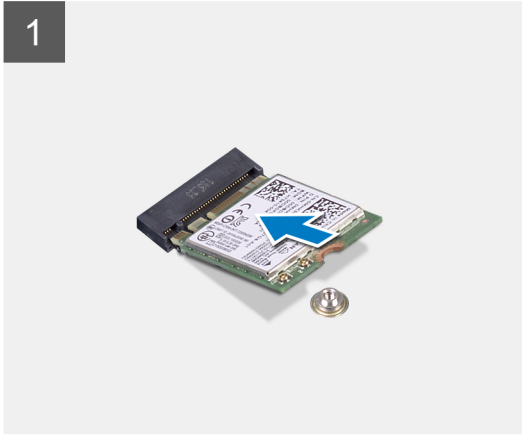
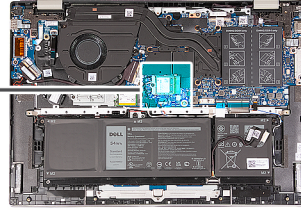

### Steps

1. Align the notch on the wireless card with the tab on the wireless-card slot and insert the wireless card at an angle into the wireless-card slot.

The following table provides the antenna-cable color scheme for the wireless card that is supported by your computer.

**Table 2. Antenna-cable color scheme**

Connectors on the wireless card	Antenna-cable color	Silkscreen marking	
Main	White	MAIN	△ (white triangle)
Auxiliary	Black	AUX	▲ (black triangle)

2. Connect the antenna cables to the wireless card.
3. Align and place the wireless-card bracket on the wireless card.
4. Replace the screw (M2x3) that secures the wireless-card bracket to the system board and palm-rest and keyboard assembly.

### Next steps

1. Install the [base cover](#).

2. Follow the procedure in [After working inside your computer](#).

## Fan

### Removing the fan

#### Prerequisites

1. Follow the procedure in [Before working inside your computer](#).
2. Remove the [base cover](#).

#### About this task

The following image(s) indicate the location of the fan and provides a visual representation of the removal procedure.

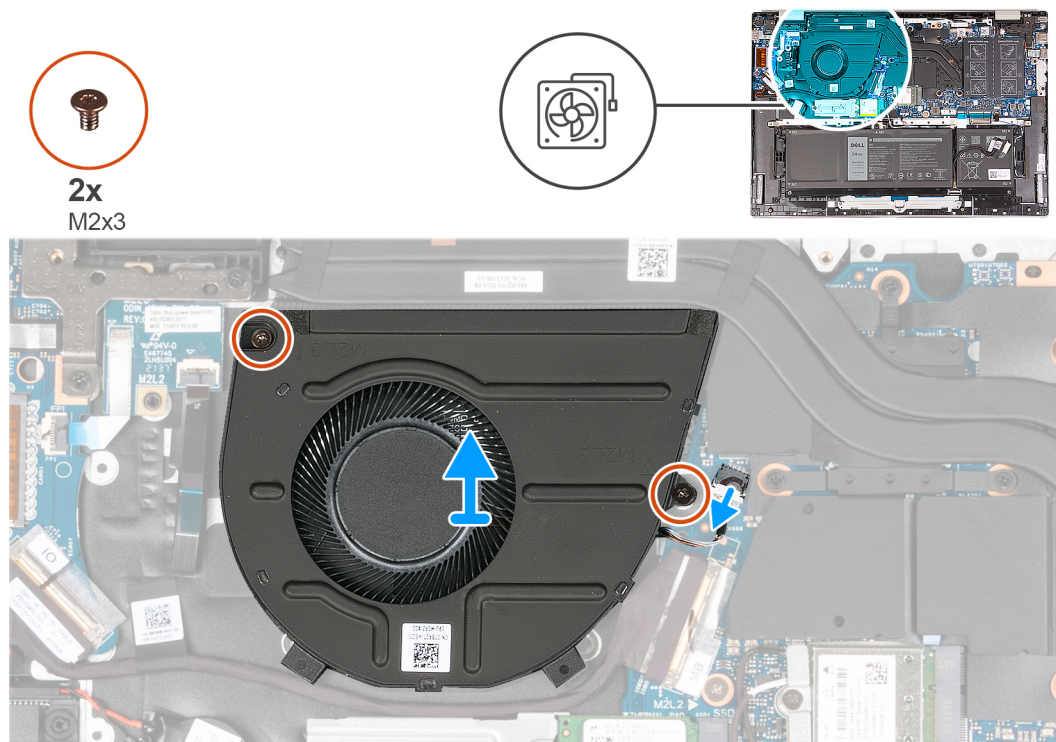

#### Steps

1. Disconnect the fan cable from the system board.
2. Remove the two screws (M2x3) that secure the fan to the palm-rest and keyboard assembly.
3. Lift the fan off the palm-rest and keyboard assembly.

### Installing the fan

#### Prerequisites

If you are replacing a component, remove the existing component before performing the installation process.

#### About this task

The following image(s) indicate the location of the fan and provides a visual representation of the installation procedure.





2x  
M2x3

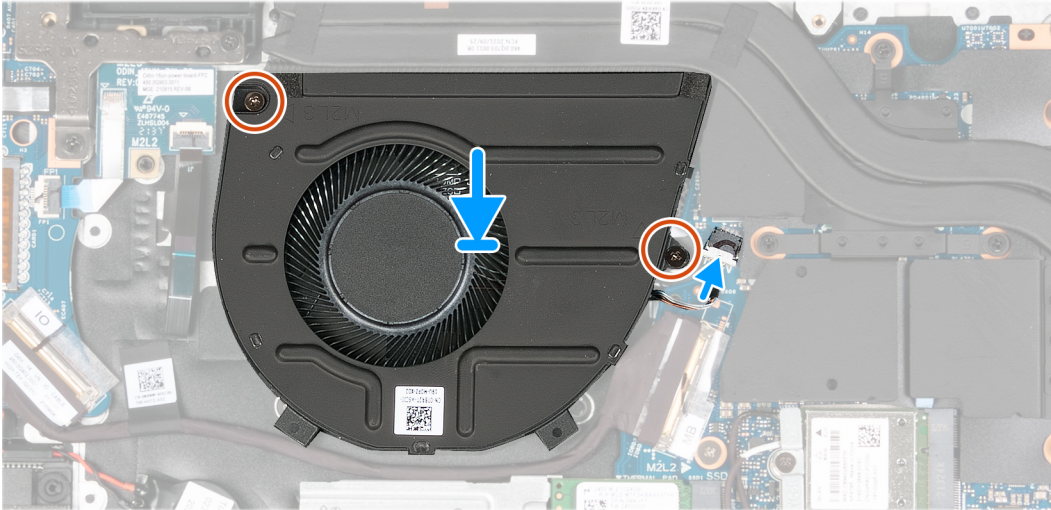
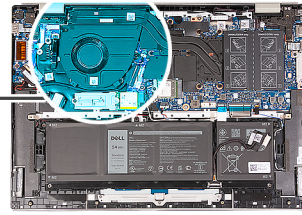
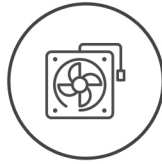

### Steps

1. Align the screw holes of the fan with screws on the palm-rest and keyboard assembly.
2. Replace the two screws (M2x3) that secure the fan to the palm-rest and keyboard assembly.
3. Connect the fan cable to the system board.

### Next steps

1. Install the [base cover](#).
2. Follow the procedure in [After working inside your computer](#).

## Coin-cell battery

### Removing the coin-cell battery

#### Prerequisites

1. Follow the procedure in [Before working inside your computer](#).
2. Remove the [base cover](#).

#### About this task

The following image(s) indicate the location of the coin-cell battery and provides a visual representation of the removal procedure.

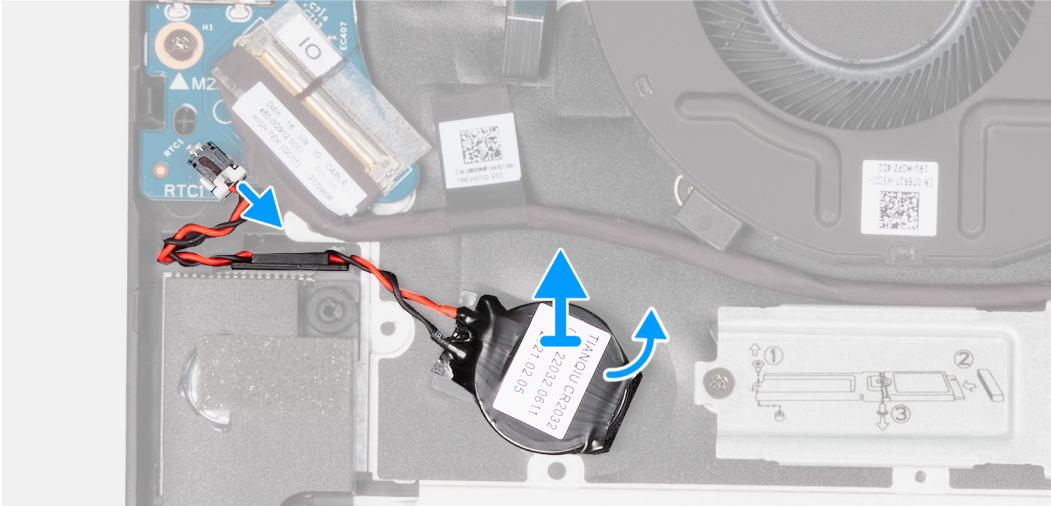
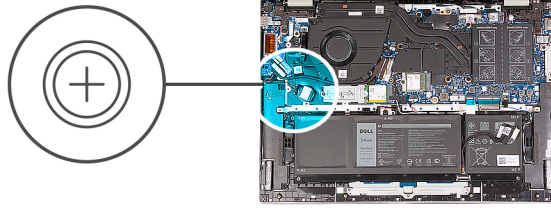

### Steps

1. Disconnect the coin-cell battery cable from the I/O board.
2. Pry the coin-cell battery from the palm-rest and keyboard assembly.

## Installing the coin-cell battery

### Prerequisites

If you are replacing a component, remove the existing component before performing the installation process.

### About this task

The following image(s) indicate the location of the coin-cell battery and provides a visual representation of the installation procedure.

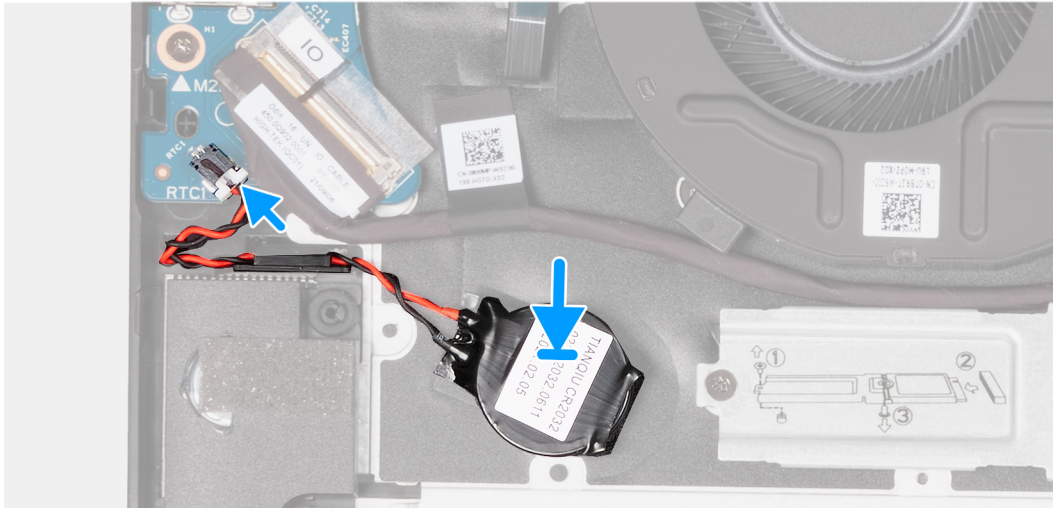
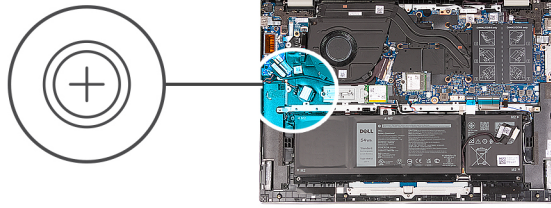

### Steps

1. Install the coin-cell battery into its slot on the palm-rest and keyboard assembly.
2. Connect the coin-cell battery cable to the I/O board.

### Next steps

1. Install the [base cover](#).
2. Follow the procedure in [After working inside your computer](#).

## Heat sink

### Removing the heatsink

#### Prerequisites

1. Follow the procedure in [Before working inside your computer](#).
2. Remove the [base cover](#).

#### About this task

- NOTE:** The heat sink may become hot during normal operation. Allow sufficient time for the heat sink to cool before you touch it.
- NOTE:** For maximum cooling of the processor, do not touch the heat transfer areas on the heat sink. The oils in your skin can reduce the heat transfer capability of the thermal grease.
- NOTE:** The number of screws on the heat sink varies depending on the graphic card configuration ordered.

The following image(s) indicate the location of the heatsink and provides a visual representation of the removal procedure.



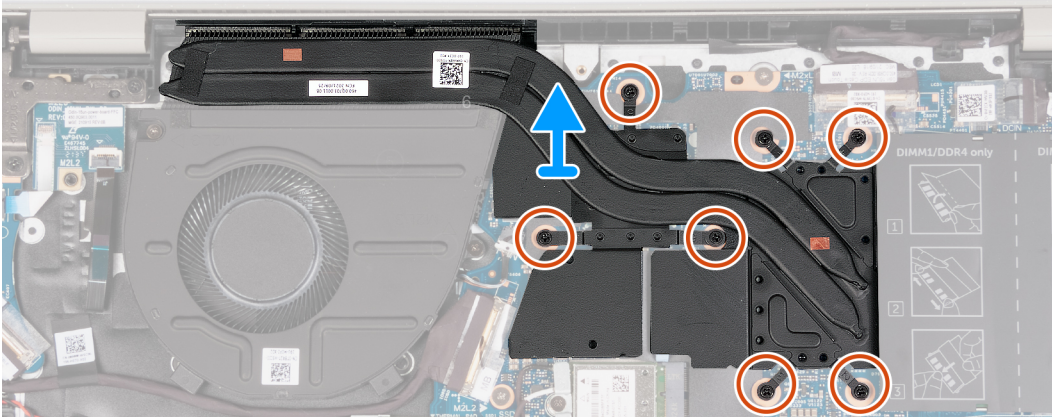
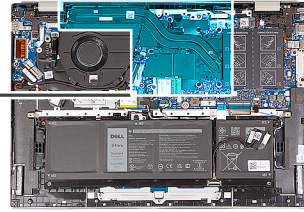

**NOTE:** This is the heatsink for your computer that supports the **discrete** Graphics Processing Unit (GPU).

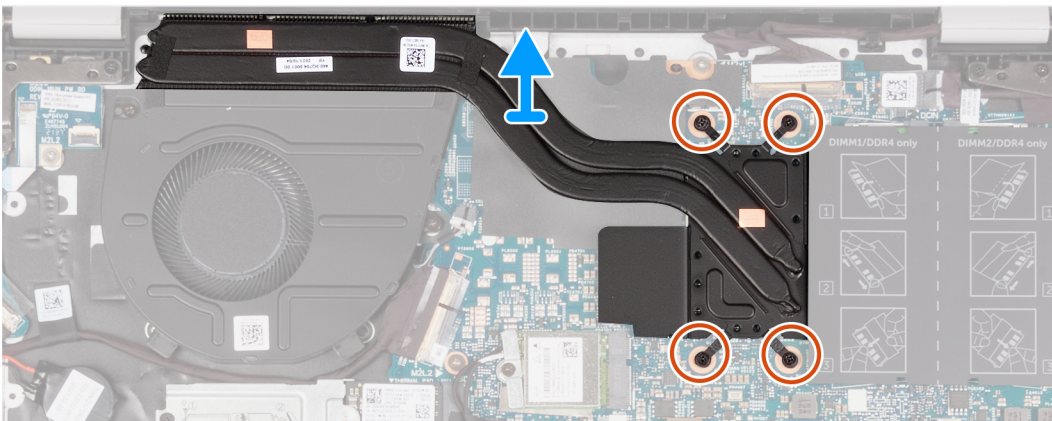
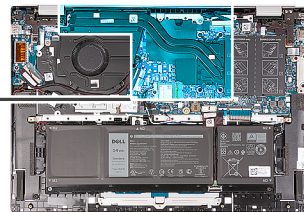

**NOTE:** This is the heatsink for your computer that supports **integrated** Graphics Processing Unit (GPU).

### Steps

1. In reverse sequential order (7>6>5>4>3>2>1), or (4>3>2>1), whichever is applicable, loosen the seven or four captive screws, whichever is applicable, that secure the heat sink to the system board.
2. Lift the heat sink from the system board.

# Installing the heatsink

## Prerequisites

If you are replacing a component, remove the existing component before performing the installation process.

## About this task

- NOTE:** If either the system board or the heat sink is replaced, use the thermal grease provided in the kit to ensure that thermal conductivity is achieved.
- NOTE:** The number of screws on the heat sink varies depending on the graphic card configuration ordered.

The following image(s) indicate the location of the heatsink and provides a visual representation of the installation procedure.

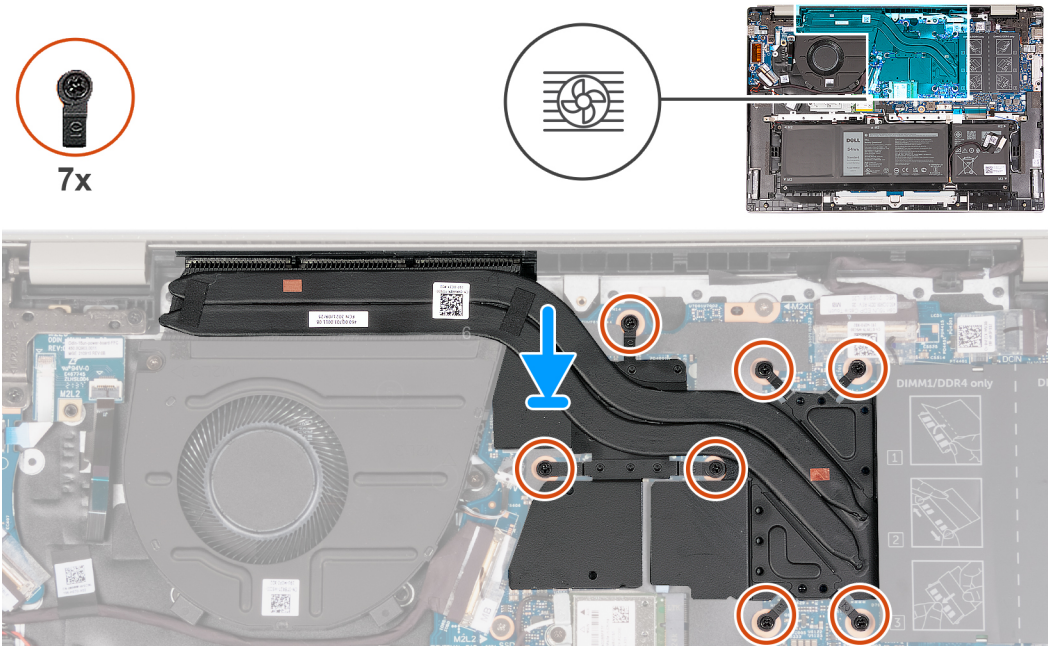

- NOTE:** This is the heatsink for your computer that supports the **discrete** Graphics Processing Unit (GPU).

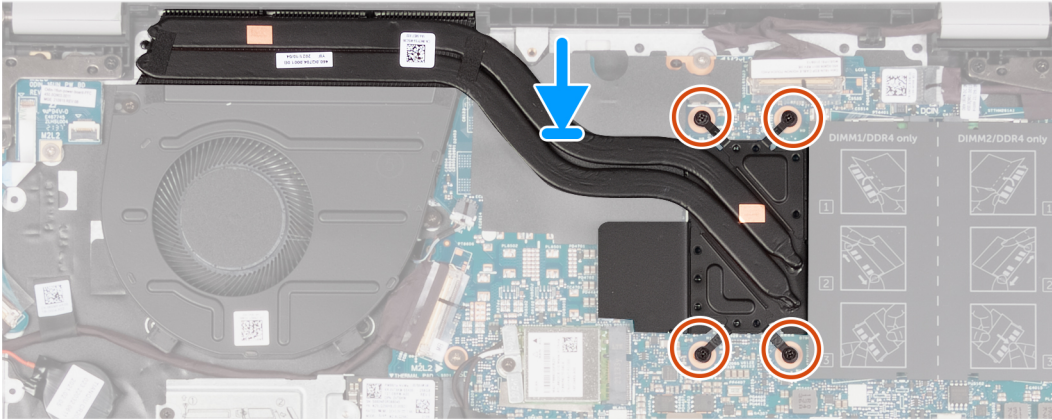
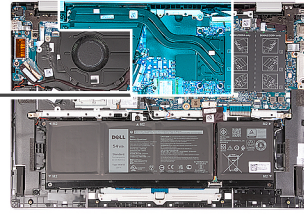

**NOTE:** This is the heatsink for your computer that supports the **integrated** Graphics Processing Unit (GPU).

### Steps

1. Align the screw holes on the heat sink to the screw holes on the system board.
2. In sequential order (1>2>3>4>5>6>7) or (1>2>3>4), tighten the seven or four captive screws, whichever is applicable, that secure the heat sink to the system board.

### Next steps

1. Install the [base cover](#).
2. Follow the procedure in [After working inside your computer](#).

## Display assembly

### Removing the display assembly

#### Prerequisites

1. Follow the procedure in [Before working inside your computer](#).
2. Remove the [base cover](#).

#### About this task

The following image(s) indicate the location of the display assembly and provides a visual representation of the removal procedure.





5x  
M2.5x5

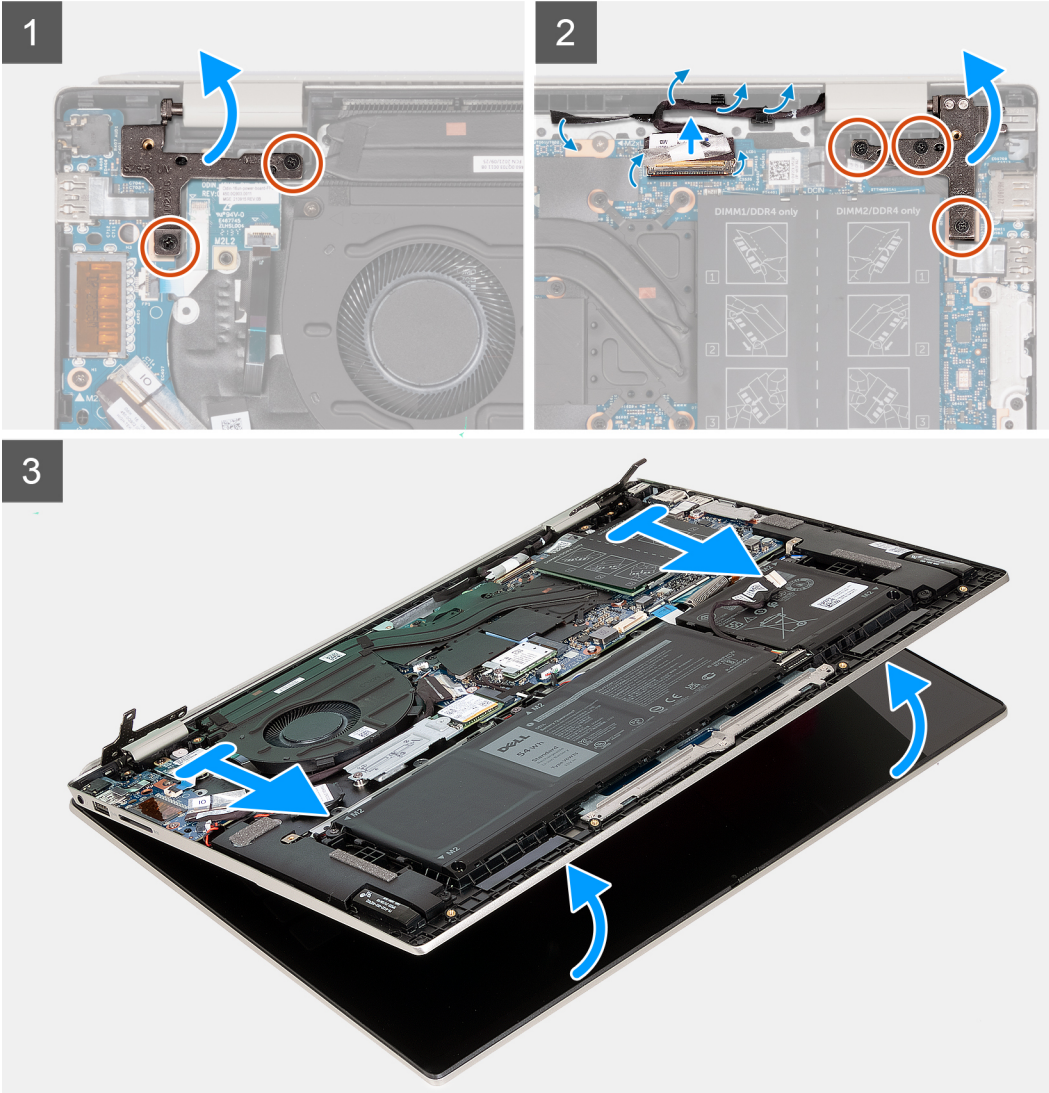
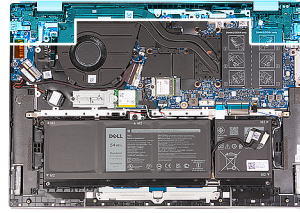

### Steps

1. Remove the two screws (M2.5x5) that secure the right display hinge of the display assembly to the system board.
2. Open the right display hinge at an angle of 90 degrees.
3. Remove the three screws (M2.5x5) that secure the left display hinge to the system board.
4. Open the left display hinge at an angle of 90 degrees.
5. Peel the clear adhesive tape.
6. Open the latch and disconnect the display cable from the system board.
7. Remove the display cable from the routing guides on the palm-rest and keyboard assembly.
8. Gently lift the palm-rest and keyboard assembly off the display assembly.

# Installing the display assembly

## Prerequisites

If you are replacing a component, remove the existing component before performing the installation process.

## About this task

The following image(s) indicate the location of the display assembly and provides a visual representation of the installation procedure.



5x  
M2.5x5

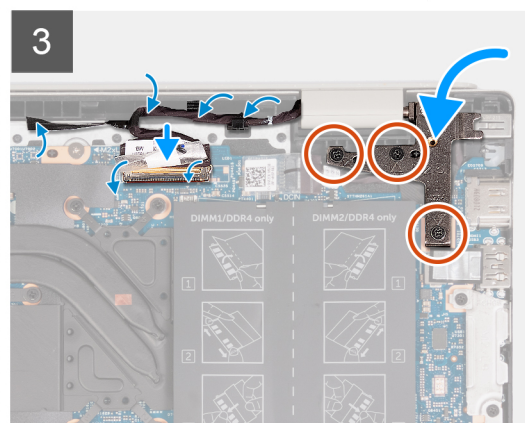
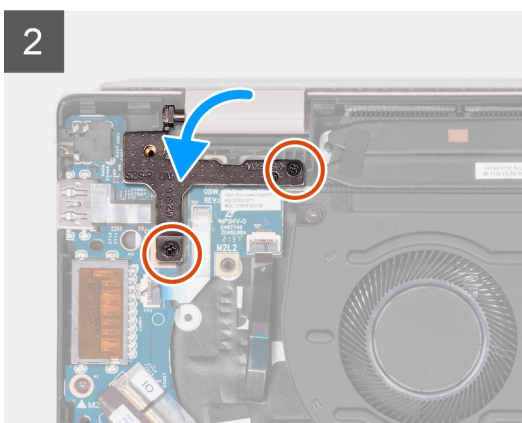
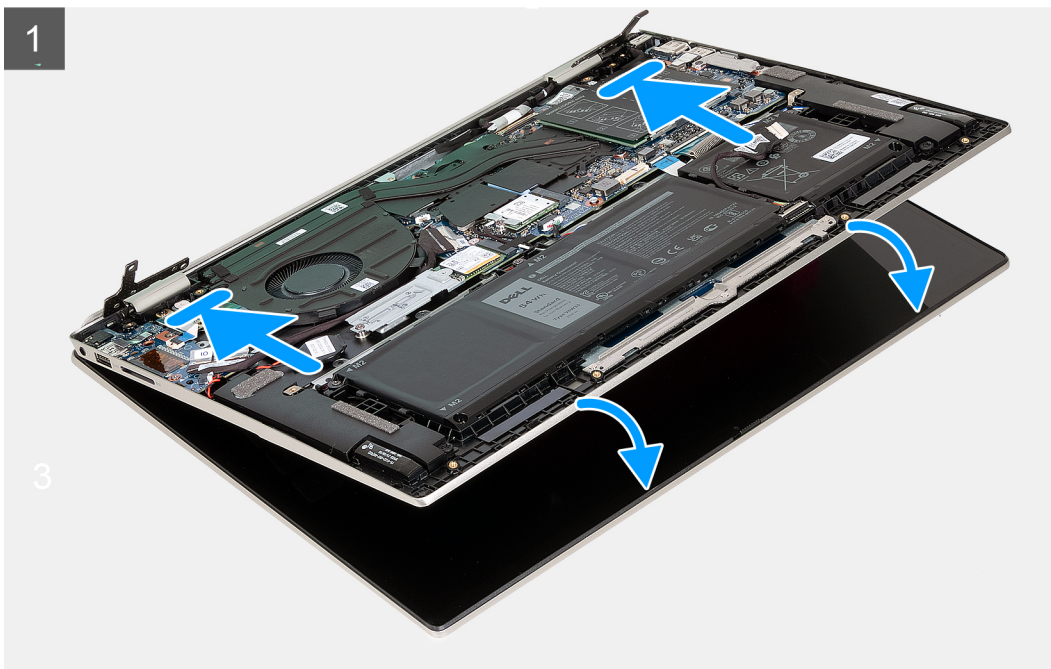
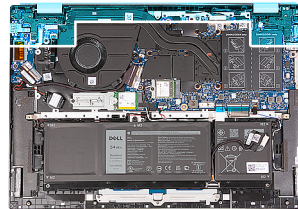

## Steps

1. Place the display assembly on a clean and flat surface with the display panel facing up.
2. Gently place the palm-rest and keyboard assembly under the display hinges.
3. Close the left display hinge and align the screw holes on the left display hinge with the screw holes on the system board.



4. Replace the three screws (M2.5x5) that secure the left display hinge to the palm-rest and keyboard assembly.
5. Close the right display hinge and align the screw holes on the right display hinge with the screw holes on the system board.
6. Replace the three screws (M2.5x5) that secure the right display hinge to the palm-rest and keyboard assembly.
7. Replace the display cable to the routing guides on the palm-rest and keyboard assembly.
8. Connect the display cable to the connector on the system board.
9. Close the latch and replace the clear adhesive tape.

#### Next steps

1. Install the [base cover](#).
2. Follow the procedure in [After working inside your computer](#).

## I/O board

### Removing the I/O board

#### Prerequisites

1. Follow the procedure in [Before working inside your computer](#).
2. Remove the [base cover](#).
3. Remove the [3-cell battery](#) or [4-cell battery](#), whichever is applicable.

#### About this task

The following image(s) indicate the location of the I/O board and provides a visual representation of the removal procedure.

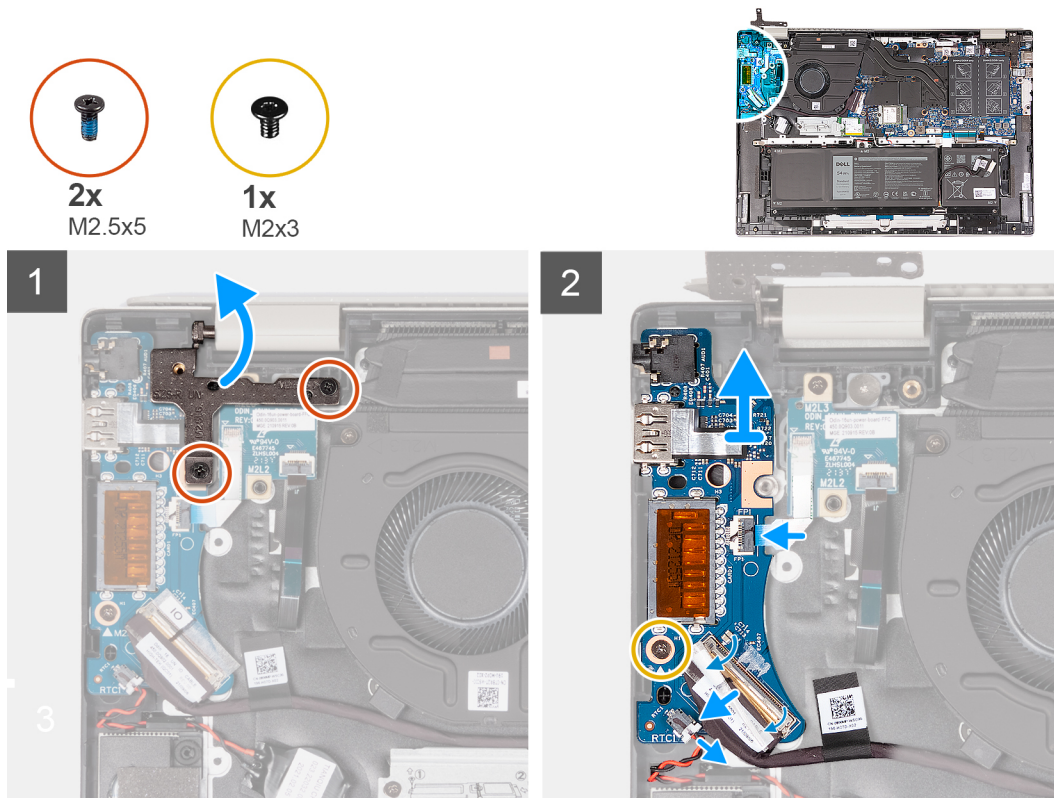

#### Steps

1. Remove the two screws (M2.5x5) that secure the right-display hinge of the display assembly to the system board.
2. Open the right-display hinge at an angle of 90 degrees.
3. Peel the clear adhesive tape and lift the latch of the I/O-board cable.

4. Disconnect the I/O board cable from the I/O board.
5. Disconnect the coin-cell battery cable from the I/O board.
6. Lift the fingerprint-reader cable connector latch and disconnect the optional fingerprint-reader cable from the I/O board.
7. Remove the screw (M2x3) that secures the I/O board to the palm-rest and keyboard assembly.
8. Lift the I/O board off the palm-rest and keyboard assembly.

## Installing the I/O board

### Prerequisites

If you are replacing a component, remove the existing component before performing the installation process.

### About this task

The following image(s) indicate the location of the I/O board and provides a visual representation of the installation procedure.

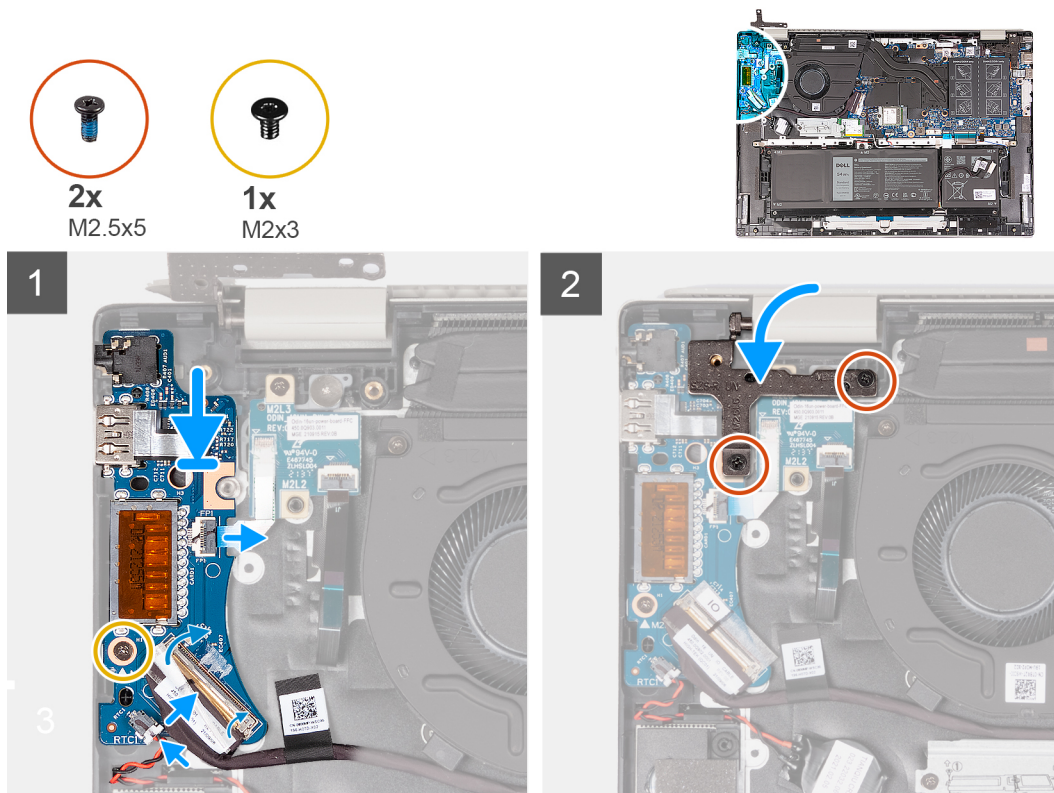

### Steps

1. Align the screw holes on the I/O board with the screw holes on the system board and palm-rest and keyboard assembly.
2. Align the ports on the I/O board to the slots on the palm-rest and keyboard assembly.
3. Place the I/O board on the palm-rest and keyboard assembly.
4. Replace the two screws (M2x3) that secure the I/O board to the palm-rest and keyboard assembly.
5. Connect the I/O board cable to the I/O board.
6. Close the latch and replace the clear adhesive tape.
7. Connect the coin-cell battery cable to the I/O board.
8. Connect the optional fingerprint-reader cable to the I/O board and close the latch to secure the cable.
9. Close the right-display hinge.
10. Replace the two screws (M2.5x5) that secure the right-display hinge of the display assembly to the system board.

### Next steps

1. Install the [3-cell battery](#) or [4-cell battery](#), whichever is applicable.

2. Install the [base cover](#).
3. Follow the procedure in [After working inside your computer](#).

# Touchpad

## Removing the touchpad

### Prerequisites

1. Follow the procedure in [Before working inside your computer](#).
2. Remove the [base cover](#).
3. Remove the [3-cell battery](#) or [4-cell battery](#), whichever is applicable.

### About this task

The following image(s) indicate the location of the touchpad and provides a visual representation of the removal procedure.

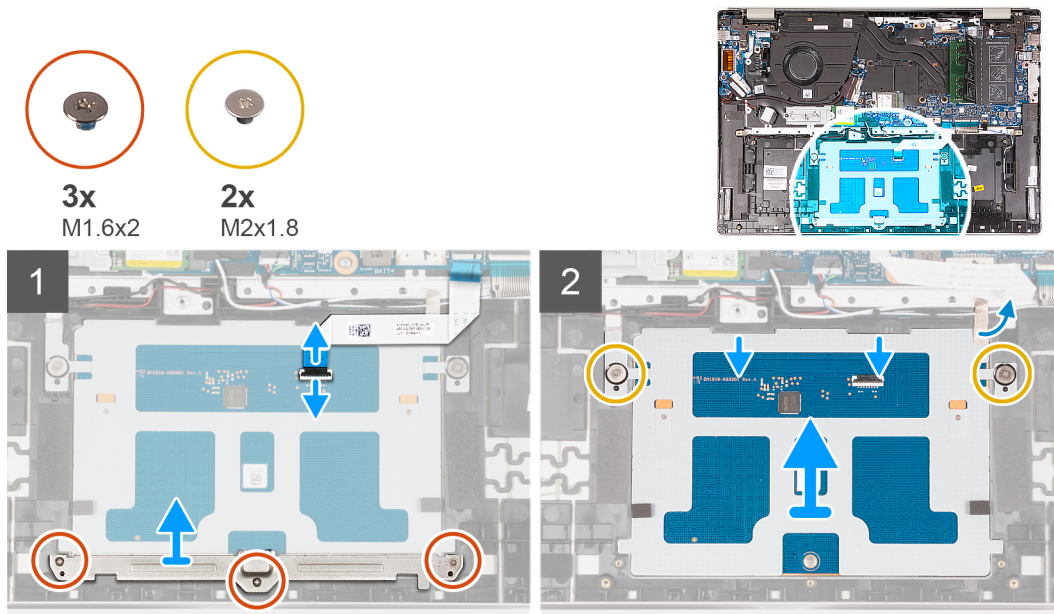

### Steps

1. Open the latch of the touchpad connector on the system board and disconnect the touchpad cable from the system board.
2. Open the latch of the touchpad connector on the touchpad and disconnect the touchpad cable from the touchpad.
3. Peel off the adhesive tape from the touchpad bracket.
4. Remove the three screws (M1.6x2) that secure the touchpad bracket to the palm-rest and keyboard assembly.
5. Lift the touchpad bracket off the palm-rest and keyboard assembly.
6. Remove the two screws (M2x1.8) that secure the touchpad to the palm-rest and keyboard assembly.
7. Lift the touchpad slightly off the palm-rest and keyboard assembly.
8. Slide the touchpad down and lift it off the palm-rest and keyboard assembly.

## Installing the touchpad

### Prerequisites

If you are replacing a component, remove the existing component before performing the installation process.

### About this task

The following image(s) indicate the location of the touchpad and provides a visual representation of the installation procedure.

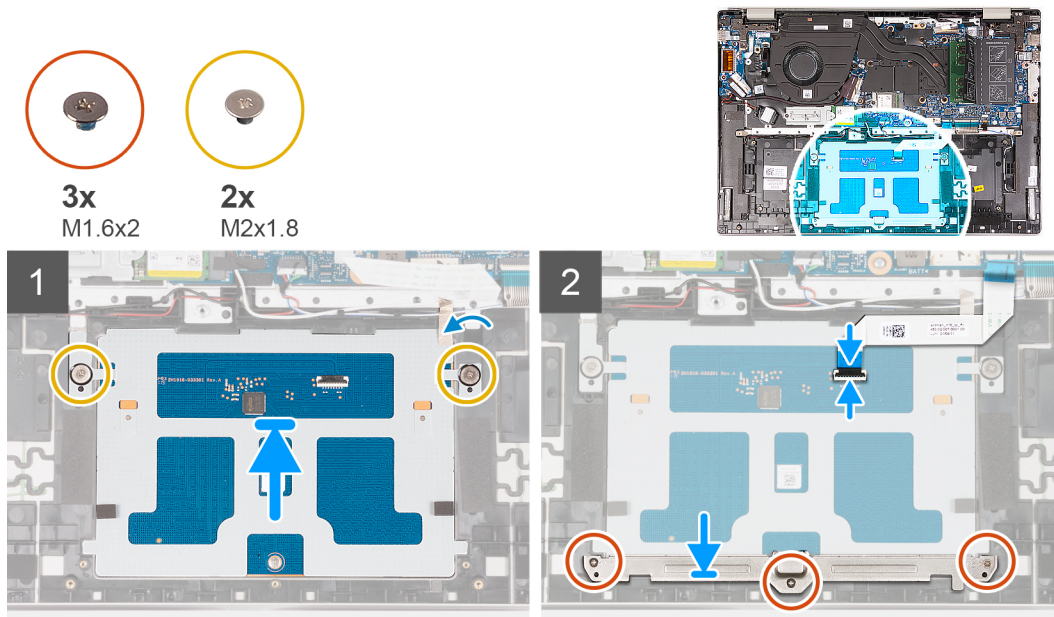

### Steps

1. Slide the touchpad onto the palm-rest and keyboard assembly.
2. Replace the two screws (M2x1.8) that secure the touchpad to the palm-rest and keyboard assembly.
3. Align the touchpad bracket and place it on the palm-rest and keyboard assembly.
4. Replace the three screws (M1.6x2) that secure the touchpad bracket to the palm-rest and keyboard assembly.
5. Adhere the adhesive tape to the touchpad bracket.
6. Open the latch of the touchpad connector on the touchpad and connect the touchpad cable to the touchpad.
7. Open the latch of the touchpad connector on the system board and connect the touchpad cable to the system board.

### Next steps

1. Install the [M.2 2230 solid-state drive](#) or [M.2 2280 solid-state drive](#), whichever is applicable.
2. Install the [base cover](#).
3. Follow the procedure in [After working inside your computer](#).

## Speakers

### Removing the speakers

#### Prerequisites

1. Follow the procedure in [Before working inside your computer](#).
2. Remove the [base cover](#).

#### About this task

**NOTE:** The wireless-card antennas are attached to the speakers as an assembly and cannot be separated for individual replacement. Services will replace the speakers and the wireless antennas as an assembly part.

The following image(s) indicate the location of the speakers and provides a visual representation of the removal procedure.



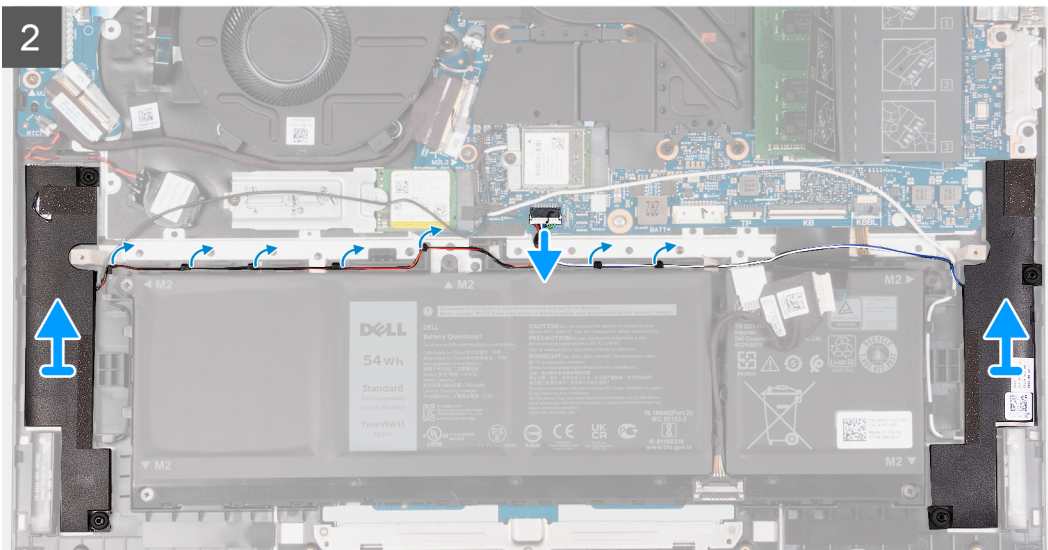
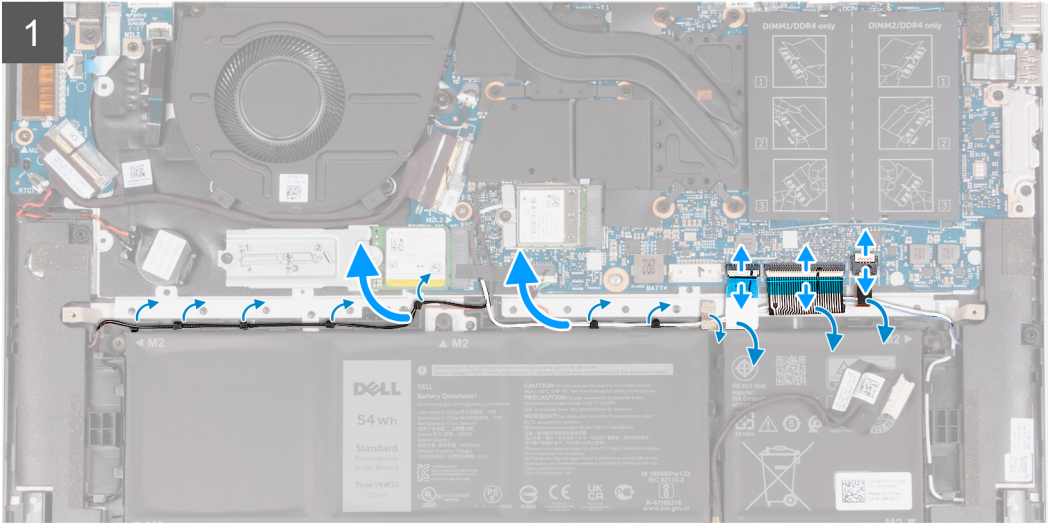
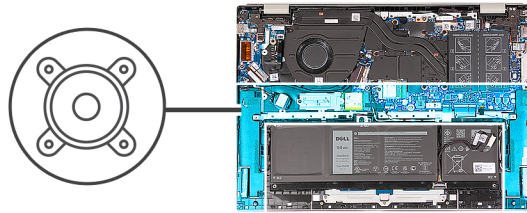

### Steps

1. Release the latch of the keyboard backlit connector on the system board and disconnect the keyboard backlit cable.
2. Release the latch of the keyboard connector on the system board and disconnect the keyboard cable.
3. Release the latch of the touchpad connector on the system board and disconnect the touchpad cable.
4. Remove the speakers cable from the routing guides on the palm-rest and keyboard assembly.
5. Disconnect the speaker cable.
6. Lift the speakers along with their cables off the palm-rest and keyboard assembly.

## Installing the speakers

### Prerequisites

If you are replacing a component, remove the existing component before performing the installation process.



## About this task

**NOTE:** If either the system board or the heat sink is replaced, use the thermal grease provided in the kit to ensure that thermal conductivity is achieved.

The following image(s) indicate the location of the speakers and provides a visual representation of the installation procedure.

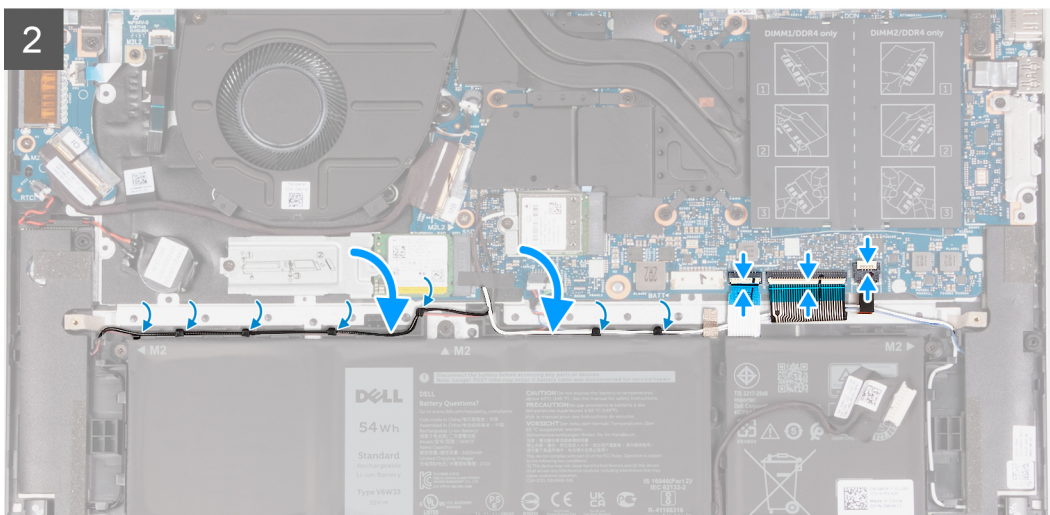
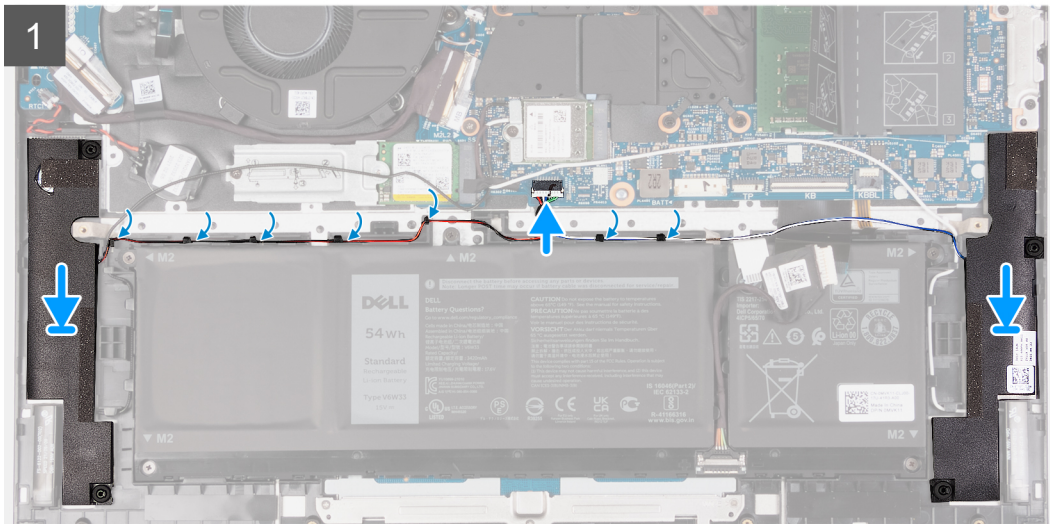
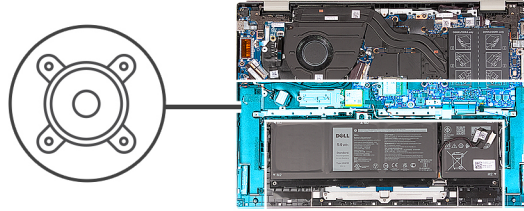

## Steps

1. Using the alignment posts, place the left and right speakers on the palm-rest and keyboard assembly.
2. Route the speaker cable through the routing guides on the palm-rest and keyboard assembly.
3. Adhere the tapes that secure the speaker cable to the palm-rest and keyboard assembly.
4. Connect the touchpad cable and close the latch of the touchpad connector on the system board.
5. Connect the keyboard cable and close the latch of the keyboard connector on the system board.
6. Connect the keyboard backlit cable and close the latch of the keyboard backlit connector on the system board.

### Next steps

1. Install the [base cover](#).
2. Follow the procedure in [After working inside your computer](#).

## System board

### Removing the system board

#### Prerequisites

1. Follow the procedure in [Before working inside your computer](#).
2. Remove the [base cover](#).
3. Remove the [memory module](#).
4. Remove the [M.2 2230 solid-state drive](#) or [M.2 2280 solid-state drive](#), whichever is applicable.
5. Remove the [wireless card](#).
6. Remove the [heatsink](#).

#### About this task

The following image(s) indicate the location of the system board and provides a visual representation of the removal procedure.

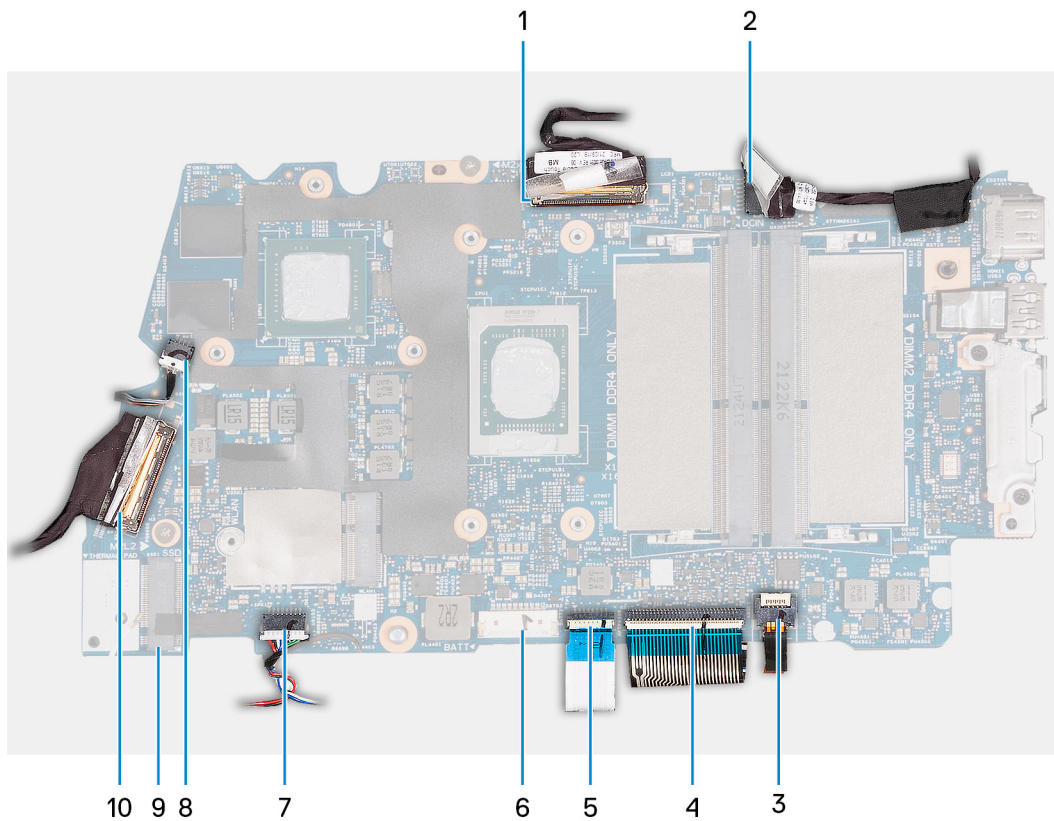

1. Display-cable connector
2. Power-cable connector
3. Keyboard backlight-cable connector
4. Keyboard-cable connector
5. Touchpad-cable connector
6. Battery-cable connector
7. Speaker-cable connector
8. System fan-cable connector
9. SSD-1 slot connector



## 10. I/O board-cable connector

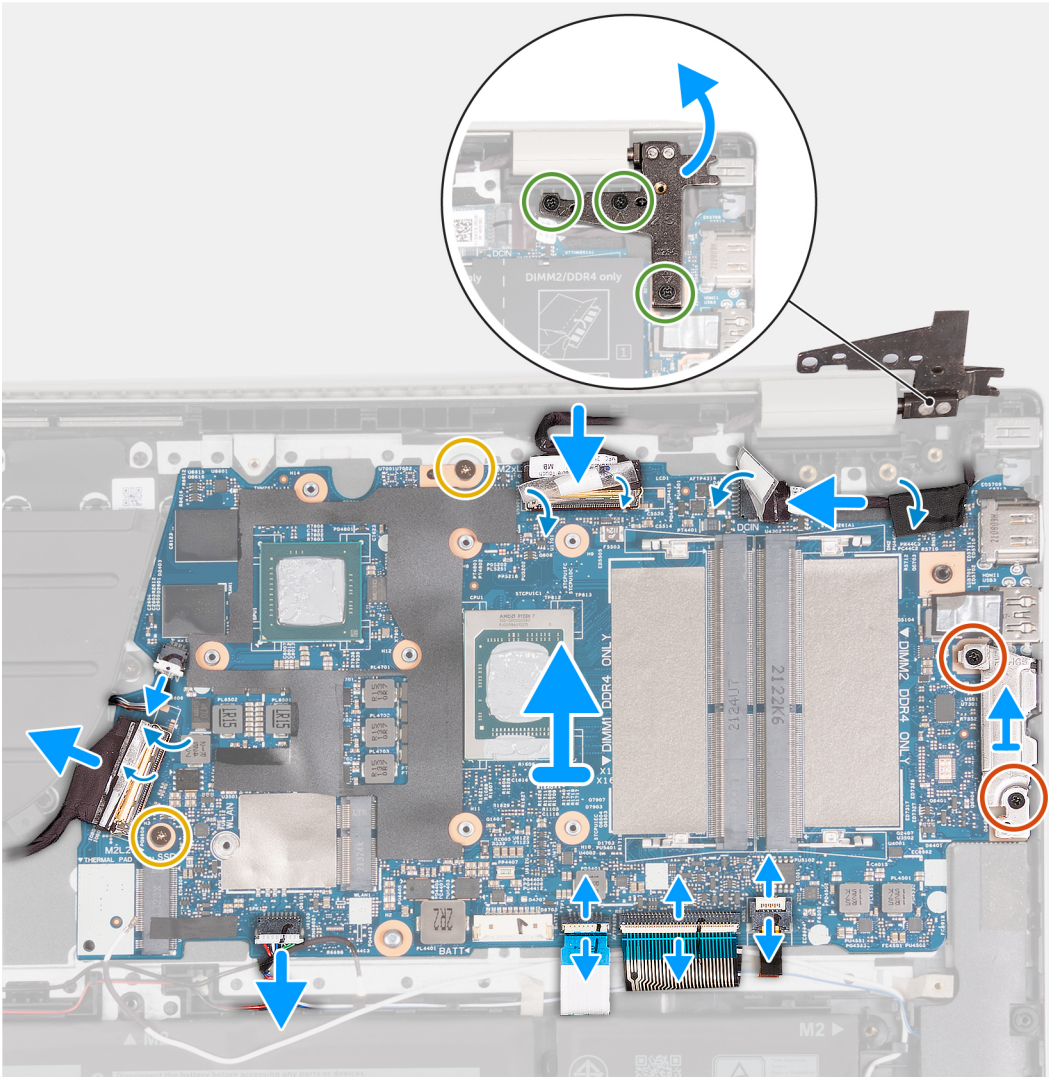

### Steps

1. Remove the three screws (M2.5x5) that secure the right display hinge to the system board.
2. Open the right display hinge at an angle of 90 degrees.
3. Peel the clear adhesive tape of the display cable connector.
4. Open the latch and disconnect the display cable from the system board.
5. Peel the adhesive tape and disconnect the power-adapter port cable from the system board.
6. Peel off the adhesive tape that secures the power-adapter port cable to the system board.
7. Remove the two screws (M2x4) that secure the Type-C port bracket to the system board.
8. Lift the Type-C port-bracket off the system board.
9. Release the latch of the keyboard backlit connector on the system board and disconnect the keyboard backlit cable.
10. Release the latch of the keyboard connector on the system board and disconnect the keyboard cable.

11. Release the latch of the touchpad connector on the system board and disconnect the touchpad cable.
12. Peel the clear adhesive tape to lift the latch of the I/O board connector and disconnect the I/O board connector from the system board.
13. Disconnect the fan cable from the system board.
14. Remove the two screws (M2x1.8) that secure the system board to the palm-rest and keyboard assembly.
15. Lift the system board at angle off the palm-rest and keyboard assembly, to clear the ports from the port openings.

## Installing the system board

### Prerequisites

If you are replacing a component, remove the existing component before performing the installation process.

### About this task

The following image(s) indicate the location of the system board and provides a visual representation of the installation procedure.



2x  
M2x4



2x  
M2x1.8



3x  
M2.5x5

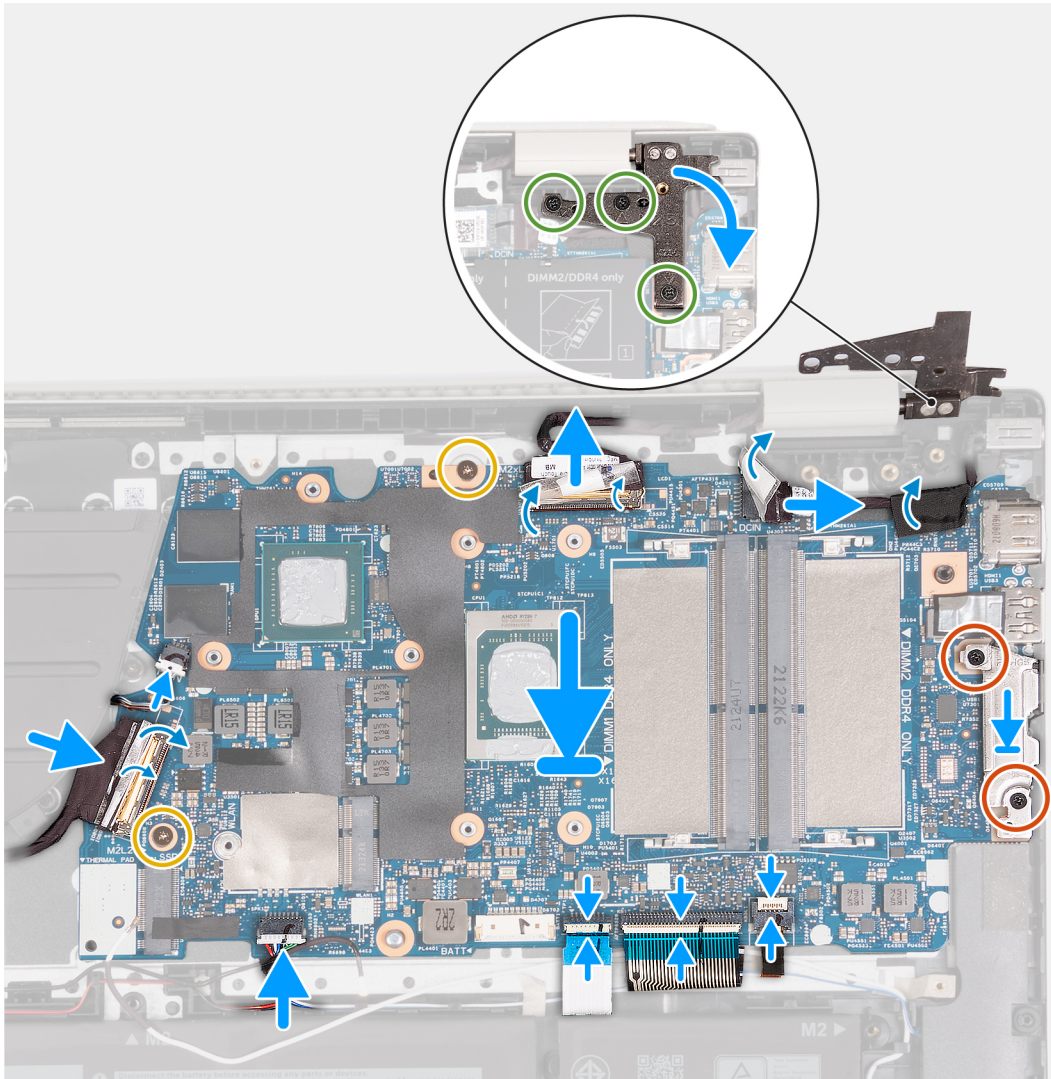
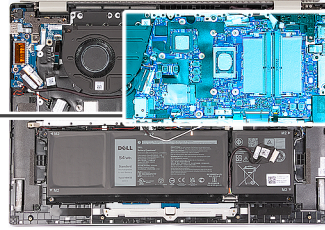

### Steps

1. Install the system board at an angle and ensure that the ports are properly aligned with the port openings.
2. Place the system board on the palm-rest and keyboard assembly.
3. Align the screw holes on the system board with the screw holes on the palm-rest and keyboard assembly.
4. Replace the two screws (M2x1.8) that secure the system board to the palm-rest and keyboard assembly.
5. Connect the fan cable to the system board.
6. Connect the I/O board cable to the system board, close the latch of the I/O board connector, and replace the clear adhesive tape on the cable.
7. Connect the touchpad cable to the touchpad connector on the system board and close the latch.
8. Connect the keyboard cable to the keyboard connector on the system board and close the latch.
9. Connect the keyboard backlit cable to the keyboard backlit connector on the system board and close the latch.
10. Align the screw holes of the Type-C port-bracket with the screw holes of the system board.
11. Place the Type-C port-bracket on the system board.



12. Replace the two screws (M2x4) that secure the Type-C port-bracket to the system board.
13. Connect the power-adapter port cable to the system board and replace the adhesive tape on the cable.
14. Connect the display cable to the system board, close the latch of the display cable connector and replace the clear adhesive tape on the display cable connector.
15. Close the right display hinge and align the screw holes on the right display hinge with the screw holes on the system board.
16. Replace the three screws (M2.5x5) that secure the right display hinge to the palm-rest and keyboard assembly.

### Next steps

1. Install the [heatsink](#).
2. Install the [wireless card](#).
3. Install the [M.2 2230 solid-state drive](#) or [M.2 2280 solid-state drive](#), whichever is applicable.
4. Install the [memory module](#).
5. Install the [base cover](#).
6. Follow the procedure in [After working inside your computer](#).

## Power-button board

### Removing the power-button board

#### Prerequisites

1. Follow the procedure in [Before working inside your computer](#).
2. Remove the [base cover](#).

#### About this task

The following image(s) indicate the location of the power-button board and provides a visual representation of the removal procedure.

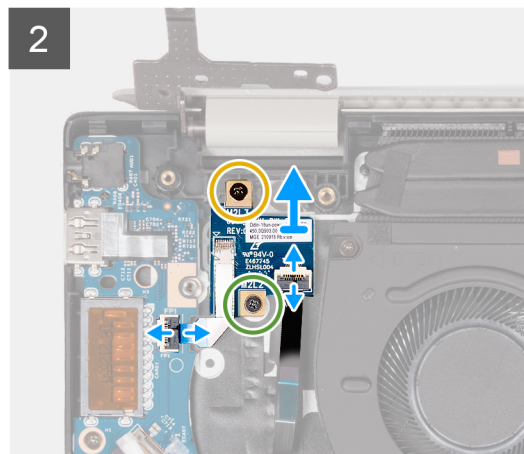
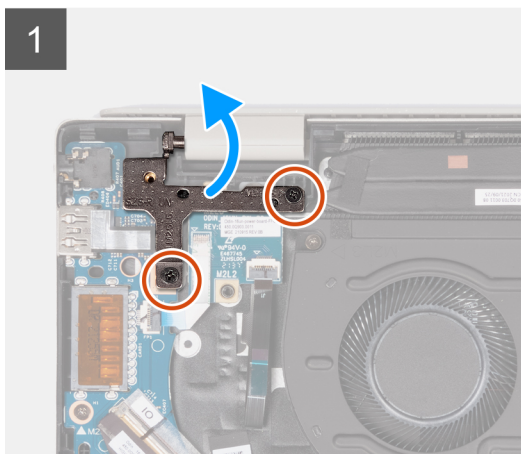
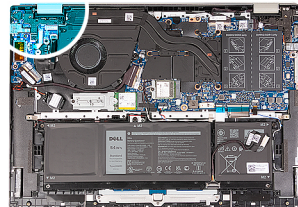
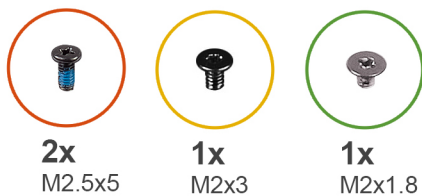

#### Steps

1. Remove the two screws (M2.5x5) that secure the right display hinge of the display assembly to the system board.
2. Open the right display hinge at an angle of 90 degrees.

3. Lift the fingerprint-reader cable connector latch and disconnect the optional fingerprint-reader cable from the I/O board.
4. Lift the latch of the power-button connector on the power-button board and disconnect the power-button cable from the power-button board.
5. Remove the screw (M2x3) that secures the power-button board to the palm-rest and keyboard assembly.
6. Remove the screw (M2x2) that secures the power-button board to the palm-rest and keyboard assembly.
7. Lift the power-button board from the palm-rest and keyboard assembly.

## Installing the power-button board

### Prerequisites

If you are replacing a component, remove the existing component before performing the installation process.

### About this task

The following image(s) indicate the location of the power-button board and provides a visual representation of the installation procedure.

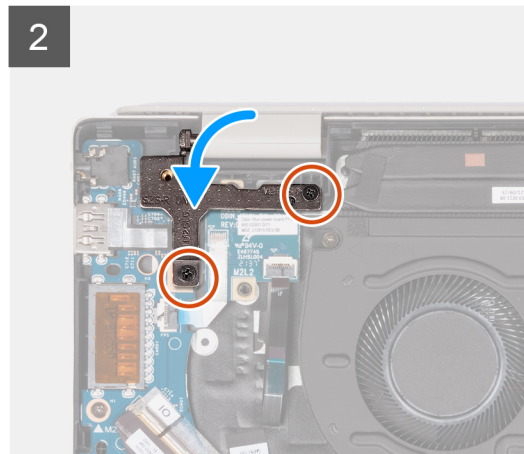
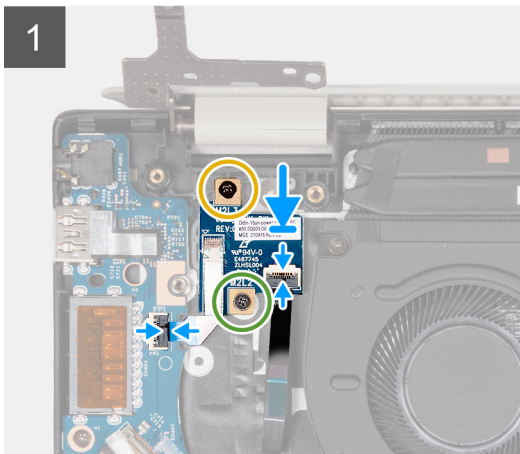
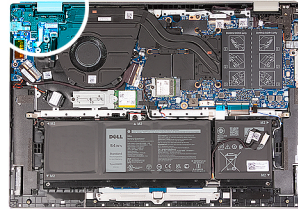
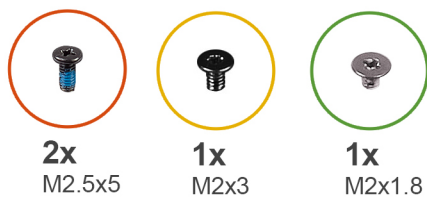

### Steps

1. Align the screw hole of the power-button board with the corresponding screw hole of the palm-rest and keyboard assembly.
2. Place the power-button board on the palm-rest and keyboard assembly.
3. Replace the screw (M2x3) that secures the power-button board to the palm-rest and keyboard assembly.
4. Replace the screw (M2x2) that secures the power-button board to the palm-rest and keyboard assembly.
5. Connect the optional fingerprint-reader cable to the I/O board and close the latch to secure the cable.
6. Connect the power-button cable to the power-button board and close the latch of the power-button connector on the power-button board.
7. Push the right display hinge down.
8. Replace the two screws (M2.5x5) that secure the right display hinge of the display assembly to the system board.

### Next steps

1. Install the [base cover](#).
2. Follow the procedure in [After working inside your computer](#).

# Power button with optional fingerprint reader

## Removing the power button with optional fingerprint reader

### Prerequisites

1. Follow the procedure in [Before working inside your computer](#).
2. Remove the [base cover](#).
3. Remove the [power-button board](#).

### About this task

The following image(s) indicate the location of the power button and provides a visual representation of the removal procedure.



1x  
M2x3

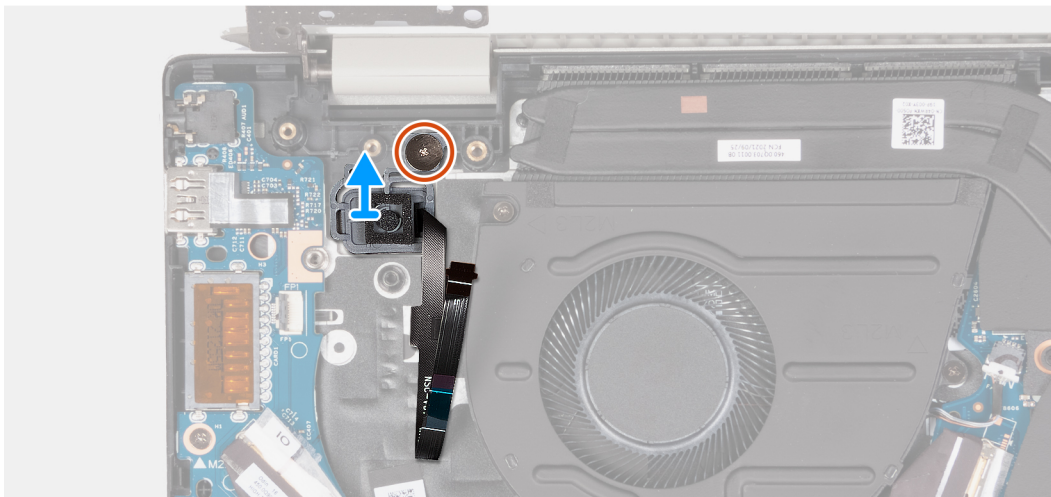
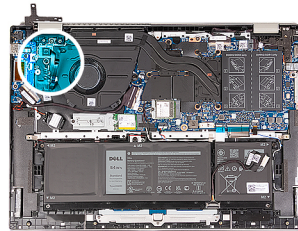

### Steps

1. Peel the adhesive tape that secures the power-button cable.
2. Remove the screw (M2x3) that secures the power button to the palm-rest and keyboard assembly.
3. Lift the power button from the palm-rest and keyboard assembly.

## Installing the power button with optional fingerprint reader

### Prerequisites

If you are replacing a component, remove the existing component before performing the installation process.

### About this task

The following image(s) indicate the location of the power button and provides a visual representation of the installation procedure.



1x  
M2x3

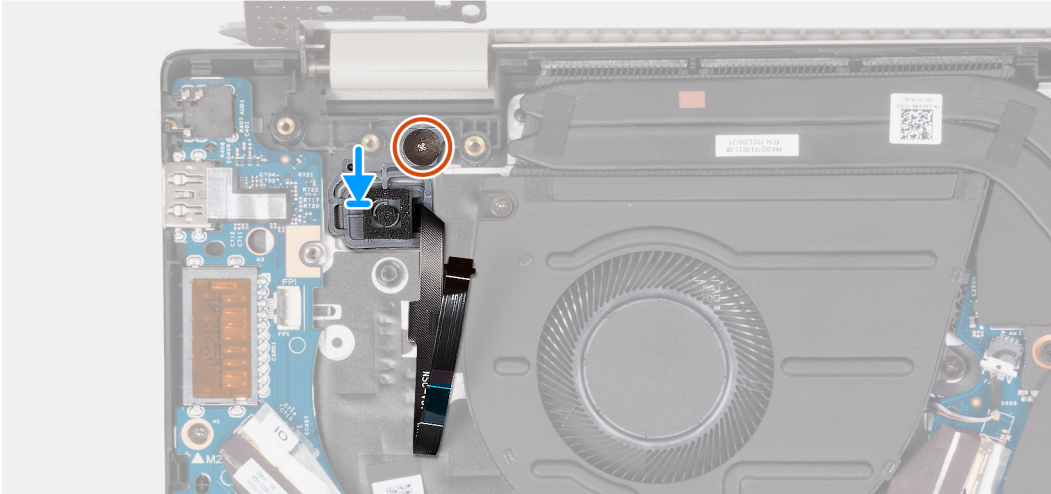
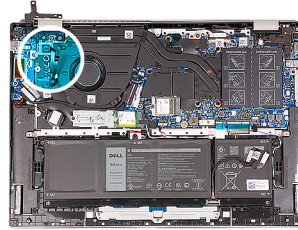

### Steps

1. Align the screw hole on the power button with the screw hole on the palm-rest and keyboard assembly.
2. Place the power button on the palm-rest and keyboard assembly.
3. Replace the screw (M2x3) that secures the power button to the palm-rest and keyboard assembly.
4. Replace the adhesive tape that secures the power-button cable to the palm-rest and keyboard assembly.

### Next steps

1. Install the [power-button board](#).
2. Install the [base cover](#).
3. Follow the procedure in [After working inside your computer](#).

## Power-adapter port

### Removing the power-adapter port

#### Prerequisites

1. Follow the procedure in [Before working inside your computer](#).
2. Remove the [base cover](#).

#### About this task

The following image(s) indicate the location of the power-adapter port and provides a visual representation of the removal procedure.





**3x**  
M2.5x5

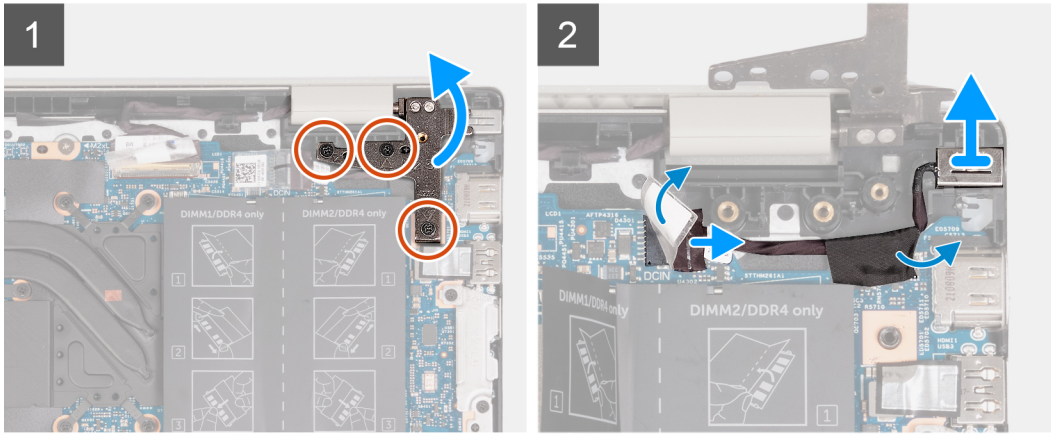
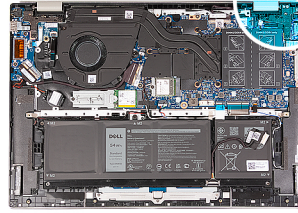

### Steps

1. Remove the three screws (M2.5x5) that secure the left display hinge to the system board.
2. Open the left display hinge at an angle of 90 degrees.
3. Peel the adhesive tape and disconnect the power-adapter port cable from the system board.
4. Peel the adhesive tape that secures the power-adapter port cable to the system board.
5. Lift the power-adapter port and the cable off the palm-rest and keyboard assembly.

## Installing the power-adapter port

### Prerequisites

If you are replacing a component, remove the existing component before performing the installation process.

### About this task

The following image(s) indicate the location of the power-adapter port and provides a visual representation of the installation procedure.



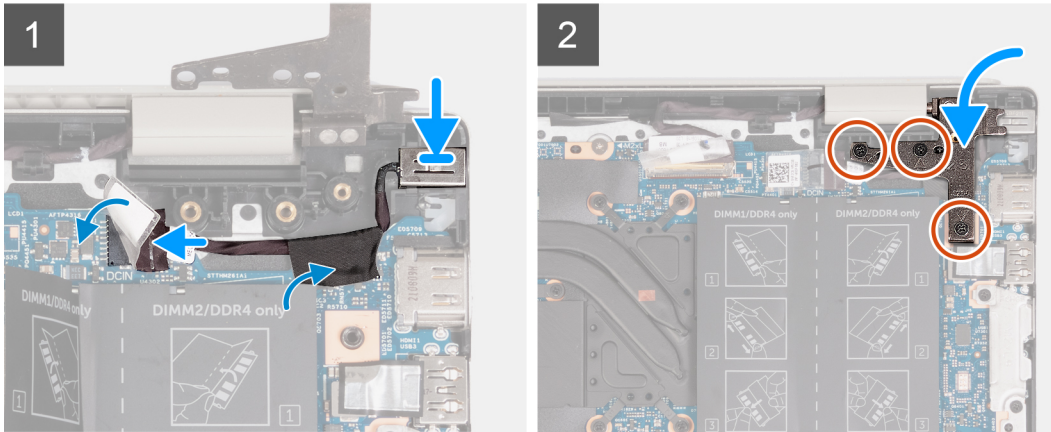
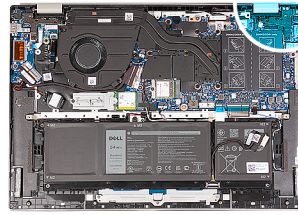

### Steps

1. Place the power-adapter port into the slot on the palm-rest and keyboard assembly.
2. Adhere the tape that secures the power-adapter port cable to the system board.
3. Connect the power-adapter port cable to the system board.
4. Adhere the tape that covers the power-adapter port connector on the system board.
5. Close the left display hinge and align the screw holes on the left display hinge with the screw holes on the system board.
6. Replace the three screws (M2.5x5) that secures the left display hinge to the system board.

### Next steps

1. Install the [base cover](#).
2. Follow the procedure in [After working inside your computer](#).

## Palm-rest and keyboard assembly

### Removing the palm-rest and keyboard assembly

#### Prerequisites

1. Follow the procedure in [Before working inside your computer](#).
2. Remove the [base cover](#).
3. Remove the [memory module](#).
4. Remove the [M.2 2230 solid-state drive](#) or [M.2 2280 solid-state drive](#), whichever is applicable.
5. Remove the [wireless card](#).
6. Remove the [3-cell battery](#) or [4-cell battery](#), whichever is applicable.
7. Remove the [display assembly](#).
8. Remove the [fan](#).
9. Remove the [coin-cell battery](#).
10. Remove the [I/O board](#).
11. Remove the [power button](#).
12. Remove the [power-button board](#).
13. Remove the [power-adapter port](#).

14. Remove the [system board](#).
15. Remove the [speakers](#).
16. Remove the [touchpad](#).

### About this task

The following image(s) indicate the location of the palm-rest and keyboard assembly and provides a visual representation of the removal procedure.

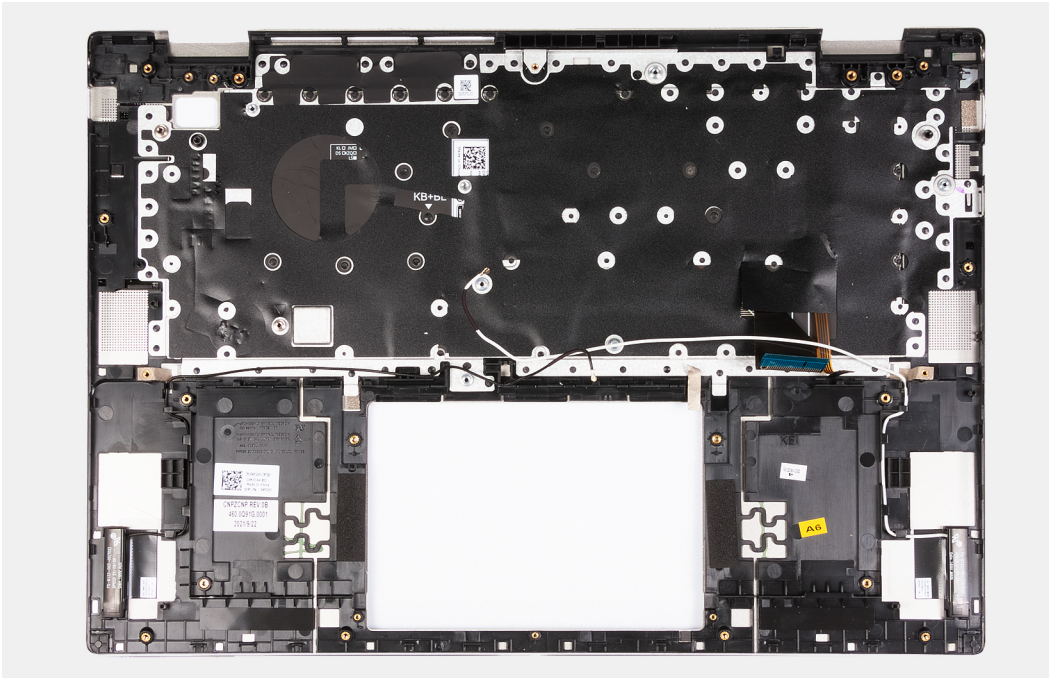

### Steps

After performing the pre-requisites, you are left with the palm-rest and keyboard assembly.

**NOTE:** The palm-rest and keyboard assembly includes the following components:

- Palm rest
- Keyboard
- Wireless antenna (2)

## Installing the palm-rest and keyboard assembly

### Prerequisites

If you are replacing a component, remove the existing component before performing the installation process.

### About this task

The following image(s) indicate the location of the palm-rest and keyboard assembly and provides a visual representation of the installation procedure.

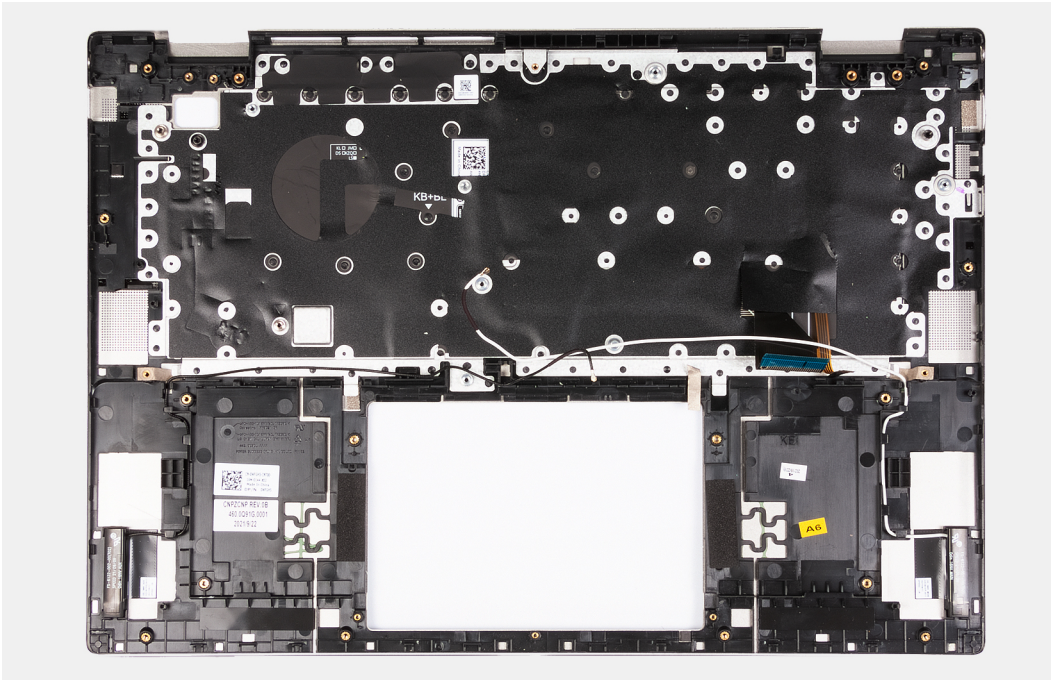

## Steps

Place the palm-rest and keyboard assembly on a flat and clean surface and perform the post-requisites to install the palm-rest and keyboard assembly.

**i** **NOTE:** The palm-rest and keyboard assembly includes the following components:

- Palm rest
- Keyboard
- Wireless antenna (2)

## Next steps

1. Install the [touchpad](#).
2. Install the [speakers](#).
3. Install the [system board](#).
4. Install the [power-adapter port](#).
5. Install the [power-button board](#).
6. Install the [power button](#).
7. Install the [I/O board](#).
8. Install the [coin-cell battery](#).
9. Install the [fan](#).
10. Install the [display assembly](#).
11. Install the [3-cell battery](#) or [4-cell battery](#), whichever is applicable.
12. Install the [wireless card](#).
13. Install the [M.2 2230 solid-state drive](#) or [M.2 2280 solid-state drive](#), whichever is applicable.
14. Install the [memory module](#).
15. Install the [base cover](#).
16. Follow the procedure in [After working inside your computer](#).

## Drivers and downloads

When troubleshooting, downloading or installing drivers it is recommended that you read the Dell Knowledge Based article, Drivers and Downloads FAQ [000123347](#).



# BIOS setup

**CAUTION:** Unless you are an expert computer user, do not change the settings in the BIOS Setup program. Certain changes can make your computer work incorrectly.

**NOTE:** Depending on the computer and its installed devices, the items listed in this section may or may not be displayed.

**NOTE:** Before you change BIOS Setup program, it is recommended that you write down the BIOS Setup program screen information for future reference.

Use the BIOS Setup program for the following purposes:

- Get information about the hardware installed in your computer, such as the amount of RAM and the size of the hard drive.
- Change the system configuration information.
- Set or change a user-selectable option, such as the user password, type of hard drive installed, and enabling or disabling base devices.

## BIOS overview

The BIOS manages data flow between the computer's operating system and attached devices such as hard disk, video adapter, keyboard, mouse, and printer.

## Entering BIOS setup program

### Steps

1. Turn on your computer.
2. Press F2 immediately to enter the BIOS setup program.

**NOTE:** If you wait too long and the operating system logo appears, continue to wait until you see the desktop. Then, turn off your computer and try again.

## Navigation keys

**NOTE:** For most of the System Setup options, changes that you make are recorded but do not take effect until you restart the system.

**Table 3. Navigation keys**

Keys	Navigation
Up arrow	Moves to the previous field.
Down arrow	Moves to the next field.
Enter	Selects a value in the selected field (if applicable) or follow the link in the field.
Spacebar	Expands or collapses a drop-down list, if applicable.
Tab	Moves to the next focus area. <b>NOTE:</b> For the standard graphics browser only.

**Table 3. Navigation keys (continued)**

Keys	Navigation
Esc	Moves to the previous page until you view the main screen. Pressing Esc in the main screen displays a message that prompts you to save any unsaved changes and restarts the system.

## One time boot menu

To enter **one time boot menu**, turn on your computer, and then press F12 immediately.

**NOTE:** It is recommended to shutdown the computer if it is on.

The one-time boot menu displays the devices that you can boot from including the diagnostic option. The boot menu options are:

- Removable Drive (if available)
- STXXXX Drive (if available)
  - NOTE:** XXX denotes the SATA drive number.
- Optical Drive (if available)
- SATA Hard Drive (if available)
- Diagnostics

The boot sequence screen also displays the option to access the System Setup screen.

## System setup options

**NOTE:** Depending on this computer and its installed devices, the items that are listed in this section may or may not be displayed.

**Table 4. System setup options—Main menu**

Main	
<b>System Time</b>	Displays the current system time of the computer in HH/MM/SS format.
<b>System Date</b>	Displays the ownership date of the computer in MM/DD/YYYY format.
<b>BIOS Version</b>	Displays the BIOS version of the computer.
<b>Product Name</b>	Displays the system model name of the computer.
<b>Service Tag</b>	Displays the service tag of the computer.
<b>Asset Tag</b>	Displays the asset tag of the computer.
<b>CPU Type</b>	Displays the processor type.
<b>CPU Speed</b>	Displays the maximum processor clock speed.
<b>CPU ID</b>	Displays the processor identification code.
<b>CPU Cache</b>	
<b>L1 Cache</b>	Displays the processor L1 Cache size.
<b>L2 Cache</b>	Displays the processor L2 Cache size.
<b>L3 Cache</b>	Displays the processor L3 Cache size.
<b>M.2 PCIe SSD</b>	Displays the PCIe SSD information connected to the M.2 slot.
<b>AC Adapter Type</b>	Displays whether an AC adapter is installed.
<b>System Memory</b>	Displays the total computer memory installed.
<b>Memory Speed</b>	Displays the memory speed.

**Table 4. System setup options—Main menu (continued)**

Main	
<b>Keyboard Type</b>	Displays the type of the keyboard (option could be backlit or non-backlit).

**Table 5. System setup options—Advance menu**

Advance	
<b>Multi-Cores Support</b>	Displays the support status for multi-cores.
<b>Virtualization</b>	Specify whether a Virtual Machine Monitor (VMM) can utilize the additional hardware capabilities provided by Onboard Virtualization Technology. Options are: <ul style="list-style-type: none"> <li>● Enabled (Default)</li> <li>● Disabled</li> </ul>
<b>VT for Direct I/O</b>	
<b>SATA Operation</b>	Allows to select the SATA mode of the computer. Option is set to AHCI.
<b>Adapter Warnings</b>	Displays Adapter Warning during the POST when Battery Level is Critically low. Options are: <ul style="list-style-type: none"> <li>● Enabled (Default)</li> <li>● Disabled</li> </ul>
<b>Function Key Behavior</b>	Allows to reverse Function Key Primary behavior with secondary. Options are: <ul style="list-style-type: none"> <li>● Multimedia Key(Default)</li> <li>● Function Key</li> </ul>
<b>Battery Health</b>	Shows Battery Health and Charge Status.
<b>Camera</b>	Allows to Switch-on/switch-off the Camera. Options are: <ul style="list-style-type: none"> <li>● Enabled (Default)</li> <li>● Disabled</li> </ul>
<b>Battery Charge Configuration</b>	Displays the Battery Charge configuration. Options are: <ul style="list-style-type: none"> <li>● Adaptive (Default)</li> <li>● Standard</li> <li>● ExpressCharge™</li> <li>● Primarily AC Use</li> <li>● Custom</li> </ul>
<b>Advanced Battery Charge Configuration</b>	Displays the Advanced Charge configuration. Options are: <ul style="list-style-type: none"> <li>● Enabled</li> <li>● Disabled (Default)</li> </ul>
<b>IPv4 HTTP Support</b>	Displays the IPv4 support status. Options are: <ul style="list-style-type: none"> <li>● Enabled</li> <li>● Disabled (Default)</li> </ul>
<b>IPv6 HTTP Support</b>	Displays the IPv6 support status. Options are: <ul style="list-style-type: none"> <li>● Enabled</li> <li>● Disabled (Default)</li> </ul>

**Table 5. System setup options—Advance menu (continued)**

<b>Advance</b>	
<b>Power Option</b>	
Power on LID open	Controls the Power function on LID open action. Options are: <ul style="list-style-type: none"> <li>• Enabled (Default)</li> <li>• Disabled</li> </ul>
<b>Maintenance</b>	Maintenance information.
Data Wipe on next boot	Performs Data wipe on next boot. Options are: <ul style="list-style-type: none"> <li>• Disabled (Default)</li> <li>• Enabled</li> </ul>
BIOS Recovery from Hard Drive	Performs reset of firmware to the factory image saved on the secondary storage. Options are: <ul style="list-style-type: none"> <li>• Enabled (Default)</li> <li>• Disabled</li> </ul>
BIOS Auto Recovery	Performs auto firmware reset when corrupted BIOS is detected. Options are: <ul style="list-style-type: none"> <li>• Disabled (Default)</li> <li>• Enabled</li> </ul>
<b>SupportAssist System Resolution</b>	Onboard Diagnostics
Auto OS Recovery Threshold	Performs SupportAssist OS recovery after the set value failed boot attempts. Options are: <ul style="list-style-type: none"> <li>• Off</li> <li>• 1</li> <li>• 2 (Default)</li> <li>• 3</li> </ul>
Support Assist OS Recovery	Enabled Support Assist OS recovery on failed boot attempts. Options are: <ul style="list-style-type: none"> <li>• Disabled</li> <li>• Enabled (Default)</li> </ul>
<b>Keyboard Illumination</b>	Allows to Switch-on/switch-off the Keyboard backlight. Options are: <ul style="list-style-type: none"> <li>• Disable</li> <li>• Dim</li> <li>• Bright (Default)</li> </ul>
<b>Keyboard Backlight with AC</b>	Allows to permanently turn off/turn-on the Keyboard backlight without the AC adapter. Options are from 5 Seconds to 15 Minutes. Default option is set to 1 Minute.
<b>Keyboard Backlight with Battery</b>	Allows to permanently turn off/turn-on the Keyboard backlight without the AC adapter. Options are from 5 Seconds to 15 Minutes. Default option is set to 1 Minute.
<b>External USB Ports</b>	Allows to turn off the External USB ports in the Operating System. Options are: <ul style="list-style-type: none"> <li>• Enabled (Default)</li> <li>• Disabled</li> </ul>
<b>Microphone</b>	Allows to Switch-on/switch-off the microphone. Options are: <ul style="list-style-type: none"> <li>• Enabled (Default)</li> <li>• Disabled</li> </ul>



**Table 5. System setup options—Advance menu (continued)**

<b>Advance</b>	
<b>Internal Bluetooth</b>	Allows to Switch-on/switch-off the Bluetooth. Options are: <ul style="list-style-type: none"> <li>● Enabled (Default)</li> <li>● Disabled</li> </ul>
<b>Internal WLAN</b>	Allows to Switch-on/switch-off the Wireless Card. Options are: <ul style="list-style-type: none"> <li>● Enabled (Default)</li> <li>● Disabled</li> </ul>
<b>Media Card Reader</b>	Allows to enable/disable the Media Card reader. Options are: <ul style="list-style-type: none"> <li>● Enabled (Default)</li> <li>● Disabled</li> </ul>
<b>Fingerprint Reader</b>	Allows to enable/disable the Fingerprint reader. Options are: <ul style="list-style-type: none"> <li>● Enabled (Default)</li> <li>● Disabled</li> </ul>
<b>Boot Disable</b>	Disable the automatic Boot. Options are: <ul style="list-style-type: none"> <li>● Enabled</li> <li>● Disabled (Default)</li> </ul>

**Table 6. System setup options—Security menu**

<b>Security</b>	
Admin Password	Displays the status of the administrator password.
System Password	Displays the status of the computer password.
<b>Asset Tag</b>	Displays and allows to edit the Asset Tag of the computer.
<b>Admin Password</b>	Set, change, or delete the administrator password.
<b>System Password</b>	Set, change, or delete the computer password.
<b>Password Change</b>	Set the status to allow User to set the System Password. The options are: <ul style="list-style-type: none"> <li>● Permitted (Default)</li> <li>● Disabled</li> </ul>
<b>Absolute®</b>	Set the Status of the Absolute Module on the computer. The options are: <ul style="list-style-type: none"> <li>● Activate</li> <li>● Deactivate</li> </ul>
<b>Absolute® Status</b>	Displays the Status of the Absolute Module on the computer. The options are: <ul style="list-style-type: none"> <li>● Disabled</li> <li>● Enabled (Default)</li> <li>● Permanently Disabled</li> </ul>
<b>WINDOWS SMM SECURITY MITIGATIONS TABLE (WSMT)</b>	Set the status to allow User to bypass System Password. The options are: <ul style="list-style-type: none"> <li>● Disable (Default)</li> <li>● Reboot Bypass</li> </ul>
<b>Firmware TPM</b>	Enable or disable TPM 2.0 security options.
<b>TPM Security</b>	TPM 2.0 Security options.

**Table 6. System setup options—Security menu (continued)**

Security	
<b>TPM On</b>	Turn On/Off TPM security option. The options are: <ul style="list-style-type: none"> <li>• On</li> <li>• Off</li> </ul>
<b>PPI Bypass for Enable Commands</b>	Controls the TPM Physical Presence Interface(PPI). When enabled, this setting allows the OS to skip BIOS PPI user prompts when issuing TPM PPI enable and activate commands. The Options are: <ul style="list-style-type: none"> <li>• Enabled</li> <li>• Disabled (Default)</li> </ul>
<b>PPI Bypass for Disable Commands</b>	Controls the TPM Physical Presence Interface(PPI). When enabled, this setting will allow the OS to skip BIOS PPI user prompts when issuing TPM PPI disable and deactivate commands(#2, 4, 7, 9, & 11). The options are: <ul style="list-style-type: none"> <li>• Disabled (Default)</li> <li>• Enabled</li> </ul>
<b>Attestation Enable</b>	Provides for the user to control whether the TPM Endorsement Hierarchy is available to the OS. The options are: <ul style="list-style-type: none"> <li>• Disabled</li> <li>• Enabled (Default)</li> </ul>
<b>Key Storage Enable</b>	Provides for the user to control whether TPM Storage Hierarchy is available to the operating system. The options are: <ul style="list-style-type: none"> <li>• Disabled</li> <li>• Enabled (Default)</li> </ul>
<b>SHA-256</b>	Provides the BIOS and the TPM to use the SHA-256 hash algorithm to extend measurements into the TPM PCRs during BIOS boot. The options are: <ul style="list-style-type: none"> <li>• Disabled</li> <li>• Enabled (Default)</li> </ul>
<b>Clear</b>	Clears the TPM owner information, and returns the TPM to the default state. The options are: <ul style="list-style-type: none"> <li>• Disabled (Default)</li> <li>• Enabled</li> </ul>
<b>PPI Bypass for Clear Commands</b>	Controls the TPM Physical Presence Interface(PPI). When enabled, this setting will allow the OS to skip BIOS PPI user prompts when issuing the Clear command. The options are: <ul style="list-style-type: none"> <li>• Disabled (Default)</li> <li>• Enabled</li> </ul>
<b>TPM Status</b>	Displays the Status of the TPM Module on the computer. The options are: <ul style="list-style-type: none"> <li>• Disabled</li> <li>• Enabled (Default)</li> </ul>
<b>UEFI Firmware Capsule Updates</b>	Enable or disable BIOS updates through UEFI capsule update packages. By default, the option is enabled.
<b>Secure Boot</b>	Ensures the system boots using only to validated boot software.

**Table 7. System setup options—Boot menu**

Boot	
<b>File Browser Add Boot Option</b>	
<b>Windows Boot Manager:</b>	Displays the Default UEFI Boot Path of the computer Operating System and allows to navigate and select the EFI file.
<b>File Browser Del Boot Option</b>	
<b>Windows Boot Manager:</b>	Displays the Dell Boot Path of the Default Boot Option..

**Table 7. System setup options—Boot menu (continued)**

Boot	
<b>UEFI BOOT</b>	
<b>HDD1- Windows Boot Manager</b>	Displays the Device ID of the Secondary Storage of the computer.
<b>UEFI Onboard LAN IPv4</b>	Displays the Device ID of the UEFI enabled Onboard IPv4 LAN controller.
<b>UEFI Onboard LAN IPv6</b>	Displays the Device ID of the UEFI enabled Onboard IPv6 LAN controller.

**Table 8. System setup options—Exit menu**

Exit	
<b>Exit Saving Changes</b>	Exit the System Setup saving the changes made to the Setup Options.
<b>Save Change Without Exit</b>	Save the Changes made to the System Setup and continue the Setup.
<b>Exit Discarding Changes</b>	Exit the System Setup without saving the changes made to the Setup Options.
<b>Load Optional Defaults</b>	Load the Factory Defaults in the System Setup Options.
<b>Discard Changes</b>	Discard any changes made to the System Setup and continue the Setup.

## System and setup password

**Table 9. System and setup password**

Password type	Description
System password	Password that you must enter to log in to your system.
Setup password	Password that you must enter to access and make changes to the BIOS settings of your computer.

You can create a system password and a setup password to secure your computer.

 **CAUTION:** The password features provide a basic level of security for the data on your computer.

 **CAUTION:** Anyone can access the data that is stored on your computer if it is not locked and left unattended.

 **NOTE:** System and setup password feature is disabled.

## Assigning a system setup password

### Prerequisites

You can assign a new **System or Admin Password** only when the status is in **Not Set**.

### About this task

To enter the system setup, press F12 immediately after a power-on or reboot.

### Steps

- In the **System BIOS** or **System Setup** screen, select **Security** and press Enter.  
The **Security** screen is displayed.
- Select **System/Admin Password** and create a password in the **Enter the new password** field.  
Use the following guidelines to assign the system password:
  - A password can have up to 32 characters.
  - At least one special character: ! " # \$ % & ' ( ) \* + , - . / : ; < = > ? @ [ \ ] ^ \_ ` { | }
  - Numbers 0 through 9.
  - Upper case letters from A to Z.

- Lower case letters from a to z.
3. Type the system password that you entered earlier in the **Confirm new password** field and click **OK**.
  4. Press Esc and save the changes as prompted by the pop-up message.
  5. Press Y to save the changes.  
The computer restarts.

## Deleting or changing an existing system setup password

### Prerequisites

Ensure that the **Password Status** is Unlocked (in the System Setup) before attempting to delete or change the existing System and/or Setup password. You cannot delete or change an existing System or Setup password, if the **Password Status** is Locked.

### About this task

To enter the System Setup, press F12 immediately after a power-on or reboot.

### Steps

1. In the **System BIOS** or **System Setup** screen, select **System Security** and press Enter.  
The **System Security** screen is displayed.
2. In the **System Security** screen, verify that **Password Status** is **Unlocked**.
3. Select **System Password**, update, or delete the existing system password, and press Enter or Tab.
4. Select **Setup Password**, update, or delete the existing setup password, and press Enter or Tab.  
 **NOTE:** If you change the System and/or Setup password, reenter the new password when prompted. If you delete the System and/or Setup password, confirm the deletion when prompted.
5. Press Esc and a message prompts you to save the changes.
6. Press Y to save the changes and exit from System Setup.  
The computer restarts.

## Clearing CMOS settings

### About this task

 **CAUTION:** Clearing CMOS settings will reset the BIOS settings on your computer.

### Steps

1. Remove the [base cover](#).
2. Ensure that the battery cable has been disconnected from the system board.
3. Remove the [coin-cell battery](#).
4. Wait for one minute.
5. Replace the [coin-cell battery](#).
6. Replace the [base cover](#).
7. Ensure that the battery cable has been reconnected to the system board.

## Clearing BIOS (System Setup) and System passwords

### About this task

To clear the system or BIOS passwords, contact Dell technical support as described at [www.dell.com/contactdell](http://www.dell.com/contactdell).

 **NOTE:** For information on how to reset Windows or application passwords, refer to the documentation accompanying Windows or your application.



# Updating the BIOS

## Updating the BIOS in Windows

### About this task

 **CAUTION:** If BitLocker is not suspended before updating the BIOS, the next time you reboot the system it will not recognize the BitLocker key. You will then be prompted to enter the recovery key to progress and the system will ask for this on each reboot. If the recovery key is not known this can result in data loss or an unnecessary operating system re-install. For more information on this subject, see Knowledge Article: <https://www.dell.com/support/article/sln153694>

### Steps

1. Go to [www.dell.com/support](http://www.dell.com/support).
2. Click **Product support**. In the **Search support** box, enter the Service Tag of your computer, and then click **Search**.  
 **NOTE:** If you do not have the Service Tag, use the SupportAssist feature to automatically identify your computer. You can also use the product ID or manually browse for your computer model.
3. Click **Drivers & Downloads**. Expand **Find drivers**.
4. Select the operating system installed on your computer.
5. In the **Category** drop-down list, select **BIOS**.
6. Select the latest version of BIOS, and click **Download** to download the BIOS file for your computer.
7. After the download is complete, browse the folder where you saved the BIOS update file.
8. Double-click the BIOS update file icon and follow the on-screen instructions.  
For more information, see knowledge base article [000124211](https://www.dell.com/support/article/000124211) at [www.dell.com/support](http://www.dell.com/support).

## Updating the BIOS using the USB drive in Windows

### About this task

 **CAUTION:** If BitLocker is not suspended before updating the BIOS, the next time you reboot the system it will not recognize the BitLocker key. You will then be prompted to enter the recovery key to progress and the system will ask for this on each reboot. If the recovery key is not known this can result in data loss or an unnecessary operating system re-install. For more information on this subject, see Knowledge Article: <https://www.dell.com/support/article/sln153694>

### Steps

1. Follow the procedure from step 1 to step 6 in [Updating the BIOS in Windows](#) to download the latest BIOS setup program file.
2. Create a bootable USB drive. For more information, see the knowledge base article [000145519](https://www.dell.com/support/article/000145519) at [www.dell.com/support](http://www.dell.com/support).
3. Copy the BIOS setup program file to the bootable USB drive.
4. Connect the bootable USB drive to the computer that needs the BIOS update.
5. Restart the computer and press **F12**.
6. Select the USB drive from the **One Time Boot Menu**.
7. Type the BIOS setup program filename and press **Enter**.  
The **BIOS Update Utility** appears.
8. Follow the on-screen instructions to complete the BIOS update.

# Updating the BIOS from the F12 One-Time boot menu

Update your computer BIOS using the BIOS update.exe file that is copied to a FAT32 USB drive and booting from the F12 One-Time boot menu.

## About this task

**CAUTION:** If BitLocker is not suspended before updating the BIOS, the next time you reboot the system it will not recognize the BitLocker key. You will then be prompted to enter the recovery key to progress and the system will ask for this on each reboot. If the recovery key is not known this can result in data loss or an unnecessary operating system re-install. For more information on this subject, see Knowledge Article: <https://www.dell.com/support/article/sln153694>

## BIOS Update

You can run the BIOS update file from Windows using a bootable USB drive or you can also update the BIOS from the F12 One-Time boot menu on the computer.

Most of the Dell computers built after 2012 have this capability, and you can confirm by booting your computer to the F12 One-Time Boot Menu to see if BIOS FLASH UPDATE is listed as a boot option for your computer. If the option is listed, then the BIOS supports this BIOS update option.

**NOTE:** Only computers with BIOS Flash Update option in the F12 One-Time boot menu can use this function.

## Updating from the One-Time boot menu

To update your BIOS from the F12 One-Time boot menu, you need the following:

- USB drive formatted to the FAT32 file system (key does not have to be bootable)
- BIOS executable file that you downloaded from the Dell Support website and copied to the root of the USB drive
- AC power adapter that is connected to the computer
- Functional computer battery to flash the BIOS

Perform the following steps to perform the BIOS update flash process from the F12 menu:

**CAUTION:** Do not turn off the computer during the BIOS update process. The computer may not boot if you turn off your computer.

## Steps

1. From a turn off state, insert the USB drive where you copied the flash into a USB port of the computer.
2. Turn on the computer and press F12 to access the One-Time Boot Menu, select BIOS Update using the mouse or arrow keys then press Enter.  
The flash BIOS menu is displayed.
3. Click **Flash from file**.
4. Select external USB device.
5. Select the file and double-click the flash target file, and then click **Submit**.
6. Click **Update BIOS**. The computer restarts to flash the BIOS.
7. The computer will restart after the BIOS update is completed.

# Troubleshooting

## Handling swollen Lithium-ion batteries

Like most laptops, Dell laptops use lithium-ion batteries. One type of lithium-ion battery is the lithium-ion polymer battery. Lithium-ion polymer batteries have increased in popularity in recent years and have become standard in the electronics industry due to customer preferences for a slim form factor (especially with newer ultra-thin laptops) and long battery life. Inherent to lithium-ion polymer battery technology is the potential for swelling of the battery cells.

Swollen battery may impact the performance of the laptop. To prevent possible further damage to the device enclosure or internal components leading to malfunction, discontinue the use of the laptop and discharge it by disconnecting the AC adapter and letting the battery drain.

Swollen batteries should not be used and should be replaced and disposed of properly. We recommend contacting Dell product support for options to replace a swollen battery under the terms of the applicable warranty or service contract, including options for replacement by a Dell authorized service technician.

The guidelines for handling and replacing Lithium-ion batteries are as follows:

- Exercise caution when handling Lithium-ion batteries.
- Discharge the battery before removing it from the system. To discharge the battery, unplug the AC adapter from the system and operate the system only on battery power. When the system will no longer power on when the power button is pressed, the battery is fully discharged.
- Do not crush, drop, mutilate, or penetrate the battery with foreign objects.
- Do not expose the battery to high temperatures, or disassemble battery packs and cells.
- Do not apply pressure to the surface of the battery.
- Do not bend the battery.
- Do not use tools of any type to pry on or against the battery.
- If a battery gets stuck in a device as a result of swelling, do not try to free it as puncturing, bending, or crushing a battery can be dangerous.
- Do not attempt to reassemble a damaged or swollen battery into a laptop.
- Swollen batteries that are covered under warranty should be returned to Dell in an approved shipping container (provided by Dell)—this is to comply with transportation regulations. Swollen batteries that are not covered under warranty should be disposed of at an approved recycling center. Contact Dell product support at <https://www.dell.com/support> for assistance and further instructions.
- Using a non-Dell or incompatible battery may increase the risk of fire or explosion. Replace the battery only with a compatible battery purchased from Dell that is designed to work with your Dell computer. Do not use a battery from other computers with your computer. Always purchase genuine batteries from <https://www.dell.com> or otherwise directly from Dell.

Lithium-ion batteries can swell for various reasons such as age, number of charge cycles, or exposure to high heat. For more information on how to improve the performance and lifespan of the laptop battery and to minimize the possibility of occurrence of the issue, see [Dell Laptop Battery - Frequently Asked Questions](#).

## Locate the Service Tag or Express Service Code of your Dell computer

Your Dell computer is uniquely identified by a Service Tag or Express Service Code. To view relevant support resources for your Dell computer, we recommend entering the Service Tag or Express Service Code at [www.dell.com/support](http://www.dell.com/support).

For more information on how to find the Service Tag for your computer, see [Locate the Service Tag for your Dell Laptop](#).

# System-diagnostic lights

## Power and battery-status light

The power and battery status light indicates the power and battery status of the computer. These are the power states:

**Solid white:**Power adapter is connected and the battery has more than 5% charge.

**Amber:**Computer is running on battery and the battery has less than 5% charge.

### Off:

- Power adapter is connected, and the battery is fully charged.
- Computer is running on battery, and the battery has more than 5% charge.
- Computer is in sleep state, hibernation, or turned off.

The power and battery-status light may blink amber or white according to pre-defined "beep codes" indicating various failures.

For example, the power and battery-status light blinks amber two times followed by a pause, and then blinks white three times followed by a pause. This 2,3 pattern continues until the computer is turned off, indicating no memory or RAM is detected.

The following table shows different power and battery-status light patterns and associated problems.

**i NOTE:** The following diagnostic light codes and recommended solutions are intended for Dell service technicians to troubleshoot problems. You should only perform troubleshooting and repairs as authorized or directed by the Dell technical assistance team. Damage due to servicing that is not authorized by Dell is not covered by your warranty.

**Table 10. Diagnostic-light LED codes**

Diagnostic light codes (Amber,White)	Problem description
1,1	M-BIST: TPM
1,2	M-BIST: SPI flash
1,3	Hinge cable OCP1
1,4	Hinge cable OCP2
1,5	i-Fuse failure
1,6	EC internal failure
2,1	Processor failure
2,2	System board: BIOS or ROM (Read-Only Memory) failure
2,3	No memory or RAM (Random-Access Memory) detected
2,4	Memory or RAM (Random-Access Memory) failure
2,5	Invalid memory installed
2,6	System-board or chipset error
2,7	Display failure - SBIOS message
2,8	Display failure - EC detection of power rail failure
3,1	Coin-cell battery failure
3,2	PCI, video card/chip failure
3,3	Recovery image not found
3,4	Recovery image found but invalid
3,5	Power-rail failure
3,6	System BIOS Flash incomplete
3,7	ME error



**Table 10. Diagnostic-light LED codes (continued)**

<b>Diagnostic light codes (Amber, White)</b>	<b>Problem description</b>
4,1	Memory error
4,2	Power rail error

**Camera status light:** Indicates whether the camera is in use.

- Solid white—Camera is in use.
- Off—Camera is not in use.

**Caps Lock status light:** Indicates whether Caps Lock is enabled or disabled.

- Solid white—Caps Lock enabled.
- Off—Caps Lock disabled.

## SupportAssist | On-board Diagnostics

### About this task

The SupportAssist | On-board Diagnostics performs a complete check of your hardware.

This diagnostic is the new on-board diagnostic tool and replaces the ePSA 3.0 diagnostics. It has a clean and modern user interface, quicker tests, simplified messaging.

SupportAssist | On-board Diagnostics can be initiated by one of the following methods:

- Pressing F12 to enter one-time Boot Menu and selecting Diagnostics to initiate the diagnostics OR Fn + Power
- BIOS POST detecting a hardware failure or error and initiating the diagnostics

The SupportAssist | On-board Diagnostics is embedded with the BIOS and is launched by the BIOS internally. The embedded system diagnostics provides a set of options for particular devices or device groups allowing you to:

- Run tests in either Quick Test Mode or Advanced Test Mode
- Run thorough tests to introduce additional test options to provide extra information about the failed device(s)
- Run tests in either Automatic Mode or Interactive Test Mode
- Run interactive tests on LCD panel and keyboard
- Display or save test results
- View status messages that indicate if the tests are completed successfully
- View error messages that indicate if problems were encountered during the test

 **NOTE:** Some tests for specific devices require user interaction. Ensure that you are present at the computer terminal when the diagnostic tests are performed.

For more information, see [SupportAssist Pre-Boot System Performance Check](#).

## Recovering the operating system

When your computer is unable to boot to the operating system even after repeated attempts, it automatically starts Dell SupportAssist OS Recovery.

Dell SupportAssist OS Recovery is a standalone tool that is preinstalled in all Dell computers installed with Windows operating system. It consists of tools to diagnose and troubleshoot issues that may occur before your computer boots to the operating system. It enables you to diagnose hardware issues, repair your computer, back up your files, or restore your computer to its factory state.

You can also download it from the Dell Support website to troubleshoot and fix your computer when it fails to boot into their primary operating system due to software or hardware failures.

For more information about the Dell SupportAssist OS Recovery, see *Dell SupportAssist OS Recovery User's Guide* at [www.dell.com/serviceabilitytools](http://www.dell.com/serviceabilitytools). Click **SupportAssist** and then, click **SupportAssist OS Recovery**.

# Backup media and recovery options

It is recommended to create a recovery drive to troubleshoot and fix problems that may occur with Windows. Dell proposes multiple options for recovering Windows operating system on your Dell PC. For more information, see [Dell Windows Backup Media and Recovery Options](#).

## WiFi power cycle

### About this task

If your computer is unable to access the internet due to WiFi connectivity issues a WiFi power cycle procedure may be performed. The following procedure provides the instructions on how to conduct a WiFi power cycle:

 **NOTE:** Some ISPs (Internet Service Providers) provide a modem/router combo device.

### Steps

1. Turn off your computer.
2. Turn off the modem.
3. Turn off the wireless router.
4. Wait for 30 seconds.
5. Turn on the wireless router.
6. Turn on the modem.
7. Turn on your computer.

## Drain residual flea power (perform hard reset)

### About this task

Flea power is the residual static electricity that remains in the computer even after it has been powered off and the battery is removed.

For your safety, and to protect the sensitive electronic components in your computer, you are requested to drain residual flea power before removing or replacing any components in your computer.

Draining residual flea power, also known as a performing a "hard reset", is also a common troubleshooting step if your computer does not power on or boot into the operating system.

### To drain residual flea power (perform a hard reset)

### Steps

1. Turn off your computer.
2. Disconnect the power adapter from your computer.
3. Remove the base cover.
4. Remove the battery.
5. Press and hold the power button for 20 seconds to drain the flea power.
6. Install the battery.
7. Install the base cover.
8. Connect the power adapter to your computer.
9. Turn on your computer.



 **NOTE:** For more information about performing a hard reset, see the knowledge base article [000130881](#) at [www.dell.com/support](http://www.dell.com/support).

# Getting help and contacting Dell

## Self-help resources

You can get information and help on Dell products and services using these self-help resources:

**Table 11. Self-help resources**

Self-help resources	Resource location
Information about Dell products and services	<a href="http://www.dell.com">www.dell.com</a>
My Dell app	
Tips	
Contact Support	In Windows search, type <code>Contact Support</code> , and press Enter.
Online help for operating system	<a href="http://www.dell.com/support/windows">www.dell.com/support/windows</a>
Access top solutions, diagnostics, drivers and downloads, and learn more about your computer through videos, manuals and documents.	Your Dell computer is uniquely identified by a Service Tag or Express Service Code. To view relevant support resources for your Dell computer, enter the Service Tag or Express Service Code at <a href="http://www.dell.com/support">www.dell.com/support</a> .  For more information on how to find the Service Tag for your computer, see <a href="#">Locate the Service Tag on your computer</a> .
Dell knowledge base articles for a variety of computer concerns	<ol style="list-style-type: none"> <li>1. Go to <a href="http://www.dell.com/support">www.dell.com/support</a>.</li> <li>2. On the menu bar at the top of the Support page, select <b>Support &gt; Knowledge Base</b>.</li> <li>3. In the Search field on the Knowledge Base page, type the keyword, topic, or model number, and then click or tap the search icon to view the related articles.</li> </ol>

## Contacting Dell

To contact Dell for sales, technical support, or customer service issues, see [www.dell.com/contactdell](http://www.dell.com/contactdell).

 **NOTE:** Availability varies by country/region and product, and some services may not be available in your country/region.

 **NOTE:** If you do not have an active Internet connection, you can find contact information about your purchase invoice, packing slip, bill, or Dell product catalog.