









1 Overview - Less Cost, Less Cabling, Less Maintenance

Designed for demanding environments, Brainboxes Industrial PoE Switches remove the need for costly electrical installations by enabling the transmission of electrical power over the same cable that carries data.

Available with **Fast** and **Gigabit Ethernet**, plus **SFP**, and in a **range of enclosures** to perfectly fit your application, Brainboxes PoE switches are simple to install, fully conform to IEEE 802.3af/at Ethernet standards for reliable performance, and offer the flexibility to deploy powered devices at almost any location.

1.1 Functionality and Features

	EMBEDDED	INDUSTRIAL	HARDENED
FAST	 SW-125	 SW-525	 SW-725
GIGABIT	 SW-135	 SW-535	 SW-735
GIGABIT PLUS SFP	 SW-195	 SW-595	

- 4 PoE+ capable ports
- Fully compliant to IEEE 802.3af/at
- PoE Power Budget: 90W @ 70°C between all 4 PoE ports
- Industrial temp range: -40°C to +70°C
- Redundant dual power inputs: +44V to +57V DC
- Compact design
- Allows power and data to be combined on the same Ethernet cable
- DIN Rail Mountable or Embedded

1.2 Product Variants

Model	PoE+	Fast Ethernet	Gigabit	SFP	Enclosure
	IEEE 802.3af/at	10/100 BaseT (RJ45)	10/100/1000 BaseT (RJ45)	1000 Base-X	
SW-125	4	5	-	-	Embedded
SW-525	4	5	-	-	Industrial
SW-725	4	5	-	-	Hardened
SW-135	4	-	5	-	Embedded
SW-535	4	-	5	-	Industrial
SW-735	4	-	5	-	Hardened
SW-195	4	-	4	1	Embedded
SW-595	4	-	4	1	Industrial

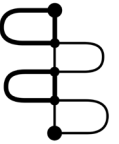

1.3 General Information

Model	Power Consumption (not including PoE)	Operating Temp (°C)	Product Weight (kg)	Product Size (mm)	GTIN (barcode)	Package Weight (kg)	Package Size (mm)
SW-125	4 Watts Max: 70mA@+57VDC	-40 to +70	0.079	105 x 95 x 20	837324004588	0.182	160 x 135 x 49
SW-525	4 Watts Max: 70mA@+57VDC	-40 to +70	0.132	116 x 99 x 23	837324004533	0.235	160 x 135 x 49
SW-725	4 Watts Max: 70mA@+57VDC	-40 to +70	0.327	115 x 99 x 28	837324004564	0.444	160 x 135 x 49
SW-135	5.5 Watts Max: 96mA@+57VDC	-40 to +70	0.090	105 x 86 x 20	837324005066	0.162	160 x 135 x 49
SW-535	5.5 Watts Max: 96mA@+57VDC	-40 to +70	0.137	116 x 99 x 23	837324005073	0.24	160 x 135 x 49
SW-735	5.5 Watts Max: 96mA@+57VDC	-40 to +70	0.327	115 x 99 x 28	837324005172	0.422	160 x 135 x 49
SW-195	5.3 Watts Max: 93mA@+57VDC	-40 to +70	0.089	105 x 86 x 20	837324005189	0.160	160 x 135 x 49
SW-595	5.3 Watts Max: 93mA@+57VDC	-40 to +70	0.136	115 x 100 x 23	837324005080	0.231	160 x 135 x 49



**UK
CA** CAGE
8QCY6



**MADE IN
BRITAIN**

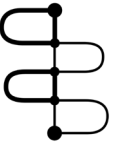

Contents

1	Overview - Less Cost, Less Cabling, Less Maintenance.....	1
1.1	Functionality and Features.....	1
1.2	Product Variants.....	1
1.3	General Information.....	2
2	Pinouts	4
2.1	Ethernet Ports	4
2.2	Power Terminal	4
3	Enclosures (3D Models Available).....	5
3.1	Industrial	5
3.1.1	SW-525, SW-535, SW-595.....	5
3.2	Hardened.....	6
3.2.1	SW-725, SW-735	6
3.3	Embedded	6
3.3.1	SW-125.....	6
3.3.2	SW-135.....	7
3.3.3	SW-195.....	7
4	Data.....	8
4.1	Connectors	8
4.2	Power Supply	8
4.3	Environment.....	8
4.4	Ethernet	8
4.5	Magjack LED	8
4.6	SFP LED.....	9
5	Approvals & Support.....	9
5.1	Industry Approvals	9
5.2	Company Approvals	9
5.3	NATO Stock Numbers.....	9
5.4	Support.....	9
6	Accessories.....	10

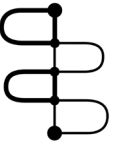

2 Pinouts

2.1 Ethernet Ports

PoE Pinout 1/2(V+) 3/6(V-) Endspan Mode A

PIN	FUNCTION		
	Data 10/100	Data Gigabit	PoE Power
1	Tx+	TxRx A+	DC+
2	Tx-	TxRx A-	DC+
3	Rx+	TxRx B+	DC-
4		TxRx C+	
5		TxRx C-	
6	Rx-	TxRx B-	DC-
7		TxRx D+	
8		TxRx D-	

2.2 Power Terminal

PIN	FUNCTION
1	-V
2	+VA
3	+VB
4	-V
5	FUNC EARTH

5 position 3.5mm pitch pluggable terminal block included

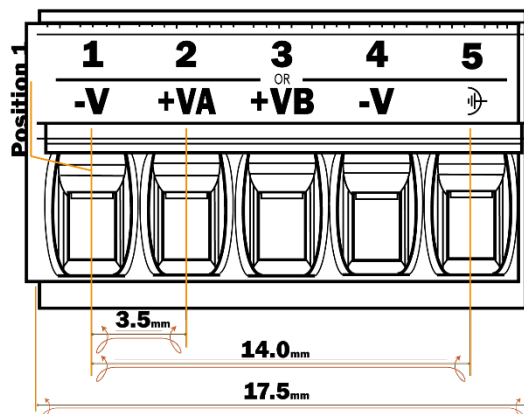

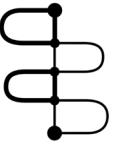

3 Enclosures (3D Models Available)

3.1 Industrial

3.1.1 SW-525, SW-535, SW-595

DIN rail mountable IP-20 rated non-conducting polyamide case

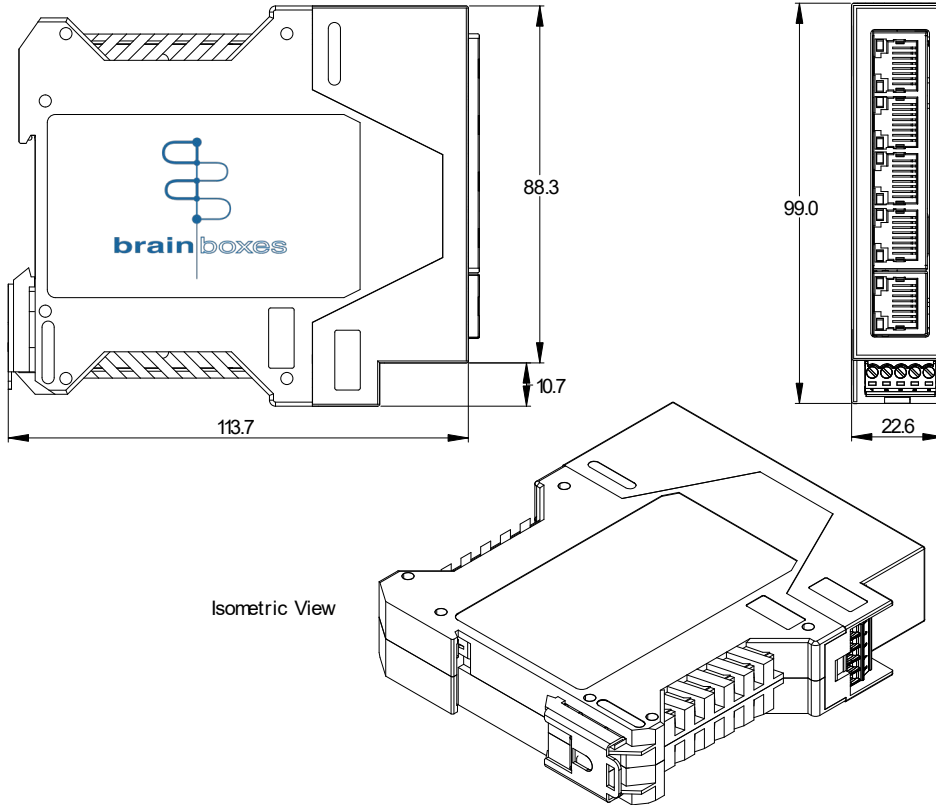

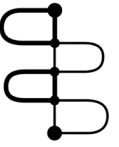

3.2 Hardened

3.2.1 SW-725, SW-735

DIN rail mountable hardened metal enclosure

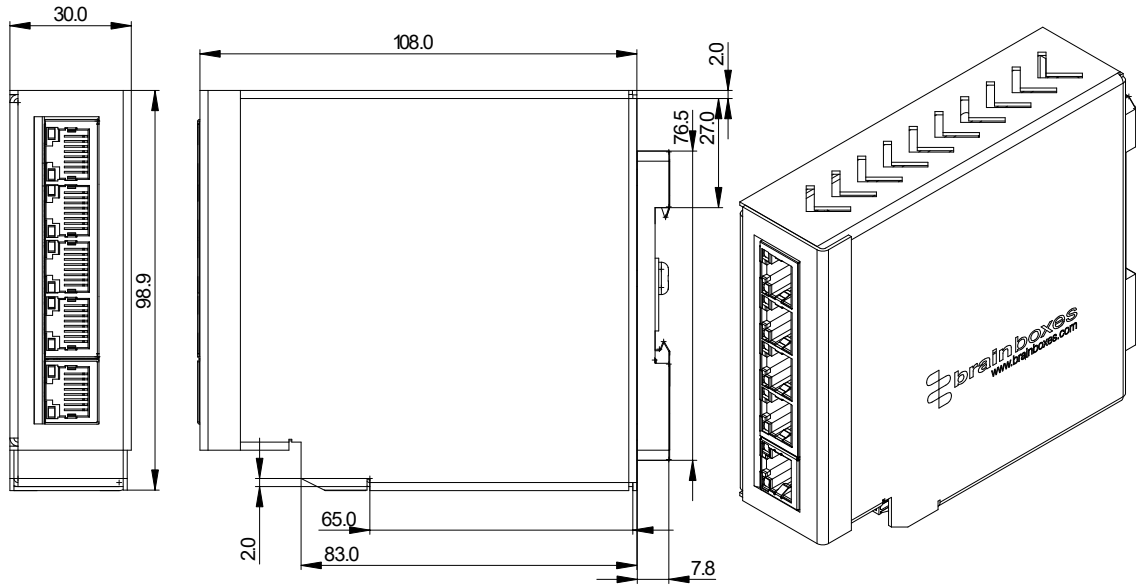

3.3 Embedded

3.3.1 SW-125

All Dimensions in mm
Tolerance +/- 0.1mm

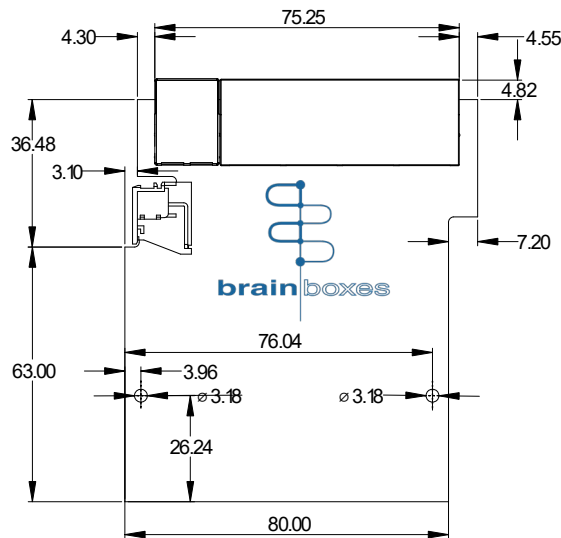

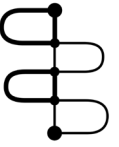

3.3.2 SW-135

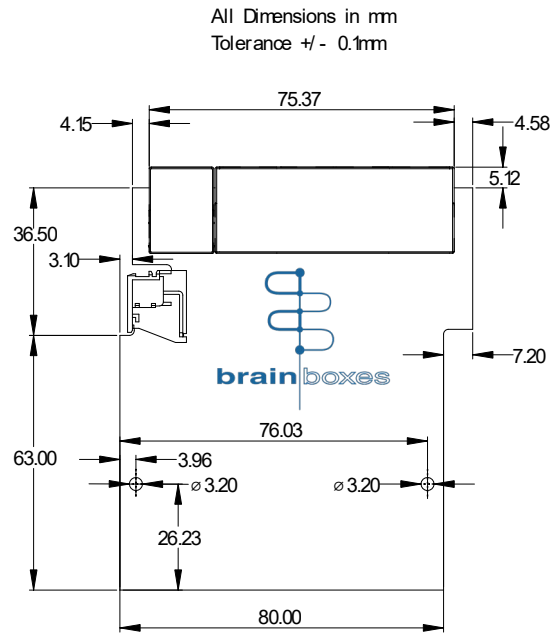

3.3.3 SW-195

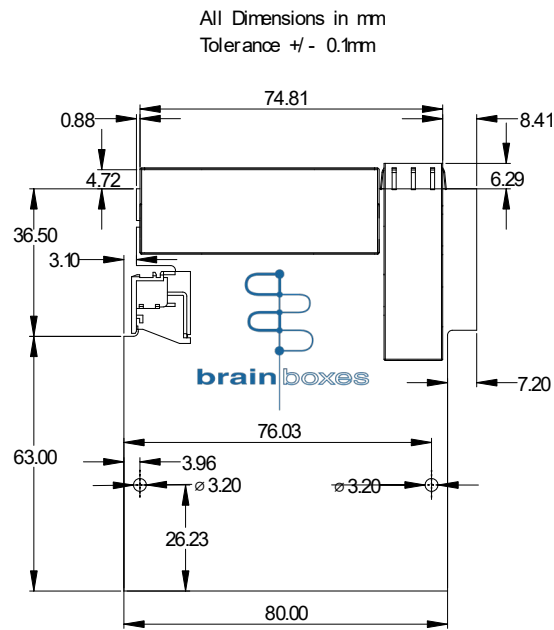

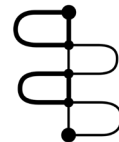

4 Data

Gigabit Ethernet: Jumbo Frame support

SFP Port: Overcurrent protection

4.1 Connectors

Screw Terminals	3.5mm pitch, #22 - #14, 0.5mm ² -2.5mm ² pin power supply
Wire Thickness	0.150 inch, 3.81mm, 20 pins, 12+8 screw terminals, #26 - #16 AWG, 0.14mm ² -1.3mm ²

4.2 Power Supply

Power Consumption	See Table: 1.3 General Information
PoE Power Budget	90W @ 70°C 4 Ports IEEE 802.3af/at compliant: deliver up to 30W to each port (backwards compatible)
Power Supply Input	Unregulated +44V to +57 Volts DC, reverse polarity protection
Isolation	1500VRMS Magnetic isolation from Ethernet

4.3 Environment

Operating Temperature	-40°C to +70°C/-40°F to +158°F
Storage Temperature	-40°C to +70°C/-40°F to +158°F
Ambient Relative Humidity	5 to 95% (non-condensing)

4.4 Ethernet

Ethernet Port	5 x RJ45 jack, auto-negotiation, crossover auto-sensing (Auto MDIX)
Protection	1,500 Volts magnetic isolation between ports

4.5 Magjack LED

Link/Activity LED	Solid Green	Connection established
	Flashing Green	Data communication
PoE Power LED (ports 1-4) (ports 2-5 SW-X95 only)	Solid Yellow	PoE power ON
	Flashing Yellow	Power warning

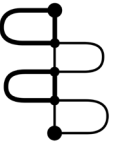

4.6 SFP LED

SFP Power LED	Solid Green	SFP power ON
	Solid Amber	SFP plugged in
	Flashing Amber	SFP activity
	Flashing Green/Amber	SFP error/incompatible

5 Approvals & Support

5.1 Industry Approvals

General	WEEE, RoHS, CE, UKCA,
UL	METL Complies with UL62368-1
HTS	8517620000
ECCN	5A991.b

5.2 Company Approvals

General	ISO9001, ISO14001, Microsoft Certified Gold Partner, AEO (C-TPAT)
CAGE	8QCY6
NCAGE	U0Q96
GSA Contract Number	47QTCA23D009X

5.3 NATO Stock Numbers

Model	NATO Stock Number (NSN)
SW-135	5930991691576
SW-535	5930998479326
SW-735	5930998479327
SW-195	5930999695816
SW-595	5930999695817

5.4 Support

Warranty	Lifetime - online registration required
Support	Lifetime Web, Email and phone support from fully qualified, friendly staff who work in and alongside the Product Development Team
OEM option	Available for bulk buy OEM
COO (Country of Origin)	Made in GB, United Kingdom of Great Britain & Northern Ireland
Customisable	Perfect Fit Custom Design policy for volume users

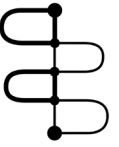

6 Accessories

- [PW-301 – 96W Single Output Industrial DIN Power Supply](#)