



**Pukka
Pad**

PRODUCT
CATALOGUE

THE PUKKA GROUP



**carpe
diem**



www.pukka-pads.co.uk

ABOUT PUKKA PADS

At Pukka Pads we are passionate about our brand and love what we do! **Since 1998** we have created and produced innovative paper-based products for the world's stationery industry. We believe our experience, dedication and commitment over the last **20 years** has led us to be the leading brand in the global stationery market. We offer a huge range of merchandise from great quality pads to innovative, **stylish**, sturdy and **high-quality** products. Pukka Pads has a fantastic in-house design team to help the business create new **on-trend** designs. The team can not only create new Pukka stationery but also help our customers with designing and manufacturing their private label products.

In 2019 Pukka Pad acquired the much-loved US gifting and stationery brand **Carpe Diem**. Pukka Pad fell in love with Carpe Diem's ethos that believes the art of organising should be expressive, **inspiring** and create a sense of excitement about the future. From A5 6-ring, personal and spiral planners to notebook holders and stationery essentials, Carpe Diem products are stylish, functional and perfect for both the planner addict and those just starting out.

We have offices based in the UK and US, as well as a sourcing team in China.

Therefore, with everything we have to offer, we truly believe there is a Pukka Pad for everyone!



REASONS TO CHOOSE PUKKA

1. Ethical sourcing
2. Complete supply chain management
3. High quality production
4. Fully audited sites
5. Personal account manager
6. Adaptive marketing team
7. In-house design service
8. Flexible & focused on building long term partnerships



PRODUCT CATALOGUE



PUKKA PADS & ENVIRONMENT

Pukka Pads realise that as a modern and progressive group of companies we have a responsibility to be aware of our impact on the environment and a duty to do everything in our means to lessen that impact. We want you to enjoy your Pukka Pad or Pukka Product with the knowledge that we are doing our part. To ensure we live up to our long term environmental values, Pukka Pads has made a commitment to:

- Use paper and materials from well managed and accredited sources & suppliers only
- Undertake the manufacturing and shipping of our products in a responsible manner
- Produce recyclable pads and products only, wherever possible
- Recycle our office and warehouse waste and to encourage a healthy working environment
- Always look for ways to improve and secure the future of the paper industry



SOURCES & SUPPLIERS

All of the paper we use for our products originates from sustainable sources. The planting of new trees is important to us; it is a crucial part of eliminating our impact on the environment as well as helping to secure the supply of paper for future generations.

We take pride in ensuring all of our paper pads and notebooks are produced from paper which originates from sustainable sources. In 2010, Pukka Pads production plant was officially double certified to both the Programme for the Endorsement of Forest Certification (PEFC) and Forest Stewardship Council® (FSC®) chain of custody Standards. PEFC and FSC® are an international non-profit, non-governmental organisations dedicated to promoting Sustainable Forest Management (SFM) through independent third-party certification, established to support environmentally appropriate, socially beneficial and economically viable management of the world's forests.



The mark of responsible forestry



MANUFACTURING & SHIPPING

All of the paper mills we use are ISO9002 and ISO 14001 accredited. We also work closely with various recycling companies which allows us to offer recycled paper to all of our customers.

As a global business the transport of our products is kept to an absolute minimum, we manage our shipping in such a way that allows us to distribute products all over the world but which does not see any unnecessary movement of stock.







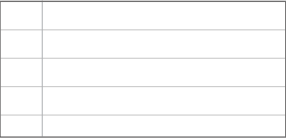
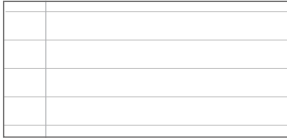
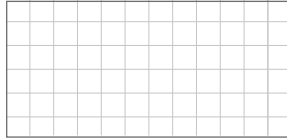

We strive to be fully informed of the latest developments and standards in paper production and promise to implement them into our business wherever possible.

CHOOSE YOUR PUKKA NOTEBOOK

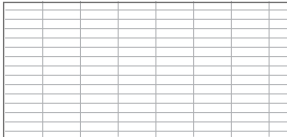
BY RULING

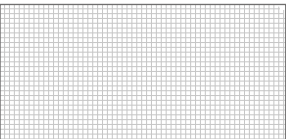
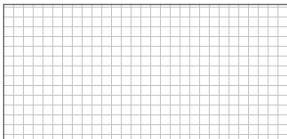
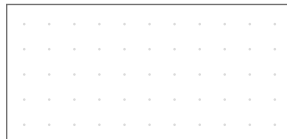
		
1 8mm Ruled	2 6mm Narrow Ruled	3 5mm Squared
		
4 Plain	5 French Ruled	6 Meeting Pad
		
7 1,5,10mm Ruled	8 2,10,20mm Ruled	9 5mm Dot Grid

BY SIZE



BY BINDING



Wire Bound

Tape Bound

Casebound

Glued

MERCHANDISING

PLANOGRAM & FSDU SERVICE

We produce bespoke product ranges for retailers and can offer full POS solutions.

Rotating Metal Display Stand



Counter Display Unit (CDU)



Cardboard Display Stand (FSDU)



Full or Half Shipper Pallet for retailers

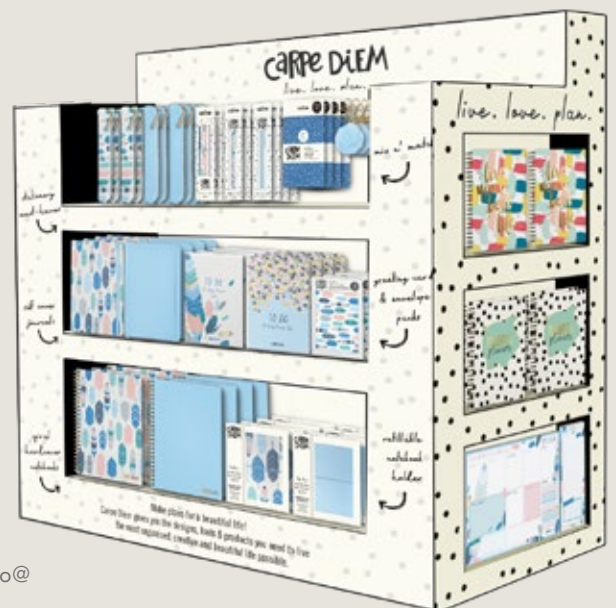

Please contact the Pukka Pads Sales Department for further information: info@pukka-pads.co.uk

MUST-HAVE

TAKE A PEEK AT WHAT'S NEW

At Pukka, stationery is our world. From colourful notebooks to cute pens, we pride ourselves on creating Must Have products. Discover our favourites below, or read on to find your own.

1. BLOOM COLLECTION

PAGE 32



2. CARPE DIEM DIARIES

PAGE 37



3. COLOURED IRLÉN JOTTAS

PAGE 43



4. STUDY BOOK

PAGE 39

5. KRAFT RANGE

PAGE 14



6. PUKKA PLANET

PAGE 17

TABLE OF CONTENTS

BOOKS & PADS

METALLIC RANGE..... NEW	6>11
RECYCLED RANGE..... NEW	13
KRAFT RANGE.....	14>15
PUKKA PLANET..... NEW	16>19
STRIPES RANGE.....	20
VOGUE RANGE.....	21
PP NEON RANGE.....	21
GLEE RANGE.....	22>23
PASTELS RANGE.....	24>26
ROCHELLE & JESS RANGE.....	27>28
FASHION PROJECT BOOKS.....	28
WILD RANGE.....	29/31
BLOOM RANGE.....	32>36
2024 DIARIES..... NEW	37

PUKKA NOTES FILING

STUDY RANGE..... NEW	38/41
RECORD & REVISION CARDS..... NEW	40/41
SOFT COVER RANGE..... NEW	42
COLOUR RANGE..... NEW	43
BLACK BUSINESS RANGE.....	44
SILVER & BLUE MANUSCRIPT RANGES.....	45
PRESSBOARD RANGE.....	46>47
UNIPAD RANGE.....	48>49
STICKY NOTES RANGE.....	50
BRIGHTS DOCUMENTS & CURRICULUM FILES.....	51
FASHION FILING.....	52
BRIGHTS FILING.....	53>54
CONCORD CLOUD FILING.....	55
PREMIUM FILING..... NEW	56
WALLPLANNERS.....	57

PLANNERS

INDEXES & DIVIDERS

POLYPROPYLENE FILING.....	58>65
INDEXES & DIVIDERS.....	66>71
REVERSIBLE FASHION DIVIDERS.....	71

BUSINESS FORMS

BUSINESS PADS.....	72
DUPLICATE & TRIPPLICATE RANGE.....	73>75
BUSINESS FORMS.....	76
RESTAURANT PADS.....	77
ACCOUNTANCY & SURVEY PADS.....	78
CONCORD BOOKS.....	79
COTTON STRING BALLS..... NEW	80

PUKKA POST & PACKAGING

ENVELOPES

POST & PACKAGING.....	81>86
BUBBLE WRAP RANGE.....	87
BUBBLE LINED ENVELOPES.....	88>89
WHITE/MANILLA ENVELOPES.....	90>91
COLOURED ENVELOPES.....	92
CHRISTMAS CARD COLLECTION.....	93
CARPE DIEM COLLECTIONS.....	94

CARPE DIEM BRAND



The Metallic Range is a Pukka classic with many useful features, catering for the young professional seeking style and sophistication in a notebook. With 200 high quality 80gsm pages you can write on both sides of the paper with confidence.



A4+ LINED



B5 LINED



A5 LINED



A6 LINED

A4+/B5/A5/A6 METALLIC JOTTA NOTEPADS - LINED

- JM018 Pack of 3 / Outer 15 (A4+, 225 x 297mm)
- 8520-MET Pack of 3 / Outer 24 (B5)
- JM021 Pack of 3 / Outer 30 (A5)
- JM036 Pack of 3 / Outer 72 (A6)

PRODUCT DETAIL
Wirebound
Card covers
Metallic print on front

PAGE DETAIL
200 Pages
80 gsm
8mm lines
Margin & 4 hole punched (A4+ Only)
Page perforation



LINED



A4+ SQUARED



A5 SQUARED



A4+ LINED



B5 LINED

A4+/A5 METALLIC JOTTA NOTEPADS - SQUARED

- JM018SQ Pack of 3 / Outer 15 (A4+ Squared)
- JM021SQ Pack of 3 / Outer 30 (A5 Squared)

PRODUCT DETAIL
Wirebound
Card covers
Metallic print on front

PAGE DETAIL
200 Pages, 80 gsm
5mm squares
Margin & 4 hole
Punched (A4+ Only)
Page perforation

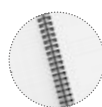

SQUARED

A4/B5 METALLIC PROJECT BOOKS

- 8521-MET Pack of 3 / Outer 12 (A4)
- 8518-MET Pack of 3 / Outer 12 (B5)

PRODUCT DETAIL
Wirebound
Printed polypropylene cover, colour coded re-positionable dividers with storage pockets

PAGE DETAIL
200 Pages
80 gsm
8mm Lines
Page perforation

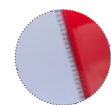

LINED



DIVIDERS

NEW



A4+ DOTTED

A5 DOTTED

200 pages with 5mm dot grid
80gsm high quality FSC paper

A4+/A5 METALLIC JOTTA NOTEPADS - DOTTED

JM018DOT Pack of 3 / Outer 15 (A4+, 225 x 297mm)
JM021DOT Pack of 3 / Outer 30 (A5)

PRODUCT DETAIL
Wirebound
Card covers
Metallic print on front

PAGE DETAIL
200 Pages
80 gsm
5mm dot grid
4 hole punched (A4+ Only)
Page perforation

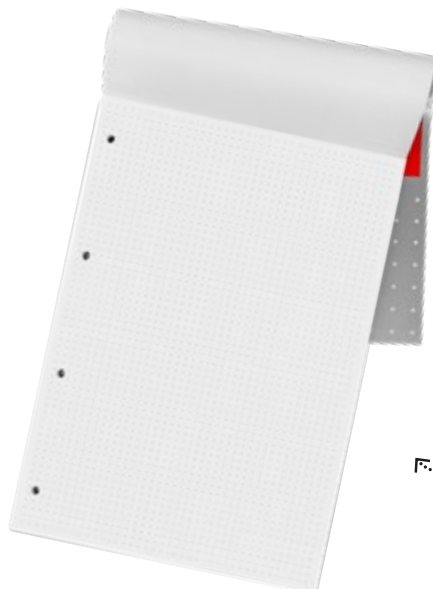

NEW

160 pages with 5mm dot grid
80gsm high quality FSC paper

A4 REFILL PAD - DOTTED

REFDOT Pack of 3 / Outer 36

PRODUCT DETAIL
Tape head-bound card cover, metallic print on front, great for visual subjects and technical drawing. The high-quality dot pages are great for writing, doodling, and making memories on the go! Perfect for trains, planes, and days out!

PAGE DETAIL
160 Pages
80 gsm
5mm dot grid
4 hole punched

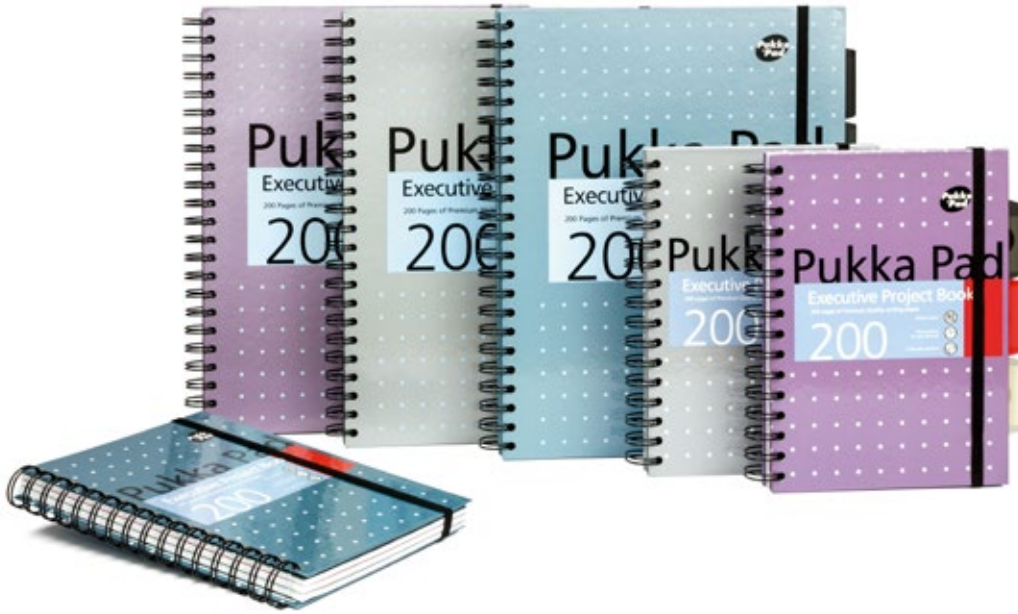

A4+/A5 METALLIC EXECUTIVE PROJECT BOOKS

6970-MET Pack of 3 / Outer 12 (Executive A4+)
6336-MET Pack of 3 / Outer 24 (Executive A5)

COLOURS



PRODUCT DETAIL

Wirebound
Hard backed covers
Elasticated closure
Important information pages
Global map
Colour coded re-positionable
dividers with storage pockets

PAGE DETAIL

200 Pages
80 gsm
8mm Lines
Margin (A4+ Only)
4 Hole punched (A4+ Only)
Page perforation



MAPS



LINED



A4+ METALLIC JOTTA EXEC

7019-MET Pack of 3 / Outer 15

PRODUCT DETAIL

Size A4+, 225 x 297mm
Wirebound
Card covers
Metallic print on front

PAGE DETAIL

300 Pages
80 gsm
8mm Lines
Margin
4 hole punched
Page perforation
tears out to A4 size



LINED

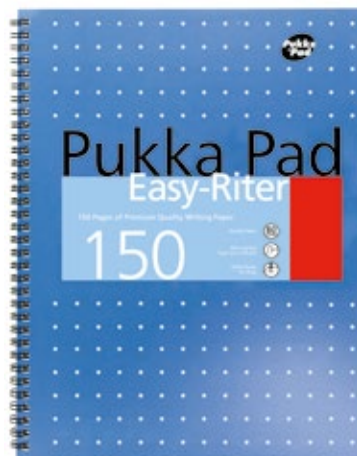

A4+ METALLIC EASY-RITER

ERM009 Pack of 3 / Outer 24

PRODUCT DETAIL

Size A4+, 225 x 297mm
Wirebound
Card covers, metallic
print on front

PAGE DETAIL

150 Pages
80 gsm
8mm Lines
Margin
4 Hole punched
Page perforation



LINED



A4+ METALLIC EDITOR PAD

EM003 Pack of 3 / Outer 27

PRODUCT DETAIL

Size A4+, 225 x 297mm
Wirebound
Card covers, metallic
print on front

PAGE DETAIL

100 Pages
80 gsm
8mm Lines
Margin
4 Hole punched
Page perforation



LINED



A4+/A5 METALLIC VELLUM NOTEBOOKS

VJM/1 Pack of 3 / Outer 24 (A4+)
 VJM/2 Pack of 3 / Outer 48 (A5)

PRODUCT DETAIL

These vellum versions of the popular pukka pad is a fantastic alternative to the standard jotta range. Vellum denotes a touch of class with documents and also is believed to be better for people with dyslexia to process information on tinted paper.

PAGE DETAIL

120 Pages
 80 gsm
 Quality vellum paper
 8mm Lines
 Margin (A4+ only)
 4 hole punched (A4+ only)
 Page perforation

LINED



COLOURS



METALLIC SHORTIE PAD

SM024 Pack of 3 / Outer 18

PRODUCT DETAIL

Size 178 x 235mm
 Wirebound, head-bound
 Card covers, metallic print
 on front

PAGE DETAIL

240 Pages
 80 gsm
 8mm Line
 Page perforation

LINED



COLOURS

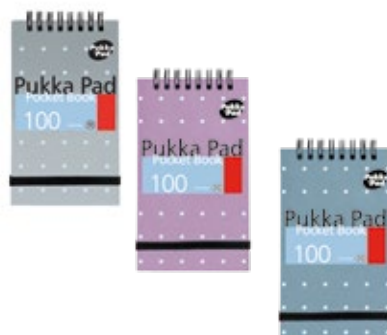

METALLIC REPORTER'S PAD

NM001 Pack of 3 / Outer 36)

PRODUCT DETAIL

Size 140 x 205mm
 Wirebound, head-bound
 card covers,
 metallic print on front,
 commonly misspelt words

PAGE DETAIL

160 Pages
 80 gsm
 8mm Lines
 Page perforation

LINED



COLOURS



A7 POCKET BOOK

6254-MET Pack of 6 / Outer 48

PRODUCT DETAIL

Size 76 x 127mm
 Wirebound, head-bound,
 card covers, metallic print on
 front, elasticated closure,
 assorted coloured packs

PAGE DETAIL

100 Pages
 80 gsm
 8mm Lines

LINED



COLOURS



A5 METALLIC WRITING PAD

6468-MET Pack of 6 / Outer 72

PRODUCT DETAIL

Size A5
 Tape head-bound,
 card cover, metallic print on front

PAGE DETAIL

160 Pages
 80 gsm
 8mm Lines

LINED



COLOURS





A4 REFILL PAD - 160 PAGE

REF80/1 Pack of 6 / Outer 36

PRODUCT DETAIL
Tape head-bound card cover, metallic print on front, assorted coloured packs

PAGE DETAIL
160 Pages
80 gsm
8mm Lines
Margin
4 hole punched



LINED

COLOURS



A4 REFILL PAD - 400 PAGE

REF400 Pack of 5 / Outer 20

PRODUCT DETAIL
Tape sidebound Card cover, metallic print on front, assorted coloured packs

PAGE DETAIL
400 Pages
80 gsm
8mm Lines
Margin
4 hole punched



LINED

COLOURS



A4 REFILL PAD NARROW RULED

6253-REF Pack of 6 / Outer 36

PRODUCT DETAIL
Tape head-bound, card cover, metallic print on front

PAGE DETAIL
160 Pages
80 gsm
6mm Lines
Margin
4 hole punched



NARROW RULED

COLOURS



A4 REFILL PAD - SQUARED

REFSQD Pack of 6 / Outer 36

PRODUCT DETAIL
Size A4 Tape head-bound, card cover, metallic print on front

PAGE DETAIL
160 Pages
80 gsm
5mm Squares
4 hole punched



SQUARED

COLOURS





A4 REFILL PAD PLAIN

REFPLN Pack of 6 / Outer 36

PRODUCT DETAIL

Tape head-bound card cover, metallic print on front

PAGE DETAIL

160 Pages
80 gsm
8mm Lines
Margin
4 Hole Punched



PLAIN

COLOURS



A4 REFILL PAD - DUAL GRAPH

REFGRA Pack of 6 / Outer 48

PRODUCT DETAIL

Size A4
Tape head-bound, card cover, metallic print on front

PAGE DETAIL

100 Pages, 80 gsm
double sided 1, 5, 10 and 2, 10, 20mm Graph
4 hole punched

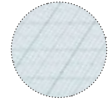

GRAPH

COLOURS



A4 MEMO PAD

A4-MEMO-80WB Pack of 10 / Outer 40

PRODUCT DETAIL

Manufactured from quality bond paper that accepts ink without bleeding or feathering and features a board back for rigidity. Each pad has 80 sheets of unpunched ruled white paper.

PAGE DETAIL

160 Pages per pad
80 gsm
8mm Lines
Size A4
Glued pads



LINED



A4 EXECUTIVE REFILL PAD

REFEXCYA4 Pack of 5 / Outer 50 (Yellow)

REFEXCWA4 Pack of 5 / Outer 50 (White)

PRODUCT DETAIL

Size A4, tape head-bound, Pukka Pad legal executive refill pad. Each page is made from high quality 60gsm paper complete with feint ruling & margin.

PAGE DETAIL

100 Pages
60 gsm
White or yellow paper, 8mm lines margin, features perforation for easy removal of sheets.



LINED

PUKKA RECYCLED RANGE

The Recycled Range reflects Pukka Pad's commitment to creating ethical, high quality products.

We are very proud to offer a premium quality recycled notepad range, so you can be sustainable in style.



REVAMPED DESIGN



A4/B5 RECYCLED PROJECT BOOKS

6050-REC Pack of 3 / Outer 12 (A4)
 6052-REC Pack of 3 / Outer 12 (B5)

PRODUCT DETAIL
 A4/ B5 Project Books with recycled dividers and 200 pages of 100% recycled 80GSM writing paper.

PAGE DETAIL
 200 Pages
 80 gsm
 8mm Lines



LINED

A4+ /A5 RECYCLED JOTTA NOTEPADS

RCA4110-3 Pack of 3 / Outer 30 (A4+)
 RCA5110-3 Pack of 3 / Outer 30 (A5)

PRODUCT DETAIL
 These environmentally friendly Pukka notebooks contain 110 pages of 100% recycled 80gsm paper, which is faint ruled with a margin for neat note-taking. The pages are perforated for easy removal.

PAGE DETAIL
 110 Pages, 80 gsm quality paper, 8mm Lines margin 4 hole punched (A4+ only)
 Page perforation



LINED



REVAMPED DESIGN



A4 RECYCLED REFILL PAD

RCREF50 Pack of 6 / Outer 36

PRODUCT DETAIL
 Size A4, tape head-bound
 100% recycled paper, card covers

PAGE DETAIL
 100 Pages
 80 gsm
 6mm Lines (Narrow ruled) margin
 4 hole punched



LINED



RECYCLED SHORTHAND PAD

RCSHRT160 Pack of 3 / Outer 48

PRODUCT DETAIL
 Size 128mm x 203mm
 100% Recycled paper, wire head-bound card covers

PAGE DETAIL
 160 Pages
 80 gsm
 8mm Lines



LINED

The Kraft Collection contains products of a classic design, created with high-quality materials that keep the environment in mind. Our notebooks come in a perfect pack of 3 meaning they are ideal for separate school subjects or work projects.



A4+/A5 KRAFT JOTTA NOTEPADS

9565-KRA Pack of 3 / Outer 15 (A4+)

9567-KRA Pack of 3 / Outer 30 (A5)

PRODUCT DETAIL

These eco-friendly Pukka notebooks contain 200 pages of white FSC recycled 80gsm paper, which is faint ruled with a margin for neat note-taking. The pages are perforated for easy removal and 4 hole punched (A4 Only) for filing in a ring binder or lever arch file. The notebook features kraft covers with a twin wire binding, allowing it to lie flat.

PAGE DETAIL

200 Pages, 80 gsm quality paper, 8mm Lines margin 4 hole punched (A4+ only)
Page perforation



LINED



A4 KRAFT PROJECT BOOK

9566-KRA Pack of 3 / Outer 12

PRODUCT DETAIL

A4 Kraft Project Book with a traditional design and 200 pages of premium quality 80GSM white FSC recycled paper.

PAGE DETAIL

200 Pages
80 gsm
8mm Lines



LINED

A4 KRAFT REFILL PAD

9568-KRA Pack of 5 / Outer 20

PRODUCT DETAIL

Size A4, tape side-bound white FSC recycled paper paper, punched hole card covers, ideal for separate school subjects or work projects.

PAGE DETAIL

400 Pages
80 gsm
8mm Lines with margin
4 hole punched



LINED

KRAFT RANGE

Made from 100% recycled materials, these black & kraft files are a responsible choice for the environment.



A4 RECYCLED RING BINDER FILES

- RF-9484 Outer 10 (Black)
- RF-9485 Outer 10 (Kraft)

PRODUCT DETAIL

Ring binder file. Board made from 100% recycled paper.
Standard D-ring mechanism
Ideal for keeping important papers organised and aligned

COLOURS



A4 RECYCLED LEVER ARCH FILES

- RF-9482 Outer 10 (Black)
- RF-9483 Outer 10 (Kraft)

PRODUCT DETAIL

Lever arch file. Board made from 100% recycled paper.
Standard lever arch mechanism, thumb hole for easy retrieval.
Can hold A4 documents,
2 Rings - 75 mm Rings, 70 mm Spine

COLOURS



FOOLSCAP RECYCLED BOX FILES

- RF-9486 Outer 8 (Black)
- RF-9487 Outer 8 (Kraft)

PRODUCT DETAIL

Foolscap box file. Board made from 100% recycled paper.
Press button catch for added security of papers
interior paper lock mechanism,
finger pull tab for easy shelf retrieval,
spine label for identification.

COLOURS



At Pukka Pads, when designing and creating any range we always keep the planet at the forefront of everything we do. But, we are always keen to be even greener, and went about designing something new. Our aim is to ditch the 'boring' stigma, and make saving the planet fun, cool and trendy with this new range.

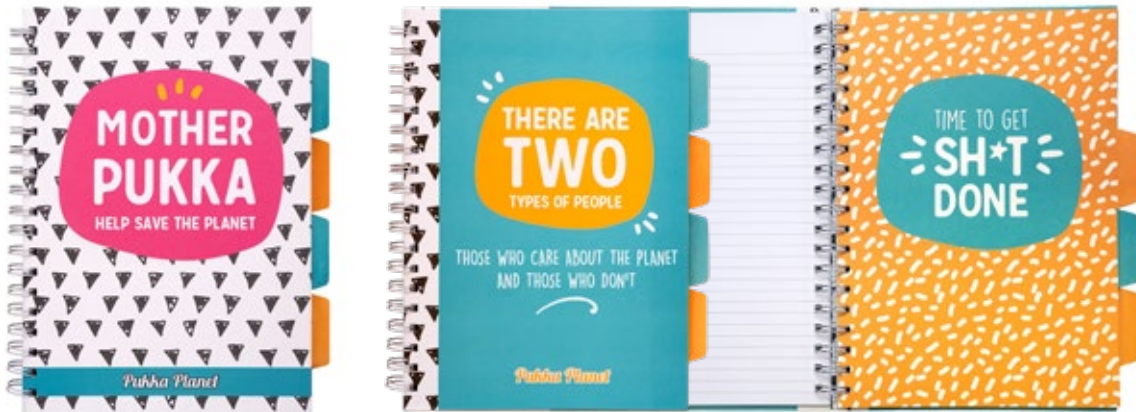

B5 PUKKA PLANET PROJECT BOOK

9702-SPP

Pack of 2 / Outer 12

PRODUCT DETAIL

Take notes in style with our Pukka Planet Project Books. Hardback cover design with silver wire, four colour coded re-positionable dividers and 200 pages of 100% recycled 80GSM writing paper.

PAGE DETAIL

200 Pages
80gsm Paper
8mm Feint Ruled
Perforated Pages



LINED



DIVIDERS





PUKKA PLANET NOTEPADS

9703-SPP	Outer 24 (130x210mm)
9704-SPP	Outer 24 (130x210mm)
9705-SPP	Outer 24 (130x210mm)
9706-SPP	Outer 24 (130x210mm)
9707-SPP	Outer 24 (130x210mm)

PRODUCT DETAIL
The Pukka Planet Notepads feature bright and vibrant covers and are made from 100% recycled paper. The notepad size is perfect for on-the-go note-taking.

PAGE DETAIL
192 Pages
90 gsm
8mm Lines
100% Recycled Paper



B5 CORK PROJECT BOOK

9856-SPP Outer 20
PRODUCT DETAIL
Hardback cover design made with cork material, four colour coded re-positionable dividers and 200 pages of 100% recycled 80GSM writing paper.
PAGE DETAIL
200 Pages
80gsm Paper
8mm Feint Ruled Perforated Pages



CORK NOTEBOOK

9855-SPP Outer 12
PRODUCT DETAIL
This notepad is made with cork material and is pleasant to the touch, 160 pages of 100% recycled 80gsm writing paper. The notepad size is perfect for on-the-go note-taking.



CORK PENCIL CASE

9740-SPP Pack of 6 / Outer 48
PRODUCT DETAIL
Rectangular case in real cork is made of a noble material that is pleasant to the touch. Cork is a recyclable material, waterproof, light and easy to wash, to keep the fun and playful design intact. Wipe clean. Size: 20.5 x 7cm.



B5 PUKKA PLANET MUTED PROJECT BOOK

9763-SPP Pack of 2 / Outer 12

PRODUCT DETAIL

Take notes in style with our Pukka Planet Muted Project Books. Hardback cover design with silver wire, four colour coded re-positionable dividers and 200 pages of 100% recycled 80GSM writing paper.

PAGE DETAIL

200 Pages
80gsm Paper
8mm Feint Ruled
Perforated Pages



LINED

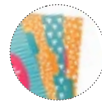

DIVIDERS

INNER LINING



9764-SPP



9765-SPP



PUKKA PLANET NOTEPADS

9764-SPP

Outer 24 (130x210mm)

9765-SPP

Outer 24 (130x210mm)

PRODUCT DETAIL

The Pukka Planet Muted Notepads feature bright and vibrant covers and are made from 100% recycled paper. The notepad size is perfect for on-the-go note-taking. So whether you need a notebook to use in lectures or school these notepads will be essential for you!

PAGE DETAIL

192 Pages
90 gsm
8mm Lines
100% Recycled Paper



LINED

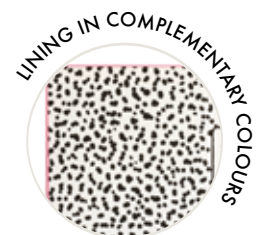



PUKKA PLANET MEMO BLOCK

9708-SPP Pack of 2 / Outer 24

PRODUCT DETAIL

Our compact memo block fits perfectly on your desk alongside our Pukka Planet stationery. The memo block comes with 4 patterned sides and is made from 100% recycled paper.

PAGE DETAIL

600 sheets
70gsm white plain paper
80mm x 80mm
Glue bound



B5 PUKKA PLANET DAILY PLANNER

9741-SPP Outer 24

PRODUCT DETAIL

The daily planner pad measures 17.6 cm x 25 cm and includes 60 tear-off daily sheets made from 100 GSM recycled paper, with its helpful daily planner pages, it's perfect for school students, university students, teachers and working professionals...the list is endless!

PAGE DETAIL

60 Pages
100gsm Paper
Glue bound
Daily view
Various sections



9709-SPP

9710-SPP

PUKKA PLANET BALLPOINT PENS (PK2)

9709-SPP Outer 50

9710-SPP Outer 50

PRODUCT DETAIL

Our premium gel pens are the perfect present for someone who's obsessed with stationery. Featuring classic black ink, a gold metal clip and debossed branding, writing out your daily notes will never be boring!

Our outer packaging is made entirely from sustainable paper and is 100% recyclable.



PUKKA PLANET PENCILS (PK6)

9738-SPP Outer 24 (Cactus)

9739-SPP Outer 24 (Green Vibes)

PRODUCT DETAIL

Our pencils are made with "care for the planet" notation in mind - hexagonal with HB graphite and white eraser on the top. Coloured in shades of our Pukka Planet range, they are a bright addition to your pencil case.

Our outer packaging is made entirely from sustainable paper and is 100% recyclable.

A Pukka Classic! The Stripes range is bold in both style and colour. Products in the Stripes range includes 80gsm pages and covers that will add a splash of colour to any project.



A4+/A5/A6 STRIPES JOTTA POLYPROP

JP018 (A4, 3/4) Pack of 3 / Outer 15 (A4+)
 JP021 (A5, 3/4) Pack of 3 / Outer 30 (A5)
 JP036 (A6, 3/4) Pack of 3 / Outer 72 (A6)

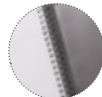

LINED

PRODUCT DETAIL

Wirebound
 Printed polyprop covers
 Assorted coloured packs

PAGE DETAIL

200 Pages
 80 gsm
 Ruled with margin
 4 hole punched (A4+ only)
 Page perforation



A4+/A5 STRIPES JOTTA POLYPROP

JP018 (5) Pack of 3 / Outer 15 (A4+)
 JP021 (5) Pack of 3 / Outer 30 (A5)



LINED

PRODUCT DETAIL

Wirebound
 Printed polyprop covers
 Assorted coloured packs

PAGE DETAIL

200 Pages
 80 gsm
 Margin & 4 Hole Punched (A4+ only)
 Page Perforation



A4/A5 STRIPES HARBACK PROJECT BOOK

CBPROBA4 Pack of 3 / Outer 12 (A4)
 CBPROBA5 Pack of 3 / Outer 24 (A5)

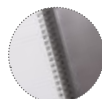

LINED



DIVIDERS

PRODUCT DETAIL

Wirebound
 Hardback cover
 Colour coded re-positionable dividers with storage pocket
 Assorted coloured packs

PAGE DETAIL

250 Pages
 80 gsm
 8mm Lines
 Page perforation



A4/A5 STRIPES PROJECT BOOK

PROBA4 Pack of 3 / Outer 12 (A4)
 PROBA5 Pack of 3 / Outer 24 (A5)

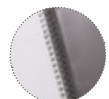

LINED



DIVIDERS

PRODUCT DETAIL

Wirebound
 Clear polyprop covers
 Colour coded re-positionable dividers with storage pocket
 Assorted coloured packs

PAGE DETAIL

250 Pages
 80 gsm
 8mm Lines
 Page Perforation

VOGUE RANGE

The Vogue collection includes A4 and A5 project books and jottas. These pads contain 200 pages of premium 80gsm paper with ruled 8mm lines which are perfect for school, work or personal use.



A4+/A5 VOGUE JOTTA NOTEPADS

37056 Pack of 3 / Outer 15 (A4+)
37057 Pack of 3 / Outer 30 (A5)

COLOURS



PRODUCT DETAIL

Wirebound
Printed card covers
Assorted coloured packs

PAGE DETAIL

200 Pages, 80 gsm, ruled with margin, 4 hole punched (A4+ only), page perforation



A4/A5 VOGUE PROJECT BOOKS

37046 Pack of 3 / Outer 12(A4)
37049 Pack of 3 / Outer 24(A5)

COLOURS



PRODUCT DETAIL

Wirebound, printed polyprop covers, colour coded re-positionable, dividers with storage pockets

PAGE DETAIL

200 Pages, 80 gsm
8mm Lines, page perforation

PP NEON RANGE

The PP Neon Range is a vibrant hard-wearing wipe clean polypropylene. Each notebook has an elastic closure and side bound wiring to ensure the safety of your notes.



A4+/A5 PP NEON NOTEPAD

7662-PPN (A4+) Pack of 3 / Outer 15
7663-PPN (A5) Pack 3 of Each / Outer 30



PRODUCT DETAIL

Side-bound, black PP covers, assorted coloured packs

PAGE DETAIL

200 Pages ruled paper, 80 gsm, margin 4 hole punched (A4+ only), page perforation



LINED



A4/A5 PP NEON PROJECT BOOK

7664-PPN (A4) Pack of 3 / Outer 12
7665-PPN (A5) Pack of 3 / Outer 24



PRODUCT DETAIL

Side-bound, black PP covers, re-positionable dividers with storage pockets, assorted coloured Packs

PAGE DETAIL

200 Pages ruled paper, 80 gsm, margin 4 hole punched (A4+ only), page perforation



LINED

Stand out from the crowd with the new Glee range! Geometric iridescent foil designs add a touch of style to these cover designs, available in green, dark blue or light blue.



A4+/A5 GLEE JOTTA NOTEPADS

- 3007-GLE (A4+) Pack of 3 / Outer 15 (Dark Blue)
- 3008-GLE (A4+) Pack of 3 / Outer 15 (Green)
- 3009-GLE (A4+) Pack of 3 / Outer 15 (Light Blue)
- 3010-GLE (A5) * Pack of 3 / Outer 30 (Dark Blue)
- 3011-GLE (A5) * Pack of 3 / Outer 30 (Green)
- 3012-GLE (A5) * Pack of 3 / Outer 30 (Light Blue)

* Special orders only (FOB)

PRODUCT DETAIL
 Card covers
 Silver twin wire
 Stylish geometric with iridescent design

PAGE DETAIL
 200 Pages
 80gsm paper
 8mm Feint ruled
 Perforated pages
 Margin, 4 hole punched (A4 only)

COLOURS

LINED



A4/A5 GLEE PROJECT BOOKS

- 3004-GLE (A4) Pack of 3 / Outer 12 (Dark Blue)
- 3005-GLE (A4) Pack of 3 / Outer 12 (Green)
- 3006-GLE (A4) Pack of 3 / Outer 12 (Light Blue)
- 8688(DE)-GLE (A5) Pack of 3 / Outer 24 (Dark Blue)
- 8688(GN)-GLE (A5) Pack of 3 / Outer 24 (Green)
- 8688(LE)-GLE (A5) Pack of 3 / Outer 24 (Light Blue)

PRODUCT DETAIL
 Clear polyprop cover
 Wire bound
 Colour coded re-positionable
 dividers with storage pockets
 Stylish geometric with iridescent design

PAGE DETAIL
 200 Pages
 80gsm Paper
 8mm Feint ruled
 Perforated pages

COLOURS

LINED



A5 GLEE JOURNALS

- 8685-GLE Pack of 3 / Outer 24 (Dark Blue)
- 8686-GLE Pack of 3 / Outer 24 (Green)
- 8684-GLE Pack of 3 / Outer 24 (Light Blue)

COLOURS



PRODUCT DETAIL

Card covers
Perfect bound
Stylish geometric
with iridescent design

PAGE DETAIL

96 Pages
80gsm
8mm Feint ruled
Elastic closure to protect your pages



A5 GLEE JOURNALS

- 8685-GLE (QUOTE) Pack of 3 / Outer 24 (Dark Blue)
- 8686-GLE (QUOTE) Pack of 3 / Outer 24 (Green)
- 8684-GLE (QUOTE) Pack of 3 / Outer 24 (Light Blue)

COLOURS



PRODUCT DETAIL

Card covers
Perfect bound
Stylish geometric
with iridescent design

PAGE DETAIL

96 Pages
80gsm
8mm Feint ruled
Elastic closure to protect your pages



A4 GLEE REFILL PADS SIDE-BOUND

- 8891-GLE Pack of 4 / Outer 20 (Dark Blue)
- 8892-GLE Pack of 4 / Outer 20 (Green)
- 8893-GLE Pack of 4 / Outer 20 (Light Blue)

COLOURS



PRODUCT DETAIL

Card covers
Design printed on inside and outside covers
with commonly misspelt words
Tape side-bound
Stylish geometric with iridescent design

PAGE DETAIL

400 Pages
80gsm
8mm Feint ruled
Margin
4 Hole punched



A4 GLEE STUD WALLETS

- 8703(DE)-GLE Pack of 12 / Outer 72
- 8703(GN)-GLE Pack of 12 / Outer 72
- 8703(LE)-GLE Pack of 12 / Outer 72

COLOURS



PRODUCT DETAIL

Stud wallet with fastening button
Holographic foil details
Sized to fit A4 - perfect for storing loose papers

Hold on to those summer vibes with the Pastels range. From small notepads to box files, this range has a lot to choose from! The collection comes in assorted packs of pink, blue and mint.



A4+/A5 PASTEL JOTTAS

8628-PST Pack of 3 / Outer 15 (A4+)
 8629-PST Pack of 3 / Outer 30 (A5)

PRODUCT DETAIL
 Card covers
 Silver twin wire
 Design printed on inside and outside cover

PAGE DETAIL
 200 Pages
 80gsm paper
 8mm Feint ruled
 Margin (A4+ only)
 Perforated pages
 4 Hole punched (A4+ only)

COLOURS

LINED



A4/A5 PASTEL PROJECT BOOKS

8630-PST Pack of 3 / Outer 12 (A4)
 8631-PST Pack of 3 / Outer 24 (A5)

PRODUCT DETAIL
 Polyprop cover
 Wire bound
 Colour coded re-positionable dividers with storage pockets

PAGE DETAIL
 200 Pages
 80gsm Paper
 8mm Feint ruled
 Perforated pages

LINED

COLOURS



PASTEL REPORTER'S PAD

8907-PST Pack of 3 / Outer 36

PRODUCT DETAIL	PAGE DETAIL	COLOURS
Card covers	160 Pages	
Wirebound	80gsm	
Head-bound	8mm Feint ruled	
Design printed on inside and outside covers	Perforated pages Personal details page	



A7 PASTEL POCKET BOOKS

8903-PST Pack of 6 / Outer 48

PRODUCT DETAIL	PAGE DETAIL	COLOURS
Card covers	100 pages	
Wirebound	80gsm	
Head-bound	8mm Feint ruled	
Design printed on inside and outside covers	Perforated pages Personal details page	



A4 PASTEL REFILL PADS TOPBOUND

8865-PST Pack of 6 / Outer 36 (A4)

PRODUCT DETAIL	PAGE DETAIL	COLOURS
Card Covers	160 Pages	
Design Printed on Inside and Outside Covers	80gsm	
Tape Headbound	8mm Feint ruled Margin 4 Hole punched	



A4 PASTEL REFILL PADS SIDEBOUND

8902-PST Pack of 3 / Outer 18 (A4)

PRODUCT DETAIL	PAGE DETAIL	COLOURS
Card Covers	400 Pages	
Design Printed on Inside and Outside Covers	80gsm	
Tape Sidebound	8mm Feint ruled Margin 4 Hole punched	



PASTEL PENCIL CASES

8887-PST CDU of 6

PRODUCT DETAIL

Transparent PVC
Colour coded zip
Silver plastic zipper head
Holds up to 30-50 pencils/pens

SIZE

L 21 x W 7 x H 10 cm

COLOURS



A4 PASTEL RING BINDER FILES

9056-PST Outer 10 (Blue/Pink)

PRODUCT DETAIL

Paper-board file
Standard D-ring mechanism
Printed inner index & note organiser

COLOURS



A4 PASTEL LEVER ARCH FILES

9057-PST Outer 10 (Blue/Pink)

PRODUCT DETAIL

Paper-board file, standard lever arch mechanism, thumb hole for easy retrieval, printed inner index & note organiser.
Can hold A4 documents
2 Rings - 75 mm Rings, 70 mm Spine

COLOURS



FOOLSCAP PASTEL BOX FILES

9058-PST Outer 10 (Blue/Pink)

PRODUCT DETAIL

Paper-board file
Press button catch for added security of papers interior paper lock mechanism, finger pull tab for easy shelf retrieval, spine label for identification, printed inner index & note organiser

COLOURS





A4 R&J ROLLBOUND RINGBINDER PRELOADED

- 9625-ROC Outer 12 (Black)
- 9626-ROC Outer 12 (Pink)
- 9627-ROC Outer 12 (Lilac)

PRODUCT DETAIL

The ringbinders come preloaded with a set of coordinating 5-part reversible dividers. The binders have two D-rings to keep everything secure. They're perfect for organising things for school, work, and more!

COLOURS



A4 R&J REVERSIBLE DIVIDERS

- 9628-ROC 20 Sets / Outer 100

PRODUCT DETAIL

Reversible dividers let you choose from stylish designs or flip over for bright bold colours. The dividers are 4-hole punched with reinforced holes for extra durability, features five subtle golden floral details and cute pastel colours. Made of high-quality 250GSM board, these dividers are ideal for even the most aggressive page flippers



A4 R&J LEVER ARCH FILES

- 9629(AST)-ROC Outer 3 (Black/Pink/Lilac)

PRODUCT DETAIL

Paper-board file, standard lever arch mechanism. The spine features a thumb hole for easy retrieval, allowing you to slide out the file you want without disrupting your whole shelf. This file is designed to hold A4 documents, 21 x 29 cm, with 2-hole lever arch locking mechanism, the spine measures 70mm

COLOURS



FOOLSCAP R&J BOX FILES

- 9632(AST)-ROC Outer 3 (Black/Pink/Lilac)

PRODUCT DETAIL

Designed to protect and organise your most important papers, the foolscap file boxes from Pukka Pad are made of premium quality paperboard. The Rochelle & Jess Box Files feature gold foil detail and contrasting gold interior to make your home and office shine. The interior has a paper lock mechanism with a press button catch that holds your documents securely in place.

COLOURS





B5 ROCHELLE & JESS PROJECT BOOK

9447-ROC Pack of 3 / Outer 12

PRODUCT DETAIL

Take notes in style with our Rochelle and Jess Project Books. Hardback cover features a hot foil design on the cover with gold wire bound, four colour coded re-positionable dividers with storage pockets. Smart elastic strap closure perfect for keeping notes and loose documents safe

PAGE DETAIL

200 Pages
80gsm Paper
8mm Feint ruled
Perforated pages

COLOURS



MATCHING PRODUCTS
PAGE 32
PAGE 49



B5 COLOUR WASH PROJECT BOOK

9032-CD Pack of 3 / Outer 12

PRODUCT DETAIL

Hardback cover, wire bound, colour coded re-positionable dividers with storage pockets, stylish fashion design (pack of 3: colour wash, rainbow, llama)

PAGE DETAIL

200 Pages
80gsm Paper
8mm Feint Ruled
Perforated Pages

SIZE

B5 (176 x 250 mm)



B5 FLORAL LOVE PROJECT BOOK

9033-CD Pack of 3 / Outer 12

PRODUCT DETAIL

Hardback cover, wire bound, colour coded re-positionable dividers with storage pockets, stylish fashion design (pack of 3: heart, geometric, navy floral)

PAGE DETAIL

200 Pages
80gsm Paper
8mm Feint ruled
Perforated pages

SIZE

B5 (176 x 250 mm)



Embrace your wild side, and snap up our roarsome new range. Wild is available in co-ordinating designs, combining faux crocodile and python skin with glossy tiger and zebra stripes. From project books to pens, this range really does deliver style at its finest and fiercest.



A5 PROJECT BOOK

8927-WLD Pack of 4 / Outer 24

PRODUCT DETAIL

- Vellum paper
- Gold twin wire
- Black Dividers with gold foiling
- Divider label sticker sheet
- Co-ordinating lining

PAGE DETAIL

- 160 Pages
- 90 gsm
- 8mm Lines
- Page perforation
- Elastic closure



LINED



DIVIDERS



PENCIL CASE

8941-WLD Pack of 4 / Outer 48 (Crocodile)

PRODUCT DETAIL

- Debossed crocodile effect PU and gold patent PU
- Debossed gold metal zip pull
- Black inner lining
- Gold zip



NOTEPAD WITH POCKET

8926-WLD(CE) Pack of 4 / Outer 32 (130x210mm)

8926-WLD(PN) Pack of 4 / Outer 32 (130x210mm)

PRODUCT DETAIL

- Vellum paper
- Gold foil page edges
- Ribbon bookmark
- Paper pocket

PAGE DETAIL

- 192 Pages
- 90 gsm
- 8mm Lines
- Elastic closure



LINED



PREMIUM BALLPOINT PENS

8931-WLD(CE) Pack of 4 / Outer 24 (Crocodile)

8931-WLD(TR) Pack of 4 / Outer 24 (Tiger)

8931-WLD (ZA) Pack of 4 / Outer 24 (Zebra)

PRODUCT DETAIL

- Black ink
- Gold metal clip with debossed branding
- Display box with gold foil and ribbon hanger
- Compatible with standard ballpoint pen refills

Expand your Wild collection with additions in leopard, zebra and tiger print. These items bold new prints with some of our most popular products, to create a range that combines fun with productivity.



B5 PROJECT BOOK

9523(AST)-WLD Pack of 2 / Outer 12 (Assorted)

PRODUCT DETAIL

White paper
Gold twin wire
Black & orange dividers
Holographic foil details
Co-ordinating lining

PAGE DETAIL

200 Pages
80 gsm
8mm Lines
Page perforation
Elastic closure



LINED



DIVIDERS



A4+ JOTTA NOTEBOOK

9521 (AST)-WLD Pack of 2 / Outer 12 (Assorted)

PRODUCT DETAIL

White paper
Gold twin wire
Holographic foil details
Co-ordinating lining

PAGE DETAIL

160 Pages
80 gsm
8mm Lines
Page perforation
4 Hole Punched



LINED



A4 REFILL PAD

9525(AST)-WLD Pack of 2 / Outer 36 (Assorted)

PRODUCT DETAIL

White paper
Tapebound
Holographic foil details

PAGE DETAIL

160 Pages
80 gsm
8mm Lines
4 Hole Punched



LINED



A4 CLIPBOARD

9529(AST)-WLD Pack of 3 / Outer 24 (Assorted)

PRODUCT DETAIL

Sized to fit A4 paper
Gold clip mechanism
Holographic foil details

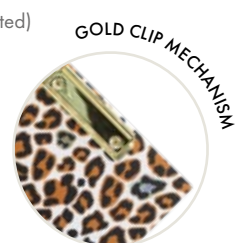

GOLD CLIP MECHANISM



A4 STUD WALLET

9527(AST)-WLD Pack of 3 / Outer 72 (Assorted)

PRODUCT DETAIL

Stud wallet with gold button fastening
Holographic foil details
Sized to fit A4 - perfect for storing loose papers

MEMO BLOCK

9535-WLD Pack of 2 / Outer 24

PRODUCT DETAIL

500 sheets
70gsm white paper
3 patterned sides & 1 with holographic foil finish



DIVIDERS PRE-LOADED INSIDE



5 TAB SUBJECT DIVIDERS

9531-WLD Pack of 20 / Outer 100

PRODUCT DETAIL

Five different designs
250gsm board
Holographic foil details
Flip upside down for bold colours
11 hole punched to fit all types of binder

ROLLBOUND RINGBINDERS

9532-WLD (Leopard)

Outer 12

9533-WLD (Zebra)

Outer 12

PRODUCT DETAIL

Rollbound
Holographic foil details
2 ring mechanism inside
Co-ordinating lining
Pre-loaded with matching 5 tab subject dividers



The Bloom Range is here to make a statement and help you live life in full bloom. Available in three complementary floral prints, with holographic foiling for a touch of drama.



B5 BLOOM PROJECT BOOK

9494-BLM(ASST) Pack of 3 / Outer 12 (Assorted)

PRODUCT DETAIL
Ivory paper
Holographic twin wire
Patterned dividers
Holographic foil details

PAGE DETAIL
200 Pages
80 gsm
8mm Lines
Page perforation
Elastic closure



LINED



DIVIDERS

A4+ BLOOM JOTTA NOTEBOOK

9497-BLM(ASST) Pack of 3 / Outer 15 (Assorted)

PRODUCT DETAIL
White paper
Silver wire
Holographic foil details
Rounded corners

PAGE DETAIL
160 Pages
80 gsm
8mm Lines
Page perforation
4 Hole Punched



LINED



BLOOM SOFTCOVER NOTEBOOK

9491-BLM Pack of 3 / Outer 24 (Blue)
9493-BLM Pack of 3 / Outer 24 (Cream)
9492-BLM Pack of 3 / Outer 24 (Black)

PRODUCT DETAIL
Ivory Paper
Bookmark ribbon
Holographic foil page edges

PAGE DETAIL
192 Pages
90 gsm
Elastic closure



LINED



B5 BLOOM COMPOSITION BOOK

9516-BLM / Outer 48 (Assorted)

PRODUCT DETAIL
Tape-bound
Holographic foil details
Rounded corners

PAGE DETAIL
140 Pages
80 gsm
Wide ruled



LINED

Whether you're planning, note-taking or filing, Bloom has the stylish solution for you. The range includes notepads, visitor books, planners, padfolios and filing.



A4 BLOOM VISITORS BOOK IN BLACK

9687-BLM Outer 12

PRODUCT DETAIL

Our beautiful Bloom visitors book will help you keep on track of who is visiting your business. The visitors book is perfect for all business establishments including bed & breakfasts and boutique hotels. It is A4 in size and features a durable hardback cover with holographic foil details on the front and back.

PAGE DETAIL

120 GSM paper, 96 pages
768 entries
Product size: A4
Space for date, name/ address and comment



A4 BLOOM VISITORS BOOK IN CREAM

9688-BLM Outer 12

PRODUCT DETAIL

Our beautiful Bloom visitors book will help you keep on track of who is visiting your business. The visitors book is perfect for all business establishments including bed & breakfasts and boutique hotels. It is A4 in size and features a durable hardback cover with holographic foil details on the front and back.

PAGE DETAIL

120 GSM paper, 96 pages
768 entries
Product size: A4
Space for date, name/ address and comment



THINGS TO DO PAGES INSIDE



A5 BLOOM DAILY PLANNER PADS

9742-BLM / Black Outer 12

9743-BLM / Pink Outer 12

PRODUCT DETAIL

Our A5 planner helps you to write all of your tasks in one place and allows you to track your progression. The pad is wirebound, great for using at the side of your desk or for taking to school or university. Each pad contains 115 sheets of 80 GSM paper with a variety of sections. Included in the pad is a section for your to do's, a scheduler table, a box section and a place for you to sketch and leave notes. Stylish cover with holographic foil finish.

PAGE DETAIL

115 Sheets
80 GSM paper
'To Do' pages
Page perforation
Preprinted to do, dates, schedule and notes tables



A3 BLOOM MONTHLY WALL PLANNER PAD

9744-BLM Outer 25 (Black)

PRODUCT DETAIL

Organise, plan and prioritise your daily tasks with our monthly wall planner. Features a large 7x5 grid with handy check-boxes and spacious 'Notes' section to organise appointments, dates, events or deadlines. 12 sheets of sleek matt 100gsm non-bleed and smudge-resistant quality paper give you an effortless feeling while jotting down your daily tasks in our undated monthly planner pad.

PAGE DETAIL

100 GSM paper
12 Sheets
Sturdy wire binding at the top
Size: A4 (Landscape)



A3 BLOOM MONTHLY WALL PLANNER PAD

9745-BLM Outer 25 (Cream)

PRODUCT DETAIL

Organise, plan and prioritise your daily tasks with our monthly wall planner. Features a large 7x5 grid with handy checkboxes and spacious 'Notes' section to organise appointments, dates, events or deadlines. 12 sheets of sleek matt 100gsm non-bleed and smudge-resistant quality paper give you an effortless feeling while jotting down your daily tasks in our undated monthly planner pad.

PAGE DETAIL

100 GSM paper
12 Sheets
Sturdy wire binding at the top
Size: A4 (Landscape)



BLOOM MEMO BLOCK

9514-BLM Pack of 2 / Outer 24

PRODUCT DETAIL

Our compact memo block fits perfectly on your desk alongside our Bloom stationery. The memo block comes with 3 patterned sides and 1 side with holographic foil finish

PAGE DETAIL

500 sheets
70gsm white plain paper
80mm x 80mm x 43mm
Glue bound



B6 BLOOM EXERCISE BOOKS

9503-BLM Set of 4 packs of 3 / Outer 72

PRODUCT DETAIL

Stitched side binding
Holographic foil details
Smooth rounded edges
Stitched binding ivory paper

PAGE DETAIL

80 Pages
80gsm Paper
7mm Feint ruled



A4 BLOOM LEVER ARCH FILES

9635(AST)-BLM Outer 3 (Black/Cream/Blue)

PRODUCT DETAIL

Paper-board file, standard lever arch mechanism. The spine features a thumb hole for easy retrieval, allowing you to slide out the file you want without disrupting your whole shelf. This file is designed to hold A4 documents, 21 x 29 cm, with 2-hole lever arch locking mechanism, the spine measures 70mm



FOOLSCAP BLOOM BOX FILES

9638(AST)-BLM Outer 3 (Black/Cream/Blue)

PRODUCT DETAIL

Our Bloom box files are ideal for creating an organised home or workspace. The box files feature a handy securing arm inside to keep your documents and other items in place. These beautiful files are foolscap size meaning there is enough room for A4 documents to comfortably sit inside, offering space for up to 500 sheets of paper. The Bloom box files are sold in an assorted pack of 3 including a black, blue and cream file.



A4 BLOOM PADFOLIO WITH REFILL

9580-BLM Pack of 3 / Outer 18 (Blue)
 9582-BLM Pack of 3 / Outer 18 (Cream)
 9581-BLM Pack of 3 / Outer 18 (Black)

PRODUCT DETAIL

A4 refill pad inside
 Storage pocket on inside cover
 Holographic foil details



POCKET FOR LOOSE PAPER



A4 BLOOM CLIPBOARD

9508(AST)-BLM Pack of 3 / Outer 24 (Assorted)

PRODUCT DETAIL

Sized to fit A4 paper
 Holographic clip mechanism
 Holographic foil details



HOLOGRAPHIC CLIP MECHANISM



A4 BLOOM STUD WALLET

9511(AST)-BLM Pack of 3 / Outer 72 (Assorted)

PRODUCT DETAIL

Stud wallet with silver button fastening
Holographic foil details
Sized to fit A4 - perfect for storing loose papers



A4 BLOOM POCKET PORTFOLIO

9517-BLM Pack of 24 / Outer 144 (Assorted)

PRODUCT DETAIL

Sized to fit A4 paper
Holographic foil details
Two storage pockets inside

SPECIAL ORDERS ONLY



STORAGE POCKETS INSIDE



5 TAB SUBJECT DIVIDERS

9504-BLM Pack of 20 / Outer 100

PRODUCT DETAIL

Five different designs
250gsm board
Holographic foil details
Flip upside down for bold colours
11 hole punched to fit all types of binder



BLOOM ROLLBOUND RINGBINDERS

9505-BLM Outer 18 (Blue)	Outer 12
9507-BLM Outer 18 (Cream)	Outer 12
9506-BLM Outer 18 (Black)	Outer 12

PRODUCT DETAIL

Roll-bound
Holographic foil details
2 ring mechanism inside
Pre-loaded with matching 5 tab subject dividers



DIVIDERS PRE-LOADED INSIDE



SUBJECT DIVIDERS WITH 5 DESIGNS

Our Carpe Diem range is cute, simple and helpful. It's designed to inspire you to live the most organised, beautiful life possible. Keeping on top of your schedule can be a challenge, but it's easier with the right tools. Plan out every detail with our 2024 Carpe Diem diaries.

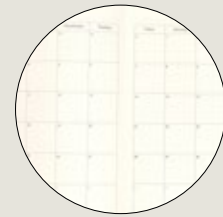

MONTHLY PLANNER PAGES



WEEK TO VIEW SPREADS



PAPER ENCLOSED POCKET

CARPE DIEM 2024 DIARY

Pink/Blue/Black

PRODUCT DETAIL

Soft Cover, 192 pages of 80 GSM acid free cream paper with yearly and monthly calendars, week to view spreads, lined notes pages and 12 month overviews.

PAGE DETAIL

192 Pages
80gsm Paper
Perforated Pages
12 Monthly overviews

SIZE

130 x 210 mm



COLOURS

-  9691-CD Black- Outer 24
-  9692-CD Pink- Outer 24
-  9693-CD Blue- Outer 24





B5 VOCABULARY BOOK (520 WORDS)



9599-VOC

Outer 12

PRODUCT DETAIL

The vocab book includes a variety of sections including:

- The word class. (noun, verb, adverb, adjective, or other)
- the word itself.
- definition of the word.
- The word in a sentence.
- synonym of the word.
- antonym of the word.

PAGE DETAIL

100 GSM paper.
130 Pages.
Repositionable A-Z alphabetical dividers.
Space for 520 words.
Vocabulary book to help with learning new words.

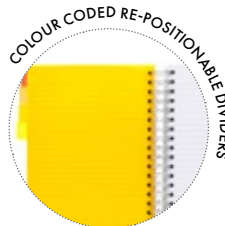
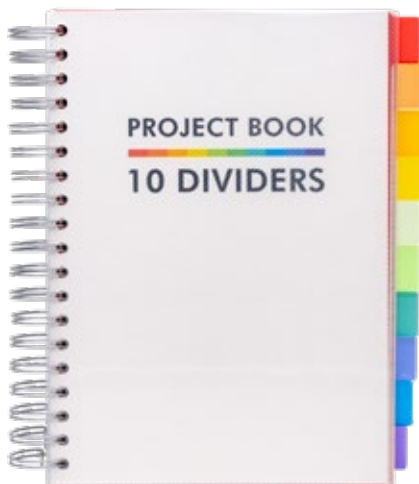

B5 WHITE PROJECT BOOK WITH 10 DIVIDERS

9603-PB

Outer 12

PRODUCT DETAIL

Perfect for splitting up your subjects for school or university but still having everything in the same place for ease of use. Our 400 page project book is split up into 10 colourful repositionable dividers. Each notebook features 200 sheets of premium 80GSM paper to prevent ghosting and bleeding, keeping each page fresh and clean.

PAGE DETAIL

400 Pages
80gsm Paper
8mm Feint ruled
Perforated pages



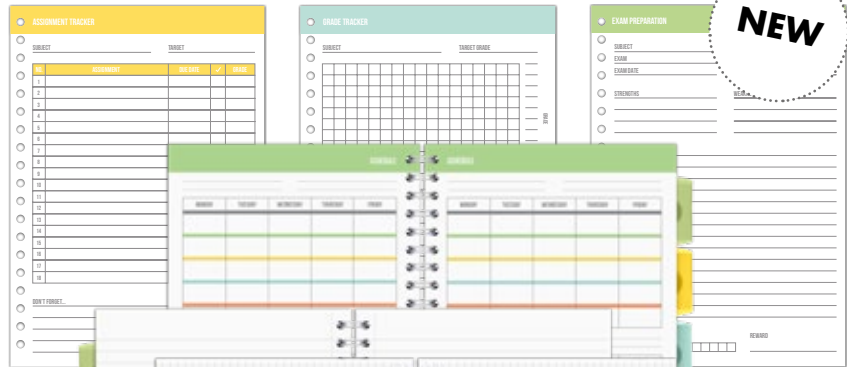
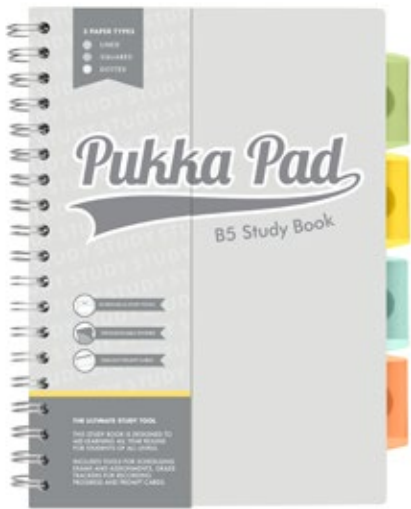

NEW

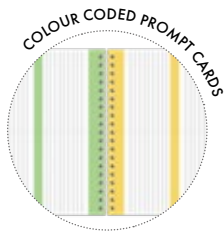

COLOUR CODED PROMPT CARDS

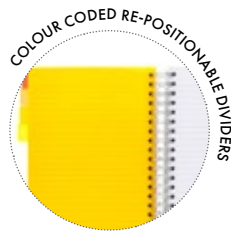

COLOUR CODED RE-POSITIONABLE DIVIDERS

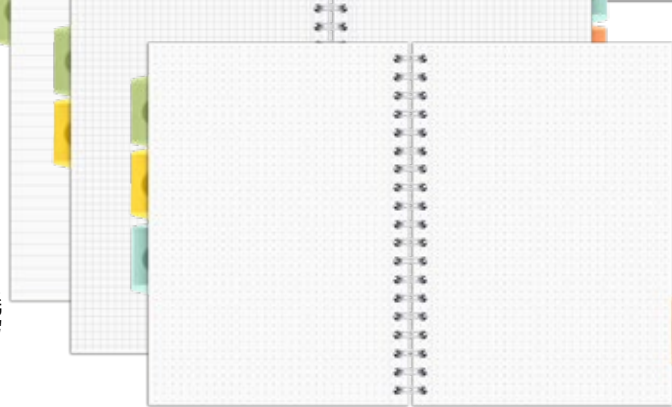

3 different paper types:
lined, squared and dotted

B5 STUDY BOOK WITH 4 DIVIDERS

9824-STU

Outer 12

PRODUCT DETAIL

Minimal, unisex cover design with tear-off fly sheet
Repositionable pp dividers in four pastel shades
Designed for study & revision includes time-planning tools, grade trackers and study tips. Tear-out prompt cards, five sheets of perforated, colour coded prompt cards to aid revision

PAGE DETAIL

B5 size - 3 different paper types: lined, squared and dotted (40 sheets each)
Three pages of schedules (2 per page)
Four pages of assignment trackers
Two pages of grade trackers (2 per page)
Eight exam preparation pages
Five sheets of colour-coded, perforated revision cards

BRIGHTS HIGHLIGHTER PENS (5 PACK)

9604-PEN

Outer 10

PRODUCT DETAIL

Using our chisel tip you will be able to highlight important words and notes in school books, university notes, and work notes. Non-Toxic water based ink, smudge resistant and easy to grip barrel. Great for hand lettering and bullet journals.

COLOURS

Pack of 5 colours:
Yellow, Pink, Orange, Green, Blue



CHISEL TIP FOR ACCURACY



5 VIBRANT COLOURS



This Record and Revision collection includes must have items for exam notes, interviews, presentation cues and keeping your business and personal directory in order.



1



1

TINTED RULED RECORD CARDS

	CODE	DETAIL	PACK	COLOUR	DESCRIPTION
1	16099	5 X 3"	10	Pastel	Ruled
2	16199	6 X 4"	10	Pastel	Ruled

PRODUCT DETAIL

Quality 160gsm board record cards. Can be written or typed on for card indexing systems. Assorted contains 25 Blue, Pink, Green and Yellow. Branding updated to Pukka from Concord

WIREBOUND REVISION CARDS

	CODE	DETAIL	PACK	OUTER	COLOUR	DESCRIPTION
1	16118	6 X 4"	10	60	White	Ruled
2	16119	6 X 4"	10	60	Assorted	Ruled

PRODUCT DETAIL

Make revision easy by recording those important facts on these revision note pads and record cards which contain 50 ruled cards. With a strong sheets to keep your notes secure. Ideal for student, home or office use. Assorted colours. Branding updated to Pukka from Concord



3



2



1



MULTICOLOUR GUIDE CARDS

	CODE	DETAIL	PACK	COLOUR	DESCRIPTION
1	15198	5 X 3"	10	Assorted	A-Z
2	15298	6 X 4"	10	Assorted	A-Z
3	15398	8 X 5"	10	Assorted	A-Z

PRODUCT DETAIL

Card for separating information with multicolour reinforced tabs for easy visual identification and durability. 300gsm board. Branding updated to Pukka from Concord

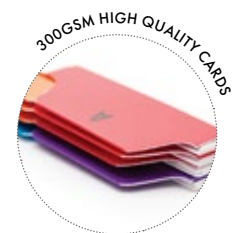



WHITE RULED RECORD CARDS

CODE	DETAIL	PACK	COLOUR	DESCRIPTION	
1	16001	5 X 3"	10	White	A-Z
2	16101	6 X 4"	10	White	A-Z
3	16201	8 X 5"	10	White	A-Z

PRODUCT DETAIL

These cards are a perfect solution to fill in your index box. Measuring 76 x 127 mm, they are ruled on both sides, these record cards are available in three sizes. Branding updated to Pukka from Concord



400 WHITE RULED RECORD CARDS (6 X 4")

16301	Outer 12
-------	----------

PRODUCT DETAIL

Box of 400 white ruled record cards
 Packaged in recyclable cardboard box
 Eco-friendly and 100% plastic free
 High quality 160 gsm paper
 Designed to be suitable for both students and businesses



The smooth finish on the Soft Cover notebooks provides a luxurious feel, but still allows them to be opened fully and laid flat when required. Each Soft Cover notebook contains 192 cream coloured, lined pages of 80gsm, acid-free paper. These notebooks also feature a useful page marker ribbon and an elasticated closure which can be used as a bookmark.



SIGNATURE PU NOTEPADS (210 x 130mm)

7747-SIG Pack of 5 / Outer 20

PRODUCT DETAIL

The Signature Notebooks feature bright and vibrant soft covers and an additional expandable pocket for storing loose sheets of paper. A ribbon page marker helps you keep your place and the elasticated closure keeps contents secure. This pack contains five notebooks in assorted colours. Size 210 x 130mm.

PAGE DETAIL

192 Pages
80 gsm
Acid free cream paper
8mm Lines



LINED

COLOURS



A4/A5 SOFT COVER NOTEBOOK

6980-SCN Pack of 3 / Outer 12 (A4 – 285 x 204mm)

6981-SCN Pack of 3 / Outer 24 (A5 – 210 x 144mm)

PRODUCT DETAIL

Case-bound
Soft covers
Page marker ribbon
Embossed branding
Sleeves in two stylish colours

Expandable inside pocket
Elasticated closure
Individually poly bagged
Assorted coloured packs

PAGE DETAIL

192 Pages
80 gsm
Acid free cream paper
8mm Lines



LINED

COLOURS



COLOUR RANGE



Pukka Pads coloured notepads have been designed with guidance from the Irlen Institute who specialise in products for those with visual perception difficulties. With the use of formulated coloured paper and tinted ruling with margin, the coloured pads can help those with Irlen syndrome and/or Dyslexia. Located within the inside front cover of the pad is a visual stress self-testing form. This will help anyone with Irlen syndrome to assess which colour pad they are most suited to.



A4 COLOURED IRLÉN NOTEPAD

IRLREF50 (ROSE)	Pack of 6 / Outer 30	IRLREF50 (GREEN)	Pack of 6 / Outer 30
IRLREF50 (LAV)	Pack of 6 / Outer 30	IRLREF50 (GOLD)	Pack of 6 / Outer 30
IRLREF50 (TURQ)	Pack of 6 / Outer 30		

PRODUCT DETAIL

Ideal for customers with dyslexia/visual perception difficulties.

- Designed with guidance from the Irlen Institute.
- Coloured paper and tinted 8mm ruling with margin, proven to reduce perpetual difficulties.
- Inner cover visual stress self-testing form assesses which colour pad you are most suited to.
- Tape head-bound Refill.

PAGE DETAIL

100 Pages
80 gsm
Tinted 8mm lines with margin
4 Hole punched

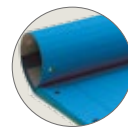

LINED

COLOURS



A4/A5 COLOURED IRLÉN JOTTAS

8628-PST	Pack of 3 / Outer 15 (A4+)
8629-PST	Pack of 3 / Outer 30 (A5)

PRODUCT DETAIL

Card covers
Silver twin wire
Design printed on inside and outside cover

PAGE DETAIL

200 Pages
80gsm paper
Tinted 8mm Feint ruled
Margin (A4 only)
Perforated pages

COLOURS





BLACK BUSINESS RANGE

If you're looking for a formal, professional notebook, then this range has you covered! The Black Business range will keep your organised and professional for all your meetings and work-related activities.

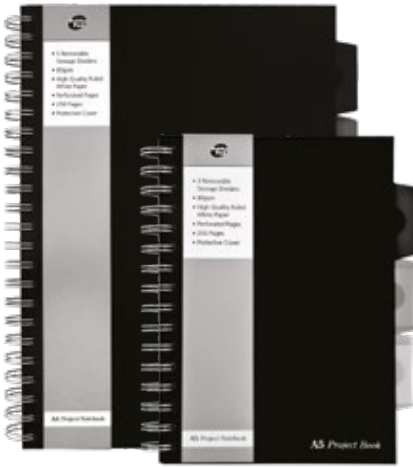

A4/A5 BLACK PROJECT BOOK

SBPROBA4 Pack of 3 / Outer 12 (A4)
SBPROBA5 Pack of 3 / Outer 24 (A5)

PRODUCT DETAIL	PAGE DETAIL
Wirebound, polyprop covers, personal details page, world map, colour coded re-positionable dividers with storage pockets	250 Pages 80 gsm 8mm Lines Page perforation



A4/A5 BLACK WIREBOUND PAD

SBWRULA4 Pack of 5 / Outer 20 (A4)
SBWRULA5 Pack of 5 / Outer 40 (A5)

PRODUCT DETAIL	PAGE DETAIL
Wirebound, hard backed linen covers, world map, personal details page	160 Pages 90 gsm 8mm Lines Margin (A4 only) Page Perforation



A4+/A5 JOTTA POLYPROP

SBJPOLYA4 Pack of 3 / Outer 15 (A4+)
SBJPOLYA5 Pack of 3 / Outer 30 (A5)

PRODUCT DETAIL	PAGE DETAIL
Wirebound, polyprop covers, elasticated closure, personal details page, world map	160 Pages 80 gsm, 8mm Lines, margin & 4 Hole punched (A4+ only) Page Perforation



A4/A5 BLACK CASEBOUND PAD

SBRULA4 Pack of 5 / Outer 20 (A4)
SBRULA5 Pack of 5 / Outer 40 (A5)

PRODUCT DETAIL	PAGE DETAIL
Case-bound, hard backed linen covers, page marker ribbon, personal details page, world map	192 Pages 90 gsm 8mm Lines Margin (A4 only)



A4+ BLACK MEETING PAD

SBMETA4160 Pack of 3 / Outer 15

PRODUCT DETAIL	PAGE DETAIL
Wirebound, polyprop covers, elasticated closure, business card holder, A4 storage pocket, printed page headings for meeting notes, personal details page, world map	160 Pages, 90 gsm, 8mm lines meeting pages, title, location, date, page perforation



A7 POCKET BOOK & PENCIL

SBPOCKET129/72 Pack of 6 / Outer 72

PRODUCT DETAIL	PAGE DETAIL
Size 86x129mm, head-bound, elasticated closure, elasticated pencil holder and pencil	200 Pages 60 gsm 8mm Lines

SILVER RANGE

The Silver range has a silver finish applied to the covers for a luxurious and sophisticated look. All the notebooks include high quality 90gsm paper.



A4/A5 SILVER WIREBOUND PAD

WRULA4 Pack of 5 / Outer 20 (A4)
WRULA5 Pack of 5 / Outer 40 (A5)

PRODUCT DETAIL

The silver finish applied to the covers on these notebooks gives them a luxurious look. Hard backed covers with world map

PAGE DETAIL

160 Pages
90 gsm
8mm Lines
Margin (A4 only)
Page perforation



LINED



A4/A5 SILVER CASEBOUND PAD

RULA4 Pack of 5 / Outer 20 (A4)
RULA5 Pack of 5 / Outer 40 (A5)

PRODUCT DETAIL

Hard-wearing covers, personal details page, world map

PAGE DETAIL

192 Pages
90 gsm
8mm Lines
Margin (A4 only)
Page marker ribbon



LINED

BLUE MANUSCRIPT RANGE

Fully cased notebooks ideal for documenting important records. The hard wearing linen-effect covers endure heavy usage. Feint ruled and printed on high quality white paper.



A4 BLUE CASEBOUND PAD

212944 Pack of 5 / Outer 20 (A4)
212969 Pack of 5 / Outer 40 (A5)
212993 Pack of 5 / Outer 60 (A6)

PRODUCT DETAIL

Case-bound hardback cover: Sturdy, long lasting and durable linen hardback cover, the binding gives a professional look and permanently keeps your notes in place, includes page marker ribbon

PAGE DETAIL

A4 notebook ruled, 192 pages, 96 sheets
Paper quality: 70 gsm paper, 8mm Lines
Margin (A4 only)

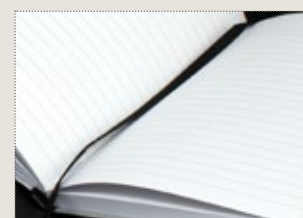

LINED

500 Micron hard glazed mottled pressed board covers available in assorted colours. This collection includes both sidebound and topbound pads, as well as convenient Major and Minor Pads.



A4 SIDEBOUND PAD

7267-PRS Pack of 10 / Outer 20

PRODUCT DETAIL

Side wirebound, 500 micron board thickness. Assorted colours

COLOURS



PAGE DETAIL

The smooth, white, 80gsm pages feature faint 8mm lines, margins and perforations for easy and clean removal. Pack contains 10 notebooks with 120 pages each.



A4 SIDEBOUND PAD

7268-PRS Pack of 10 / Outer 20

PRODUCT DETAIL

Side wirebound, 500 micron hard glazed mottled pressboard covers. Assorted colours of pink, purple, turquoise, lime and lemon

PAGE DETAIL

120 Pages, 80 gsm faint ruled white paper, micro-perforated pages for easy removal

COLOURS



A5 SIDEBOUND PAD

7270-PRS Pack of 10 / Outer 40
7271-PRS Pack of 10 / Outer 40

PRODUCT DETAIL

Side wirebound, 500 micron hard glazed mottled pressboard covers. Assorted colours

COLOURS



PAGE DETAIL

120 Pages, 80 gsm faint ruled white paper Micro-perforated pages for easy removal



A4 TOPBOUND PAD

7269-PRS Pack of 10 / Outer 20

PRODUCT DETAIL

Top wirebound, 500 micron hard glazed mottled pressboard covers. Assorted colours

COLOURS



PAGE DETAIL

120 Pages, 80 gsm faint ruled white paper, micro-perforated pages for easy removal



TOPBOUND MAJOR PAD

7266-PRS Pack of 10 / Outer 20

PRODUCT DETAIL

Size 202 x 127mm, top wirebound, 500 micron hard glazed mottled pressboard covers, elasticated closure to keep notes safe. Assorted colours

PAGE DETAIL

300 Pages, 80 gsm feint ruled white paper

COLOURS



TOPBOUND MINOR PADS

7272-PRS Pack of 20 / Outer 60

7273-PRS Pack of 20 / Outer 60

PRODUCT DETAIL

Top wirebound, 500 micron pressboard covers, elasticated closure to keep notes safe. Assorted colours

PAGE DETAIL

120 Pages, 80 gsm feint ruled white paper, micro-perforated pages for easy removal

COLOURS



A6 SIDEBOUND PAD

7274-PRS Pack of 10 / Outer 80

PRODUCT DETAIL

Side wirebound, 500 micron mottled pressboard covers, assorted colours, contains two of each colours – purple, blue, green, yellow and red

PAGE DETAIL

120 Pages, 80 gsm feint ruled white paper, micro-perforated pages for easy removal

COLOURS



A4/A5 SIDEBOUND PAD

7277-PRS Pack of 10 / Outer 20 (A4)

7276-PRS Pack of 10 / Outer 20 (A5)

PRODUCT DETAIL

Side wirebound 500 micron mottled pressboard covers

PAGE DETAIL

120 Pages, 80 gsm feint ruled white paper, micro-perforated pages for easy removal

COLOURS



TOPBOUND MINOR PAD

7275-PRS Pack of 10 / Outer 80

PRODUCT DETAIL

127 x 76mm, top wirebound, 500 micron pressboard covers, elasticated closure to keep notes safe

PAGE DETAIL

120 Pages, 80 gsm feint ruled white paper, micro-perforated pages for easy removal

COLOURS



Unipad, a high quality 60 gsm product range, is a sub-brand of Pukka Pad. The range includes a selection of writing pads such as project books, refill pads, college and reporter pads. Products are packed into cardboard display units which are designed ready for display on retail shelves without the need for unpacking.



A4/A5 PROJECT BOOK

6200-UNI CDU12 (A4)
6201-UNI CDU12 (A5)

COLOURS

PRODUCT DETAIL
Wire-bound, clear polyprop covers, colour coded re-positionable dividers with storage pockets. Assorted coloured packs

PAGE DETAIL
200 Pages, 60 gsm, 8mm lines
Page perforation

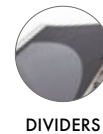

A4 SPIRAL NOTEPAD

USP80 CDU 15

PRODUCT DETAIL	PAGE DETAIL
Size A4	160 Pages
Spiral bound	60 gsm
Card covers.	Margin with 4 hole punched
Assorted Coloured Packs	Page Perforation

COLOURS





A4 REFILL PAD SIDE-BOUND

URP80SIDE CDU 15 (160 Pages)
URP200 CDU 9 (400 Pages)

PRODUCT DETAIL

Tape side-bound, card covers.
Assorted coloured packs

COLOURS



PAGE DETAIL

Available in
160 or 400
pages, 60 gsm,
margin,
4 hole punched



LINED



A4 REFILL PAD TOP-BOUND

URP80 CDU 15

PRODUCT DETAIL

Tape head-bound,
card covers. Assorted
coloured packs

COLOURS



PAGE DETAIL

160 Pages, 60 gsm with
margin and 4 hole punched,
8mm lines



LINED



SHORTHAND PAD

USH80 CDU 15

PRODUCT DETAIL

Size 128mm x 203mm,
Wire bound head-bound,
Card covers.
Assorted coloured packs

PAGE DETAIL

160 Lined pages
60 gsm
Page perforation

COLOURS



MEMO PAD FEINT/NARROW RULED

UMEM80(FR)B Pack of 10 / Outer 40 (Feint Ruled)
UMEM80(NR)B Pack of 10 / Outer 40 (Narrow Ruled)

PRODUCT DETAIL

Glued Pads

PAGE DETAIL

160 Pages, 60 gsm
Available in feint or
narrow ruling



NARROW
RULED

Keep track of your notes while studying, marking up documents, or re-reading your favourite novel. Stylish re-positionable self-adhesive products, easy to stick and remove without damaging surfaces. Pukka Notes range has a variety of sizes and colours to choose from.



Fun shape to add impact to your message



Easy to lift one flag at a time



Ideal to point out important information











A combination of paper notes and film indexes

CODE/REF	SIZE	PACK SIZE	COLOUR
1 6701-NTS	12 x 44	24	Green, yellow, orange, pink and purple
2 6704-NTS	12 x 44	24	Red, yellow, green, light blue
3 6707-NTS	12x45 / 38x51	24	Green, yellow, orange, pink and light blue
4 6714-NTS	69 x 65	24	Magenta, neon lime, pink, orange and lemon
5 6717-NTS	12x45 / 12x42	24	Assorted neon colours
6 6719-NTS	76 x 76	12	Magenta, neon lime, pink, orange and lemon
7 8622-NTS	76 x 127	12	Magenta, neon lime, pink, orange and lemon
8 8623-NTS	Varied Sizes	12	Pink, yellow and lime green
9 8625-NTS	20 x 50	24	Assorted Colours

Concord brand has an extensive range of files, folders and wallets to help make your office life better. Document wallets are ideal for storing loose A4 and foolscap papers.



IXL CURRICULUM RINGBINDERS A4

CODE/REF	DETAIL	PACK SIZE	COLOUR
86510	Design & Technology	10	Green 
86511	Modern Language	10	Lime 
86512	Mathematics	10	Navy 
86514	Science	10	Red 
86515	English	10	Yellow 
86516	Geography	10	Orange 
86518	Physical Education	10	Blue 
86519	Music	10	Pink 
86520	History	10	Purple 

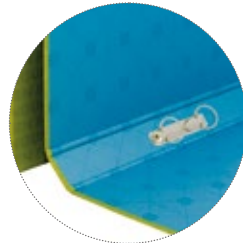

PRODUCT DETAIL

These curriculum ring-binders are perfect for filing your school or college work. They are ideal for keeping your coursework and assignments in one handy place with their bright design and wipe clean surface.

BRIGHTS HALF FLAP DOCUMENT WALLET FOOLSCAP



- 55091 - Bright Manilla Assorted Pack of 25 / Box of 4
- 55095 - Bright Manilla Pack of 5 (1 x 5 colours) / Box of 10



PRODUCT DETAIL

Smart, brightly coloured document wallets that are ideal for colour coding files and making finding document easy. Half flap helps keep papers protected and safe. 38mm capacity, 290gsm bright board.

Bright and fun in a candy colour scheme, our new range of Pukka files is stylish without sacrificing practicality. Ring binders, lever arches and box files are available in five complementary patterns, and come complete with dotted linings inside.

MATCHING PRODUCTS
PAGE 19
PAGE 49



A4 FASHION RING BINDER FILES

9461-FF(ASST)

- Box of 10 Assorted
- 2 x Hearts
- 2 x Geometric
- 2 x Feathers
- 2 x Stripes
- 2 x Colourwash

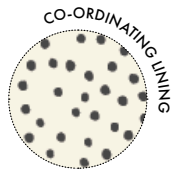

PRODUCT DETAIL

- Paperboard file
- Standard d-ring mechanism
- Co-ordinating linings inside

A4 FASHION LEVER ARCH FILES

9466-FF(ASST)

- Box of 10 Assorted
- 2 x Hearts
- 2 x Geometric
- 2 x Feathers
- 2 x Stripes
- 2 x Colourwash

PRODUCT DETAIL

- Paperboard file
- Standard lever arch mechanism
- Thumb hole for easy retrieval



FOOLSCAP FASHION BOX FILES

9471-FF(ASST)

- Box of 5 Assorted
- 1 x Hearts
- 1 x Geometric
- 1 x Feathers
- 1 x Stripes
- 1 x Colourwash

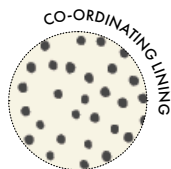

PRODUCT DETAIL

- Paperboard file
- Press button catch
- Interior paper lock mechanism
- Finger pull tab for easy retrieval

A4 FASHION CLIP BOARD PADFOLIOS

9476-FF - Hearts

Box of 6

9478-FF - Geometric

Box of 6

9479-FF - Feathers

Box of 6

PRODUCT DETAIL

- Clipboard front cover to fit A4 sheets, strong metal clip holds plenty of paper
- Refill pad inside with dotted lines and tear-off sheets, pocket inside for holding loose papers, pens and more



A4 BRIGHTS LEVER ARCH FILES

CODE/REF	DETAIL	PACK SIZE	COLOUR	SIZE	CODE/REF	DETAIL	PACK SIZE	COLOUR	SIZE
BR-7757	Laminated	10	Black	A4	BR-7764	Laminated	10	Pink	A4
BR-7758	Laminated	10	Red	A4	BR-7996	Laminated	10	Navy	A4
BR-7759	Laminated	10	Orange	A4	BR-9448	Laminated	10	Assorted	A4
BR-7760	Laminated	10	Green	A4				3 x Black	
BR-7761	Laminated	10	Blue	A4				2 x Blue	
BR-7762	Laminated	10	Purple	A4				2 x Pink	
BR-7763	Laminated	10	Yellow	A4				2 x Green	
								1 x Orange	

Featuring a secure
2 O-ring mechanism



A4 BRIGHTS RINGBINDER FILES

CODE/REF	DETAIL	PACK SIZE	COLOUR	SIZE	CODE/REF	DETAIL	PACK SIZE	COLOUR	SIZE
BR-7765	Laminated	10	Black	A4	BR-7997	Laminated	10	Navy	A4
BR-7766	Laminated	10	Red	A4	BR-9449	Laminated	10	Assorted	A4
BR-7767	Laminated	10	Orange	A4				3 x Black	
BR-7768	Laminated	10	Green	A4				2 x Blue	
BR-7769	Laminated	10	Blue	A4				2 x Pink	
BR-7770	Laminated	10	Purple	A4				2 x Green	
BR-7771	Laminated	10	Yellow	A4				1 x Orange	
BR-7772	Laminated	10	Pink	A4					

Featuring lid clip
& internal spring clip



FOOLSCAP BRIGHTS BOX FILES

CODE/REF	DETAIL	PACK SIZE	COLOUR	SIZE	CODE/REF	DETAIL	PACK SIZE	COLOUR	SIZE
BR-7773	Laminated	10	Black	Foolscap	BR-7998	Laminated	10	Navy	Foolscap
BR-7774	Laminated	10	Red	Foolscap	BR-9450	Laminated	10	Assorted	Foolscap
BR-7775	Laminated	10	Orange	Foolscap				3 x Black	
BR-7776	Laminated	10	Green	Foolscap				2 x Blue	
BR-7777	Laminated	10	Blue	Foolscap				2 x Pink	
BR-7778	Laminated	10	Purple	Foolscap				2 x Green	
BR-7779	Laminated	10	Yellow	Foolscap				1 x Orange	
BR-7780	Laminated	10	Pink	Foolscap					

ROTATING METAL DISPLAY STAND

Screw together and stack... It's simple!
This excellent quality metal floor stand offers the perfect display solution, organising your files for maximum impact.

Please contact us for type offer.

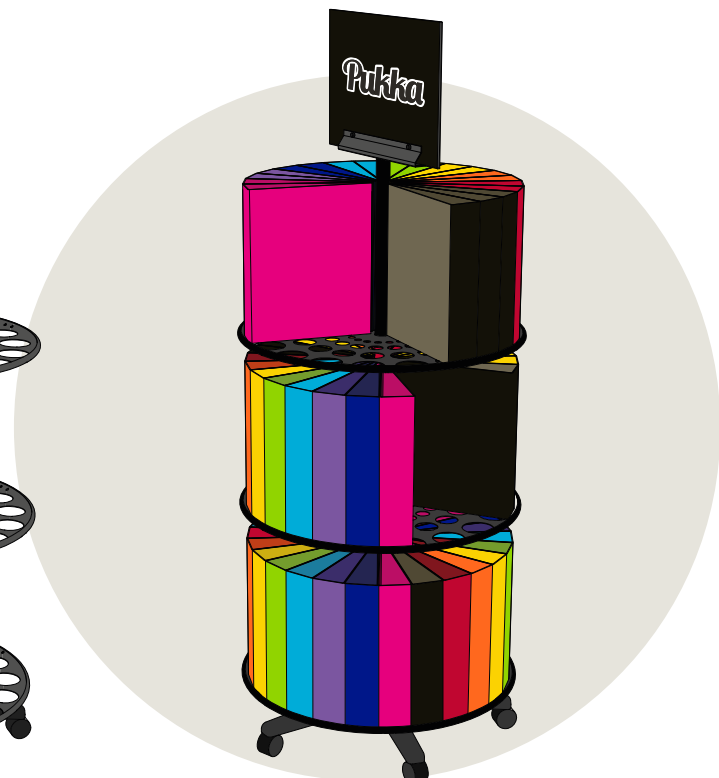
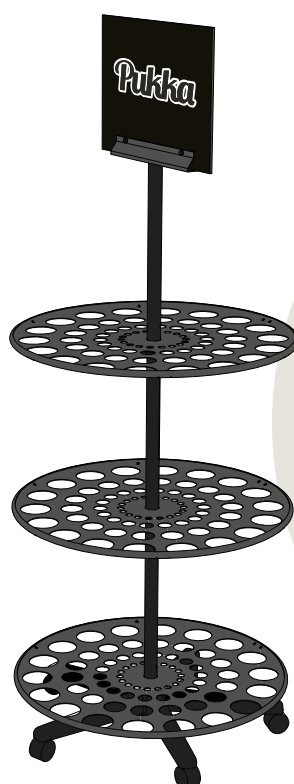

Made from hard wearing, strong cardboard, these files are durable and ideal for storing multiple A4-sized paper documents that have been two-hole punched.



Featuring a secure 2 O-ring mechanism



A4 CLOUD RINGBINDER FILE

C81101 Outer 10

PRODUCT DETAIL

Paper over board ring binders from Concord. Two O-ring binding mechanism. Spine label for easy identification. Hard wearing cover.

DETAIL

Capacity: 25mm.
Size: A4. Cloud
Packed 10



Featuring a secure Lever Arch mechanism

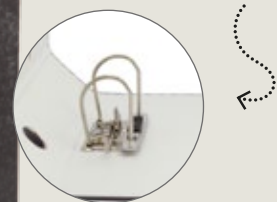

A4 CLOUD LEVER ARCH FILE

C214047 Outer 10

PRODUCT DETAIL

A4 70mm Spine Lever Arch File. Ideal for storing larger amounts of paper than its ring binder cousin. Hard wearing cover with protective metal edge

DETAIL

File Colour: Cloud Grey
Size: A4
Spine Width: 70mm Spine



Hard wearing cover with protective metal edge

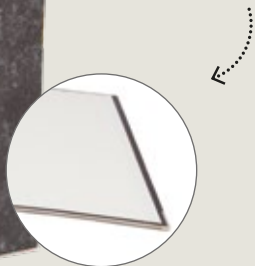

FOOLSCAP CLOUD LEVER ARCH

C216057 Outer 10

PRODUCT DETAIL

Foolscap files take A4 paper however are slightly taller than the A4 folders which gives added space to avoid the papers from being damaged. Manufactured with durable materials and superior mechanism ensuring excellent performance and efficiency.

DETAIL

File Colour: Cloud Grey
Size: Foolscap
Spine Width: 70mm Spine



Featuring lid clip & internal spring clip



FOOLSCAP CLOUD BOX FILE

1274 Outer 10

PRODUCT DETAIL

A4 70mm spine lever arch file. Ideal for storing larger amounts of paper than its ring binder cousin.

DETAIL

File Colour: Cloud Grey
Size: Foolscap
Spine Width: 70mm Spine

The Pukka Pads premium filing range is here for all your home and office needs, keep your important documents secure and safe with our filing range. Our premium lever arch files allow you to be stylish without having to sacrifice practicality.

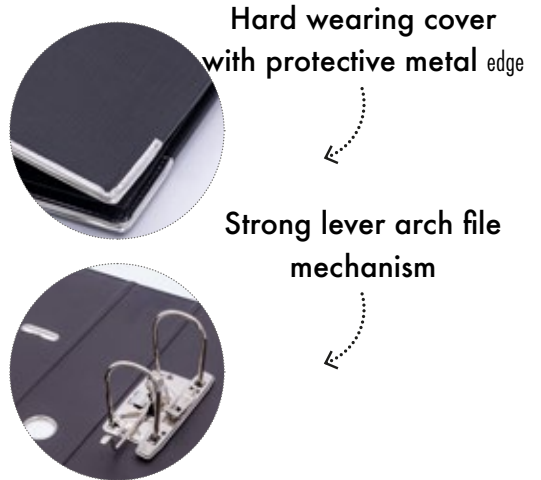

A4 PREMIUM LEVER ARCH FILES

- 9712-PPF Box of 10 (Black)
- 9713-PPF Box of 10 (Red)
- 9714-PPF Box of 10 (Blue)

PRODUCT DETAIL

These Pukka Premium lever arch files are ideal for use in home offices, small businesses and with students. They are crafted from quality materials to offer a durable design to keep your documents safe and secure. For added convenience, these files feature a spine label for easy identification, as well as a thumb hole to easily remove it from the shelf.

SPECS

- Suitable for A4 documents
- Thumb hole for easy retrieval
- Reversible spine label
- Approximate dimensions (mm): H 320 W 280 D 75
- Strong lever mechanism



A4 PREMIUM LEVER ARCH FILE

- 9715-PPF Box of 10 Olive
- 9716-PPF Box of 10 Orchid

PRODUCT DETAIL

Suitable for A4 documents, thumb hole for easy retrieval
 Reversible label spine, approximate dimensions (mm): H 320 W 280 D 75
 Strong lever mechanism



A4 PREMIUM BOX FILE

- 9778-PPF- Black/
- 9779-PPF- Red/
- 9780-PPF- Blue

Box of 10

PRODUCT DETAIL

Our Premium box files are ideal for creating an organised home or workspace. The box files feature a handy securing arm inside to keep your documents and other items in place, with enough room for over 500 sheets of paper.

WALL PLANNERS

Our Pukka Planners range is cute, simple, and chic. Designed to inspire you to live the most organised, creative and beautiful life possible.



BLACK & GOLD 2023 WALL PLANNER

9736-WP Outer 16

PRODUCT DETAIL

Our Pukka Pads black & gold 2023 wall planner is the perfect companion for your home, workplace, or WFH set-up! The 2023 dated year planner is ideal for putting on your wall to keep track of important dates, deadlines, holidays & work meetings. Its simple to use design enables you to track your days, weeks, months, and years easily.

PAGE DETAIL

Size: A1+ (910mm x 610mm)
250 GSM laminated paper
Includes 9 sheets of removable stickers in an assorted range of colours
13 months runs from Jan 2023 to Jan 2024
Public holidays included

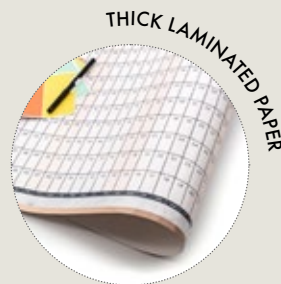

MARBLE & ROSE GOLD 2023 WALL PLANNER

9737-WP Outer 16

PRODUCT DETAIL

Our Pukka Pads marble & rose gold 2023 wall planner is the perfect companion for your home, workplace, or WFH set-up! The 2023 dated year planner is ideal for putting on your wall to keep track of important dates, deadlines, holidays & work meetings. Its simple to use design enables you to track your days, weeks, months, and years easily. The thick paper of this 2023 wall planner is used to protect the calendar from ink leakage.

PAGE DETAIL

Size: A1+ (910mm x 610mm)
250 GSM laminated paper
Includes 9 sheets of removable stickers in an assorted range of colours
13 months runs from Jan 2023 to Jan 2024
Public holidays included

High quality filing products designed to help you to manage and easily organise your everyday paperwork, ideal for all office, home, or school users. All products feature eye-catching on-pack communication, highlighting their features & benefits. Products are available in a variety of pack sizes and formats.



A4 RINGBINDER FILE 2 RING

- 6061-PFL (CLR) Pack of 5 / Outer 30
- 6062-PFL (BLK) Pack of 5 / Outer 30
- 6064-PFL (BLU) Pack of 5 / Outer 30
- 6065-PFL (PUR) Pack of 5 / Outer 30



A4 RINGBINDER 4 RING

- 6066-PFL (CLR) Pack of 5 / Outer 30
- 6080-PFL (PNK) Pack of 5 / Outer 30
- 6082-PFL (PUR) Pack of 5 / Outer 30



A4 LEVER ARCH FILE

- 6110-PFL (CLR) Pack of 5 / Outer 20
- 6121-PFL (BLK) Pack of 5 / Outer 20
- 6122-PFL (PNK) Pack of 5 / Outer 20
- 6123-PFL (BLU) Pack of 5 / Outer 20
- 6124-PFL (PUR) Pack of 5 / Outer 20



A4 RINGBINDER 25MM RING

- 7114-PFL (RED) Pack of 5 / Outer 30
- 7115-PFL (ASSRT) Pack of 10 / Outer 30
- 7119-PFL (BLU) Pack of 10 / Outer 60
- 7124-PFL (BLU) Pack of 10 / Outer 40



A4/A5 RINGBINDER 15MM RING

- 7116-PFL (A5) (CLR) Pack of 10 / Outer 60
- 7117-PFL (A4) (CLR) Pack of 10 / Outer 60
- 7121-PFL (A5) (BLU) Pack of 10 / Outer 60
- 7122-PFL (A4) (ASSRT BRITE) Pack of 10 / Outer 60
- 7123-PFL (A4) (BLU) Pack of 10 / Outer 60



A4 EXECUTIVE RINGBINDER

- 7125-PFL (ASSRT BRITE) Pack of 10 / Outer 40



A4 PP EXECUTIVE PRESENTATION RINGBINDER

- 7127-PFL (BLU) Pack of 10 / Outer 40



A4 PP EXECUTIVE PRESENTATION RINGBINDER WITH INDEX

- 7128-PFL (BLU) Pack of 10 / Outer 60



A4 PP SWING CLIP FILE

- 6184-PFL (PNK) Pack of 5 / Outer 100
- 6185-PFL (BLU) Pack of 5 / Outer 100
- 6186-PFL (PUR) Pack of 5 / Outer 100



A4 PRESENTATION RINGBINDER 4D RING

- 8813-DIS - (16mm) Outer 10
- 8814-DIS - (25mm) Outer 10
- 8815-DIS - (40mm) Outer 10
- 8816-DIS - (50mm) Outer 10

PRODUCT DETAIL

Personalise your projects and reports with these stylish presentation display binders, full front and spine pockets for bespoke cover sheets, strong 4 D-ring mechanism for easy addition and removal of documents, hold up to 400 sheets, constructed from strong durable materials with white waterproof / wipe clean outer.



A4 6-PART EXPANDING BOX FILE

- 6192-PFL (CLR) Pack of 5 / Outer 30
- 6193-PFL (BLK) Pack of 5 / Outer 30
- 6194-PFL (PNK) Pack of 5 / Outer 30
- 6195-PFL (BLU) Pack of 5 / Outer 30
- 6196-PFL (PUR) Pack of 5 / Outer 30



A4 PP 3 FLAP FOLIO FILE

- 6189-PFL (PNK) Pack of 5 / Outer 100
- 6191-PFL (PUR) Pack of 5 / Outer 100



A4 RINGBINDER TAB WALLET

- 6125-PFL Pack of 5 / Outer 240



A4 RINGBINDER STUD WALLET

- 6126-PFL Pack of 5 / Outer 120



A4 RINGBINDER DISPLAY BOOK

- 6127-PFL Pack of 5 / Outer 100



A4 CLEAR PUNCHED POCKETS

- POCA425 Pack of 25 / Outer 2000
- POCA450 Pack of 50 / Outer 2000



A4 PP STUD WALLET

7092-PFL Pack of 5 / Outer 200



A3 PP STUD WALLET

7094-PFL Pack of 5 / Outer 100



FOOLSCAP PP STUD TRIO WALLET

7093-PFL Pack of 5 / Outer 100



A4 PP TWIN FILE

7083-PFL (BLU) Pack of 5 / Outer 200



A4 PP PORTRAIT STUD WALLET

7098-PFL (A4) Pack of 5 / Outer 200



PP 2 CD WALLETS

7135-PFL (CLR) Pack of 5 / Outer 40



FOOLSCAP PP STUD WALLET

6128-PFL (CLR) Pack of 5 / Outer 120
 6129-PFL (PNK) Pack of 5 / Outer 120
 6130-PFL (BLU) Pack of 5 / Outer 120
 6131-PFL (PUR) Pack of 5 / Outer 120



A4 PP STUD WALLET

6132-PFL (CLR) Pack of 5 / Outer 120
 6133-PFL (PNK) Pack of 5 / Outer 120
 6134-PFL (BLU) Pack of 5 / Outer 120
 6135-PFL (PUR) Pack of 5 / Outer 120



A5 PP STUD WALLET TWIN PACK

6136-PFL (CLR) Pack of 5 / Outer 40
 6137-PFL (PNK) Pack of 5 / Outer 40
 6138-PFL (BLU) Pack of 5 / Outer 40
 6139-PFL (PUR) Pack of 5 / Outer 40





DL PP STUD WALLET TWIN PACK

6143-PFL (PNK) Pack of 5 / Outer 80 ●

FOOLSCAP PP STUD WALLET

7095-PFL Pack of 5 / Outer 200 ○
●
●
●
●

A4 STUD WALLET LITE

7100-PFL Pack of 5 / Outer 200 ○
●
●
●
●



FOOLSCAP PP STUD WALLET

7085-PFL (RED) Pack of 5 / Outer 120 ●
 7086-PFL (YEL) Pack of 5 / Outer 120 ●
 7087-PFL (BLU) Pack of 5 / Outer 120 ●
 7088-PFL (GREEN) Pack of 5 / Outer 120 ●
 7089-PFL (ASSRT BRITE) Pack of 5 / Outer 120 ●

A4 PP STUD WALLET

7096-PFL (ASSRT BRITE) Pack of 5 / Outer 200 ●
●
●
●



A5 PP STUD WALLET

7090-PFL (ASSRT BRITE) Pack of 5 / Outer 200 ● ● ● ● ●

A4 / A5 PP ZIP WALLETS

7101-PFL (A5, ASSRT BRITE) Pack of 25 / Outer 800 ● ● ● ●
 7102-PFL (A4, ASSRT BRITE) Pack of 25 / Outer 600 ● ● ● ●

Store all your important documents in the Concord Display Books. These Display Books are perfect for important business presentations or to showcase your achievements.



A4 PP PRESENTATION DISPLAY BOOK 40 POCKETS

6177-PFL (CLR)	Pack of 5 / Outer 30	<input type="checkbox"/>
6178-PFL (BLK)	Pack of 5 / Outer 30	<input checked="" type="checkbox"/>
6179-PFL (PNK)	Pack of 5 / Outer 30	<input checked="" type="checkbox"/>
6180-PFL (BLU)	Pack of 5 / Outer 30	<input checked="" type="checkbox"/>
6181-PFL (PUR)	Pack of 5 / Outer 30	<input checked="" type="checkbox"/>

PRODUCT DETAIL

Front cover pocket for personalisation, 40 pockets (80 pages to view), crystal clear copy-safe, file storage display



A4 PRESENTATION DISPLAY BOOK 20 POCKET

6172-PFL (CLR)	Pack of 5 / Outer 30	<input type="checkbox"/>
6173-PFL (BLK)	Pack of 5 / Outer 30	<input checked="" type="checkbox"/>
6175-PFL (BLU)	Pack of 5 / Outer 30	<input checked="" type="checkbox"/>

PRODUCT DETAIL

Front cover pocket for personalisation, 20 pockets (40 pages to view), crystal clear copy-safe, file storage display



A4 PP PRESENTATION DISPLAY BOOK 20 POCKETS

6146-PFL (CLR)	Pack of 5 / Outer 30	<input type="checkbox"/>
6147-PFL (BLK)	Pack of 5 / Outer 30	<input checked="" type="checkbox"/>
6161-PFL (PNK)	Pack of 5 / Outer 30	<input checked="" type="checkbox"/>
6162-PFL (BLU)	Pack of 5 / Outer 30	<input checked="" type="checkbox"/>

PRODUCT DETAIL

20 Pockets (40 pages to view), crystal clear copy-safe, file storage display, card pocket for personalisation



A4 PRESENTATION DISPLAY BOOK 40 POCKET

6164-PFL (CLR)	Pack of 5 / Outer 30	<input type="checkbox"/>
6165-PFL (BLK)	Pack of 5 / Outer 30	<input checked="" type="checkbox"/>
6166-PFL (PNK)	Pack of 5 / Outer 30	<input checked="" type="checkbox"/>
6167-PFL (BLU)	Pack of 5 / Outer 30	<input checked="" type="checkbox"/>
6168-PFL (PUR)	Pack of 5 / Outer 30	<input checked="" type="checkbox"/>

PRODUCT DETAIL

40 Pockets (80 pages to view), crystal clear copy-safe, file storage display, card pocket for personalisation



A4 DISPLAY BOOK LITE 20 POCKET

7136-PFL (ASSRT) Pack of 12 / Outer 96
7137-PFL (CLR) Pack of 12 / Outer 96

PRODUCT DETAIL

20 Pockets with frost covers, durable polypropylene covers, pack of 12, assorted colours blue, light blue, purple, yellow, pink & clear



A4 DISPLAY BOOK LITE 40 POCKET

7138-PFL (ASSRT) Pack of 12 / Outer 96

PRODUCT DETAIL

40 Pockets with frost covers, durable polypropylene covers, pack of 12, assorted colours blue, light blue, purple, pink, yellow & clear



A4 EXECUTIVE DISPLAY BOOK 20 POCKET A4

7139-PFL (BLK) Outer 30 Singles

PRODUCT DETAIL

Polypropylene professional presentation display book, 20 pockets, 1800 micron thick cover for strength and durability, front cover pocket to hold customised presentation sheet



A4 DISPLAY BOOK 10/16/24 POCKET

7140-PFL (10 Pocket, ASSRT BRITE) Pack of 10 / Outer 60
7141-PFL (16 Pocket, ASSRT BRITE) Pack of 10 / Outer 60
7142-PFL (24 Pocket, ASSRT BRITE) Pack of 10 / Outer 60

PRODUCT DETAIL

10/16/24 Pocket display books, full length wrap around spine label insert for easy identification, made from semi-rigid, wipe clean polypropylene, clear copy-safe pockets, assorted packs contain 3x blue and purple, 2x turquoise and 1x green and pink



A4 CLAMP FILE

7103-PFL (CLR) Pack of 10 / Outer 60
7104-PFL (ASSRT BRITE) Pack of 10 / Outer 60
7105-PFL (BLU) Pack of 10 / Outer 60

PRODUCT DETAIL

Pack of 10 clamp binders, 100 sheet capacity, made from long-lasting polypropylene, simple clamp binding mechanism, reusable spine label insert, business card holder for personalisation



Stylish and portable, these organisational files will help to prevent your important documents going astray. Label pockets allow for personalisation, making it easy to create comprehensive storage solutions.



A4 PP DOCUMENT STORAGE BOX

6197-PFL (CLR)	Pack of 5 / Outer 30	<input type="checkbox"/>
6198-PFL (BLK)	Pack of 5 / Outer 30	<input checked="" type="checkbox"/>
6199-PFL (PNK)	Pack of 5 / Outer 30	<input checked="" type="checkbox"/>
6216-PFL (BLU)	Pack of 5 / Outer 30	<input checked="" type="checkbox"/>

PRODUCT DETAIL

Rigid & robust, 30mm capacity, for documents, catalogues or magazines, internal pocket for smaller cards, receipts or tickets, press-stud closure, card pocket for personalisation



A4 DOCUMENT STORAGE BOX

7131-PFL (CLR, 35mm Spine)	Outer 40 Singles	<input type="checkbox"/>
7132-PFL (CLR, 25mm Spine)	Outer 40 Singles	<input type="checkbox"/>

PRODUCT DETAIL

Polypropylene box file, push lock, 25mm or 35mm spine, fully welded rigid construction for strength, secure plastic push-lock protects contents, business card holder and index strip, cutaway front for easy access



A4 DOCUMENT STORAGE BOX

7133-PFL (BLU)	Outer 20 Singles	<input checked="" type="checkbox"/>
7134-PFL (CLR)	Outer 20 Singles	<input type="checkbox"/>

PRODUCT DETAIL

Polypropylene box file, push lock, 60mm spine, fully welded rigid construction for strength, secure elastic push-lock protects contents, business card holder and index strip, cutaway front for easy access



A4 EXECUTIVE ORGANISER FILE

7106-PFL Outer 12 Singles

PRODUCT DETAIL

Multi-use expanding 6 part, 4mm x 25mm rings, index tabs for filing, supplied with 40-page, 80gsm punched refill pad, business card holder and pen loop, inner zipped pockets, secure colour-coded closure lock, capacity 200 pages



A4 EXECUTIVE FILE

7107-PFL (BLU) Outer 5 Singles

PRODUCT DETAIL

Robust polypropylene document file case, 3 ply construction made from recycled polypropylene, index tabs, 26 expanding sections for documents, thumb cut pockets, pull-up handle, twin closure locks, will lie completely flat on desk, smart black interior contrasting with coloured cover



A4 EXECUTIVE ORGANISER WITH DIVIDERS

7108-PFL (6 Part) Outer 30 Singles
 7109-PFL (13 Part) Outer 30 Singles

PRODUCT DETAIL

Expanding organiser file, multicoloured dividers, 6 or 13 part, index tabs for personalisation, business card pocket on inside cover flap, snap shut button closure, keeps contents safe and secure



FOOLSCAP EXECUTIVE ORGANISER WITH DIVIDERS

7110-PFL (13 Part) Outer 15 Singles
 7111-PFL (24 Part) Outer 10 Singles

PRODUCT DETAIL

Expanding organiser file, 13 or 24 part, welded, pre-printed tab inserts, soft touch handles, unobtrusive closures, keeps contents safe and secure



EXECUTIVE DESK EXPANDER

7112-PFL (Portrait) Outer 40 Singles
 7113-PFL (Landscape) Outer 40 Singles

PRODUCT DETAIL

13 Part expanding desk organiser, made from strong wipe-clean polypropylene, colour coordinated plastic, carry handles, colour coded insert tabs

Concord offers a wide range of Indexes and Dividers to make your office life easier, helping you to fly through paperwork and get back to business.



A4 CLASSIC CLEAR FILM REINFORCED INDEXES

Our premium range of clear reinforced indexes. Printed both sides with reinforced tabs and holes. Complete with printed contents page which enables easy referencing. Bright white board.

CODE/REF	DETAIL	PACK SIZE	COLOUR	SIZE
00501/CS5	1-5	20	Clear	A4
00901/CS9	1-10	20	Clear	A4
01201/CS12	1-12	20	Clear	A4
01401/CS14	1-15	10	Clear	A4
00701/CS7	1-20	10	Clear	A4
02501/CS25	1-25	5	Clear	A4
03101/CS31	1-31	5	Clear	A4
05501/CS55	1-50	2	Clear	A4
05401/CS54	1-54	2	Clear	A4
05601/CS56	1-75	2	Clear	A4
05701/CS57	1-100	2	Clear	A4
05801/CS58	1-200	1	Clear	A4
04001/CS40	A-Z (20pt)	10	Clear	A4
04501/CS45	A-Z (26pt)	10	Clear	A4
02201/CS22	Jan-Dec	10	Clear	A4

A5 CLASSIC CLEAR FILM REINFORCED INDEXES

07001/CS70	1-5	20	Clear	A5
07101/CS71	1-10	10	Clear	A5
07201/CS72	1-20	5	Clear	A5
01002	1-31	4	Clear	A5
07301/CS73	A-Z	5	Clear	A5

A3 CLASSIC CLEAR FILM REINFORCED INDEXES

04601/CS46	1-10	10	Clear	A3
04801/CS48	1-20	5	Clear	A3

MULTICOLOUR FILM REINFORCED DIVIDERS

Our premium range of clear reinforced indexes to add a touch of class to your projects, reports and presentations.

CODE/REF	DETAIL	PACK SIZE	COLOUR	SIZE
00601/CS6	5 Part	20	Multi-Colour	A4
00801/CS8	10 Part	20	Multi-Colour	A4

INDEXES & DIVIDERS

CLASSIC MULTICOLOUR FILM REINFORCED INDEXES

Our premium range of clear reinforced indexes to add a touch of class to your projects, reports and presentations. Reinforced holes with matching contents page and assorted coloured tabs.

CODE/REF	DETAIL	PACK SIZE	COLOUR	SIZE
00201/CS2	1-5	20	Multi-Colour	A4
00401/CS4	1-10	20	Multi-Colour	A4
01301/CS13	1-12	20	Multi-Colour	A4
01601/CS16	1-15	10	Multi-Colour	A4
01901/CS19	1-20	10	Multi-Colour	A4
03201/CS32	1-31	5	Multi-Colour	A4
05001/CS50	1-50	2	Multi-Colour	A4
02101/CS21	A-Z	10	Multi-Colour	A4
02401/CS24	Jan-Dec	10	Multi-Colour	A4

MULTICOLOUR EXTRA WIDE FILM REINFORCED INDEXES

09601/CS96	1-5	20	Multi-Colour	E/W
09701/CS97	1-10	10	Multi-Colour	E/W
09801/CS98	1-12	10	Multi-Colour	E/W
09901/CS99	1-20	5	Multi-Colour	E/W
10001/CS100	1-31	4	Multi-Colour	E/W
07801/CS78	A-Z	5	Multi-Colour	E/W
07901/CS79	Jan-Dec	10	Multi-Colour	E/W

ACADEMIC INDEXES MULTICOLOUR FILM REINFORCED

Premium indexes that help you organise your weekly or monthly tasks, or to organise your projects by academic year, ideal for use at home, office or school. Reinforced multicoloured tabs and comes with matching colour co-ordinated contents page.

CODE/REF	DETAIL	PACK SIZE	COLOUR	SIZE
02701/CS27	Term Time	20	Multi-Colour	A4
02801/CS28	Apr-Mar	20	Multi-Colour	A4
02901/CS29	Aug-Jul	10	Multi-Colour	A4

UNPUNCHED INDEXES & DIVIDERS

A selection of indexes for non-standard filing options. Can be punched to suit your individual needs. Ideal for use with slide, wire and comb binders.

CODE/REF	DETAIL	PACK SIZE	COLOUR	SIZE
75101	1-5	4 Pack of 20	White	A4
75201	1-10	4 Pack of 10	White	A4
75301	1-12	4 Pack of 10	White	A4
76101	1-15	4 Pack of 5	White	A4
75401	1-20	4 Pack of 5	White	A4
75501	1-31	3 Pack of 5	White	A4
75601	A-Z (26 Part)	3 Pack of 5	White	A4

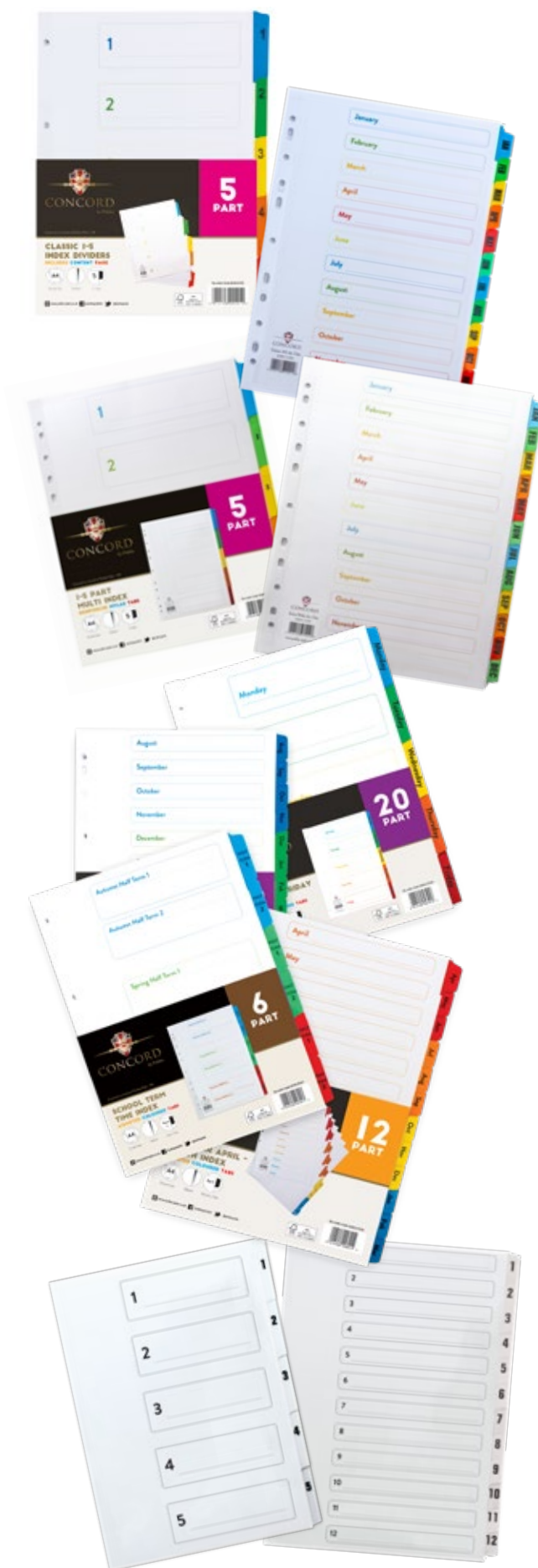

WHITE POLYPROPYLENE INDEXES

Practical hard wearing tear resistant indexes which can be wiped clean. With reinforced matching contents page. Euro-punched 11 holes. 120 micron plastic.

CODE/REF	DETAIL	PACK SIZE	COLOUR	SIZE
64001	1-5	25	White	A4
64101	1-10	25	White	A4
64201	1-12	20	White	A4
64301	1-15	20	White	A4
64401	1-20	10	White	A4
64501	1-31	10	White	A4
64601	A-Z	10	White	A4
64701	Jan-Dec	20	White	A4

GREY COMMERCIAL POLYPROPYLENE INDEXES

Practical hard wearing tear resistant indexes which can be wiped clean. With reinforced matching contents page. Euro-punched 11 holes. 120 micron plastic.

62305	1-5	25	Grey	A4
62405	1-10	25	Grey	A4
62505	1-12	20	Grey	A4
62605	1-15	20	Grey	A4
62705	1-20	10	Grey	A4
62805	1-31	10	Grey	A4
62905	A-Z	10	Grey	A4
63005	Jan-Dec	20	Grey	A4

POLYPROPYLENE MULTICOLOUR DIVIDERS

Colourful, practical and hard wearing indexes with printed and plain tabs. Complete with contents page in matching colours with reinforced spine. 120 micron plastic.

A4 ASSORTED PUNCHED 11 HOLES

66299	1-5	25	Multi-Colour	A4
66399	1-10	25	Multi-Colour	A4
66499	1-12	20	Multi-Colour	A4
66599	1-20	10	Multi-Colour	A4
66699	1-31	10	Multi-Colour	A4
65799	A-Z	10	Multi-Colour	A4

A4 ASSORTED PLAIN SUBJECT PUNCHED 11 HOLES

06801	5 Part	25	Multi-Colour	A4
65899	6 Part	25	Multi-Colour	A4
06901	10 Part	25	Multi-Colour	A4
65999	12 Part	25	Multi-Colour	A4

EXTRA WIDE FOR USE WITH PUNCHED POCKETS

67199	1-10	20	Multi-Colour	E/W
67099	A-Z	10	Multi-Colour	E/W
66099	5 Part	25	Multi-Colour	E/W
66199	10 Part	20	Multi-Colour	E/W

INDEXES & DIVIDERS

SUBJECT DIVIDERS BOARDS

Wide range of traditional subject dividers with plain tabs which can be written or typed onto. Euro-punched 11 holes, assorted colour tabs.

A4 ASSORTED COLOURS PUNCHED 11 HOLES

CODE/REF	DETAIL	PACK SIZE	COLOUR	SIZE
71199/J11	5 Part	50	Pastel	A4
70699/J16	6 Part	40	Pastel	A4
72299/J22	10 Part	25	Pastel	A4
71499/J14	12 Part	20	Pastel	A4
71599/J15	15 Part	10	Pastel	A4
74499/J44	20 Part	10	Pastel	A4
72099/J20	10 Part	25	Pastel	A4
74099/J40	20 Part	20	Pastel	A4

A5 ASSORTED COLOURS PUNCHED 2 HOLES

70599/J5	5 Part	20	Pastel	A5
72199/J21	10 Part	10	Pastel	A5

A3 ASSORTED COLOURS PUNCHED 4 HOLES

70299/J2	10 Part Upright	10	Pastel	A3
70399/J3	5 Part Oblong	20	Pastel	A3
70499/J4	10 Part Oblong	10	Pastel	A3

A4 ASSORTED COLOURS (PACK OF 5) PUNCHED 4 HOLES

71190	5 Part	50	Pastel	A4
72090	10 Part	25	Pastel	A4

COMMERCIAL SUBJECT DIVIDERS BOARDS

Great value for money dividers suitable for everyday use. Euro-punched 11 holes. 150gsm coloured board.

A4 ASSORTED COLOURS PUNCHED 11 HOLES

CODE/REF	DETAIL	PACK SIZE	COLOUR	SIZE
51099	5 Part	100	Pastel	A4
51199	10 Part	50	Pastel	A4

EXTRA WIDE FOR USE WITH PUNCHED POCKETS 11 HOLES

51399	5 Part	50	Pastel	E/W
51599	10 Part	25	Pastel	E/W

REINFORCED SUBJECT DIVIDERS & INDEXES

Reinforced holes to add extra strength and durability. Euro-punched 11 holes. 160 gsm.

A4 ASSORTED PUNCHED 11 HOLES

CODE/REF	DETAIL	PACK SIZE	COLOUR	SIZE
77099	5 Part	50	Pastel	A4
77199	10 Part	25	Pastel	A4
77299	A-Z (20pt)	10	Pastel	A4



WHITE SUBJECT DIVIDERS BOARDS

Wide range of traditional white subject dividers with plain tabs which can be written or typed onto. Euro-punched 11 holes.

CODE/REF	DETAIL	PACK SIZE	COLOUR	SIZE
----------	--------	-----------	--------	------

A4 WHITE PUNCHED 11 HOLES

79901	5 Part	50	White	A4
79701	10 Part	25	White	A4
79501	12 Part	20	White	A4
79601	20 Part	10	White	A4

EXTRA WIDE WHITE FOR PUNCHED POCKET PUNCHED 11 HOLES

77701	5 Part	50	White	E/W
77801	10 Part	25	White	E/W

A3 WHITE PUNCHED 4 HOLES

79801	5 Part	20	White	A3
-------	--------	----	-------	----

PASTEL INDEXES

Economical and hard wearing manilla indexes perfect for everyday general use. Euro-punched 11 holes. 180 gsm board.

CODE/REF	DETAIL	PACK SIZE	COLOUR	SIZE
----------	--------	-----------	--------	------

78602/AZ6	A-Z (20pt)	10	Pastel	A4
71999/J19	Jan – Dec	10	Pastel	A4
71899/J18	A-Z	15	Pastel	E/W
77901	A-Z	15	White	E/W

KRAFT MANILLA INDEXES

79102/AZ9	1-10	25	Kraft	A4
78202/AZ2	A-Z	20	Kraft	A4
79202/AZ13	1-31	10	Kraft	A4
79302/AZ12	Jan-Dec	20	Kraft	A4
73102	16 Part A-Z	10	Kraft	A4

RECYCLED INDEXES & DIVIDERS

100% quality recycled dividers and indexes making them an excellent choice for environmentally friendly users. With matching contents pages. 160gsm board.

A4 ASSORTED COLOURS PUNCHED 11 HOLES

48301	1-10	20	White	A4
47601	1-20	10	White	A4
47701	1-31	10	White	A4
48201	A-Z	10	White	A4
47801	Jan-Dec	20	White	A4

A4 WHITE PRINTED PUNCHED 11 HOLES

48099	5 Part	20	Pastel	A4
48199	10 Part	10	Pastel	A4
48699	20 Part	10	Pastel	A4

INDEXES & DIVIDERS

BRIGHT SUBJECT DIVIDERS & INDEXES

Bright, eye-catching dividers and indexes for those who want their filing to stand out. Assorted colour tabs. Euro-punched 11 holes. 160gsm coloured board.

CODE/REF	DETAIL	PACK SIZE	COLOUR	SIZE
A4 DIVIDERS PUNCHED 11 HOLES				
50699	5 Part	20	Bright	A4
50799	6 Part	20	Bright	A4
50899	10 Part	10	Bright	A4
50999	12 Part	10	Bright	A4
52499	A-Z	10	Bright	A4
EXTRA WIDE FOR USE WITH PUNCHED POCKETS 11 HOLES				
52199	5 Part	20	Bright	E/W
52299	10 Part	20	Bright	E/W
52399	20 Part	10	Bright	E/W

BRIGHT HEAVY BOARD DIVIDERS

Super thick board divider for extra durability. Attractive bright colour board with stunning colour tabs ideal for longer, ongoing projects. 290gsm coloured board.

CODE/REF	DETAIL	PACK SIZE	COLOUR	SIZE
A4 DIVIDERS PUNCHED 11 HOLES				
52599	5 Part	20	Bright	A4
52699	10 Part	10	Bright	A4

NEON FLUORESCENT SUBJECT DIVIDERS

5 vivid, fluorescent tabs to organise contents by subject. Double sided, coloured board with vibrant tabs: pink, orange, red and yellow. 11 hole punched.

CODE/REF	DETAIL	PACK SIZE	COLOUR	SIZE
89099	5 Part	20	Neon	A4
89199	10 Part	10	Neon	A4

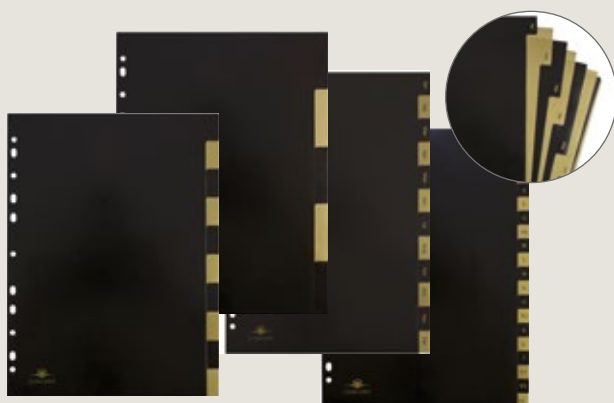

A4 BLACK & GOLD PP DIVIDERS

7737-NOI	25 Sets (5 Part)		
7738-NOI	25 Sets (10 Part)		
7740-NOI	20 Sets (Jan-Dec)		
7739-NOI	10 Sets (A-Z)		

PRODUCT DETAIL

Hard wearing A4 PP sheet dividers, extra width for easy viewing when used with punched pockets, tabbed, two colour dividers made of long lasting PP.



A4 REVERSIBLE FASHION DIVIDERS

9481-FF	20 Sets / Outer 100
---------	---------------------

PRODUCT DETAIL

Reversible dividers let you choose from stylish designs or flip over for bright bold colours. The dividers are 4-hole punched with reinforced holes for extra durability, features five stylish colours and fashion designs. Flip catalogue for matching products.

MATCHING PRODUCTS
PAGE 19
PAGE 32

Pukka offers an assortment of different record books to help your business run smoothly. They are perfect for any business that operates a phone network or communicates with their customers and clients via telephone.



TELEPHONE MESSAGE PAD

MES11/2/200 Pack of 5 / Outer 30
 MES11/2/400 Pack of 3 / Outer 18

PRODUCT DETAIL

Size 152mm x 280mm, wirebound, no carbon required (NCR)

PAGE DETAIL

200 Or 400 duplicate messages, 4 messages per page, message perforation



PETTY CASH

PET11/2/200 Pack of 5 / Outer 30

PRODUCT DETAIL

Size 152mm x 280mm, wirebound, no carbon required (NCR)

PAGE DETAIL

120 Pages, 80 gsm feint ruled white paper, micro-perforated pages for easy removal



RECEIPT BOOK

REC11/2/200 Pack of 5 / Outer 30

PRODUCT DETAIL

200 Duplicate receipts, 4 receipts per page, receipt perforated for easy removal

PAGE DETAIL

200 Duplicate receipts, no carbon required (NCR), 4 receipts per page, 153x280mm wirebound with card covers.



THINGS TO DO TODAY PAD

THI11/1/115 Pack of 5 / Outer 15

PRODUCT DETAIL

Size 152mm x 280mm, wirebound

PAGE DETAIL

115 Sheets, 80 gsm, 'To Do' pages, page perforation

DUPLICATE & TRIPLICATE RANGE



The duplicate and triplicate range is designed to enable businesses to run with maximum efficiency. Eliminating the task of writing out multiple pages can save companies a huge amount of time.



PLAIN RULED DUPLICATE BOOKS

- 6900-FRM Pack of 5 / Outer 25 (Size 105 x 130mm)
- 6901-FRM Pack of 5 / Outer 25 (Size 216 x 130mm)
- 6902-FRM Pack of 5 / Outer 25 (Size 248 x 187mm)
- 6903-FRM Pack of 5 / Outer 25 (Size A4)

PRODUCT DETAIL

No carbon (NCR), index pages, branded writing guard

PAGE DETAIL

100 Sets, sequentially numbered in sets 1-100 for accurate record-keeping, plain ruled, page perforation



PLAIN RULED TRIPLICATE BOOKS

- 6904-FRM Pack of 5 / Outer 25 (Size 105 x 130mm)
- 6905-FRM Pack of 5 / Outer 25 (Size 216 x 130mm)

PRODUCT DETAIL

Featuring No Carbon (NCR) paper for consistent copies, Taped cloth binding for traditional use, index pages, branded writing guard

PAGE DETAIL

100 Sets, sequentially numbered in sets 1-100 for accurate record-keeping, plain ruled, page perforation



ORDER / INVOICE DUPLICATE BOOKS

- 6907-FRM Pack of 5 / Outer 25
- 6908-FRM Pack of 5 / Outer 25

PRODUCT DETAIL

Size 210mm x 130mm, featuring No Carbon (NCR) paper for consistent copies, taped cloth binding for traditional use, index pages, branded writing guard

PAGE DETAIL

100 Sets, sequentially numbered in sets 1-100 for accurate record-keeping, pre-printed order and invoice pages, page perforation



WIREBOUND DUPLICATE/TRIPPLICATE BOOK

- 6909-FRM Pack of 5 / Outer 25
- 6910-FRM Pack of 5 / Outer 25

PRODUCT DETAIL

Size 210mm x 130mm, featuring No Carbon Required (NCR) paper for consistent copies, twin-wire binding, index pages, branded writing guard

PAGE DETAIL

50 Sets, plain ruled page perforation



RECEIPT BOOK DUPLICATE

DCU1520 Pack of 5 / Outer 25

PRODUCT DETAIL

Size 140 x 276mm, No Carbon Required (NCR) paper, taped cloth binding for traditional use, writing guard

PAGE DETAIL

200 Sets, sequentially numbered in sets 1–200 for accurate record-keeping, receipt pages, colour-coded pages for easy identification of original records and copies, page perforation



RECEIPT BOOK DUP / TRIP

DCU2520 Pack of 5 / Outer 25

TCU2520 Pack of 5 / Outer 25

PRODUCT DETAIL

Size 69 x 140mm, No Carbon Required (NCR), taped cloth binding for traditional use, writing guard

PAGE DETAIL

50 Sets, sequentially numbered in sets 1–50 for accurate record-keeping, receipt pages, colour-coded pages for easy identification of original records and copies, page perforation



SALES ORDER DUP BOOK / PURCHASE ORDER DUP BOOK

DCU5804 Pack of 5 / Outer 25

DCU5832 Pack of 5 / Outer 25

PRODUCT DETAIL

Size 137mm x 203mm, No Carbon Required (NCR), writing guard

PAGE DETAIL

50 Sets, sequentially numbered, colour-coded pages, page perforation



INVOICE DUP / TRIP BOOK

DCU5842 Pack of 5 / Outer 25

TCU5842 Pack of 5 / Outer 25

PRODUCT DETAIL

Size 137 x 203mm, No Carbon Required (NCR) paper, taped cloth binding for traditional use, writing guard

PAGE DETAIL

50 Sets, sequentially number in sets 1–50 for accurate record-keeping, invoice pages, vat details, colour-coded pages, page perforation



SALES INVOICE DUPLICATE / TRIPLICATE BOOK

DCU5841 Pack of 5 / Outer 25

TCU5841 Pack of 5 / Outer 25

PRODUCT DETAIL

Size 137 x 203mm, No Carbon Required (NCR) paper, taped cloth binding for traditional use, writing guard

PAGE DETAIL

50 Sets, sequentially numbered in sets 1–50 for accurate record-keeping, sales invoice pages, vat details, colour-coded pages, page perforation



ORDER DUP / TRIP BOOK

DCU5801 Pack of 5 / Outer 25

TCU5801 Pack of 5 / Outer 25

PRODUCT DETAIL

Size 137mm x 203mm, No Carbon Required (NCR), taped cloth binding for traditional use, writing guard

PAGE DETAIL

50 Sets, sequentially numbered, colour-coded pages, page perforation



DELIVERY NOTE

DCU5881 Pack of 5 / Outer 25

PRODUCT DETAIL

Size 137 x 203mm, no carbon required (ncr), taped cloth binding for traditional use, writing guard

PAGE DETAIL

50 Sets, sequentially numbered, colour-coded pages, page perforation



INVOICE DUPLICATE BOOKS

DU8142 Pack of 5 / Outer 25 (214 x 273mm)
DU5842 Pack of 5 / Outer 25 (137 x 203mm)

PRODUCT DETAIL

Carbon sheet supplied, taped cloth binding for traditional use, index pages

PAGE DETAIL

50 Sets, sequentially numbered in sets 1-50 for accurate record-keeping, invoice pages, vat details, page perforation



INVOICE DUPLICATE BOOK / ORDER DUPLICATE BOOK

DUP4566 Pack of 5 / Outer 25
DUP5862 Pack of 5 / Outer 25

PRODUCT DETAIL

Size 105mm x 130mm / size 216mm x 130mm, carbon sheet supplied, index pages

PAGE DETAIL

100 Sets, sequentially numbered, page perforation



PLAIN RULED DUPLICATE

DUP5869 Pack of 5 / Outer 25

PRODUCT DETAIL

Size 216mm x 130mm, carbon sheet supplied, taped cloth binding for traditional use, index pages

PAGE DETAIL

100 Sets, sequentially numbered in sets 1-100 for accurate record-keeping, plain ruled, page perforation



RAFFLE TICKETS, 500/1000 TICKETS

RAF500 Pack of 6 / Outer 72
RAF1000 Pack of 6 / Outer 36

PRODUCT DETAIL

Size 102mm x 140mm • book of 500 or 1000 tickets • assorted colours in pack

PAGE DETAIL

Numbered 500 = 1-500, 1000 = 1-1000

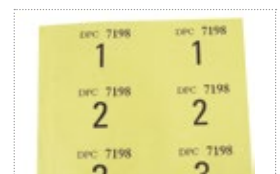

More office essentials. From Telephone Message forms to While You Were Out pads, these basic necessities are designed to make business life easier.



THINGS TO DO TODAY PAD

MU8171 Pack of 2 / Outer 36

PRODUCT DETAIL

Glued Head-bound • Hard Backing Covers

PAGE DETAIL

50 Sheets • Pre-printed 'To Do', Contacts and Follow up Tables

WHILE YOU WERE OUT PAD

9711D Pack of 12 / Outer 144

PRODUCT DETAIL

Size 102mm x 127mm • Glued Head-bound • Hard Backing Covers

PAGE DETAIL

100 Sheets • Quality White Paper • Pre-printed



PETTY CASH VOUCHER PAD

PETP100 Pack of 10 / Outer 100

PRODUCT DETAIL

Glued Side-bound • Hard Backing Covers

PAGE DETAIL

100 Sheets • Quality White Paper • Pre-printed

TELEPHONE MESSAGE PAD

EU547M2 Pack of 10 / Outer 200

PRODUCT DETAIL

Glued Head-bound • Hard Backing Covers

PAGE DETAIL

100 Sheets • Quality White Paper • Pre-printed

RESTAURANT PAD

RPJ2100 Pack of 2 / Outer 72

PRODUCT DETAIL

Glued Head-bound • Hard Backing Covers

PAGE DETAIL

100 Sheets • Sequentially Numbered for Accurate Record-keeping • Pre-printed Pages

RESTAURANT PADS



Pukka Pads Restaurant Pads are perfect for use in restaurants, cafés, bars and pubs as the design makes it easy to take orders while you are on your feet.



DUPLICATE RESTAURANT PAD 140 X 76MM

7073-RES Pack of 5 / Outer 50

PRODUCT DETAIL

4.5 inch Tear-off Strip for Orders • 1 inch Counterfoil Retained on Pad for Easy Record • 50 Carbonless Copy Slips for Instant Duplicate

PAGE DETAIL

Size 140mm x 76mm 50 Numbered Pages • Counterfoil for Duplication



DUPLICATE RESTAURANT PAD 165 X 95MM

7074-RES Pack of 5 / Outer 50

PRODUCT DETAIL

End Fold Duplicate Sheets Numbered 1-50 • Both Perforated • No Carbon Required

PAGE DETAIL

Size 165mm x 95mm • 50 Numbered Self Duplicating Sheets with Table Number • Date & Initials



TRIPPLICATE RESTAURANT PAD 165 X 95MM

7075-RES Pack of 5 / Outer 50

PRODUCT DETAIL

Numbered Consecutively 1 - 50 in Red • White Top Sheet • Coloured 2nd and 3rd Sheet

PAGE DETAIL

Size 165mm x 95mm • 50 Leaves in Triplicate



KITCHEN RESTAURANT PAD 127 X 64MM

7076-RES Pack of 5 / Outer 50

PRODUCT DETAIL

Perforated Pages

PAGE DETAIL

Size 127mm x 64mm • Numbered Consecutively 1 - 100



DUPLICATE RESTAURANT PAD 140 X 76MM

7077-RES Pack of 5 / Outer 50

PRODUCT DETAIL

End Fold Duplicate Restaurant Pad with Carbon

PAGE DETAIL

Size 140mm x 76mm • 50 Numbered Pages • Counterfoil for Duplication



RESTAURANT PAD 165 X 96MM

7078-RES Pack of 5 / Outer 50

PRODUCT DETAIL

End Fold Duplicate Restaurant Pad with Carbon

PAGE DETAIL

Size 165mm x 96mm • 50 Numbered Pages • Counterfoil for Duplication

Designed to meet the specialist needs of the accountancy profession. Each accountancy pad contains 80 sheets. Survey pads produced specifically for engineers' and surveyors' use. Pads are supplied in A4 and are bond ruled one side.



8 CASH COLUMN ACCOUNTANCY PAD

CV2064 Pack of 5 / Outer 20

PRODUCT DETAIL

This head-bound accountancy pad has 8 cash columns on each sheet and is made of high quality white paper to ensure minimum show-through of text.

PAGE DETAIL

80 sheets, 80gsm paper that is white bond and ruled on one side, 8 Cash Columns



6 CASH COLUMN ACCOUNTANCY PAD

CV2085 Pack of 5 / Outer 20

PRODUCT DETAIL

This head-bound accountancy pad has 6 cash columns on each sheet and is made of high quality white paper to ensure minimum show-through of text.

PAGE DETAIL

80 sheets, 80gsm paper that is white bond and ruled on one side, 6 Cash Columns



DOUBLE BILL SURVEY PAD

CV5066 Pack of 10 / Outer 20

PRODUCT DETAIL

Double bill survey pad. Each sheet is printed with line and column. Card cover notebook for flexibility Fits to standard filing systems

PAGE DETAIL

100 sheets, Head Bound Book with Feints 80gsm paper. Ruled on one side



SINGLE BILL SURVEY PAD

CV5072 Pack of 10 / Outer 20

PRODUCT DETAIL

Single bill right survey pad. Each sheet is printed with line and column. Card cover notebook for flexibility. Fits to standard filing systems

PAGE DETAIL

100 sheets, Head Bound Book with Feints 80gsm paper. Ruled on one side

Traditional style books for storing all your family, friends or business details in one place. Ideal for home or office use. Premium quality black padded binder. Loose leaf index and refill sheets.



A5 ADDRESS BOOK

80410/CD2 Boxed in 10

PRODUCT DETAIL

Black complete padded binder. For sheet size: A5 210x148mm. Loose leaf A-Z index and refill sheets (20 Sheets). Clear reinforced tabs and punched holes. Ideal for home or office use.



BUSINESS CARD BOOK

82310/CD5 Boxed in 10

PRODUCT DETAIL

Black complete binder holds 224 card, (Max capacity 432 cards). Size 280 X 292mm. Business cards and written details can be stored together for easy reference and retrieval of details at your fingertips. Come complete with A-Z reinforced index and clear plastic card holder sheets

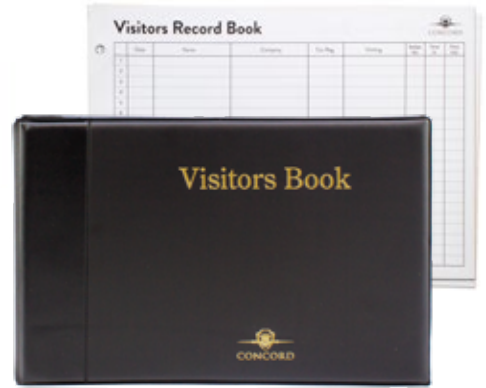

VISITORS BOOK

85710/CD14 Boxed in 10
85801/CD14P (10 Sets x 50 Sheets refill)

PRODUCT DETAIL

Record all your visitors information in one place: date, name, company, car registration, person visiting, badge number and time in and out. Ensure you comply with health and safety and fire regulations. Premium black binder comes complete with preprinted loose leaf sheets for 2000 entries with clear reinforced punch holes on every sheet for durability. Size: 230x335mm.



A5 TEL./FAX BOOK

87110/CD10 Pack of 10 / Outer 50

PRODUCT DETAIL

Combination telephone and fax reference book for quick and easy access to important information. Space available for mobile and email details. A-Z index with reinforced tabs for durability.



ADDRESS BOOK

CV6020 Pack of 5 / Outer 60

PRODUCT DETAIL

185 x 125mm, 16 Part A-Z. Keep all your addresses and telephone numbers in one stylish place. Wire-bound spine with alternate black and gold reinforced tabs for extra durability.



STATIC DESK PEN | SIGN IN

8720-PEN 5 inners of 10 (Box of 50)

PRODUCT DETAIL

Ergonomically Designed, aesthetically pleasing with adhesive pad on underside. This desk pen completes your visitor book system to create a complete solution to your signing in needs.

Introducing the brand new additions to our Pukka Post & Packaging range, our 40m and 60m 100% cotton string balls. Ideal for packaging, parcel wrapping and craft use.

NEW



Two lengths of 100% cotton string

Completely plastic free packaging

Packed in a branded CDUs or Pack of 4



COTTON STRING BALL

9767-PCK - 40m	Pack of 4 / Outer of 12
9767-PCK(12) - 40m	CDU of 12
9768-PCK - 60m	Pack of 4 / Outer of 12
9768-PCK(12) - 60m	CDU of 12

PRODUCT DETAIL

The cotton string balls are strong, reusable and made from 100% natural cotton, this means that they are fully biodegradable, and can be composted after use. They are versatile products that have many uses in the home, office or workplace. Use for home crafting, parcel wrapping, packaging and more! It is a great eco-friendly alternative to add to your post & packaging collection.

Peace of mind is a limited resource, especially when your business' livelihood depends on brilliant mailing services. Make sure that you have the best possible equipment to work with, by choosing Pukka Post & Packaging.



BROWN PARCEL TAPE - 6 PACK

9645-PCK Pack of 6 / Outer 36

PRODUCT DETAIL

Size: 48mm x 66m
 These brown tapes come in a 6 rolls, ideal for sealing parcels and boxes. Sticky and strong enough than the average, consistent and reliable performance in a wide range of applications.



CLEAR PARCEL TAPE - 6 PACK

9646-PCK Pack of 6 / Outer 36

PRODUCT DETAIL

Size: 48mm x 66m
 These clear tapes come in a 6 rolls, ideal for sealing parcels and boxes. Sticky and strong enough than the average, it won't breaking when packing, prevent coming off the cardboard during long time.



FRAGILE PARCEL TAPE - 6 PACK

9647-PCK Pack of 6 / Outer 36

PRODUCT DETAIL

Size: 50m x 33m
 Strong adhesive for secure sealing. Perfect for retail, warehouse, mailroom, and businesses to use.



CLEAR ADHESIVE TAPE (19MM X 66M) PACK OF 2

9648-PCK Pack of 2 / Outer 72

PRODUCT DETAIL

Our tape is perfect for sealing presents, boxes, providing extra security, the list is endless! It comes in a 2 pack and is strong and measures 19mm x 66m, ideal for home use. Fits in a standard 3" core tape dispenser.



PARCEL TAPE DISPENSER WITH PARCEL TAPE

9649-PCK Outer 24

PRODUCT DETAIL

The Tape Dispenser is easy and comfortable to use with a pistol grip on our plastic handle. Our pack of tapes cater for various tasks such as sealing boxes and parcels for shipping, for house/office moves and storage. Packaging kit contains 2 x rolls of tape and 1 x tape dispenser.

NEW

Pukka Post & packaging is aimed to take the stress out of all of your packaging needs! Pack it with confidence with our Pukka Post Poly Mailer bags.



POLY MAILER (165MM X 235MM) PACK OF 10

9652-PCK Pack of 10 / Outer 1000
 9652-PCK(5) Pack of 5 / Outer 250

PRODUCT DETAIL

Size: 165mm x 235mm +40mm in capacity
 Poly Mailer is made of plastic which can be recycled if checked locally.
 Peel off back with a self-seal grip. Tear resistant. Designated address area.
 Great for both personal and business use.



POLY MAILER (190 X 340MM) PACK OF 10

9653-PCK Pack of 10 / Outer 1000
 9653-PCK(5) Pack of 5 / Outer 250

PRODUCT DETAIL

Size: 190mm x 340mm +40mm in capacity
 Poly Mailer is made of plastic which can be recycled if checked locally.
 Peel off back with a self-seal grip. Tear resistant. Designated address area.
 Great for both personal and business use.



POLY MAILER (240 X 320MM) PACK OF 10

9654-PCK Pack of 10 / Outer 1000
 9654-PCK(5) Pack of 5 / Outer 250

PRODUCT DETAIL

Size: 240mm x 320mm +40mm in capacity
 Poly Mailer is made of plastic which can be recycled if checked locally.
 Peel off back with a self-seal grip. Tear resistant. Designated address area.
 Great for both personal and business use.



POLY MAILER (320 X 440MM) PACK OF 10

9655-PCK Pack of 10 / Outer 500
 9655-PCK(5) Pack of 5 / Outer 500

PRODUCT DETAIL

Size: 320mm x 440mm +40mm in capacity
 Poly Mailer is made of plastic which can be recycled if checked locally.
 Peel off back with a self-seal grip. Tear resistant. Designated address area.
 Great for both personal and business use.



POLY MAILER (410 X 500MM) PACK OF 10

9656-PCK Pack of 10 / Outer 250
 9656-PCK(5) Pack of 5 / Outer 250

PRODUCT DETAIL

Size: 410mm x 500mm +40mm in capacity
 Poly Mailer is made of plastic which can be recycled if checked locally.
 Peel off back with a self-seal grip. Tear resistant. Designated address area.
 Great for both personal and business use.

POLY MAILER (440 X 580MM) PACK OF 10

9657-PCK Pack of 10 / Outer 250
 9657-PCK(5) Pack of 5 / Outer 250

PRODUCT DETAIL

Size: 440mm x 580mm +40mm in capacity
 Poly Mailer is made of plastic which can be recycled if checked locally.
 Peel off back with a self-seal grip. Tear resistant. Designated address area.
 Great for both personal and business use.



POLY MAILER (510 X 680MM) PACK OF 10

9658-PCK Pack of 10 / Outer 200
 9658-PCK(5) Pack of 5 / Outer 250

PRODUCT DETAIL

Size: 510mm x 680mm +40mm in capacity
 Poly Mailer is made of plastic which can be recycled if checked locally.
 Peel off back with a self-seal grip. Tear resistant. Designated address area.
 Great for both personal and business use.

A5/A6 DOCUMENTS ENCLOSED - PACK OF 10

9659-PCK Pack of 10 / Outer 1000
 9660-PCK Pack of 10 / Outer 1000

PRODUCT DETAIL

These wallets are used to affix important papers to the top of your packages, so they don't get lost inside the box. They're easy to attach with peel & self-seal backing, requiring no tape or glue. Made of strong, tamper-proof material. Choose the right size between the A5 and A6.

Our parcel box range is made in Britain and is made from the highest quality single wall cardboard. We take pride in our packaging and we are all about creating the best possible first impression.



Flat packed structure,
easy to store and take up
minimal space

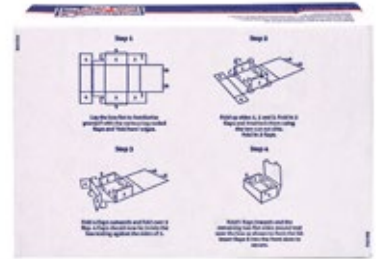

PUKKA POSTAL BOXES (SMALL/MEDIUM/LARGE)

- 9605-PCK - Small (271 x 181 x 99mm)
- 9653-PCK - Medium (350 x 250 x 160mm)
- 9606-PCK - Large (475 x 375 x 200mm)

- CDU of 10
- CDU of 10
- CDU of 10

PRODUCT DETAIL

Strong single wall cardboard • Lightweight • Dedicade space for senders and receivers address • Supplied as flat packed.
The single wall cardboard will protect your items during transit and is supplied flat packed for easy storage.



NEW



Sized to fit through
letter boxes

PUKKA MAILING BOXES (SMALL/MEDIUM)

- 9837-PCK - Small (217x108x20mm)
- 9838-PCK - Medium (320x230x19mm)

- CDU of 10
- CDU of 10

PRODUCT DETAIL

- Two sizes, both packed in CDUs
- Sized to fit through letter boxes
- Small measures 217x108x20mm
- Medium measures 320x230x19mm
- Designed and produced in the UK
- Made from 100% cardboard
- Recyclable with household waste
- Eco-friendly packaging solution



MULTIPURPOSE STICKER LABELS WHITE

7877-STA

Outer 20

PRODUCT DETAIL

- 50 Sheets • 4 Labels per sheet • Multipurpose sticker labels
- 200 stickers • White in colour • Self-adhesive and easy to peel off
- Suitable for addresses, names, etc..



250 SELF ADHESIVE LABELS ROLL (89 X 36MM)

7722-PCK

Outer 20

PRODUCT DETAIL

- Self Adhesive label rolls • Size: 89mm x 36mm • Roll of 250 stickers
- White in colour • Self-adhesive and easy to peel off • Suitable for addresses, names, etc. • Ideal for retail, warehouse, mailroom, and businesses to use.



BLACK PERMANENT MARKERS - 4 PACK

9650-PEN

Inner of 10 / Outer 50

PRODUCT DETAIL

Our 4 pack of black marker pens are perfect for writing on parcels, addressing labels, and marking. Featuring a chisel tip that is ideal for both thick and thin lines, perfect for all your packaging and post needs.



ASSORTED PERMANENT MARKERS - 4 PACK

9651-PEN

Inner of 10 / Outer 50

PRODUCT DETAIL

Our 4 pack of marker pens including a Black, Blue, Red, and Green pen are perfect for writing on parcels, addressing labels, and marking. Featuring a chisel tip that is ideal for both thick and thin lines, our Pukka Pens will be perfect for all your packaging and post needs.



Can be used for wrapping & packaging



Available in several sizes to meet your needs



Made from recycled material



KRAFT PAPER ROLLS

Perfect for your home and office, the Pukka Post Kraft Paper Roll is a must have for a multitude of reasons. You can use it for drawing or painting, either as a drop cloth or a medium. It makes a wonderful table cover for outdoor or messy meals. You can even use it as a sustainable wrapping paper, allowing you to create your own fun design for any occasion. Perfect for packing and shipping, wrap your delicate items or pad the box with extra paper. It's made of recycled materials and is recyclable when you're finished, making it an environmentally friendly option.

CODE/REF	DETAIL	SIZE	COLOUR	PACK SIZE
9661-PCK	Recycled Kraft Paper Roll 10 metre	10m x 50cm	Brown	25
9662-PCK	Recycled Kraft Paper Roll 25 metre	25m x 50cm	Brown	12
9663-PCK	Recycled Kraft Paper Roll 50 metre	50m x 50cm	Brown	12
9664-PCK	Recycled Kraft Paper Roll 10 metre	10m x 75cm	Brown	25
9665-PCK	Recycled Kraft Paper Roll 25 metre	25m x 75cm	Brown	12
9666-PCK	Recycled Kraft Paper Roll 50 metre	50m x 75cm	Brown	8
9667-PCK	Recycled Kraft Paper Roll 5 metre	5m x 70cm	Brown	20

Cushions and protect items to prevent damage



Transparent for easy item identification



Suitable for packing small and large objects



PROTECTIVE BUBBLE WRAP FOR PACKAGING AND MAILING

A great resource for any mailing or delivery room, the small-sized air-cushioned bubbles protect contents from devastating breakage due to falls and accidents. While securely wrapped in Pukka Post Bubble Wrap, items will be safer for postage and travel, giving you peace of mind. The lightweight material won't weigh down packages, either. For professional deliveries, trust Pukka.

All-purpose in use, Pukka Post Bubble Wrap can be used at home when moving house, or for storage solutions. The non-abrasive material won't scratch surfaces or cause unwanted discolouration, so you can safely use the wrap for long-term storage to keep your fragile items in pristine condition.

Made in Britain, each wrap roll measures approximately 300mm x 20mm, for a versatile and universal fit for any packing need.

CODE/REF	DETAIL	SIZE	COLOUR	PACK SIZE
7204-PCK	Bubble Wrap - 300mm x 5m	300mm x 5m	Clear	24
9536-PCK	Bubble Wrap - 300mm x 10m	300mm x 10m	Clear	10
9488-PCK	Bubble Wrap - 300mm x 20m	300mm x 20m	Clear	4
9614-PCK	Bubble Wrap - 300mm x 50m	300mm x 50m	Clear	1
9616-PCK	Bubble Wrap - 300mm x 100m	300mm x 100m	Clear	1
7462-PCK	Bubble Wrap - 500mm x 3m	500mm x 3m	Clear	12
9537-PCK	Bubble Wrap - 500mm x 5m	500mm x 5m	Clear	12
9538-PCK	Bubble Wrap - 500mm x 10m	500mm x 10m	Clear	4
9539-PCK	Bubble Wrap - 500mm x 20m	500mm x 20m	Clear	4
9617-PCK	Bubble Wrap - 500mm x 50m	500mm x 50m	Clear	1
9619-PCK	Bubble Wrap - 500mm x 100m	500mm x 100m	Clear	1
BR 20	Bubble Wrap - 750mm x 75m	750mm x 75m	Clear	1

Here at Pukka Pads we think these bubble envelopes are essential for sending out any fragile items. The lining in these mailers will provide extra strength along with puncture resistance, helping to protect the contents throughout the mailing process. They also have a useful strong self-seal closure, making these Pukka Post Envelopes perfect for mailing out fragile or delicate items.



BUBBLE LINED ENVELOPES, SIZE A

7060-ENV Pack of 10 / Outer 200

PRODUCT DETAIL

These padded envelopes have a peel and seal closure making them easy to use and much more hygienic than the standard gummed envelopes. Strong peel and seal closure for ease of use. Lightweight with superb crush protection
Size A Gold (175mm x 130mm)



BUBBLE LINED ENVELOPES, SIZE B

7061-ENV Pack of 10 / Outer 200

PRODUCT DETAIL

As part of Pukka's range of professional postage products, Pukka size B gold bubble-lined envelopes bring the quality and reliability you've come to expect from Pukka.
Size B Gold (225 X 140mm)



BUBBLE LINED ENVELOPES, SIZE C

7062-ENV Pack of 10 / Outer 100

PRODUCT DETAIL

These padded envelopes have a peel and seal closure making them easy to use and much more hygienic than the standard gummed envelopes. Strong peel and seal closure for ease of use. Lightweight with superb crush protection
Size C Gold (170 X 225mm)



BUBBLE LINED ENVELOPES, SIZE D

7063-ENV(4) Pack of 4 / Outer 100
7063-ENV(10) Pack of 10 / Outer 100

PRODUCT DETAIL

Bubble Lined Envelope, Size D Gold (200 x 275mm) Pack of 100. Lightweight and impact resistant. Bubble lined interior to protect contents. Peel and seal closure.



BUBBLE LINED ENVELOPES, SIZE E

7064-ENV Pack of 10 / Outer 100

PRODUCT DETAIL

Bubble Lined Envelope, Size E Gold (240 x 275mm) Pack of 100. Lightweight and impact resistant. Bubble lined interior to protect contents. Peel and seal closure.



BUBBLE LINED ENVELOPES, SIZE F

7065-ENV Pack of 10 / Outer 100

PRODUCT DETAIL

Bubble Lined Envelope, Size F Gold (250 x 345mm) Pack of 100. Lightweight and impact resistant. Bubble lined interior to protect contents. Peel and seal closure.



BUBBLE LINED ENVELOPES, SIZE G

7066-ENV(4) Pack of 4 / Outer 100
7066-ENV(10) Pack of 10 / Outer 100

PRODUCT DETAIL

Bubble Lined Envelope, Size G Gold (260 x 345mm) Pack of 100. Lightweight and impact resistant. Bubble lined interior to protect contents. Peel and seal closure.



BUBBLE LINED ENVELOPES, SIZE H

7067-ENV Pack of 10 / Outer 100

PRODUCT DETAIL

Bubble Lined Envelope, Size H Gold (290 X 370mm) Pack of 100. Lightweight and impact resistant. Bubble lined interior to protect contents. Peel and seal closure.



BUBBLE LINED ENVELOPES, SIZE J

7068-ENV Pack of 10 / Outer 50

PRODUCT DETAIL

Bubble Lined Envelope, Size J Gold (320 x 445mm) Pack of 50. Lightweight and impact resistant. Bubble lined interior to protect contents. Peel and seal closure.



BUBBLE LINED ENVELOPES, SIZE K

7069-ENV Pack of 10 / Outer 50

PRODUCT DETAIL

Bubble Lined Envelope, Size K (370 x 480mm) Gold (Pack of 50). Lightweight and impact resistant. Bubble lined interior to protect contents. Peel and seal closure.



BUBBLE LINED ENVELOPES, SIZE CD

7072-ENV Pack of 10 / Outer 100

PRODUCT DETAIL

Strong outer Kraft paper for maximum protection. Bubble lined for further cushioning. Self seal closure on flap. Easy to write on and accepts labels, stamps and franks easily. Size 175 X 200mm, CD size gold

The Concord Envelopes range includes envelopes for all your practical needs. From sending an important letter to paying your staff, the Concord envelopes have something for every occasion. The Concord Envelopes are all premium quality of between 80-115gsm.



C4/C5/C6 PEEL & SEAL ENVELOPES

- C4WPS-10 Pack of 10 (C4 – 324 x 229mm)
- C5WPS –10 Pack of 10 (C5 – 229 x 162mm)
- C6WPS-50 Pack of 50 (C6 – 114 x 162)

PRODUCT DETAIL

Size C4/C5/C6 • Peel & Seal • White Envelopes • 90gsm



C4/C5 PEEL & SEAL ENVELOPES

- RR20 Pack of 50 (C4 – 324 x 229mm)
- RR10 Pack of 50 (C5 – 229 x 162mm)

PRODUCT DETAIL

Size C4/C5 • Peel & Seal • Manilla Envelopes • 115gsm

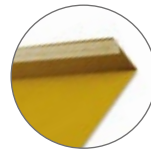

DL PEEL & SEAL ENVELOPES

- DLWPS-50 Pack of 50

PRODUCT DETAIL

Size 110 x 220mm • Peel & Seal • White Envelopes • 90gsm • 50 Envelopes



C4/C5/C6 SELF SEAL ENVELOPES

- SW65 Pack of 25 (C4) 90gsm
- SW50 Pack of 25(C5) 80gsm
- SW61 Pack of 50 (C6) 80gsm

PRODUCT DETAIL

Size C4/C5/C6 • Self Seal • White Envelopes



C4/C5 SELF SEAL ENVELOPES

- SW57 Pack of 25 / Outer 20 (C4) 80gsm
- SW47 Pack of 25 / Outer 20 (C5) 80gsm

PRODUCT DETAIL

Size C4/C5 • Self Seal • Manilla Envelopes • 80gsm



DL SELF SEAL ENVELOPES

- SS01 Pack of 50 (Window Envelopes)
- S140 Pack of 50

PRODUCT DETAIL

Size 110 x 220mm • Self Seal • White Envelopes • 80gsm





C5/C6 GUMMED ENVELOPES

- SW45 Pack of 25 (C5 Manilla)
- SW15 –Pack of 50 outer of 20 (C6 Manilla)
- SW20 Pack of 50 (C6 White)

PRODUCT DETAIL

Size C5/C6 • Gummed • White / Manilla Envelopes • 80gsm



DL GUMMED ENVELOPES

- SW25 Pack of 50 (Manilla)
- SW30 Pack of 50 (White)

PRODUCT DETAIL

Size DL – 110 x 220mm • Gummed • White / Manilla Envelopes • 80gsm

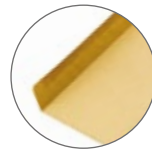

SMALL GUMMED ENVELOPES

- SW10 Pack of 50 (89 x 152mm)
- SW01 Pack of 50 (Manilla)

PRODUCT DETAIL

Size 89 x 152mm • Gummed • White / Manilla Envelopes • 80gsm • 50 Envelopes



SMALL SELF SEAL ENVELOPES

- SW12 Pack of 50 (White)

PRODUCT DETAIL

Size 89 x 152mm • Self Seal • White Envelopes • 80gsm

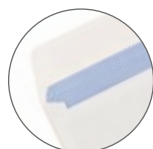

SELF SEAL WAGE ENVELOPES

- 7447-ENV Pack of 50 (Printed Wage Envelope)
- 7448-ENV Pack of 50 (Wage Envelope)

PRODUCT DETAIL

Size 102 x 108mm • Self Seal • Manilla Envelopes • 80gsm



GUMMED MONEY ENVELOPES

- 7449-ENV Pack of 50
- 100062CWG Box of 1,000

PRODUCT DETAIL

Size 62 x 100mm • Gummed • Manilla Envelopes • 80gsm



Pukka Post & Packaging aims to take the stress out of all of your packaging needs! A place to buy all your packaging in one go! Our coloured envelopes are perfect for all occasions including wedding invitations, Christmas cards, birthday cards, pen pals & baby showers!

MULTI-PACKS COLOURED ENVELOPES

Pack of 25 • 100 GSM • Gummed



9059-ENV (Size C6)
9060-ENV (Size C5)
COLOURS:
Amethyst, Soft Pink, Soft Blue,
Leaf Bird Green, Vanilla.



9061-ENV (Size C6)
9062-ENV (Size C5)
COLOURS:
Poppy Red, Canary Yellow,
Meadow Green, Kingfisher Blue,
Fuchsia Pink .



9063-ENV (Size C6)
9064-ENV (Size C5)
COLOURS:
Gold.



9065-ENV (Size C6)
9066-ENV (Size C5)
COLOURS:
Silver.



9067-ENV (Size C6)
9068-ENV (Size C5)
COLOURS:
Fresh White.





CHRISTMAS COLLECTION BAUBLE CARDS

9774-SPP Pack of 10 Cards and Envelopes

PRODUCT DETAIL

Pack of 10 festive cards with a matte finish and gold foiled lettering, they are sure to be a great addition to any christmas celebration. With an assortment of two designs in the Bauble range, you can mix and match greetings as you wish, while still keeping eco-friendly with our FSC certified card and envelope bundle.



CHRISTMAS COLLECTION FLORAL BERRIES

9775-XMS Pack of 10 Cards and Envelopes

PRODUCT DETAIL

Pack of 10 festive cards with a matte finish which are sure to be a great addition to any christmas celebration. With an assortment of two designs in the Floral Berries Range, you can mix and match greetings as you wish, while still keeping eco-friendly with our FSC certified card and envelope bundle.



CHRISTMAS COLLECTION FOXES

9777-XMS Pack of 10 Cards and Envelopes

PRODUCT DETAIL

Pack of 10 festive cards with a matte finish which are sure to be a great addition to any christmas celebration. With an assortment of two designs in the Foxes Range, you can mix and match greetings as you wish, while still keeping eco-friendly with our FSC certified card and envelope bundle.



CHRISTMAS COLLECTION HOUSE CARDS

9776- XMS Pack of 10 Cards and Envelopes

PRODUCT DETAIL

Pack of 10 festive cards with a matte finish which are sure to be a great addition to any christmas celebration. With an assortment of two designs in the Houses Range, you can mix and match greetings as you wish, while still keeping eco-friendly with our FSC certified card and envelope bundle.

DESIGN STUDIO



We wouldn't be able to provide any of this to our consumers without the help of our studio teams. Our team of talented designers stay on top of trends and with their vision, intense dedication and passion for the Pukka Pads brand this results in designs that delight and inspire consumers worldwide.

People expect more from our products and that's what they get. We have an innovation team dedicated to new product design. From concept to prototype, our innovation team use the latest research to develop everyday, school, and office supplies that consumers love.

Our studio love to innovate, so our product and design portfolio is constantly growing! We would love to share our team's vision with you!

CUSTOM MADE PRODUCTS

In addition to the many varied products listed, we also develop bespoke products exclusive to a brand or manufacturer. We offer a fully bespoke service and can create fully branded products to match your venue, brand or event. These can be:

- Selected from our range or created to suit your own
- Designed and printed to your requirements
- Packaged to meet your needs

If you are interested in purchasing for your own brand, minimum orders may apply. Contact us to find out how we can add value to your brand.



DESIGN PORTFOLIO

Contact your sales representative to view our products and design portfolio. Or why not discuss working with our design team? We can create exclusive cover designs suited to your own vision.

THE PUKKA GROUP

UK Main Office

312 Bournemouth Road, Branksome,
Poole, Dorset
BH14 9AP - UK
Telephone: (+44) 01202 339 960

info@pukka-pads.co.uk
www.pukka-pads.co.uk





CARPE DIEM

PRODUCT
COLLECTIONS

THE PUKKA GROUP



CARPE
DIEM



www.pukka-pads.co.uk

TABLE OF CONTENTS

BLACK COLLECTION.....	1
BUFFALO CHECK COLLECTION.....	2
BALLERINA PINK COLLECTION.....	3
SKY BLUE COLLECTION.....	4
FEATHERS COLLECTION.....	6
DITZY FLORAL COLLECTION.....	7
COLOUR WASH COLLECTION.....	8
SPIRAL PLANNERS.....	10
2023 CARPE DIEM DIARIES.....	11
STICKER TABLETS.....	12
RAINBOW COLOUR WASH COLLECTION.....	13
FLORAL LOVE COLLECTION.....	13
A6 NOTELET SETS.....	14
DISPLAY.....	15



BLACK COLLECTION

An everyday staple, the Black core collection ticks all the boxes. Gold hardware details and stationery must-haves with spot prints give an on trend and elevated feel to the collection.



1	9109-CD	A5 Planner	Black	Includes black 12 month undated insert set
2	9110-CD	Personal Planner	Black	Includes black 12 month undated insert set
3	9113-CD	Slim Pencil Case	Black	
4	9111-CD	Notebook Holder	Black	Includes 2 notebooks - 1 plain / 1 ruled
5	9360-CD	A6 Notebook & Passport Holder	Black	
6	9119-CD	Daily Planner Pad	Black	Tear off sheets
7	9118-CD	Magnetic To Do List	Black	Tear off sheets
8	9114-CD(22)	Metal Gel Pen	Black	Black gel ink
9	9229-CD(22)	Ballpoint Pen 4 Pack	Monochrome	Black ink
10	9372-CD	Soft Cover Journal	Black	Ruled pages with elastic closure and ribbon page marker
11	9120-CD	Weekly Planner Pad	Black	Tear off sheets

BUFFALO CHECK COLLECTION

Make a statement with the Buffalo Check collection. The monochrome palette allows you to mix and match with our core Black collection.



1	9182-CD	A5 Planner	Buffalo Check	Includes black 12 month undated insert set
2	9183-CD	Personal Planner	Buffalo Check	Includes black 12 month undated insert set
3	9185-CD	Slim Pencil Case	Buffalo Check	
4	9184-CD	Notebook Holder	Buffalo Check	Includes 2 notebooks - 1 plain / 1 ruled
5	9365-CD	A6 Notebook & Passport Holder	Buffalo Check	
6	9112-CD	Pom Pom Keyring	Black	Faux fur
7	9375-CD	B5 Spiral Hard-cover Notebook	Black	Ruled pages
8	9186-CD(22)	Metal Gel Pen	Buffalo Check	Black gel ink
9	9070-CD	Notebook Insert	Mixed Media	20 pages 1 pack 320 gsm

BALLERINA PINK COLLECTION

Pretty in pink and a little bit sweet. The core Ballerina Pink collection features heart prints and rainbow stripes across its planners, notebook holders, notebooks, journals and stationery essentials.



1	9152-CD	A5 Planner	Ballerina Pink	Includes black 12 month undated insert set
2	9153-CD	Personal Planner	Ballerina Pink	Includes black 12 month undated insert set
3	9156-CD	Slim Pencil Case	Ballerina Pink	
4	9154-CD	Notebook Holder	Ballerina Pink	Includes 2 notebooks - 1 plain / 1 ruled
5	9361-CD	A6 Notebook & Passport Holder	Ballerina Pink	
6	9376-CD	B5 Spiral Hard-cover Notebook	Ballerina Pink	Ruled pages
7	9370-CD	Soft Cover Journal	Ballerina Pink	Ruled pages with elastic closure and ribbon page marker
8	9162-CD	Daily Planner Pad	Rainbow Stripe/Ballerina Pink	Tear off sheets
9	9157-CD(22)	Metal Gel Pen	Ballerina Pink	Black gel ink
10	9155-CD	Pom Pom Keyring	Ballerina Pink	Faux fur
11	9161-CD	Magnetic To Do List	Ballerina Pink	Tear off sheets
12	9163-CD	Weekly Planner Pad	Ballerina Pink	Tear off sheets

SKY BLUE COLLECTION

Keeping it cool and calm with the Sky Blue collection, a core colourway, complemented with gold hardware. Featuring feather print details, the collection can be perfectly mixed and matched with the Feathers collection.



1	9164-CD	A5 Planner	Sky Blue	Includes black 12 month undated insert set
2	9165-CD	Personal Planner	Sky Blue	Includes black 12 month undated insert set
3	9169-CD	Slim Pencil Case	Sky Blue	
4	9166-CD	Notebook Holder	Sky Blue	Includes 2 notebooks - 1 plain / 1 ruled
5	9362-CD	A6 Notebook & Passport Holder	Sky Blue	
6	9378-CD	B5 Spiral Hard-cover Notebook	Sky Blue	Ruled pages
7	9176-CD	Magnetic To Do List	Sky Blue	Tear off sheets
8	9171-CD(22)	Metal Gel Pen	Sky Blue	Black gel ink
9	9168-CD	Pom Pom Keyring	Sky Blue	Faux fur
10	9374-CD	Soft Cover Journal	Sky Blue	Ruled pages with elastic closure and ribbon page marker
11	9178-CD	Weekly Planner Pad	Sky Blue	Tear off sheets



THIS WEEK				
Monday	Tuesday	Wednesday	Thursday	Friday

TO DO
AS Daily Planner
Pad
CAPPEDEM



Did you know...?

All Planners, Notebook Holders, Journals and Pencil Cases are made from a quality vegan leather, with a high quality FSC®-certified paper used across all paper products.

FEATHERS COLLECTION

Float away on the wings of a pastel hued dream with the Feathers collection. A cobalt speckle print lines the collection, adding both a stylish and playful touch. Mix and match with the Sky Blue collection to create a refreshing stationery range.



1	9209-CD	A5 Planner	Feathers	Includes sky blue 12 month undated insert set
2	9210-CD	Personal Planner	Feathers	Includes sky blue 12 month undated insert set
3	9212-CD	Slim Pencil Case	Feathers	
4	9211-CD	Notebook Holder	Feathers	Includes 2 notebooks - 1 plain / 1 ruled
5	9363-CD	A6 Notebook & Passport Holder	Feathers	
6	9218-CD	Daily Planner Pad	Feathers	Tear off sheets
7	9217-CD	Magnetic To Do List	Feathers	Tear off sheets
8	9213-CD(22)	Metal Gel Pen	Feathers	Black gel ink
9	9379-CD	B5 Spiral Hard-cover Notebook	Feathers	Ruled pages
10	9230-CD(22)	Ballpoint Pen 4 Pack	Feathers	Black ink
11	9373-CD	Soft Cover Journal	Feathers	Ruled pages with elastic closure and ribbon page marker
12	9219-CD	Weekly Planner Pad	Feathers	Tear off sheets

DITZY FLORAL COLLECTION

Cascading florals and soothing blues flow across the Ditzzy Floral collection. A ballerina pink check lines planners and notebook holders, with a matching all-over print across a notebook, journal and pencil case.



1	9198-CD	A5 Planner	Ditzzy Floral	Includes black 12 month undated insert set
2	9199-CD	Personal Planner	Ditzzy Floral	Includes black 12 month undated insert set
3	9201-CD	Slim Pencil Case	Ballerina Pink Check	
4	9200-CD	Notebook Holder	Ditzzy Floral	Includes 2 notebooks - 1 plain / 1 ruled
5	9364-CD	A6 Notebook & Passport Holder	Ditzzy Floral	
6	9207-CD	Daily Planner Pad	Ditzzy Floral	Tear off sheets
7	9206-CD	Magnetic To Do List	Ditzzy Floral	Tear off sheets
8	9202-CD(22)	Metal Gel Pen	Ditzzy Floral	Black gel ink
9	9377-CD	B5 Spiral Hard-cover Notebook	Ballerina Pink Check	Ruled pages
10	9228-CD(22)	Ballpoint Pen 4 Pack	Hearts	Black ink
11	9371-CD	Soft Cover Journal	Ballerina Pink Check	Ruled pages with elastic closure and ribbon page marker
12	9208-CD	Weekly Planner Pad	Ditzzy Floral	Tear off sheets

COLOUR WASH COLLECTION

Embrace painterly strokes of bold colour across our Colour Wash A5 and Personal Planner. A midnight blue lining complements the striking cover with gold hardware details adding a little something extra.



4 PACK NOTEBOOKS

Packs of compatible notebooks in a range of colours and patterns allow you to personalise your A6 Passport & Notebook Holder available in three different designs, each pack includes a weekly planner and plain, lined and dotted notebooks.



1	9179-CD	A5 Planner	Colour Wash	Includes black 12 month undated insert set
2	9180-CD	Personal Planner	Colour Wash	Includes black 12 month undated insert set
3	9181-CD(22)	Metal Gel Pen	Colour Wash	Black gel ink
4	9368-CD	A6 Notebook 4 Pack	Feathers	4 different notebooks - dot grid, lined, plain & planner
5	9367-CD	A6 Notebook 4 Pack	Hearts	4 different notebooks - dot grid, lined, plain & planner
6	9366-CD	A6 Notebook 4 Pack	Monochrome	4 different notebooks - dot grid, lined, plain & planner
7	9361-CD	A6 Notebook & Passport Holder	Ballerina Pink	

A5 PLANNER DETAILS

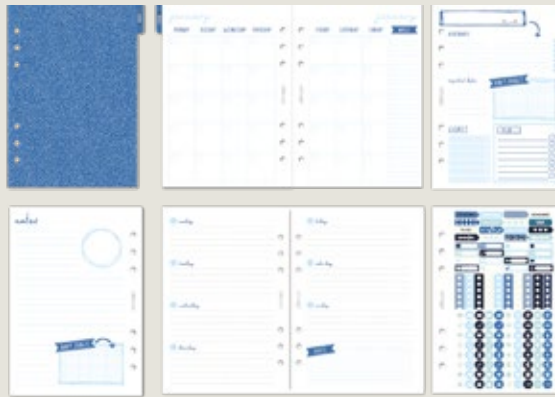

Comes with co-ordinating inserts:

- 12 Monthly Tabbed Dividers
- 12 Monthly Calendar Layouts (undated)
- 60 Horizontal Weekly Layouts (undated)
- 12 Lined Pages
- 12 Grid Pages
- 12 Plain Pages
- 2 Acetate Bookmarks with Gold Foil
- 1 Acetate Dashboard with Gold Foil
- 1 Dashboard Insert
- 3 Sticker Sheets

PERSONAL PLANNER DETAILS

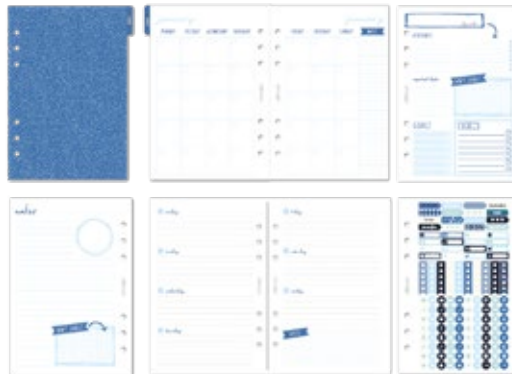

Comes with co-ordinating inserts:

- 12 Monthly Tabbed Dividers
- 12 Monthly Calendar Layouts (undated)
- 60 Horizontal Weekly Layouts (undated)
- 12 Lined Pages, 12 Grid Pages,
- 12 Plain Pages
- 2 Acetate Bookmarks with Gold Foil
- 1 Acetate Dashboard with Gold Foil
- 1 Dashboard Insert
- 3 Sticker Sheets

EVERYDAY LIVING SPIRAL PLANNERS

Keep the family and home well organised with the Home Spiral Planner, perfect for keeping important information on hand. And, intended to keep you financially in control, the Budget Spiral Planner is both functional and universal, with multi-currency icons. Step by step guides and simple layouts encourage the user to reach saving goals.



1

12 Month Undated Planner, coated tabbed dividers, budget Tracking insert, includes 2 sticker sheets with 183 stickers and 1 interior pocket

Lots of pages to help you plan including 6 Tabbed dividers, 7 Personal info inserts, 14 Calendar inserts, 26 Schedule inserts, 21 Get it done inserts, 21 Menu plan inserts, 8 To do inserts, 1 Interior pocket



2

1	10767	Spiral Planner	Home	Undated yearly home planner with tabbed dividers
2	10768	Spiral Planner	Budget	Undated yearly budget planner with tabbed dividers

2024 CARPE DIEM DIARIES

Plan out every day in detail with the 12-Month Weekly Diary/Planner. The premium PU cover is filled with a structured layout to let you see each week's appointments at a glance across a two-page spread.



1



What's inside?

- Yearly & monthly calendars
- Week to view spreads
- Lined notes pages
- 12 monthly overviews with goals, important dates, to-do lists and wish lists



2



Expandable inner pocket

3

- 1 **9691-CD**
- 2 **9692-CD**
- 3 **9693-CD**

Soft Cover Diary (213mm x 133mm)
Soft Cover Diary (213mm x 133mm)
Soft Cover Diary (213mm x 133mm)

Black
Ballerina Pink
Sky Blue

With ribbon bookmark and elastic fastener, high quality ivory-colored, 80gsm acid-free paper, colour-coordinated expandable inner pocket.

STICKER TABLETS

Plan, personalise and prettify with our extensive range of sticker tablets. Available in two sizes, our mini tablets are perfect for sliding in between the pages of a planner. And each tablet offers hundreds of stickers to choose from.



1	7993	Mini Sticker Tablet	Bloom	Tear off sheets - 568 stickers
2	7983	Mini Sticker Tablet	Seasons	Tear off sheets - 578 stickers
3	7956	Mini Sticker Tablet	Good Vibes	Tear off sheets - 594 stickers
4	7994	Mini Sticker Tablet	Faith	Tear off sheets - 777 stickers
5	10262	A5 Sticker Tablet	Good Vibes	Tear off sheets - 533 stickers
6	10769	A5 Sticker Tablet	Budget	Tear off sheets - 561 stickers
7	8902	A5 Sticker Tablet	Fitness	Tear off sheets - 803 stickers
8	8916	A5 Sticker Tablet	Home	Tear off sheets - 725 stickers
9	10184	A5 Sticker Tablet	Tabs	Tear off sheets - 522 stickers



RAINBOW COLOUR WASH COLLECTION

A burst of bright colour and cute llamas come together in the Rainbow Colour Wash collection. With our three-packs of Project Books and Composition Books there is no reason not to look beyond the rainbow for a bit of inspiration.



FLORAL LOVE COLLECTION

Fill your heart with romantic blooms and soft tones of coral, mint and navy with the Floral Love collection. Perfect for note-taking and planning, the collection includes a range of different notebooks.



1	9032-CD	3 Pack Project Books	Rainbow Colour Wash	Ruled pages with 4 removable tabbed dividers & elastic closure
2	9095-CD*	3 Pack Composition Books	Rainbow Colour Wash	140 Ruled pages, 80gsm quality paper
3	9033-CD	3 Pack Project Books	Floral Love	Ruled pages with 4 removable tabbed dividers & elastic closure
4	9096-CD	3 Pack Composition Books	Floral Love	140 Ruled pages, 80gsm quality paper

* Products sold in the US Only

A6 NOTELET SETS

Our 10 packs of notelets make sending mail fun. From Thank Yous to I Love Yous, they are the perfect expression of friendship, gratitude and affection. Each pack has five different designs with complementary envelopes.

SPECIAL
ORDERS
ONLY



1



2



3

1	9404-CD	Thank You Card 10 Pack	Rainbow Colour Wash	10 pack with 5 different designs and matching envelopes
2	9405-CD	Thank You Card 10 Pack	Feathers	10 pack with 5 different designs and matching envelopes
3	9407-CD	With Love Card 10 Pack	Hearts	10 pack with 5 different designs and matching envelopes





BEAUTIFUL PACKAGING

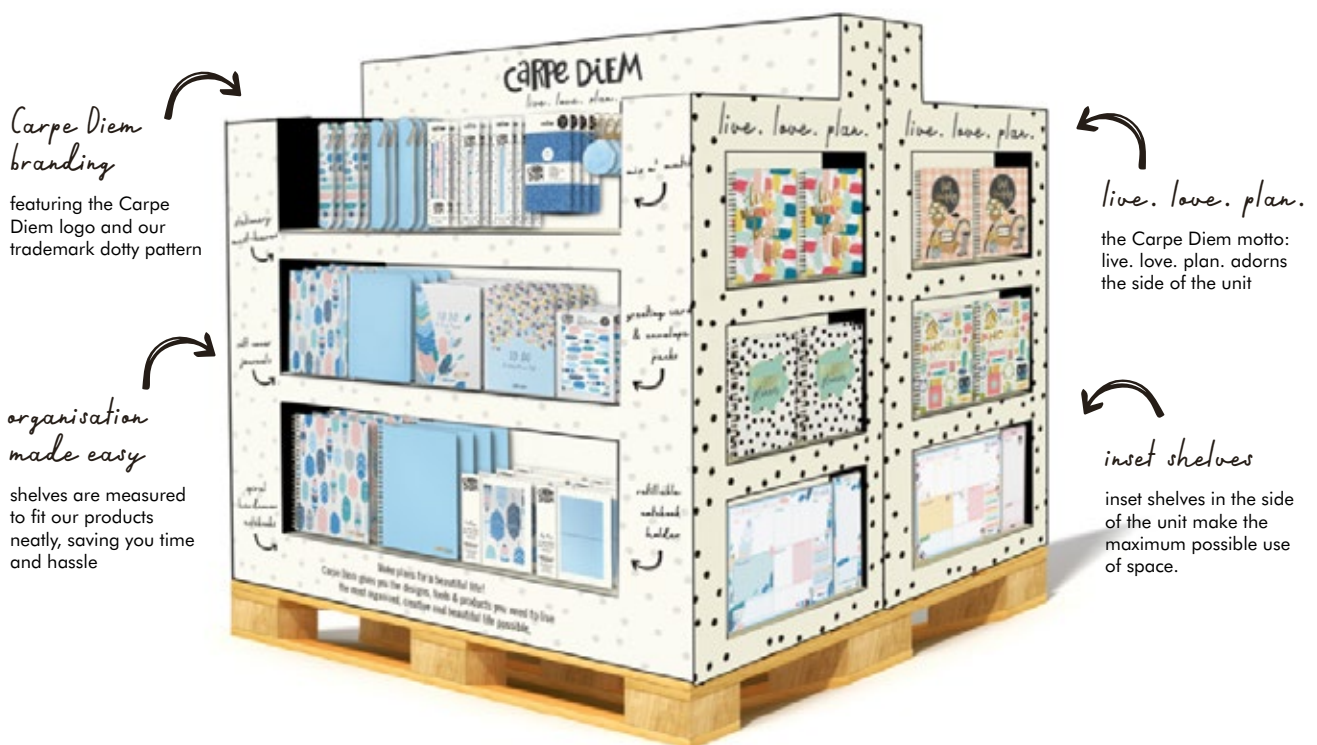

DISPLAY

A one stop destination for your Carpe Diem collection, our free standing display units can house a wide variety of different products. With multiple shelves, there are countless combinations of merchandising options- giving you the flexibility to create something that works for you.





*Carpe Diem provides the products
you need to live the most organised,
creative and beautiful life.*

CONTACT US

wholesale@carpediemplanners.co.uk

DESIGN STUDIO



We wouldn't be able to provide any of this to our consumers without the help of our studio teams. Our team of talented designers stay on top of trends and with their vision, intense dedication and passion for the Pukka Pads brand this results in designs that delight and inspire consumers worldwide.

People expect more from our products and that's what they get. We have an innovation team dedicated to new product design. From concept to prototype, our innovation team use the latest research to develop everyday, school, and office supplies that consumers love.

Our studio love to innovate, so our product and design portfolio is constantly growing! We would love to share our team's vision with you!

CUSTOM MADE PRODUCTS

In addition to the many varied products listed, we also develop bespoke products exclusive to a brand or manufacturer. We offer a fully bespoke service and can create fully branded products to match your venue, brand or event. These can be:

- Selected from our range or created to suit your own
- Designed and printed to your requirements
- Packaged to meet your needs

If you are interested in purchasing for your own brand, minimum orders may apply. Contact us to find out how we can add value to your brand.



DESIGN PORTFOLIO

Contact your sales representative to view our products and design portfolio. Or why not discuss working with our design team? We can create exclusive cover designs suited to your own vision.

THE PUKKA GROUP

UK Main Office

312 Bournemouth Road, Branksome,
Poole, Dorset
BH14 9AP - UK
Telephone: (+44) 01202 339 960

info@pukka-pads.co.uk
www.pukka-pads.co.uk

