

XPS 15 9520

External Display Connection Guide



Notes, cautions, and warnings

 **NOTE:** A NOTE indicates important information that helps you make better use of your product.

 **CAUTION:** A CAUTION indicates either potential damage to hardware or loss of data and tells you how to avoid the problem.

 **WARNING:** A WARNING indicates a potential for property damage, personal injury, or death.

Contents

Chapter 1: Before you begin	4
Modes of connection.....	4
Turn off the computer display.....	5
Chapter 2: Connect external displays	6
Integrated graphics.....	6
Chapter 3: Troubleshooting	10
Chapter 4: Getting help and contacting Dell	11

Before you begin

You can connect up to three 4K external displays or one 5K, or one 8K or higher displays using the USB-C ports available on your XPS 15 9520.

Before you begin, ensure that you check the ports available on your external displays and decide on the [modes of connections](#).

NOTE: Regardless of a Discrete Graphics Controller (dGPU) on some models, all external displays are controlled by the Integrated graphics controller (iGPU).

Modes of connection

Depending on the connectors available on your external display, you can connect the displays to the Thunderbolt 4 USB-C port on your computer using:

- Thunderbolt 4 cables, adapters or docking stations
- USB-C cables, adapters or docking stations

NOTE: To experience the full resolution supported by your external displays, use appropriate cables. For example, use DisplayPort or HDMI cables for 4K and above resolution.

NOTE: USB-C or Thunderbolt docking stations can be used to connect external displays to the computer using a single USB-C cable, while charging the computer. For more information about the types of docking stations available from Dell, see the knowledge base article [000124295](#) at www.dell.com/support.

NOTE: USB-C adapters can also be used to connect external displays to the computer, though these do not allow power charging at the same time. For more information about the types of USB-C adapters available from Dell, see the knowledge base article [000125728](#) at www.dell.com/support.

USB-C and Thunderbolt 4 USB-C ports available on your computer:

NOTE: When connecting a display using an adapter or docking station, it is recommended that you connect the display to the docking station first and then connect the docking station to the Thunderbolt 4 USB-C port on your computer.

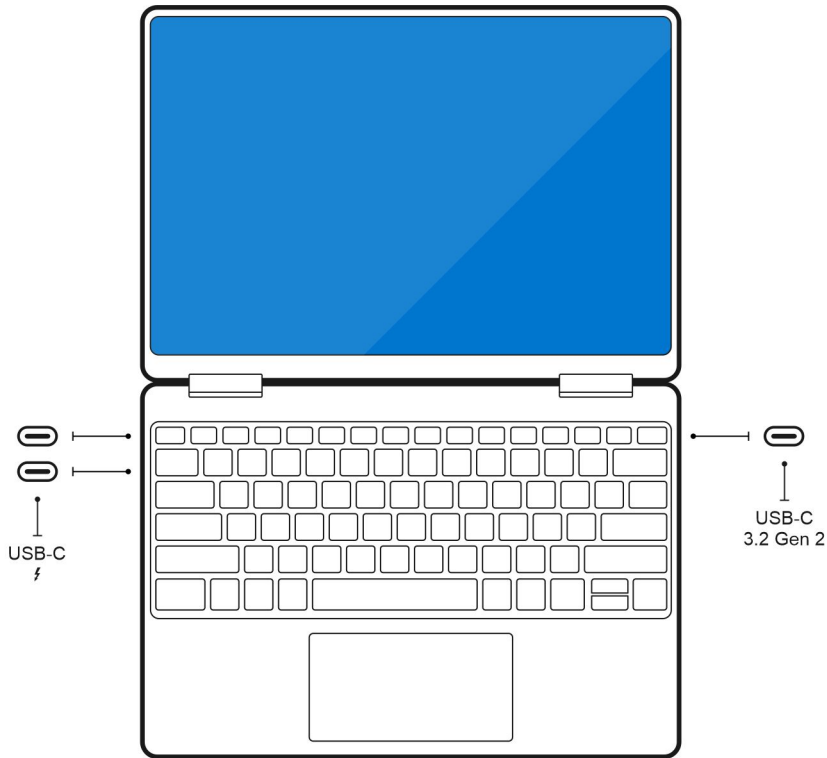

Turn off the computer display

There may be instances where you may want to turn off the computer's display to connect more external displays. You can turn off the display of your computer by using the Intel HD Graphics Command Center.

NOTE: Connect and configure at least one external display before disabling the computer display.

To turn off the computer's display:

1. In the Windows search bar, type **Intel Graphics Command Center** and press **<Enter>**.
2. Accept the **Intel Graphics Command Center** software licence agreement.
3. On the **Intel Graphics Command Center** window, click **Display**. The list of active displays is listed under the **Connected Displays** section.
4. Click the ellipsis (...) in the top-right corner of your primary display, then click **Extend > Display 2**.
5. Click the ellipsis (...) in the top-right corner of display 2, then click **Make Display Primary**.
6. Click the ellipsis (...) in the top-right corner of your computer's display, then click **Disable**.

Connect external displays

You can connect up to three external displays to the USB-C ports or up to four external displays using a docking station on your computer.

The following table summarizes the number of supported external displays:

Table 1. Display support (up to 4K/60 Hz)

Graphics card	Supported external displays with computer internal display on	Supported external displays with computer internal display off
Intel UHD Graphics	3	4
Intel Iris Xe Graphics	3	4
NVIDIA GeForce RTX 3050 Laptop GPU (Video signal through integrated GPU)	3	4
NVIDIA GeForce RTX 3050 Ti Laptop GPU (Video signal through integrated GPU)	3	4

Table 2. Display support (up to 8K/60 Hz)

Graphics card	Supported external displays with computer internal display on	Supported external displays with computer internal display off
Intel UHD Graphics	1	1
Intel Iris Xe Graphics	1	1
NVIDIA GeForce RTX 3050 Laptop GPU (Video signal through integrated GPU)	1	1
NVIDIA GeForce RTX 3050 Ti Laptop GPU (Video signal through integrated GPU)	1	1

Integrated graphics

Connecting external displays to XPS 15 9520

NOTE: When connecting a display using an adapter or docking station, it is recommended that you connect the display to the docking station first and then connect the docking station to the USB-C port on your computer.

With the computer display turned on

You can connect up to three external displays directly to USB-C ports.

- Connect an external display directly to your computer by using a USB-C or Thunderbolt cable:

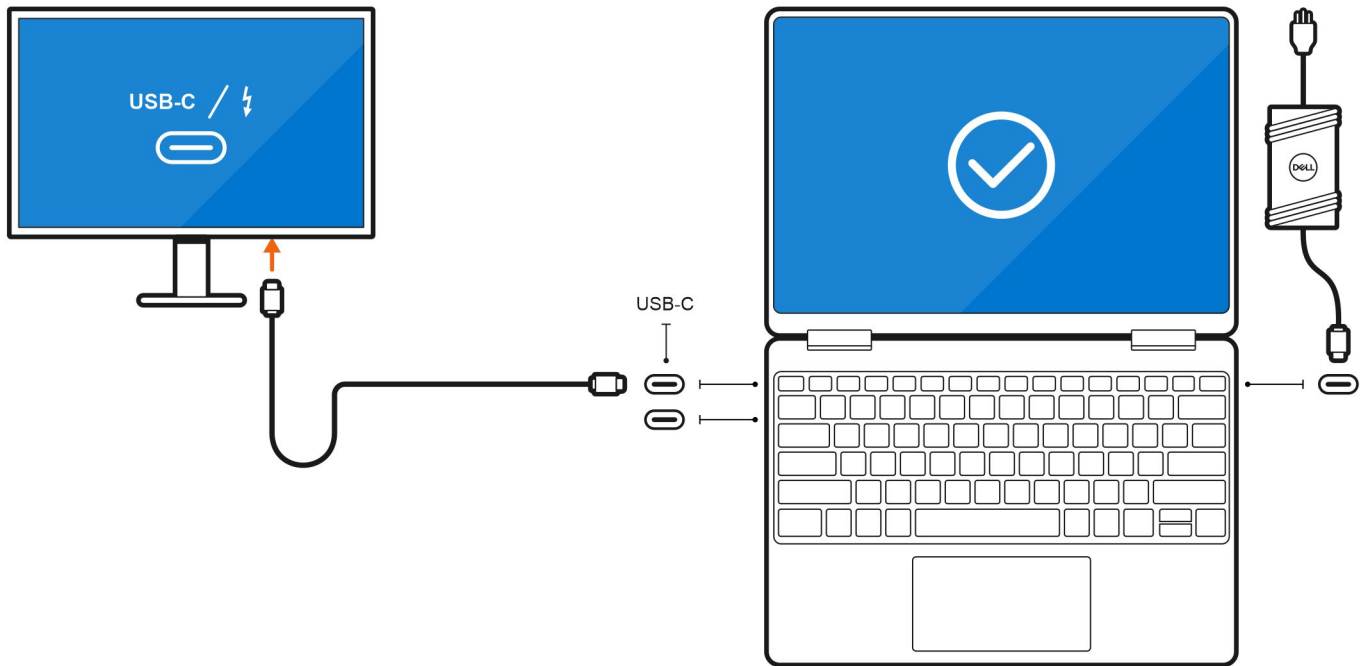

- Connect an external display using a USB-C to Thunderbolt/HDMI/DisplayPort adapter:

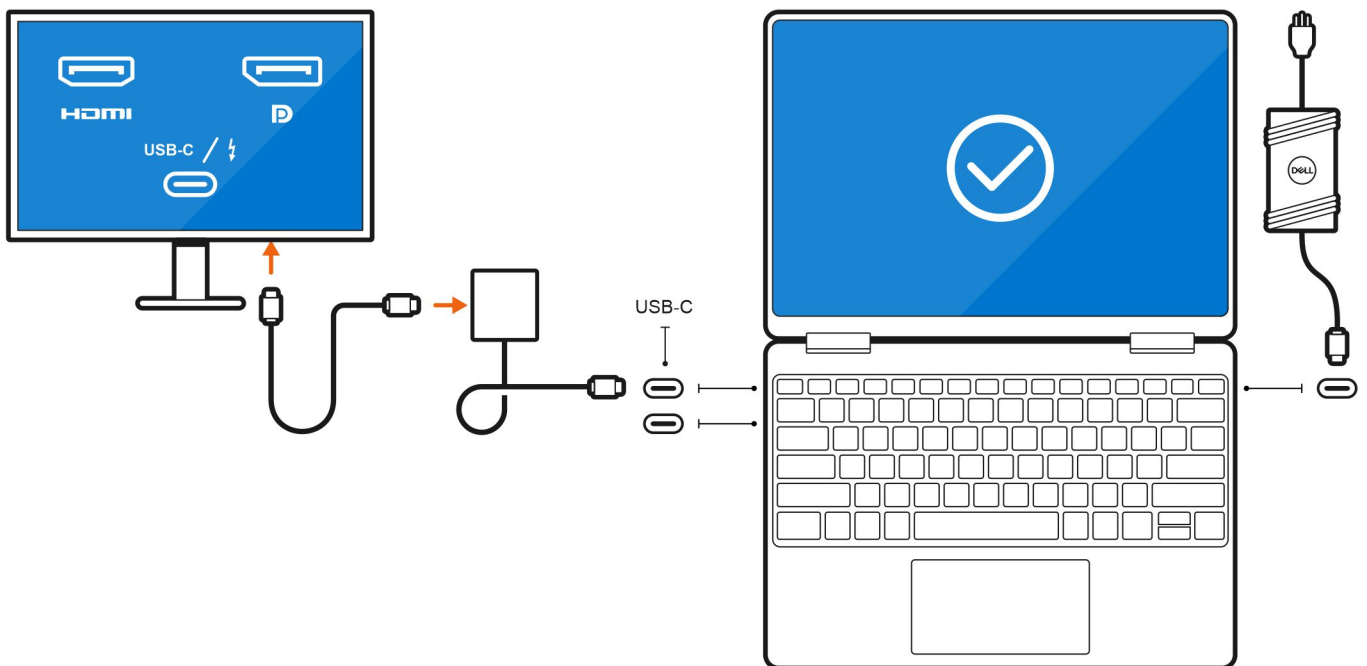

- Connect up to three external displays using a USB-C docking station or USB-C to Thunderbolt/HDMI/DisplayPort adapter:

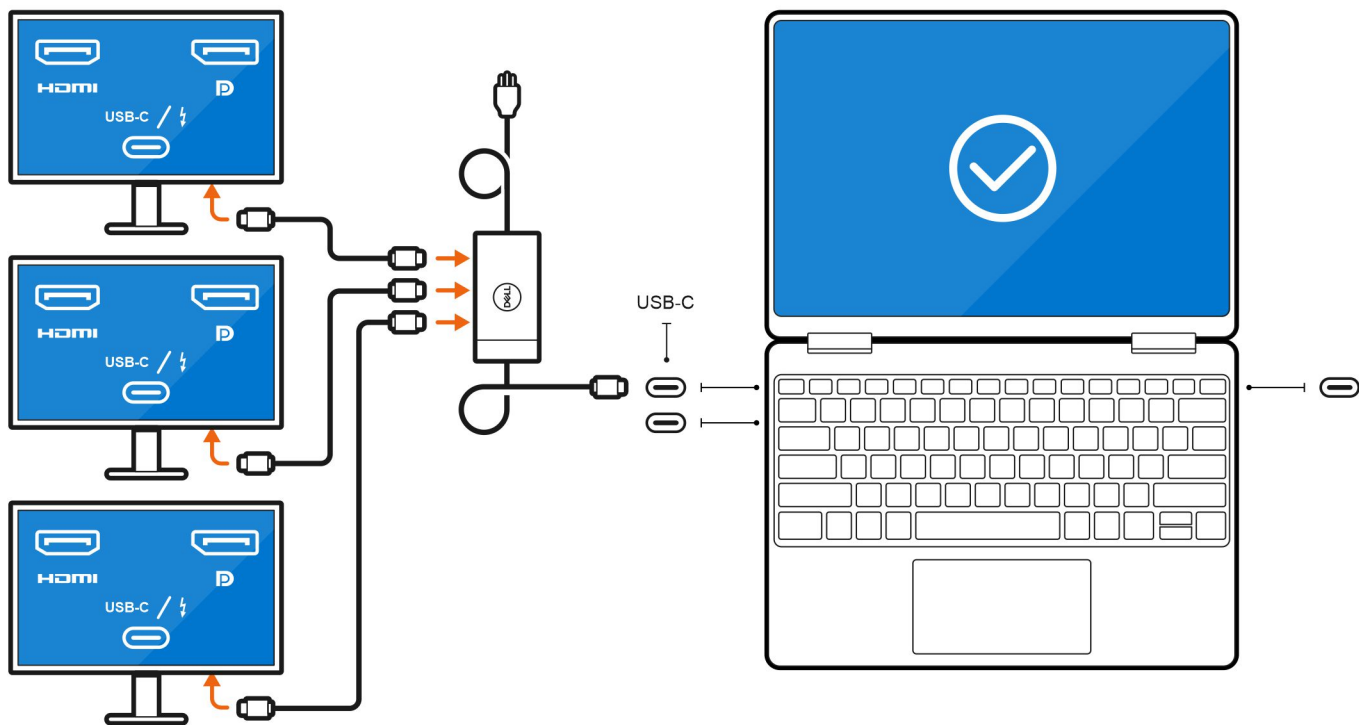

With the computer display turned off

- NOTE:** Ensure that you turn off your computer's display before connecting the external displays. For more information, see [Turn off the computer display](#).
- NOTE:** Connect and configure at least one external display before disabling the computer internal display.
- NOTE:** The resolution, refresh rate, and maximum number of external monitors supported by the dock are dependent on the compatibility between computer and dock.

You can connect up to three external displays directly to the Type-C ports on your computer or you can connect the displays to the computer using the docking station.

- Connect three external displays directly to the two Type-C ports and the docking station:

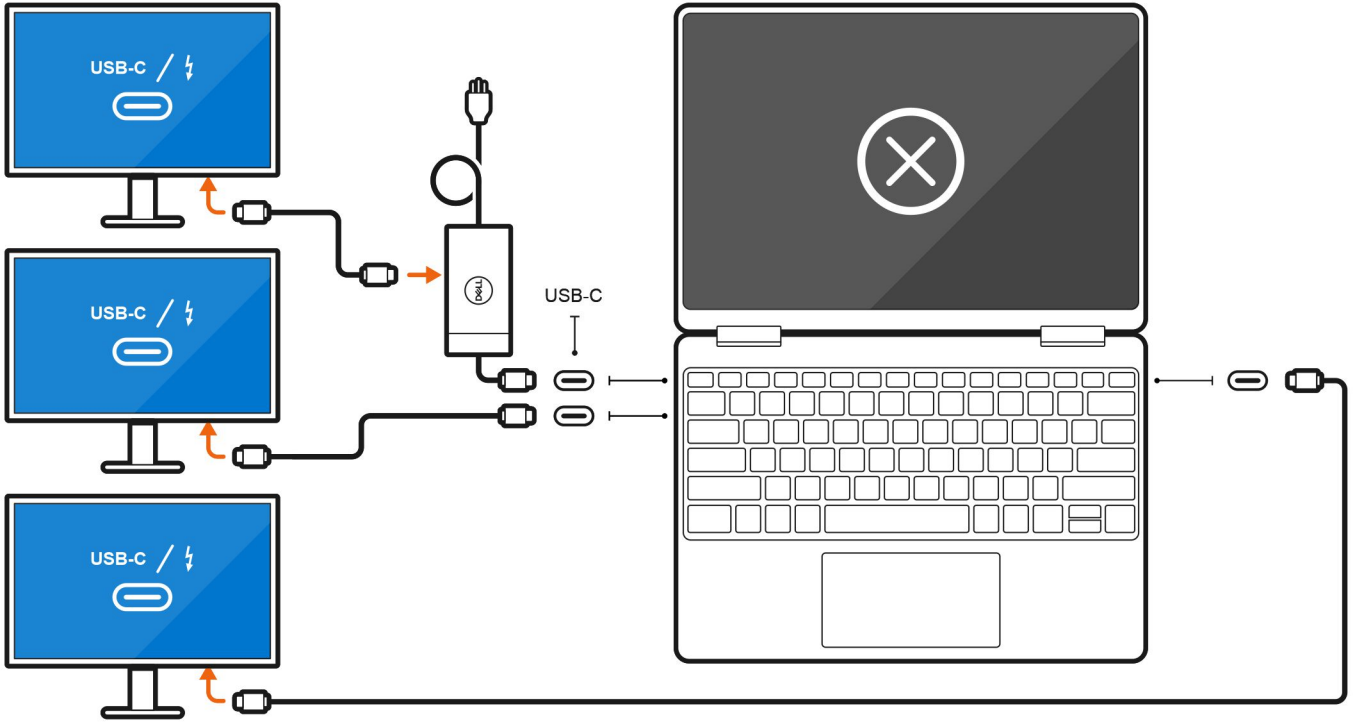

- Connect up to four external displays directly to the WD19TB series docking station and then connecting the docking station to the computer:

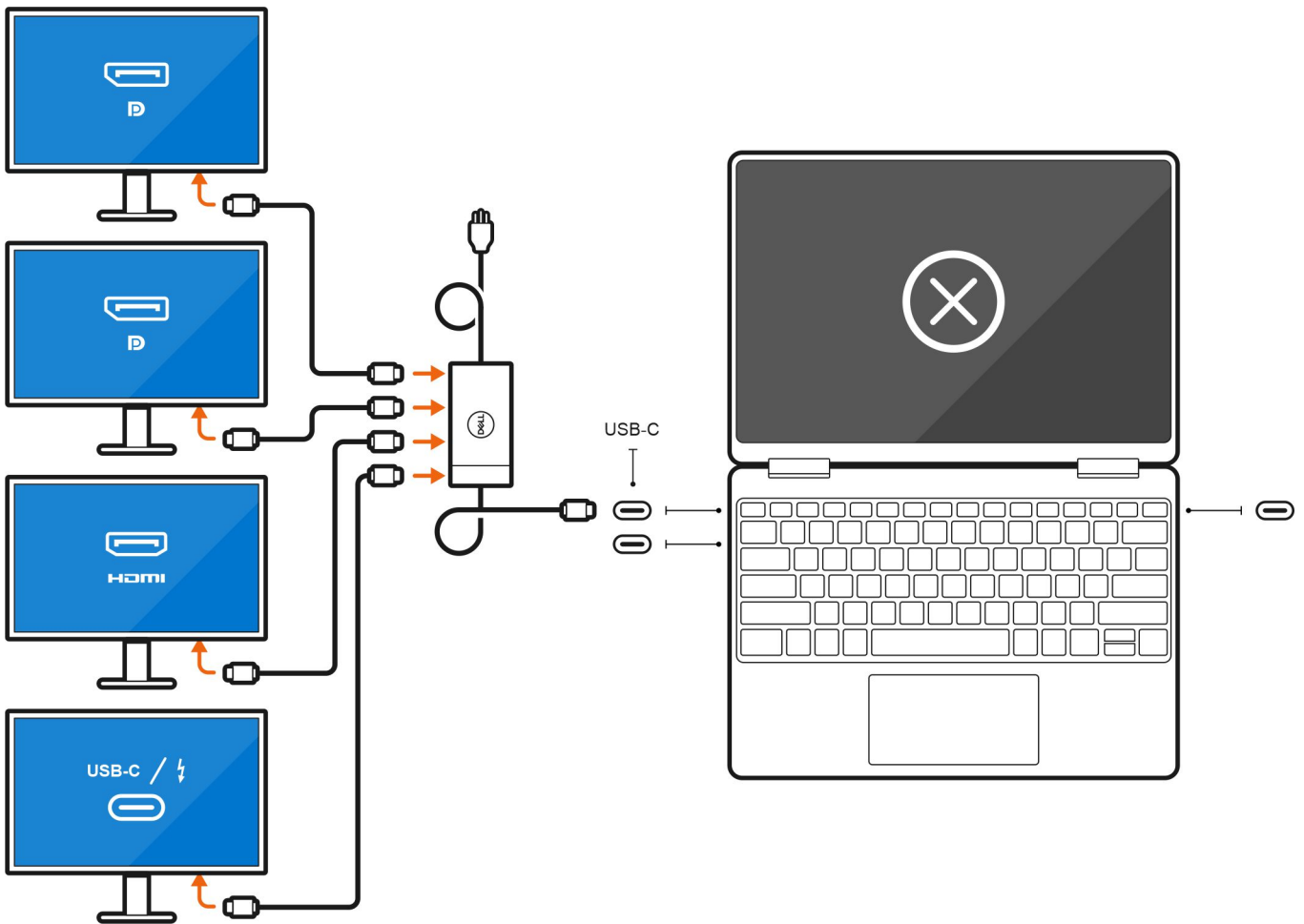

Troubleshooting

8K displays flickering

Question

When I connect two 8K displays to both Thunderbolt ports on the left side or the right side of the computer, they flicker when they run at a display rate of 60 Hz.

Cause

This may be because of interlacing or switching as the Thunderbolt controller has send only part of the data, where the other one has to send the second part of the data synchronization may be a problem.

Workaround

Connect each 8K display to a Thunderbolt port on either side of the computer, for example, one 8K display to either Ports on the left side, and the other to either Ports on the right side. After doing so, power the displays off and on again.

8K displays not displaying correctly

Question

When I connect the 8K display to the computer using a Thunderbolt docking station, it disrupts the display of my computer.

Cause

This may be because of a hardware limitation with the Thunderbolt docking station.

Workaround

Connect the 8K display directly to a Thunderbolt port on your computer. Power on the display and than turn off the power on the display.

No display or Blank screen after display Multi-Stream Transport (MST) option is turned off via WD19/WD19TB/WD19DC series docking stations

Question

When the display Multi-Stream Transport (MST) is turned OFF via WD19/WD19TB/WD19DC series docking stations, the display does not power on or has a blank screen.

Cause

Multi-Stream Transport (MST) hub do not have any specific definition for handling or deal with this kind of DisplayPort Configuration Data (DPCD) change (eg: MST/SST, DP1.4/1.2, HDR, FreeSync).

Workaround



- Hot-Plug Dock cable.
- Hot-Plug Display cable.

Getting help and contacting Dell

Self-help resources

You can get information and help on Dell products and services using these self-help resources:

Table 3. Self-help resources

Self-help resources	Resource location
Information about Dell products and services	www.dell.com
My Dell app	
Tips	
Contact Support	In Windows search, type <code>Contact Support</code> , and press Enter.
Online help for operating system	www.dell.com/support/windows
Access top solutions, diagnostics, drivers and downloads, and learn more about your computer through videos, manuals and documents.	Your Dell computer is uniquely identified by a Service Tag or Express Service Code. To view relevant support resources for your Dell computer, enter the Service Tag or Express Service Code at www.dell.com/support . For more information on how to find the Service Tag for your computer, see Locate the Service Tag on your computer .
Dell knowledge base articles for a variety of computer concerns	<ol style="list-style-type: none"> 1. Go to www.dell.com/support. 2. On the menu bar at the top of the Support page, select Support > Knowledge Base. 3. In the Search field on the Knowledge Base page, type the keyword, topic, or model number, and then click or tap the search icon to view the related articles.

Contacting Dell

To contact Dell for sales, technical support, or customer service issues, see www.dell.com/contactdell.

 **NOTE:** Availability varies by country/region and product, and some services may not be available in your country/region.

 **NOTE:** If you do not have an active Internet connection, you can find contact information about your purchase invoice, packing slip, bill, or Dell product catalog.