

# ThinkPad P1 Gen 6

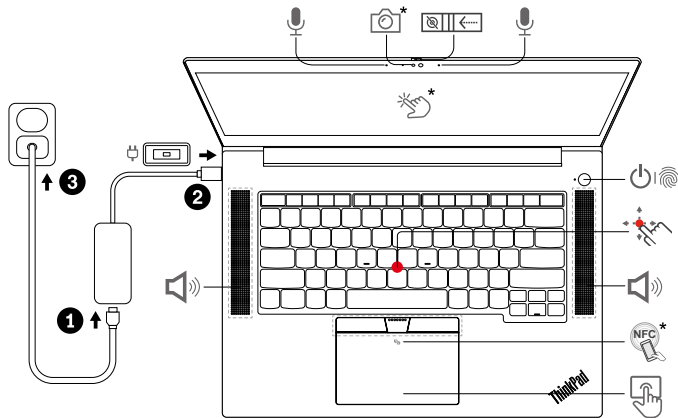

## Get started

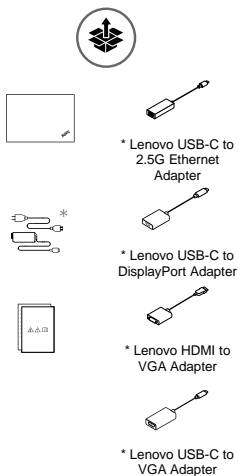

\* For selected models

## Overview

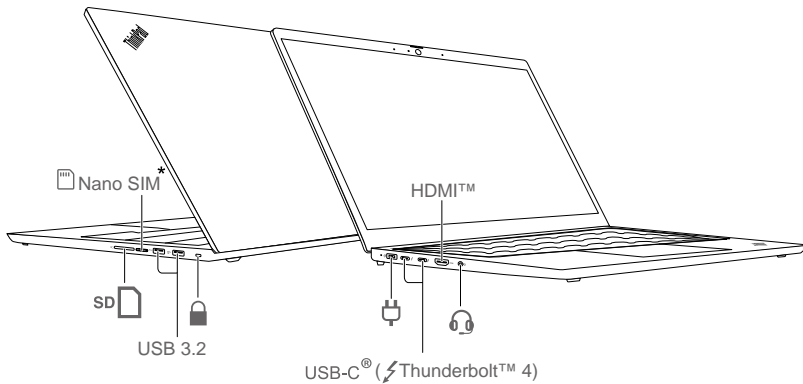

Read the statement on USB transfer rate in the *User Guide*. To access the *User Guide*, go to <https://pcsupport.lenovo.com>.

## Lenovo Commercial Vantage\*

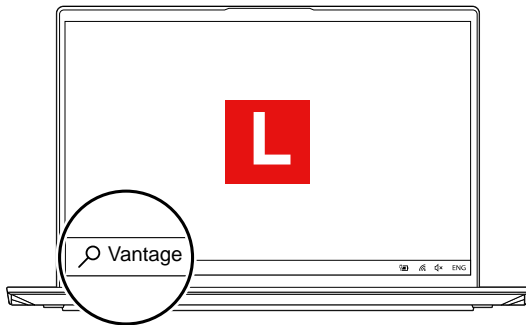

Access Commercial Vantage to adjust device settings and check for system updates.

## Lock on leave<sup>1</sup>



Protect your privacy and improve battery life.

<sup>1</sup>The initial BIOS disabled this function. It will be enabled by software update soon. Refer to README file for BIOS on system support site.

# Lenovo View\*



Video Enhancer

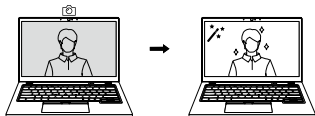

Background Removal

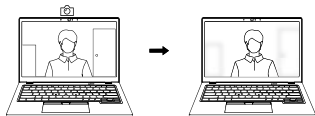

Privacy Guard

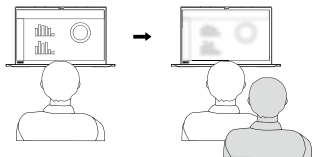

Posture Warning

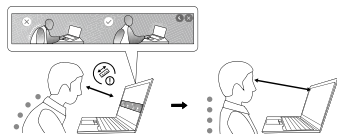

## [English]

### Specific absorption rate (SAR)

YOUR DEVICE MEETS INTERNATIONAL GUIDELINES FOR EXPOSURE TO RADIO WAVES.

Refer to the following for 10g SAR limit and maximum reported SAR values:

10g SAR limit: 2 W/kg (body-worn SAR); 4 W/kg (limb SAR)

Maximum SAR with 0 mm separation distance: 0.750 W/kg (body-worn SAR); 3.163 W/kg (limb SAR)

For more information about SAR, refer to the *Safety and Warranty Guide* that came with your device.

### European Union (EU) / United Kingdom (UK) — radio frequency and power

This radio equipment operates with the following frequency bands and maximum radio-frequency power:

Technology	Frequency [MHz] / band	Maximum transmit power
WLAN 802.11b/g/n/ax	2400 - 2483.5	< 20 dBm
WLAN 802.11a/n/ac/ax	5150 - 5725	< 23 dBm
WLAN 802.11a/n/ac/ax	5725 - 5875	< 13.98 dBm
WLAN 802.11ax	5945 - 6425	< 23 dBm
Bluetooth BR/EDR/LE	2400 - 2483.5	< 20 dBm
WWAN UMTS	1/8	< 24.5 dBm
WWAN LTE	1/3/7/8/20/28/34/38/40/41/42/43	< 25 dBm
WWAN LTE HPUE	41	< 26 dBm
NFC	13.56	< -5.31 dB $\mu$ A/m@10m

Note: Not all wireless bands may be enabled depending on your product configuration.

Usage of this device is limited to indoor locations in the bands 5150 - 5350 MHz and 5945 - 6425 MHz.

For Datecode Position Only

Printed in China

# Lenovo

Second Edition (September 2023)

© Copyright Lenovo 2023.

**LIMITED AND RESTRICTED RIGHTS NOTICE:** If data or software is delivered pursuant to a General Services Administration "GSA" contract, use, reproduction, or disclosure is subject to restrictions set forth in Contract No. GS-35F-05925.

Lenovo, Lenovo logo, ThinkPad, and ThinkPad logo are trademarks of Lenovo. Intel and Thunderbolt are trademarks of Intel Corporation or its subsidiaries in the U.S. and/or other countries. The terms HDMI and HDMI High-Definition Multimedia Interface are trademarks or registered trademarks of HDMI Licensing LLC in the United States and other countries. USB-C is a registered trademark of USB Implementers Forum. All other trademarks are the property of their respective owners.



For FSC Mix logo only