

Multifunction MiMo Antenna

L[G]AM-7-27[X]24-58

L[G]AM-7-27-[X]24-58



Low Profile Design

MiMo 5G/4G/3G/2G + Single or 2x2 MiMo 2.4/5GHz

Optional GPS/GNSS

The L[G]PAM has a compact housing that contains 2x2 MiMo antenna function for 5G/4G/3G/2G and either single or 2x2 MiMo antenna function for 2.4/5GHz.

The LGAM version also includes an active antenna for GPS/GLONASS/Galileo/BeiDou with 26dB gain LNA.

This antenna range is ideal for vending machines, payment terminals and other M2M or IoT applications.

Technical Drawing

Part No. LGAM-7-27-24-58 shown

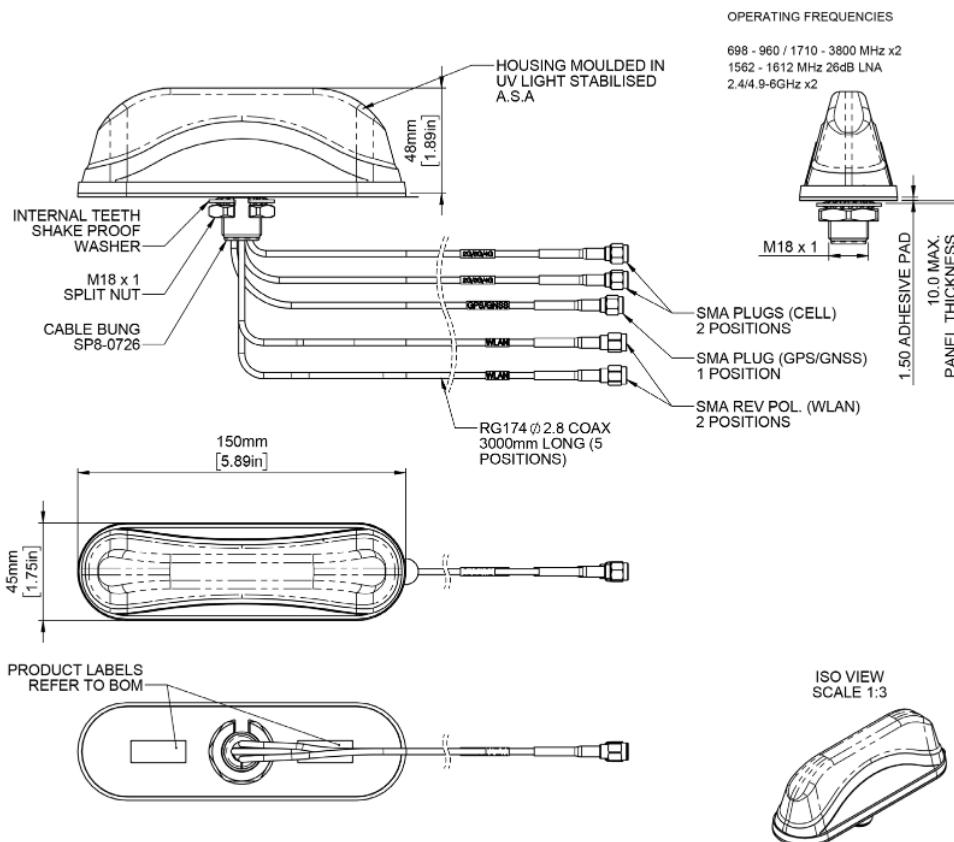

Multifunction MiMo Antenna

L[G]AM-7-27[X]24-58

* without cable loss

Product Data

Part No.		LPAM-7-27-24-58	LPAM-7-27-S24-58	LGAM-7-27-24-58	LGAM-7-27-S24-58
Electrical Data					
Frequency Range (MHz)	Elements 1 (G Version)	1562-1612			
	Element 2 & 3	698-960, 1710-2170, 2500-3800			
	Elements 4 & 5	2300-2500 & 4900-6000			
Operational Bands	Element 1 (G Version)	-	-	GPS/GNSS/Galileo/BeiDou	
	Elements 2 & 3	5G/4G/3G/2G			
	Elements 4 & 5	2x cell			
		2.4/5.0 GHz WiFi			
Peak Gain: Isotropic*		2x WiFi	1x WiFi	2x WiFi	1x WiFi
	Elements 2 & 3	2dBi (698-960MHz) / 5dBi (1710-3800MHz)			
	Element 4 & 5	4dBi (2.4GHz) / 6dBi (5.0GHz)			
Isolation <small>(with 5m (16') of RG174 cable)</small>	Cellular	>12dB			
	WiFi	>20dB			
Typical Efficiency*	Elements 2 & 3	>50%			
Correlation Co-efficient	Elements 2 & 3	<0.2			
Polarisation		Vertical			
Pattern		Omni-directional			
Impedance		50Ω			
Max input power (W)		Internal elements 25W			
GPS/GNSS Data					
Frequency Range (MHz)		1562-1612MHz			
VSWR		<2:1 ± 4MHz			
Gain: LNA		26dB			
Polarisation		Right Hand Circular			
Operating Voltage		3-5 DC (fed via coax)			
Current		Typical <20 mA			
Mechanical Data					
Dimensions (mm)	Total Height	50 (2.2")			
	Length	150 (5.9")			
	Width	44 (1.47")			
Operating Temp (°C)		-40° / +80°C (-40° / 176°F)			
Material		ASA			
Colour		Black			
Ingress Protection		IP66			
Mounting Data					
Fixing		Panel Mount			
Hole Size (mm)		19 (3/4")			
Cable Data					
Cable Type - All Feeds		RG174			
Dimensions (mm)	Diameter	2.8 (0.11")			
	Length	3000 (10')			
Termination	GPS/GNSS	-	-	SMA Plug	SMA Plug
	2x Cell	2x SMA Plug			
	WiFi	2x SMA Rev Pol Plug	1x SMA Rev Pol Plug	2x SMA Rev Pol Plug	1x SMA Rev Pol Plug

Multifunction MiMo Antenna

L[G]AM-7-27[X]24-58

Electrical Data

VSWR

Typical VSWR - 4G/3G/2G Elements 2&3*

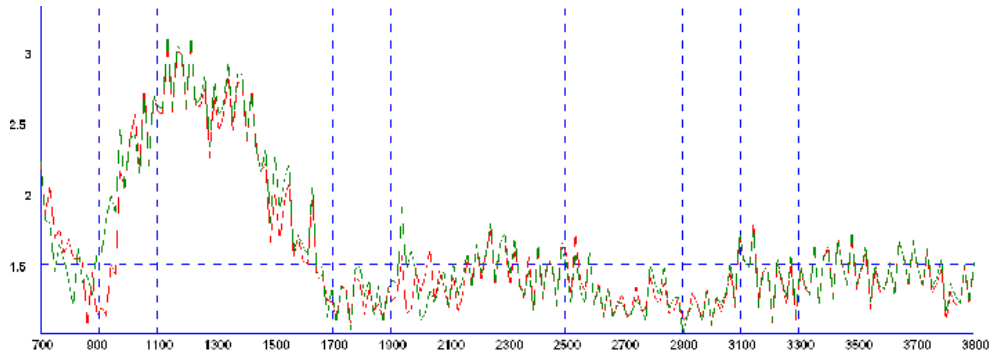

*VSWR measured with 3m (10') of RG174 cable a) Red: in free space b) Green: on a 400x400mm (1'4") ground plane

Typical VSWR - WiFi Elements 4&5

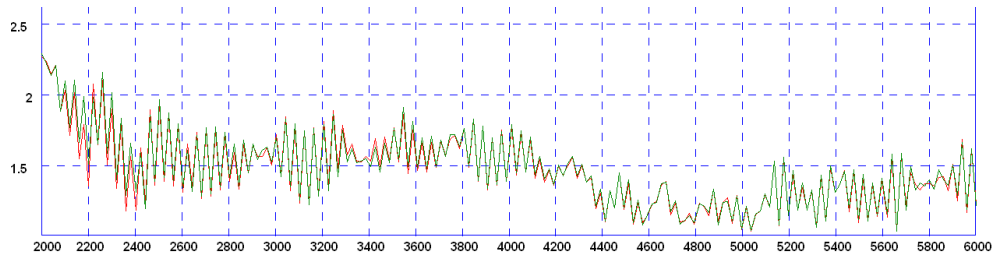

*VSWR measured with 3m (10') of RG174 cable a) Red: in free space b) Green: on a 400x400mm (1'4") ground plane

Isolation

Typical Isolation - Cellular Elements 2&3*



*Isolation measured with 3m (10') of RG174 cable a) Red: in free space b) Green: on a 400x400mm (1'4") ground plane

Typical Isolation - WiFi Elements 4&5

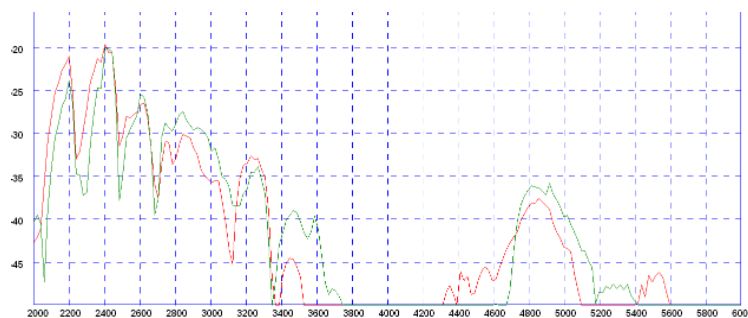

*Isolation measured with 3m (10') of RG174 cable a) Red: in free space b) Green: on a 400x400mm (1'4") ground plane

Typical 3D Radiation Patterns - Cell / LTE Elements 2&3

3D Gain Plot Top (700MHz)

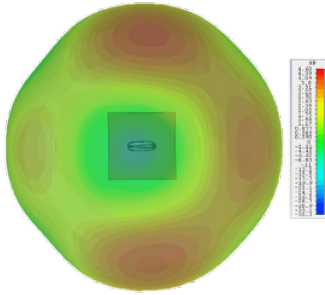

3D Gain Plot Top (800MHz)

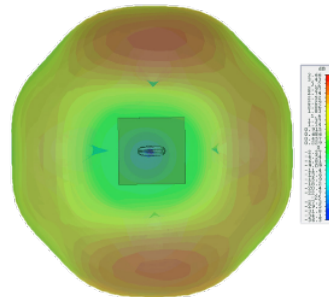

3D Gain Plot Top (900MHz)

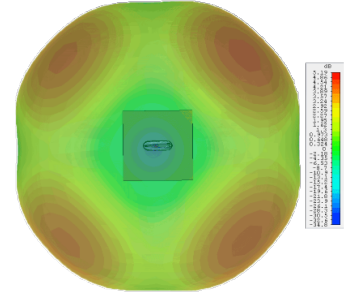

3D Gain Plot Top (1800MHz)

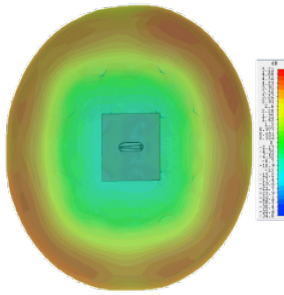

3D Gain Plot Top (2100MHz)

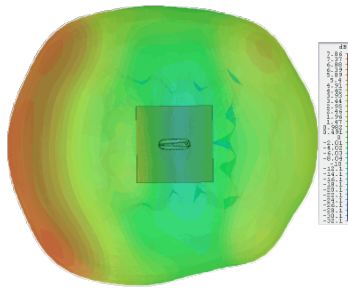

3D Gain Plot Top (2600MHz)

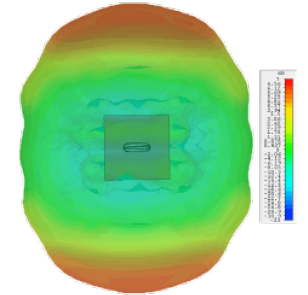

3D Gain Plot Top (3600MHz)

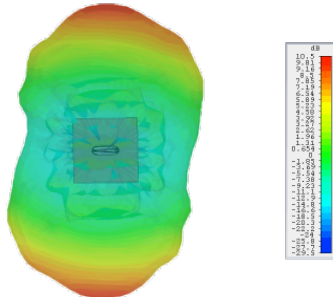

Typical 3D Radiation Patterns - Wifi Elements 4&5

3D Gain Plot Top (2.4GHz)

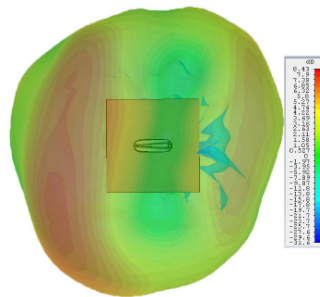

3D Gain Plot Top (5.4GHz)

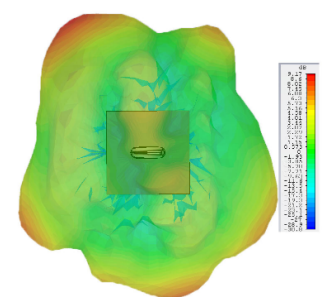

*3D radiation patterns simulated in CST Microwave Studio on a 600x600mm (2' X2') ground plane with both elements fed together.

Typical Radiation Patterns - GPS/GNSS Element 1

Element 3: Typical E Plane Pattern

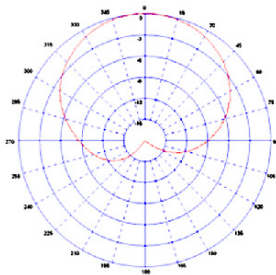

Typical 3D Radiation Patterns - Wifi Elements (Single Wifi)

3D Gain Plot Top (2.4GHz)

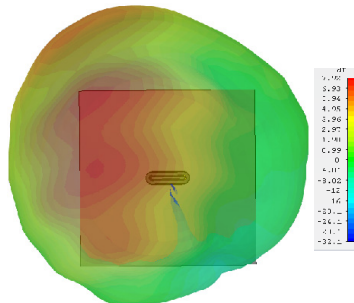

3D Gain Plot Top (5.4GHz)

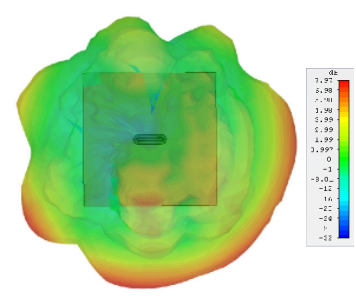

*3D radiation patterns simulated in CST Microwave Studio on a 600x600mm (2' X2') ground plane with a single element feed.