

SP72

Single Plane Scanner



ZEBRA

Product Reference Guide

2023/09/29

ZEBRA and the stylized Zebra head are trademarks of Zebra Technologies Corporation, registered in many jurisdictions worldwide. All other trademarks are the property of their respective owners. ©2023 Zebra Technologies Corporation and/or its affiliates. All rights reserved.

Information in this document is subject to change without notice. The software described in this document is furnished under a license agreement or nondisclosure agreement. The software may be used or copied only in accordance with the terms of those agreements.

For further information regarding legal and proprietary statements, please go to:

SOFTWARE: zebra.com/linkoslegal.

COPYRIGHTS: zebra.com/copyright.

PATENTS: ip.zebra.com.

WARRANTY: zebra.com/warranty.

END USER LICENSE AGREEMENT: zebra.com/eula.

Terms of Use

Proprietary Statement

This manual contains proprietary information of Zebra Technologies Corporation and its subsidiaries (“Zebra Technologies”). It is intended solely for the information and use of parties operating and maintaining the equipment described herein. Such proprietary information may not be used, reproduced, or disclosed to any other parties for any other purpose without the express, written permission of Zebra Technologies.

Product Improvements

Continuous improvement of products is a policy of Zebra Technologies. All specifications and designs are subject to change without notice.

Liability Disclaimer

Zebra Technologies takes steps to ensure that its published Engineering specifications and manuals are correct; however, errors do occur. Zebra Technologies reserves the right to correct any such errors and disclaims liability resulting therefrom.

Limitation of Liability

In no event shall Zebra Technologies or anyone else involved in the creation, production, or delivery of the accompanying product (including hardware and software) be liable for any damages whatsoever (including, without limitation, consequential damages including loss of business profits, business interruption, or loss of business information) arising out of the use of, the results of use of, or inability to use such product, even if Zebra Technologies has been advised of the possibility of such damages. Some jurisdictions do not allow the exclusion or limitation of incidental or consequential damages, so the above limitation or exclusion may not apply to you.

Contents

About This Guide.....	19
Configurations.....	19
Accessories.....	21
Notational Conventions.....	22
Icon Conventions.....	23
Service Information.....	23
Getting Started.....	24
Unpacking the Scanner.....	24
Ports.....	25
Features.....	25
Power Options.....	28
Host Interfaces.....	28
Removing the Back Cover.....	29
Installing Cables.....	29
Connecting Cables to the SP7201.....	29
Connecting Cables to the SP7208.....	30
Connecting an External Speaker.....	31
Replacing the Back Cover.....	31
Mounting Accessories.....	32
Mounting the SP72-V Using the Table Mount.....	33
Mounting the SP72-V Using the Riser Mount.....	35
Removing the SP72-V from the Mount.....	38
Mounting the SP72-H Using the Bucket Mount.....	39
Configuring the Scanner.....	42

Operating the Scanner.....	42
Indicator Lights.....	42
Adjusting Speaker Tone.....	42
Adjusting Speaker Volume.....	42
123Scan and Software Tools.....	43
123Scan.....	43
Communication with 123Scan.....	44
123Scan Requirements.....	44
123Scan Information.....	44
Scanner SDK, Other Software Tools, and Videos.....	45
Advanced Data Formatting.....	45
Multicode Data Formatting.....	46
Multicode Data Formatting Use.....	46
MDF for Best Practices.....	47
Preferred Symbol.....	48
Data Parsing (UDI Scan+, Label Parse+ and Blood Bag Parse+).....	49
Scan a UDI Label using UDI Scan+.....	49
Scan a GS1 Label using Label Parse+.....	50
Scan a Blood Bag Label using Blood Bag Parse+.....	50
Data Capture.....	51
Scanning.....	51
Active Scan Area.....	51
Decode Ranges.....	52
Beeper and LED Indicators.....	53
Electronic Article Surveillance (EAS).....	55
Checkpoint EAS.....	56
Sensormatic EAS.....	56
Maintenance, Troubleshooting, and Specifications.....	57
Maintenance.....	57
Known Harmful Ingredients.....	57

Approved Cleaners.....	58
Cleaning the Scanner.....	58
Troubleshooting.....	58
Dump Scanner Parameters.....	61
Technical Specifications.....	61
Scanner to Host Connectors.....	61
Auxiliary USB Type A Connector.....	62
EAS Connectors.....	62
USB Interface.....	63
USB Interface Connection.....	63
USB Parameter Defaults.....	65
USB Device Type.....	67
Symbol Native API (SNAPI) Status Handshaking.....	69
USB Keystroke Delay.....	70
USB Caps Lock Override.....	71
USB Barcodes with Unknown Characters.....	72
USB Convert Unknown to Code 39.....	73
USB Fast HID.....	74
USB Polling Interval.....	75
Keypad Emulation.....	77
USB Quick Keypad Emulation.....	78
Keypad Emulation with Leading Zero.....	79
USB Keyboard FN1 Substitution.....	80
USB Function Key Mapping.....	81
USB Simulated Caps Lock.....	82
USB Convert Case.....	83
USB Static CDC.....	84
CDC Beep on <BEL>.....	85
USB CDC Host Variant.....	86
TGCS (IBM) USB Direct I/O Beep.....	87
USB IBM Long Direct IO.....	88
TGCS (IBM) USB Beep Directive.....	89
TGCS (IBM) USB Barcode Configuration Directive.....	90

TGCS (IBM) USB Specification Version.....	91
Product ID (PID) Type.....	92
Product ID (PID) Value.....	93
ECLevel.....	94
4690 Flash Update.....	95
USB ASCII Character Sets.....	96
RS-232 Interface.....	97
RS-232 Interface Connection.....	97
RS-232 Parameter Defaults.....	99
RS-232 Host-Specific Parameter Settings.....	100
RS-232 Host-Specific Code ID Characters.....	101
RS-232 Host Types.....	104
RS-232 Baud Rate.....	106
RS-232 Parity.....	108
RS-232 Stop Bits.....	109
Data Bits.....	110
Check Receive Errors.....	111
Hardware Handshaking.....	112
Software Handshaking.....	114
RS-232 Host Serial Response Timeout.....	116
RTS Line State.....	117
Beep on <BEL>.....	118
Intercharacter Delay.....	119
Nixdorf Beep/LED Options.....	120
RS-232 Barcodes with Unknown Characters.....	121
Datalogic Host Format.....	122
Datalogic Supported Commands.....	123
NCR Host Preferences.....	124
RS-232 ASCII Character Sets.....	130
IBM 468X/469X Interface.....	131

IBM 468X/469X Interface Connection.....	131
IBM Parameter Defaults.....	133
IBM Host Parameters.....	134
Port Address.....	134
Convert Unknown to Code 39.....	135
RS-485 Beep Directive.....	136
RS-485 Barcode Configuration Directive.....	137
IBM-485 Specification Version.....	138
Keyboard Wedge Interface.....	139
Keyboard Wedge Interface Connection.....	139
Keyboard Wedge Parameter Defaults.....	141
Keyboard Wedge Host Parameters.....	142
Keyboard Wedge Host Types.....	142
Barcodes with Unknown Characters.....	143
Keystroke Delay.....	144
Intra-keystroke Delay.....	145
Alternate Numeric Keypad Emulation.....	146
Quick Keypad Emulation (Keyboard Wedge).....	147
Simulated Caps Lock (Keyboard Wedge).....	148
Caps Lock Override.....	149
Convert Case (Keyboard Wedge).....	150
Function Key Mapping (Keyboard Wedge).....	151
FN1 Substitution.....	152
Send Make and Break.....	153
Keyboard Map.....	154
ASCII Character Sets.....	155
SSI Interface.....	156
Communication.....	156
SSI Commands.....	157
SSI Transactions.....	158
General Data Transactions.....	158

Decoded Data Transmission.....	158
Communication Summary.....	160
RTS/CTS Lines.....	160
ACK/NAK Option.....	160
Number of Data Bits.....	160
Serial Response Timeout.....	160
Retries.....	160
Baud Rate, Stop Bits, Parity, Response Timeout, ACK/NAK Handshaking.....	161
Errors.....	161
SSI Communication Notes.....	161
Encapsulation of RSM Commands/Responses over SSI.....	162
Command Structure.....	162
Response Structure.....	162
Example Transaction.....	162
Setting SSI Parameters.....	164
SSI Scanning Sequence Examples.....	164
SSI Errors While Scanning.....	164
Simple Serial Interface Parameter Defaults.....	165
SSI Host Parameters.....	166
Select SSI Host.....	166
SSI Baud Rate.....	167
SSI Parity.....	169
Check Parity.....	170
SSI Stop Bits.....	171
Software Handshaking.....	172
Host RTS Line State.....	173
Datalogic Supported Commands.....	174
Decode Data Packet Format.....	175
Host Serial Response Timeout (SSI).....	176
Host Character Timeout.....	177
Multipacket Option.....	178
Interpacket Delay.....	179
Event Reporting.....	180
Decode Event.....	180

Boot Up Event.....	181
Parameter Event.....	182
User Preferences and Miscellaneous Options.....	183
Setting User Preference Parameters.....	183
User Preference Scanning Sequence Examples.....	183
User Preference Errors While Scanning.....	183
User Preferences/Miscellaneous Options Parameter Defaults.....	184
User Preferences.....	186
Default Parameters.....	186
Parameter Barcode Scanning.....	187
Beep After Good Decode.....	188
LED on Good Decode.....	189
Beeper Volume.....	190
Scan Tone.....	191
Beeper Duration.....	193
Tone/Volume Button.....	194
Speaker Control.....	195
Suppress Power Up Beeps.....	196
Hands-Free Decode Session Timeout.....	196
Timeout Between Decodes, Same Symbol.....	198
Timeout Between Decodes, Different Symbols.....	199
Extend Timeout Between Decodes, 2D Same Symbol.....	200
Decode Range Limit (Hands-free).....	201
Mobile Phone / Display Mode (Enhanced).....	202
Motion Detect Mode (Wakeup).....	203
Rescan Beep.....	204
PDF Prioritization.....	205
PDF Prioritization Timeout.....	206
Presentation Mode Field of View.....	207
securPharm Decoding.....	208
securPharm Output Formatting.....	209
Non-Decode Event.....	213
Non-Decode Event Threshold.....	214

Miscellaneous Scanner Parameters.....	215
Enter Key.....	215
Tab Key.....	216
Transmit Code ID Character.....	217
Prefix Suffix Values.....	218
Scan Data Transmission Format.....	219
FN1 Substitution Values.....	221
Unsolicited Heartbeat Interval.....	222
Driver’s License Set Up.....	223
Driver’s License Parsing.....	223
Parsing Driver’s License Data Fields (Embedded Driver's License Parsing).....	224
Embedded Driver's License Parsing Criteria - Code Type.....	224
Driver’s License Parse Rules.....	224
Driver’s License Parse Fields.....	225
AAMVA Parse Fields.....	226
Parser Version ID Barcode.....	235
DL Parsing User Preferences.....	235
Set Default Parameter.....	235
Output Gender as M or F.....	236
Date Format.....	236
Send Keystroke (Control Characters and Keyboard Characters).....	237
Parsing Rule Example.....	253
Embedded Driver's License Parsing ADF Example.....	256
Custom Tone Introduction.....	259
Downloading a Custom Tone via 123 Scan.....	259
Downloading a Custom Tone via Scanner SDK Sample Application.....	264
Image Capture Preferences.....	267
Setting Image Capture Parameters.....	267
Image Capture Scanning Sequence Examples.....	267
Image Capture Errors While Scanning.....	267

Image Capture Preferences Parameter Defaults.....	268
Image Capture Preferences Modes and Parameters.....	269
Snapshot Mode.....	269
Image Capture Illumination.....	270
Image Capture Autoexposure.....	270
Fixed Exposure.....	272
Digital Gain.....	273
Snapshot Mode Timeout.....	274
Silence Operational Mode Changes.....	275
Image Cropping.....	276
Crop to Pixel Addresses.....	277
Image Size (Number of Pixels).....	278
Image Brightness (Target White).....	279
JPEG Image Options.....	280
JPEG Quality Value.....	281
JPEG Size Value.....	282
Image Enhancement.....	283
Image File Format Selector.....	284
Image Rotation.....	285
Bits Per Pixel.....	286
Camera Button.....	287
Camera Button Delay.....	288
Color Camera Mode.....	289
Symbologies.....	290
Symbology Parameter Defaults.....	291
Enable/Disable All Code Types.....	297
UPC/EAN/JAN.....	298
UPC-A.....	298
UPC-E.....	299
UPC-E1.....	300
EAN-8/JAN-8.....	301
EAN-13/JAN-13.....	302
Bookland EAN.....	303

Bookland ISBN Format.....	304
ISSN EAN.....	305
Decode UPC/EAN/JAN Supplementals.....	306
User-Programmable Supplementals.....	309
UPC/EAN/JAN Supplemental Redundancy.....	310
UPC/EAN/JAN Supplemental AIM ID Format.....	311
Transmit UPC-A Check Digit.....	312
Transmit UPC-E Check Digit.....	313
Transmit UPC-E1 Check Digit.....	314
UPC-A Preamble.....	315
UPC-E Preamble.....	316
UPC-E1 Preamble.....	317
Convert UPC-E to UPC-A.....	318
Convert UPC-E1 to UPC-A.....	319
EAN/JAN Zero Extend.....	320
UCC Coupon Extended Code.....	321
Coupon Report.....	322
UPC Reduced Quiet Zone.....	323
Digimarc Digital Watermarks.....	324
Linear UPC/EAN.....	325
Code 128.....	326
Set Lengths for Code 128.....	327
GS1-128 (formerly UCC/EAN-128).....	329
ISBT 128.....	330
ISBT Concatenation.....	331
Check ISBT Table.....	332
ISBT Concatenation Redundancy.....	333
Code 128 <FNC4>.....	334
Code 128 Security Level.....	335
Code 128 Reduced Quiet Zone.....	336
Code 39.....	337
Trioptic Code 39.....	338
Convert Code 39 to Code 32.....	339
Code 32 Prefix.....	340

Set Lengths for Code 39.....	341
Code 39 Check Digit Verification.....	343
Transmit Code 39 Check Digit.....	344
Transmit Code 39 Start/Stop Characters.....	345
Code 39 Full ASCII Conversion.....	346
Code 39 Security Level.....	347
Code 39 Reduced Quiet Zone.....	348
Code 93.....	349
Set Lengths for Code 93.....	350
Code 11.....	352
Set Lengths for Code 11.....	353
Code 11 Check Digit Verification.....	355
Transmit Code 11 Check Digits.....	356
Interleaved 2 of 5 (I 2 of 5).....	357
Set Lengths for Interleaved 2 of 5 (I 2 of 5).....	358
Interleaved 2 of 5 (I 2 of 5) Check Digit Verification.....	360
Transmit I 2 of 5 Check Digit.....	361
Convert Interleaved 2 of 5 (I 2 of 5) to EAN-13.....	362
Febraban.....	363
Interleaved 2 of 5 (I 2 of 5) Security Level.....	364
Interleaved 2 of 5 (I 2 of 5) Reduced Quiet Zone.....	365
Discrete 2 of 5 (D 2 of 5).....	366
Set Lengths for Discrete 2 of 5 (D 2 of 5).....	367
Codabar (NW - 7).....	369
Set Lengths for Codabar.....	370
CLSI Editing.....	372
NOTIS Editing.....	373
Codabar Security Level.....	374
Codabar Upper or Lower Case Start/Stop Characters.....	375
Codabar Mod 16 Check Digit Verification.....	376
Transmit Codabar Check Digit.....	377
MSI.....	378
Set Lengths for MSI.....	379
MSI Check Digits.....	381

Transmit MSI Check Digit(s).....	382
MSI Check Digit Algorithm.....	383
MSI Reduced Quiet Zone.....	384
MSI Security Level.....	385
Chinese 2 of 5.....	386
Matrix 2 of 5.....	387
Set Lengths for Matrix 2 of 5.....	388
Matrix 2 of 5 Check Digit.....	390
Transmit Matrix 2 of 5 Check Digit.....	391
Inverse 1D.....	392
GS1 DataBar.....	393
GS1 DataBar Omnidirectional (formerly GS1 DataBar-14).....	393
GS1 DataBar Limited.....	394
GS1 DataBar Expanded.....	395
Convert GS1 DataBar to UPC/EAN/JAN.....	396
GS1 DataBar Security Level.....	397
GS1 DataBar Limited Margin Check.....	398
Symbology-Specific Security Features.....	399
Redundancy Level.....	399
Security Level.....	401
1D Quiet Zone Level.....	402
Intercharacter Gap Size.....	403
Composite.....	404
Composite CC-C.....	404
Composite CC-A/B.....	405
Composite TLC-39.....	406
Composite Inverse.....	407
UPC Composite Mode.....	408
Composite Beep Mode.....	409
GS1-128 Emulation Mode for UCC/EAN Composite Codes.....	410
2D Symbologies.....	411
PDF417.....	411
MicroPDF417.....	412
Code 128 Emulation.....	413

Data Matrix.....	414
GS1 Data Matrix.....	415
Data Matrix Inverse.....	416
Decode Data Matrix Mirror Images.....	417
Enhanced Dotted Datamatrix.....	418
Maxicode.....	419
QR Code.....	420
Weblink QR.....	421
GS1 QR.....	422
MicroQR.....	423
Linked QR Mode.....	424
Aztec.....	425
Aztec Inverse.....	426
Han Xin.....	427
Han Xin Inverse.....	428
Grid Matrix.....	429
Grid Matrix Inverse.....	430
Grid Matrix Mirrored.....	431
DotCode.....	432
DotCode Prioritize.....	433
DotCode Inverse.....	434
DotCode Mirrored.....	435
Macro PDF Features.....	436
Flush Macro PDF Buffer.....	436
Abort Macro PDF Entry.....	437
Postal Codes.....	438
US Postnet.....	438
US Planet.....	439
Transmit US Postal Check Digit.....	440
UK Postal.....	441
Transmit UK Postal Check Digit.....	442
Japan Postal.....	443
Australia Post.....	444
Australia Post Format.....	445

Netherlands KIX Code.....	446
USPS 4CB/One Code/Intelligent Mail.....	447
UPU FICS Postal.....	448
Mailmark.....	449
Posti LAPA 4-State Code.....	449
Electronic Article Surveillance (EAS).....	450
EAS Parameter Defaults.....	450
EAS Parameters.....	451
EAS Operating Modes.....	451
Sensormatic Deactivation Timeout.....	460
Sensormatic EAS Deactivation.....	461
Sensormatic EAS Beeps.....	462
Sensormatic Request Messages.....	466
Checkpoint Interlock Polarity.....	468
Connecting an Auxiliary Scanner.....	469
Programming the Auxiliary Scanner.....	469
Downloading Firmware.....	469
12VDC Power Requirement.....	470
Using Auxiliary Scanners.....	470
Using a Zebra Scanner as an Auxiliary Scanner.....	470
Using a Non-Zebra Scanner as an Auxiliary Scanner.....	470
Numeric Barcodes.....	471
Cancel.....	472
Alphanumeric Barcodes.....	473
Cancel.....	473
Alphanumeric Barcodes 1.....	473
ASCII Character Sets.....	486

Programming Reference.....	496
Symbol Code Identifiers.....	496
AIM Code Identifiers.....	497
Communication Protocol Functionality.....	502
Standard Parameter Defaults.....	504
Country Codes.....	515
USB and Keyboard Wedge Country Keyboard Types (Country Codes).....	515
Country Code Barcodes.....	515
Country Code Pages.....	528
Country Code Page Defaults.....	528
Country Code Page Barcodes.....	531
CJK Decode Control.....	538
CJK Control Parameters.....	538
Unicode Output Control.....	538
CJK Output Method to Windows Host.....	538
Non-CJK UTF Barcode Output.....	540
Unicode/CJK Decode Setup with Windows Host.....	542
Setting Up the Windows Registry Table for Unicode Universal Output.....	542
Adding CJK IME on Windows.....	542
Selecting the Simplified Chinese Input Method on the Host.....	543
Selecting the Traditional Chinese Input Method on the Host.....	543
Non-Parameter Attributes.....	545
Model Number.....	545
Serial Number.....	545
Date of Manufacture.....	545
Date of First Programming.....	546

Configuration Filename.....	546
Beeper/LED.....	546
Parameter Defaults.....	547
Beep on Next Bootup.....	547
Reboot.....	548
Host Trigger Session.....	548
Firmware Version.....	548
Scankit Version.....	548
Sample Barcodes.....	549
Sample Code 39.....	549
Sample Code 93.....	549
Sample UPC/EAN.....	549
Sample Code 128.....	550
Sample Interleaved 2 of 5.....	550
Sample GS1 DataBar.....	550
Sample PDF417.....	551
Sample Data Matrix.....	551
Sample Maxicode.....	552
Sample QR Code.....	552
Sample Aztec.....	552
Sample Grid Matrix.....	552
Sample US Postnet.....	553
Sample UK Postal.....	553

About This Guide

The SP72 Single Plane Scanner Product Reference Guide provides general instructions for setting up, operating, maintaining, and troubleshooting the SP72 horizontal and vertical scanners.



NOTE: Configurations listed with Color Camera and Sensormatic EAS features will be available in Q4 2023.

Configurations

Presents the different configurations of the SP72-V and SP72-H models with their respective descriptions.

Table 1 SP72-V Vertical Scanner Configurations

Configuration	Description
SP7201	
SP7201-SV00004ZZWW	Single Plane, USB Only, Standard Range
SP7201-SV00004ZCWW	Single Plane, USB Only, Standard Range, Checkpoint EAS (CBL-CE0072 cable included)
SP7201-DV00004ZCNA	Single Plane, USB Only, DL Parsing, Checkpoint EAS (CBL-CE0072 cable included), NA Only
SP7201-SV00004ZZY	Single Plane, USB Only, Standard Range, India Only
SP7201-SV00004ZSWW	Single Plane, USB Only, Standard Range, Sensormatic EAS
SP7201-SV00004ZZCN	Single Plane, USB Only, Standard Range, China Only
SP7201-SV00004ZCY	Single Plane, USB Only, Standard Range, Checkpoint EAS (CBL-CE0072 cable included), India Only
SP7208	
SP7208-SV00004ZZWW	Single Plane, Multi-Interface, AUX Port, Standard Range
SP7208-SV00004ZCWW	Single Plane, Multi-Interface, AUX Port, Standard Range, Checkpoint EAS (CBL-CE0072 cable included)
SP7208-SV00004CCWW	Single Plane, Multi-Interface, AUX Port, Standard Range, Checkpoint EAS (CBL-CE0072 cable included), Color Camera (CBL-CC0072 Color Camera Cable included)
SP7208-SV00004CSWW	Single Plane, Multi-Interface, AUX Port, Standard Range, Sensormatic EAS, Color Camera (CBL-CC0072 Color Camera Cable included)

Table 1 SP72-V Vertical Scanner Configurations (Continued)

Configuration	Description
SP7208-DV00004ZCNA	Single Plane, Multi-Interface, AUX Port, DL Parsing, Checkpoint EAS (CBL-CE0072 cable included), NA Only
SP7208-DV00004CCNA	Single Plane, Multi-Interface, AUX Port, DL Parsing, Checkpoint EAS (CBL-CE0072 cable included), Color Camera (CBL-CC0072 Color Camera Cable included), NA Only
SP7208-SV00004ZSWW	Single Plane, Multi-Interface, AUX Port, Standard Range, Sensormatic EAS
SP7208-SV00004ZCY	Single Plane, Multi-Interface, AUX Port, Standard Range, Checkpoint EAS (CBL-CE0072 cable included), India Only
SP7208-SV00004ZCCN	Single Plane, Multi-Interface, AUX Port, Standard Range, Checkpoint EAS (CBL-CE0072 cable included), China Only
SP7208-SV00004ZSCN	Single Plane, Multi-Interface, AUX Port, Standard Range, Sensormatic EAS, China Only

Table 2 SP72-H Horizontal Scanner Configurations

Configuration	Description
SP7201	
SP7201-SH00004SCWW	Single Plane, USB Only, Standard Range, EAS (CBL-CE0072 Checkpoint EAS cable included), Sapphire Glass
SP7201-SH00004DCWW	Single Plane, USB Only, Standard Range, EAS (CBL-CE0072 Checkpoint EAS cable included), Diamond-like Glass
SP7201-DH00004SCNA	Single Plane, USB Only, DL Parsing, EAS (CBL-CE0072 Checkpoint EAS cable included), Sapphire Glass, NA Only
SP7201-SH00004SCY	Single Plane, USB Only, Standard Range, EAS (CBL-CE0072 Checkpoint EAS cable included), Sapphire Glass, India Only
SP7201-SH00004SCCN	Single Plane, USB Only, Standard Range, EAS (CBL-CE0072 Checkpoint EAS cable included), Sapphire Glass, China Only
SP7201-SH00004DCCN	Single Plane, USB Only, Standard Range, EAS (CBL-CE0072 Checkpoint EAS cable included), Diamond-like Glass, China Only
SP7208	
SP7208-SH00004SCWW	Single Plane, Multi-Interface, Aux Port, Standard Range, EAS (CBL-CE0072 Checkpoint EAS cable included), Sapphire Glass
SP7208-SH00004DCWW	Single Plane, Multi-Interface, Aux Port, Standard Range, EAS (CBL-CE0072 Checkpoint EAS cable included), Diamond-Like Glass
SP7208-SH00004DSWW	Single Plane, Horizontal, Multi-Interface, AUX Port, Standard Range, Midnight Black, Sensormatic EAS, Diamond-like Glass
SP7208-DH00004SCNA	Single Plane, Multi-Interface, Aux Port, DL Parsing, EAS (CBL-CE0072 Checkpoint EAS cable included), Sapphire Glass, NA Only
SP7208-SH00004SSWW	Single Plane, Horizontal, Multi-Interface, AUX Port, Standard Range, Midnight Black, Sensormatic EAS, Sapphire Glass
SP7208-SH00004SCY	Single Plane, Multi-Interface, Aux Port, Standard Range, EAS (CBL-CE0072 Checkpoint EAS cable included), Sapphire Glass, India Only

Table 2 SP72-H Horizontal Scanner Configurations (Continued)

Configuration	Description
SP7208-SH00004SCCN	Single Plane, Multi-Interface, Aux Port, Standard Range, EAS (CBL-CE0072 Checkpoint EAS cable included), Sapphire Glass, China Only
SP7208-SH00004DCCN	Single Plane, Multi-Interface, Aux Port, Standard Range, EAS (CBL-CE0072 Checkpoint EAS cable included), Diamond-Like Glass, China Only
SP7208-SH00004DSCN	Single Plane, Horizontal, Multi-Interface, AUX Port, Standard Range, Midnight Black, Sensormatic EAS, Diamond-like Glass, China Only
SP7208-SH00004SSCN	Single Plane, Horizontal, Multi-Interface, AUX Port, Standard Range, Midnight Black, Sensormatic EAS, Sapphire Glass, China Only

Accessories

Presents the accessories of the SP72-V and SP72-H models with their respective descriptions. This includes multiple different cable types such as USB, RS-232, Keyboard Wedge, and IBM. The table also includes power supplies, mounting, and additional accessories.

Table 3 SP72 Accessories

Part Number	Description
USB Cables	
CBA-U21-S07ZBR	Shielded USB: Series A Connector, 7 ft. (2.1 m), Straight, BC1.2
CBA-U23-S07ZBR	Shielded USB: Power Plus Connector, 7 ft. (2.0 m), Straight, 12V
CBA-U30-S15ZBR	Shielded USB: Series A Connector, 15 ft. (4.6 m), Straight
RS-232 Cables	
CBA-R01-S07PBR	DB9F, 7 ft. (2 m) Straight, TXD-2, W/TTL Current Limit Protection
CBA-R08-S07ZBR	7 ft. (2 m) Straight, Nixdorf Beetle, 5V Direct Power, W/TTL Current Limit Protection
CBA-R10-S07ZBR	7 ft. (2 m) Straight, Nixdorf Beetle, Direct Power, W/TTL Current Limit Protection
CBA-R23-S07ZBR	7 ft. (2 m) Straight, Fujitsu T POS500 ICL, W/TTL Current Limit Protection
CBA-R27-S07ZAR	NCR7432 DYNAKEY, 7 ft. (2 m) Straight
CBA-R32-S07PAR	TRU TTL DB9F: 7 ft. (2 m) Straight
CBA-R41-S12ZAR	Siemens Nixdorf, 12V, 12 ft. Straight
Keyboard Wedge Cables	
CBA-K61-S07PAR	Auto-Host Detect, 7 ft. (2 m) Straight, PS/2 Power Port
IBM Cables	
CBA-M61-S07ZAR	Cable Assembly, Auto-Host Detect, IBM: 468X/9X, 7 ft. (2 m) Straight, Port 9B
CBA-M64-S07ZAR	Cable Assembly, Auto-Host Detect, IBM: 468X/9X, 7 ft. (2 m) Straight, Port 5B

Table 3 SP72 Accessories (Continued)

Part Number	Description
Miscellaneous Cables	
CBL-CC0072	Color Camera Cable for SP72-V, SM72
CBL-CE0072	Checkpoint EAS Cable for SP72, SM72
CBL-DC-376A1-01	DC Line Cord to PWRBGA12V50W0WW (straight connector)
23844-00-00R	AC Line Cord to PWRBGA12V50W0WW (US)
Power Supplies	
PWR-WUA5V4W0US	Power Supply, 5VDC, 100 - 240VAC, US/CA/MX/JP/TW
PWR-WUA5V4W0BR	Power Supply, 5VDC, 100 - 240VAC, KR (Korea)
PWR-WUA5V4W0EU	Power Supply, 5VDC, 100 - 240VAC, EU/UK
PWR-WUA5V4W0CN	Power Supply, 5VDC, 100 - 240VAC, CN
PWR-WUA5V4W0AU	Power Supply, 5VDC, 100 - 240VAC, HK/AU
PWR-WUA5V4W0IN	Power Supply, 5VDC, 100 - 240VAC, IN
PWR-BGA12V50W0WW	Level VI AC/DC Power Supply (brick) AC Input: 100-240V, 2.4A; DC Output: 12V, 4.16A, 50W Requires DC line cord and country-specific AC grounded line cord
Mounting Accessories	
BRKT-BM0072-00	Bucket Mount for SP72-H
BRKT-RM0072-04	Riser Mount for SP72-V
BRKT-TM0072-04	Table Mount for SP72-V
Other Accessories	
MISC-DG0072	Diamond-like Glass Platter for SP72-H
MISC-SG0072	Sapphire Glass Platter for SP72-H

Notational Conventions

The following conventions are used in this document:

- **Bold** text is used to highlight the following:
 - Dialog box, window, and screen names
 - Dropdown list and list box names
 - Checkbox and radio button names
 - Icons on a screen
 - Key names on a keypad
 - Button names on a screen

- Bullets (•) indicate:
 - Action items
 - List of alternatives
 - Lists of required steps that are not necessarily sequential.
- Sequential lists (for example, those that describe step-by-step procedures) appear as numbered lists.

Icon Conventions

The documentation set is designed to give the reader more visual clues. The following visual indicators are used throughout the documentation set.



NOTE: The text here indicates information that is supplemental for the user to know and that is not required to complete a task.



IMPORTANT: The text here indicates information that is important for the user to know.



CAUTION: If the precaution is not heeded, the user could receive a minor or moderate injury.



WARNING: If danger is not avoided, the user CAN be seriously injured or killed.



DANGER: If danger is not avoided, the user WILL be seriously injured or killed.

Service Information

If you have a problem with your equipment, contact Zebra Global Customer Support for your region. Contact information is available at: zebra.com/support.

When contacting support, please have the following information available:

- Serial number of the unit
- Model number or product name
- Software type and version number

Zebra responds to calls by email, telephone, or fax within the time limits set forth in support agreements.

If your problem cannot be solved by Zebra Customer Support, you may need to return your equipment for servicing and will be given specific directions. Zebra is not responsible for any damages incurred during shipment if the approved shipping container is not used. Shipping the units improperly can possibly void the warranty.

If you purchased your Zebra business product from a Zebra business partner, contact that business partner for support.

Getting Started

The SP72 Single Plane Scanner provides intuitive, hands-free scanning. The scanner reads all standard retail symbologies and interfaces to all popular Point of Sale (POS) devices.

The SP72 is available in two unique form factors:

- SP72-V (Vertical) for on-counter applications.
- SP72-H (Horizontal) for in-counter applications.

The SP72 is also available in two tiers to match specific feature requirements and budget:

- The SP7208 premium-level scanner combines optimal performance with advanced features, such as a color camera option to support vision-based applications.
- The SP7201 base-level scanner offers SP7208 performance but at a lower price, including only the essential features needed for many of today's applications.

Table 4 Differences between the SP7208 and SP7201

Feature	SP7208	SP7201
SP72-V		
Multiple interfaces: USB, RS-232, TGCIS (IBM) 46xx over RS485, Keyboard Wedge	Yes	5VDC USB only
Aux port	Yes	No
Aux power port	Yes	No
2MP color camera option	Yes	No
SP72-H		
Multiple interfaces: USB, RS-232, TGCIS (IBM) 46xx over RS485, Keyboard Wedge	Yes	5VDC USB only
Aux port	Yes	No
Aux power port	Yes	No

Unpacking the Scanner

Remove the scanner from its packing and inspect it for damage. The following items are included in the package:

- Scanner.

- SP72 Scanner Quick Reference Guide (p/n MN-004637-xx).



NOTE: Depending on the configuration purchased, the box may also contain a combination of cables (Color Camera Cable, Checkpoint EAS Cable, USB cable) and mounting accessories, such as the bucket.

If any items are missing or damaged, call the Zebra Technologies Support Center. See [Service Information](#) for contact information. KEEP THE PACKING. It is the approved shipping container and should be used if it is ever necessary to return the equipment for servicing.

Ports

The SP72 includes the following ports:

- Host Port (All models) - A 10-pin RJ45 type connector accommodates various host interface cables.
- EAS Port (EAS Models only) - A 10-pin RJ45 type connector accommodates various Electronic Article Surveillance (EAS) systems (such as, Checkpoint or Sensormatic).
- AUX Port (SP7208 Models only) - Series A type USB connector accommodates a handheld auxiliary scanner, such as the DS2208.
- AUX Power Port (SP7208 Models only) - 12VDC
- Color Camera Port (Color Camera models only)
- External Speaker Port (SP72-H Models only)



NOTE: For detailed connection information, see the applicable host interface chapter.

Features

Label diagrams of key features for the different scanner configurations.

Figure 1 SP7201-V Scanner

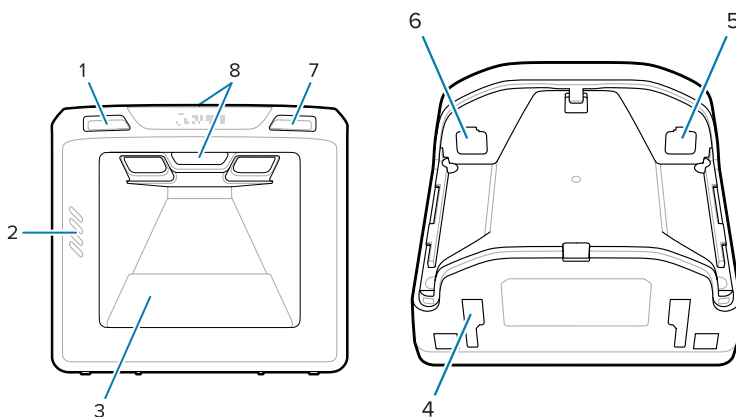

Table 5 SP7201-V Scanner

1	Volume control button
2	Speaker

Table 5 SP7201-V Scanner (Continued)

3	Scan window
4	Mounting Slots (2)
5	Host port
6	EAS port
7	Image Capture button
8	User Feedback indicator LEDs (2)

Figure 2 SP7208-V Scanner

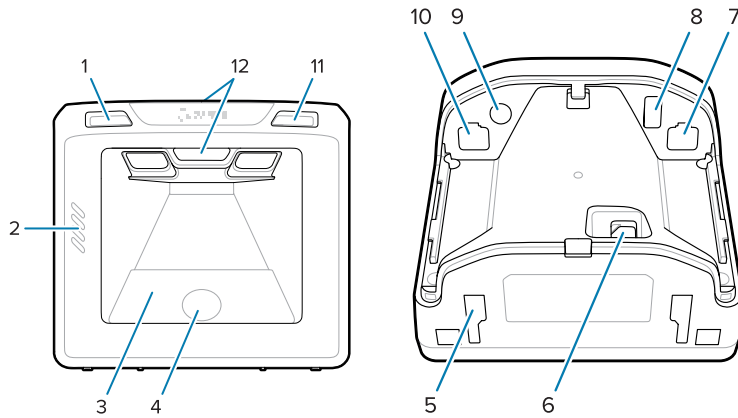

Table 6 SP7208-V Scanner

1	Volume control button
2	Speaker
3	Scan window
4	Color camera
5	Mounting Slots (2)
6	Color camera port
7	Host port
8	Aux port
9	Aux power port
10	EAS port
11	Image capture button
12	User Feedback indicator LEDs (2)

Figure 3 SP7201-H Scanner

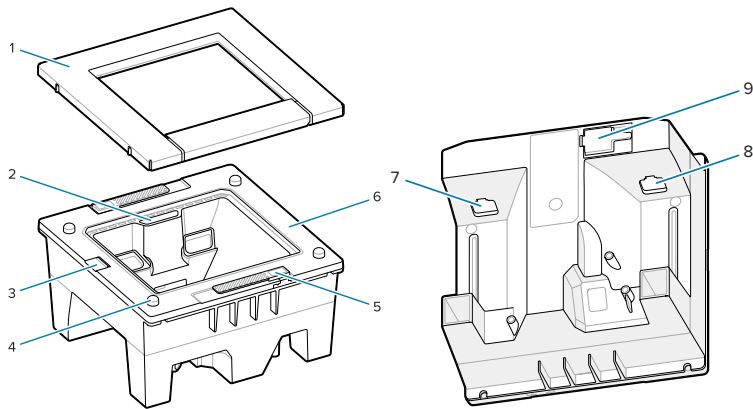

Table 7 SP7201-H Scanner

1	Platter assembly
2	User feedback indicator LED
3	Speaker
4	Platter alignment pin (4)
5	Lift feature (2)
6	Front housing
7	EAS port
8	Host port
9	External speaker port

Figure 4 SP7208-H Scanner

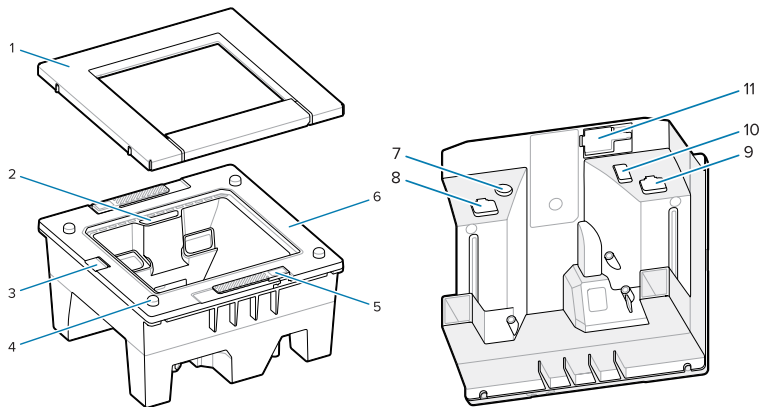

Table 8 SP7208-H Scanner

1	Platter assembly
2	User feedback indicator LED
3	Speaker

Table 8 SP7208-H Scanner (Continued)

4	Platter alignment pin (4)
5	Lift feature (2)
6	Front housing
7	Aux power port
8	EAS port
9	Host port
10	Aux port
11	External speaker port

Power Options

SP7201 (5VDC USB Only)

The SP7201 is powered from the host via the USB host cable and is ready to scan when connected. USB power is via Standard USB (5VDC) or USB BC1.2. It does not have an on/off switch.

SP7208 (Multi-Interface)

The SP7208 is powered from the host via the host cable and is ready to scan when connected. USB power is via Standard USB (5VDC), USB BC1.2 or USB Power Plus.



NOTE: Use of color camera and/or auxiliary scanner options supported on the SP7208 require more than 500mA. This can be achieved via a high-power USB port (such as USB BC1.2 compatible), a 12VDC PowerPlus cable, or an external power supply.

Host Interfaces

SP7201 (5VDC USB Only)

The SP7201 supports a 5VDC USB host connection only. The scanner defaults to the HID keyboard interface type. To select other USB interface types, scan programming barcode menus or use the Windows-based programming tool 123Scan. For international keyboard support, see [Country Codes](#) to program the keyboard to interface with a USB host.

SP7208 (Multi-Interface)

The SP7208 scanner supports the following interfaces, and automatically adapts to the connected host.

- USB host connection. The scanner defaults to the HID keyboard interface type. To select other USB interface types, scan programming barcode menus or use the Windows-based programming tool 123Scan. For international keyboard support, see [Country Codes](#) to program the keyboard to interface with a USB host.
- TTL-level RS-232 host connection. The scanner defaults to the standard RS-232 interface type. To modify communication between the scanner and the host, scan barcode menus or use the Windows-based programming tool 123Scan.
- IBM 468X/469X host connection. User selection is required to configure this interface. To modify communication between the scanner and the IBM terminal, scan barcode menus or use the Windows-based programming tool 123Scan.

- Keyboard Wedge host connection. The scanner defaults to the IBM AT Notebook interface type. The host interprets scanned data as keystrokes. For international keyboard support, see [Country Codes](#) to program the keyboard to interface with a keyboard wedge host.
- SSI communication between the scanner and a serial host, which allows the host to control the scanner.

Removing the Back Cover

Remove the back cover before connecting cables.

To remove the back cover, gently press on the area of the cover indicated by the arrow, slide the cover downward, and lift off.

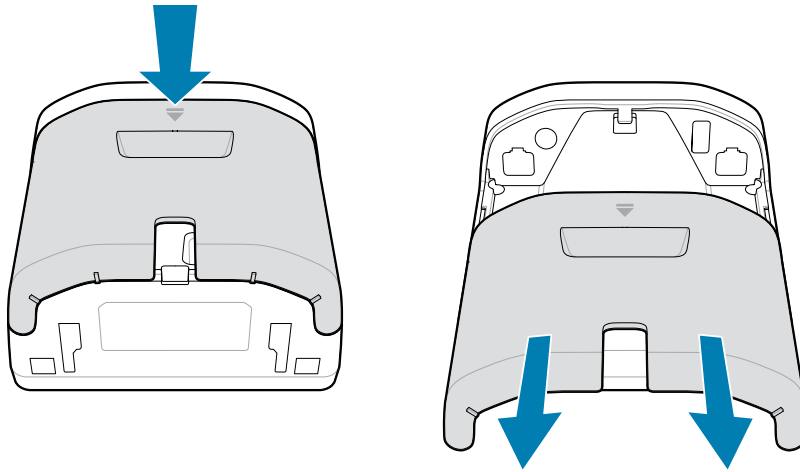

Installing Cables

This section describes how to connect cables to the SP7201 and SP7208.

Connecting Cables to the SP7201

To connect the cables to the SP7201:

1. Insert the host cable into the SP7201 host port.
2. For an optional EAS connection, see [Electronic Article Surveillance \(EAS\)](#).



NOTE: For specific host connection instructions, see the applicable host interface chapter. The connectors illustrated are examples only, and actual cables can vary, but the steps to connect the scanner are the same.

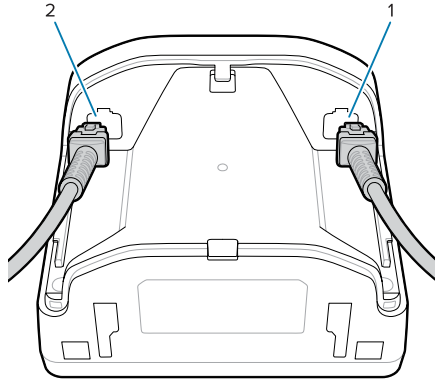

1	Host port
2	EAS port

Connecting Cables to the SP7208

To connect the cables to the SP7208:

1. Insert the host cable into the SP7208 host port.
2. If connecting an auxiliary scanner, insert the auxiliary scanner cable into the SP72 aux port.
3. For an optional EAS connection, see [Electronic Article Surveillance \(EAS\)](#).
4. If connecting an optional color camera, insert the camera cable into the SP7208 color camera port.
5. If connecting an auxiliary scanner or color camera, connect the 12V power supply to the power port.



NOTE: If connecting the 12V power supply, you must connect this last to ensure proper scanner operation.



WARNING:

The USB-C connector on this device is not electrically symmetrical. The cable included with the device is designed to fit in one orientation only. Using a non-provided USB-C cable may result in inserting the cable in the wrong electrical orientation rendering the color camera inoperable.



NOTE: For specific host connection instructions, see the applicable host interface chapter. The connectors illustrated are examples only, and actual cables can vary, but the steps to connect the scanner are the same.

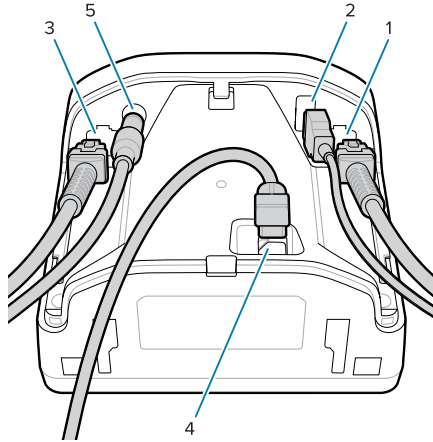

1	Host port
2	Aux port
3	EAS port
4	Color camera port
5	Power port

Connecting an External Speaker

Provides instructions for connecting an external speaker to the SP72-H.



NOTE: This applies to the SP72-H only.

Insert a 2-wire external speaker (customer-provided) into the SP72-H external speaker port.



IMPORTANT: The external speaker and cable must meet the following specifications:

- Must have a 2-pin micro-fit 3.0 type connector at the scanner end.
- Speaker must be 4 ohms, 1 watt.
- Cable must be shielded 24-gauge wire no longer than 2 feet.

Replacing the Back Cover

The SP72 back cover has three channels to route outgoing cables so they do not hinder scanner placement.

To replace the back cover:

1. Place the cover on the back of the scanner, properly routing the cables through the nearest channel.

2. Press the cover and slide upward until it snaps into place.

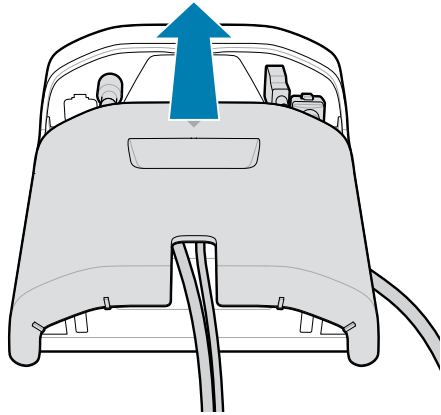

Mounting Accessories

The SP72 is designed to sit on a table top, but optional mounting kits are available to mount the SP72 to a table top or a wall, or install in a counter top.

- Table Mount, 3-degree Table Mount for the SP72-V (BRKT-TM0072-04, BRKT-TM1072-04)
- Riser Mounts for the SP72-V (BRKT-RM0072-04)
- Bucket Mount for the SP72-H (BRKT-BM0072-00)



NOTE: Installing the scanner behind an additional protective window can create reflective areas that may impact performance.

Figure 5 SP72-V Table Mount (BRKT-TM0072-04)

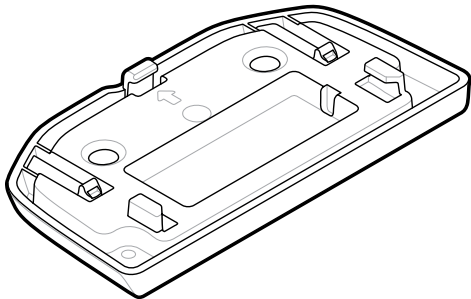

Figure 6 SP72-V Riser Mount (BRKT-RM0072-04)

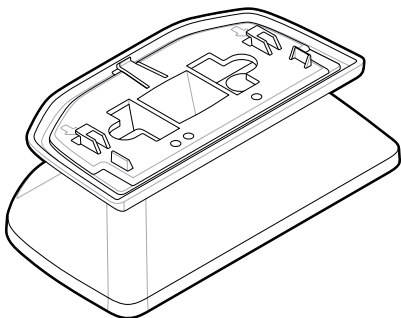
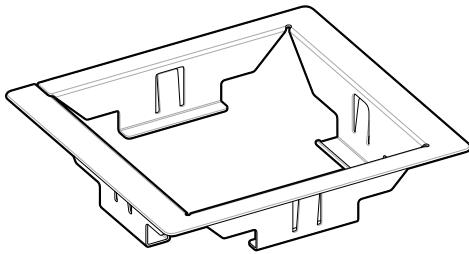

Figure 7 SP72-H Bucket Mount (BRKT-BM0072-00)

Mounting the SP72-V Using the Table Mount



NOTE:

Instructions also apply to the 3-degree table mount (BRKT-TM1072-04) [not pictured].

Mounting the Scanner Using Double-sided Tape

(Preferred method) To mount the scanner to the tabletop using the double-sided tape provided:

1. See [Installing Cables](#) to connect all interface and power cables.
2. Replace the back cover and verify the cables are routed properly.
3. Determine the location for the scanner.
4. Peel off the paper on one side of the double-sided tape strip and press it into the rectangular area on the bottom of the mount.

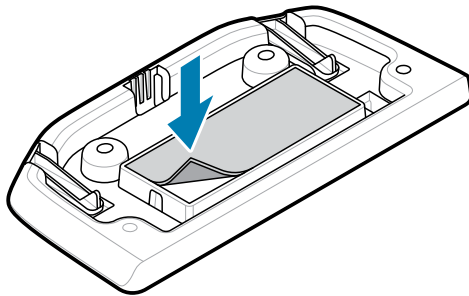

5. Peel off the paper on the remaining side of the double-sided tape strip.
6. Position the mount and press down onto the table surface.
7. Align the scanner mounting slots with the plastic tabs on the mount.

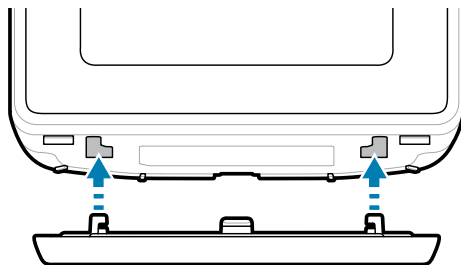

8. Slide the scanner back until it clicks into place, with the plastic tabs in the scanner mounting slots.

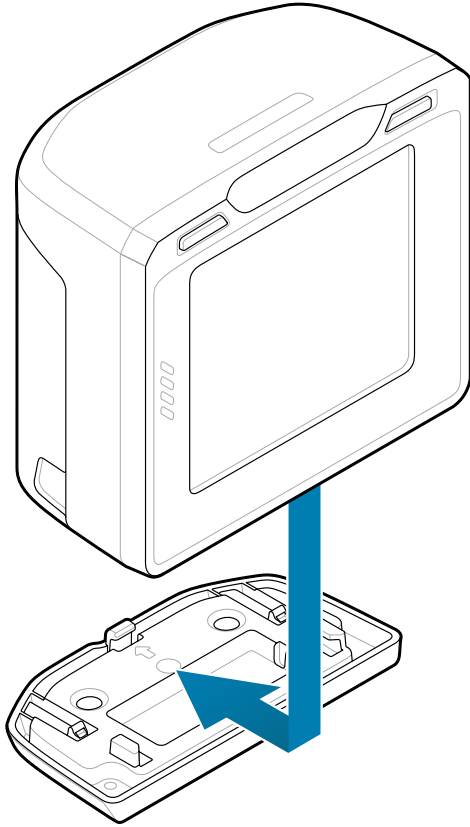

Mounting the Scanner Using Screws

To mount the scanner to the tabletop using screws (not provided):

1. See [Installing Cables](#) to connect all interface and power cables. Replace the back cover and verify the cables are routed properly.
2. Place the Table Mount in the desired scanner location.
3. Secure the mount with four screws (not included; #10 screw size recommended).

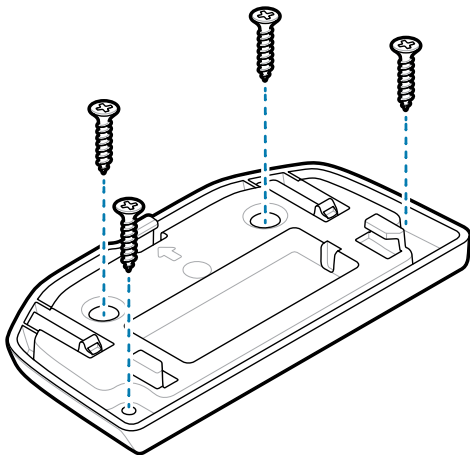

4. Align the scanner mounting slots with the plastic tabs on the mount.

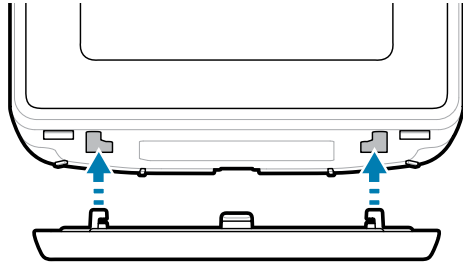

5. Slide the scanner back until it clicks into place, with the plastic tabs in the scanner mounting slots.

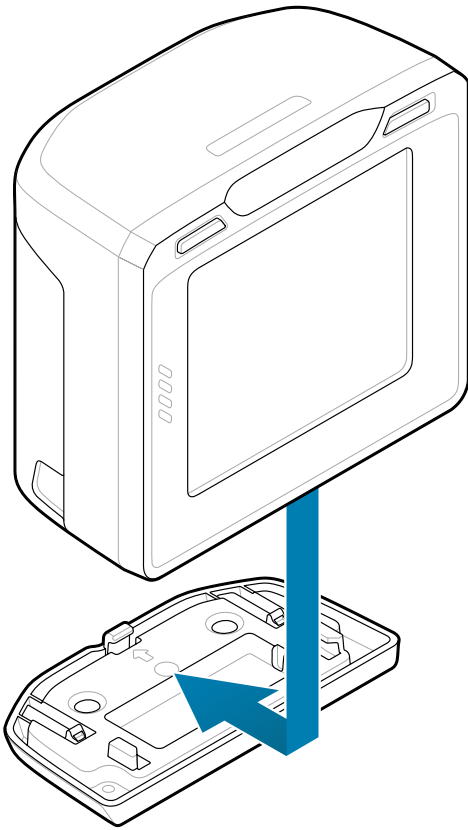

Mounting the SP72-V Using the Riser Mount

To mount the scanner to the tabletop or wall:

1. See [Installing Cables](#) to connect all interface and power cables. Replace the back cover and verify the cables are routed properly.
2. Place the flat surface of the Riser Mount on the tabletop or wall in the desired scanner location and using a pencil through the screw holes on the top of the mount, mark the two mounting holes.
3. Drill two #10 pilot holes on the marked locations.

4. Place the Riser Mount in position over the pilot holes and insert the two provided #10 wood screws through the holes to fasten to the mounting surface.

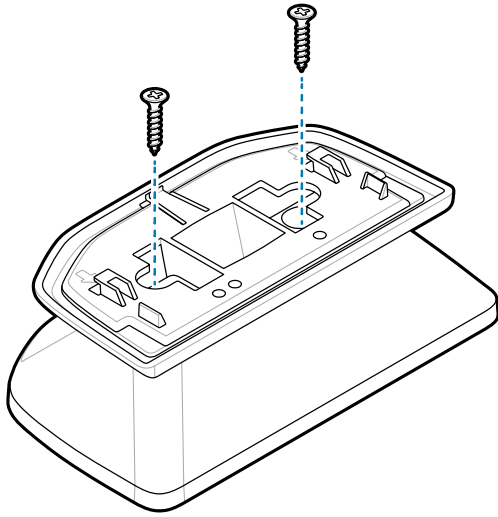

5. Align the scanner mounting slots with the plastic tabs on the mount.

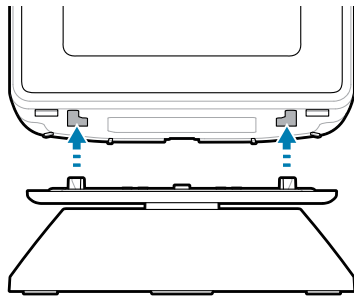

6. Slide the scanner forward until it clicks into place, with the plastic tabs in the scanner mounting slots.

7. If table-top mounted, use the integrated pivot to adjust the angle of the scanner 15° forward as needed.

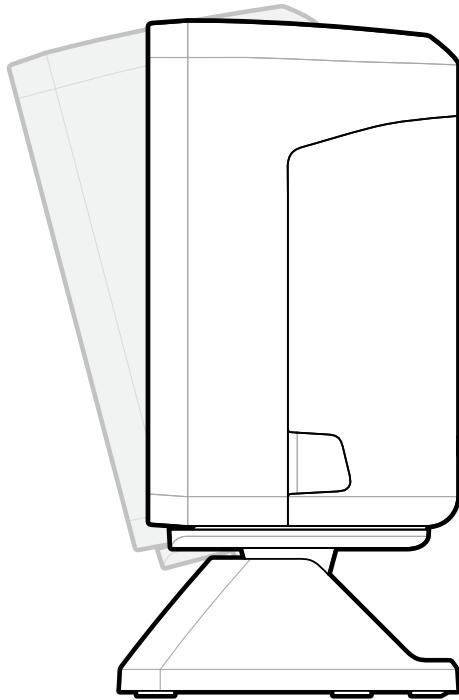

8. If wall-mounted, use the integrated pivot to adjust the angle of the scanner 15° to 45° backward.

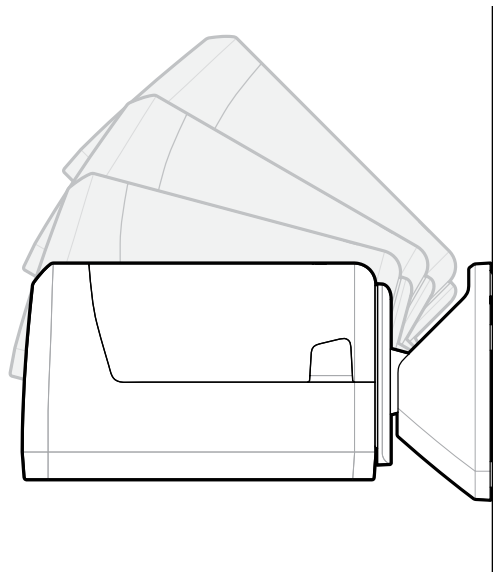

Removing the SP72-V from the Mount

To remove the scanner from the Table Mount, grasp the scanner firmly on both sides, slide it forward and lift out.

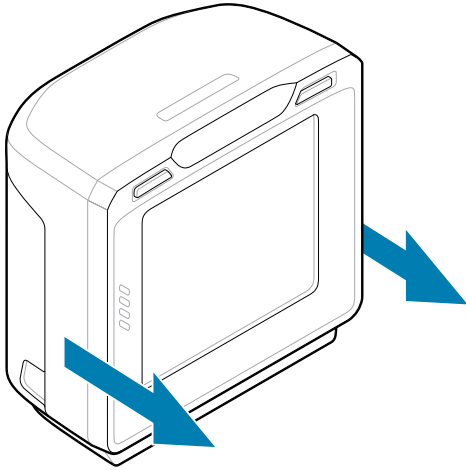

To remove the scanner from the Riser Mount, grasp the scanner firmly on both sides, slide it backward and lift out.

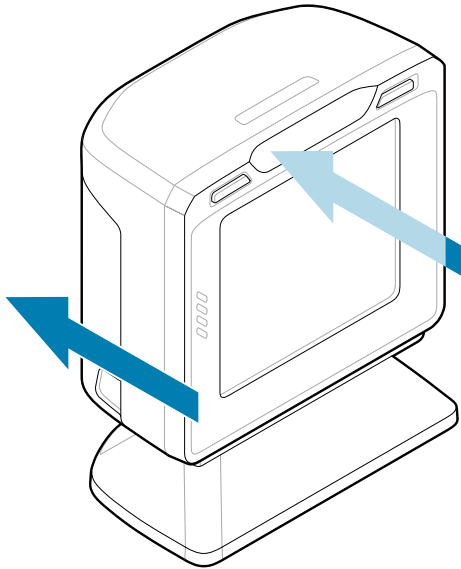

Mounting the SP72-H Using the Bucket Mount

The SP72-H is designed to be installed in the counter top.

Mounting the SP72-H Resting on the Counter Top

To mount the scanner resting on the counter using the Bucket Mount:

1. Cut a hole in the countertop at the desired scanner location, measuring 6.26 in. (159 mm) square.

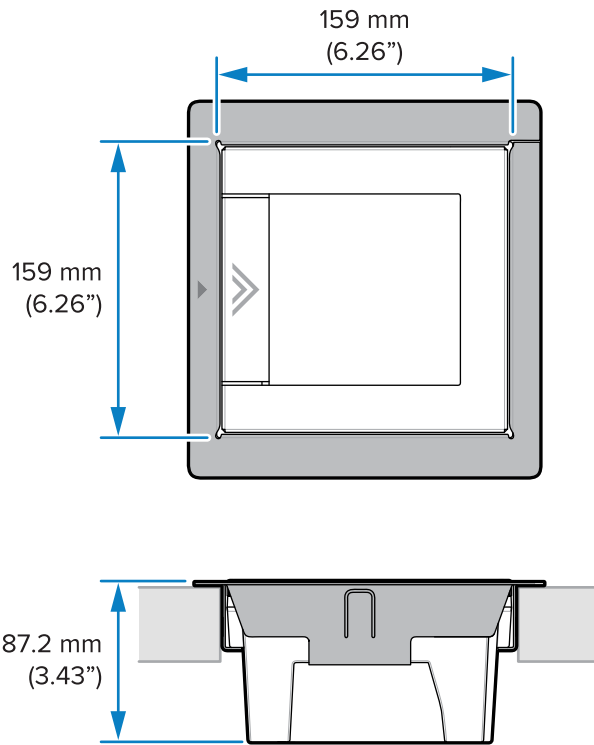

2. Place the Bucket Mount into the hole.

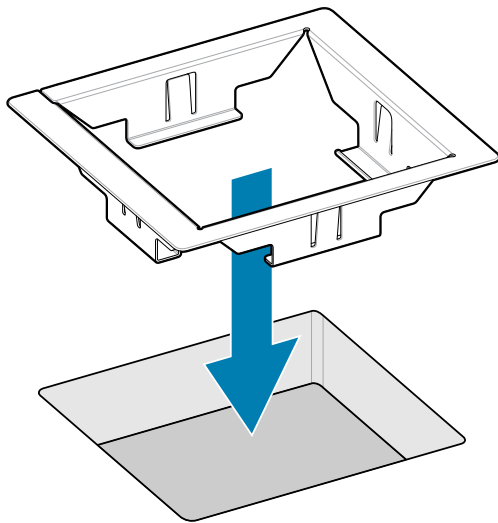

3. Place the scanner on the counter near the bucket.
4. Route the cables from beneath the hole and attach to the scanner.
5. Use the lift features to lower the scanner into the bucket.

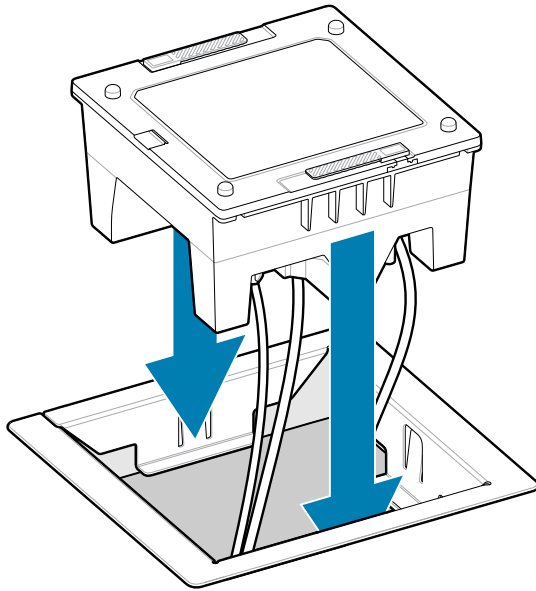

6. Install the platter.

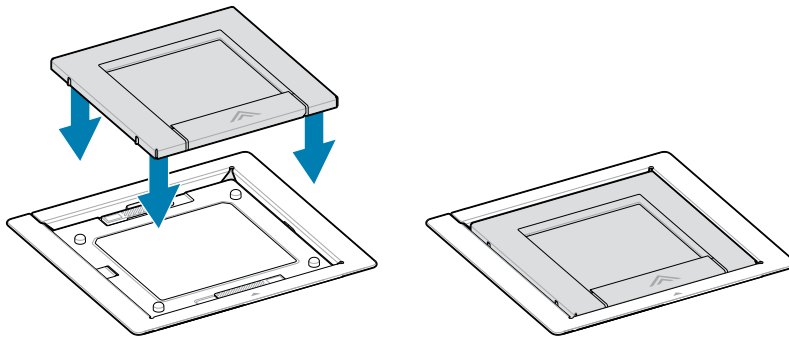

NOTE: The arrows on the bucket and the platter must align (face in the same direction). Arrows indicate the scan direction.

Mounting the SP72-H Flush with the Counter Top

To mount the scanner so it is flush with the counter using the Bucket Mount:

1. Cut a hole in the countertop at the desired scanner location, measuring 6.26 in. (159 mm) square.
2. With a router set to a depth of 1.27 mm (0.05 in.), route the opening with routing dimensions of 188 mm x 201 mm (7.40 in. x 7.91 in.), with the longer dimension perpendicular to the product flow. The corner

radius should not exceed 5.3 mm (0.21 in.). Ensure the routed feature is concentric with the inside square cutout.

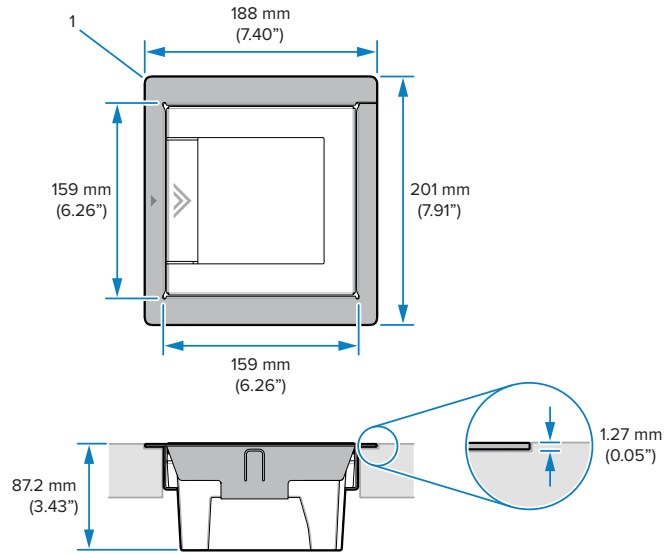

3. Place the Bucket Mount into the hole.
4. Place the scanner on the counter near the bucket.
5. Route the cables from beneath the hole and attach to the scanner.
6. Use the lift handles to lower the scanner into the bucket.

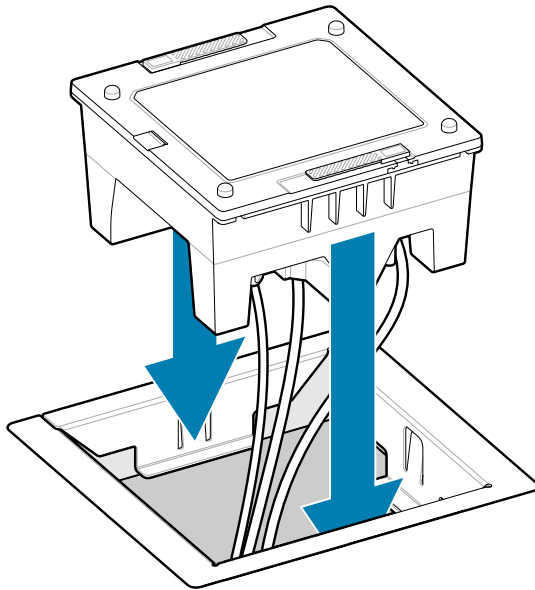

7. Install the platter.



NOTE: The arrows on the bucket and the platter must align (face in the same direction).

Configuring the Scanner

To configure the scanner, use the barcodes in this manual, or use the 123Scan configuration program (see [123Scan and Software Tools](#)).

To set up the scanner for RS-232, IBM 468X/469X, Keyboard Wedge, or USB connection, see the host-specific chapter.

Operating the Scanner

Indicator Lights

Provides details regarding the location of the indicator LED lights for the SP72-V and SP72-H model.

- The SP72-V has two LED lights located on the front and the top.
- The SP72-H has one LED light located on the front.



NOTE: All LEDs are bi-color red/green.

Adjusting Speaker Tone

To change speaker tone, hold the Volume Control button on the front of the scanner (see [Features](#)) for three seconds or longer.

While the speaker cycles through the available tones, release the Volume Control button when you hear the desired tone. This allows you to adjust the speaker tone, but does not allow you to disable the tone.

Alternatively, scan a barcode in [Scan Tone](#) to change or disable the speaker tone.



NOTE:

The [Volume/Tone Button](#) parameter barcodes can be used to prevent the speaker tone from being changed.

Adjusting Speaker Volume

To change beeper volume, press (short duration press) and release the Volume Control button on the front of the scanner (see [Features](#)) repeatedly until the desired volume level sounds (high, medium or low).

Alternatively, scan a barcode in [Beeper Volume](#).



NOTE:

The [Volume/Tone Button](#) parameter barcodes can be used to prevent speaker volume from being changed.

123Scan and Software Tools

This chapter describes the Zebra software tools available for customizing scanner operation.

123Scan

123Scan is a software tool that simplifies scanner setup and more.

Intuitive enough for first time users, the 123Scan wizard guides users through a streamlined setup process. Settings are saved in a configuration file that can be printed as a single programming barcode for scanning, emailed to a smart phone for scanning from its screen, or downloaded to the scanner using a USB cable.

Through 123Scan a user can:

- Configure a scanner using a wizard.
 - Program the following scanner settings.
 - Beeper tone / volume settings.
 - Enable / disable symbologies.
 - Communication settings.
 - Modify data before transmission to a host using:
 - Advanced Data Formatting (ADF) - Scan one barcode per trigger pull.
 - Multicode Data Formatting (MDF) - Scan many barcodes in one trigger pull (select scanners).
 - Preferred Symbol - Single out one barcode on label of many (select scanners).
- Load parameter settings to a scanner via the following.
 - Barcode scanning.
 - Scan a paper barcode.
 - Scan a barcode from a PC screen.
 - Scan a barcode from a smart phone screen.
 - Download over a USB cable.
 - Load settings to one scanner.
 - Stage up to 10 scanners simultaneously (Powered USB Hub recommended with 0.5 amp / port).

- Validate scanner setup.
 - View scanned data within the utility's Data view screen.
 - Capture an image and save to a PC within the utility's Data view screen.
 - Review settings using the Parameter Report.
 - Clone settings from an already deployed scanner from the Start screen.
- Upgrade scanner firmware.
 - Load settings to one scanner.
 - Stage up to 10 scanners simultaneously (Powered USB Hub recommended with 0.5 amp / port).
- View statistics such as:
 - Asset tracking information.
 - Time and usage information.
 - Barcodes scanned by symbology.
- Generate the following reports.
 - Barcode Report - Programming barcode, included parameter settings, and supported scanner models.
 - Parameter Report - Parameters programmed within a configuration file.
 - Inventory Report - Scanner asset tracking information.
 - Validation Report - Scanned data from the Data view.
 - Statistics Report - All statistics retrieved from the scanner.

For more information go to: zebra.com/123Scan.

Communication with 123Scan

Use a USB cable to connect the scanner to a Windows host computer running 123Scan.

123Scan Requirements

- Host computer running Windows 10 or 11
- Scanner
- USB cable

123Scan Information

For more information on 123Scan, go to: zebra.com/123Scan

For a 1 minute tour of 123Scan, go to: zebra.com/ScannerHowToVideos

To see a list of all of our software tools, go to: zebra.com/scannersoftware

Scanner SDK, Other Software Tools, and Videos

Tackle all your scanner programming needs with our diversified set of software tools. Whether you need to simply stage a device, or develop a fully featured application with image and data capture as well as asset management, these tools help you every step of the way.

To download any of the following free tools, go to: zebra.com/scannersoftware.

- 123Scan configuration utility
- SDKs
 - Scanner SDK for Windows
 - Scanner SDK for Linux
 - Scanner SDK for Android
 - Scanner SDK for iOS
- Drivers
 - OPOS driver
 - JPOS driver
 - USB CDC driver
- Scanner Management Service (SMS) for Remote Management
 - Windows
 - Linux
- Mobile Apps
 - Scanner Control App
 - Android
 - iOS
 - Scan-To-Connect Utility
 - Android
 - Windows
- How-To-Videos



NOTE: For a list of SDK supported scanner functionality by communication protocol, see [Communication Protocol Functionality](#)

Advanced Data Formatting

Advanced Data Formatting (ADF) allows customizing data before transmission to the host device. Use ADF to edit scanned data to suit the host application's requirements. With ADF you scan one barcode per trigger pull. ADF is programmed using 123Scan.

For a video on Creating an Advanced Data Formatting (ADF) Rule using 123Scan, go to zebra.com/ScannerHowToVideos.

For additional information, refer to the Advanced Data Formatting Programmer Guide.

Multicode Data Formatting

Multicode Data Formatting (MDF) enables a 2D imaging scanner to scan all barcodes on a label at once, and then modify and transmit the data to meet host application requirements. MDF supports programming up to nine unique labels into one scanner.

Programming options include:

- Output all or specific barcodes.
- Control the barcode output sequence.
- Apply unique multicode data formatting (MDF) to each output barcode.
- Discard scanned data if all required barcodes are not present.

For more information, refer to the Multicode Data Formatting and Preferred Symbol User Guide, p/n MN-002895-xx.

For a video on Creating an Multicode Data Formatting (MDF) Rule using 123Scan, go to zebra.com/ScannerHowToVideos.

Multicode Data Formatting Use

Multicode Data Formatting may yield multiple unexpected and undesired outputs when a label (most likely on a complex label) passes through the scanner's field of view. This problem happens when the complex label's barcodes can be matched by more than one group (for example, Group 1 represents all barcodes present, and Group 2 represent some barcodes present).

1. As the label is moving through the field of view, it is first partially read (some of the barcodes in the field of view in Frame 2).
2. Then, the second decode occurs as it is fully read (all the barcodes in the field of view in Frame 3).

- This yields two different outputs (instead of the expected single output) from the presentation of a label. This problem is driven by a complex label inadvertently matching two different MDF rules/groups, thereby yielding two outputs.

Figure 8 Scanning Label in a Horizontal Orientation

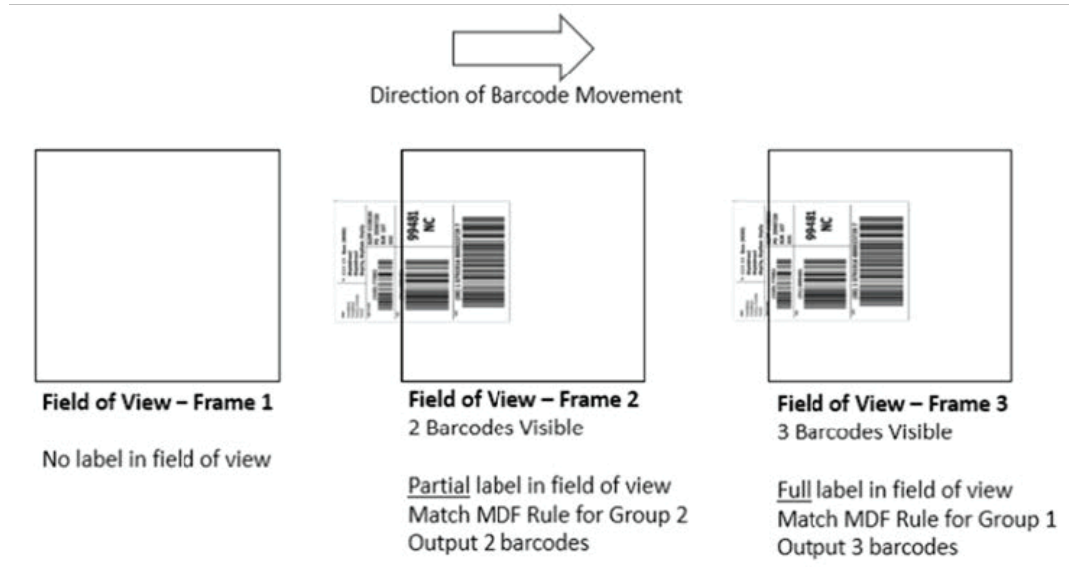

MDF for Best Practices

Suggestions to minimize the undesired multiple outputs when scanning with MDF.

- Scan barcodes in a vertical orientation.

Figure 9 Scanning Label in a Vertical Orientation

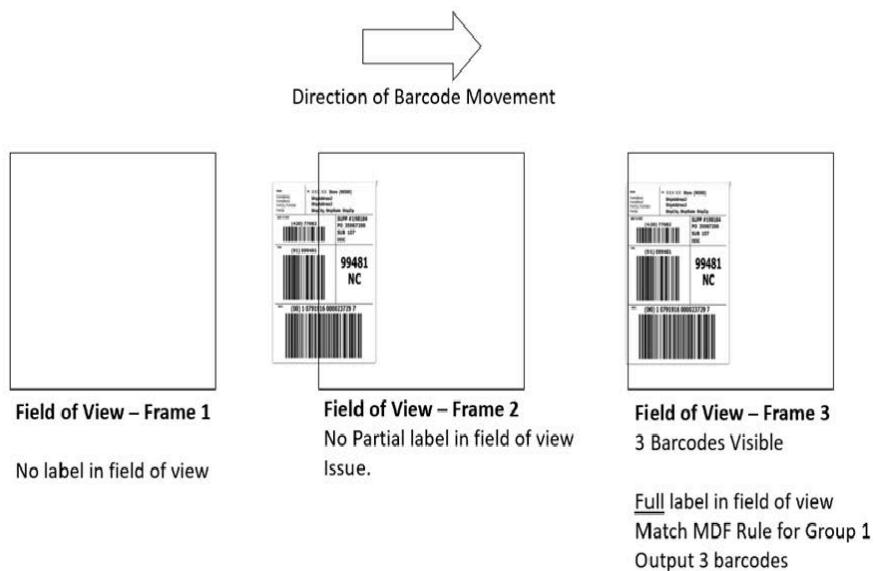

- When creating the MDF programming with multiple groups, the Group 1's pattern match should be the most complicated (hardest to match), which equals to the most number of barcodes and criteria. Then Group 2, 3, and so on should be progressively matched more easily.
- When defining criteria, avoid enabling an output when the pattern is not matched. Set **Output if NO pattern match** set as **Discard bar code**.

Figure 10 Figure Match Setting for Output

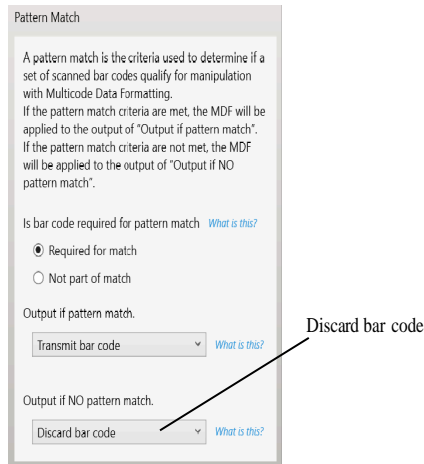

- Select Discard barcode(s) NOT within the pattern match in the 123Scan MDF setting. For more details, select **What is this?** located next to this selection.
- To prevent double decodes of the same symbol, increase the Timeout Between Same Symbols setting. See [Timeout Between Decodes, Same Symbol](#) for more details.
- Turn the scanner's aimer on to assist operators in scanning the barcode in a more consistent manner.
- Other reasons a label/barcode may not be decoded while in the field of view are as follows:
 - The label out of focus (too close or too far away). See [Decode Ranges](#) for correct working range.
 - Specular reflection (reflection off a shiny surface).
 - The label is presented at extreme angle to scanner.

Preferred Symbol

Preferred Symbol is a barcode prioritization technique that enables favored decoding of high-priority barcode(s). The Preferred Symbol is the only barcode that is decoded and output within the preset Preferred Symbol Timeout. During this time, the scanner attempts to decode the prioritized barcode and reports only this barcode.

For more information, refer to the Multicode Data Formatting and Preferred Symbol User Guide, p/n MN-002895-xx.

To program Preferred Symbol via 123Scan, select **123Scan > Configuration Wizard > Symbologies** screen, and then select **Preferred Symbol** from the drop-down menu. Preferred Symbol programming is saved in the 123Scan configuration file.

Figure 11 Preferred Symbol Programming Options

Preferred Symbol

Preferred Symbol [What is this?](#)

Options

Prioritized symbologies

Preferred Symbol Options [Edit](#)

Identify exact bar code

Preferred symbol criteria [View / Edit](#)

Prioritization time (ms) [What is this?](#)

Data Parsing (UDI Scan+, Label Parse+ and Blood Bag Parse+)

Data Parsing allows a Zebra scanner to scan a UDI label, GS1 label, or Blood Bags with one or more barcodes encoded with multiple data fields (such as date of manufacture, expiration date, batch number, GTIN, and SSCC) and transmit select data fields and not others, in a specific order to a host application. Wave the scanner over all the barcodes while holding the trigger.

The scanner finds and transmits only the required data fields, even if they are spread across multiple barcodes and on different sides of the container.

In addition, the scanner can insert field separators (such as tab, enter, and slash) to automate data entry into a host application.

Use 123 Scan to program your scanner. For more information on writing a Data Parsing Rule, refer to the Data Parsing (UDI, GS1 Label, Blood Bag) on Zebra Scanners User Guide at: zebra.com/support. To watch a video on Creating a Data Parsing Rule using 123Scan, go to: zebra.com/ScannerHowToVideos.

Scan a UDI Label using UDI Scan+

Government regulatory agencies (such as the United States Food and Drug Administration (FDA), European Commission, and International Medical Device Regulatory Forum) have established Unique

Device Identification (UDI) standards to identify and monitor the distribution and use of medical devices within healthcare environments

These UDI standards identify medical devices from manufacturing through distribution to patient use - enabling complete traceability of the millions of individual medical devices utilized for patient care. To enable UDI compliance, all medical devices must carry a UDI label to enable “track and trace” from the point of production, during shipment, through the product’s use and disposal.

Scan a GS1 Label using Label Parse+

The GS1 Organization, an international standards body, has released specifications used worldwide for generating shipping labels. These labels are used when shipping packages (logistics), raw materials and produce.

Scan a Blood Bag Label using Blood Bag Parse+

The International Council for Commonality in Blood Banking Automation (CCBBA Organization, an international standards body, has released a worldwide specification for generating blood bag labels. These labels are used when shipping, storing, and using blood bags.



NOTE: For more information, go to: isbt128.org/tech-library/iccbba-documents/standards-documents/standard-labeling-blood.

Data Capture

This section provides beeper and LED definitions and general instructions and tips for scanning.

Scanning

For optimal scanning performance, ensure the surface covered by the active scan area is free of designs (for example, stripes or patterns). Ideally, the area should be a light, solid color.

The scanner includes an object detection wakeup system that provides a high swipe speed and reduces power consumption. The red Illumination has two power level modes: Idle Mode for object detection and Full Illumination for scanning. Presenting an object to the scanner window activates Full Illumination Mode, and removing the object returns the scanner to Idle Mode.

When the object presented in the Field of View (FOV) includes a barcode, the scanner scans the barcode, and if the barcode is successfully decoded, the illumination LEDs return to Idle Mode when the object is removed. The scanner is able to adjust the FOV to prevent decoding undesired barcodes in the area.

Active Scan Area

The active scan area is the area in front of the scanner window opening in which a barcode can be decoded, represented by the dotted area.

To scan a barcode, ensure all cable connections are secure, and present the item anywhere within the active scan area with the barcode facing the scanner window.

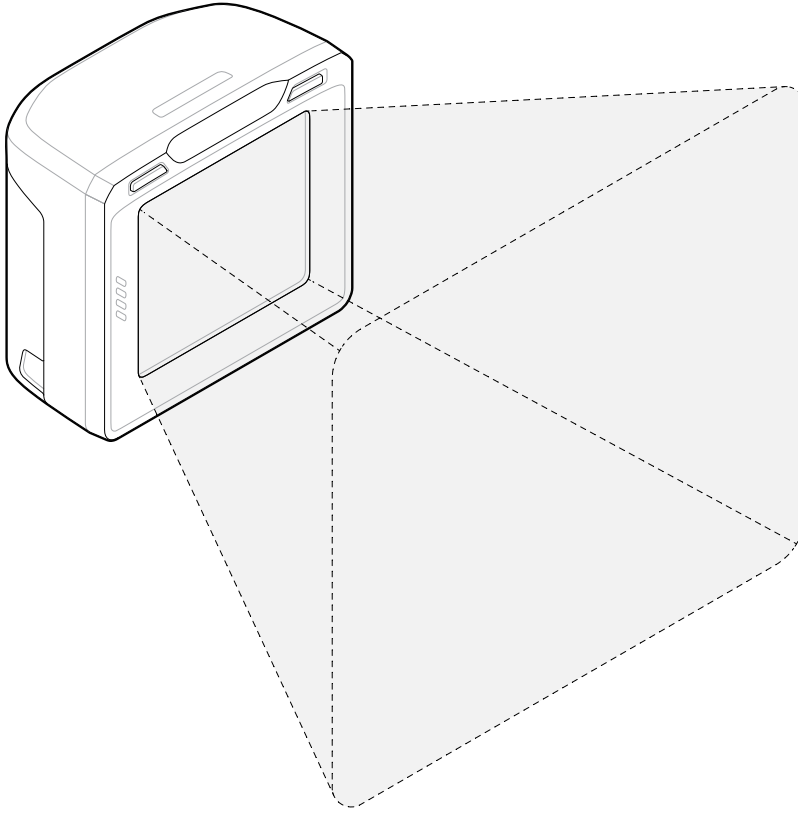

Upon successful decode, the scanner beeps and the green LED flashes momentarily.

Decode Ranges

Table 9 Decode Ranges: SP72-V

Barcode Type	Typical Ranges (cm)	Typical Ranges (in.)
3 mil Code 39	0.0 - 9.7	0.0 - 3.8
10 mil Code 39	0.0 - 20.6	0.0 - 8.1
3 mil Code 128	0.0 - 8.4	0.0 - 3.3
15 mil Code 128	0.0 - 22.9	0.0 - 9.0
13 mil UPC-A	0.0 - 21.8	0.0 - 8.6
14 mil PDF417	0.0 - 19.2	0.0 - 7.6
5 mil DataMatrix	0.5 - 6.5	0.2 - 2.6
15 mil DataMatrix	0.0 - 16.8	0.0 - 6.6
20 mil QR Code	0.0 - 19.1	0.0 - 7.5

Table 10 Decode Ranges: SP72-H

Barcode Type	Typical Ranges (cm)	Typical Ranges (in.)
3 mil Code 39	0.0 - 7.3	0.0 - 2.9
10 mil Code 39	0.0 - 17.1	0.0 - 6.7
3 mil Code 128	0.0 - 6.3	0.0 - 2.5
15 mil Code 128	0.0 - 19.4	0.0 - 7.6
13 mil UPC-A	0.0 - 18.2	0.0 - 7.2
14 mil PDF417	0.0 - 16.0	0.0 - 6.3
5 mil DataMatrix	0.5 - 5.7	0.2 - 2.2
15 mil DataMatrix	0.0 - 14.1	0.0 - 5.6
20 mil QR Code	0.0 - 16.0	0.0 - 6.3

Beeper and LED Indicators

In addition to beep sequences, the scanner includes an array of three bi-color (green/red) LEDs to display system status and alerts.

The following table defines beep sequences that occur during scanner operation and programming, and LED indications that display during scanning.

Table 11 Scanner Beeper and LED Indications

Beeper Sequence	LED	Indication
Standard Use		
Low, medium, high	Green	Power up
User-configured	Green blink off, then on	A barcode was decoded
None	Center green LED remains ON	Presentation mode is on
4 low	Red	Transmission error
5 low	Red	Conversion or format error
Low, low, low, extra low	Red	RS-232 receive error
High	None	A <BEL> character is received over RS-232
low, high, high, low	None	The attached aux scanner is drawing too much current.
high, low	None	An unsupported device was plugged into the USB host, and/or the device failed enumeration.
Image Capture		
None	All green, blinking	Snapshot mode started
None	Return to steady green	Snapshot mode complete

Table 11 Scanner Beeper and LED Indications (Continued)

Beeper Sequence	LED	Indication
High, low state	Green (default) LED mode based upon hand-held/hands-free mode	Snapshot mode time-out
5 clicks, then shutter sound	Green blinking	Snapshot taken
EAS		
Sensormatic EAS Soft Tag Beep (programmable)	N/A	A soft tag is deactivated.
Sensormatic EAS Hard Tag Beep (programmable)	N/A	The scanner conclusively detected a hard tag.
Sensormatic Tag Detected Any Time Beep (programmable)	N/A	A soft or hard tag is in the detected field.
Sensormatic EAS Deactivation Fail Beep (programmable)	N/A	A tag is not deactivated, is considered live, and the type of tag (soft or hard) cannot be determined.
High, low	N/A	EAS communication disconnect; the scanner disconnected from the Sensormatic control box.
Low, high	N/A	EAS communication reconnect; the scanner reconnected to the Sensormatic control box.
Parameter Programming		
Low, high	Red	Input error: incorrect bar code, programming sequence, or Cancel scanned
High, low	Green	Number expected; enter value using numeric bar codes
High, low, high, low	Green	Successful program exit with change in parameter setting
ADF Programming		
Low/high/low	None	ADF transmit error
High/low	Green	Number expected, enter another digit. Add leading zeros to the front if necessary.
Low/low	Green	Alphanumeric expected, enter another alphanumeric character or scan the End of Message barcode
High/high	Green blinking	ADF criteria or action is expected, enter another criteria or action or scan the Save Rule barcode
High/low/low	Green	All criteria or actions cleared for current rule, continue entering rule
High/low/high/low	Green (turns off after blinking)	Rule saved. Rule entry mode exited.

Table 11 Scanner Beeper and LED Indications (Continued)

Beeper Sequence	LED	Indication
Long low/long high	Red	Rule error. Entry error, wrong barcode scanned, or criteria/action list is too long for a rule. Re-enter criteria or action.
Low beep	Green	Deleted last saved rule. The current rule is left intact.
Low/high/high	Green	All rules deleted
Long low/long high/long low/long high	Red	Out of rule memory. Erase some existing rules, then try to save rule again.
Long low/long high/long low	Green (turns off after blinking)	Cancel rule entry. Rule entry mode exited because of an error or the user asked to exit rule entry.
Macro PDF		
2 low	None	Buffered File ID error. A barcode not in the current MPDF sequence was scanned.
2 long low	None	File ID error. A barcode not in the current MPDF sequence was scanned.
3 long low	None	Out of memory. There is not enough buffer space to store the current MPDF symbol.
4 long low	None	Bad symbology. Scanned a 1D or 2D barcode in an MPDF sequence, a duplicate MPDF label, a label in an incorrect order, or trying to transmit an empty or illegal MPDF field.
5 long low	None	Flushing MPDF buffer
Fast Warble	None	Aborting MPDF sequence
Low/high beeps	None	Flushing an already empty MPDF buffer

Electronic Article Surveillance (EAS)

The scanner includes an integrated Electronic Article Surveillance (EAS) antenna. The scanner and EAS system can operate independently of each other. The deactivation range is mapped suitable to the scanning range, so both can be accomplished almost simultaneously.

The EAS connector port in the back of the device allows connecting the EAS deactivation antenna to the EAS system.

Checkpoint EAS

Model Compatibility

The scanner is intended for use with Checkpoint CP-VII, CP-IX, and CP-XI systems. It does not support CP-IV and other low-power receiver-based EAS deactivation systems.

Considerations

The Checkpoint CP-VII system generates a periodic burst of electromagnetic energy that deactivates EAS tags brought near the scanner. To avoid interference with scanner operation, observe the following precautions when installing the EAS system:

- Position the EAS antenna box as far as possible from the scanner (at least 15.24 cm. / 6 in.)
- Position the EAS antenna, EAS antenna box, EAS control cable, and EAS controller box as far as possible from the scanner's host and power cables.

Because EAS range is dependent on the Checkpoint system (calibrated onsite) as well as the scanner, estimated ranges can not be provided. However, the following factors influence EAS range:

- Antenna – length, gauge, number of turns, placement in the scanner
- Type of Checkpoint EAS system used (CP-VII, CP-IX, or CP-XI)
- Length of wire connecting antenna to EAS (site/installation dependent)
- Checkpoint system settings (site/installation dependent)

Checkpoint Contact Information

Contact your local Checkpoint representative to install the EAS cable to the Checkpoint Deactivation System.

Sensormatic EAS

Contact your local Sensormatic representative for installation information.

Maintenance, Troubleshooting, and Specifications

This section provides suggested scanner maintenance, troubleshooting, technical specifications, and connections (pinouts).

Maintenance

Known Harmful Ingredients

The following chemicals are known to damage the plastics on Zebra scanners and should not come in contact with the device:

- Acetone
- Ammonia solutions
- Aqueous or alcoholic alkaline solutions
- Aromatic and chlorinated hydrocarbons
- Benzene
- Carboic acid
- Compounds of amines or ammonia
- Ethanolamine
- Ethers
- Ketones
- TB-lysoform
- Toluene
- Trichloroethylene

Approved Cleaners

Isopropyl alcohol 70% (including pre-moistened wipes).

Cleaning the Scanner

Routinely cleaning the scan window is required. A dirty window may affect scanning accuracy. Do not allow any abrasive material to touch the window.

1. Dampen a soft cloth with one of the approved cleaning agents listed above or use pre-moistened wipes.
2. Gently wipe all surfaces, including the front, back, sides, top and bottom. Never apply liquid directly to the scanner. Be careful not to let liquid pool around the scan window, cable connectors, or any other area on the device.
3. Do not spray water or other cleaning liquids directly onto the scan window.
4. Wipe the scan window with a lens tissue or other material suitable for cleaning optical material such as eyeglasses.
5. Immediately dry the scan window after cleaning to prevent streaking.
6. Allow the unit to air dry before use.
7. Scanner connectors:
 - a) Dip the cotton portion of a cotton-tipped applicator in isopropyl alcohol.
 - b) Rub the cotton portion of the cotton-tipped applicator back-and-forth across the connectors at least three times. Do not leave any cotton residue on the connectors.
 - c) Use the cotton-tipped applicator dipped in alcohol to remove any grease and dirt near the connector area.
 - d) Use a dry cotton tipped applicator and rub the cotton portion of the cotton-tipped applicator back-and-forth across the connectors at least three times. Do not leave any cotton residue on the connectors.

Troubleshooting



NOTE: If, after performing the possible solutions in the following table, the scanner still experiences problems, contact the distributor or call support.

Table 12 Troubleshooting

Problem	Possible Cause	Possible Solution
The illumination does not appear when pressing the trigger.	No power to the scanner.	If the configuration requires a power supply, re-connect the power supply.
	Incorrect host interface cable is used.	Connect the correct host interface cable.
	Interface/power cables are loose.	Re-connect cables.

Table 12 Troubleshooting (Continued)

Problem	Possible Cause	Possible Solution
	Scanner is disabled.	For IBM 468x and USB IBM hand-held, IBM table-top, and OPOS modes, enable the scanner via the host interface. Otherwise, see the technical person in charge of scanning.
	If using RS-232 Nixdorf B mode, CTS is not asserted.	Assert CTS line.
Scanner emits illumination, but does not decode the barcode.	Scanner is not programmed for the correct barcode type.	Program the scanner to read that type of barcode. See Symbologies .
	Barcode symbol is unreadable.	Scan test symbols of the same barcode type to determine if the barcode is defaced.
	The symbol is not completely inside illumination.	Move the symbol completely within the illumination. Move the symbol completely within the field of view (AIM pattern does NOT define FOV).
	Distance between scanner and barcode is incorrect.	Move the scanner closer to or further from the barcode. See Decode Ranges .
Scanner decodes barcode, but does not transmit the data to the host.	Scanner is not programmed for the correct host type.	Scan the appropriate host type programming barcode. See the chapter corresponding to the host type.
	Interface cable is loose.	Re-connect the cable.
	If the scanner emits four long low beeps, a transmission error occurred. This occurs if a unit is not properly configured or connected to the wrong host type.	Set the scanner's communication parameters to match the host's setting.
	If the scanner emits 5 low beeps, a conversion or format error occurred.	Configure the scanner's conversion parameters properly.
	If the scanner emits low/high/low beeps, it detected an invalid ADF rule.	Program the correct ADF rules. Refer to the Advanced Data Formatting Programmer Guide.
Host displays scanned data incorrectly.	Scanner is not programmed to work with the host.	Scan the appropriate host type programming barcode.
		For RS-232, set the scanner's communication parameters to match the host's settings.
		For a Keyboard Wedge configuration, program the system for the correct keyboard type, and turn off the CAPS LOCK key.
		Program the proper editing options (for example, UPC-E to UPC-A Conversion).

Table 12 Troubleshooting (Continued)

Problem	Possible Cause	Possible Solution
Scanner emits short low/short medium/short high beep sequence (power-up beep sequence) more than once.	The USB bus may put the scanner in a state where power to the scanner is cycled on and off more than once.	Normal during host reset.
Scanner emits 4 short high beeps during decode attempt.	Scanner has not completed USB initialization.	Wait several seconds and scan again.
Scanner emits Low/low/low/extra low beeps when not in use.	RS-232 receive error.	Normal during host reset. Otherwise, set the scanner's RS-232 parity to match the host setting.
Scanner emits low/high beeps during programming.	Input error, incorrect barcode or Cancel barcode was scanned.	Scan the correct numeric barcodes within range for the parameter programmed.
Scanner emits low/high/low/high beeps during programming.	Out of host parameter storage space.	Scan Default Parameters .
	Out of memory for ADF rules.	Reduce the number of ADF rules or the number of steps in the ADF rules.
	During programming, indicates out of ADF parameter storage space.	Erase all rules and re-program with shorter rules.
Scanner emits low/high/low beeps.	ADF transmit error.	Refer to the Advanced Data Formatting Guide for information.
	Invalid ADF rule is detected.	Refer to the Advanced Data Formatting Guide for information.
Scanner emits a power-up beep after changing USB host type.	The USB bus re-established power to the scanner.	Normal when changing USB host type.
Scanner emits one high beep when not in use.	In RS-232 mode, a <BEL> character was received and Beep on <BEL> option is enabled.	Normal when Beep on <BEL> is enabled and the scanner is in RS-232 mode.
Scanner emits frequent beeps.	Inadequate power supplied to the scanner.	Check the system power. If the configuration requires a power supply, re-connect the power supply.
	Incorrect host interface cable is used.	Verify that the correct host interface cable is used. If not, connect the correct host interface cable.
	Interface/power cables are loose.	Check for loose cable connections and re-connect cables.
Scanner emits five long low beeps after a barcode is decoded.	Conversion or format error was detected. The scanner conversion parameters are not properly configured.	Ensure the scanner conversion parameters are properly configured.
	Conversion or format error was detected. An ADF rule was set up with characters that cannot be sent for the host selected.	Change the ADF rule, or change to a host that can support the ADF rule.
	Conversion or format error was detected. A barcode was scanned with characters that cannot be sent for that host.	Scan a different barcode, or change to a host that can support the barcode.

Table 12 Troubleshooting (Continued)

Problem	Possible Cause	Possible Solution
SP7208 emits a low-high-high-low beep sequence (may sound once every 10 seconds)	The attached aux scanner is drawing too much current.	Disconnect/Reconnect the aux scanner. If that doesn't solve the issue replace the aux scanner.
Scanner emits a high, low beeper sequence.	An unsupported USB device was plugged into the USB host port, and/or the device failed enumeration.	Disconnect the unsupported device.

Dump Scanner Parameters

To debug a scanner issue, scan the following bar code with the scanner connected in USB HID keyboard mode to Microsoft® Windows Notepad or Wordpad, or via RS-232 to Windows Hyperterminal. This outputs all the scanner's asset tracking information and parameter settings to a text document.

Refer to the parameter numbers to interpret the parameter/attribute numbers in the output.



NOTE: Use 123Scan if available as an alternative to using this feature. 123Scan is the preferable method for outputting scanner information.



NOTE: For proper formatting, it may be necessary to first scan `<DATA> <SUFFIX 1> (1)`

To select the timeout between decodes for the same symbol, scan the following barcode, and then scan two barcodes from [Numeric Barcodes](#) that correspond to the desired interval, in 0.1 second increments.

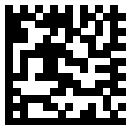

Technical Specifications

For device technical specifications, go to zebra.com/support.

Scanner to Host Connectors

The scanner includes a 10-pin RJ50 MOD connector for communication to a POS host.

Table 13 Scanner Signal Pinouts

Pin	IBM	RS-232	Keyboard Wedge	USB
1	Cable ID	Cable ID	Cable ID	Cable ID
2	Power (+5V)	Power (+5V)	Power (+5V)	Power (+5V)
3	Ground	Ground	Ground	Ground
4	IBM_OUT	TxD	KeyClock	Reserved
5	IBM_IN	RxD	TermData	D +

Table 13 Scanner Signal Pinouts (Continued)

Pin	IBM	RS-232	Keyboard Wedge	USB
6	IBM_T/R	RTS	KeyDat	Reserved
7	Reserved	CTS	TermClock	D -
8	Download input	Download input	Download input	Download input
9	Reserved	Reserved	Reserved	Reserved
10	Power (+12V)	Power (+12V)	Power (+12V)	Power (+12V)

Auxiliary USB Type A Connector

The scanner includes a USB host type A connector to support an auxiliary USB scanner. This connector supports a USB host connection with 500ma power supply support.

Table 14 USB Type A Auxiliary Scanner Port Pinouts

Pin 1	Pin 2	Pin 3	Pin 4
VCC	D -	D +	GND

EAS Connectors

The scanner includes a 10-pin RJ50 MOD connector to support:

- Checkpoint system antennas
- Checkpoint Interlock functionality
- Sensormatic system communication (antenna not included)



NOTE: The scanner supports only one EAS system at a time, either Checkpoint or Sensormatic.

Table 15 EAS Signal Pinouts

Pin	Function
1	EAS Interlock
2	No connection
3	Ground
4	Sensormatic RS-232 TXD
5	Sensormatic RS-232 RXD
6	Sensormatic RS-232 RTS
7	Sensormatic RS-232 CTS
8	No connection
9	EAS antenna
10	EAS antenna

USB Interface

This section describes how to set up the scanner with a USB host. The scanner connects directly to a USB host, or a powered USB hub, which powers it.

The scanner ships with the settings shown in [USB Parameter Defaults](#). If the default values suit requirements, programming is not necessary.

USB Interface Connection

The scanner connects to USB-capable hosts including:

- TGCS (IBM) terminals
- Apple™ desktop and notebooks
- Other network computers that support more than one keyboard.

The following operating systems support the scanner through USB:

- Windows® XP, 7, 8, 10
- MacOS 8.5 - MacOS 10.6
- TGCS (IBM) 4690/TCx Sky OS

The scanner also interfaces with other USB hosts that support USB Human Interface Devices (HID).

To connect the scanner to a USB host:

1. Connect the modular connector of the USB interface cable to the host port as described in [Installing Cables](#).
2. Plug the Type-A connector of cable in the USB host or hub or plug the 12V USB Powerplug connector in an available port of the IBM SurePOS or NCR POS terminal.
3. Optionally, connect a handheld auxiliary scanner to the aux port.

4. If connecting an auxiliary scanner, connect the power supply to the power port and an AC outlet.

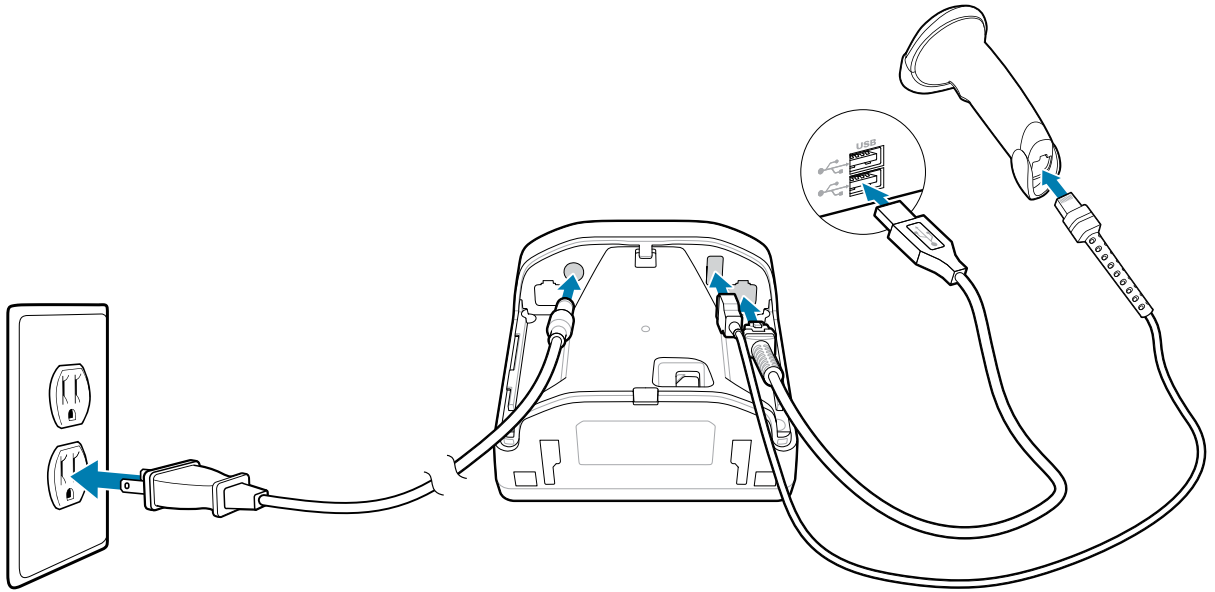

5. The scanner automatically detects the host and uses the default USB device type. If the default (*) does not meet your requirements, select another USB device type by scanning the appropriate barcode from [USB Device Type](#).
6. On first installation when using Windows, the software may prompt to select or install the Human Interface Device driver. To install this driver, provided by Windows, click **Next** at all choices and click **Finished** on the last choice. The scanner powers up during this installation.
7. To modify any other parameter options, scan the appropriate barcodes in this guide.

If problems occur with the system, see [Troubleshooting](#).

USB Parameter Defaults

The following table lists defaults for USB host parameters.

You can change default values in one of two ways:

- Scan the appropriate barcodes in this section. The new value replaces the standard default value in memory. To recall default parameter values, see [Default Parameters](#).
- Configure the scanner using the 123Scan configuration program. See [123Scan and Software Tools](#).

Table 16 USB Interface Parameter Defaults

Parameter	Default
USB Host Parameters	
USB Device Type	USB HID Keyboard
Symbol Native API (SNAPI) Status Handshaking	Enable
USB Keystroke Delay	No Delay
USB Caps Lock Override	Do Not Override Caps Lock Key (Disable)
Barcodes with Unknown Characters	Send Barcodes with Unknown Characters
USB Convert Unknown to Code 39	Disable
USB Fast HID	Enable
USB Polling Interval	3 msec
Keypad Emulation	Enable
Quick Keypad Emulation	Enable
Keypad Emulation with Leading Zero	Enable
USB Keyboard FN1 Substitution	Disable
Function Key Mapping	Disable
Simulated Caps Lock	Disable
Convert Case	No Case Conversion
USB Static CDC	Enable
CDC Beep on <BEL>	Enable
USB CDC Host Variant	Standard USB CDC
TGCS (IBM) USB Direct I/O Beep	Honor
USB IBM Long Direct I/O	Disable
TGCS (IBM) USB Beep Directive	Ignore
TGCS (IBM) USB Barcode Configuration Directive	Ignore
TGCS (IBM) USB Specification Version	Version 2.2
Product ID (PID) Type	Host Type Unique
Product ID (PID) Value	N/A

Table 16 USB Interface Parameter Defaults (Continued)

Parameter	Default
EC Level	N/A
4690 Flash Update	Enable

USB Device Type

You can scan one of the following barcodes to select the USB device type.

- When changing USB device types, the scanner resets and issues the standard startup beep sequences.
- When connecting two scanners to a host, IBM does not allow selecting two of the same device type. If you require two connections, select an IBM Table-top USB for one scanner and an IBM Hand-held USB for the second scanner.
- Select OPOS (IBM Hand-held with Full Disable) to completely shut off the scanner when an IBM register issues a Scan Disable command, including aim, illumination, decoding, and data transmission.
- Before selecting USB CDC Host, ensure your host OS has a USB CDC driver installed. For reference, Windows 10 includes a native (built-in) USB CDC driver. To recover a scanner stalled (non-functional) in USB CDC mode: Either install a USB CDC Driver or after power-up, hold the trigger for 10 seconds (which allows the scanner to recover), then scan another USB Device Type barcode.
- Select USB HID POS to communicate over a USB cable with Microsoft's Universal Windows Platform (UWP) applications running on Windows 10 devices.



*USB HID Keyboard

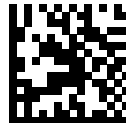

IBM Table-top USB



IBM Hand-held USB

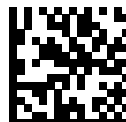

OPOS (IBM Hand-held with Full Disable)



USB CDC Host

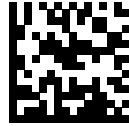

SSI over USB CDC



Symbol Native API (SNAPI) without Imaging Interface



Symbol Native API (SNAPI) with Imaging Interface



USB HID POS (for Windows 10 devices only)

Symbol Native API (SNAPI) Status Handshaking

After selecting a SNAPI interface as the USB device type, select an option to enable or disable status handshaking.



*Enable SNAPI Status Handshaking



Disable SNAPI Status Handshaking

USB Keystroke Delay

This parameter sets the delay, in milliseconds, between emulated keystrokes. Select a longer delay for hosts that require slower data transmission.



*No Delay

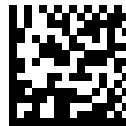

Medium Delay (20 msec)



Long Delay (40 msec)

USB Caps Lock Override

This option applies only to the USB HID Keyboard device. Select Override Caps Lock Key to preserve the case of the data regardless of the state of the Caps Lock key. This setting is always enabled for the Japanese Windows (ASCII) keyboard type and cannot be disabled.



Override Caps Lock Key (Enable)



*Do Not Override Caps Lock Key (Disable)

USB Barcodes with Unknown Characters

This option applies only to the USB HID Keyboard and IBM devices. Unknown characters are characters the host does not recognize. Select Send Barcodes With Unknown Characters to send all barcode data except for unknown characters. The scanner issues no error beeps.

Select Do Not Send Barcodes With Unknown Characters for IBM devices to prevent sending barcodes containing at least one unknown character to the host, or for USB HID Keyboard devices to send the barcode characters up to the unknown character. The scanner issues an error beep.



*Send Barcodes with Unknown Characters



Do Not Send Barcodes with Unknown Characters

USB Convert Unknown to Code 39

This option applies only to the IBM hand-held, IBM table-top, and OPOS devices. Select an option to enable or disable converting unknown barcode type data to Code 39.



Enable Convert Unknown to Code 39



*Disable Convert Unknown to Code 39

USB Fast HID

Select Enable USB Fast HID to transmit USB HID data at a faster rate.



NOTE: Disable this if there are problems with transmission.



*Enable USB Fast HID



Disable USB Fast HID

USB Polling Interval

Select an option to set the polling interval, which is the rate at which data transmits between the scanner and host computer. A lower number indicates a faster data rate.



NOTE: When changing the USB polling interval, the scanner restarts and issues a power-up beep sequence.



IMPORTANT: Ensure the host supports the selected data rate.



1 msec



2 msec



*3 msec



4 msec



5 msec

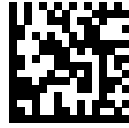

6 msec



7 msec

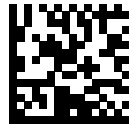

8 msec



9 msec



10 msec

Keypad Emulation

Select Enable Keypad Emulation to send all characters as ASCII sequences over the numeric keypad. For example, ASCII A transmits as “ALT make” 0 6 5 “ALT Break”.



NOTE: If your keyboard type is not listed in the country code list (see [Country Codes](#)), disable [Quick Keypad Emulation](#) and enable Keypad Emulation.



*Enable Keypad Emulation



Disable Keypad Emulation

USB Quick Keypad Emulation

Enable Quick Keypad Emulation for a quick method of emulation using the numeric keypad where ASCII sequences are only sent for ASCII characters not found on the keyboard.



NOTE: Quick Keypad Emulation only applies to the USB HID Keyboard device when Keypad Emulation is enabled.



*Enable Quick Keypad Emulation

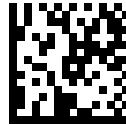

Disable Quick Keypad Emulation

Keypad Emulation with Leading Zero

Select Enable Keypad Emulation with Leading Zero to send character sequences sent over the numeric keypad as ISO characters which have a leading zero. For example, ASCII A transmits as “ALT MAKE” 0 0 6 5 “ALT BREAK”.



NOTE: This parameter only applies if [Emulate Keypad](#) is enabled.



*Enable Keypad Emulation with Leading Zero



Disable Keypad Emulation with Leading Zero

USB Keyboard FN1 Substitution

This option applies code 128 and ISBT 128 to the USB HID Keyboard device. Scan Enable USB Keyboard FN1 Substitution to replace any FN1 character in a GS1 128 barcode with a user-selected Key Category and value.

See [FN1 Substitution Values](#) to set the Key Category and Key Value.



Enable USB Keyboard FN1 Substitution



*Disable USB Keyboard FN1 Substitution

USB Function Key Mapping

ASCII values under 32 are normally sent as a control-key sequence (see [ASCII Character Sets](#)). Select **Enable Function Key Mapping** to send the keys in bold in place of the standard key mapping. Table entries that do not have a bold equivalent remain the same regardless of whether you enable this parameter.



Enable Function Key Mapping



*Disable Function Key Mapping

USB Simulated Caps Lock

Select Enable Simulated Caps Lock to invert upper and lower case characters on the barcode as if the Caps Lock state is enabled on the keyboard. This inversion occurs regardless of the keyboard's Caps Lock state.



NOTE: Simulated Caps Lock applies to ASCII characters only. Do not enable this if [Caps Lock Override](#) is enabled.



Enable Simulated Caps Lock



*Disable Simulated Caps Lock

USB Convert Case

Use this parameter to convert all of the barcode data to the selected case.



NOTE: Convert Case applies to ASCII characters only.



*No Case Conversion



Convert All to Upper Case



Convert All to Lower Case

USB Static CDC

Parameter # 670

You can connect devices to the same COM port or different COM ports.

When disabled, each device connected consumes another COM port (first device = COM1, second device = COM2, third device = COM3, etc.)

When enabled, each device connects to the same COM port.



*Enable USB Static CDC (1)



Disable USB Static CDC (0)

CDC Beep on <BEL>

Parameter # 150

If you enable this parameter, the scanner issues a beep when it detects a <BEL> character in USB CDC communications. <BEL> indicates an illegal entry or other important event.



*Enable CDC Beep on <BEL>



Disable CDC Beep on <BEL>

USB CDC Host Variant

Parameter # 1713

When USB Device Type is set to USB CDC Host, the CDC Host Variant selects which type of CDC variant is used. The default USB CDC host variant is Standard CDC Host Mode.



*Standard USB CDC (0)



CDC SITA (1)



NCR USB CDC (9)

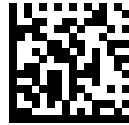

NCR USB CDC Datalogic (10)

TGCS (IBM) USB Direct I/O Beep

Parameter # 1360

The host can send a direct I/O beep request to the scanner. If you select Ignore Direct I/O Beep, the scanner does not sound beeps on this command. All directives are still acknowledged to the USB host as if they were processed.



*Honor Direct I/O Beep



Ignore Direct I/O Beep

USB IBM Long Direct IO

Parameter # 1147

Use this option to enable or disable USB IBM Long Direct IO.



*Disable (0)



Enable (1)

TGCS (IBM) USB Beep Directive

The host can send a beeper configuration request to the scanner. Scan Ignore Beep Directive to prevent the scanner from processing the host request. All directives are still acknowledged to the USB host as if they were processed.



Honor Beep Directive

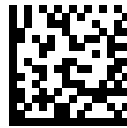

*Ignore Beep Directive

TGCS (IBM) USB Barcode Configuration Directive

The host can enable and disable code types. Scan Ignore Barcode Configuration Directive to prevent the scanner from processing the host request. All directives are still acknowledged to the USB host as if they were processed.



Honor Barcode Configuration Directive

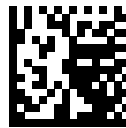

*Ignore Barcode Configuration Directive

TGCS (IBM) USB Specification Version

Parameter # 1729

You can specify code types as unknown or specify the code types with an appropriate IBM identifier.

Select IBM Specification Level (Original) to send the following code types as Unknown:

- Data Matrix
- GS1 Data Matrix
- QR Code
- GS1 QR
- MicroQR Code
- Aztec

Select IBM Specification Level Version 2.2 to send the code types with the appropriate IBM identifiers.



IBM Specification Level (Original)

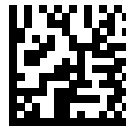

*IBM Specification Level Version 2.2 or higher

Product ID (PID) Type

Parameter # 1281 (SSI # F8h 05h 01h)

This parameter defines the PID value reported in USB enumeration.



*Host Type Unique (0)

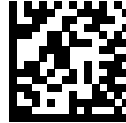

Product Unique (1)



IBM Unique (2)

Product ID (PID) Value

Parameter # 1725 (SSI # F8h 06h BDh)

This parameter sets a Product ID (PID) value.



NOTE: This parameter applies to customers using a Firmware Flash Update per the Toshiba Global Commerce Solutions (TGCS) Universal Serial Bus OEM Point-of-Sale Device Interface.

To set a Product ID value, scan Set PID Value, and then scan four numeric barcodes in [Numeric Barcodes](#) that correspond to the value. Enter a leading zero for single-digit numbers. To correct an error, or change a selection, scan [Cancel](#). The range is (0, 1600 - 1649).



Set PID Value

ECLevel

Parameter # 1710 (SSI # F8h 06h AEh)

This parameter sets an ECLevel.



NOTE: This parameter applies to customers using a Firmware Flash Update per the Toshiba Global Commerce Solutions (TGCS) Universal Serial Bus OEM Point-of-Sale Device Interface. It allows defining an ECLevel value to manage and control Flash Update operations on the 4690 operating system.

Contact Zebra Support at zebra.com/support for more information.

To set an ECLevel value, scan Set ECLevel, and then scan five numeric barcodes in [Numeric Barcodes](#) that correspond to the desired level. Enter a leading zero for single digit numbers. To correct an error, or change a selection, scan [Cancel](#).



Set ECLevel

4690 Flash Update

Parameter # 1727 (SSI # F8h 06h BFh)

Enable users to manage and control Zebra scanner devices in the 4690/TCx Sky OS Firmware Flash Update per the Toshiba Global Commerce Solutions (TGCS) Universal Serial Bus OEM Point-of-Sale Device Interface.



Disable (0)



*Enable (1)

USB ASCII Character Sets

See [ASCII Character Sets](#) for the following information:

- [ASCII Character Sets](#)
- [ALT Key Character Set](#)
- [GUI Key Character Set](#)
- [PF Key Character Set](#)
- [F Key Character Set](#)
- [Numeric Key Character Set](#)
- [Extended Key Character Set](#)

RS-232 Interface

The scanner supports the RS-232 interface to connect to point-of-sale devices, host computers, or other devices with an available RS-232 port (for example, com port).

The scanner ships with the settings shown in [RS-232 Interface Parameter Defaults](#). If the default values suit requirements, programming is not necessary.

If your host does not appear in [RS-232 Host-Specific Settings](#), refer to the documentation for the host device to set communication parameters to match the host.



NOTE: The scanner uses TTL RS-232 signal levels, which interface with most system architectures. For system architectures requiring RS-232C signal levels, Zebra offers different cables providing TTL-to-RS-232C conversion. Contact support for more information.

RS-232 Interface Connection

To connect to an RS-232 host:

1. Attach the modular connector of the RS-232 interface cable to the SP72 host port as described in [Installing Cables](#).
2. Connect the other end of the RS-232 interface cable to the serial port on the host.
3. Optionally connect a hand-held auxiliary scanner to the aux port.
4. If connecting an auxiliary scanner, connect the power supply to the power port and an AC outlet.

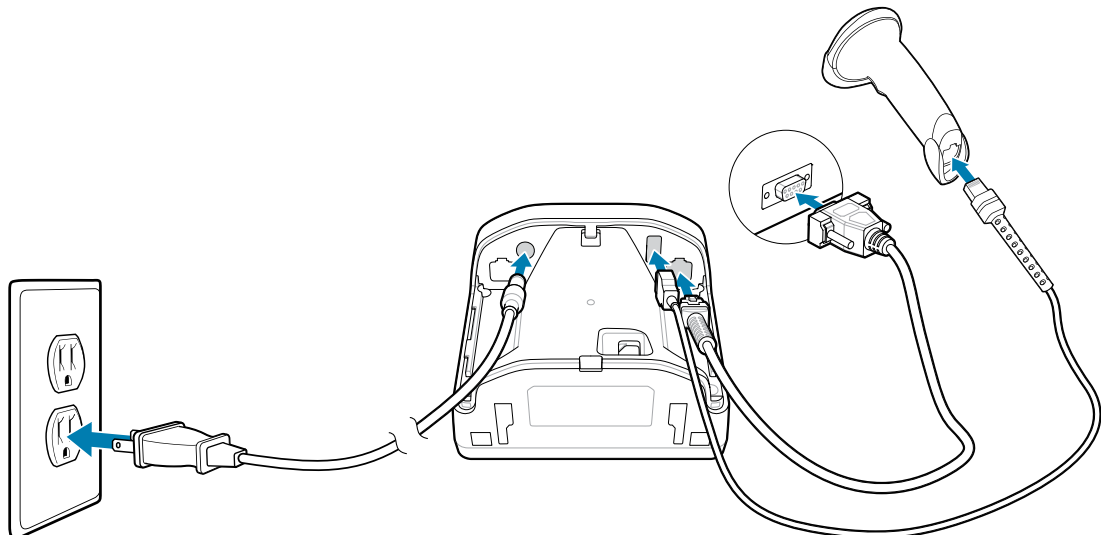

5. The scanner automatically detects the host interface type and uses the default setting. If the default (*) does not meet your requirements, select another RS-232 host type by scanning the appropriate barcode from [RS-232 Host Types](#).
6. To modify any other parameter options, scan the appropriate barcodes in this guide.

If problems occur with the system, see [Troubleshooting](#).

RS-232 Parameter Defaults

The following table lists defaults for RS-232 host parameters.

You can change default values in one of two ways:

- Scan the appropriate barcodes in this chapter. The new value replaces the standard default value in memory. To recall default parameter values, see [Default Parameters](#).
- Configure the scanner using the 123Scan configuration program. See [123Scan and Software Tools](#).

Table 17 RS-232 Interface Parameter Defaults

Parameter	Default
RS-232 Host Parameters	
RS-232 Host Types	Standard
Baud Rate	9600
Parity	None
Stop Bits	1 Stop Bit
Data Bits	8-bit
Check Receive Errors	Enable
Hardware Handshaking	None
Software Handshaking	None
Host Serial Response Timeout	2 Seconds
RTS Line State	Low RTS
Beep on <BEL>	Disable
Intercharacter Delay	0 msec
Nixdorf Beep/LED Options	Normal Operation
Barcodes with Unknown Characters	Send Barcode With Unknown Characters
Datalogic Host Format	Enable
Datalogic Supported Commands	None
NCR Enable/Disable Alternate Beep Volume for Not on File Event	Disable
NCR Not on File Beeper Volume	Low Volume
NCR Use Prefix	Enable
NCR Prefix	1002 (STX)
NCR Suffix	1003 (ETX)
NCR Use Block Check Character	Enable
NCR 2D Label-ID Mode	NCR Mode

RS-232 Host-Specific Parameter Settings

Some RS-232 hosts use their own parameter default settings.

You can select standard, ICL, Fujitsu, Wincor-Nixdorf Mode A or B, OPOS/JPOS, Olivetti, Omron, Common Use Terminal Equipment (CUTE-LP/LG barcode readers), NCR, or Datalogic and set the appropriate default.

Table 18 RS-232 Host-Specific Settings

Parameter	ICL	Fujitsu	Wincor-Nixdorf Mode A	Wincor-Nixdorf Mode B/OPOS/JPOS
Baud Rate	9600	9600	9600	9600
Parity	Even	None	Odd	Odd
Stop Bits	One	One	One	One
Data Bits	8-bit	8-bit	8-bit	8-bit
Hardware Handshaking	RTS/CTS Option 3	None	RTS/CTS Option 3	RTS/CTS Option 3
Software Handshaking	None	None	None	None
Serial Response Timeout	9.9 Seconds	2 Seconds	None	None
RTS Line State	High	Low	Low	Low = No data to send
Beep On <BEL>	Disable	Disable	Disable	Disable
Transmit Code ID	Yes	Yes	Yes	Yes
Data Transmission Format	Data/Suffix	Data/Suffix	Data/Suffix	Data/Suffix
Prefix	None	None	None	None
Suffix	CR (1013)	CR (1013)	CR (1013)	CR (1013)

In the Wincor-Nixdorf Mode A/B, when CTS is low, scanning is disabled and when CTS is high, scanning is enabled. If you scan Wincor-Nixdorf RS-232 Mode A/B without connecting the scanner to the proper host, it may appear unable to scan. In this case, scan a different RS-232 host type within 5 seconds of cycling power to the scanner.

Table 19 RS-232 Host-Specific Settings

Parameter	Olivetti	Omron	CUTE	NCR	Datalogic
Baud Rate	9600	9600	9600	9600	9600
Parity	Even	None	Even	Odd	Odd
Stop Bits	One	One	One	One	One
Data Bits	7-bit	8-bit	7-bit	7-bit	7-bit
Hardware Handshaking	None	None	None	None	None
Software Handshaking	ACK/NAK	None	None	None	None
Serial Response Timeout	9.9 Seconds	9.9 Seconds	9.9 Seconds	9.9 Seconds	9.9 Seconds

Table 19 RS-232 Host-Specific Settings (Continued)

Parameter	Olivetti	Omron	CUTE	NCR	Datalogic
RTS Line State	Low	High	High	High	High
Beep On <BEL>	Disable	Disable	Disable	Disable	Enable
Transmit Code ID	Yes	Yes	Yes	Yes	Yes
Data Transmission Format	Prefix/Data/Suffix	Data/Suffix	Prefix/Data/Suffix	Prefix/Suffix*	Data/Suffix
Prefix	STX (1003)	None	STX (1002)	STX *	None
Suffix	ETX (1002)	CR (1013)	CR (1013) ETX (1003)	ETX *	CR (1013)

The CUTE host disables all parameter scanning, including Set Defaults. If you inadvertently select CUTE, scan [Enable Parameter Barcode Scanning](#), and then change the host selection.

RS-232 Host-Specific Code ID Characters

RS-232 hosts have code ID characters that are transmitted automatically.

RS-232 hosts ICL, Fujitsu, Nixdorf Mode A or B, OPOS/JPOS, Olivetti, Omron, CUTE, NCR, or Datalogic transmit code ID characters. These characters are not programmable and are separate from the Transmit Code ID feature. Do not enable the Transmit Code ID feature for these hosts.

Table 20 RS-232 Host-Specific Code ID Characters

Code Type	ICL	Fujitsu	Wincor-Nixdorf Mode A	Wincor-Nixdorf Mode B/OPOS/JPOS
UPC-A	A	A	A	A
UPC-E	E	E	C	C
EAN-8/JAN-8	FF	FF	B	B
EAN-13/JAN-13	F	F	A	A
Bookland EAN	F	F	A	A
Code 128	L <len>	None	K	K
GS1-128	L <len>	None	P	P
Code 39	C <len>	None	M	M
Code 39 Full ASCII	None	None	M	M
Trioptic	None	None	None	None
Code 32	None	None	None	None
Code 93	None	None	L	L
I 2 of 5	I <len>	None	I	I
D 2 of 5	H <len>	None	H	H
IATA	H<len>	None	H	H

Table 20 RS-232 Host-Specific Code ID Characters (Continued)

Code Type	ICL	Fujitsu	Wincor-Nixdorf Mode A	Wincor-Nixdorf Mode B/OPOS/JPOS
Codabar	N <len>	None	N	N
MSI	None	None	O	O
GS1 DataBar Variants	None	None	E	E
PDF417	None	None	Q	Q
MicroPDF417	None	None	S	S
Data Matrix	None	None	R	R
GS1 Data Matrix	None	None	W	W
Maxicode	None	None	T	T
QR Code	None	None	U	U
GS1 QR	None	None	X	X
Aztec/Aztec Rune	None	None	V	V

Table 21 RS-232 Host-Specific Code ID Characters

Code Type	Olivetti	Omron	CUTE	NCR	Datalogic
UPC-A	A	A	A	A	A
UPC-E	C	E	None	E	E
EAN-8/JAN-8	B	FF	None	FF	FF
EAN-13/JAN-13	A	F	A	F	F
Bookland EAN	A	F	None	F	None
Code 128	K <len>	L <len>	5	B3	#
GS1-128	P <len>	L <len>	5	JC1	None
Code 39	M <len>	C <len>	3	B1	*
Code 39 Full ASCII	None	None	3	None	None
Trioptic	None	None	None	None	\$T
Code 32	None	None	None	A	AE
Code 93	L <len>	None	None	JG0	&
I 2 of 5	I <len>	I <len>	1	B2	i
D 2 of 5	H <len>	H <len>	2	None	None
IATA	H<len>	H<len>	2	None	IA
Codabar	N <len>	N <len>	None	N	%
MSI	O <len>	None	None	None	@

Table 21 RS-232 Host-Specific Code ID Characters (Continued)

Code Type	Olivetti	Omron	CUTE	NCR	Datalogic
GS1 DataBar Variants	None	None	None	j0	DataBar-R4 DataBar Limited: RL DataBar Expanded: RX
PDF417	None	None	6	jL2*	P
MicroPDF417	None	None	6	jL2*	mP
Data Matrix	None	None	4	jd0*	Dm
QR Code	None	None	7	jQ0	QR
Aztec/Aztec Rune	None	None	8	jz0	Az

RS-232 Host Types

Select an RS-232 host interface using one of the following options.

Notes on using RS-232 host types:

- For a list of supported scanner functionality by communication protocol, see [Communication Protocol Functionality](#).
- Scanning Standard RS-232 activates the RS-232 driver, but does not change port settings (for example, parity, data bits, handshaking). Selecting another RS-232 host type barcode changes these settings.
- The CUTE host disables all parameter scanning, including Set Defaults. If you inadvertently select CUTE, scan [Enable Parameter Barcode Scanning](#), and then change the host selection.



*Standard RS-232



ICL RS-232



Nixdorf RS-232 Mode A



Nixdorf RS-232 Mode B



Olivetti ORS4500



Omron



OPOS/JPOS



Fujitsu RS-232



CUTE



NCR



Datalogic Variant

RS-232 Baud Rate

The RS-232 baud rate is the number of bits of data transmitted per second.

Select an option to set the scanner's baud rate to match the baud rate setting of the host device. Otherwise, data may not reach the host device or may reach it in distorted form.



* Baud Rate 9600

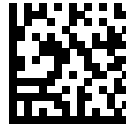

Baud Rate 19,200



Baud Rate 38,400

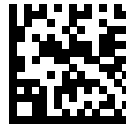

Baud Rate 57,600



Baud Rate 115,200



Baud Rate 230,400



Baud Rate 460,800



Baud Rate 921,600

RS-232 Parity

A parity check bit is the most significant bit of each ASCII coded character. Choose an option to select the parity type according to host device requirements.

- Odd - This sets the parity bit value to 0 or 1, based on data, to ensure that the coded character contains an odd number of 1 bits.
- Even - This sets the parity bit value to 0 or 1, based on data, to ensure that the coded character contains an even number of 1 bits.
- None - No parity bit is required.



Odd



Even



*None

RS-232 Stop Bits

The stop bit(s) at the end of each transmitted character marks the end of transmission of one character and prepares the receiving device for the next character in the serial data stream. Select an option to set the number of stop bits (one or two) based on the number the receiving host can accommodate.



*1 Stop Bit



2 Stop Bits

Data Bits

This parameter allows the scanner to interface with devices requiring a 7-bit or 8-bit ASCII protocol.



7-Bit



*8-Bit

Check Receive Errors

This parameter determines whether to check the parity, framing, and overrun of received characters.



NOTE: The parity value of received characters is verified against the value set for [Parity](#).



*Check For Received Errors

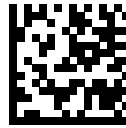

Do Not Check For Received Errors

Hardware Handshaking

The data interface consists of an RS-232 port designed to operate either with or without the hardware handshaking lines Request to Send (RTS) and Clear to Send (CTS).

If hardware handshaking and software handshaking are both enabled, hardware handshaking takes precedence.



NOTE: The DTR signal is jumpered to the active state.

You can choose one of the following options:

None

This disables hardware handshaking and transmits scan data as it becomes available.

Standard RTS/CTS

This sets standard RTS/CTS hardware handshaking and transmits scanned data. The scanner reads the CTS line for activity according to the following sequence:

- If the CTS line is de-asserted, the scanner asserts the RTS line and waits up to [Host Serial Response Timeout](#) for the host to assert CTS, and then transmits data when asserted. If, after the timeout, the CTS line is not asserted, the scanner sounds a transmit error and discards the data.
- If CTS is asserted, the scanner waits up to [Host Serial Response Timeout](#) for the host to de-assert CTS. If after this timeout the CTS line is still asserted, the scanner sounds a transmit error and discards the scanned data.
- The scanner de-asserts RTS after sending the last character of data.
- The host negates CTS. The scanner checks for a de-asserted CTS upon the next data transmission.



NOTE: During data transmission, if CTS is deasserted for more than 50 ms between characters, the scanner sounds a transmit error and discards the data. The data must be re-scanned.

RTS/CTS Option 1

The scanner asserts RTS before transmitting and ignores the state of CTS. The scanner de-asserts RTS when transmission completes.

RTS/CTS Option 2

RTS is always high or low (user-programmed logic level). However, the scanner waits for the host to assert CTS before transmitting data. If CTS is not asserted within the [Host Serial Response Timeout](#), the scanner sounds a transmit error and discards the data. During data transmission, if CTS is deasserted for more than 50 ms between characters, the scanner sounds a transmit error and discards the data.

RTS/CTS Option 3

This transmits scanned data according to the following sequence:

- The scanner asserts RTS before data transmission, regardless of the state of CTS.
- The scanner waits up to the [Host Serial Response Timeout](#) for the host to assert CTS, and then transmits data when asserted. If, after the timeout, the CTS line is not asserted, the scanner sounds a transmit error and discards the data.
- The scanner de-asserts RTS after sending the last character of data.
- The host negates CTS. The scanner checks for a de-asserted CTS upon the next data transmission.



NOTE: During data transmission, if CTS is deasserted for more than 50 ms between characters, the scanner sounds a transmit error and discards the data. The data must be re-scanned.



*None



Standard RTS/CTS



RTS/CTS Option 1



RTS/CTS Option 2



RTS/CTS Option 3

Software Handshaking

This parameter offers control of data transmission in addition to, or instead of, that offered by hardware handshaking. If software handshaking and hardware handshaking are both enabled, hardware handshaking takes precedence.

- None - This transmits data immediately. The scanner expects no response from the host.
- ACK/NAK - After transmitting data, the scanner waits for an ACK or NAK response from the host. If it receives a NAK, the scanner transmits the data again and waits for an ACK or NAK. After three unsuccessful attempts to send data after receiving NAKs, the scanner sounds a transmit error and discards the data. The scanner waits up to the programmable [Host Serial Response Timeout](#) to receive an ACK or NAK. If the scanner does not get a response in this time, it sounds a transmit error and discards the data. There are no reattempts.
- ENQ - The scanner waits for an ENQ character from the host before transmitting data. If it does not receive an ENQ within the [Host Serial Response Timeout](#), the scanner sounds a transmit error and discards the data. The host must transmit an ENQ character at least every [Host Serial Response Timeout](#) to prevent transmission errors.
- ACK/NAK with ENQ - This combines the two previous options. An additional ENQ is not required to retransmit data due to a NAK from the host.
- XON/XOFF - An XOFF character stops data transmission until the scanner receives an XON character. There are two situations for XON/XOFF:
 - The scanner receives an XOFF before it has data to send. When the scanner has data, it waits up to the [Host Serial Response Timeout](#) for an XON character before transmitting. If it does not receive the XON within this time, the scanner sounds a transmit error and discards the data.
 - The scanner receives an XOFF during data transmission and stops transmission after sending the current byte. When the scanner receives an XON character, it sends the rest of the data. The scanner waits indefinitely for the XON.



*None



ACK/NAK



ENQ

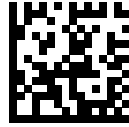

ACK/NAK with ENQ



XON/XOFF

RS-232 Host Serial Response Timeout

This parameter specifies how long the scanner waits for an ACK, NAK, or CTS before determining that a transmission error occurred. This only applies when in one of the ACK/NAK software handshaking modes, or RTS/CTS hardware handshaking mode.



*Minimum: 2 Seconds



Low: 2.5 Seconds



Medium: 5 Seconds



High: 7.5 Seconds



Maximum: 9.9 Seconds

RTS Line State

This parameter sets the idle state of the serial host RTS line to Low RTS or High RTS.



*Host: Low RTS

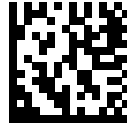

Host: High RTS

Beep on <BEL>

This parameter sets whether the scanner issues a beep when it detects a <BEL> character on the RS-232 serial line. <BEL> indicates an illegal entry or another important event.



Beep On <BEL> Character (Enable)



*Do Not Beep On <BEL> Character (Disable)

Intercharacter Delay

This parameter specifies the intercharacter delay inserted between character transmissions.



*Minimum: 0 msec



Low: 25 msec



Medium: 50 msec

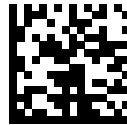

High: 75 msec



Maximum: 99 msec

Nixdorf Beep/LED Options

If you selected Nixdorf Mode B, scan one of the following barcodes to indicate when the scanner beeps and turns on its LED after a decode.



*Normal Operation (Beep/LED Immediately After Decode)



Beep/LED After Transmission



Beep/LED After CTS Pulse

RS-232 Barcodes with Unknown Characters

Unknown characters are characters the host does not recognize. Select Send Barcodes With Unknown Characters to send all barcode data except for unknown characters. The scanner issues no error beeps.

Select Do Not Send Barcodes With Unknown Characters to send barcode data up to the first unknown character. The scanner issues an error beep.



*Send Barcodes With Unknown Characters



Do Not Send Barcodes With Unknown Characters

Datalogic Host Format

Parameter # 2253 (SSI # F8 08 CD)

When this parameter is enabled (default), the Datalogic host variant appends a code ID and a suffix value (CR) to the decoded data. When this parameter is disabled, only the decode data is transmitted. These commands are supported over RS232 or USB CDC.



*Enable (1)



Disable (0)

Datalogic Supported Commands

Parameter # 2260 (SSI # F8 08 D4)

This parameter allows serial scan to enable or disable commands for a standard RS232 host.

- 'E' or 'e' = Enable Scanning
- 'D' or 'd' = Disable Scanning
- 'R' = Reset the scanner
- 'F' = Indicate to the scanner that Datalogic is not on file
- 'B' = Issue a good read beep
- 1 (Not an ASCII Character – This is a decimal number 1) = Force a good read beep
- 7 (Not an ASCII Character – This is a decimal number 7) = Force a good read beep



Enable (1)



*Disable (0)

NCR Host Preferences

If you select NCR as an RS-232 Host Type, you can choose select parameters for communications.

NCR Enable/Disable Alternate Beep Volume for Not on File Event

Parameter # 2384

Controls the ability to adjust beep volume for a not on file event. The default is disable.



*Disable



Enable

NCR Not on File Beeper Volume

Parameter # 2383

Sets the beeper volume for not on file events to Low, Medium, or High. The default is Low Volume.



NOTE: [Enable / Disable Alternate Beep Volume for Not on File Event](#) must be enabled for this parameter to function.



*Low Volume (02)



Medium Volume (01)



High Volume (00)

NCR Use Prefix

Parameter # 1238

You can enable or disable NCR using the prefix.

If you selected NCR from [RS-232 Host Types](#), use this parameter to enable or disable using the prefix for all communications.



*Enable NCR Use Prefix (1)

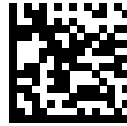

Disable NCR Use Prefix (0)

NCR Prefix

Parameter # 1282

You can set the prefix character to use if you enabled NCR.

If you selected NCR from [RS-232 Host Types](#) and enabled [NCR Use Prefix](#), set the prefix character to use for all communications.

To do this, scan the following barcode, and then scan four numeric barcodes from [Numeric Barcodes](#) that correspond to the desired character in [NCR Use Prefix](#). The default is 1002 (STX).



NCR Prefix

NCR Suffix

Parameter # 1283

You can set the suffix (terminator) character to use if you enabled NCR.

If you selected NCR from [RS-232 Host Types](#), set the suffix (terminator) character to use for all communications.

To do this, scan the following barcode, and then scan four numeric barcodes from [Numeric Barcodes](#) that correspond to the desired character in [ASCII Character Sets](#). The default is 1003 (ETX).



NCR Suffix

NCR Use Block Check Character (BCC)

Parameter # 1239

You can enable Block Check Character if you enabled NCR.

If you selected NCR from [RS-232 Host Types](#), use this parameter to enable or disable using the Block Check Character (after the Terminator byte) for all communications.



*Enable NCR Use BCC (1)



Disable NCR Use BCC (0)

NCR 2D Label-ID Mode

Parameter # 1948

Select an NCR 2D Label-ID mode for the defined bar code prefix type.

- NCR Mode - Adds an NCR prefix to a bar code. This is the default.
- Legacy Mode - Adds an non-NCR prefix to a bar code.
- Suppress Mode - No prefix is added to a bar code.



* NCR Mode (0)

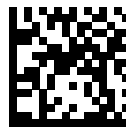

Legacy Mode (1)



Suppress Mode (2)

RS-232 ASCII Character Sets

You can refer to the ASCII Character Sets for prefix and suffix values.

See [ASCII Character Sets](#) for prefix/suffix values.

IBM 468X/469X Interface

This section describes how to set up the scanner with an IBM 468X/469X host.

The scanner ships with the settings shown in [IBM 468X/469X Interface Parameter Defaults](#). If the default values suit requirements, programming is not necessary.

IBM 468X/469X Interface Connection

To connect the scanner to the IBM host computer:

1. Attach the modular connector of the IBM 46XX interface cable to the host port as described in [Installing Cables](#).
2. Connect the other end of the IBM 46XX interface cable to the appropriate port on the host (typically Port 9).
3. Optionally connect a hand-held auxiliary scanner to the aux port.
4. If connecting an auxiliary scanner, connect the power supply to the power port and an AC outlet.

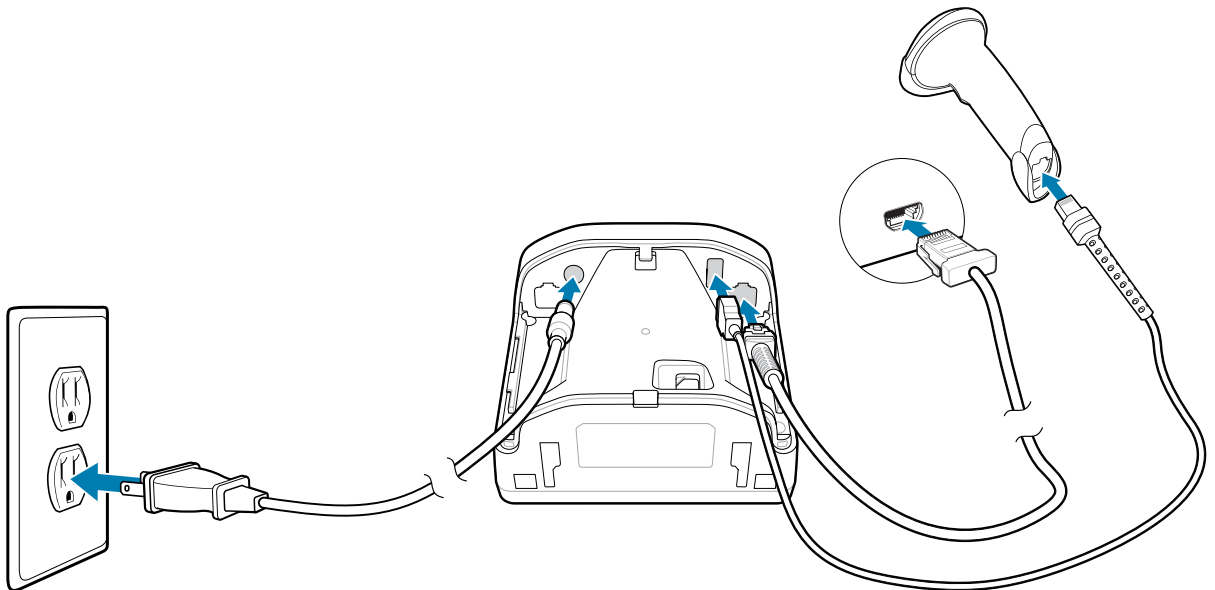

5. The scanner automatically detects the host interface type, but there is no default setting. Scan the appropriate barcode from [Port Address](#) to select the port address.

6. To modify any other parameter options, scan the appropriate barcodes in this guide.



NOTE: The only required configuration is the port address. The IBM system typically controls other scanner parameters.

If problems occur with the system, see [Troubleshooting](#).

IBM Parameter Defaults

The IBM 468X/469X Interface Parameter defaults table lists defaults for IBM host parameters.

Change these values in one of two ways:

- Scan the appropriate barcodes in this chapter. The new value replaces the standard default value in memory. To recall default parameter values, see [Default Parameters](#).
- Configure the scanner using the 123Scan configuration program. See [123Scan and Software Tools](#).

Table 22 IBM 468X/469X Interface Parameter Defaults

Parameter	Default
IBM 468X/469X Host Parameters	
Port Address	None
Convert Unknown to Code 39	Disable
RS-485 Beep Directive	Ignore
RS-485 Barcode Configuration Directive	Ignore
IBM-485 Specification Version	Original Specification

IBM Host Parameters

Port Address

This parameter selects the IBM 468X/469X port.



NOTE: Selecting a Port Address barcode enables the RS-485 interface on the device.



*None

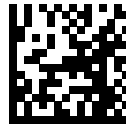

Hand-held Scanner Emulation (Port 9B)



Non-IBM Scanner Emulation (Port 5B)

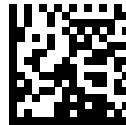

Table-top Scanner Emulation (Port 17)

Convert Unknown to Code 39

This parameter enables or disables converting unknown barcode type data to Code 39.



Enable Convert Unknown to Code 39



*Disable Convert Unknown to Code 39

RS-485 Beep Directive

The IBM RS-485 host can send a beeper configuration request to the scanner. Select Ignore Beep Directive to prevent the scanner from processing the host request. All directives are still acknowledged to the host as if they were processed.



Honor Beep Directive



*Ignore Beep Directive

RS-485 Barcode Configuration Directive

The IBM RS-485 host can enable and disable code types. Select Ignore Barcode Configuration Directive to prevent the scanner from processing the host request. All directives are still acknowledged to the IBM RS-485 host as if they were processed.



Honor Barcode Configuration Directive



*Ignore Barcode Configuration Directive

IBM-485 Specification Version

Parameter # 1729 (SSI # F8h 06h C1h)

This parameter determines which symbologies are reported.

- IBM-485 Original Specification - reports only symbologies historically supported on each port as known.
- IBM-485 - reports all symbologies supported in the new IBM specification as known with the respective code types.



*IBM-485 Original Specification (0)



IBM-485 (1)

Keyboard Wedge Interface

This section describes how to set up the scanner with a keyboard wedge interface.

The scanner connects between the keyboard and host computer and translates barcode data into keystrokes, which the host accepts as if they originated from the keyboard. This mode adds barcode reading functionality to a system designed for manual keyboard input. Keyboard keystrokes are simply passed through.

The scanner ships with the settings shown in [Keyboard Wedge Interface Parameter Defaults](#). If the default values suit requirements, programming is not necessary.

Keyboard Wedge Interface Connection

To connect the scanner between a keyboard and host computer:

1. Turn off the host and unplug the keyboard connector.
2. Connect the modular connector of the Y-cable to the host port as described in [Installing Cables](#).
3. Connect the round male DIN host connector of the Y-cable to the keyboard port on the host device.
4. Connect the round female DIN keyboard connector of the Y-cable to the keyboard connector.
5. Optionally connect a hand-held auxiliary scanner to the aux port.

6. If connecting an auxiliary scanner, connect the power supply to the power port and an AC outlet.

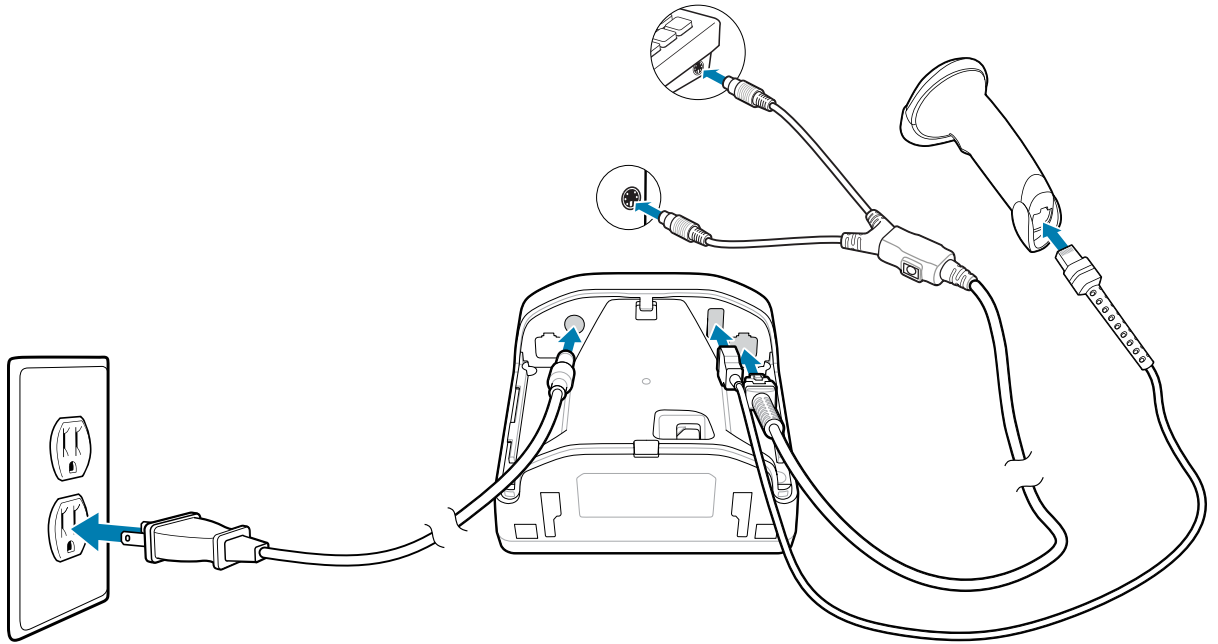

7. Ensure that all connections are secure.
8. Turn on the host system.
9. The scanner automatically detects the host interface type and uses the default setting. If the default (*) does not meet your requirements, see [Keyboard Wedge Host Parameters](#).
10. To modify other parameter options, scan the appropriate barcodes in this guide.

If problems occur with the system, see [Troubleshooting](#).

Keyboard Wedge Parameter Defaults

The following table lists defaults for keyboard wedge host parameters.

Change these values in one of two ways:

- Scan the appropriate barcodes in this chapter. The new value replaces the standard default value in memory. To recall default parameter values, see [Default Parameters](#).
- Configure the scanner using the 123Scan configuration program. See [123Scan and Software Tools](#).

Table 23 Keyboard Wedge Interface Parameter Defaults

Parameter	Default
Keyboard Wedge Host Parameters	
Keyboard Wedge Host Type	IBM AT Notebook
Barcodes with Unknown Characters	Send Barcodes with Unknown Characters
Keystroke Delay	No Delay
Intra-keystroke Delay	Disable
Alternate Numeric Keypad Emulation	Enable
Quick Keypad Emulation	Enable
Simulated Caps Lock	Disable
Caps Lock Override	Disable
Convert Case	Do Not Convert
Function Key Mapping	Disable
FN1 Substitution	Disable
Send Make and Break	Send

Keyboard Wedge Host Parameters

The parameters in this section control Keyboard Wedge Host characteristics.

Keyboard Wedge Host Types

Use this parameter to select the keyboard wedge host.



NOTE: For a list of supported scanner functionality by communication protocol, see [Communication Protocol Functionality](#).



IBM PC/AT & IBM PC Compatibles



*IBM AT Notebook

Barcodes with Unknown Characters

Unknown characters are characters the host does not recognize. This parameter determines how to process barcodes containing unknown characters.

- Send Barcodes With Unknown Characters - sends all barcode data except for unknown characters. The scanner issues no error beeps.
- Do Not Send Barcodes With Unknown Characters - sends barcode data up to the first unknown character. The scanner issues an error beep.



*Send Barcodes with Unknown Characters

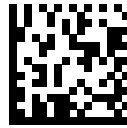

Do Not Send Barcodes with Unknown Characters

Keystroke Delay

This is the delay in milliseconds between emulated keystrokes. Select an option to increase the delay when hosts require slower data transmission.



*No Delay



Medium Delay (20 msec)



Long Delay (40 msec)

Intra-keystroke Delay

Select Enable Intra-keystroke Delay to insert an additional delay between each emulated key press and release. This also sets [Keystroke Delay](#) to a minimum of 5 msec.



Enable Intra-keystroke Delay



*Disable Intra-keystroke Delay

Alternate Numeric Keypad Emulation

This allows emulation of most other country keyboard types not listed in [Country Codes](#) in a Microsoft® operating system environment.



NOTE: If your keyboard type is not listed in the country code list (see [Country Codes](#)), disable [Quick Keypad Emulation](#) and ensure [Alternate Numeric Keypad Emulation](#) is enabled.



*Enable Alternate Numeric Keypad



Disable Alternate Numeric Keypad

Quick Keypad Emulation (Keyboard Wedge)

This enables faster keypad emulation where character value sequences are only sent for characters not found on the keyboard.



NOTE: This option applies only when [Alternate Numeric Keypad Emulation](#) is enabled.



*Enable Quick Keypad Emulation



Disable Quick Keypad Emulation

Simulated Caps Lock (Keyboard Wedge)

Select Enable Caps Lock to invert upper and lower case characters on the barcode as if the Caps Lock state is enabled on the keyboard. This inversion occurs regardless of the keyboard's Caps Lock state.



NOTE: This only applies to alpha characters.



Enable Caps Lock



*Disable Caps Lock

Caps Lock Override

Select Enable Caps Lock Override for AT or AT Notebook hosts to preserve the case of the data regardless of the state of the Caps Lock key.

When enabled, an 'A' in the barcode transmits as an 'A' regardless of the setting of the keyboard's Caps Lock key.



NOTE: If both Simulated Caps Lock and Caps Lock Override are enabled, Caps Lock Override takes precedence.



Enable Caps Lock Override



*Disable Caps Lock Override

Convert Case (Keyboard Wedge)

This parameter converts all barcode data to the selected case.



NOTE: Convert Case applies to ASCII characters only.



Convert to Upper Case



Convert to Lower Case



*Do Not Convert

Function Key Mapping (Keyboard Wedge)

ASCII values under 32 are normally sent as control key sequences (see [ASCII Character Sets](#)). Select Enable Function Key Mapping to send the keys in bold in place of the standard key mapping. Table entries that do not have a bold entry remain the same whether or not you enable this parameter.



Enable Function Key Mapping



*Disable Function Key Mapping

FN1 Substitution

Select Enable FN1 Substitution to replace FN1 characters in an EAN128 barcode with a user-selected keystroke (see [FN1 Substitution Values](#)).

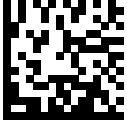

Enable FN1 Substitution



*Disable FN1 Substitution

Send Make and Break

Select Send Make and Break Scan Codes to prevent sending the scan codes for releasing a key.



NOTE: Windows-based systems must use Send Make and Break Scan Codes.



*Send Make and Break Scan Codes



Send Make Scan Code Only

Keyboard Map

The following keyboard map is a reference for prefix/suffix keystroke parameters. To program the prefix/suffix values, see the barcodes on [Prefix/Suffix Values](#).

Figure 12 IBM PS2 Type Keyboard

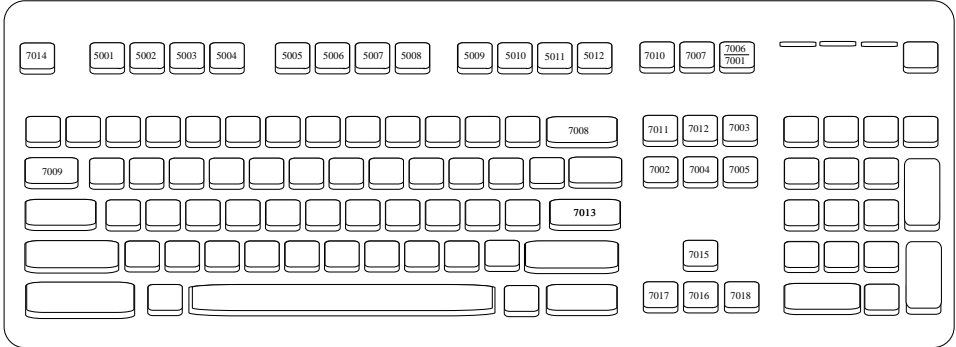

ASCII Character Sets

For character set information, review a specific character set table.

- [ASCII Character Sets](#)
- [ALT Key Character Set](#)
- [GUI Key Character Set](#)
- [PF Key Character Set](#)
- [F Key Character Set](#)
- [Numeric Key Character Set](#)
- [Extended Key Character Set](#)

SSI Interface

This chapter describes the system requirements of the Simple Serial Interface (SSI), which provides a communications link between Zebra decoders (e.g., scan engines, slot scanners, hand-held scanners, two-dimensional scanners, hands-free scanners, and RF base stations) and a serial host. It provides the means for the host to control the decoder or scanner.

Communication

All communication between the scanner and host occurs over the hardware interface lines using the SSI protocol. Refer to the Simple Serial Interface Programmer's Guide, p/n 72E-40451-xx, for more information on SSI.

The host and the scanner exchange messages in packets. A packet is a collection of bytes framed by the proper SSI protocol formatting bytes. The maximum number of bytes per packet that the SSI protocol allows for any transaction is 257 (255 bytes + 2 byte checksum).

Depending on the configuration, the scanner can send decode data as ASCII data (unpacketed), or as part of a larger message (packeted).

SSI performs the following functions for the host device:

- Maintains a bi-directional interface with the scanner
- Allows the host to send commands that control the scanner
- Passes data from the scanner to a host device in SSI packet format or straight decode message.

The SSI environment consists of a scanner, a serial cable which attaches to the host device, and if required, a power supply.

SSI transmits all decode data including special formatting (for example, AIM ID). Parameter settings can control the format of the transmitted data.

The scanner can also send parameter information, product identification information, or event codes to the host.

All commands sent between the scanner and host must use the format described in the SSI Message Formats section. [SSI Transactions](#) describes the required sequence of messages in specific cases.

SSI Commands

The following table lists all the SSI opcodes the scanner supports. The host transmits opcodes designated type H. The scanner (decoder) transmits type D opcodes, and either can transmit Host/Decoder (H/D) types.

Table 24 SSI Commands

Name	Type	Opcode	Description
AIM_OFF	H	0xC4	Deactivate aiming pattern.
AIM_ON	H	0xC5	Activate aiming pattern.
BEEP	H	0xE6	Sound the beeper.
CAPABILITIES_REPLY	D	0xD4	Reply to CAPABILITIES_REQUEST; contains a list of the capabilities and commands the decoder supports.
CAPABILITIES_REQUEST	H	0xD3	Request capabilities report from the decoder.
CMD_ACK	H/D	0xD0	Positive acknowledgment of received packet.
CMD_NAK	H/D	0xD1	Negative acknowledgment of received packet.
DECODE_DATA	D	0xF3	Decode data in SSI packet format.
EVENT	D	0xF6	Event indicated by associated event code.
LED_OFF	H	0xE8	De-activate LED output.
LED_ON	H	0xE7	Activate LED output.
PARAM_DEFAULTS	H	0xC8	Set parameter default values.
PARAM_REQUEST	H	0xC7	Request values of certain parameters.
PARAM_SEND	H/D	0xC6	Send parameter values.
REPLY_REVISION	D	0xA4	Reply to REQUEST_REVISION, contains the decoder's software/hardware configuration.
REQUEST_REVISION	H	0xA3	Request the decoder's configuration.
SCAN_DISABLE	H	0xEA	Prevent the operator from scanning barcodes.
SCAN_ENABLE	H	0xE9	Permit barcode scanning.
SLEEP	H	0xEB	Request to place the decoder into low power.
START_DECODE	H	0xE4	Tell the decoder to attempt to decode a barcode.
STOP_DECODE	H	0xE5	Tell the decoder to abort a decode attempt.
WAKEUP	H	N/A	Wake the decoder from low power mode.

For details of the SSI protocol, refer to the Simple Serial Interface Programmer's Guide.

SSI Transactions

General Data Transactions

This section describes general data transactions between the scanner and a host.

ACK/NAK Handshaking

If you enable ACK/NAK handshaking (the default), all packeted messages must have a CMD_ACK or CMD_NAK response, unless the command description states otherwise. Zebra recommends leaving this handshaking enabled to provide feedback to the host. Raw decode data and WAKEUP do not use ACK/NAK handshaking since they are not packeted data.

Following is an example of a problem which can occur if you disable ACK/NAK handshaking:

- The host sends a PARAM_SEND message to the scanner to change the baud rate from 9600 to 19200.
- The scanner cannot interpret the message.
- The scanner does not implement the change the host requested.
- The host assumes that the parameter change occurred and acts accordingly.
- Communication is lost because the change did not occur on both sides.

If you enable ACK/NAK handshaking, the following occurs:

- The host sends a PARAM_SEND message.
- The scanner cannot interpret the message.
- The scanner CMD_NAKs the message.
- The host resends the message.
- The scanner receives the message successfully, responds with CMD_ACK, and implements parameter changes.

Decoded Data Transmission

The [Decode Data Packet Format](#) parameter controls how decode data is sent to the host. Set this parameter to send the data in a DECODE_DATA packet. Clear this parameter to transmit the data as raw ASCII data.



NOTE: When transmitting decode data as raw ASCII data, ACK/NAK handshaking does not apply regardless of the state of the ACK/NAK handshaking parameter.

ACK/NAK Enabled and Packeted Data

The scanner sends a DECODE_DATA message after a successful decode. The scanner waits for a programmable timeout for a CMD_ACK response. If it does not receive the response, the scanner tries to send two more times before issuing a host transmission error. If the scanner receives a CMD_NAK from the host, it may attempt a retry depending on the cause field of the CMD_NAK message.

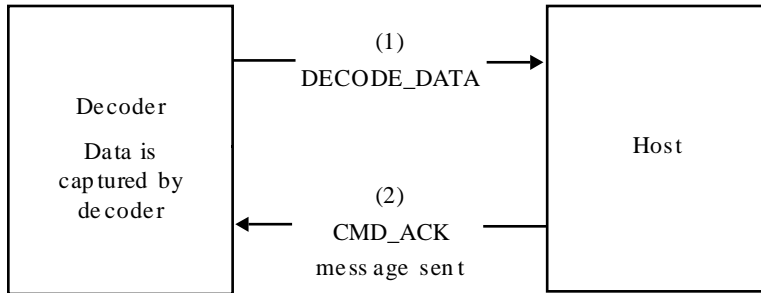

ACK/NAK Enabled and Unpacketed ASCII Data

Even if ACK/NAK handshaking is enabled, no handshaking occurs because handshaking applies only to packeted data. In this example the packeted_decode parameter is disabled.

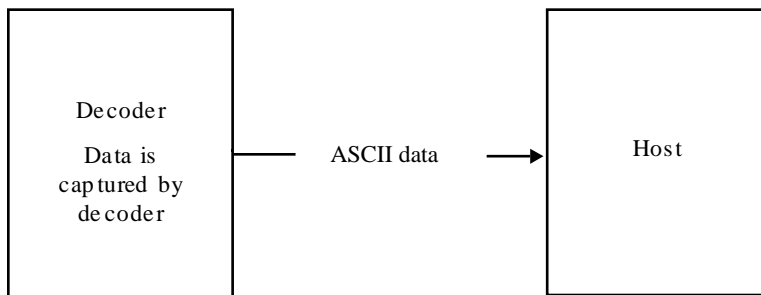

ACK/NAK Disabled and Packeted DECODE_DATA

In this example ACK/NAK does not occur even though packeted_decode is enabled because the ACK/NAK handshaking parameter is disabled.

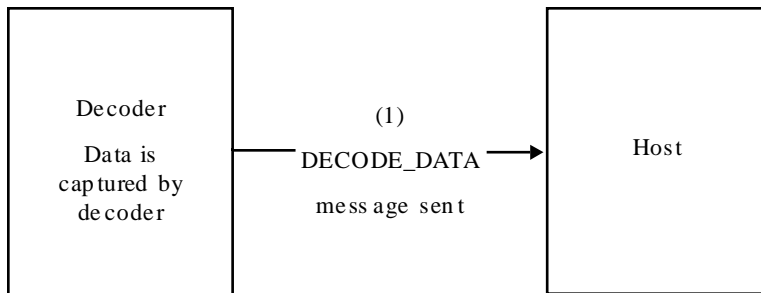

ACK/NAK Disabled and Unpacketed ASCII Data

The decoder sends captured data to the host.

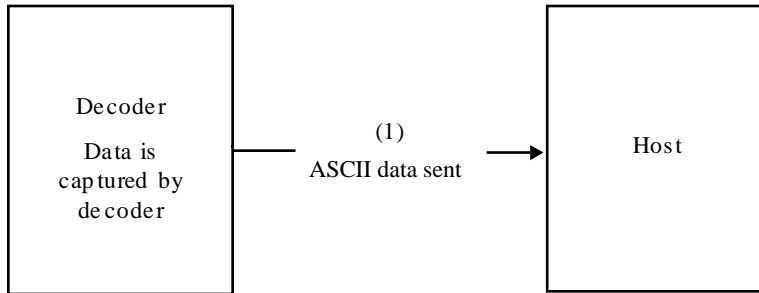

Communication Summary

RTS/CTS Lines

All communication must use RTS/CTS handshaking as described in the Simple Serial Interface Programmer's Guide, p/n 72E-40451-xx. If bypassing hardware handshaking, the host must send the WAKEUP command before all other communication or the first byte of a message can be lost during the scanner wakeup sequence. Zebra recommends not bypassing RTS/CTS hardware handshaking.

ACK/NAK Option

ACK/NAK handshaking is enabled by default and Zebra recommends leaving it enabled. Disabling this can cause communication problems, as handshaking is the only acknowledgment that a message was received correctly. ACK/NAK is not used with unpacked decode data regardless of whether it is enabled.

Number of Data Bits

All communication with the scanner must use 8-bit data.

Serial Response Timeout

The [Host Serial Response Timeout](#) parameter determines how long to wait for a handshaking response before trying again or aborting further attempts. Set the same value for both the host and scanner.



NOTE: You can temporarily change the [Host Serial Response Timeout](#) when the host takes longer to process an ACK or longer data string. Zebra does not recommend frequent permanent changes due to limited write cycles of non-volatile memory.

Retries

The host resends data twice after the initial send if the scanner does not respond with an ACK or NAK (if ACK/NAK handshaking is enabled), or response data (for example, PARAM_SEND, REPLY_REVISION). If the scanner replies with a NAK RESEND, the host resends the data. All resent messages must have the resend bit set in the Status byte.

The scanner resends data two times after the initial send if the host fails to reply with an ACK or NAK (if ACK/NAK handshaking is enabled).

Baud Rate, Stop Bits, Parity, Response Timeout, ACK/NAK Handshaking

If you use PARAM_SEND to change these serial parameters, the ACK response to the PARAM_SEND uses the previous values for these parameters. The new values then take effect for the next transaction.

Errors

The scanner issues a communication error when:

- The CTS line is asserted when the scanner tries to transmit, and is still asserted on each of two successive retries
- The scanner does not receive an ACK or NAK after initial transmit and two resends.

SSI Communication Notes

- When not using hardware handshaking, space messages sufficiently apart. The host must not communicate with the scanner if the scanner is transmitting.
- When using hardware handshaking, frame each message properly with handshaking signals. Do not try to send two commands within the same handshaking frame.
- There is a permanent/temporary bit in the PARAM_SEND message. Removing power from the scanner discards temporary changes. Permanent changes are written to non-volatile memory. Frequent changes shorten the life of the non-volatile memory.

Encapsulation of RSM Commands/Responses over SSI

The SSI protocol allows the host to send a command that is variable in length up to 255 bytes. Although there is a provision in the protocol to multi-packet commands from the host, the scanner does not support this. The host must fragment packets using the provisions in the RSM protocol.

Command Structure

Byte	7	6	5	4	3	2	1	0
0	Length (not including the checksum)							
1	SSI_MGMT_COMMAND (0x80)							
2	Message Source (4 - Host)							
3	Reserved (0)			Reserved (0)		Reserved (0)	Cont'd packet	Retransmit
4	Payload data (see the following example)							
...								
Length -1								
Length	2's complement checksum (MSB)							
Length +1	2's complement checksum (LSB)							

The expected positive response is SSI_MGMT_COMMAND which can be a multi-packet response. Devices that do not support this command respond with the standard SSI_NAK.

Response Structure

Byte	7	6	5	4	3	2	1	0
0	Length (not including the checksum)							
1	SSI_MGMT_COMMAND (0x80)							
2	Message Source (0 - Decoder)							
3	Reserved (0)			Reserved (0)		Reserved (0)	Cont'd packet	Retransmit
4	Payload data (see the following example)							
...								
Length -1								
Length	2's complement checksum (MSB)							
Length +1	2's complement checksum (LSB)							

Example Transaction

The following example illustrates how to retrieve diagnostic information (Diagnostic Testing and Reporting - Attribute #10061- decimal) from the scanner using encapsulation of RSM commands over SSI. Before sending an RSM command, the host must send the RSM Get Packet Size command to query the packet size supported by the device.

Command from Host to Query Packet Size Supported by Device

```
0A 80 04 00 00 06 20 00 FF FF FD 4E
```

Where:

- 0A 80 04 00 is encapsulation of RSM commands over SSI command header
- 00 06 20 00 FF FF is RSM Get Packet Size command
- FD 4E is SSI command checksum

Response from Device with Packet Size Information

```
0C 80 00 00 00 08 20 00 00 F0 00 F0 FD 6C
```

Where:

- 0C 80 00 00 is encapsulation of RSM command over SSI command header
- 00 08 20 00 00 F0 00 F0 is RSM Get Packet Size response
- FD 6C is SSI response checksum

Command from Host to Retrieve Diagnostic Information

```
0C 80 04 00 00 08 02 00 27 4D 42 00 FE B0
```

Where:

- 0C 80 04 00 is encapsulation of RSM commands over SSI command header
- 00 08 02 00 27 4D 42 00 is attribute Get command requesting attribute 10061 decimal
- FE B0 is SSI command checksum

Response from Device with Diagnostic Information

```
21 80 00 00 00 1D 02 00 27 4D 41 01 42 00 0E 00 00 00 00 01 03 02 03 03 03 04  
03 05 03 06 03 FF FF FC 15
```

Where:

- 21 80 00 00 00 1D 02 00 27 4D 41 01 42 00 0E 00 00 is encapsulation of RSM responses over SSI command header
- 00 00 01 03 02 03 03 03 04 03 05 03 06 03 is attribute Get response which includes diagnostic report value
- FF FF is attribute Get response, packet termination
- FC 15 is SSI response checksum

Setting SSI Parameters

You can set up a scanner with an SSI host. When using SSI, program the scanner via barcode menu or SSI hosts commands

The scanner ships with the settings shown in [SSI Interface Defaults](#) (also see [Standard Parameter Defaults](#) for all defaults). If the default values suit requirements, programming is not necessary.

To set feature values, scan a single barcode or a short barcode sequence. The settings are stored in non-volatile memory and are preserved even when the scanner powers down.



NOTE: Most computer monitors allow scanning barcodes directly on the screen. When scanning from the screen, be sure to set the document magnification to a level where you can see the barcode clearly, and bars and/or spaces do not merge.

To return all features to default values, scan [Set Factory Defaults](#). Throughout the programming barcode menus, asterisks (*) indicate default values.

SSI Scanning Sequence Examples

In most cases scanning one barcode sets the parameter value. For example, to set the baud rate to 19,200, scan the **Baud Rate 19,200** barcode under [Baud Rate](#). The scanner issues a fast warble beep and the LED turns green, signifying a successful parameter entry.

Other parameters require scanning several barcodes. See the parameter descriptions for this procedure.

SSI Errors While Scanning

Unless otherwise specified, to correct an error during a scanning sequence, just re-scan the correct parameter.

Simple Serial Interface Parameter Defaults

The following table lists defaults for SSI host parameters.

You can change these values in one of two ways:

- Scan the appropriate barcodes in this section. The new value replaces the standard default value in memory. To recall default parameter values, see [Default Parameters](#).
- Download data through the device's serial port using SSI. Hexadecimal parameter numbers appear in this chapter below the parameter title, and option values appear in parenthesis beneath the accompanying barcodes. Refer to the Simple Serial Interface (SSI) Programmer's Guide for detailed instructions for changing parameters using this method.

Table 25 SSI Interface Default Table

Parameter	Parameter Number	SSI Number	Default
SSI Host Parameters			
Select SSI Host	N/A	N/A	N/A
Baud Rate	156	9Ch	9600
Parity	158	9Eh	None
Check Parity	151	97h	Disable
Stop Bits	157	9Dh	1
Software Handshaking	159	9Fh	ACK/NAK
Host RTS Line State	154	9Ah	Low
Datalogic Supported Commands	2260	F8 08 D4	Disable
Decode Data Packet Format	238	EEh	Send Raw Decode Data
Host Serial Response Timeout	155	9Bh	2 Seconds
Host Character Timeout	239	EFh	200 msec
Multipacket Option	334	F0h 4Eh	Multipacket Option 1
Interpacket Delay	335	F0h 4Fh	0 msec
Event Reporting			
Decode Event	256	F0h 00h	Disable
Boot Up Event	258	F0h 02h	Disable
Parameter Event	259	F0h 03h	Disable



NOTE: SSI interprets Prefix, Suffix1, and Suffix2 values listed in [ASCII Character Sets](#) differently than other interfaces. SSI does not recognize key categories, only the 3-digit decimal value. The default value of 7013 is interpreted as CR only.

SSI Host Parameters

Scan barcodes to set SSI host parameters

Select SSI Host

Use this parameter to select SSI as the host interface.



SSI Host

SSI Baud Rate

Parameter # 156 (SSI # 9Ch)

Baud rate is the number of bits of data transmitted per second.

Select an option to set the scanner's baud rate to match the baud rate setting of the host device. Otherwise, data may not reach the host device or may reach it in distorted form.



Baud Rate 460,800 (14)



Baud Rate 921,600 (15)



*Baud Rate 9600 (6)



Baud Rate 19,200 (7)



Baud Rate 38,400 (8)



Baud Rate 57,600 (10)



Baud Rate 115,200 (11)



Baud Rate 230,400 (13)



Baud Rate 460,800 (14)

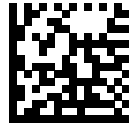

Baud Rate 921,600 (15)

SSI Parity

Parameter # 158 (SSI # 9Eh)

Choose whether code characters contain an odd or even number of 1 bits, or choose that no parity bit is required.

A parity check bit is the most significant bit of each ASCII coded character. Use this parameter to select the parity type according to host device requirements.

- Odd - This sets the parity bit value to 0 or 1, based on data, to ensure that the coded character contains an odd number of 1 bits.
- Even - This sets the parity bit value to 0 or 1, based on data, to ensure that the coded character contains an even number of 1 bits.
- None - No parity bit is required.



Odd (2)



Even (1)



*None (0)

Check Parity

Parameter # 151 (SSI # 97h)

Choose whether to check the parity of received characters.

Use this parameter to select whether to check the parity of received characters. See [SSI Parity](#) to select the type of parity.



*Do Not Check Parity (0)



Check Parity (1)

SSI Stop Bits

Parameter # 157 (SSI # 9Dh)

The stop bit(s) at the end of each transmitted character marks the end of transmission of one character and prepares the receiving device for the next character in the serial data stream.

Select an option to set the number of stop bits (one or two) based on the number the receiving host can accommodate.



*1 Stop Bit (1)

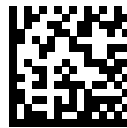

2 Stop Bits (2)

Software Handshaking

Parameter # 159 (SSI # 9Fh)

This parameter offers control of data transmission in addition to the control hardware handshaking offers. Hardware handshaking is always enabled; you cannot disable it.

- Disable ACK/NAK Handshaking - The scanner neither generates nor expects ACK/NAK handshaking packets.
- Enable ACK/NAK Handshaking - After transmitting data, the scanner expects either an ACK or NAK response from the host. The scanner also ACKs or NAKs messages from the host. The scanner waits up to the programmable [Host Serial Response Timeout](#) to receive an ACK or NAK. If the scanner does not get a response in this time, it resends its data up to two times before discarding the data and declaring a transmission error.



Disable ACK/NAK (0)



*Enable ACK/NAK (1)

Host RTS Line State

Parameter # 154 (SSI # 9Ah)

This parameter sets the expected idle state of the Serial Host RTS line.

The SSI interface is used with host applications that also implement the SSI protocol. However, you can use the scanner in a "scan-and-transmit" mode to communicate with any standard serial communication software on a host PC (see [Decode Data Packet Format](#)). If transmission errors occur in this mode, the host PC may be asserting hardware handshaking lines that interfere with the SSI protocol. Scan the High barcode to address this problem.



*Low (0)



High (1)

Datalogic Supported Commands

Parameter # 2260 (SSI # F8 08 D4)

This parameter allows serial scan to enable or disable commands for a standard RS232 host.

- 'E' or 'e' = Enable Scanning
- 'D' or 'd' = Disable Scanning
- 'R' = Reset the scanner
- 'F' = Indicate to the scanner that Datalogic is not on file
- 'B' = Issue a good read beep
- 1 (Not an ASCII Character – This is a decimal number 1) = Force a good read beep
- 7 (Not an ASCII Character – This is a decimal number 7) = Force a good read beep



Enable (1)



*Disable (0)

Decode Data Packet Format

Parameter # 238 (SSI # EEh)

Use this parameter to select whether to transmit decoded data in raw format (unpacketed), or with the packet format defined by the serial protocol.



NOTE: Selecting the raw format disables ACK/NAK handshaking for decode data.



*Send Raw Decode Data (0)



Send Packeted Decode Data (1)

Host Serial Response Timeout (SSI)

Parameter # 155 (SSI # 9Bh)

This parameter specifies how long a scanner waits for an ACK or NAK before resending.

If the scanner wants to send, and the host has already been granted permission to send, the scanner waits for the designated timeout before declaring an error.



NOTE: Other values are available via SSI command.



*Low - 2 Seconds (20)



Medium - 5 Seconds (50)



High - 7.5 Seconds (75)



Maximum - 9.9 Seconds (99)

Host Character Timeout

Parameter # 239 (SSI # EFh)

This parameter specifies the maximum time a scanner waits between characters transmitted by the host before discarding the received data and declaring an error.

Select an option to specify the maximum time the scanner waits from Low to High.



NOTE: Other values are available via SSI command.



*Low - 200 msec (20)

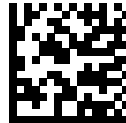

Medium - 500 msec (50)



High - 750 msec (75)



Maximum - 990 msec (99)

Multipacket Option

Parameter # 334 (SSI # F0h 4Eh)

This parameter controls ACK/NAK handshaking for multi-packet transmissions.

- Multi-Packet Option 1 - The host sends an ACK/NAK for each data packet during a multi-packet transmission.
- Multi-Packet Option 2 - The scanner sends data packets continuously, with no ACK/NAK handshaking to pace the transmission. The host, if overrun, can use hardware handshaking to temporarily delay scanner transmissions. At the end of transmission, the scanner waits for a CMD_ACK or CMD_NAK.
- Multi-Packet Option 3 - This is the same as option 2 with the addition of a programmable interpacket delay. See [Interpacket Delay](#) to set this delay.



*Multipacket Option 1 (0)



Multipacket Option 2 (1)



Multipacket Option 3 (2)

Interpacket Delay

Parameter # 335 (SSI # F0h 4Fh)

This parameter specifies the interpacket delay if you selected Multipacket Option 3.



NOTE: Other values are available via SSI command.



*Minimum - 0 msec (0)



Low - 25 msec (25)



Medium - 50 msec (50)



High - 75 msec (75)



Maximum - 99 msec (99)

Event Reporting

The host can request the scanner to provide certain information (events) relative to scanner behavior. Scan the following barcodes to enable or disable events.

Table 26 Event Codes

Event Class	Event	Code Reported
Decode Event	Non-parameter decode	0x01
Boot Up Event	System power-up	0x03
Parameter Event	Parameter entry error	0x07
	Parameter stored	0x08
	Defaults set (and parameter event is enabled by default)	0x0A
	Number expected	0x0F

Decode Event

Parameter # 256 (SSI # F0h 00h)

Use this parameter to enable or disable a non-parameter decode event.

- Enable Decode Event - scanner generates a message to the host upon a successful barcode decode.
- Disable Decode Event - no notification is sent.



Enable Decode Event (1)



*Disable Decode Event (0)

Boot Up Event

Parameter # 258 (SSI # F0h 02h)

Use this parameter to enable or disable a system power-up event.

- Enable Boot Up Event - scanner generates a message to the host whenever power is applied.
- Disable Boot Up Event - no notification is sent.



Enable Boot Up Event (1)



*Disable Boot Up Event (0)

Parameter Event

Parameter # 259 (SSI # F0h 03h)

Use this parameter to enable or disable parameter events.

- Enable Parameter Event - scanner generates a message to the host when one of the events specified in [Event Reporting](#) occurs.
- Disable Parameter Event - no notification is sent.



Enable Parameter Event (1)



*Disable Parameter Event (0)

User Preferences and Miscellaneous Options

You can program the scanner to perform various functions, or activate different features. This chapter describes user preference features and provides programming barcodes for selecting these features.

The scanner ships with the settings shown in [User Preferences Parameter Defaults](#). If the default values suit requirements, programming is not necessary.

Setting User Preference Parameters

To set feature values, scan a single barcode or a short barcode sequence. The settings are stored in non-volatile memory and are preserved even when the scanner powers down.



NOTE: Most computer monitors allow scanning barcodes directly on the screen. When scanning from the screen, be sure to set the document magnification to a level where you can see the barcode clearly, and bars and/or spaces do not merge.

If not using the default host, select the host type (see each host chapter for specific host information) after the power-up beeps sound. This is only necessary upon the first power-up when connected to a new host.

To return all features to default values, see [Default Parameters](#). Throughout the programming barcode menus, asterisks indicate (*) default values.

User Preference Scanning Sequence Examples

In most cases, scanning one barcode sets the parameter value.

For example, to set the beeper tone to high, scan the High Frequency (beeper tone) barcode listed under [Scan Tone](#). The scanner issues a fast warble beep and the LED turns green, signifying a successful parameter entry.

Other parameters require scanning several barcodes. See the parameter descriptions for this procedure.

User Preference Errors While Scanning

Unless otherwise specified, to correct an error during a scanning sequence, just re-scan the correct parameter.

User Preferences/Miscellaneous Options Parameter Defaults

The following table lists defaults for user preference and miscellaneous parameters.

Change these values in one of two ways:

- Scan the appropriate barcodes in this chapter. The new value replaces the standard default value in memory. To recall default parameter values, see [Default Parameters](#).
- Configure the scanner using the 123Scan configuration program. See [123Scan and Software Tools](#).

Table 27 User Preferences Parameter Defaults

Parameter	Parameter Number ^a	SSI Number ^b	Default
User Preferences			
Set Default Parameter	N/A	N/A	N/A
Write to Custom Defaults	N/A	N/A	N/A
Parameter Barcode Scanning	236	ECh	Enable
Beep After Good Decode	56	38h	Enable
LED on Good Decode	744	F1h E8h	Enable
Beeper Volume	140	8Ch	Auto
Scan Tone	145	91h	Medium
Beeper Duration	628	F1h 74h	Medium
Tone/Volume Button	1287	F8h 05h 07h	Enable Tone, Enable Volume
Speaker Control	2359	F8 09 37	Internal
Suppress Power Up Beeps	721	F1h D1h	Do Not Suppress
Timeout Between Decodes, 1D Same Symbol	137	89h	0.4 Seconds
Extend Timeout Between Decodes, 2D Same Symbol	2367	F8h 09h 3Fh	0.3 Seconds
Timeout Between Decodes, Different Symbols	144	90h	0.1 Seconds
Decode Range Limit (Hands-free)	1950	F8h 07h 9Eh	Disable
Mobile Phone/Display Mode (Enhanced)	716	F1h CCh	Standard
Motion Detect Mode (Wakeup)	2377	F8 09 49	Object Detect
Rescan Beep	2382	F8 09 4E	Disable
PDF Prioritization	719	F4h F1h CFh	Disable
PDF Prioritization Timeout	720	F1h D0h	200 ms
Presentation Mode Field of View	609	F1h 61h	Full
SecurPharm Decoding	1752	F8h 06h D8h	Disable
Securpharm Output Formatting	1753	F8h 06h D9h	No Formatting
Non-Decode Event	2075	F8 08 1B	Disable

Table 27 User Preferences Parameter Defaults (Continued)

Parameter	Parameter Number ^a	SSI Number ^b	Default
Non-Decode Event Threshold	2076	F8 08 1C	N/A
Miscellaneous Options			
Enter Key	N/A	N/A	N/A
Tab Key	N/A	N/A	N/A
Transmit Code ID Character	45	2Dh	None
Prefix Value	99, 105	63h, 69h	7013 <CR><LF>
Suffix 1 Value	98, 104	62h, 68h	7013 <CR><LF>
Suffix 2 Value	100, 106	64h, 6Ah	7013 <CR><LF>
Scan Data Transmission Format	235	EBh	Data As Is
FN1 Substitution Values	103, 109	67h, 6Dh	7013 <CR><LF>
Unsolicited Heartbeat Interval	1118	F8h 04h 5Eh	Disable

^a Parameter number decimal values are used for programming via RSM commands.

^b SSI number hex values are used for programming via SSI commands.

User Preferences

Set feature values by scanning the desired parameter values.

Default Parameters

Scan one of the following barcodes to reset the scanner to its default settings.

- Restore Defaults resets all default parameters as follows:
 - If you configured custom default parameter values via the Write to Custom Defaults barcode, scanning the Restore Defaults barcode restores these custom values.
 - If you did not configure custom default parameter values, scanning the Restore Defaults barcode restores the factory default values. Default values are available at the beginning of each chapter.
- Set Factory Defaults clears all custom default values and sets the factory default values. Default values are available at the beginning of each chapter.



Restore Defaults



Set Factory Defaults

Write to Custom Defaults

To create a set of custom defaults, select the desired parameter values in this guide and then scan Write to Custom Defaults.



Write to Custom Defaults

Parameter Barcode Scanning

Parameter # 236 (SSI # ECh)

This parameter selects whether to enable or disable the decoding of parameter barcodes, including the Set Defaults barcodes.



*Enable Parameter Barcode Scanning (1)



Disable Parameter Barcode Scanning (0)

Beep After Good Decode

Parameter # 56 (SSI # 38h)

This parameter selects whether or not the scanner beeps after a good decode. If you select Disable Beep After Good Decode, the beeper still operates during parameter menu scanning and to indicate error conditions.

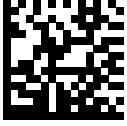

*Enable Beep After Good Decode (1)



Disable Beep After Good Decode (0)

LED on Good Decode

Parameter # 744 (SSI # F1h E8h)

This parameter selects whether or not the LED blinks on a good decode.

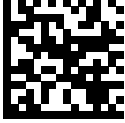

*Enable LED on Good Decode (2)



Disable LED on Good Decode (0)

Beeper Volume

Parameter # 140 (SSI # 8Ch)

This parameter selects a beeper volume.



NOTE: When set to Auto Volume, the scanner will automatically select either Medium or High volume based on the power input detected.

- USB A (500mA) results in a medium volume.
- USB A (BC1.2) results in a high volume.
- External 12VDC power source results in High volume.



CAUTION: Selecting High volume while connected to USB A (500mA) will result in the scanner exceeding USB certification power limits.



Low Volume (2)



Medium Volume (1)



High Volume (0)



Auto Volume* (3)

Scan Tone

Parameter # 145 (SSI # 91h)

Use this parameter to select a scan tone. Select one scan tone from the special tones or from the standard tones. Use the Disable Tone option to disable all tones.

Standard Tones



Disable Tone (3)



Low Tone (2)



*Medium Tone (1)



High Tone (0)



Medium to High Tone (2-tone) (4)

Special Tones



Wood Block / Tone 1 (6)



Pulse / Tone 2 (7)



Chime / Tone 3 (8)



Zap / Tone 4 (9)



Triple Beep / Tone 5 (10)



User Programmable / Tone 6 (11)

Note: See Custom Scan Tone to download a custom tone.

Beeper Duration

Parameter # 628 (SSI # F1h 74h)

This parameter selects the duration for the good decode beep.



Short Duration (0)



*Medium Duration (1)



Long Duration (2)

Tone/Volume Button

Parameter # 1287 (SSI # F8h 05h 07h)

Enable this parameter to use the physical Volume button on the front panel of the scanner to change the speaker volume and tone. Disable this parameter to prevent the speaker volume and tone from being changed using the physical Volume button on the front panel of the scanner.



*Enable Tone, Enable Volume (1)



Disable Tone, Disable Volume (0)



Disable Tone, Enable Volume (2)



Enable Tone, Disable Volume (3)

Speaker Control

Parameter # 2359 (SSI #F8 09 37)

This parameter allows you to select how audio feedback from the scanner is projected. There are two options

- Internal speaker – In-built speaker provides audio output that can be configured up to 3 different levels (Refer to [Beeper Volume](#)). Barcode “Internal speaker 1” can be used to reset to this default setting.
- External speaker – Enables an auxiliary speaker, if one is needed and connected. Barcode “External speaker 0” will activate this functionality.



NOTE: Auxiliary cables and speakers are to be user supplied. This parameter can only be used to alternate between internal and external speakers, both will not function simultaneously.



*Internal (0)



External (1)

Suppress Power Up Beeps

Parameter # 721 (SSI # F1h D1h)

This parameter selects whether or not to suppress the scanner's power-up beeps.



*Do Not Suppress Power Up Beeps (0)



Suppress Power Up Beeps (1)

Hands-Free Decode Session Timeout

Parameter # 400 (SSI # F0 90)

This parameter is the hands-free compliment to the Decode Session Timeout. It configures the minimum and maximum decode processing time during a hands-free scan attempt. It only applies to the hands-free trigger mode or when a scanner is placed in the gooseneck stand.

The range for this parameter is 2 - 255 with a default value of 66.

The minimum decode processing time is defined as the time in which the scanner stops decoding when an object is removed or left stationary in the imaging field of view.

The maximum decode processing time is defined as the time in which the scanner stops decoding when an object is left in or is moving in the field of view.

Both the maximum and minimum times are configured using a single setting. The relationship of this setting is as follows:

Setting Value ^a	Minimum Time	Maximum Time
X < 25	250 ms	2.5 seconds
252 > X >= 25	X * 10 ms	X * 100 ms
X= 252	10 seconds	25 seconds
X= 253	15 seconds	25 seconds
X= 254	20 seconds	25 seconds
X= 255	25 seconds	25 seconds

^a value must be three digits.

For example, a setting value of 100 results in the scanner turning off approximately 1 second after an object is removed from the field of view or 10 seconds while an object is in the field of view moving.

The default value of the setting is 15, which results in a minimum time of 250 ms and a maximum time of 2.5 seconds.

User Preferences and Miscellaneous Options

The default value of the setting is 66, which results in a minimum time of 660 ms and a maximum time of 6.6 seconds.

Adjust this setting based on your requirements. For example, when doing PDF prioritization, this parameter should be set to a value where the maximum time is above the PDF prioritization timeout.

To set a three digit value scan the following bar code, and then scan three bar codes from [Numeric Barcodes](#). Enter a leading zero for single-digit numbers. To correct an error or change a selection, scan Cancel.



Hands-Free Decode Session Timeout

Timeout Between Decodes, Same Symbol

Parameter # 137 (SSI # 89h)

Use this option in presentation mode or Continuous Barcode Read mode to prevent the scanner from continuously decoding the same barcode when it is left in the scanner's field of view. The barcode must be out of the field of view for the timeout period before the scanner reads the same consecutive symbol.

Timeout Between Decodes, Same Symbol is programmable in 0.1 second increments from 0.0 to 9.9 seconds. The default interval is 0.5 seconds.

To select the timeout between decodes for the same symbol, scan the following barcode, and then scan two barcodes from [Numeric Barcodes](#) that correspond to the desired interval, in 0.1 second increments.



Timeout Between Decodes, Same Symbol

Timeout Between Decodes, Different Symbols

Parameter # 144 (SSI # 90h)

Use this option in presentation mode or Continuous Barcode Read to control the time the scanner waits before decoding a different symbol.

Timeout Between Decodes, Different Symbols is programmable in 0.1 second increments from 0.1 to 9.9 seconds. The default is 0.1 seconds.

To select the timeout between decodes for different symbols, scan the following barcode, and then scan two barcodes from [Numeric Barcodes](#) that correspond to the desired interval, in 0.1 second increments.



Timeout Between Decodes, Different Symbols

Extend Timeout Between Decodes, 2D Same Symbol

Parameter # 2367 (SSI # F8h 09h 3Fh)

Use this option to add to the value of [Extend Timeout Between Decodes, 2D Same Symbol](#) for non-1D barcodes (2D and other symbologies).

The default extend timeout is 0.3 seconds. For example, the total timeout value for a 2D barcode by default is 0.7 seconds (0.4 + 0.3 seconds). Adjusting [Extend Timeout Between Decodes, 2D Same Symbol](#) affects the 2D decode timeout accordingly.

To select the extend timeout between decodes for the same symbol, scan the following barcode, and then scan two barcodes from [Numeric Barcodes](#) that correspond to the desired interval, in 0.1 second increments.



Extend Timeout Between Decodes, 2D Same
Symbol

Decode Range Limit (Hands-free)

Parameter # 1950 (SSI # F8h 07h 9Eh)

This parameter can be used in EAS applications to better match decode range with EAS deactivation range.

Select the desired range. The default value is Unrestricted.

- Near - Range is limited so that only nearby barcodes are reported. Used to reduce the chance of inadvertently scanning surrounding barcodes.
- Medium - Range is limited to fit most EAS applications.
- Far - Range is limited slightly so that farther barcodes are also reported.
- Unrestricted - Range is not limited (maximum range).



Medium(22)

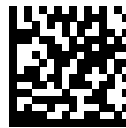

Unrestricted(0)*



Far (17)



Near (29)

Mobile Phone / Display Mode (Enhanced)

Parameter # 716 (SSI # F1h CCh)

This mode improves barcode reading performance on mobile phones and electronic displays. Scan one of the following barcodes to select the desired mode.

- Standard
- Enhanced



*Standard (6)



Enhanced (7)

Motion Detect Mode (Wakeup)

Parameter # 2377 (SSI # F8 09 49)

This parameter selects the method used to detect motion and activate a decode session.

The available options are:

- Scene Detect - A decode session is triggered when a change in scene (for example, motion) is detected by the imaging sensor. Illumination is turned on and decoding is enabled. Scene Detect does not require illumination to detect a change in scene (for example, Motion). Susceptible to inadvertent wakeup from motion beyond decode zone (for example, people moving past scanner).
- Object Detect - A decode session is triggered when a barcode is detected by the imaging sensor. Illumination is increased and decoding is enabled. Object detect requires some illumination to detect the object (for example, Barcode). Less susceptible than Scene Detect to inadvertent wakeup from motion beyond decode zone (for example, people moving past scanner)
- Auto (Default) - The recommended motion detect mode is selected automatically according to model type as follows:
 - SP72-V (Vertical): Object Detect mode
 - SP72-H (Horizontal): Scene Detect mode



Auto (0*)

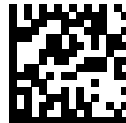

Object Detect (1)



Scene Detect (2)

Rescan Beep

Parameter #2382 (SSI # F8 09 4E)

This feature allows the user to acoustically recognize if/when an item is scanned multiple times, either intentionally or unintentionally.

The standard decode tone is heard after the 1st decode and any odd numbered decode after that (3rd, 5th, 7th, etc.). A higher frequency “rescan beep” tone is heard after the 2nd decode and any even numbered decode after that (2nd, 4th, 6th, etc.). If the standard decode tone is changed to something other than the default, the odd numbered decodes would use this newly defined tone while the even numbered decodes would always use the rescan beep tone.

When this feature is disabled, the standard decode tone will be used for all decodes.

To enable this feature, scan the Enable barcode followed by three barcodes from [Numeric Barcodes](#) to set the Rescan Beep Timeout. The Rescan Beep Timeout determines how long the scanner will wait between decodes before it considers the next decode a 1st scan attempt. The Rescan Beep Timeout range is 1 (001) to 255 (255) seconds. We recommend setting this parameter initially to 5 (005) seconds and adjusting as needed.



Rescan Beep Enable

PDF Prioritization

Parameter # 719 (SSI # F4h F1h CFh)

Enable this parameter to delay decoding certain 1D barcodes by the value specified in PDF Prioritization Timeout.

During the [PDF Prioritization Timeout](#) time, the scanner attempts to decode a PDF417 symbol (for example, on a US driver's license), and if successful, reports this only. If it does not decode (cannot find) a PDF417 symbol, it reports the 1D symbol after the timeout. The 1D symbol must be in the device's field of view for the scanner to report it. This parameter does not affect decoding other symbologies.

The 1D Code 128 barcode lengths include the following:

- 7 to 10 characters
- 14 to 22 characters
- 27 to 28 characters

In addition, a Code 39 barcode with the following lengths are considered to potentially be part of a US driver's license:

- 8 characters
- 12 characters



Enable PDF Prioritization (1)

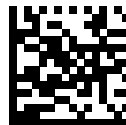

*Disable PDF Prioritization (0)

PDF Prioritization Timeout

Parameter # 720 (SSI # F1h D0h)

If you enabled PDF Prioritization, set this timeout to indicate how long the scanner attempts to decode a PDF417 symbol before reporting the 1D barcode in the field of view.

The PDF Prioritization Timeout range is 0 to 5000 ms, and the default is 200 ms.

Scan the following barcode, and then scan four barcodes from [Numeric Barcodes](#) that specify the timeout in milliseconds. For example, to enter 400 ms, scan the following barcode, and then scan 0400.



PDF Prioritization Timeout

Presentation Mode Field of View

Parameter # 609 (SSI # F1h 61h)

This parameter sets the size of the search area.

In presentation mode, the default setting of Full Field of View allows the scanner to search the entire area of the imaging field of view.

Select Small Field of View or Medium Field of View to search for a barcode in a smaller centered region of the imaging field of view to speed search time.



Small Field of View (0)

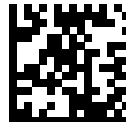

Medium Field of View (1)



*Full Field of View (2)

securPharm Decoding

Parameter # 1752 (SSI # F8h 06h D8h)

securPharm implements the IFA and GS1 Coding System for the European pharmaceutical industry. securPharm code is used to prevent pharmaceutical counterfeiting. This parameter enables or disables the ability to process pharmaceutical type barcodes.

When this feature is enabled, if a GS1 symbol is decoded and includes any aspects of the Application Identifier associated with the securPharm GS1 specifications, the entire GS1 symbol is processed as a securPharm symbol. For this reason, it is expected that under certain circumstances, a GS1 barcode that is a securPharm symbol may not be processed properly; if the GS1 symbol is not created as per the specification. The output cannot be guaranteed as valid.

Although the GS1-128 type and the GS1 DataBar family are not specifically indicated in the IFA specification, they are supported.

The securPharm output is in XML format and can include the product number, serial number, lot number, expiration and Date of Manufacturing. The XML tags can be arranged in any order. Tags that are not in the barcode are omitted. For example:

```
<content dfi="value_dfi">
```

```
<Daten_1>value_Daten_1</Daten_1>
```

```
<Daten_2>value_Daten_2</Daten_2>
```

```
<Daten_n>value_Daten_n</Daten_n>
```

```
</content>
```

Where:

- value_dfi = IFA or GS1
- Daten_1 to Daten_n is the production number, serial number, etc.



*Disable securPharm Decoding (0)



Enable securPharm Decoding (1)

securPharm Output Formatting

Parameter # 1753 (SSI # F8h 06h D9h)

securPharm Output Formatting parameter options represent bit positions. Therefore, any combination of formatting can be used.



NOTE: securPharm output formatting is effective only when [securPharm Decoding](#) is enabled.

When you scan a securPharm Output Formatting barcode, the securPharm output is formatted in a number of ways.

Sample GS1 Format

Product Number: GTIN Data Identifier DI Data Format Identifier: GS1

Data Carrier

*FNCI*041501 234567 82 

101 A234 B5*FNCI*

1717 231

> Scanned Barcode >

```
<content dfi="GS1">
<gtin>04150123456782</gtin>
  <lot>1A234B5</lot>
  <exp>151231</exp>
  <sn>1234567890123456</sn>
</content>
```

Sample GS1 Output - Feature Disabled

The output has no format:

```
0104150123456782101A234B517151231211234567890123456
```

Sample GS1 Output - No Formatting (0)

The output is a single line of characters:

```
<content dfi="GS1"><gtin>04150123456782</gtin><lot>1A234B5</lot><exp>151231</exp><sn>1234567890123456</sn></content>
```

Sample GS1 Output - Insert Tab (1)

The output is a single line of characters with a tab inserted in the XML body:

```
<content dfi="GS1">[tab]<gtin>04150123456782</gtin>[tab]<lot>1A234B5</lot>[tab]<exp>151231</exp>[tab]<sn>1234567890123456</sn></content>
```

Sample GS1 Output - Insert New Line (2)

The output consists of multiple lines of characters with a new line character at the end of each line.

```
<content dfi="GS1">
<gtin>04150123456782</gtin>
<lot>1A234B5</lot>
<exp>151231</exp>
<sn>1234567890123456</sn>
</content>
```

Sample GS1 Output - Insert Tab and New Line (3)

The output consists of multiple lines of characters with tabs and a new line character at the end of each line.

```
<content dfi="GS1">
[tab] <gtin>04150123456782</gtin>
[tab] <lot>1A234B5</lot>
[tab] <exp>151231</exp>
[tab] <sn>1234567890123456</sn>
</content>
```

Sample IFA Format

Product Number: PPN Data Identifier DI Data Format Identifier: IFA

<p>Data Carrier</p> <p><i>Mac06</i>9N1112 345678 2<i>Gs</i></p> <p>1T1A234B5 <i>Gs</i></p> <p>D15123 1 <i>Gs</i></p> 
--

> Scanned Barcode >

<pre><content dfi="IFA "> <ppn>11 1234567842 </ppn > <lot>1A 234B5</lot > <sn>123 4567890123 456</sn > </content ></pre>
--

Sample GS1 Output - Feature Disabled

The output has no format:

```
[ ]>069N1112345678421T1A234B5S1234567890123456
```

Sample GS1 Output - No Formatting (0)

The output is a single line of characters:

```
<content dfi="IFA"><ppn>111234567842</ppn><lot>1A234B5</lot><sn>1234567890123456</sn></content>
```

Sample GS1 Output - Insert Tab (1)

The output is a single line of characters with a tab inserted in the XML body:

```
<content dfi="IFA">[tab]<ppn>111234567842</ppn>[tab]<lot>1A234B5</lot>[tab]<sn>1234567890123456</sn></content>
```

Sample GS1 Output - Insert New Line (2)

The output consists of multiple lines of characters with a new line character at the end of each line.

```
<content dfi="IFA">
<ppn>111234567842</ppn>
<lot>1A234B5</lot>
<sn>1234567890123456</sn>
</content>
```

Sample GS1 Output - Insert Tab and New Line (3)

The output consists of multiple lines of characters with tabs and a new line character at the end of each line.

```
<content dfi="IFA">
[tab] <ppn>111234567842</ppn>
[tab] <ppn>111234567842</ppn>
[tab] <lot>1A234B5</lot>
[tab] <sn>1234567890123456</sn>
</content>
```

securPharm Output Formatting Barcodes

Scan a barcode below to format the securPharm output.



*No Formatting (0)



Insert Tab (1)



Insert New Line (2)

Non-Decode Event

Parameter # 2075 (SSI # F8 08 1B)

This parameter controls how the scanner will process a non-decode event (when an item passes through the decode zone but a barcode was not decoded).

The available options are:

- Disable - Non-Decode events will not be reported.
- Transmit to Host - Non-Decode events will be reported to the Host.
- Transmit to Color Camera - Non-Decode events be reported to the Color Camera.
- Transmit to Host and Color Camera - Non-Decode events be reported to the Host and Color Camera.

When a non-decode event is detected, the scanner will transmit the following unique barcode data “[Code128]ZTC:001”. A host application can be developed to act on this event.



*Disable (0)



Transmit to Host (1)



Transmit to Color Camera (2)

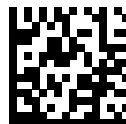

Transmit to Host and Color Camera (3)

Non-Decode Event Threshold

Parameter # 2076 (SSI # F8 08 1C)

This parameter sets the sensitivity level of detecting non-decode events.

If your system is detecting too many non-decode events, increase this threshold. If your system is not detecting enough non-decode events, decrease this threshold. To select the desired threshold, scan the following barcode, and then scan 3 barcodes from Numeric Barcodes that correspond to the desired value.

- Default is 70.
- Range 1-250.



Set non-decode event threshold

Miscellaneous Scanner Parameters

This section provides additional barcodes and parameters for miscellaneous options.

Enter Key

This parameter adds an Enter key (carriage return or line feed) after scanned data.

To program other prefixes and/or suffixes, see [Prefix/Suffix Values](#).



Add Enter Key (Carriage Return/Line Feed)

Tab Key

This parameter adds a Tab key after scanned data.



Tab Key

Transmit Code ID Character

Parameter # 45 (SSI # 2Dh)

A Code ID character identifies the code type of a scanned barcode. This is useful when decoding more than one code type. In addition to any single character prefix selected, the Code ID character is inserted between the prefix and the decoded symbol.

Select no Code ID character, a Symbol Code ID character, or an AIM Code ID character. For Code ID characters, see [Symbol Code Identifiers](#) and [AIM Code Identifiers](#).



Symbol Code ID Character (2)



AIM Code ID Character (1)



*None (0)

Prefix Suffix Values

Key Category Parameter # P = 99, S1 = 98, S2 = 100

Key Category SSI # P = 63h, S1 = 62h, S2 = 64h

Decimal Value Parameter # P = 105, S1 = 104, S2 = 106

Decimal Value SSI # P = 69h, S1 = 68h, S2 = 6Ah

This parameter appends up to one prefix or up to two suffix values to scan data for use in data editing. The default prefix and suffix value is 7013 <CR><LF> (Enter key).



NOTE: To use Prefix/Suffix values, first set the [Scan Data Transmission Format](#).

To set a value for a prefix or suffix, scan one of the following barcodes, and then scan four barcodes from [Numeric Barcodes](#) that correspond to that value. See [ASCII Character Sets](#) for the four-digit codes.

When using host commands to set the prefix or suffix, set the key category parameter to 1, and then set the 3-digit decimal value. See [ASCII Character Sets](#) for the four-digit codes.

To correct an error or change a selection, scan [Cancel](#).



Scan Prefix (7)



Scan Suffix 1 (6)



Scan Suffix 2 (8)

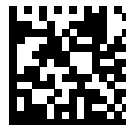

Data Format Cancel

Scan Data Transmission Format

Parameter # 235 (SSI # EBh)

This parameter selects the scan data format.



NOTE: If using this parameter do not use ADF rules to set the prefix/suffix.

To set values for the prefix or suffix, see [Prefix Suffix Values](#).



*Data As Is (0)

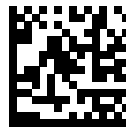

<DATA> <SUFFIX 1> (1)



<DATA> <SUFFIX 2> (2)

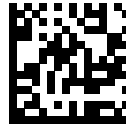

<DATA> <SUFFIX 1> <SUFFIX 2> (3)



<PREFIX> <DATA > (4)



<PREFIX> <DATA> <SUFFIX 1> (5)



<PREFIX> <DATA> <SUFFIX 2> (6)



<PREFIX> <DATA> <SUFFIX 1> <SUFFIX 2> (7)

FN1 Substitution Values

Key Category Parameter # 103 (SSI # 67h)

Decimal Value Parameter # 109 (SSI # 6Dh)

Keyboard wedge and USB HID keyboard hosts support a FN1 substitution feature. Enabling this substitutes any FN1 character (0x1b) in an EAN128 barcode with a value. This value defaults to 7013 <CR><LF> (Enter key).

When using host commands to set the FN1 substitution value, set the key category parameter to 1, and then set the 3-digit keystroke value. See the [ASCII Character Set](#) for the current host interface for the desired value.

Selecting a FN1 Substitution Value

Select a FN1 substitution value via the following barcode menus.

1. Scan the following barcode.

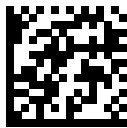

Set FN1 Substitution Value

2. Locate the keystroke desired for FN1 Substitution in the ASCII Character Set table for the current host interface, and enter the 4-digit ASCII value by scanning four barcodes from [Numeric Barcodes](#).

To correct an error or change the selection, scan [Cancel](#).

To enable FN1 substitution for USB HID keyboard, scan the [Enable FN1 Substitution](#) barcode.

Unsolicited Heartbeat Interval

Parameter # 1118 (SSI # F8h 04h 5Eh)

When this parameter is enabled, the scanner can send unsolicited heartbeat messages to assist in diagnostics. The range is 0 - 9999.

The heartbeat event is sent as decode data (with no decode beep) in the form of:

```
MOTEVTHB : nnn
```

Where: nnn is a three-digit sequence number starting at 001 and wrapping after 100.

To enable this parameter and set the desired unsolicited heartbeat interval, scan one of the following time interval barcodes, or scan Set Another Interval followed by four barcodes from [Numeric Barcodes](#) that correspond to the desired number of seconds.

Scan Disable Unsolicited Heartbeat Interval to turn off the feature.



10 Seconds (10)

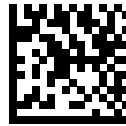

1 Minute (60)



Set Another Interval

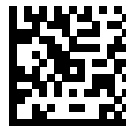

*Disable Unsolicited Heartbeat Interval (0)

Driver's License Set Up

The scanner uses internally embedded algorithms to parse out barcode information from standard US driver's licenses and certain other American Association of Motor Vehicle Administrators (AAMVA) compliant ID cards. Scanning these barcodes produces formatted data for use in age verification, credit card application information, and more.



NOTE: Only applies to -DL model digital scanners.

This section describes how to program the scanner to read and use the data contained in the 2D barcodes on US driver's licenses and AAMVA compliant ID cards.

Table 28 DL Parsing Parameter Table

Parameter	Default
DL Parsing Parameters	
Driver's License Parsing	No Driver's License Parsing
Parsing Driver's License Data Fields	N/A
Driver's License Parse Rules	N/A
AAMVA Parse Fields	N/A
Set Default Parameter	N/A
Output Gender as M or F	N/A
Date Format	CCYYMMDD
No Separator	N/A
Send Keystroke Control Characters Keyboard Characters	N/A
Parsing Rule Example	N/A
Embedded Driver's License Parsing ADF Example	N/A

Driver's License Parsing

Parameter # 645 (SSI #F1 85)

This parameter enables driver's license parsing on the scanner.



NOTE: This does not require Zebra software (.DLL).

Choose more options in the order indicating the sequence of data fields that the scanner outputs. See [Parsing Driver's License Data Fields](#) for more information.



*No Driver's License Parsing



Embedded Driver's License Parsing

Parsing Driver's License Data Fields (Embedded Driver's License Parsing)

To program a parsing rule:

1. Choose [Begin New Driver's License Parse Rule](#).
2. Choose any of the field options on the following pages, or [Send Keystroke \(Control Characters and Keyboard Characters\)](#).
3. After entering the entire rule, select [Save Driver's License Parse Rule](#) to save the rule.



NOTE: The scanner stores only one driver's license parsing rule in memory at a time. Saving a new rule replaces the prior rule.

4. To abort the programming sequence at any time during programming, choose [Quit Entering Driver's License Rule](#). Any previously saved rule is retained.
5. To erase a saved rule, select [Erase Driver's License Parse Rules](#).

Embedded Driver's License Parsing Criteria - Code Type

After specifying the fields and their order for the parsed driver's license, you can also apply standard ADF rules to the parsed data using the **Parsed Driver's License** criterion barcode in the Advanced Data Formatting Programmer Guide.



NOTE: Only create standard ADF rules on parsed driver's license data when configured for Embedded Driver's License Parsing.

See [Embedded Driver's License Parsing ADF Example](#) for a sample ADF rule using this code type criterion.

Driver's License Parse Rules

Choose an option to program a parsing rule.



Begin New Driver's License Parse Rule



Save Driver's License Parse Rule



Quit Entering Driver's License Rule



Erase Driver's License Parse Rules

Driver's License Parse Fields

These options are the supported parse fields for driver's license.

Not all IDs present data in the same format. For example, some IDs can have separate fields for first name, last name, and middle initial, while others have a single field with the entire name. Also, some IDs expire on the subject's birth date while the expiration date field only indicates the year. To present data in a consistent format, use the nine options provided in this section to return data calculated from the actual data contained in the ID barcode.



First Name



Middle Name/Initial



Last Name

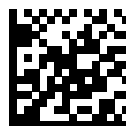

Name Suffix



Name Prefix



Expiration Date



Birth Date



Issue Date



ID Number (Formatted)

AAMVA Parse Fields

The scanner uses the specified fields to parse out information from American Association of Motor Vehicle Administrators (AAMVA) compliant ID cards.



AAMVA Issuer ID

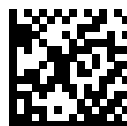

Full Name



Last Name

Driver's License Set Up



First Name



Middle Name / Initial



Name Suffix



Name Prefix



Mailing Address Line 1

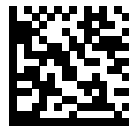

Mailing Address Line 2



Mailing Address City



Mailing Address State

Driver's License Set Up



Mailing Address Postal Code



Home Address Line 1



Home Address Line 2



Home Address City

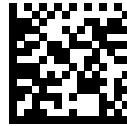

Home Address State



Home Address Postal Code



License ID Number



License Class

Driver's License Set Up



License Restrictions



License Endorsements



Height (Feet and/or Inches)



Height (Centimeters)



Weight (Pounds)



Weight (Kilograms)



Eye Color

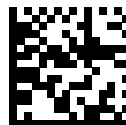

Hair Color

Driver's License Set Up



License Expiration Date

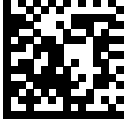

Birth Date

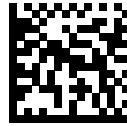

Gender



License Issue Date



License Issue State



Social Security Number



Permit Class



Permit Expiration Date

Driver's License Set Up



Permit ID Number



Permit Issue Date



Permit Restrictions

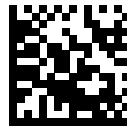

Permit Endorsements



AKA Social Security Name



AKA Full Name



AKA Last Name



AKA First Name

Driver's License Set Up



AKA Middle Name / Initial



AKA Name Suffix



AKA Name Prefix



AKA Birth Date

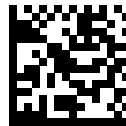

Issue Timestamp



Number of Duplicates



Medical Codes

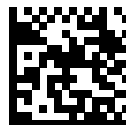

Organ Donor

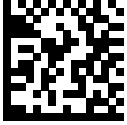

Nonresident



Customer ID



Weight Range



Document Discriminator



Country



Federal Commission Codes

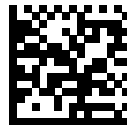

Place of Birth



Audit Information



Inventory Control



Race / Ethnicity



Std Vehicle Class



Std Endorsements



Std Restrictions



Class Description



Endorsement Description

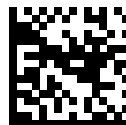

Restrictions Description



Height in Inches

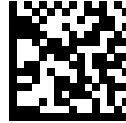

Height in Centimeters



Std Endorsements

Parser Version ID Barcode

Include this field to emit embedded parser software version identification.

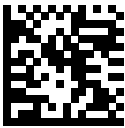

Parser Version ID

DL Parsing User Preferences

Use the following barcodes to set user preferences.

Set Default Parameter

This parameter returns all parameters to the default values.

See the default value tables in each chapter.



*Set All Defaults

Output Gender as M or F

Select this parameter to report the gender as M or F instead of a numeric value.

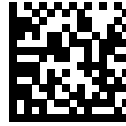

Output gender as M or F

Date Format

Use this parameter to select the date format to display.

Date fields include the following:

- CCYY = 4-digit year (CC=2-digit century [00-99], YY=2-digit year in the century [00-99])
- MM = 2-digit month [01-12]
- DD = 2-digit day of the month [00-31]

To specify a date separator, for example, a character separating each field of the date, select the Send <character> option that corresponds to the alphanumeric character to use as the date separator immediately following the date format barcode. To select no date separator, select the No Separator DL parsing rule immediately following the date format.



DDMMCCYY

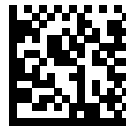

DDCCYYMM



YYMMDD

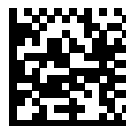

YYDDMM



MMDDYY

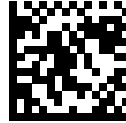

MMYDD



DDMMYY



DDYYMM

No Separator

This parameter immediately follows a date format barcode to use no separator character between the date fields.



No Separator

Send Keystroke (Control Characters and Keyboard Characters)

Specify a Control Character or a Keyboard Character to send.

Control Characters

Select a Send Control parameter for the control character to send.



Send Control A



Send Control B



Send Control C



Send Control D



Send Control E



Send Control F



Send Control G



Send Control H



Send Control I

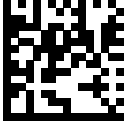

Send Control J



Send Control K



Send Control L



Send Control M



Send Control N

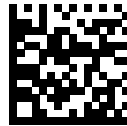

Send Control O



Send Control P



Send Control Q

Driver's License Set Up



Send Control R



Send Control S



Send Control T

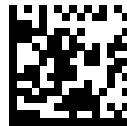

Send Control U



Send Control V



Send Control W



Send Control X

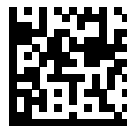

Send Control Y



Send Control Z



Send Control [



Send Control \



Send Control]



Send Control 6



Send Control -

Keyboard Characters

Select a Send parameter for the specific keyboard characters to send.



Send Space



Send !

Driver's License Set Up



Send "



Send #



Send \$



Send %



Send &



Send '



Send (

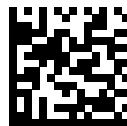

Send)



Send *

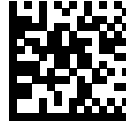

Send +



Send ,

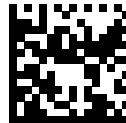

Send -



Send .

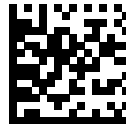

Send /



Send 0



Send 1

Driver's License Set Up



Send 2



Send 3



Send 4



Send 5



Send 6



Send 7



Send 8



Send 9

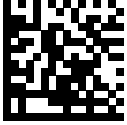

Send :

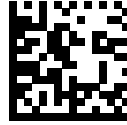

Send ;



Send <



Send =



Send >

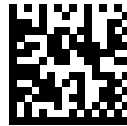

Send ?



Send @



Send A

Driver's License Set Up



Send B

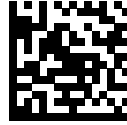

Send C



Send D



Send E



Send F



Send G



Send H



Send I

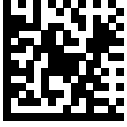

Send J



Send K



Send L



Send M



Send N



Send O



Send P



Send Q

Driver's License Set Up



Send R



Send S



Send T



Send U



Send V



Send W



Send X

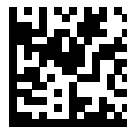

Send Y



Send Z



Send [



Send \

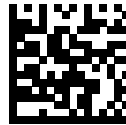

Send]



Send ^



Send _



Send `



Send a

Driver's License Set Up



Send b



Send c



Send d



Send e



Send f

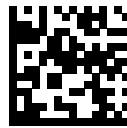

Send g



Send h

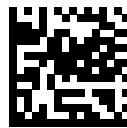

Send i



Send j

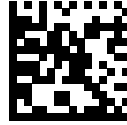

Send k



Send l

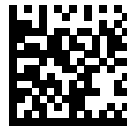

Send m



Send n

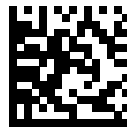

Send o



Send p

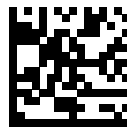

Send q



Send r



Send s



Send t



Send u



Send v



Send w



Send x

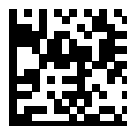

Send y



Send z



Send {



Send |



Send }



Send ~



Send Tab Key



Send Enter Key

Parsing Rule Example

Follow the sequence to examine how a parsing rule is created.

Choose the parameters in sequence to program the scanner to extract and transmit:

- first, middle, and last names
- mailing address line 1
- mailing address line 2

Driver's License Set Up

- mailing address city
- mailing address state
- mailing address postal code
- date of birth

Then, scan a driver's license barcode.



NOTE: This example applies to RS-232. To use this example with a USB interface, enable [USB Function Key Mapping](#) to send the Enter key properly.



1 - Embedded Driver's License Parsing



2 - Begin New Driver's License Parse Rule



3 - First Name

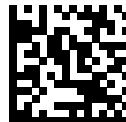

4 - Send Space



5 - Middle Name / Initial



6 - Send Space



7 - Last Name



8 - Send Enter Key



9 - Mailing Address Line 1

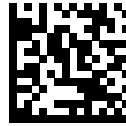

10 - Send Space



11 - Mailing Address Line 2



12 - Send Enter Key



13 - Mailing Address City



14 - Send Space



15 - Mailing Address State



16 - Send Space



17 - Mailing Address Postal Code



18 - Send Enter Key



19 - Birth Date

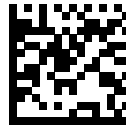

20 - Send Enter Key



21 - Save Driver's Licence Parse Rule

Embedded Driver's License Parsing ADF Example

This example creates a parsing rule for parsed data.

The parsing rule configures the data in the following format:

```
Last Name, First Name
```



1 - Begin New Driver's License Parse Rule

Driver's License Set Up



2 - Last Name



3 - Send ,



4 - Send Space



5 - First Name



6 - Save Driver's Licence Parse Rule

Then, in order to limit the full name to 15 characters, create the following ADF rule:



1 - Begin New Rule



2 - Criterion: Parsed Driver's License



3 - Action: Send Next 15 Characters



4 - Save Rule

For a license belonging to Michael Williams, the parsed data is Williams, Michael and Williams, Micha after applying the previous ADF rule.

Custom Tone Introduction

The imager supports downloading a custom tone to sound when a good decode occurs.

Create the audio tone according to the following specifications:

- Use a WAV audio file format; acceptable file extensions are .wav and .wave.
- Encode the audio file at 16 samples per second, i.e., 16 kHz sampling rate.
- Encode the audio file at 16 bits per sample.
- Encode the audio file with a single channel (mono). WAVE audio type/format = PCM (Pulse Coded Modulation).
- Ensure the audio file does not exceed 65 kBytes.
- Ensure the audio file name does not exceed 31 bytes.

Downloading a Custom Tone via 123 Scan

1. Download and install Zebra's 123Scan Scanner Configuration Utility from the support web site: zebra.com/123Scan.

2. Open 123Scan.

Figure 13 123 Scan Utility

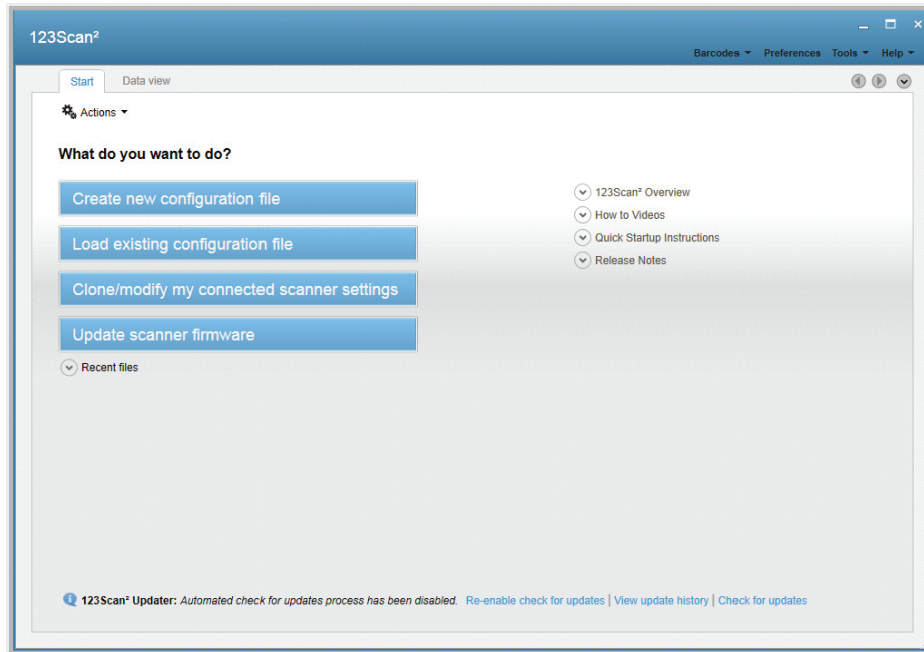

3. Select **Clone/modify my connected scanner settings**.

Figure 14 USB Parameter Change Window

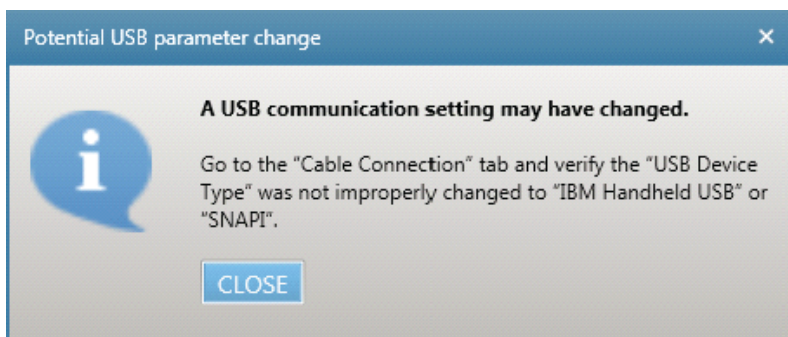

4. Select **CLOSE** in the dialog window.

Figure 15 General Parameters Sections

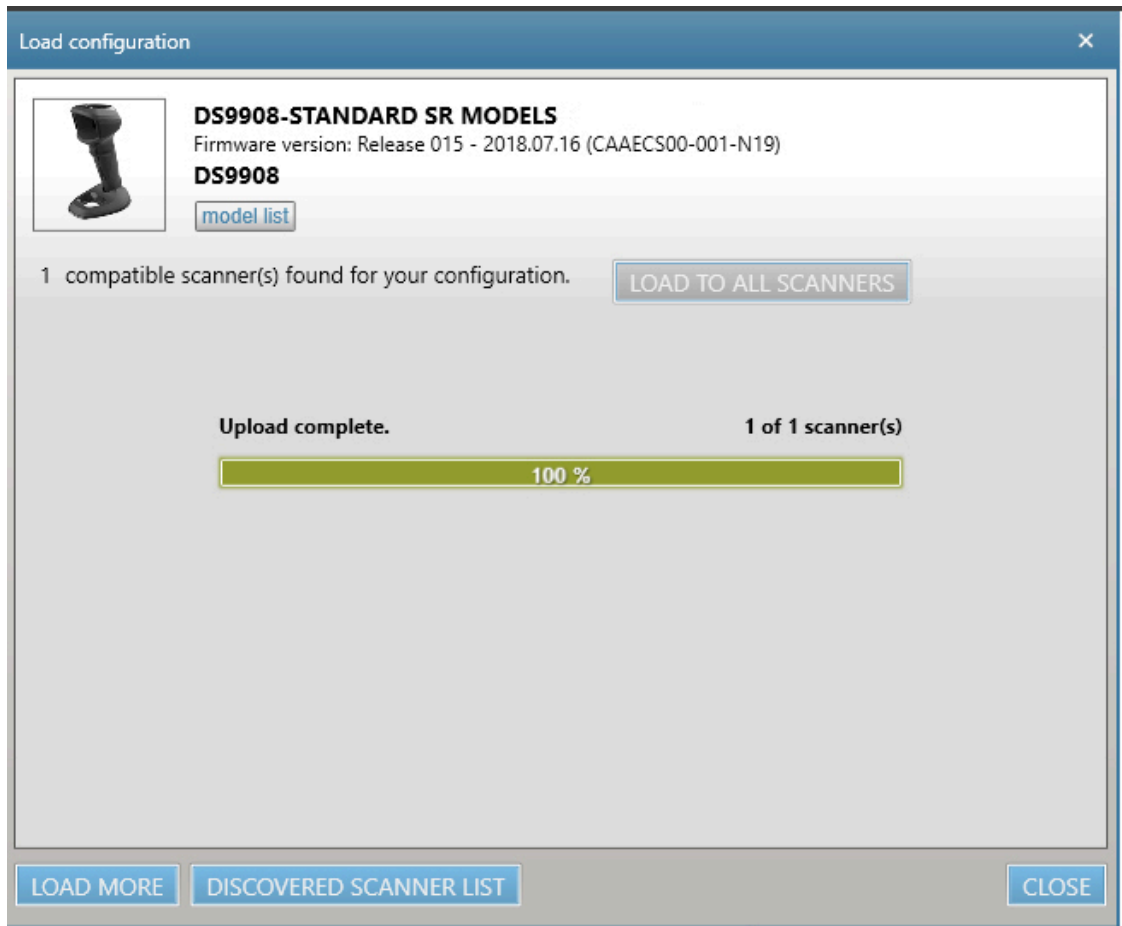

5. Select **General > Beeper**.

- Click **Select Tone from PC** button to navigate to and select the custom tone.

Figure 16 Enable Custom Scan Tone Window

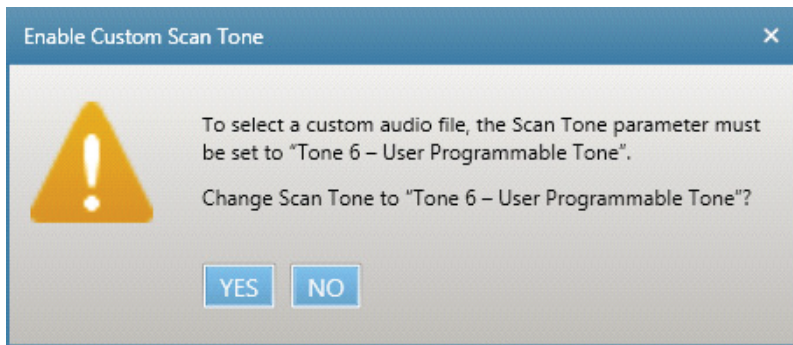

- Select **YES** on the dialog window to set the Scan Tone parameter to the **User Programmable/Tone 6** option.

The **Scan Tone** field indicates **Tone 6 - User Programmable**, and the **Set Custom Scan Tone** field now reflects the selected WAV file name.

Figure 17 Updated General Parameters Section

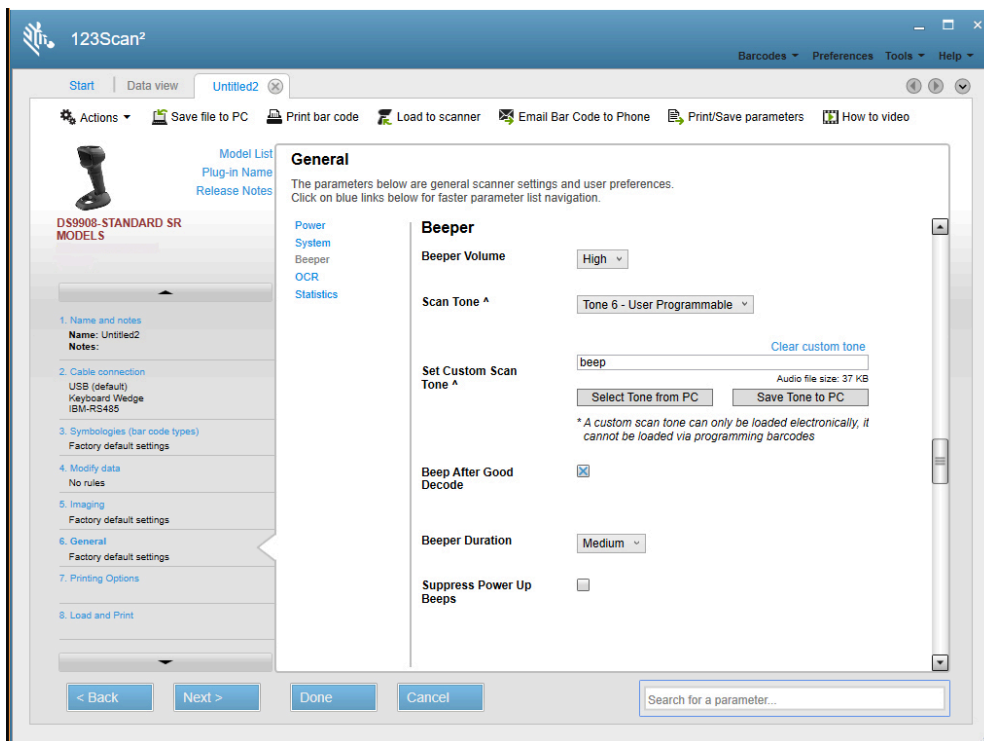

8. Select **Load to Scanner** at the top of the window.

Figure 18 Load Configuration Window

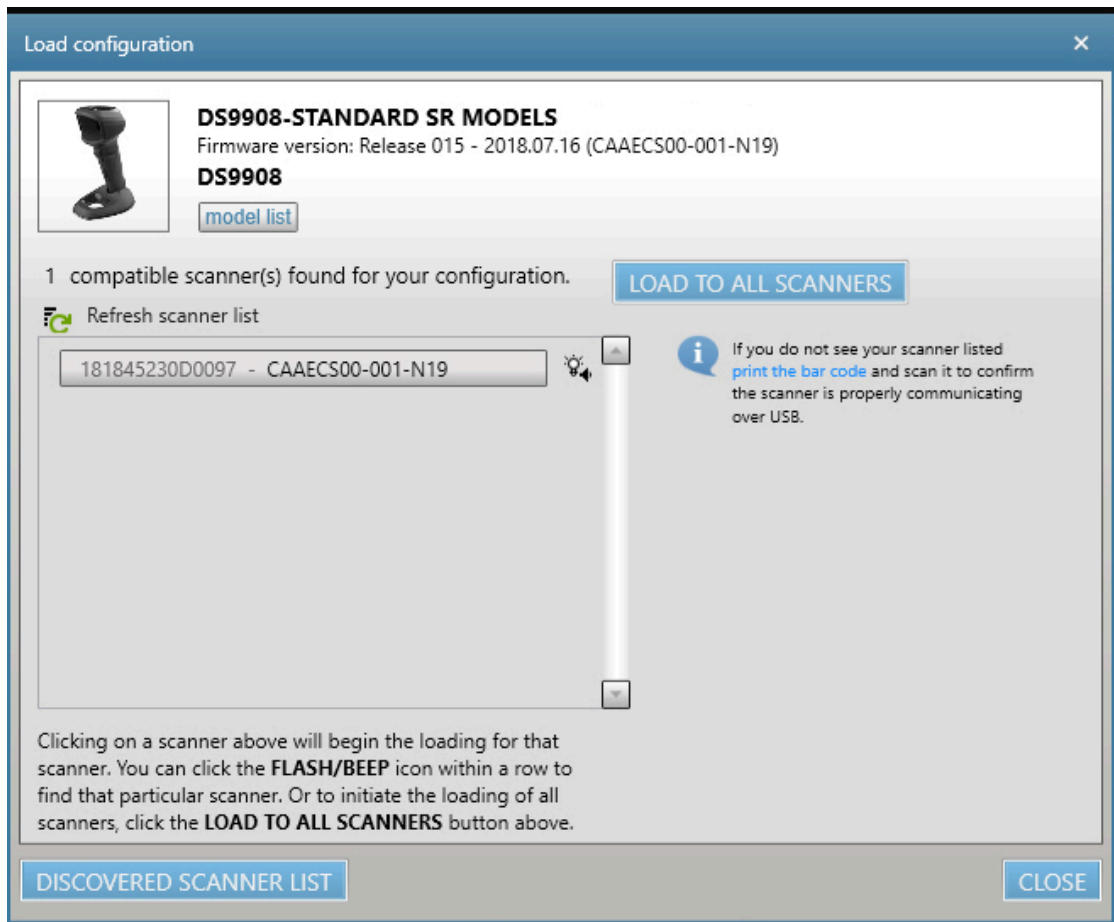

9. Select a scanner in the list or select **LOAD TO ALL SCANNERS** to send the configuration file to all scanners listed.

Figure 19 Load Configuration Complete Window

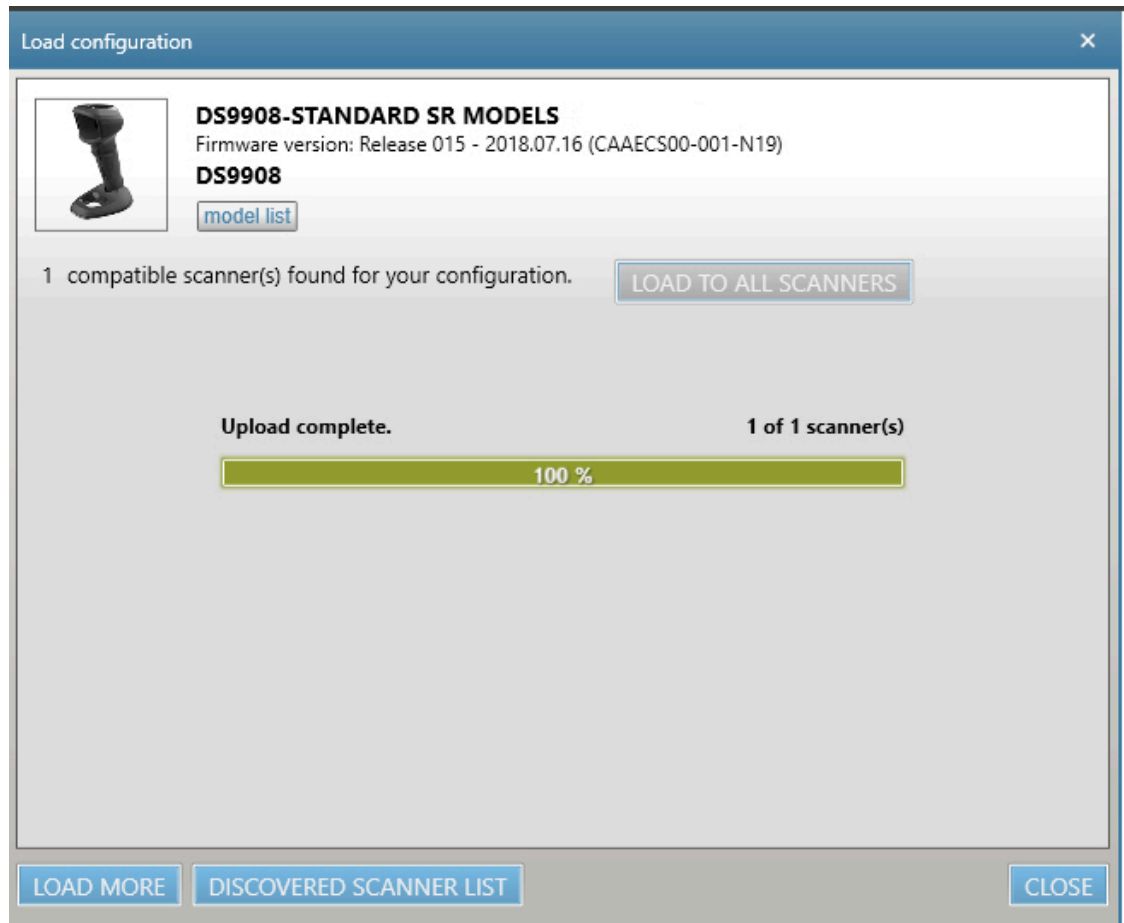

10. Select **CLOSE** when the upload completes.
11. Verify that the custom tone was successfully downloaded to the scanner by scanning a barcode.

Downloading a Custom Tone via Scanner SDK Sample Application

Download a custom audio file to the imager using the Scanner SDK C++ Sample Application. The user-defined tone is represented by a unique attribute number.

1. Place the imager in SNAPI USB communication mode by scanning [Symbol Native API \(SNAPI\)](#) with Imaging Interface.
2. Ensure the imager is disconnected from the host PC.

3. To launch the **Scanner SDK C++ Sample Application** , on the host PC select **Start > Scanner > Scanner SDK > C++ Sample Application**.

Figure 20 Scanner SDK C++ Sample Application

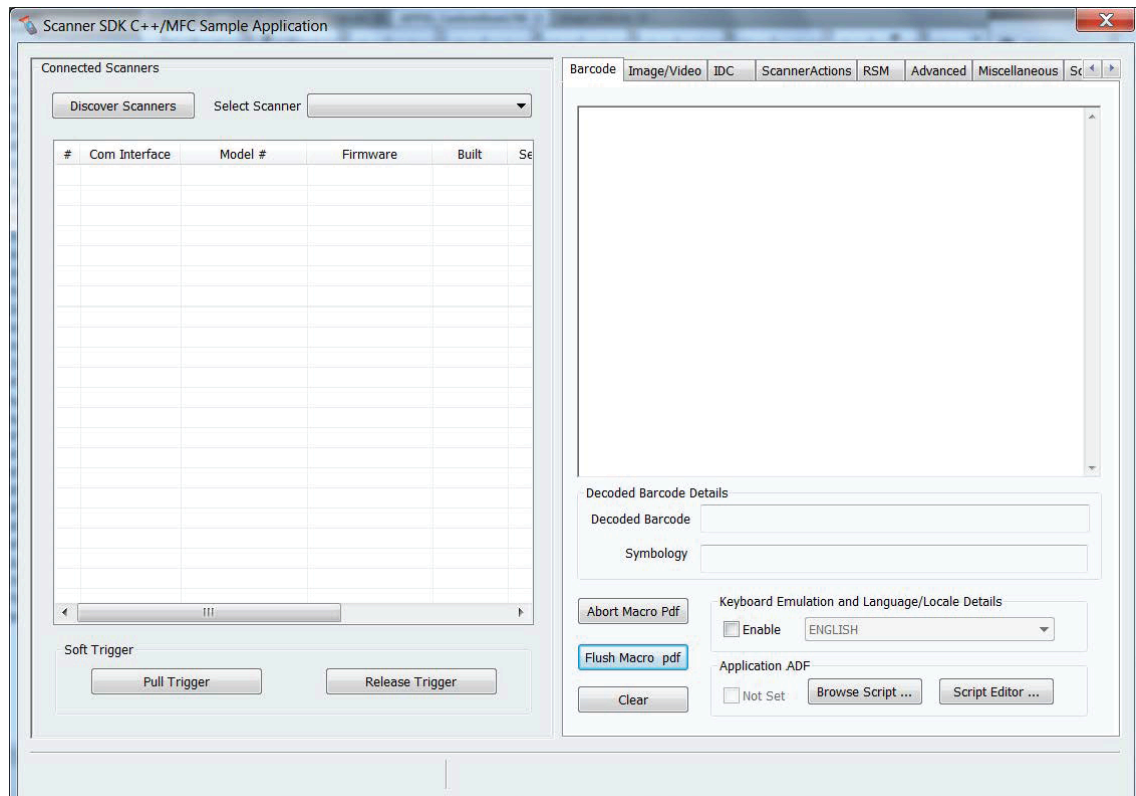

4. Connect the imager to a USB port on the PC and wait for the power-up tone.
5. Verify imager is operational by touching the trigger to turn on illumination.
6. Select **Discover Scanners** in the SDK application. The imager appears in the Connected Scanners list.
7. Select the **Advanced** tab
8. In the **Custom Good Decode Tone** section of the window, select Browse.
9. Select the WAV file to download. Ensure the file does not exceed 65 kB.
10. Select **Upload**. After a few seconds the status bar on the bottom of the window displays **UPDATE_AUDIO_FILE - Command Success**.
11. Scan the **Scan Tone 6** barcode via the parameter [Scan Tone](#) .

12. Scan a barcode (see [Sample Barcodes](#)) to verify that the imager sounds the downloaded scan tone.

Image Capture Preferences

You can program the imager to perform various functions, or you can activate different features. This section describes image capture preference features and provides programming barcodes for selecting these features.



NOTE: Only the Symbol Native API (SNAPI) with Imaging interface supports image capture. See [USB Device Type](#) to enable this host.

The imager ships with the settings shown in [Image Capture Preferences Parameter Defaults](#) (also see [Standard Parameter Defaults](#) for all defaults). If the default values suit requirements, programming is not necessary.

Setting Image Capture Parameters

To set feature values, scan a single barcode or a short barcode sequence. The settings are stored in non-volatile memory and are preserved even when the imager powers down.



NOTE: Most computer monitors allow scanning barcodes directly on the screen. When scanning from the screen, be sure to set the document magnification to a level where you can see the barcode clearly, and bars and/or spaces do not merge.

To return all features to default values, scan the [factory defaults](#). Throughout the programming barcode menus, asterisks (*) indicate default values, followed by the feature description and value.

Image Capture Scanning Sequence Examples

You can scan a barcode to set a parameter value.

For example, to disable image capture illumination, scan the Disable Image Capture Illumination barcode found in [Image Capture Illumination](#). After enabling this setting, the imager issues a fast warble beep and the LED turns green, signifying a successful parameter entry.

Other parameters require scanning several barcodes. See the parameter descriptions for this procedure.

Image Capture Errors While Scanning

Unless otherwise specified, to correct an error during a scanning sequence, just re-scan the correct parameter.

Image Capture Preferences Parameter Defaults

The image capture preferences parameter defaults lists defaults for image capture preference parameters.

You can change values in one of two ways:

- Scan the appropriate barcodes in this chapter. The new value replaces the standard default value in memory. To recall default parameter values, see [Default Parameters](#).
- Configure the scanner using the 123Scan configuration program. See [123Scan and Software Tools](#).

Table 29 Image Capture Preferences Parameter Defaults

Parameter	Parameter Number ^a	SSI Number ^b	Default
Image Capture Preferences			
Snapshot Mode	N/A	N/A	N/A
Image Capture Illumination	361	F0h 69h	Enable
Image Capture Autoexposure	360	F0h 68h	Enable
Fixed Exposure	567	F4h F1h 37h	10
Digital Gain	1233	F4h D1h	16
Snapshot Mode Timeout	323	F0h 43h	30 seconds
Silence Operational Mode Changes	1293	F8h 05h 0Dh	Disable
Image Cropping	302	F0h 2Dh	Disable
Crop to Pixel Addresses	315 316 317 318	F4h F0h 3Bh F4h F0h 3Ch F4h F0h 3Dh F4h F0h 3Eh	0 top 0 left 1199 bottom 1919 right
Image Size (Number of Pixels)	302	F0h 2Eh	Full
Image Brightness (Target White)	390	F0h 86h	180
JPEG Image Options	299	F0h 2Bh	Quality
JPEG Quality Value	305	F0h 31h	65
JPEG Size Value	561	F1h 31h	160 kB
Image Enhancement	564	F1h 34h	Low (1)
Image File Format Selection	304	F0h 30h	JPEG
Image Rotation	665	F1h 99h	0
Bits Per Pixel	303	F0h 2Fh	8 BPP
Camera Button	1716	F8h 06h B4h	Disable
Camera Button Delay	1717	F8h 06h B5h	20 seconds
Color Camera Mode	2385	F8 09 51	0

^a Parameter number decimal values are used for programming via RSM commands.

^b SSI number hex values are used for programming via SSI commands.

Image Capture Preferences Modes and Parameters

The parameters in this section control image capture characteristics.

Snapshot Mode

Use Snapshot Mode to capture a high-quality image and transmit it to the host. Select the Snapshot Mode option to temporarily enter this mode. While in this mode the imager blinks the green LED at one-second intervals to indicate it is not in standard operating (decode) mode.

In Snapshot Mode, the imager turns on its aiming pattern to highlight the area to capture in the image. The next trigger press instructs the imager to capture a high quality image and transmit it to the host. A short time may pass (less than two seconds) between when the trigger is pressed and the image is captured as the imager adjusts to lighting conditions.

If you do not press the trigger within the Snapshot Mode Timeout period, the imager returns to Decode Mode. Use [Snapshot Mode Timeout](#) to adjust this timeout period. The default timeout period is 30 seconds.



Snapshot Mode

Image Capture Illumination

Parameter # 361 (SSI # F0h 69h)

This parameter turns on illumination during every image capture.

- Enabled - Illumination is on during image capture.
- Disabled - Prevents the imager from using illumination.



NOTE: This usually results in superior images. The effectiveness of illumination decreases as the distance to the target increases.



*Enable Image Capture Illumination (1)

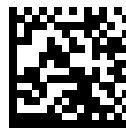

Disable Image Capture Illumination (0)

Image Capture Autoexposure

Parameter # 360 (SSI # F0h 68h)

This parameter enables the imager to control gain and exposure (integration time) settings to best capture an image for Snapshot mode.

- Enabled - Allows the imager to control gain and exposure settings to best capture an image.
- Disabled - Manually adjust the gain and exposure time.



NOTE: Disabling Image Capture Autoexposure is only recommended for advanced users with difficult image capture situations.



*Enable Image Capture Autoexposure (1)

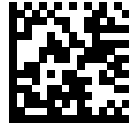

Disable Image Capture Autoexposure (0)

Fixed Exposure

Parameter # 567 (SSI # F4h F1h 37h)

This parameter configures the exposure used in manual mode for Snapshot and Video modes. Each integer value represents 18.5 microseconds of exposure. The default value is 10 which results in an exposure setting of 185 microseconds.

Type: Word

Range: 2- 30000

To set the exposure, scan the Fixed Exposure barcode, and then scan four numeric barcodes from [Numeric Barcodes](#) representing the value. Leading zeros are required. For example, to set a Fixed Exposure value of 99, scan 0, 0, 9, 9.

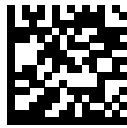

Fixed Exposure (4 digits)

Digital Gain

Parameter # 1233 (SSI # F4h D1h)

This parameter adjusts the digital gain.

A value of 32 = x 1 digital gain; for example, digital gain = 1/32 x digital gain parameter value.

Scan the following barcode, and then scan two barcodes from [Numeric Barcodes](#) to enter a 2-digit value for the digital gain. The default is 16.



Digital Gain

Snapshot Mode Timeout

Parameter # 323 (SSI # F0h 43h)

This parameter sets the amount of time the imager remains in Snapshot Mode.

- Set Snapshot Mode Timeout - scan this parameter and then scan a barcode from [Numeric Barcodes](#). Values increment by 30. For example, 1 = 60 seconds, 2 = 90 seconds.
- 30 Seconds - resets timeout to 30 seconds.
- No Timeout - the imager remains in Snapshot Mode until you press the trigger.

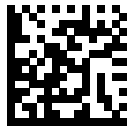

Set Snapshot Mode Timeout



*30 Seconds

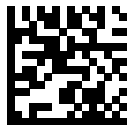

No Timeout

Silence Operational Mode Changes

Parameter # 1293 (SSI # F8h 05h 0Dh)

This parameter silences the beeper when switching between operational modes (for example, from Decode Mode to Snapshot Mode).

- Enabled - Silences the beep when switching between operational modes.
- Disabled - Allows the beep when switching between operational modes.



Silence Operational Mode Changes (Enable) (1)



*Do Not Silence Operational Mode Changes (Disable) (0)

Image Cropping

Parameter # 301 (SSI # F0h 2Dh)

This parameter crops a captured image to the pixel addresses set in Crop to Pixel Addresses.

- Enabled - Crops the captured image.
- Disabled - Does not crop the captured image.



Enable Image Cropping (1)



*Disable Image Cropping (Use Full 1920 X 1200 Pixels) (0)

Crop to Pixel Addresses

Parameter # 315 (SSI # F4h F0h 3Bh) (Top)

Parameter # 316 (SSI # F4h F0h 3Ch) (Left)

Parameter # 317 (SSI # F4h F0h 3Dh) (Bottom)

Parameter # 318 (SSI # F4h F0h 3Eh) (Right)

When Image Cropping is enabled, use this parameter to set the pixel addresses.

The pixel addresses value range is (0,0) to [1919] x [1199].

- Top Pixel Address - A value with the left pixel address to begin an image crop.
- Left Pixel Address - A value with the top pixel address to begin an image crop.
- Right Pixel Address - A value with the right pixel address to end an image crop.
- Bottom Pixel Address - A value with the right pixel address to end an image crop.

Columns are numbered from 0 to [1919], rows from 0 to [1199]. Specify values for Top, Left, Bottom, and Right, where Top and Bottom correspond to row pixel addresses, and Left and Right correspond to column pixel addresses.



NOTE: The imager has a cropping resolution of 4 pixels. Setting the cropping area to less than 4 pixels (after resolution adjustment, see [Image Size](#)) transfers the entire image.

To crop to the pixel addresses, enable Image Cropping, and then scan four numeric barcodes from [Numeric Barcodes](#) representing the value.



Top Pixel Address (0 - [1199] Decimal)



Left Pixel Address (0 - [1919] Decimal)

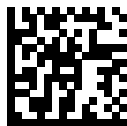

Bottom Pixel Address (0 - [1199] Decimal)



Right Pixel Address (0 - [1919] Decimal)

Image Size (Number of Pixels)

Parameter # 302 (SSI # F0h 2Eh)

This option alters image resolution before compression. Multiple pixels are combined into one pixel, resulting in a smaller image containing the original content with reduced resolution.

Select a resolution value to produce an image size.

Table 30 Image Size

Resolution Value	Uncropped Image Size
Full	1920 x 1200
1/2	960 x 600
1/4	640 x 400



*Full Resolution (0)



1/2 Resolution (1)



1/4 Resolution (3)

Image Brightness (Target White)

Parameter # 390 (SSI # F0h 86h)

This parameter sets the Target White value used in Snapshot and Video Viewfinder modes when using auto exposure.

Type: Byte

Range: [1 - 240]

- Image Brightness (3 digits) - Represents the image brightness value.
- 180 - Sets the white level of the image to ~180.



NOTE: White and black are defined as the maximum value decimal and 1, respectively.

Scan Image Brightness, and then scan three numeric barcodes from [Numeric Barcodes](#) representing the value. Leading zeros are required. For example, to set an Image Brightness value of 99, scan 0, 9, 9.



*180



Image Brightness (3 digits)

JPEG Image Options

Parameter # 299 (SSI # F0h 2Bh)

This parameter changes the JPEG image quality or size.

- JPEG Quality Selector - Enter a quality value via the [JPEG Quality Value](#) parameter; the imager then selects the corresponding image size.
- JPEG Size Selector - Enter a size value via the [JPEG Size Value](#) parameter; the imager then selects the best image quality.



*JPEG Quality Selector (1)

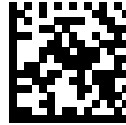

JPEG Size Selector (0)

JPEG Quality Value

Parameter # 305 (SSI # F0h 31h)

This parameter adjusts the quality of the JPEG.



NOTE: Use this parameter if you selected JPEG Quality Selector as a JPEG Image Option.

Scan the JPEG Quality Value, and then scan three barcodes from [Numeric Barcodes](#) corresponding to a value from 5 to 100, where 100 represents the highest quality image. Leading zeros are required. For example, to set an image quality value of 55, scan 0, 5, 5.

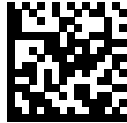

JPEG Quality Value (Default: 065) (5 - 100 Decimal)

JPEG Size Value

Parameter # 561 (SSI # F1h 31h)

Type: Word

Range: [5-350]

If you selected JPEG Size Selector, use JPEG Size Value to set the JPEG size.



CAUTION: JPEG compression may take 10 to 15 seconds based on the amount of information in the target image. Selecting [JPEG Quality Selector](#) produces a compressed image that is consistent in quality and compression time.

To set the JPEG size, scan JPEG Size Value and then scan three numeric barcodes from [Numeric Barcodes](#) representing the target JPEG file size in kilobytes (KB). Leading zeros are required. For example, to set an image file size value of 99, scan 0, 9, 9.



JPEG Size Value (Default: 160) (3 digits)

Image Enhancement

Parameter # 564 (SSI # F1h 34h)

This parameter uses a combination of edge sharpening and contrast enhancement to produce an image that is visually pleasing.

Select the level of image enhancement:

- Off (0)
- Low (1)
- Medium (2)
- High (3)



Off (0)



*Low (1)



Medium (2)



High (3)

Image File Format Selector

Parameter # 304 (SSI # F0h 30h)

Use this parameter to select an image format appropriate for the system (BMP, TIFF, or JPEG). The imager stores captured images in the selected format.



BMP File Format (3)

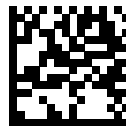

*JPEG File Format (1)



TIFF File Format (4)

Image Rotation

Parameter # 665 (SSI # F1h 99h)

Use this parameter to rotate an image by 90-degree increments (0, 90, 180, or 270).



*Rotate 0° (0)



Rotate 90° (1)



Rotate 180° (2)



Rotate 270° (3)

Bits Per Pixel

Parameter # 303 (SSI # F0h 2Fh)

Use this parameter to select the number of significant bits per pixel (BPP) to use when capturing an image.

- 1 BPP - For a black and white image.
- 4 BPP - Assigns 1 of 16 levels of grey to each pixel.
- 8 BPP - Assigns 1 of 256 levels of grey to each pixel.



NOTE: The imager ignores these settings for JPEG file formats, which only support 8 BPP. TIFF file formats only support 4 BPP and 8 BPP. Selecting **1 BPP** for TIFF applies the 4 BPP option.



1 BPP (0)

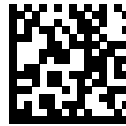

4 BPP (1)



*8 BPP (2)

Camera Button

Parameter # 1716 (SSI # F8h 06h B4h)

This parameter allows the camera button on the front of the tower to capture images.

- Disabled - The camera button cannot be used.
- Enabled - The camera button is used. The camera button is configured for the decode sensor.
- Enabled (color camera) - The camera button configured for color camera sensor. The color camera must be attached.



NOTE: The parameter is only valid if the scanner is in USB SNAPI with Imaging mode (see [Symbol Native API \(SNAPI\)](#)).



*Disable Camera Button (0)

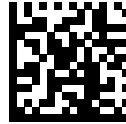

Enable Camera Button (1)



Enabled Camera Button:Color Camera (2)

Camera Button Delay

Parameter # 1717 (SSI # F8h 06h B5h)

This parameter controls the camera shutter delay, or the time delay between pressing the camera button and actually capturing the image.

This delay allows the user time to place the item into the proper position for capturing the image. Units of time are in increments of 100 ms.

Range: 0-255 ms.

Scan Camera Shutter Delay to set a time delay value, and then scan three barcodes from [Numeric Barcodes](#). Enter a leading zero for single digit numbers. To correct an error or change a selection, scan [Cancel](#).



Camera Shutter Delay

Color Camera Mode

Parameter # 2385 (SSI # F8 09 51)

Scan one of the following barcodes to select which video mode on the color camera is optimized when using object detect to detect motion.



NOTE: It is only required to change from default when using 'Motion Detect Mode = Object-Detect'.

- 0* - Keep this setting if the Color-Camera is not running 'Video-Mode=2/Continuous Mode' (the Color Camera default mode).
- 2 – Only use this setting when the following apply.
 - The scanner is in Motion-Detect=Object-Detect mode
 - Color Camera is set for Video-Mode=2/Continuous Mode.



0*



2

Symbologies

You can program the scanner to perform various functions, or activate different features.

This section describes symbology features and provides programming barcodes for selecting these features.

The scanner ships with the settings shown in [Symbology Parameter Defaults](#). If the default values suit requirements, programming is not necessary.

Symbology Parameter Defaults

The following table lists defaults for all symbology parameters.

Change these values in one of two ways:

- Choose the appropriate parameter in this section. The new value replaces the standard default value in memory. To recall the default parameter values, see [Default Parameters](#).
- Configure the scanner using the 123Scan configuration program. See [123Scan and Software Tools](#).

Table 31 Symbology Parameter Defaults

Parameter	Parameter Number ^a	SSI Number ^b	Default
Enable/Disable All Code Types			
1D Symbologies			
UPC/EAN/JAN			
UPC-A	1	01h	Enable
UPC-E	2	02h	Enable
UPC-E1	12	0Ch	Disable
EAN-8/JAN 8	4	04h	Enable
EAN-13/JAN 13	3	03h	Enable
Bookland EAN	83	53h	Disable
Bookland ISBN Format	576	F1h 40h	ISBN-10
ISSN EAN	617	F1h 69h	Disable
Decode UPC/EAN/JAN Supplementals (2 and 5 digits)	16	10h	Ignore
User-Programmable Supplementals	579, 580	F4h F1h 43hF4h F1h 44h	000
UPC/EAN/JAN Supplemental Redundancy	80	50h	10
UPC/EAN/JAN Supplemental AIM ID	672	F1h A0h	Combined
Transmit UPC-A Check Digit	40	28h	Enable
Transmit UPC-E Check Digit	41	29h	Enable
Transmit UPC-E1 Check Digit	42	2Ah	Enable
UPC-A Preamble	34	22h	System Character
UPC-E Preamble	35	23h	System Character
UPC-E1 Preamble	36	24h	System Character
Convert UPC-E to UPC-A	37	25h	Disable
Convert UPC-E1 to UPC-A	38	26h	Disable
EAN/JAN Zero Extend	39	27h	Disable
UCC Coupon Extended Code	85	55h	Disable

Table 31 Symbology Parameter Defaults (Continued)

Parameter	Parameter Number ^a	SSI Number ^b	Default
Coupon Report	730	F1h DAh	New Coupon Format
UPC Reduced Quiet Zone	1289	F8h 05h 09h	Disable
Digimarc Digital Watermark	1687	F8h 06h 97h	Disable
Linear UPC/EAN	68	44h	Disable
Code 128			
Code 128	8	08h	Enable
Set Length(s) for Code 128	209, 210	D1h, D2h	0 to 80
GS1-128 (formerly UCC/EAN-128)	14	0Eh	Enable
ISBT 128	84	54h	Enable
ISBT Concatenation	577	F1h 41h	Disable
Check ISBT Table	578	F1h 42h	Enable
ISBT Concatenation Redundancy	223	DFh	10
Code 128 <FNC4>	1254	F8h 04h E6h	Honor
Code 128 Security Level	751	F1h EFh	Security Level 1
Code 128 Reduced Quiet Zone	1208	F8h 04h B8h	Disable
Code 39			
Code 39	0	00h	Enable
Trioptic Code 39	13	0Dh	Disable
Convert Code 39 to Code 32 (Italian Pharmacy Code)	86	56h	Disable
Code 32 Prefix	231	E7h	Disable
Set Length(s) for Code 39	18, 19	12h, 13h	1 to 55
Code 39 Check Digit Verification	48	30h	Disable
Transmit Code 39 Check Digit	43	2Bh	Disable
Transmit Code 39 Stop/Start	1900	F8 07 6Ch	Disable
Code 39 Full ASCII Conversion	17	11h	Disable
Code 39 Security Level	750	F1h EEh	Security Level 1
Code 39 Reduced Quiet Zone	1209	F8h 04h B9h	Disable
Code 93			
Code 93	9	09h	Enable
Set Length(s) for Code 93	26, 27	1Ah, 1Bh	1 to 55
Code 11			
Code 11	10	0Ah	Disable

Table 31 Symbology Parameter Defaults (Continued)

Parameter	Parameter Number ^a	SSI Number ^b	Default
Set Lengths for Code 11	28, 29	1Ch, 1Dh	4 to 55
Code 11 Check Digit Verification	52	34h	Disable
Transmit Code 11 Check Digit(s)	47	2Fh	Disable
Interleaved 2 of 5 (ITF)			
Interleaved 2 of 5 (ITF)	6	06h	Enable
Set Lengths for I 2 of 5	22, 23	16h, 17h	6 to 55
I 2 of 5 Check Digit Verification	49	31h	Disable
Transmit I 2 of 5 Check Digit	44	2Ch	Disable
Convert I 2 of 5 to EAN 13	82	52h	Disable
Febraban	1750	F8h 06h D6h	Disable
I 2 of 5 Security Level	1121	F8h 04h 61h	Security Level 1
I 2 of 5 Reduced Quiet Zone	1210	F8h 04h BAh	Disable
Discrete 2 of 5 (DTF)4			
Discrete 2 of 5	5	05h	Disable
Set Length(s) for D 2 of 5	20, 21	14h 15h	1 to 55
Codabar (NW - 7)			
Codabar	7	07h	Enable
Set Lengths for Codabar	24, 25	18h, 19h	4 to 55
CLSI Editing	54	36h	Disable
NOTIS Editing	55	37h	Disable
Codabar Security Level	1776	F8h 06h F0h	Security Level 1
Codabar Upper or Lower Case Start/ Stop Characters Detection	855	F2h 57h	Upper Case
Codabar Mod 16 Check Digit Verification	1784	F8 06h F8h	None
Transmit Codabar Check Digit	704	F1h C0h	None
MSI			
MSI	11	0Bh	Disable
Set Length(s) for MSI	30, 31	1Eh, 1Fh	4 to 55
MSI Check Digits	50	32h	One
Transmit MSI Check Digit	46	2Eh	Disable
MSI Check Digit Algorithm	51	33h	Mod 10/Mod 10
MSI Reduced Quiet Zone	1392	F8h 05h 70h	Disable
MSI Security Level	2122	F8 08 4A	Security Level 1

Table 31 Symbology Parameter Defaults (Continued)

Parameter	Parameter Number ^a	SSI Number ^b	Default
Chinese 2 of 5			
Chinese 2 of 5	408	F0h 98h	Disable
Matrix 2 of 5			
Matrix 2 of 5	618	F1h 6Ah	Disable
Set Lengths for Matrix 2 of 5	619 620	F1h 6Bh F1h 6Ch	4 to 55
Matrix 2 of 5 Check Digit	622	F1h 6Eh	Disable
Transmit Matrix 2 of 5 Check Digit	623	F1h 6Fh	Disable
Inverse 1D	586	F1h 4Ah	Regular
GS1 DataBar			
GS1 DataBar Omnidirectional	338	F0h 52h	Enable
GS1 DataBar Limited	339	F0h 53h	Enable
GS1 DataBar Expanded	340	F0h 54h	Enable
Convert GS1 DataBar to UPC/EAN/JAN	397	F0h 8Dh	Disable
GS1 DataBar Security Level	1706	F8h 06h AAh	Level 1
GS1 DataBar Limited Margin Check	728	F1h D8h	Level 3
Symbology-Specific Security Features			
Redundancy Level	78	4Eh	1
Security Level	77	4Dh	1
1D Quiet Zone Level	1288	F8h 05h 08h	1
Intercharacter Gap Size	381	F0h 7Dh	Normal
Composite Codes			
Composite CC-C	341	F0h 55h	Disable
Composite CC-A/B	342	F0h 56h	Disable
Composite TLC-39	371	F0h 73h	Disable
Composite Inverse	1113	F8h 04h 59h	Regular
UPC Composite Mode	344	F0h 58h	UPC Never Linked
Composite Beep Mode	398	F0h 8Eh	Beep As Each Code Type is Decoded
GS1-128 Emulation Mode for UCC/EAN Composite Codes	427	F0h ABh	Disable
2D Symbologies			
PDF417	15	0Fh	Enable
MicroPDF417	227	E3h	Disable

Table 31 Symbology Parameter Defaults (Continued)

Parameter	Parameter Number ^a	SSI Number ^b	Default
Code 128 Emulation	123	7Bh	Disable
Data Matrix	292	F0h 24h	Enable
GS1 Data Matrix	1336	F8h 05h 38h	Disable
Data Matrix Inverse	588	F1h 4Ch	Inverse Autodetect
Decode Data Matrix Mirror Images	537	F1h 19h	Auto
Enhanced Dotted Datamatrix	2106	89h	Disable
Maxicode	294	F0h 26h	Disable
QR Code	293	F0h 25h	Enable
Weblink QR	1947	F8 07 9Bh	Enable
GS1 QR	1343	F8h 05h 3Fh	Enable
MicroQR	573	F1h 3Dh	Enable
Linked QR Mode	1847	737h	Linked QR Only
Aztec	574	F1h 3Eh	Enable
Aztec Inverse	589	F1h 4Dh	Inverse Autodetect
Han Xin	1167	F8h 04h 8Fh	Disable
Han Xin Inverse	1168	F8h 04h 90h	Regular
Grid Matrix	1718	F8h 06h B6h	Disable
Grid Matrix Inverse	1719	F8h 06h B7h	Regular
Grid Matrix Mirrored	1736	F8h 06h C8h	Non-Mirrored
DotCode	1906	F8 07 72h	Disable
DotCode Prioritize	1937	F8 07 91h	Enable
DotCode Inverse	1907	F8 07 73h	Autodetect
DotCode Mirrored	1908	F8 07 74h	Autodetect
Macro PDF			
Flush Macro PDF Buffer	N/A	N/A	N/A
Abort Macro PDF Entry	N/A	N/A	N/A
Postal Codes			
US Postnet	89	59h	Disable
US Planet	90	5Ah	Disable
Transmit US Postal Check Digit	95	5Fh	Enable
UK Postal	91	5Bh	Disable
Transmit UK Postal Check Digit	96	60h	Enable
Japan Postal	290	F0h 22h	Disable

Table 31 Symbology Parameter Defaults (Continued)

Parameter	Parameter Number ^a	SSI Number ^b	Default
Australia Post	291	F0h 23h	Disable
Australia Post Format	718	F1h CEh	Autodiscriminate
Netherlands KIX Code	326	F0h 46h	Disable
USPS 4CB/One Code/Intelligent Mail	592	F1h 50h	Disable
UPU FICS Postal	611	F1h 63h	Disable
Mailmark	1337	F8h 05h 39h	Disable
Posti LAPA 4-State Code	2031	F8 07EF	Disable

^a Parameter number decimal values are used for programming via RSM commands.

^b SSI number hex values are used for programming via SSI commands.

Enable/Disable All Code Types

- Disable All Code Types - Disable all symbologies. This is useful when enabling only a few code types.
- Enable All Code Types - Enable all symbologies. This is useful if you need to disable only a few code types.



Disable All Code Types

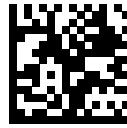

Enable All Code Types

UPC/EAN/JAN

You can choose one of these parameters to enable UPC, EAN, or JAN settings.

UPC-A

Parameter # 1 (SSI #01h)

This parameter enables or disables UPC-A.

- *Enabled - enables UPC-A.
- Disabled - disables UPC-A.



*Enable UPC-A (1)



Disable UPC-A (0)

UPC-E

Parameter # 2 (SSI # 02h)

This parameter enables UPC-E.

- *Enabled - this sets UPC-E to use.
- Disabled - UPC-E is no longer in use.



*Enable UPC-E (1)



Disable UPC-E (0)

UPC-E1

Parameter # 12 (SSI # 0Ch)

This parameter enables UPC-E1.

- Enabled - This sets UPC-E1 to use.
- Disabled - UPC-E1 is no longer in use.



NOTE: UPC-E1 is not a UCC (Uniform Code Council) approved symbology.



Enable UPC-E1 (1)



*Disable UPC-E1 (0)

EAN-8/JAN-8

Parameter # 4 (SSI # 04h)

This parameter enables EAN-8/JAN-8.

- Enabled - Sets EAN-8/JAN-8 for use.
- Disabled - EAN-8/JAN-8 is no longer in use.



*Enable EAN-8/JAN-8 (1)



Disable EAN-8/JAN-8 (0)

EAN-13/JAN-13

Parameter # 3 (SSI # 03h)

This parameter enables EAN-13/JAN-13.

- Enabled - Sets EAN-13/JAN-13 for use.
- Disabled - EAN-13/JAN-13 is no longer in use.



*Enable EAN-13/JAN-13 (1)

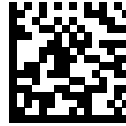

Disable EAN-13/JAN-13 (0)

Bookland EAN

Parameter # 83 (SSI # 53h)

This parameter enables Bookland EAN.

- Enabled - This sets Bookland EAN for use.
- Disabled - Bookland EAN is no longer in use.



NOTE: If you enable Bookland EAN, select a [Bookland ISBN Format](#). Also set [Decode UPC/EAN/JAN Supplementals](#) to either Decode UPC/EAN/JAN with Supplementals Only, Autodiscriminate UPC/EAN/JAN With Supplementals, or Enable 978/979 Supplemental Mode.



Enable Bookland EAN (1)



*Disable Bookland EAN (0)

Bookland ISBN Format

Parameter # 576 (SSI # F1h 40h)

If Bookland EAN is enabled, this parameter allows you to choose a format for Bookland data.

- *Bookland ISBN-10 - The scanner reports Bookland data starting with 978 in traditional 10-digit format with the special Bookland check digit for backward-compatibility. Data starting with 979 is not considered Bookland in this mode.
- Bookland ISBN-13 - The scanner reports Bookland data (starting with either 978 or 979) as EAN-13 in 13-digit format to meet the 2007 ISBN-13 protocol.



NOTE: For Bookland EAN to function properly, first enable [Bookland EAN](#) and then set [Decode UPC/EAN/JAN Supplementals](#) to either Decode UPC/EAN/JAN with Supplementals Only, Autodiscriminate UPC/EAN/JAN With Supplementals, or Enable 978/979 Supplemental Mode.



*Bookland ISBN-10 (0)



Bookland ISBN-13 (1)

ISSN EAN

Parameter # 617 (SSI # F1h 69h)

This parameter enables ISSN EAN.

- Enabled - Sets ISSN EAN for use.
- *Disabled - ISSN EAN is no longer in use.



Enable ISSN EAN (1)



*Disable ISSN EAN (0)

Decode UPC/EAN/JAN Supplementals

Parameter # 16 (SSI # 10h)

This parameter decodes supplementals, which are barcodes appended according to specific format conventions (for example, UPC A+2, UPC E+2, EAN 13+2). .

- Decode UPC/EAN/JAN with Supplementals Only - The scanner only decodes UPC/EAN/JAN symbols with supplemental characters, and ignores symbols without supplementals.
- Ignore UPC/EAN/JAN Supplementals - When presented with a UPC/EAN/JAN plus supplemental symbol, the scanner decodes UPC/EAN/JAN and ignores the supplemental characters.
- Autodiscriminate UPC/EAN/JAN with Supplementals - The scanner decodes UPC/EAN/JAN symbols with supplemental characters immediately. If the symbol does not have a supplemental, the scanner must decode the barcode the number of times set via [UPC/EAN/JAN Supplemental Redundancy](#) before transmitting its data to confirm that there is no supplemental.
- Enable 378/379 Supplemental Mode
- Enable 978/979 Supplemental Mode



NOTE: If you select 978/979 Supplemental Mode and are scanning Bookland EAN barcodes, see [Bookland EAN](#), and select a format using [Bookland ISBN Format](#).

- Enable 977 Supplemental Mode
- Enable 414/419/434/439 Supplemental Mode
- Enable 491 Supplemental Mode
- Enable Smart Supplemental Mode - This applies to EAN-13 barcodes starting with any prefix listed previously.
- Supplemental User-Programmable Type 1 - This applies to EAN-13 barcodes starting with a 3-digit user-defined prefix. Set this using [User Programmable Supplementals](#).
- Supplemental User-Programmable Type 1 and 2 - This applies to EAN-13 barcodes starting with either of two 3-digit user-defined prefixes. Set the prefixes using [User Programmable Supplementals](#).
- Smart Supplemental Plus User-Programmable 1 - This applies to EAN-13 barcodes starting with any prefix listed previously or the prefix set using [User Programmable Supplementals](#).
- Smart Supplemental Plus User-Programmable 1 and 2 - This applies to EAN-13 barcodes starting with any prefix listed previously or one of the two user-defined prefixes set using [User Programmable Supplementals](#).



NOTE: To minimize the risk of invalid data transmission, select either to decode or ignore supplemental characters.



Decode UPC/EAN/JAN With Supplementals Only
(1)

Symbologies



*Ignore UPC/EAN/JAN Supplementals (0)



Autodiscriminate UPC/EAN/JAN with Supplementals (2)

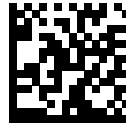

Enable 378/379 Supplemental Mode (4)



Enable 978/979 Supplemental Mode (5)



Enable 977 Supplemental Mode (7)



Enable 414/419/434/439 Supplemental Mode (6)

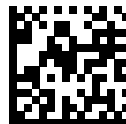

Enable 491 Supplemental Mode (8)



Enable Smart Supplemental Mode (3)



Supplemental User-Programmable Type 1 (9)



Supplemental User-Programmable Type 1 and 2 (10)

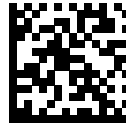

Smart Supplemental Plus User-Programmable 1 (11)



Smart Supplemental Plus User-Programmable 1 and 2 (12)

User-Programmable Supplementals

Parameter # 579 (SSI # F4h F1h 43h)

Parameter # 580 (SSI # F4h F1h 44h)

If you selected a Supplemental User-Programmable option, this parameter allows you to set two 3-digit prefixes.

- User-Programmable Supplemental 1 - Sets the first 3-digit prefix. See [Numeric Barcodes](#).
- User-Programmable Supplemental 2 - Sets a 2nd 3-digit prefix, if necessary. See [Numeric Barcodes](#).



User-Programmable Supplemental 1

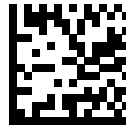

User-Programmable Supplemental 2

UPC/EAN/JAN Supplemental Redundancy

Parameter # 80 (SSI # 50h)

If you selected Autodiscriminate UPC/EAN/JAN with Supplementals, this option sets the number of times to decode a symbol without supplementals before transmission. You can enable audio feedback during a reconnect attempt.

The range is from 2-30. Five or above is recommended when decoding a mix of UPC/EAN/JAN symbols with and without supplementals.

To set a redundancy value, scan the following barcode, and then scan two barcodes from [Numeric Barcodes](#) on page 471. Enter a leading zero for single digit numbers. To correct an error or change a selection, scan [Cancel](#) on page 472.



UPC/EAN/JAN Supplemental Redundancy

UPC/EAN/JAN Supplemental AIM ID Format

Parameter # 672 (SSI # F1h A0h)

If Transmit Code ID Character is set to **AIM Code ID Character**, select an output format when reporting UPC/EAN/JAN barcodes with supplementals.

- Separate - Transmit UPC/EAN/JAN with supplementals with separate AIM IDs but one transmission, for example,

```
]E<0 or 4><data>]E<1 or 2>[supplemental data]
```

- Combined - Transmit UPC/EAN/JAN with supplementals with one AIM ID and one transmission. For example, see below.

```
]E3<data+supplemental data>
```

- Separate Transmissions - Transmit UPC/EAN/JAN with supplementals with separate AIM IDs and separate transmissions, for example,

```
]E<0 or 4><data>  
]E<1 or 2>[supplemental data]
```



Separate (0)



*Combined (1)



Separate Transmissions (2)

Transmit UPC-A Check Digit

Parameter # 40 (SSI # 28h)

This parameter transmits data with or without the UPC-A check digit.

The check digit is the last character of the symbol used to verify the integrity of the data. It is always verified to guarantee the integrity of the data.

- *Transmit UPC-A Check Digit - Transmits the data with the UPC-A check digit.
- Do Not Transmit UPC-A Check Digit - Transmits the data without the UPC-A check digit.



*Transmit UPC-A Check Digit (1)



Do Not Transmit UPC-A Check Digit (0)

Transmit UPC-E Check Digit

Parameter # 41 (SSI # 29h)

This parameter transmits data with or without the UPC-E check digit.

The check digit is the last character of the symbol used to verify the integrity of the data. It is always verified to guarantee the integrity of the data.

- *Transmit UPC-E Check Digit - transmits the data with the UPC-E check digit.
- Do Not Transmit UPC-E Check Digit - transmits the data without the UPC-E check digit.



*Transmit UPC-E Check Digit (1)



Do Not Transmit UPC-E Check Digit (0)

Transmit UPC-E1 Check Digit

Parameter # 42 (SSI #2Ah)

This parameter transmits data with or without the UPC-E1 check digit.

The check digit is the last character of the symbol used to verify the integrity of the data. It is always verified to guarantee the integrity of the data.

- *Transmit UPC-E1 Check Digit - Transmits the data with the UPC-E1 check digit.
- Do Not Transmit UPC-E1 Check Digit - Transmits the data without the UPC-E1 check digit.



*Transmit UPC-E1 Check Digit (1)



Do Not Transmit UPC-E1 Check Digit (0)

UPC-A Preamble

Parameter # 34 (SSI # 22h)

Preamble characters are part of the UPC symbol, and include Country Code and System Character.

Select the appropriate option for transmitting a UPC-A preamble to match the host system:

- Transmit System Character only
- Transmit System Character and Country Code (“0” for USA)
- Transmit no preamble.



No Preamble (<DATA>) (0)



*System Character (<SYSTEM CHARACTER>
<DATA>) (1)



System Character & Country Code (< COUNTRY
CODE> <SYSTEM CHARACTER> <DATA>) (2)

UPC-E Preamble

Parameter # 35 (SSI # 23h)

Preamble characters are part of the UPC symbol, and include Country Code and System Character.

Select the appropriate option for transmitting a UPC-E preamble to match the host system:

- Transmit System Character only
- Transmit System Character and Country Code (“0” for USA)
- Transmit no preamble.



No Preamble (<DATA>) (0)

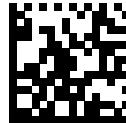

*System Character (<SYSTEM CHARACTER>
<DATA>) (1)



System Character & Country Code (< COUNTRY
CODE> <SYSTEM CHARACTER> <DATA>) (2)

UPC-E1 Preamble

Parameter # 36 (SSI # 24h)

Preamble characters are part of the UPC symbol, and include Country Code and System Character.

Select the appropriate option for transmitting a UPC-E1 preamble to match the host system:

- Transmit System Character only
- Transmit System Character and Country Code ("0" for USA)
- Transmit no preamble.



No Preamble (<DATA>) (0)



*System Character (<SYSTEM CHARACTER>
<DATA>) (1)



System Character & Country Code (< COUNTRY
CODE> <SYSTEM CHARACTER> <DATA>) (2)

Convert UPC-E to UPC-A

Parameter # 37 (SSI # 25h)

This parameter converts UPC-E (zero suppressed) decoded data to UPC-A format before transmission.

After conversion, the data follows UPC-A format and is affected by UPC-A programming selections (such as, Preamble, Check Digit).

- *Enabled - Converts UPC-E decoded data to UPC-A format.
- Disabled - Transmits UPC-E decoded data without conversion to UPC-A.



Convert UPC-E to UPC-A (Enable) (1)



*Do Not Convert UPC-E to UPC-A (Disable) (0)

Convert UPC-E1 to UPC-A

Parameter # 38 (SSI # 26h)

This parameter converts UPC-E1 (zero suppressed) decoded data to UPC-A format before transmission.

After conversion, the data follows UPC-A format and is affected by UPC-A programming selections (e.g., Preamble, Check Digit).

- *Enabled - converts UPC-E1 decoded data to UPC-A format.
- Disabled - transmits UPC-E1 decoded data without conversion to UPC-A.



Convert UPC-E1 to UPC-A (Enable) (1)



*Do Not Convert UPC-E1 to UPC-A (Disable) (0)

EAN/JAN Zero Extend

Parameter # 39 (SSI # 27h)

This parameter enables or disables decoded EAN-8 symbols to be compatible in length with EAN-13 symbols.

- Enabled - Adds five leading zeros to decoded EAN-8 symbols to make them compatible in length to EAN-13 symbols
- Disabled - Transmits EAN-8 symbols as-is, without adding zeroes.



Enable EAN/JAN Zero Extend (1)



*Disable EAN/JAN Zero Extend (0)

UCC Coupon Extended Code

Parameter # 85 (SSI # 55h)

This parameter decodes UPC-A barcodes starting with digit '5', EAN-13 barcodes starting with digit '99', and UPC-A/GS1-128 coupon codes.

- Enabled - Extends decoding for UPC-A, EAN-13, and GS1-128 coupon codes.
- *Disabled - Does not extend decoding for UPC-A, EAN-13, and GS1-128 coupon codes.



NOTE: UPC-A, EAN-13, and GS1-128 must be enabled to use this feature.



NOTE: See [UPC/EAN/JAN Supplemental Redundancy](#) to control autodiscrimination of the GS1-128 portion (right half) of a coupon code.



Enable UCC Coupon Extended Code (1)

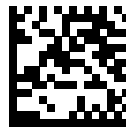

*Disable UCC Coupon Extended Code (0)

Coupon Report

Parameter # 730 (SSI # F1h DAh)

This parameter selects the type of coupon format to support.

- Old Coupon Format - Support UPC-A/GS1-128 and EAN-13/GS1-128.
- New Coupon Format - An interim format to support UPC-A/GS1-DataBar and EAN-13/GS1-DataBar.
- Autodiscriminate Format - Support both Old Coupon Format and New Coupon Format.



Old Coupon Format (0)

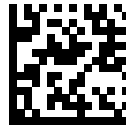

*New Coupon Format (1)



Autodiscriminate Coupon Format (2)

UPC Reduced Quiet Zone

Parameter # 1289 (SSI # F8h 05h 09h)

This parameter enables or disables decoding UPC barcodes with reduced quiet zones (the margins on either side of the barcode).

- Enabled - Enables decoding UPC barcodes with reduced quiet zones.
- *Disabled - Disables decoding UPC barcodes with reduced quiet zones.



NOTE: If you select Enable, select a [1D Quiet Zone Level](#).



Enable UPC Reduced Quiet Zone (1)



*Disable UPC Reduced Quiet Zone (0)

Digimarc Digital Watermarks

Parameter # 1687 (SSI # F8h 0h 97h)

This parameter enables or disables the Digimarc Digital Watermarks.

- Enabled - Enables the Digimarc Digital Watermarks.
- *Disabled - Disables the Digimarc Digital Watermarks.



Enable Digimarc Digital Watermarks/DW (1)



*Disable Digimarc Digital Watermarks/DW (0)

Linear UPC/EAN

Parameter # 68 (SSI # 44h)

This parameter enables or disables transmission of a barcode only when both the left and right blocks are successfully decoded within one image.

This parameter applies to code types containing two adjacent blocks (such as, UPC-A, EAN-8, EAN-13).

- Enabled - Enables or transmission of a barcode only when both the left and right blocks are successfully decoded within one image.
- Disabled - Disables transmission of a barcode only when both the left and right blocks are successfully decoded within one image.



NOTE: This is recommended when barcodes are in proximity to each other.



Enable Linear UPC/EAN (1)

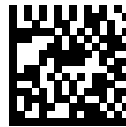

*Disable Linear UPC/EAN (0)

Code 128

Parameter # 8 (SSI #08h)

You can enable or disable Code 128.

- *Enabled - Enables Code 128.
- Disabled - Disables Code 128.



*Enable Code 128 (1)



Disable Code 128 (0)

Set Lengths for Code 128

Parameter # 209 (SSI #D1h)

Parameter # 210 (SSI #D2h)

This parameter sets lengths for Code 128 to any length, one or two discrete lengths, or lengths within a specific range.

The length of a code refers to the number of characters (for example, human-readable characters), including check digit(s) the code contains. The default is 0 to 80. The maximum range is 0 - 80.



NOTE: When setting lengths, enter a leading zero for single digit numbers.

- One Discrete Length - Decode only Code 128 symbols containing a selected length.
- Two Discrete Lengths - Decode only Code 128 symbols containing either of two lengths.
- Length Within Range - Decode Code 128 symbols with a specific length range.
- Any Length - Decode Code 128 symbols containing any number of characters within the scanner's capability.

Select lengths using barcodes in [Numeric Barcodes](#). To correct an error or change the selection, scan [Cancel](#).

For example:

- To decode only Code 128 symbols with 14 characters, scan Code 128 - One Discrete Length, and then scan 1, 4.
- To decode only Code 128 symbols containing either 2 or 14 characters, scan Code 128 - Two Discrete Lengths, and then scan 0, 2, 1, 4.
- To decode Code 128 symbols containing between 4 and 12 characters, scan Code 128 - Length Within Range, and then scan 0, 4, 1, 2.



Code 128 - One Discrete Length



Code 128 - Two Discrete Lengths



*Code 128 - Length Within Range (Default: 0 to 80)



Code 128 - Any Length

GS1-128 (formerly UCC/EAN-128)

Parameter # 14 (SSI #0Eh)

You can enable or disable GS1-128.

- *Enabled - Enables GS1-128.
- Disabled - Disables GS1-128.



*Enable GS1-128 (1)



Disable GS1-128 (0)

ISBT 128

Parameter # 84 (SSI #54h)

You can enable or disable ISBT 128.

- *Enabled - enables ISBT 128.
- Disabled - disables ISBT 128.

ISBT 128 is a variant of Code 128 used in the blood bank industry.



*Enable ISBT 128 (1)

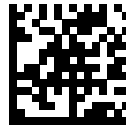

Disable ISBT 128 (0)

ISBT Concatenation

Parameter # 577 (SSI #F1h 41h)

This parameter enables and disables ISBT concatenation.

Select an option for concatenating pairs of ISBT code types:

- Enable ISBT Concatenation - There must be two ISBT codes in order for the scanner to decode and perform concatenation. The scanner does not decode single ISBT symbols.
- Disable ISBT Concatenation - The scanner does not concatenate pairs of ISBT codes it encounters.
- Autodiscriminate ISBT Concatenation - The scanner decodes and concatenates pairs of ISBT codes immediately. If only a single ISBT symbol is present, the scanner must decode the symbol the number of times set via [ISBT Concatenation Redundancy](#) before transmitting its data to confirm that there is no additional ISBT symbol.



NOTE: For ISBT AutoDetect to operate as expected, both barcodes must be in the field of view simultaneously. This may be difficult to achieve in presentation mode.



NOTE: When enabling ISBT Concatenation or Autodiscriminate ISBT Concatenation set Code 128 Security Level to Level 2.



Enable ISBT Concatenation (1)



*Disable ISBT Concatenation (0)



Autodiscriminate ISBT Concatenation (2)

Check ISBT Table

Parameter # 578 (SSI #F1h 42h)

This parameter enables or disables the Check ISBT Table to concatenate only those pairs found in this table. Other types of ISBT codes are not concatenated.

- *Enabled - enables the Check ISBT Table to concatenate only those pairs found in this table.
- Disabled - disables the Check ISBT Table to concatenate only those pairs found in this table.

The ISBT specification includes a table that lists several types of ISBT barcodes that are commonly used in pairs.



*Enable Check ISBT Table (1)



Disable Check ISBT Table (0)

ISBT Concatenation Redundancy

Parameter # 223 (SSI #DFh)

This parameter sets the number of times the scanner must decode an ISBT symbol before determining that there is no additional symbol.

This parameter applies if you set ISBT Concatenation to Autodiscriminate.

Scan the following barcode, and then scan barcodes in [Numeric Barcodes](#) to set a value between [2 and 20]. Enter a leading zero for single-digit numbers. To correct an error or change a selection, scan [Cancel](#). The default is [10].



ISBT Concatenation Redundancy

Code 128 <FNC4>

Parameter # 1254 (SSI #F8h 04h E6h)

This parameter processes the Code 128 <FNC4> character, and either ignores (removes) the character or honors (does not remove) the character.

- *Honor Code 128 <FNC4> - The <FNC4> character is processed normally, per Code 128 standard.
- Ignore Code 128 <FNC4> - Strips the <FNC4> character from the decode data. The remaining characters are sent to the host unchanged.



*Honor Code 128 <FNC4> (0)



Ignore Code 128 <FNC4> (1)

Code 128 Security Level

Parameter # 751 (SSI #F1h EFh)

This parameter enables four levels of decode security for Code 128.

Code 128 barcodes are vulnerable to misdecodes, particularly when Code 128 Lengths is set to Any Length. There is an inverse relationship between security and scanner aggressiveness. Increasing the level of security can reduce scanning aggressiveness, so select only the level of security necessary.

- Code 128 Security Level 0 - The scanner operates in its most aggressive state, while providing sufficient security in decoding most in-spec barcodes.
- Code 128 Security Level 1 - This option eliminates most misdecodes while maintaining reasonable aggressiveness.
- Code 128 Security Level 2 - This option applies greater barcode security requirements if Security Level 1 fails to eliminate misdecodes.
- Code 128 Security Level 3 - If you selected Security Level 2, and misdecodes still occur, select this security level to apply the highest safety requirements.



NOTE: Selecting Code 128 Security Level 3 is an extreme measure against mis-decoding severely out-of-spec barcodes, and significantly impairs the decoding ability of the device. If this level of security is required, try to improve the quality of the barcodes.



Code 128 Security Level 0 (0)



*Code 128 Security Level 1 (1)



Code 128 Security Level 2 (2)



Code 128 Security Level 3 (3)

Code 128 Reduced Quiet Zone

Parameter # 1208 (SSI #F8h 04h B8h)

This parameter enables or disables decoding Code 128 with reduced quiet zones (the margins on either side of the barcode).

If you select Enable, select a [1D Quiet Zone Level](#).

- *Enabled - enables Code 128 with reduced Quiet Zones.
- Disabled - disables Code 128 with reduced Quiet Zones.



Enable Code 128 Reduced Quiet Zone (1)



*Disable Code 128 Reduced Quiet Zone (0)

Code 39

Parameter # 0 (SSI #00h)

This parameter enables or disables Code 39.

- *Enabled - Enables Code 39.
- Disabled - Disables Code 39.



*Enable Code 39 (1)



Disable Code 39 (0)

Trioptic Code 39

Parameter # 13 (SSI #0Dh)

This parameter enables or disables Trioptic Code 39.

Trioptic Code 39 is a variant of Code 39 used in the marking of computer tape cartridges. Trioptic Code 39 symbols always contain six characters.

- Enabled - enables Trioptic Code 39.
- *Disabled - disables Trioptic Code 39.



NOTE: You cannot enable Trioptic Code 39 and Code 39 Full ASCII simultaneously.



Enable Trioptic Code 39 (1)



*Disable Trioptic Code 39 (0)

Convert Code 39 to Code 32

Parameter # 86 (SSI #5h)

This parameter enables or disables converting Code 39 to Code 32.

Code 32 is a variant of Code 39 used by the Italian pharmaceutical industry.



NOTE: Code 39 must be enabled for this parameter to function.

- Enabled - enables Convert Code 39 to Code 32.
- *Disabled - disables Convert Code 39 to Code 32.



Enable Convert Code 39 to Code 32 (1)



*Disable Convert Code 39 to Code 32 (0)

Code 32 Prefix

Parameter # 231 (SSI #E7h)

This parameter enables or disables adding the prefix character “A” to all Code 32 barcodes.

- Enabled - enables Code 32 Prefix.
- *Disabled - disables Code 32 Prefix.



NOTE: [Convert Code 39 to Code 32](#) must be enabled for this parameter to function.



Enable Code 32 Prefix (1)



*Disable Code 32 Prefix (0)

Set Lengths for Code 39

L1 Parameter # 18 (SSI #12h)

L2 Parameter # 19 (SSI #13h)

This parameter set lengths for Code 39.

The length of a code refers to the number of characters (for example, human readable characters), including check digit(s) the code contains. Set lengths for Code 39 to any length, one or two discrete lengths, or lengths within a specific range. If Code 39 Full ASCII is enabled, Length Within Range or Any Length are the preferred options. The default is 1 to 55 . The maximum range is 0 - 80.



NOTE: When setting lengths, enter a leading zero for single digit numbers.

- One Discrete Length - Decode only Code 39 symbols containing a selected length.
- Two Discrete Lengths - Decode only Code 39 symbols containing either of two lengths.
- Length Within Range - Decode Code 39 symbols with a specific length range.
- Any Length - Decode Code 39 symbols containing any number of characters within the scanner's capability.

Select lengths using barcodes in [Numeric Barcodes](#). To correct an error or change the selection, scan [Cancel](#).

For example:

- To decode only Code 39 symbols with 14 characters, scan Code 39 - One Discrete Length, and then scan 1, 4.
- To decode only Code 39 symbols containing either 2 or 14 characters, scan Code 39 - Two Discrete Lengths, and then scan 0, 2, 1, 4.
- To decode Code 39 symbols containing between 4 and 12 characters, scan Code 39 - Length Within Range, and then scan 0, 4, 1, 2.



Code 39 - One Discrete Length



Code 39 - Two Discrete Lengths



*Code 39 - Length Within Range (Default: 1 to 55)



Code 39 - Any Length

Code 39 Check Digit Verification

Parameter # 48 (SSI #30h)

This parameter checks the integrity of all Code 39 symbols to verify that the data complies with specified check digit algorithm.

Only Code 39 symbols which include a modulo 43 check digit are decoded. Enable this feature if the Code 39 symbols contain a Modulo 43 check digit.

- Enabled - enables Code 39 Check Digit.
- *Disabled - disables Code 39 Check Digit.



Enable Code 39 Check Digit (1)



*Disable Code 39 Check Digit (0)

Transmit Code 39 Check Digit

Parameter # 43 (SSI #2Bh)

This parameter transmits Code 39 data with or without the check digit.

- Enabled - enables Transmit Code 39 Check Digit.
- *Disabled - disables Transmit Code 39 Check Digit.



NOTE: [Code 39 Check Digit Verification](#) must be enabled for this parameter to function.



Transmit Code 39 Check Digit (Enable) (1)

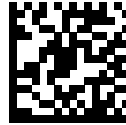

*Do Not Transmit Code 39 Check Digit (Disable) (0)

Transmit Code 39 Start/Stop Characters

Parameter # 1900 (SSI # F8 07 6Ch)

This parameter selects whether to transmit Code 39 start/stop characters.

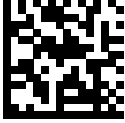

*Disable Transmit Code 39 Start/Stop Characters
(0)



Enable Transmit Code 39 Start/Stop Characters (1)

Code 39 Full ASCII Conversion

Parameter # 17 (SSI #11h)

This parameter enables or disables Code 39 Full ASCII.

Code 39 Full ASCII is a variant of Code 39 which pairs characters to encode the full ASCII character set.

- Enabled - enables Code 39 Full ASCII.
- *Disabled - disables Code 39 Full ASCII.



NOTE: You cannot enable Trioptic Code 39 and Code 39 Full ASCII simultaneously.



NOTE: Code 39 Full ASCII to Full ASCII Correlation is host-dependent, and is therefore described in the ASCII character set table for the appropriate interface. See [ASCII Character Sets](#).



Enable Code 39 Full ASCII (1)



*Disable Code 39 Full ASCII (0)

Code 39 Security Level

Parameter # 750 (SSI #F1h EEh)

This parameter sets the security level for Code 39.

Select increasing levels of security for decreasing levels of barcode quality. There is an inverse relationship between security, and device aggressiveness, so choose only that level of security necessary for any given application.

- Code 39 Security Level 0 - Allows the device to operate in its most aggressive state, while providing sufficient security in decoding most "in-spec" barcodes.
- *Code 39 Security Level 1 - This setting eliminates most mis-decodes
- Code 39 Security Level 2 - Select this option if Security Level 1 fails to eliminate mis-decodes.
- Code 39 Security Level 3 - If you selected Security Level 2 and mis-decodes still occur, select this security level.



NOTE: Selecting Security Level 3 is an extreme measure against mis-decoding severely out of spec barcodes. Selecting this level of security significantly impairs the decoding ability of the device. If you need this level of security, try to improve the quality of the barcodes.



Code 39 Security Level 0 (0)

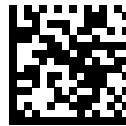

*Code 39 Security Level 1 (1)



Code 39 Security Level 2 (2)

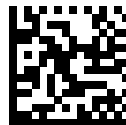

Code 39 Security Level 3 (3)

Code 39 Reduced Quiet Zone

Parameter # 1209 (SSI #F8h 04h B9h)

This parameter enables or disables decoding Code 39 with reduced quiet zones (the margins on either side of the barcode).

If you select Enable, select a [1D Quiet Zone Level](#).

- *Enabled - enables Code 39 with reduced Quiet Zones.
- Disabled - disables Code 39 with reduced Quiet Zones.



Enable Code 39 Reduced Quiet Zone (1)



*Disable Code 39 Reduced Quiet Zone (0)

Code 93

Parameter # 9 (SSI #09h)

This parameter enables or disables Code 93.

- *Enabled - enables Code 93.
- Disabled - disables Code 93.



*Enable Code 93 (1)

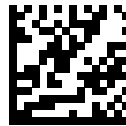

Disable Code 93 (0)

Set Lengths for Code 93

Parameter # 26 (SSI #1Ah)

Parameter # 27 (SSI #1Bh)

This parameter sets the lengths for Code 93 to any length, one or two discrete lengths, or lengths within a specific range.

The length of a code refers to the number of characters (for example, human-readable characters), including check digit(s) the code contains. The default is 1 to 55. The maximum range is 0 - 80.



NOTE: When setting lengths, enter a leading zero for single-digit numbers.

- One Discrete Length - Decode only Code 93 symbols containing a selected length.
- Two Discrete Lengths - Decode only Code 93 symbols containing either of two lengths.
- Length Within Range - Decode Code 93 symbols with a specific length range.
- Any Length - Decode Code 93 symbols containing any number of characters within the scanner's capability.

Select lengths using barcodes in [Numeric Barcodes](#). To correct an error or change the selection, scan [Cancel](#).

For example:

- To decode only Code 93 symbols with 14 characters, scan Code 93 - One Discrete Length, and then scan 1, 4.
- To decode only Code 93 symbols containing either 2 or 14 characters, scan Code 93 - Two Discrete Lengths, and then scan 0, 2, 1, 4.
- To decode Code 93 symbols containing between 4 and 12 characters, scan Code 93 - Length Within Range, and then scan 0, 4, 1, 2.



Code 93 - One Discrete Length

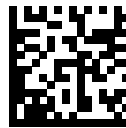

Code 93 - Two Discrete Lengths



*Code 93 - Length Within Range (Default: 1 to 55)

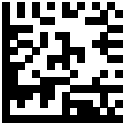

Code 93 - Any Length

Code 11

Parameter # 10 (SSI #0Ah)

This parameter enables or disables Code 11.

- *Enabled - enables Code 11.
- Disabled - disables Code 11.
-



Enable Code 11 (1)

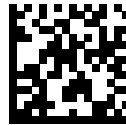

*Disable Code 11 (0)

Set Lengths for Code 11

L1 Parameter # 28 (SSI #1Ch)

L2 Parameter # 29 (SSI #1Dh)

This parameter set lengths for Code 11.

The length of a code refers to the number of characters (i.e., human readable characters), including check digit(s) the code contains. Set lengths for Code 11 to any length, one or two discrete lengths, or lengths within a specific range. The default is 4 to 55. The maximum range is 0-80.



NOTE: When setting lengths, enter a leading zero for single digit numbers.

- One Discrete Length - Decode only Code 11 symbols containing a selected length.
- Two Discrete Lengths - Decode only Code 11 symbols containing either of two lengths.
- Length Within Range - Decode Code 11 symbols with a specific length range.
- Any Length - Decode Code 11 symbols containing any number of characters within the scanner's capability.

Select lengths using barcodes in [Numeric Barcodes](#). To correct an error or change the selection, scan [Cancel](#).

For example:

- To decode only Code 11 symbols with 14 characters, scan Code 11 - One Discrete Length, and then scan 1, 4.
- To decode only Code 11 symbols containing either 2 or 14 characters, scan Code 11 - Two Discrete Lengths, and then scan 0, 2, 1, 4.
- To decode Code 11 symbols containing between 4 and 12 characters, scan Code 11 - Length Within Range, and then scan 0, 4, 1, 2.



Code 11 - One Discrete Length

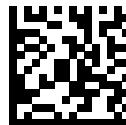

Code 11 - Two Discrete Lengths



*Code 11 - Length Within Range (Default: 4 to 55)



Code 11 - Any Length

Code 11 Check Digit Verification

Parameter # 52 (SSI #34h)

This parameter checks the integrity of all Code 11 symbols to verify that the data complies with specified check digit algorithm.

- *Disabled - disables Code 11 Check Digit.
- One Check Digit - enables Code 11 to check one digit.
- Two Check Digits - enables Code 11 to check 2 digits.



*Disable (0)

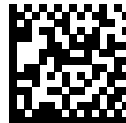

One Check Digit (1)



Two Check Digits (2)

Transmit Code 11 Check Digits

Parameter # 47 (SSI #2Fh)

This parameter transmits Code 11 data with or without the check digit.

- Enabled - enables Transmit Code 11 Check Digit.
- *Disabled - disables Transmit Code 11 Check Digit.



NOTE: [Code 11 Check Digit Verification](#) must be enabled for this parameter to function.



Transmit Code 11 Check Digit(s) (Enable) (1)



*Do Not Transmit Code 11 Check Digit(s) (Disable)
(0)

Interleaved 2 of 5 (I 2 of 5)

Parameter # 6 (SSI #06h)

This parameter enables or disables I 2 of 5.

- *Enabled - enables I 2 of 5.
- Disabled - disables I 2 of 5.



*Enable Interleaved 2 of 5 (1)



Disable Interleaved 2 of 5 (0)

Set Lengths for Interleaved 2 of 5 (I 2 of 5)

L1 Parameter # 22 (SSI #16h)

L2 Parameter # 23 (SSI #17h)

This parameter set lengths for I 2 of 5.

The length of a code refers to the number of characters (for example, human-readable characters), including check digit(s) the code contains. Set lengths for I 2 of 5 to any length, one or two discrete lengths, or lengths within a specific range. The default is 6 to 55. The maximum range is 0-80.



NOTE: When setting lengths, enter a leading zero for single digit numbers.

- One Discrete Length - Decode only I 2 of 5 symbols containing a selected length.
- Two Discrete Lengths - Decode only I 2 of 5 symbols containing either of two lengths.
- Length Within Range - Decode I 2 of 5 symbols with a specific length range.
- Any Length - Decode I 2 of 5 symbols containing any number of characters within the scanner's capability.



NOTE: Due to the construction of the I 2 of 5 symbology, it is possible for a scan line covering only a portion of the code to transmit as a complete scan, yielding less data than is encoded in the barcode. To prevent this, select specific lengths (I 2 of 5 - One Discrete Length, Two Discrete Lengths) for I 2 of 5 applications, or increase the [Security Level](#).

Select lengths using barcodes in [Numeric Barcodes](#). To correct an error or change the selection, scan [Cancel](#).

For example:

- To decode only I 2 of 5 symbols with 14 characters, scan I 2 of 5 - One Discrete Length, and then scan 1, 4.
- To decode only I 2 of 5 symbols containing either 2 or 14 characters, scan I 2 of 5 - Two Discrete Lengths, and then scan 0, 2, 1, 4.
- To decode I 2 of 5 symbols containing between 4 and 12 characters, scan I 2 of 5 - Length Within Range, and then scan 0, 4, 1, 2.

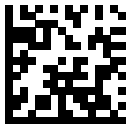

I 2 of 5 - One Discrete Length



I 2 of 5 - Two Discrete Lengths



*I 2 of 5 - Length Within Range (Default: 6 to 55)



I 2 of 5 - Any Length

Interleaved 2 of 5 (I 2 of 5) Check Digit Verification

Parameter # 49 (SSI #31h)

This parameter enables or disables checking the integrity of all I 2 of 5 symbols to verify the data complies with either the specified Uniform Symbology Specification (USS) or the Optical Product Code Council (OPCC) check digit algorithm.

- *Disable - disables checking the integrity of all I 2 of 5 symbols to verify the data complies.
- USS Check Digit - enables checking the integrity of USS.
- OPCC Check Digit - enables checking the integrity of OPCC.



*Disable (0)



USS Check Digit (1)



OPCC Check Digit (2)

Transmit I 2 of 5 Check Digit

Parameter # 44 (SSI #2Ch)

This parameter enables or disables transmission of I 2 of 5 data with or without the check digit.

- Enabled - enables transmission of check digit.
- *Disabled - disables transmission of check digit.



Transmit I 2 of 5 Check Digit (Enable) (1)



*Do Not Transmit I 2 of 5 Check Digit (Disable) (0)

Convert Interleaved 2 of 5 (I 2 of 5) to EAN-13

Parameter # 82 (SSI #52h)

This parameter enables or disables converting 14-character I 2 of 5 codes to EAN-13, and then transmitting to the host as EAN-13.

- Enabled - enables converting 14-character I 2 of 5 codes to EAN-13.
- *Disabled - disables converting 14-character I 2 of 5 codes to EAN-13.



NOTE: The I 2 of 5 code must be enabled, and the code must have a leading zero and a valid EAN-13 check digit.



Convert I 2 of 5 to EAN-13 (Enable) (1)



*Do Not Convert I 2 of 5 to EAN-13 (Disable) (0)

Febraban

Parameter # 1750 (SSI #F8h 06h D6h)

This parameter enables or disables the I 2 of 5 internal check digit calculation and transmission.

Febraban is an Interleaved 2 of 5 (I 2 of 5) length 44 that requires inserting special check characters in the transmitted data stream.

- *Enabled - enables internal check of digit calculation and transmission.
- Disabled - disables internal check of digit calculation and transmission.



NOTE: Recommendations for length settings:

- I 2 of 5 Length 1: Larger of the fixed length and the Febraban length (==44).
- I 2 of 5 Length 2: Smaller of the fixed length and the Febraban length (==44).



Enable Febraban (1)



*Disable Febraban (0)

Interleaved 2 of 5 (I 2 of 5) Security Level

Parameter # 1121 (SSI #F8h 04h 61h)

This parameter sets the security level for I 2 of 5.

I 2 of 5 barcodes are vulnerable to misdecodes, particularly when I 2 of 5 Lengths is set to Any Length. The scanner offers four levels of decode security for I 2 of 5 barcodes. There is an inverse relationship between security and scanner aggressiveness. Increasing the level of security can reduce scanning aggressiveness, so select only the level of security necessary.

- I 2 of 5 Security Level 0: The scanner operates in its most aggressive state, while providing sufficient security in decoding most in-spec barcodes.
- I 2 of 5 Security Level 1: A barcode must be successfully read twice, and satisfy certain safety requirements before being decoded. This default setting eliminates most misdecodes.
- I 2 of 5 Security Level 2: This option applies greater barcode security requirements if Security Level 1 fails to eliminate misdecodes.
- I 2 of 5 Security Level 3: If you selected Security Level 2, and misdecodes still occur, select this security level. The highest safety requirements are applied. A barcode must be successfully read three times before being decoded.



NOTE: Selecting this option is an extreme measure against mis-decoding severely out-of-spec barcodes, and significantly impairs the decoding ability of the scanner. If this level of security is required, try to improve the quality of the barcodes.



I 2 of 5 Security Level 0 (0)



*I 2 of 5 Security Level 1 (1)



I 2 of 5 Security Level 2 (2)



I 2 of 5 Security Level 3 (3)

Interleaved 2 of 5 (I 2 of 5) Reduced Quiet Zone

Parameter # 1210 (SSI #F8h 04h B9h)

This parameter enables or disables decoding I 2 of 5 with reduced quiet zones (the margins on either side of the barcode).

If you select Enable, select a [1D Quiet Zone Level](#).

- Enabled - enables I 2 of 5 with reduced Quiet Zones.
- *Disabled - disables I 2 of 5 with reduced Quiet Zones.



Enable I 2 of 5 Reduced Quiet Zone (1)



*Disable I 2 of 5 Reduced Quiet Zone (0)

Discrete 2 of 5 (D 2 of 5)

Parameter # 5 (SSI #05h)

This parameter enables or disables D 2 of 5.

- Enabled - enables D 2 of 5.
- *Disabled - disables D 2 of 5.



Enable Discrete 2 of 5 (1)



*Disable Discrete 2 of 5 (0)

Set Lengths for Discrete 2 of 5 (D 2 of 5)

L1 Parameter # 20 (SSI #14h)

L2 Parameter # 21 (SSI #15h)

This parameter set lengths for D 2 of 5.

The length of a code refers to the number of characters (for example, human-readable characters), including check digit(s) the code contains. Set lengths for D 2 of 5 to any length, one or two discrete lengths, or lengths within a specific range. The default is 1-55. The maximum range is 0-55.



NOTE: When setting lengths, enter a leading zero for single digit numbers.

Scan one of the following barcodes to select a length option:

- One Discrete Length - Decode only D 2 of 5 symbols containing a selected length.
- Two Discrete Lengths - Decode only D 2 of 5 symbols containing either of two lengths.
- Length Within Range - Decode D 2 of 5 symbols with a specific length range.
- Any Length - Decode D 2 of 5 symbols containing any number of characters within the scanner's capability.



NOTE: Due to the construction of the D 2 of 5 symbology, it is possible for a scan line covering only a portion of the code to transmit as a complete scan, yielding less data than is encoded in the barcode. To prevent this, select specific lengths (D 2 of 5 - One Discrete Length, Two Discrete Lengths) for D 2 of 5 applications.

Select lengths using barcodes in [Numeric Barcodes](#). To correct an error or change the selection, scan [Cancel](#).

For example:

- To decode only D 2 of 5 symbols with 14 characters, scan D 2 of 5 - One Discrete Length, and then scan 1, 4.
- To decode only D 2 of 5 symbols containing either 2 or 14 characters, scan D 2 of 5 - Two Discrete Lengths, and then scan 0, 2, 1, 4.
- To decode D 2 of 5 symbols containing between 4 and 12 characters, scan D 2 of 5 - Length Within Range, and then scan 0, 4, 1, 2.



D 2 of 5 - One Discrete Length

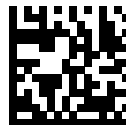

D 2 of 5 - Two Discrete Lengths

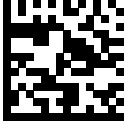

*D 2 of 5 - Length Within Range (Default: 1-55)

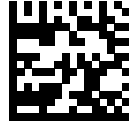

D 2 of 5 - Any Length

Codabar (NW - 7)

Parameter # 7 (SSI #07h)

This parameter enables or disables Codabar.

- *Enabled - enables Codabar.
- Disabled - disables Codabar.



*Enable Codabar (1)



Disable Codabar (0)

Set Lengths for Codabar

L1 Parameter # 24 (SSI #18h)

L2 Parameter # 25 (SSI #19h)

This parameter set lengths for Codabar.

The length of a code refers to the number of characters (for example, human-readable characters), including check digit(s) the code contains. Set lengths for Codabar to any length, one or two discrete lengths, or lengths within a specific range. The default is 4 to 55 . The maximum range is 0-60.



NOTE: When setting lengths, enter a leading zero for single-digit numbers.

- One Discrete Length - Decode only Codabar symbols containing a selected length.
- Two Discrete Lengths - Decode only Codabar symbols containing either of two lengths.
- Length Within Range - Decode Codabar symbols with a specific length range.
- Any Length - Decode Codabar symbols containing any number of characters within the scanner's capability.

Select lengths using barcodes in [Numeric Barcodes](#). To correct an error or change the selection, scan [Cancel](#).

For example:

- To decode only Codabar symbols with 14 characters, scan Codabar - One Discrete Length, and then scan 1, 4.
- To decode only Codabar symbols containing either 2 or 14 characters, scan Codabar - Two Discrete Lengths, and then scan 0, 2, 1, 4.
- To decode Codabar symbols containing between 4 and 12 characters, scan Codabar - Length Within Range, and then scan 0, 4, 1, 2.



Codabar - One Discrete Length



Codabar - Two Discrete Lengths



*Codabar - Length Within Range (Default: 4 to 55)



Codabar - Any Length

CLSI Editing

Parameter # 54 (SSI #36h)

This parameter enables or disables CLSI editing.

Select Enable CLSI Editing to strip the start and stop characters and insert a space after the first, fifth, and tenth characters of a 14-character Codabar symbol if the host system requires this data format.

- Enabled - enables CLSI editing.
- *Disabled - disables CLSI editing.



NOTE: Symbol length does not include start and stop characters.



Enable CLSI Editing (1)



*Disable CLSI Editing (0)

NOTIS Editing

Parameter # 55 (SSI #37h)

This parameter enables or disables NOTIS editing which strips the start and stop characters from a decoded Codabar symbol if the host system requires this data format.

- Enabled - enables NOTIS editing.
- *Disabled - disables NOTIS editing.



Enable NOTIS Editing (1)



*Disable NOTIS Editing (0)

Codabar Security Level

Parameter # 1776 (SSI #F8h 06h F0h)

This parameter sets the security level for Codabar 39.

The scanner offers four levels of decode security for Codabar barcodes. There is an inverse relationship between security and scanner aggressiveness. Increasing the level of security can reduce scanning aggressiveness, so select only the level of security necessary.

- Codabar Security Level 0: This setting allows the scanner to operate in its most aggressive state, while providing sufficient security in decoding most in-spec barcodes.
- Codabar Security Level 1: This default setting eliminates most misdecodes.
- Codabar Security Level 2: Select this option with greater barcode security requirements if Security Level 1 fails to eliminate misdecodes.
- Codabar Security Level 3: If you selected Security Level 2, and misdecodes still occur, select this security level to apply the highest safety requirements.



NOTE: Selecting this option is an extreme measure against mis-decoding severely out-of-spec barcodes, and significantly impairs the decoding ability of the scanner. If this level of security is required, try to improve the quality of the barcodes.



Codabar Security Level 0 (0)



*Codabar Security Level 1 (1)

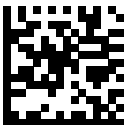

Codabar Security Level 2 (2)



Codabar Security Level 3 (3)

Codabar Upper or Lower Case Start/Stop Characters

Parameter # 855 (SSI #F2h 57h)

This parameter selects whether to transmit upper case or lower case Codabar start/stop characters.

- Lower Case (1) - enables lower case start/stop characters.
- *Upper Case (0) - enables upper case start/stop characters.



Lower Case (1)



*Upper Case (0)

Codabar Mod 16 Check Digit Verification

Parameter # 1784 (SSI #F8h 06h F8h)

This parameter checks the Codabar Mod 16 check digit to verify that the data complies with the specified check digit algorithm.

- Enabled - enables check digit.
- *Disabled - disables check digit.



Enable Codabar Mod 16 Check digit (1)



*Disable Codabar Mod 16 Check digit (0)

Transmit Codabar Check Digit

Parameter # 704 (SSI #F1h C0h)

This parameter selects whether or not to transmit the Codabar check digit(s).

- Enabled - enables check digit transmission.
- *Disabled - disables check digit transmission.



Enable Codabar Check Digit Transmission (1)

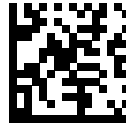

*Disable Codabar Check Digit Transmission (0)

MSI

Parameter # 11 (SSI #0Bh)

This parameter enables or disables MSI.

- Enabled - enables MSI.
- *Disabled - disables MSI.



Enable MSI (1)

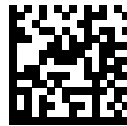

*Disable MSI (0)

Set Lengths for MSI

L1 Parameter # 30 (SSI #1Eh)

L2 Parameter # 31 (SSI #1Fh)

This parameter set lengths for MSI.

The length of a code refers to the number of characters (for example, human-readable characters), including check digit(s) the code contains. Set lengths for MSI to any length, one or two discrete lengths, or lengths within a specific range. The default is 4 to 55. The maximum range is 0-55.



NOTE: When setting lengths, enter a leading zero for single-digit numbers.

Scan one of the following barcodes to select a length option:

- One Discrete Length - Decode only MSI symbols containing a selected length.
- Two Discrete Lengths - Decode only MSI symbols containing either of two lengths.
- Length Within Range - Decode MSI symbols with a specific length range.
- Any Length - Decode MSI symbols containing any number of characters within the scanner's capability.



NOTE: Due to the construction of the MSI symbology, it is possible for a scan line covering only a portion of the code to transmit as a complete scan, yielding less data than is encoded in the barcode. To prevent this, select specific lengths (MSI - One Discrete Length, Two Discrete Lengths) for MSI applications.

Select lengths using barcodes in [Numeric Barcodes](#). To correct an error or change the selection, scan [Cancel](#).

For example:

- To decode only MSI symbols with 14 characters, scan MSI - One Discrete Length, and then scan 1, 4.
- To decode only MSI symbols containing either 2 or 14 characters, scan MSI - Two Discrete Lengths, and then scan 0, 2, 1, 4.
- To decode MSI symbols containing between 4 and 12 characters, scan MSI - Length Within Range, and then scan 0, 4, 1, 2.



MSI - One Discrete Length



MSI - Two Discrete Lengths



*MSI - Length Within Range (Default: 4 to 55)



MSI - Any Length

MSI Check Digits

Parameter # 50 (SSI #32h)

This parameter checks the MSI check digit to verify that the data complies with the specified check digit algorithm.

With MSI symbols, one check digit is mandatory and always verified by the reader. The second check digit is optional. If the MSI codes include two check digits, select the Two MSI Check Digits option to enable verification of the second check digit.

- 0 - Does not check the MSI check digit; decodes MSI with no check digit.
- 1 - This is for MSI barcodes with one check digit. This is the default.
- 2 - This is for MSI barcodes with two check digits.

See [MSI Check Digit Algorithm](#) to select second digit algorithms.



No MSI Check Digit (0)



*One MSI Check Digits (1)



Two MSI Check Digit (2)

Transmit MSI Check Digit(s)

Parameter # 46 (SSI #2Eh)

This parameter transmits MSI data with or without the check digit.

- Enabled - transmits MSI data with check digit.
- *Disabled - does not transmit MSI data check digit.



Transmit MSI Check Digit(s) (Enable) (1)



*Do Not Transmit MSI Check Digit(s) (Disable) (0)

MSI Check Digit Algorithm

Parameter # 51 (SSI #33h)

This parameter selects the algorithm used to encode the check digit.

Two algorithms are available for verifying the second MSI check digit. Select one of the following options to select the algorithm used to encode the check digit.



MOD 11/MOD 10 (0)



*MOD 10/MOD 10 (1)

MSI Reduced Quiet Zone

Parameter # 1392 (SSI #F8h 05h 70h)

This parameter enables or disables decoding MSI with reduced quiet zones (the margins on either side of the barcode).

If you select Enable, select a [1D Quiet Zone Level](#).

- *Disabled - disables MSI with reduced Quiet Zones.
- Enabled - enables MSI with reduced Quiet Zones.



*Disable MSI Reduced Quiet Zone (0)



Enable MSI Reduced Quiet Zone (1)

MSI Security Level

Parameter # 2122 (SSI # F8 08 4A)

The digital scanner offers four levels of decode security for MSI bar codes. There is an inverse relationship between security and digital scanner aggressiveness. Increasing the level of security can reduce scanning aggressiveness, so select only the level of security necessary.

MSI Security Level 0: This setting allows the digital scanner to operate in its most aggressive state, while providing sufficient security in decoding most in-spec bar codes.

MSI Security Level 1: This default setting eliminates most misdecodes.

MSI Security Level 2: Select this option with greater bar code security requirements if Security Level 1 fails to eliminate misdecodes.

MSI Security Level 3: If you selected Security Level 2, and misdecodes still occur, select this security level to apply the highest safety requirements.



NOTE: Selecting this option is an extreme measure against mis-decoding severely out-of-spec bar codes, and significantly impairs the decoding ability of the digital scanner. If this level of security is required, try to improve the quality of the bar codes.



Security Level 0 (0)



Security Level 1 (1*)



Security Level 2 (2)



Security Level (3)

Chinese 2 of 5

Parameter # 408 (SSI #98h)

This parameter enables or disables Chinese 2 of 5.

- Enabled - enables Chinese 2 of 5.
- *Disabled - disables Chinese 2 of 5.



Enable Chinese 2 of 5 (1)



*Disable Chinese 2 of 5 (0)

Matrix 2 of 5

Parameter # 618 (SSI #F1h 6Ah)

This parameter enables or disables Matrix 2 of 5.

- Enabled - enables Matrix 2 of 5.
- *Disabled - disables Matrix 2 of 5.



Enable Matrix 2 of 5 (1)



*Disable Matrix 2 of 5 (0)

Set Lengths for Matrix 2 of 5

L1 Parameter # 619 (SSI #F1h 6Bh)

L2 Parameter # 620 (SSI #F1h 6Ch)

This parameter set lengths for Matrix 2 of 5.

The length of a code refers to the number of characters (for example, human-readable characters), including check digit(s) the code contains. Set lengths for Matrix 2 of 5 to any length, one or two discrete lengths, or lengths within a specific range. The default is 4 to 55. The maximum range is 0-80.



NOTE: When setting lengths, enter a leading zero for single-digit numbers.

Scan one of the following barcodes to select a length option:

- One Discrete Length - Decode only Matrix 2 of 5 symbols containing a selected length.
- Two Discrete Lengths - Decode only Matrix 2 of 5 symbols containing either of two lengths.
- Length Within Range - Decode Matrix 2 of 5 symbols with a specific length range.
- Any Length - Decode Matrix 2 of 5 symbols containing any number of characters within the scanner's capability.

Select lengths using barcodes in [Numeric Barcodes](#). To correct an error or change the selection, scan [Cancel](#).

For example:

- To decode only Matrix 2 of 5 symbols with 14 characters, scan Matrix 2 of 5 - One Discrete Length, and then scan 1, 4.
- To decode only Matrix 2 of 5 symbols containing either 2 or 14 characters, scan Matrix 2 of 5 - Two Discrete Lengths, and then scan 0, 2, 1, 4.
- To decode Matrix 2 of 5 symbols containing between 4 and 12 characters, scan Matrix 2 of 5 - Length Within Range, and then scan 0, 4, 1, 2.



Matrix 2 of 5 - One Discrete Length



Matrix 2 of 5 - Two Discrete Lengths



*Matrix 2 of 5 - Length Within Range (Default: 4 to 55)



Matrix 2 of 5 - Any Length

Matrix 2 of 5 Check Digit

Parameter # 622 (SSI #F1h 6Eh)

This parameter determines whether to include the Matrix 2 of 5 check digit with the barcode data.

The check digit is the last character of the symbol used to verify the integrity of the data.

- Enabled - enables Matrix 2 of 5 Check Digit.
- *Disabled - disables Matrix 2 of 5 Check Digit.



Enable Matrix 2 of 5 Check Digit (1)

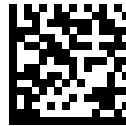

*Disable Matrix 2 of 5 Check Digit (0)

Transmit Matrix 2 of 5 Check Digit

Parameter # 623 (SSI #F1h 6Fh)

This parameter transmits Matrix 2 of 5 data with or without the check digit.

- Transmit - enables Transmit Matrix 2 of 5 Check Digit.
- *Do Not Transmit - does not Transmit Matrix 2 of 5 Check Digit.



Transmit Matrix 2 of 5 Check Digit (1)



*Do Not Transmit Matrix 2 of 5 Check Digit (0)

Inverse 1D

Parameter # 586 (SSI #F1h 4Ah)

This parameter sets the 1D inverse decoder setting.

- Regular Only - The scanner decodes regular 1D barcodes only.
- Inverse Only - The scanner decodes inverse 1D barcodes only.
- Inverse Autodetect - The scanner decodes both regular and inverse 1D barcodes.



NOTE: This parameter does not apply to GS1 DataBarcode types.



NOTE: The Inverse 1D setting may impact Composite or Inverse Composite decoding.



*Regular (0)



Inverse Only (1)



Inverse Autodetect (2)

GS1 DataBar

The variants of GS1 DataBar are DataBar Omnidirectional, DataBar Limited, and DataBar Expanded. The limited and expanded versions have stacked variants. Choose to enable or disable each variant of the GS1 DataBar.

GS1 DataBar Omnidirectional (formerly GS1 DataBar-14)

Parameter # 338 (SSI #F0h 52h)

This parameter enables or disables GS1 DataBar Omnidirectional.

- *Enabled - enables GS1 DataBar Omnidirectional.
- Disabled - disables GS1 DataBar Omnidirectional.



*Enable GS1 DataBar Omnidirectional (1)



Disable GS1 DataBar Omnidirectional (0)

GS1 DataBar Limited

Parameter # 339 (SSI #F0h 53h)

This parameter enables or disables GS1 DataBar Limited.

- *Enabled - enables GS1 DataBar Limited.
- Disabled - disables GS1 DataBar Limited.



*Enable GS1 DataBar Limited (1)



Disable GS1 DataBar Limited (0)

GS1 DataBar Expanded

Parameter # 340 (SSI #F0h 54h)

This parameter enables or disables GS1 DataBar Expanded.

- *Enabled - enables GS1 DataBar Expanded.
- Disabled - disables GS1 DataBar Expanded.

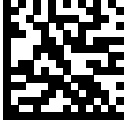

*Enable GS1 DataBar Expanded (1)



Disable GS1 DataBar Expanded (0)

Convert GS1 DataBar to UPC/EAN/JAN

Parameter # 397 (SSI #F0h, 8Dh)

This parameter enables or disables Convert GS1 DataBar to UPC/EAN/JAN.

- Enabled - enables Convert GS1 DataBar to UPC/EAN/JAN.
- *Disabled - disables Convert GS1 DataBar to UPC/EAN/JAN.

This parameter only applies to GS1 DataBar Omnidirectional and GS1 DataBar Limited symbols not decoded as part of a Composite symbol. Enable Convert GS1 DataBar to UPC/EAN/JAN strips the leading '010' from DataBar Omnidirectional and DataBar Limited symbols encoding a single zero as the first digit, and then reports as EAN-13.

For barcodes beginning with between two and five zeros, this strips the leading '0100' and reports the barcode as UPC-A. The [UPC-A Preamble](#) option that transmits the system character and country code applies to converted barcodes. Note that neither the system character nor the check digit can be stripped.



Enable Convert GS1 DataBar to UPC/EAN/JAN (1)



*Disable Convert GS1 DataBar to UPC/EAN/JAN (0)

GS1 DataBar Security Level

Parameter # 1706 (SSI #F8h 06h AAh)

This parameter sets the security level for GS1 DataBar.

The scanner offers four levels of decode security for GS1 DataBar (GS1 DataBar Omnidirectional, GS1 DataBar Limited, GS1 DataBar Expanded) barcodes.

- Security Level 0 - The scanner operates in its most aggressive state, while providing sufficient security decoding most in-spec barcodes.
- *Security Level 1 - This setting eliminates most misdecodes while maintaining reasonable aggressiveness.
- Security Level 2 - Select this option with greater barcode security requirements if Security Level 1 fails to eliminate misdecodes.
- Security Level 3 - If you selected Security Level 2 and misdecodes still occur, select this security level to apply the highest safety requirements.



GS1 DataBar Security Level 0 (0)

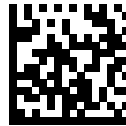

*GS1 DataBar Security Level 1 (1)



GS1 DataBar Security Level 2 (2)



GS1 DataBar Security Level 3 (3)

GS1 DataBar Limited Margin Check

Parameter # 728 (SSI #F1h D8h)

This parameter sets the margin level for GS1 DataBar.

The scanner offers four levels of decode security for GS1 DataBar Limited barcodes. There is an inverse relationship between the level of margin check and scanner aggressiveness. Increasing the level of margin check can reduce scanning aggressiveness, so select only the level of margin check necessary.

- Margin Check Level 1 – No clear margin required. This complies with the original GS1 standard, yet can result in erroneous decoding of a DataBar Limited barcode when scanning some UPC symbols that start with digits 9 and 7.
- Margin Check Level 2 – Automatic risk detection. This level of margin check can result in erroneous decoding of DataBar Limited barcodes when scanning some UPC symbols. If a misdecode is detected, the scanner operates in Level 3 or Level 1.
- *Margin Check Level 3 – Margin check level reflects the newly proposed GS1 standard that requires a five times trailing clear margin.
- Margin Check Level 4 – Margin check level extends beyond the standard required by GS1. This level of margin check requires a five times leading and trailing clear margin.



GS1 DataBar Limited Margin Check Level 1 (1)



GS1 DataBar Limited Margin Check Level 2 (2)



*GS1 DataBar Limited Margin Check Level 3 (3)

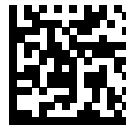

GS1 DataBar Limited Margin Check Level 4 (4)

Symbology-Specific Security Features

These security features are unique to the Symbology section.

Redundancy Level

Parameter # 78 (SSI #4Eh)

This parameter selects the redundancy level appropriate for the barcode quality.

Select higher redundancy levels for decreasing levels of barcode quality. As redundancy levels increase, the scanner's aggressiveness decreases.

- *Redundancy Level 1 - The scanner must read the following code types twice before decoding:
 - Codabar (8 characters or less)
 - MSI (4 characters or less)
 - D 2 of 5 (8 characters or less)
 - I 2 of 5 (8 characters or less)
- Redundancy Level 2 - The scanner must read all code types twice before decoding.
- Redundancy Level 3 - The scanner must read code types other than the following twice before decoding, but must read the following codes three times:
 - Codabar (8 characters or less)
 - MSI (4 characters or less)
 - D 2 of 5 (8 characters or less)
 - I 2 of 5 (8 characters or less)
- Redundancy Level 4 - The scanner must read all code types three times before decoding.



*Redundancy Level 1 (1)

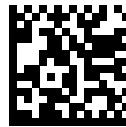

Redundancy Level 2 (2)



Redundancy Level 3 (3)



Redundancy Level 4 (4)

Security Level

Parameter # 77 (SSI #4Dh)

This parameter sets the security level.

The scanner offers four levels of decode security, which include the Code 128 family, UPC/EAN/JAN, and Code 93. Select increasing levels of security for decreasing levels of scanning quality. There is an inverse relationship between security and scanner aggressiveness, so choose only that level of security necessary for the application.

- Security Level 0 - The scanner operates in its most aggressive state, while providing sufficient security decoding most in-spec barcodes.
- Security Level 1 - This default setting eliminates most mis-decodes.
- Security Level 2 - Select this option if Security Level 1 fails to eliminate mis-decodes.
- Security Level 3 - If you selected Security Level 2 and mis-decodes still occur, select this security level.



NOTE: Selecting this option is an extreme measure against mis-decoding severely out-of-spec barcodes, and significantly impairs the decoding ability of the scanner. If this level of security is required, try to improve the quality of the barcodes.



Security Level 0 (0)



*Security Level 1 (1)



Security Level 2 (2)

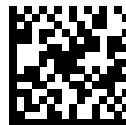

Security Level 3 (3)

1D Quiet Zone Level

Parameter # 1288 (SSI #F8h 05h 08h)

This parameter sets the level of aggressiveness when setting a reduced quiet zone (the margin on either side of a barcode), and applies to symbologies enabled by a Reduced Quiet Zone parameter.

Because higher levels increase the decoding time and risk of mis-decodes, Zebra strongly recommends enabling only the symbologies which require higher quiet zone levels, and leaving Reduced Quiet Zone disabled for all other symbologies. Options are:

- 1D Quiet Zone Level 0 - The scanner performs normally in terms of quiet zone.
- *1D Quiet Zone Level 1 - The scanner performs more aggressively in terms of quiet zone.
- 1D Quiet Zone Level 2 - The scanner only requires a quiet zone at the end of barcode for decoding.
- 1D Quiet Zone Level 3 - The scanner decodes anything in terms of quiet zone or end of barcode.



1D Quiet Zone Level 0 (0)



*1D Quiet Zone Level 1 (1)



1D Quiet Zone Level 2 (2)



1D Quiet Zone Level 3 (3)

Intercharacter Gap Size

Parameter # 381 (SSI #F0h 7Dh)

This parameter enables a device to tolerate large intercharacter gap sizes.

The Code 39 and Codabar symbologies have an intercharacter gap that is typically quite small. Due to various barcode printing technologies, this gap can grow larger than the maximum size allowed, preventing the scanner from decoding the symbol. If this problem occurs, scan the Large Intercharacter Gaps parameter to tolerate these out-of-specification barcodes.



*Normal Intercharacter Gaps (6)



Large Intercharacter Gaps (10)

Composite

Composites link symbols or barcodes together and they are read by a scanner as one object.

Composite CC-C

Parameter # 341 (SSI #F0h 55h)

This parameter enables or disables Composite barcodes of type CC-C.

- Enabled - enables CC-C.
- *Disabled - disables CC-C.



Enable CC-C (1)



*Disable CC-C (0)

Composite CC-A/B

Parameter # 342 (SSI #F0h 56h)

This parameter enables or disables CC-A/B.

- Enabled - enables CC-A/B.
- *Disabled - disables CC-A/B.



Enable CC-A/B (1)



*Disable CC-A/B (0)

Composite TLC-39

Parameter # 371 (SSI #F0h 73h)

This parameter enables or disables TLC-39.

- Enabled - enables TLC-39.
- *Disabled - disables TLC-39.



Enable TLC39 (1)



*Disable TLC39 (0)

Composite Inverse

Parameter # 1113 (SSI #F8h 04h 59h)

This parameter sets Composite for either regular decode or inverse decode.

- *Regular Only - The scanner decodes regular Composite barcodes only. Before selecting this, set [Inverse 1D](#) to Regular Only or Inverse Autodetect.
- Inverse Only - The scanner decodes inverse Composite barcodes only. This mode only supports Composite Inverse that includes DataBar combined with CCAB, and does not support other 1D/2D combinations. Before selecting this, first enable [Composite CC-A/B](#), and set [Inverse 1D](#) to Inverse Only or Inverse Autodetect.



*Regular Only (0)



Inverse Only (1)

UPC Composite Mode

Parameter # 344 (SSI #F0h 58h)

This parameter links UPC symbols with a 2D symbol during transmission as if they were one symbol.

- *UPC Never Linked - Transmit UPC barcodes regardless of whether a 2D symbol is detected.
- UPC Always Linked - Transmit UPC barcodes and the 2D portion. If 2D is not present, do not transmit the barcode.
- Autodiscriminate UPC Composites - The scanner determines if there is a 2D portion, then transmits the UPC, as well as the 2D portion if present.



*UPC Never Linked (0)



UPC Always Linked (1)



Autodiscriminate UPC Composites (2)

Composite Beep Mode

Parameter # 398 (SSI #F0h 8Eh)

This parameter selects the number of decode beeps that sound upon decoding a Composite.

- Single Beep - after both are decoded.
- *Beep for each code type - as each code type is decoded.
- Double Beep - after both are decoded.



Single Beep After Both are Decoded (0)

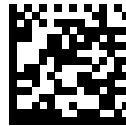

*Beep as Each Code Type is Decoded (1)



Double Beep After Both are Decoded (2)

GS1-128 Emulation Mode for UCC/EAN Composite Codes

Parameter # 427 (SSI #F0h ABh)

This parameter enables or disables GS1-128 Emulation Mode for UCC/EAN Composite Codes.

- Enabled - enables GS1-128 Emulation Mode for UCC/EAN Composite Codes.
- *Disabled - disables GS1-128 Emulation Mode for UCC/EAN Composite Codes.



Enable GS1-128 Emulation Mode for UCC/EAN
Composite Codes (1)



*Disable GS1-128 Emulation Mode for UCC/EAN
Composite Codes (0)

2D Symbologies

The following parameters are specific to 2D Symbologies.

PDF417

Parameter # 15 (SSI 0Fh)

This parameter enables or disables PDF417.

- *Enabled - enables PDF417.
- Disabled - disables PDF417.



*Enable PDF417 (1)



Disable PDF417 (0)

MicroPDF417

Parameter # 227 (SSI #E3h)

This parameter enables or disables MicroPDF417

- Enabled - enables MicroPDF417.
- *Disabled - disables MicroPDF417.



Enable MicroPDF417 (1)



*Disable MicroPDF417 (0)

Code 128 Emulation

Parameter # 123 (SSI #7Bh)

This parameter transmits data from certain MicroPDF417 symbols as Code 128.

You must enable [AIM Code Characters](#) for this parameter to work.

Enable Code 128 Emulation to transmit these MicroPDF417 symbols with one of the following prefixes:

]C1 if the first codeword is 903-905

]C2 if the first codeword is 908 or 909

]C0 if the first codeword is 910 or 911

Disable Code 128 Emulation to transmit these MicroPDF417 symbols with one of the following prefixes:

]L3 if the first codeword is 903-905

]L4 if the first codeword is 908 or 909

]L5 if the first codeword is 910 or 911



NOTE: Linked MicroPDF codewords 906, 907, 912, 914, and 915 are not supported. Use GS1 Composites instead.



Enable Code 128 Emulation (1)



*Disable Code 128 Emulation (0)

Data Matrix

Parameter # 292 (SSI #F0h 24h)

This parameter enables or disables Data Matrix.

- *Enabled - enables Data Matrix.
- Disabled - disables Data Matrix.



*Enable Data Matrix (1)

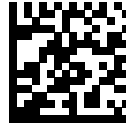

Disable Data Matrix (0)

GS1 Data Matrix

Parameter # 1336 (SSI #F8h 05h 38h)

This parameter enables or disables GS1 Data Matrix.

- Enabled - enables GS1 Data Matrix.
- *Disabled - disables GS1 Data Matrix.



Enable GS1 Data Matrix (1)



*Disable GS1 Data Matrix (0)

Data Matrix Inverse

Parameter # 588 (SSI #F1h 4Ch)

This parameter selects the Data Matrix inverse decoder setting.

- Regular Only - The scanner decodes regular Data Matrix barcodes only.
- Inverse Only - The scanner decodes inverse Data Matrix barcodes only.
- *Inverse Autodetect - The scanner decodes both regular and inverse Data Matrix barcodes.



Regular Only (0)

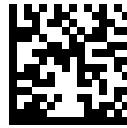

Inverse Only (1)



*Inverse Autodetect (2)

Decode Data Matrix Mirror Images

Parameter # 537 (SSI #F1h 19h)

This parameter selects an option for decoding Data Matrix mirror images.

- Never - Do not decode Data Matrix barcodes that are mirror images.
- Always - Decode only Data Matrix barcodes that are mirror images.
- *Auto - Decode both mirrored and unmirrored Data Matrix barcodes.



Never (0)



Always (1)



*Auto (2)

Enhanced Dotted Datamatrix

Parameter # 2106 (SSI # 89h)

Enabling this parameter can enhance the decode performance of dotted data matrix barcode. The default is disabled.

- *Disable (0) – Disable the feature
- Enable (1) – Enable the feature



*Disable (0)

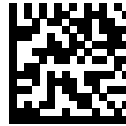

Enable (1)

Maxicode

Parameter # 294 (SSI #F0h 26h)

This parameter enables or disables Maxicode.

- Enabled - enables Maxicode.
- *Disabled - disables Maxicode.



Enable Maxicode (1)



*Disable Maxicode (0)

QR Code

Parameter # 293 (SSI #F0h 25h)

This parameter enables or disables QR Code.

- *Enabled - enables QR Code.
- Disabled - disables QR Code.



NOTE: Enabling this also enables QR Mirrored and Linked QR.



*Enable QR Code (1)



Disable QR Code (0)

Weblink QR

Parameter # 1947 (SSI #F8 07 9Bh)

This parameter enables you to decode or not decode Weblink QR codes.

- Do Not Decode Weblink QR Codes - disables you from decoding Weblink QR codes.
- Decode Weblink QR Codes - enables you to decode Weblink QR codes.



Disable



*Enable

GS1 QR

Parameter # 1343 (SSI #F8h 05h 3Fh)

This parameter enables or disables GS1 QR.

- Enabled* - enables GS1 QR
- Disabled - disables GS1 QR.



Enable* GS1 QR (1)



Disable GS1 QR (0)

MicroQR

Parameter # 573 (SSI #F1h 3Dh)

This parameter enables or disables MicroQR.

- *Enabled - enables MicroQR.
- Disabled - disables MicroQ.



*Enable MicroQR (1)



Disable MicroQR (0)

Linked QR Mode

Parameter # 1847 (SSI #737h)

This parameter selects a linked QR mode.

- *Linked QR Only - The scanner does not decode individual QR symbols from a set of linked QR codes.
- Individual QR With Headers - The scanner decodes individual QR symbols from a set of linked QR codes and retains the header information and data.
- Individual QR No Headers - The scanner decodes individual QR symbols from a set of linked QR codes and transmits the data without header information.



*Linked QR Only (0)



Individual QR With Headers (1)



Individual QR No Headers (2)

Aztec

Parameter # 574 (SSI #F1h 3Eh)

This parameter enables or disables Aztec.

- *Enabled - enables Aztec.
- Disabled - disables Aztec.



NOTE: Enabling this also enables Linked Aztec.



*Enable Aztec (1)



Disable Aztec (0)

Aztec Inverse

Parameter # 589 (SSI #F1h 4Dh)

This parameter selects the Aztec inverse decoder setting.

- Regular Only - The scanner decodes regular Aztec barcodes only.
- Inverse Only - The scanner decodes inverse Aztec barcodes only.
- *Inverse Autodetect - The scanner decodes both regular and inverse Aztec barcodes.



Regular Only (0)

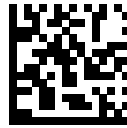

Inverse Only (1)



*Inverse Autodetect (2)

Han Xin

Parameter # 1167 (SSI #F8h 04h 8Fh)

This parameter enables or disables Han Xin.

- Enabled - enables Han Xin.
- *Disabled - disables Han Xin.



Enable Han Xin (1)



*Disable Han Xin (0)

Han Xin Inverse

Parameter # 1168 (SSI #F8h 04h 90h)

This parameter selects a Han Xin inverse decoder setting.

- *Regular Only - The scanner decodes Han Xin barcodes with normal reflectance only.
- Inverse Only - The scanner decodes Han Xin barcodes with inverse reflectance only.
- Inverse Autodetect - The scanner decodes both regular and inverse Han Xin barcodes.



*Regular Only (0)



Inverse Only (1)



Inverse Autodetect (2)

Grid Matrix

Parameter # 1718 (SSI #F8 06h B6h)

This parameter enables or disables Grid Matrix.

- Enabled - enables Grid Matrix.
- *Disabled - disables Grid Matrix.

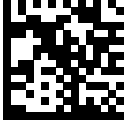

Enable Grid Matrix (1)

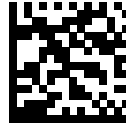

*Disable Grid Matrix (0)

Grid Matrix Inverse

Parameter # 1719 (SSI #F8h 06h B7h)

This parameter selects a Grid Matrix inverse decoder setting.

- *Regular Only - the imager decodes Grid Matrix barcodes with normal reflectance only.
- Inverse Only - the imager decodes Grid Matrix barcodes with inverse reflectance only.
- Inverse Autodetect - the imager decodes both regular and inverse Grid Matrix barcodes.



*Regular (0)



Inverse Only (1)



Inverse Autodetect (2)

Grid Matrix Mirrored

Parameter # 1736 (SSI #F8h 06h C8h)

This parameter selects a mirror image Grid Matrix setting.

- *Non-Mirrored Only - the imager decodes non-mirrored Grid Matrix barcodes only.
- Mirrored Only - the imager decodes mirrored Grid Matrix barcodes only.
- Autodetect - the imager decodes both mirrored and non-mirrored Grid Matrix barcodes.



*Non-Mirrored Only (0)

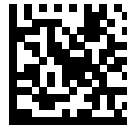

Mirrored Only (1)



Mirrored Autodetect (2)

DotCode

Parameter # 1906 (SSI #F8 07 72h)

You can enable or disable DotCode.

- Enabled - enables DotCode.
- *Disabled - disables DotCode.



*Disable DotCode



Enable DotCode

DotCode Prioritize

Parameter # 1937 (SSI #F8 07 91h)

This parameter enables or disables giving priority to DotCode decoding versus other symbologies.

- Disabled - disables DotCode as a priority.
- *Enabled - enables DotCode as a priority.



Disable

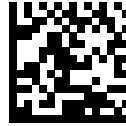

*Enable

DotCode Inverse

Parameter # 1907 (SSI #F8 07 73h)

This parameter selects the DotCode Inverse decoder setting.

- Regular Only - the device decodes DotCode Inverse codes with normal reflectance only.
- Inverse Only - the device decodes DotCode Inverse codes with inverse reflectance only.
- Inverse Autodetect - the device decodes DotCode Inverse codes with both normal and inverse reflectance.



Regular (0)



Inverse Only (1)



*Autodetect (2)

DotCode Mirrored

Parameter # 1908 (SSI #F8 07 74h)

This parameter sets a DotCode Mirror decoder setting.

- Never - decodes non-mirrored DotCode codes only.
- Always - decodes mirrored DotCode codes only.
- *Autodetect - decodes both mirrored and non-mirrored DotCode codes.



Never (0)



Always (1)



*Autodetect

Macro PDF Features

Macro PDF is a special feature for combining multiple PDF symbols into one file. The scanner can decode symbols encoded with this feature, and can store more than 64 Kb of decoded data from up to 50 MacroPDF symbols.

When printing, keep each Macro PDF sequence separate, as each sequence has unique identifiers. Do not mix barcodes from several Macro PDF sequences, even if they encode the same data. When scanning a Macro PDF sequence, scan the entire sequence without interruption. When scanning a mixed sequence, two long low beeps (low/low) indicate an inconsistent file ID or inconsistent symbology error.

Flush Macro PDF Buffer

This parameter flushes the buffer of all decoded Macro PDF data stored to that point, transmits it to the host device, and aborts from Macro PDF mode.



Flush Macro PDF Buffer

Abort Macro PDF Entry

This parameter clears all currently-stored Macro PDF data in the buffer without transmission and aborts from Macro PDF mode.



Abort Macro PDF Entry

Postal Codes

These parameters are regarding postal codes from around the globe.

US Postnet

Parameter # 89 (SSI #59h)

This parameter enables or disables US Postnet.

- Enabled - enables US Postnet.
- *Disabled - disables US Postnet.



Enable US Postnet (1)



*Disable US Postnet (0)

US Planet

Parameter # 90 (SSI #5Ah)

This parameter enables or disables US Planet.

- Enabled - enables US Planet.
- *Disabled - disables US Planet.



Enable US Planet (1)



*Disable US Planet (0)

Transmit US Postal Check Digit

Parameter # 95 (SSI #5Fh)

This parameter selects whether to transmit US Postal data, which includes both US Postnet and US Planet, with or without the check digit.

- *Transmit - transmit US Postal with Check Digit.
- Do Not Transmit - do not transmit US Postal with Check Digit.



*Transmit US Postal Check Digit (1)



Do Not Transmit US Postal Check Digit (0)

UK Postal

Parameter # 91 (SSI # 5Bh)

This parameter enables or disables UK Postal.



Enable UK Postal (1)



*Disable UK Postal (0)

Transmit UK Postal Check Digit

Parameter # 96 (SSI # 60h)

This parameter enables or disables Transmit UK Postal Check Digit.

Scan one of the following barcodes to select whether to transmit UK Postal data with or without the check digit.



*Transmit UK Postal Check Digit (1)



Do Not Transmit UK Postal Check Digit (0)

Japan Postal

Parameter # 290 (SSI # F0h, 22h)

This parameter enables or disables Japan Postal.

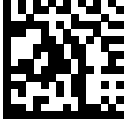

Enable Japan Postal (1)



*Disable Japan Postal (0)

Australia Post

Parameter # 291 (SSI # F0h, 23h)

This parameter enables or disables Australia Post.



Enable Australia Post (1)



*Disable Australia Post (0)

Australia Post Format

Parameter # 718 (SSI # F1h, CEh)

This parameter enables or disables Australia Post Format.

- Autodiscriminate (or Smart mode) - Decode the Customer Information Field using the N and C Encoding Tables.



NOTE: This option increases the risk of misdecodes because the encoded data format does not specify the Encoding Table used for encoding.

- Raw Format - Output raw bar patterns as a series of numbers 0 through 3.
- Alphanumeric Encoding - Decode the Customer Information Field using the C Encoding Table.
- Numeric Encoding - Decode the Customer Information Field using the N Encoding Table.

For more information on Australia Post Encoding Tables, refer to the Australia Post Customer Barcoding Technical Specifications available at auspost.com.au.



*Autodiscriminate (0)



Raw Format (1)



Alphanumeric Encoding (2)



Numeric Encoding (3)

Netherlands KIX Code

Parameter # 326 (SSI # F0h, 46h)

This parameter enables or disables Netherlands KIX Code.



Enable Netherlands KIX Code (1)

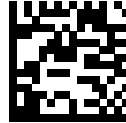

*Disable Netherlands KIX Code (0)

USPS 4CB/One Code/Intelligent Mail

Parameter # 592 (SSI # F1h 50h)

This parameter enables or disables USPS 4CB/One Code/Intelligent Mail.

Scan one of the following barcodes to enable or disable USPS 4CB/One Code/Intelligent Mail.



Enable USPS 4CB/One Code/Intelligent Mail (1)



*Disable USPS 4CB/One Code/Intelligent Mail (0)

UPU FICS Postal

Parameter # 611 (SSI # F1h 63h)

This parameter enables or disables Code 39.

Scan one of the following barcodes to enable or disable UPU FICS Postal.



Enable UPU FICS Postal (1)



*Disable UPU FICS Postal (0)

Mailmark

Parameter # 1337 (SSI # F8h 05h 39h)

This parameter enables or disables Mailmark.

Scan one of the following barcodes to enable or disable Mailmark.



*Disable Mailmark (0)



Enable Mailmark (1)

Posti LAPA 4-State Code

Parameter # 2031 (SSI #F8 07EF)

This parameter enables or disables Posti LAPA.

- *Disabled - disable Posti LAPA.
- Enabled - enables Posti LAPA.



*Disable Posti LAPA (0)



Enable Posti LAPA (1)

Electronic Article Surveillance (EAS)

You can program the scanner to perform various functions, or activate different features. This section describes the Electronic Article Surveillance (EAS) features and provides programming options for selecting these features.

The scanner ships with the settings shown in [EAS Parameter Defaults](#). If the default values suit requirements, programming is not necessary.



NOTE: Configurations listed with Color Camera and Sensormatic EAS features will be available in Q4 2023.

EAS Parameter Defaults

The following table lists the defaults for EAS parameters.

Change these values in one of two ways:

- Scan the appropriate options in this section. The new value replaces the standard default value in memory. To recall default parameter values, see [Default Parameters](#).
- Configure the scanner using the 123Scan configuration program. See [123Scan and Software Tools](#).

Table 32 EAS Parameter Defaults

Parameter	Parameter Number	Default
EAS Parameters		
Operating Modes	977	Disable
Sensormatic Deactivation Timeout	982	10 seconds
Sensormatic EAS Deactivation	979	Enable
Sensormatic EAS Soft Tag Beeps	984	Soft Tag Beep 1
Sensormatic Hard Tag Beeps	985	Hard Tag Beep 1
Sensormatic EAS Tag Detected Any Time Beep	980	Enable
Sensormatic EAS Deactivation Fail Beep	1213	Disable
Sensormatic Request Communication/Connection Message	978	Enable
Checkpoint Interlock Polarity	983	Active High

EAS Parameters

Use these parameters with EAS.

EAS Operating Modes

Parameter # 977

In addition to EAS preferences, the following EAS operating modes for the scanner enable EAS functionality, independent of whether EAS equipment is connected.

The installer must match the mode with the installed equipment. Enabling a mode without EAS equipment, or with the wrong equipment installed, results in EAS error messages.

Select the appropriate mode to configure the scanner for EAS functionality.

- [Sensormatic Auto Mode](#)
- [Sensormatic Always Enable Deactivation Mode](#)
- [Sensormatic Barcode Interlock Mode](#)
- [Sensormatic Barcode Auto Interlock Mode](#)
- [Barcode Hold Off Mode](#)
- [Sensormatic Scan Enable Interlock Mode](#)
- [Checkpoint Barcode Interlock Mode](#)
- [Checkpoint Scan Enable Interlock Mode](#)
- [*EAS Disable Mode](#)

Sensormatic Auto Mode

This mode depends on the Scan Enable Time value the scanner reads from the Sensormatic ScanMax Pro control box, set by Sensormatic during installation.

- If the Scan Enable Time equals 0 seconds or 30 seconds, the scanner operates in [Sensormatic Scan Enable Interlock Mode](#).
- If the Scan Enable Time is set from 1 second to 29 seconds, tag deactivation is active following a barcode decode, and remains active until this timer expires.



NOTE: More than one tag can be deactivated during this time.



Sensormatic Auto Mode (0)

Sensormatic Always Enable Deactivation Mode

Tag deactivation is always enabled when the scanner is powered on.



NOTE: In this mode, the scanner always deactivates tags in the deactivation field.



Sensormatic Always Enable Deactivation Mode (1)

Sensormatic Barcode Interlock Mode

Tag deactivation is enabled only after a barcode is decoded.

The tag deactivation time uses the value set for [Sensormatic Deactivation Timeout](#).



NOTE: Tags in the deactivation field can also be deactivated during the deactivation time.



Sensormatic Barcode Interlock Mode (2)

Sensormatic Barcode Auto Interlock Mode

Tag deactivation is enabled only after a barcode is decoded. The deactivation state only lasts 1.2 seconds to avoid subsequent tag deactivation.



Sensormatic Barcode Auto Interlock Mode (3)

Sensormatic Barcode Hold Off Mode

If the scanner detects a tag, it does not decode barcodes (the scanner does not beep or transmit to the host) until the tag is deactivated.



NOTE: A barcode decode does not occur if a hard tag is detected until the tag is removed from the detection field.



Sensormatic Barcode Hold Off Mode (4)

Sensormatic Scan Enable Interlock Mode

If the host (POS application) sends a Scan Enable message to the scanner, the deactivated tag is enabled.
If the host sends a Scan Disable message, the deactivated tag is disabled.



Sensormatic Scan Enable Interlock Mode (5)

Checkpoint Barcode Interlock Mode

This mode enables Checkpoint tag deactivation for several seconds after a barcode is decoded. The Checkpoint device controls all audible and visual feedback (the scanner does not produce audio and visual feedback for tag detection or tag deactivation).

The Checkpoint installer can also set this in the Checkpoint device.



Checkpoint Barcode Interlock Mode (6)

Checkpoint Scan Enable Interlock Mode

If the host (POS application) sends a Scan Enable message to the scanner, tag deactivation is active. If the host sends a Scan Disable message, tag deactivation is inactive. Tag deactivation is enabled on power on.



Checkpoint Scan Enable Interlock Mode (7)

EAS Disable Mode

EAS tags are not detected or deactivated.



*EAS Disable Mode (8)

Sensormatic Deactivation Timeout

Parameter # 982

This parameter determines the time that EAS tag deactivation is allowed after a barcode decode.

This option only applies to [Sensormatic Barcode Interlock Mode](#).



NOTE: When a tag is deactivated, additional deactivations can occur if the deactivation period is still active.

To set the EAS deactivation time from 1 to 29 seconds, scan Sensormatic Deactivation Timeout, and then scan two numeric barcodes from [Numeric Barcodes](#). Enter a leading zero for single-digit numbers.

For example, to set the deactivation time period to 8 seconds, scan Sensormatic Deactivation Timeout, and then scan the 0 and 8 barcodes. To correct an error or change the selection, scan [Cancel](#).



Sensormatic Deactivation Timeout

Sensormatic EAS Deactivation

Parameter # 979

This parameter enables deactivating of soft tags.

Choose one of the following:

- Enabled - EAS soft tags are deactivated.
- Disabled - EAS soft tags are not deactivated.



*Sensormatic Enable EAS Deactivation (1)



Sensormatic Disable EAS Deactivation (0)

Sensormatic EAS Beeps

The following parameters set an audible alert upon Sensormatic EAS tag detection and/or deactivation. These modes have no affect if using Checkpoint equipment.

The following table lists the programmable tag-related beeps, as well as the non-programmable EAS communication beeps.

Table 33 Sensormatic Beep Types

Beep Type	Description
Sensormatic EAS Tag-related Beeps	
Sensormatic EAS Soft Tag Beeps	A soft tag is deactivated.
Sensormatic EAS Hard Tag Beeps	The scanner conclusively detected a hard tag.
Sensormatic Tag Detected Any Time Beep	A soft or hard tag is in the detected field.
Sensormatic EAS Deactivation Fail Beep	A tag is not deactivated, is considered live, and the type of tag (soft or hard) cannot be determined.
Sensormatic EAS Communication Beeps	
Sensormatic EAS Communication Disconnect Beep (high-low)	The scanner disconnected from the Sensormatic control box.
Sensormatic EAS Communication Reconnect Beep (low-high)	The scanner reconnected to the Sensormatic control box.

Sensormatic EAS Soft Tag Beeps

Parameter # 984

This parameter enables soft tag beeps upon deactivation.

Choose one of the following:

- Sensormatic EAS Soft Tag Beep 1 - sound a short low beep when an EAS soft tag is deactivated.
- Sensormatic EAS Soft Tag Beep 2 - sound a medium duration low beep when an EAS soft tag is deactivated.
- Disable EAS Soft Tag Beep - sound no beep when an EAS soft tag is deactivated.



*Sensormatic EAS Soft Tag Beep 1 (1)



Sensormatic EAS Soft Tag Beep 2 (2)



Disable EAS Soft Tag Beep (0)

Sensormatic EAS Hard Tag Beeps

Parameter # 985

This parameter enables hard tag beeps upon detection.

Choose one of the following:

- Sensormatic EAS Hard Tag Beep 1 - sound a short high beep when an EAS hard tag is detected.
- Sensormatic EAS Hard Tag Beep 2 - sound a medium duration high beep when an EAS hard tag is detected.
- Disable EAS Hard Tag Beep - sound no beep when an EAS hard tag is detected.



*Sensormatic EAS Hard Tag Beep 1 (1)

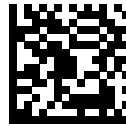

Sensormatic EAS Hard Tag Beep 2 (2)



Disable EAS Hard Tag Beep (0)

Sensormatic EAS Tag Detected Any Time Beep

Parameter # 980

This parameter enables the scanner to beep when a soft or hard tag is detected.

Choose one of the following:

- Enabled - scanner detects soft or hard tags and beeping is activated.
- Disabled - scanner detects soft or hard tags and beeping is not activated.



*Enable Detected Any Time Beep (1)

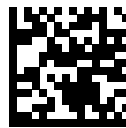

Disable Detected Any Time Beep (0)

Sensormatic EAS Deactivation Fail Beep

Parameter # 1213

This parameter enables the scanner to sound a deactivation fail beep if a tag is not deactivated, is considered live, and the type of tag (soft or hard) cannot be determined.

Choose one of the following:

- Enabled - sounds a deactivation fail beep.
- Disabled - does not sound a deactivation fail beep.



Enable Deactivation Fail Beep (1)



*Disable Deactivation Fail Beep (0)

Sensormatic Request Messages

The following parameters enable the three EAS message types.

- Request Communication/Connection Message
- Request Voltage Message
- Request Scan Time Message

Enabling a message type periodically sends messages between the scanner and the control box, approximately every 2 seconds. Error messages display on the . Refer to the Scanner Integrator Guide for error messages.

Sensormatic Request Communication/Connection Message

Parameter # 978

This parameter enables communication with the control box.

Choose one of the following:

- Enabled - facilitates communication.
- Disabled - does not enable communication.

Enable this to allow communication with the control box.



*Enable Communication/Connection Message (1)

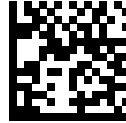

Disable Communication/Connection Message (0)

Checkpoint Interlock Polarity

Parameter # 983

This parameter determines the interlock pulse polarity required to deactivate a tag.



NOTE: The polarity must match the setting in the EAS control box.

Choose one of the following options:

- Active Low - An active low pulse initiates tag deactivation.
- Active High - An active high pulse initiates tag deactivation.



Active Low (0)



*Active High (1)

Connecting an Auxiliary Scanner

This chapter provides instructions to configure the SP72 for connection to an auxiliary scanner. Refer to the auxiliary scanner's Product Reference Guide to program it with matching settings.

The SP72 provides a USB port to connect an auxiliary hand-held scanner. See the diagrams in each interface chapter for host and auxiliary scanner connection details.

Auxiliary scanners that are supported by the SP72 include but are not limited to Zebra's DS9908, DS9308, DS8x8, and DS22x8.



NOTE: Power off the SP72 before connecting or disconnecting an auxiliary scanner.

Programming the Auxiliary Scanner

The auxiliary scanner can be programmed in the following ways:

- Connect the auxiliary scanner to the SP72 and connect the SP72 to a PC running 123Scan². You can program both (independently) via 123Scan².
- Scan a macro programming bar code from this guide, or one created via 123Scan² using the auxiliary scanner.
- Scan the programming bar codes in this guide using the auxiliary scanner.



NOTE: When the SP72 powers up it automatically configures the auxiliary scanner host type to be the same as the SP72 host type. All of the other auxiliary scanner settings and user parameters remain as is.

Downloading Firmware

Updating firmware on the auxiliary scanner can be done in the following ways:

- Connect the auxiliary scanner to a PC running 123Scan². Update firmware via 123Scan².
- Connect the auxiliary scanner to the SP72 and connect the SP72 to a PC running 123Scan². You can update firmware in both (independently) via 123Scan².

12VDC Power Requirement

The SP72 requires 12VDC when an auxiliary scanner is connected.

12VDC is provided as follows:

- USB (Series A) - A 12VDC USB (Series A) cable and 12VDC power supply are required.
- USB (PowerPlus) - A 12VDC USB (PowerPlus) cable is required. 12VDC provided by host.
- RS-232 - A 12VDC RS-232 cable and 12VDC power supply are required.
- IBM (RS485) - A 12VDC IBM (RS485) cable is required. 12VDC provided by host.
- Keyboard Wedge - A 12VDC Keyboard Wedge cable and 12VDC power supply are required.



NOTE: Power supply model PWRS-14000-148R or PWRS-14000-148C is required for USB (Series A) and RS-232.

Using Auxiliary Scanners

Provides reference information for the use of both Zebra and Non-Zebra Auxiliary Scanners.

Using a Zebra Scanner as an Auxiliary Scanner

Provides information as to the use of Zebra Auxiliary Scanner

When the SP72 powers up, it automatically configures the auxiliary scanner host type to be the same as the SP72 host type. This feature is supported by Zebra scanners that support RSM commands. Some Zebra scanners, such as the LS1203 and older LS2208s, do not support this feature. (Refer to Using a Zebra Scanner That Does Not Support RSM Commands as an Auxiliary Scanner.) All of the other auxiliary scanner settings and user parameters remain as is.



NOTE: An auxiliary cordless scanner, such as the LI4278, LS4278, or DS6878, can be attached to the SP72. If a presentation cradle is used with any of these scanners, a separate cradle power supply (12VDC) is required. If a standard cradle is used with the DS6878, a separate cradle power supply (5VDC) is required.

Using a Non-Zebra Scanner as an Auxiliary Scanner

Provide information about connecting a non-Zebra scanner.

The SP72 provides a USB port to connect an auxiliary hand-held scanner. Non-Zebra scanners must be programmed separately and pre-configured for the appropriate host type before connecting to SP72 .



NOTE: Zebra does not guarantee that a non-Zebra scanner will operate as an auxiliary scanner on the SP72

Numeric Barcodes

For parameters requiring specific numeric values, scan the appropriately numbered barcode(s).



0



1



2



3



4



5



6



7



8



9

Cancel

To correct an error or change a selection, scan the barcode below.



Cancel

Alphanumeric Barcodes

For parameters requiring specific alphanumeric values, scan the appropriately numbered barcode(s).

Cancel

To correct an error or change a selection, scan the barcode below.



Cancel

Alphanumeric Barcodes 1



Space



#



\$

Alphanumeric Barcodes



*



-



/



“



%



+



.

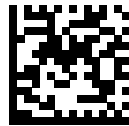

!

Alphanumeric Barcodes



c



)



;



=



&



(



:



<

Alphanumeric Barcodes



?



[



]



-



>

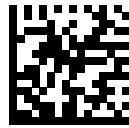

@



\



^



'



NOTE: Do not confuse the following barcodes with those on the numeric keypad.



0



1



2



3



4

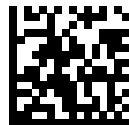

5

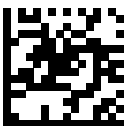

6

Alphanumeric Barcodes



7



8



9

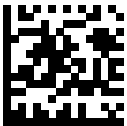

End of Message

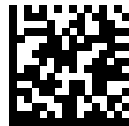

Cancel



A



B



C



E



G



I



K

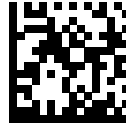

D



F

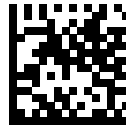

H



J

Alphanumeric Barcodes



M



O



Q



S



L

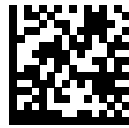

N



P



R

Alphanumeric Barcodes



U



W



Y



a



T



V



X



Z



c



e



g



i



b



d



f



h



k



m



o



q



j



l

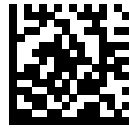

n



p

Alphanumeric Barcodes



s



u



w



y



r

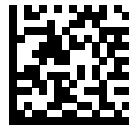

t



v

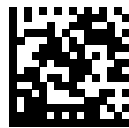

x



{



}



z



|

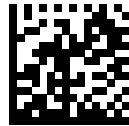

~

ASCII Character Sets



NOTE: For the Keyboard Wedge Interface, Code 39 Full ASCII interprets the barcode special character (\$ + % /) preceding a Code 39 character and assigns an ASCII character value to the pair. For example, if you enable Code 39 Full ASCII and scan +B, it transmits as b, %J as ?, and %V as @. Scanning ABC%i outputs the keystroke equivalent of ABC >.

ASCII Value (Prefix/ Suffix Value)	Full ASCII Code 39 Encode Char	Keystroke	ASCII Character (Applies to RS-232 Only)
1000	%U	CTRL 2	NUL
1001	\$A	CTRL A	SOH
1002	\$B	CTRL B	STX
1003	\$C	CTRL C	ETX
1004	\$D	CTRL D	EOT
1005	\$E	CTRL E	ENQ
1006	\$F	CTRL F	ACK
1007	\$G	CTRL G	BELL
1008	\$H	CTRL H/BACKSPACE ^a	BCKSPC
1009	\$I	CTRL I/HORIZONTAL TAB ^b	HORIZ TAB
1010	\$J	CTRL J	LF/NW LN
1011	\$K	CTRL K	VT
1012	\$L	CTRL L	FF
1013	\$M	CTRL M/ENTER ^c	CR/ENTER
1014	\$N	CTRL N	SO
1015	\$O	CTRL O	SI
1016	\$P	CTRL P	DLE
1017	\$Q	CTRL Q	DC1/XON
1018	\$R	CTRL R	DC2
1019	\$S	CTRL S	DC3/XOFF
1020	\$T	CTRL T	DC4
1021	\$U	CTRL U	NAK

ASCII Character Sets

ASCII Value (Prefix/ Suffix Value)	Full ASCII Code 39 Encode Char	Keystroke	ASCII Character (Applies to RS-232 Only)
1022	\$V	CTRL V	SYN
1023	\$W	CTRL W	ETB
1024	\$X	CTRL X	CAN
1025	\$Y	CTRL Y	EM
1026	\$Z	CTRL Z	SUB
1027	%A	CTRL [ESC
1028	%B	CTRL \	FS
1029	%C	CTRL]	GS
1030	%D	CTRL 6	RS
1031	%E	CTRL -	US
1032	Space	Space	Space
1033	/A	!	!
1034	/B	"	"
1035	/C	#	#
1036	/D	\$	\$
1037	/E	%	%
1038	/F	&	&
1039	/G	'	'
1040	/H	((
1041	/I))
1042	/J	*	*
1043	/K	+	+
1044	/L	,	,
1045	-	-	-
1046	.	.	.
1047	/o	/	/
1048	0	0	0
1049	1	1	1
1050	2	2	2
1051	3	3	3
1052	4	4	4
1053	5	5	5
1054	6	6	6
1055	7	7	7
1056	8	8	8

ASCII Character Sets

ASCII Value (Prefix/ Suffix Value)	Full ASCII Code 39 Encode Char	Keystroke	ASCII Character (Applies to RS-232 Only)
1057	9	9	9
1058	/Z	:	:
1059	%F	;	;
1060	%G	<	<
1061	%H	=	=
1062	%I	>	>
1063	%J	?	?
1064	%V	@	@
1065	A	A	A
1066	B	B	B
1067	C	C	C
1068	D	D	D
1069	E	E	E
1070	F	F	F
1071	G	G	G
1072	H	H	H
1073	I	I	I
1074	J	J	J
1075	K	K	K
1076	L	L	L
1077	M	M	M
1078	N	N	N
1079	O	O	O
1080	P	P	P
1081	Q	Q	Q
1082	R	R	R
1083	S	S	S
1084	T	T	T
1085	U	U	U
1086	V	V	V
1087	W	W	W
1088	X	X	X
1089	Y	Y	Y
1090	Z	Z	Z
1091	%K	[[

ASCII Character Sets

ASCII Value (Prefix/ Suffix Value)	Full ASCII Code 39 Encode Char	Keystroke	ASCII Character (Applies to RS-232 Only)
1092	%L	\	\
1093	%M]]
1094	%N	^	^
1095	%O	_	_
1096	%W	`	`
1097	+A	a	a
1098	+B	b	b
1099	+C	c	c
1100	+D	d	d
1101	+E	e	e
1102	+F	f	f
1103	+G	g	g
1104	+H	h	h
1105	+I	i	i
1106	+J	j	j
1107	+K	k	k
1108	+L	l	l
1109	+M	m	m
1110	+N	n	n
1111	+O	o	o
1112	+P	p	p
1113	+Q	q	q
1114	+R	r	r
1115	+S	s	s
1116	+T	t	t
1117	+U	u	u
1118	+V	v	v
1119	+W	w	w
1120	+X	x	x
1121	+Y	y	y
1122	+Z	z	z
1123	%P	{	{
1124	%Q		
1125	%R	}	}
1126	%S	~	~

ASCII Character Sets

ASCII Value (Prefix/ Suffix Value)	Full ASCII Code 39 Encode Char	Keystroke	ASCII Character (Applies to RS-232 Only)
1127			Undefined
7013			ENTER

- ^a The keystroke in bold transmits only if you enabled Function Key Mapping. Otherwise, the unbold keystroke transmits.
- ^b The keystroke in bold transmits only if you enabled Function Key Mapping. Otherwise, the unbold keystroke transmits.
- ^c The keystroke in bold transmits only if you enabled Function Key Mapping. Otherwise, the unbold keystroke transmits.

Table 34 ALT Key Character Set

ALT Keys	Keystroke
2045	ALT -
2050	ALT 2
2054	ALT 6
2064	ALT @
2065	ALT A
2066	ALT B
2067	ALT C
2068	ALT D
2069	ALT E
2070	ALT F
2071	ALT G
2072	ALT H
2073	ALT I
2074	ALT J
2075	ALT K
2076	ALT L
2077	ALT M
2078	ALT N
2079	ALT O
2080	ALT P
2081	ALT Q
2082	ALT R
2083	ALT S
2084	ALT T
2085	ALT U

Table 34 ALT Key Character Set (Continued)

ALT Keys	Keystroke
2086	ALT V
2087	ALT W
2088	ALT X
2089	ALT Y
2090	ALT Z
2091	ALT [
2092	ALT \
2093	ALT]



NOTE: GUI Shift Keys - The Apple™ iMac keyboard has an apple key on either side of the space bar. Windows-based systems have a GUI key to the left of the left ALT key, and to the right of the right ALT key.

Table 35 GUI Key Character Set

GUI Key	Keystroke
3000	Right Control Key
3048	GUI 0
3049	GUI 1
3050	GUI 2
3051	GUI 3
3052	GUI 4
3053	GUI 5
3054	GUI 6
3055	GUI 7
3056	GUI 8
3057	GUI 9
3065	GUI A
3066	GUI B
3067	GUI C
3068	GUI D
3069	GUI E
3070	GUI F
3071	GUI G
3072	GUI H

Table 35 GUI Key Character Set (Continued)

GUI Key	Keystroke
3073	GUI I
3074	GUI J
3075	GUI K
3076	GUI L
3077	GUI M
3078	GUI N
3079	GUI O
3080	GUI P
3081	GUI Q
3082	GUI R
3083	GUI S
3084	GUI T
3085	GUI U
3086	GUI V
3087	GUI W
3088	GUI X
3089	GUI Y
3090	GUI Z

Table 36 PF Key Character Set

PF Keys	Keystroke
4001	PF 1
4002	PF 2
4003	PF 3
4004	PF 4
4005	PF 5
4006	PF 6
4007	PF 7
4008	PF 8
4009	PF 9
4010	PF 10
4011	PF 11
4012	PF 12

Table 36 PF Key Character Set (Continued)

PF Keys	Keystroke
4013	PF 13
4014	PF 14
4015	PF 15
4016	PF 16

Table 37 F Key Character Set

F Keys	Keystroke
5001	F 1
5002	F 2
5003	F 3
5004	F 4
5005	F 5
5006	F 6
5007	F 7
5008	F 8
5009	F 9
5010	F 10
5011	F 11
5012	F 12
5013	F 13
5014	F 14
5015	F 15
5016	F 16
5017	F 17
5018	F 18
5019	F 19
5020	F 20
5021	F 21
5022	F 22
5023	F 23
5024	F 24

Table 38 Numeric Key Character Set

Numeric Keypad	Keystroke
6042	*
6043	+
6044	Undefined
6045	-
6046	.
6047	/
6048	0
6049	1
6050	2
6051	3
6052	4
6053	5
6054	6
6055	7
6056	8
6057	9
6058	Enter
6059	Num Lock

Table 39 Extended Key Character SetExtended Keypad

Extended Keypad	Keystroke
7001	Break
7002	Delete
7003	Pg Up
7004	End
7005	Pg Dn
7006	Pause
7007	Scroll Lock
7008	Backspace
7009	Tab
7010	Print Screen
7011	Insert
7012	Home

Table 39 Extended Key Character SetExtended Keypad (Continued)

Extended Keypad	Keystroke
7013	Enter
7014	Escape
7015	Up Arrow
7016	Dn Arrow
7017	Left Arrow
7018	Right Arrow

Programming Reference

This section provides symbol and AIM code identifiers.

Symbol Code Identifiers

Table 40 Symbol Code Characters

Code Character	Code Type
A	UPC-A, UPC-E, UPC-E1, EAN-8, EAN-13
B	Code 39, Code 32
C	Codabar
D	Code 128, ISBT 128, ISBT 128 Concatenated
E	Code 93
F	Interleaved 2 of 5
G	Discrete 2 of 5, or Discrete 2 of 5 IATA
H	Code 11
J	MSI
K	GS1-128
L	Bookland EAN
M	Trioptic Code 39
N	Coupon Code
R	GS1 DataBar Family
S	Matrix 2 of 5
T	UCC Composite, TLC 39
U	Chinese 2 of 5
X	ISSN EAN, PDF417, Macro PDF417, Micro PDF417
z	Aztec, Aztec Rune
P00	Data Matrix
P01	QR Code, MicroQR

Table 40 Symbol Code Characters (Continued)

Code Character	Code Type
P02	Maxicode
P03	US Postnet
P04	US Planet
P05	Japan Postal
P06	UK Postal
P08	Netherlands KIX Code
P09	Australia Post
P0A	USPS 4CB/One Code/Intelligent Mail
P0B	UPU FICS Postal
P0C	Mailmark
P0D	Grid Matrix
P0G	GS1 Data Matrix
P0H	Han Xin
P0Q	GS1 QR
P0X	Signature Capture

AIM Code Identifiers

Each AIM Code Identifier contains the three-character string]cm where:

] = Flag Character (ASCII 93)

c = Code Character (see table below)

m = Modifier Character (see table below)

Table 41 AIM Code Characters

Code Character	Code Type
A	Code 39, Code 39 Full ASCII, Code 32
C	Code 128, ISBT 128, ISBT 128 Concatenated, GS1-128, Coupon (Code 128 portion)
d	Data Matrix, GS1 Data Matrix
E	UPC/EAN, Coupon (UPC portion)
e	GS1 DataBar Family

Table 41 AIM Code Characters (Continued)

Code Character	Code Type
F	Codabar
G	Code 93
g	Grid Matrix
H	Code 11
h	Han Xin
I	Interleaved 2 of 5
L	PDF417, Macro PDF417, Micro PDF417
L2	TLC 39
M	MSI
Q	QR Code, MicroQR, GS1 QR
S	Discrete 2 of 5, IATA 2 of 5
U	Maxicode
z	Aztec, Aztec Rune
X	Bookland EAN, ISSN EAN, Trioptic Code 39, Chinese 2 of 5, Matrix 2 of 5, Korean 3 of 5, US Postnet, US Planet, UK Postal, Japan Postal, Australia Post, Netherlands KIX Code, USPS 4CB/One Code/ Intelligent Mail, UPU FICS Postal, Mailmark, Signature Capture

The modifier character is the sum of the applicable option values based on the following table.

Table 42 Modifier Characters

Code Type	Option Value	Option
Code 39	0	No check character or Full ASCII processing.
	1	Reader has checked one check character.
	3	Reader has checked and stripped check character.
	4	Reader has performed Full ASCII character conversion.
	5	Reader has performed Full ASCII character conversion and checked one check character.
	7	Reader has performed Full ASCII character conversion and checked and stripped check character.
	Example: A Full ASCII barcode with check character W, A+I+MI+DW, is transmitted as JA7AIMID where 7 = (3+4).	
Trioptic Code 39	0	No option specified at this time. Always transmit 0.
	Example: A Trioptic barcode 412356 is transmitted as JX0412356	
Code 128	0	Standard data packet, no Function code 1 in first symbol position.
	1	Function code 1 in first symbol character position.
	2	Function code 1 in second symbol character position.

Table 42 Modifier Characters (Continued)

Code Type	Option Value	Option
		Example: A Code (EAN) 128 barcode with Function 1 character FNC1 in the first position, AIMID is transmitted as]C1AIMID
I 2 of 5	0	No check digit processing.
	1	Reader has validated check digit.
	3	Reader has validated and stripped check digit.
		Example: An I 2 of 5 barcode without check digit, 4123, is transmitted as]I04123
Codabar	0	No check digit processing.
	1	Reader has checked check digit.
	3	Reader has stripped check digit before transmission.
		Example: A Codabar barcode without check digit, 4123, is transmitted as]F04123
Code 93	0	No options specified at this time. Always transmit 0.
		Example: A Code 93 barcode 012345678905 is transmitted as]G0012345678905
MSI	0	Check digits are sent.
	1	No check digit is sent.
		Example: An MSI barcode 4123, with a single check digit checked, is transmitted as]M14123
D 2 of 5	0	No options specified at this time. Always transmit 0.
		Example: A D 2 of 5 barcode 4123, is transmitted as]S04123
UPC/EAN	0	Standard data packet in full EAN format, i.e., 13 digits for UPC-A, UPC-E, and EAN-13 (not including supplemental data).
	1	Two digit supplemental data only.
	2	Five digit supplemental data only.
	3	Combined data packet comprising 13 digits from EAN-13, UPC-A or UPC-E symbol and 2 or 5 digits from supplemental symbol.
	4	EAN-8 data packet.
		Example: A UPC-A barcode 012345678905 is transmitted as]E0012345678905
Bookland EAN	0	No options specified at this time. Always transmit 0.
		Example: A Bookland EAN barcode 123456789X is transmitted as]X0123456789X
ISSN EAN	0	No options specified at this time. Always transmit 0.
		Example: An ISSN EAN barcode 123456789X is transmitted as]X0123456789X
Code 11	0	Single check digit
	1	Two check digits
	3	Check characters validated but not transmitted.

Table 42 Modifier Characters (Continued)

Code Type	Option Value	Option
GS1 DataBar Family		No option specified at this time. Always transmit 0. GS1 DataBar Omnidirectional and GS1 DataBar Limited transmit with an Application Identifier "01". Note: In GS1-128 emulation mode, GS1 DataBar is transmitted using Code 128 rules (i.e.,]C1).
		Example: A GS1 DataBar Omnidirectional barcode 0110012345678902 is transmitted as je00110012345678902.
EAN.UCC Composites (GS1 DataBar, GS1-128, 2D portion of UPC composite)		Native mode transmission. Note: UPC portion of composite is transmitted using UPC rules.
	0	Standard data packet.
	1	Data packet containing the data following an encoded symbol separator character.
	2	Data packet containing the data following an escape mechanism character. The data packet does not support the ECI protocol.
	3	Data packet containing the data following an escape mechanism character. The data packet supports the ECI protocol.
		GS1-128 emulation Note: UPC portion of composite is transmitted using UPC rules.
	1	Data packet is a GS1-128 symbol (i.e., data is preceded with]JC1).
PDF417, Micro PDF417	0	Reader set to conform to protocol defined in 1994 PDF417 symbology specifications. Note: When this option is transmitted, the receiver cannot reliably determine whether ECIs have been invoked or whether data byte 92DEC has been doubled in transmission.
	1	Reader set to follow the ECI protocol (Extended Channel Interpretation). All data characters 92DEC are doubled.
	2	Reader set for Basic Channel operation (no escape character transmission protocol). Data characters 92DEC are not doubled. Note: When decoders are set to this mode, unbuffered Macro symbols and symbols requiring the decoder to convey ECI escape sequences cannot be transmitted.
	3	The barcode contains a GS1-128 symbol, and the first codeword is 903-907, 912, 914, 915.
	4	The barcode contains a GS1-128 symbol, and the first codeword is in the range 908-909.
	5	The barcode contains a GS1-128 symbol, and the first codeword is in the range 910-911.
		Example: A PDF417 barcode ABCD, with no transmission protocol enabled, is transmitted as]L2ABCD.
Data Matrix	0	ECC 000-140, not supported.
	1	ECC 200.
	2	ECC 200, FNC1 in first or fifth position.
	3	ECC 200, FNC1 in second or sixth position.
	4	ECC 200, ECI protocol implemented.

Table 42 Modifier Characters (Continued)

Code Type	Option Value	Option
	5	ECC 200, FNC1 in first or fifth position, ECI protocol implemented.
	6	ECC 200, FNC1 in second or sixth position, ECI protocol implemented.
GS1 Data Matrix	2	ECC 200, FNC1 in first or fifth position.
MaxiCode	0	Symbol in Mode 4 or 5.
	1	Symbol in Mode 2 or 3.
	2	Symbol in Mode 4 or 5, ECI protocol implemented.
	3	Symbol in Mode 2 or 3, ECI protocol implemented in secondary message.
QR Code	0	Model 1 symbol.
	1	Model 2 / MicroQR symbol, ECI protocol not implemented.
	2	Model 2 symbol, ECI protocol implemented.
	3	Model 2 symbol, ECI protocol not implemented, FNC1 implied in first position.
	4	Model 2 symbol, ECI protocol implemented, FNC1 implied in first position.
	5	Model 2 symbol, ECI protocol not implemented, FNC1 implied in second position.
	6	Model 2 symbol, ECI protocol implemented, FNC1 implied in second position.
GS1 QR	3	Model 2 symbol, ECI protocol not implemented, FNC1 implied in first position.
Aztec	0	Aztec symbol.
	C	Aztec Rune symbol.
Han Xin	0	Generic data, no special features are set. The transmitted data does not follow the AIM ECI protocol.
	1	ECI protocol enabled. There is at least one ECI mode encoded. Transmitted data must follow the AIM ECI protocol.
Mailmark	0	No option specified at this time. Always transmit 0.

Communication Protocol Functionality

This section provides information about functionality supported via communication (cable) interface. [The following table](#) lists supported scanner functionality by communication protocol.

Table 43 Communication Interface Functionality

Communication Interfaces	Functionality		
	Data Transmission	Remote Management	Image and Video Transmission
USB			
HID Keyboard Emulation	Supported	Not Available	Not Available
CDC COM Port Emulation	Supported	Not Available	Not Available
SSI over CDC COM Port Emulation	Supported	Supported	Supported
IBM Table-top USB	Supported	Supported	Not Available
IBM Hand-held USB	Supported	Supported	Not Available
USB OPOS Hand-held	Supported	Supported	Not Available
Symbol Native API (SNAPI) without Imaging Interface	Supported	Supported	Not Available
Symbol Native API (SNAPI) with Imaging Interface	Supported	Supported	Supported
RS-232			
Standard RS-232	Supported	Not Available	Not Available
ICL RS-232	Supported	Not Available	Not Available
Fujitsu RS-232	Supported	Not Available	Not Available
Wincor-Nixdorf RS-232 Mode A	Supported	Not Available	Not Available
Wincor-Nixdorf RS-232 Mode B	Supported	Not Available	Not Available
Olivetti ORS4500	Supported	Not Available	Not Available
Omron	Supported	Not Available	Not Available
CUTE	Supported	Not Available	Not Available
OPOS/JPOS	Supported	Not Available	Not Available
SSI	Supported	Supported	Supported

Table 43 Communication Interface Functionality (Continued)

Communication Interfaces	Functionality		
	Data Transmission	Remote Management	Image and Video Transmission
IBM 4690			
Hand-held Scanner Emulation (Port 9B)	Supported	Not Available	Not Available
Table-top Scanner Emulation (Port 17)	Supported	Supported	Not Available
Non-IBM Scanner Emulation (Port 5B)	Supported	Supported	Not Available
Keyboard Wedge			
IBM PC/AT & IBM PC Compatibles	Supported	Not Available	Not Available
IBM AT Notebook	Supported	Not Available	Not Available

Standard Parameter Defaults

This section provides the standard parameter defaults.

Table 44 Parameter Defaults

Parameter	Parameter Number ^a	SSI Number ^b	Default
USB Host Parameters			
USB Device Type	N/A	N/A	USB HID Keyboard
Symbol Native API (SNAPI) Status Handshaking	N/A	N/A	Enable
USB Keystroke Delay	N/A	N/A	No Delay
USB Caps Lock Override	N/A	N/A	Disable
Barcodes with Unknown Characters	N/A	N/A	Send Barcodes with Unknown Characters
USB Convert Unknown to Code 39	N/A	N/A	Disable
USB Fast HID	N/A	N/A	Enable
USB Polling Interval	N/A	N/A	3 msec
Keypad Emulation	N/A	N/A	Enable
Quick Keypad Emulation	N/A	N/A	Enable
Keypad Emulation with Leading Zero	N/A	N/A	Enable
USB FN1 Substitution	N/A	N/A	Disable
Function Key Mapping	N/A	N/A	Disable
Simulated Caps Lock	N/A	N/A	Disable
Convert Case	N/A	N/A	None
USB Static CDC	N/A	N/A	Enable
CDC Beep on <BEL>	N/A	N/A	Enable
TGCS (IBM) USB Direct I/O Beep	1360	N/A	Honor
TGCS(IBM) Long Direct I/O	1147	N/A	Disable
TGCS (IBM) USB Beep Directive	N/A	N/A	Ignore

Standard Parameter Defaults

Table 44 Parameter Defaults (Continued)

Parameter	Parameter Number ^a	SSI Number ^b	Default
TGCS (IBM) USB Barcode Configuration Directive	N/A	N/A	Ignore
TGCS (IBM) USB Specification Version	N/A	N/A	Version 2.2
Product ID(PID) Type	1281	N/A	Host Type Unique
Product ID (PID) Value	1725	N/A	N/A
EC Level	1710	N/A	N/A
4690 Flash Update	1727	N/A	Enable
SSI Host Parameters			
Select SSI Host	N/A	N/A	N/A
Baud Rate	156	9Ch	9600
Parity	158	9Eh	None
Check Parity	151	97h	Disable
Stop Bits	157	9Dh	1
Software Handshaking	159	9Fh	ACK/NAK
Host RTS Line State	154	9Ah	Low
Decode Data Packet Format	238	EEh	Send Raw Decode Data
Host Serial Response Timeout	155	9Bh	2 Seconds
Host Character Timeout	239	EFh	200 msec
Multipacket Option	334	F0h 4Eh	Multipacket Option 1
Interpacket Delay	335	F0h 4Fh	0 msec
Event Reporting			
Decode Event	256	F0h 00h	Disable
Boot Up Event	258	F0h 02h	Disable
Parameter Event	259	F0h 03h	Disable
RS-232 Host Parameters			
RS-232 Host Types	N/A	N/A	Standard
Baud Rate	N/A	N/A	9600
Parity	N/A	N/A	None
Stop Bits	N/A	N/A	1 Stop Bit
Data Bits	N/A	N/A	8-bit
Check Receive Errors	N/A	N/A	Enable
Hardware Handshaking	N/A	N/A	None
Software Handshaking	N/A	N/A	None

Table 44 Parameter Defaults (Continued)

Parameter	Parameter Number ^a	SSI Number ^b	Default
Host Serial Response Timeout	N/A	N/A	2 Sec
RTS Line State	N/A	N/A	Low RTS
Beep on <BEL>	N/A	N/A	Disable
Intercharacter Delay	N/A	N/A	0 msec
Nixdorf Beep/LED Options	N/A	N/A	Normal Operation
Barcodes with Unknown Characters	N/A	N/A	Send Barcode With Unknown Characters
Datalogic Host Format	2253	F8 08 CD	Enable
Datalogic Supported Commands	2260	F8 08 D4	Disable
NCR Enable/Disable Alternate Beep Volume for Not on File Event	2384	N/A	Disable
NCR Not on File Beeper Volume	2383	N/A	Low Volume
NCR Use Prefix	1238	N/A	Enable
NCR Prefix	1282	N/A	1002 (STX)
NCR Suffix	N/A	N/A	1003 (ETX)
NCR Use Block Check Character	1239	N/A	Enable
NCR 2D Label-ID Mode	1948	N/A	NCR Mode
IBM 468X/469X Host Parameters			
Port Address	N/A	N/A	None
Convert Unknown to Code 39	N/A	N/A	Disable
RS-485 Beep Directive	N/A	N/A	Ignore
RS-485 Barcode Configuration Directive	N/A	N/A	Ignore
IBM-485 Specification Version	N/A	N/A	Original Specification
Keyboard Wedge Host Parameters			
Keyboard Wedge Host Type	N/A	N/A	IBM AT Notebook
Barcodes with Unknown Characters	N/A	N/A	Send Barcodes with Unknown Characters
Keystroke Delay	N/A	N/A	No Delay
Intra-keystroke Delay	N/A	N/A	Disable
Alternate Numeric Keypad Emulation	N/A	N/A	Enable
Quick Keypad Emulation	N/A	N/A	Enable
Simulated Caps Lock	N/A	N/A	Disable
Caps Lock Override	N/A	N/A	Disable

Standard Parameter Defaults

Table 44 Parameter Defaults (Continued)

Parameter	Parameter Number ^a	SSI Number ^b	Default
Convert Case	N/A	N/A	Do Not Convert
Function Key Mapping	N/A	N/A	Disable
FN1 Substitution	N/A	N/A	Disable
Send Make and Break	N/A	N/A	Send
User Preferences			
Set Default Parameter	N/A	N/A	N/A
Parameter Barcode Scanning	236	ECh	Enable
Beep After Good Decode	56	38h	Enable
Beeper Volume	140	8Ch	High
Scan Tone	145	91h	Medium
Beeper Duration	628	F1h 74h	Medium
Suppress Power Up Beeps	721	F1h D1h	Do Not Suppress
LED on Good Decode	744	F1h E8h	Enable
Timeout Between Decodes, Same Symbol	137	89h	0.5 Seconds
Extend Timeout Between Decodes	2367	F8h 09h 3Fh	0.3 Seconds
Timeout Between Decodes, Different Symbols	144	90h	0.1 Seconds
Mobile Phone/Display Mode	716	F1h CCh	Standard
Motion Detect Mode (Wakeup)	2377	F8 09 49	Object Detect
Rescan Beep	2382	F8 09 4E	Disable
Non-Decode Event	2075	F8 08 1B	Disable
Non-Decode Event Threshold	2076	F8 08 1C	70
PDF Prioritization	719	F4h F1h CFh	Disable
PDF Prioritization Timeout	720	F1h D0h	200 ms
Presentation Mode Field of View	F1h 61h	Full	
Miscellaneous Options			
Enter Key	N/A	N/A	N/A
Tab Key	N/A	N/A	N/A
Transmit Code ID Character	45	2Dh	None
Prefix Value	99, 105	63h, 69h	7013 <CR><LF>
Suffix 1 Value Suffix 2 Value	98, 104 100, 106	62h, 68h 64h, 6Ah	7013 <CR><LF>
Scan Data Transmission Format	235	EBh	Data As Is

Table 44 Parameter Defaults (Continued)

Parameter	Parameter Number ^a	SSI Number ^b	Default
FN1 Substitution Values	103, 109	67h, 6Dh	7013 <CR><LF>
Unsolicited Heartbeat Interval	1118	F8h 04h 5Eh	Disable
Dump Scanner Parameters	N/A	N/A	N/A
securPharm Decoding	1752	F8h 06h D8h	Disable
securPharm Output Formatting	1753	F8h 06h D9h	No Formatting
Send Versions			
Firmware Version	N/A	N/A	N/A
Scankit Version	N/A	N/A	N/A
Serial Number	N/A	N/A	N/A
Date of Manufacture	N/A	N/A	N/A
Image Capture Preferences			
Snapshot Mode	N/A	N/A	N/A
Image Capture Illumination	361	F0h 69h	Enable
Image Capture Autoexposure	360	F0h 68h	Enable
Fixed Exposure	567	F4h F1h 37h	100
Snapshot Mode Timeout	323	F0h 43h	0 (30 seconds)
Silence Operational Mode Changes	1293	F8h 05h 0Dh	Disable
Image Cropping	301	F0h 2Dh	Disable
Crop to Pixel Addresses	315 316 317 318	F4h F0h 3Bh F4h F0h 3Ch F4h F0h 3Dh F4h F0h 3Eh	0 top 0 left 1199 bottom 1919 right
Image Size (Number of Pixels)	302	F0h 2Eh	Full
Image Brightness (Target White)	390	F0h 86h	180
JPEG Image Options	299	F0h 2Bh	Quality
JPEG Quality Value	305	F0h 31h	65
JPEG Size Value	561	F1h 31h	160 kB
Image Enhancement	564	F1h 34h	Low (1)
Image File Format Selection	304	F0h 30h	JPEG
Image Rotation	665	F1h 99h	0
Bits per Pixel (BPP)	303	F0h 2Fh	8 BPP
Digital Gain	1233	F4h D1h	16
Camera Button	1716	F8h 06h B4h	Disable
Camera Button Delay	1717	F8h 06h B5h	20 seconds

Standard Parameter Defaults

Table 44 Parameter Defaults (Continued)

Parameter	Parameter Number ^a	SSI Number ^b	Default
Color Camera Mode	2385	F8 09 51	0
Symbologies			
Enable/Disable All Code Types			
1D Symbologies			
UPC/EAN/JAN			
UPC-A	1	01h	Enable
UPC-E	2	02h	Enable
UPC-E1	12	0Ch	Disable
EAN-8/JAN 8	4	04h	Enable
EAN-13/JAN 13	3	03h	Enable
Bookland EAN	83	53h	Disable
Bookland ISBN Format	576	F1h 40h	ISBN-10
ISSN EAN	617	F1h 69h	Disable
Decode UPC/EAN/JAN Supplementals (2 and 5 digits)	16	10h	Ignore
User-Programmable Supplementals Supplemental 1: Supplemental 2:	579580	F4h F1h 43hF4h F1h 44h	000
UPC/EAN/JAN Supplemental Redundancy	80	50h	10
Decode UPC/EAN/JAN Supplemental AIM ID	672	F1h A0h	Combined
Transmit UPC-A Check Digit	40	28h	Enable
Transmit UPC-E Check Digit	41	29h	Enable
Transmit UPC-E1 Check Digit	42	2Ah	Enable
UPC-A Preamble	34	22h	System Character
UPC-E Preamble	35	23h	System Character
UPC-E1 Preamble	36	24h	System Character
Convert UPC-E to UPC-A	37	25h	Disable
Convert UPC-E1 to UPC-A	38	26h	Disable
EAN/JAN Zero Extend	39	27h	Disable
UCC Coupon Extended Code	85	55h	Disable
Coupon Report	730	F1h DAh	New Coupon Format
UPC Reduced Quiet Zone	1289	F8h 05h 09h	Disable
Digimarc Digital Watermark	1687	F8h 06h 97h	Disable

Table 44 Parameter Defaults (Continued)

Parameter	Parameter Number ^a	SSI Number ^b	Default
Linear UPC/EAN	68	44h	Disable
Code 128			
Code 128	8	08h	Enable
Set Length(s) for Code 128	209, 210	D1h, D2h	0 to 80
GS1-128 (formerly UCC/EAN-128)	14	0Eh	Enable
ISBT 128	84	54h	Enable
ISBT Concatenation	577	F1h 41h	Disable
Check ISBT Table	578	F1h 42h	Enable
ISBT Concatenation Redundancy	223	DFh	10
Ignore Code 128 <FNC4>	1254	F8h 04h E6h	Honor
Code 128 Security Level	751	F1h EFh	Security Level 1
Code 128 Reduced Quiet Zone	1208	F8h 04h B8h	Disable
Code 39			
Code 39	0	00h	Enable
Trioptic Code 39	13	0Dh	Disable
Convert Code 39 to Code 32 (Italian Pharmacy Code)	86	56h	Disable
Code 32 Prefix	231	E7h	Disable
Set Length(s) for Code 39	18, 19	12h, 13h	1 to 55
Code 39 Check Digit Verification	48	30h	Disable
Transmit Code 39 Check Digit	43	2Bh	Disable
Code 39 Full ASCII Conversion	17	11h	Disable
Code 39 Security Level	750	F1h EEh	Security Level 1
Code 39 Reduced Quiet Zone	1209	F8h 04h B9h	Disable
Code 93			
Code 93	9	09h	Enable
Set Length(s) for Code 93	26, 27	1Ah, 1Bh	1 to 55
Code 11			
Code 11	10	0Ah	Disable
Set Lengths for Code 11	28, 29	1Ch, 1Dh	4 to 55
Code 11 Check Digit Verification	52	34h	Disable
Transmit Code 11 Check Digit(s)	47	2Fh	Disable
Interleaved 2 of 5 (ITF)			

Standard Parameter Defaults

Table 44 Parameter Defaults (Continued)

Parameter	Parameter Number ^a	SSI Number ^b	Default
Interleaved 2 of 5 (ITF)	6	06h	Enable
Set Lengths for I 2 of 5	22, 23	16h, 17h	6 to 55
I 2 of 5 Check Digit Verification	49	31h	Disable
Transmit I 2 of 5 Check Digit	44	2Ch	Disable
Convert I 2 of 5 to EAN 13	82	52h	Disable
Febraban	1750	F8h 06h D6h	Disable
I 2 of 5 Security Level	1121	F8h 04h 61h	Security Level 1
I 2 of 5 Reduced Quiet Zone	1210	F8h 04h BAh	Disable
Discrete 2 of 5 (DTF)			
Discrete 2 of 5	5	05h	Disable
Set Length(s) for D 2 of 5	20, 21	14h 15h	1 to 55
Codabar (NW - 7)			
Codabar	7	07h	Enable
Set Lengths for Codabar	24, 25	18h, 19h	4 to 55
CLSI Editing	54	36h	Disable
NOTIS Editing	55	37h	Disable
Codabar Security Level	1776	F8h 06h F0h	Security Level 1
Codabar Upper or Lower Case Start/ Stop Characters Detection	855	F2h 57h	Upper Case
Codabar Mod 16 Check Digit Verification	1784	F8h 06h F8h	Disable
Transmit Codabar Check Digit	704	F1h C0h	Disable
MSI			
MSI	11	0Bh	Disable
Set Length(s) for MSI	30, 31	1Eh, 1Fh	4 to 55
MSI Check Digits	50	32h	One
Transmit MSI Check Digit	46	2Eh	Disable
MSI Check Digit Algorithm	51	33h	Mod 10/Mod 10
MSI Reduced Quiet Zone	1392	F8h 05h 70h	Disable
MSI Security Level	2122	F8 08 4A	Security Level 1
Chinese 2 of 5			
Chinese 2 of 5	408	F0h 98h	Disable
Matrix 2 of 5			
Matrix 2 of 5	618	F1h 6Ah	Disable

Table 44 Parameter Defaults (Continued)

Parameter	Parameter Number ^a	SSI Number ^b	Default
Matrix 2 of 5 Lengths	619 620	F1h 6Bh F1h 6Ch	4 to 55
Matrix 2 of 5 Check Digit	622	F1h 6Eh	Disable
Transmit Matrix 2 of 5 Check Digit	623	F1h 6Fh	Disable
Inverse 1D	586	F1h 4Ah	Regular
GS1 DataBar			
GS1 DataBar Omnidirectional	338	F0h 52h	Enable
GS1 DataBar Limited	339	F0h 53h	Enable
GS1 DataBar Expanded	340	F0h 54h	Enable
Convert GS1 DataBar to UPC/EAN/JAN	397	F0h 8Dh	Disable
GS1 DataBar Security Level	1706	F8h 06h AAh	Level 1
GS1 DataBar Limited Margin Check	728	F1h D8h	Level 3
Symbology-Specific Security Features			
Redundancy Level	78	4Eh	1
Security Level	77	4Dh	1
1D Quiet Zone Level	1288	F8h 05h 08h	1
Intercharacter Gap Size	381	F0h 7Dh	Normal
Composite Codes			
Composite CC-C	341	F0h 55h	Disable
Composite CC-A/B	342	F0h 56h	Disable
Composite TLC-39	371	F0h 73h	Disable
Composite Inverse	1113	F8h 04h 59h	Regular
UPC Composite Mode	344	F0h 58h	UPC Never Linked
Composite Beep Mode	398	F0h 8Eh	Beep As Each Code Type is Decoded
GS1-128 Emulation Mode for UCC/EAN Composite Codes	427	F0h ABh	Disable
2D Symbologies			
PDF417	15	0Fh	Enable
MicroPDF417	227	E3h	Disable
Code 128 Emulation	123	7Bh	Disable
Data Matrix	292	F0h 24h	Enable
GS1 Data Matrix	1336	F8h 05h 38h	Disable
Data Matrix Inverse	588	F1h 4Ch	Inverse Autodetect

Standard Parameter Defaults

Table 44 Parameter Defaults (Continued)

Parameter	Parameter Number ^a	SSI Number ^b	Default
Decode Data Matrix Mirror Images	537	F1h 19h	Auto
Maxicode	294	F0h 26h	Disable
QR Code	293	F0h 25h	Enable
GS1 QR	1343	F8h 05h 3Fh	Disable
MicroQR	573	F1h 3Dh	Enable
Linked QR Mode	1847	737h	Linked QR Only
Aztec	574	F1h 3Eh	Enable
Aztec Inverse	589	F1h 4Dh	Inverse Autodetect
Han Xin	1167	F8h 04h 8Fh	Disable
Han Xin Inverse	1168	F8h 04h 90h	Regular
Grid Matrix	1718	F8h 06h B6h	Disable
Grid Matrix Inverse	1719	F8h 06h B7h	Regular
Grid Matrix Mirrored	1736	F8h 06h C8h	Non-Mirrored
DotCode	1906	F8 07 72h	Disable
DotCode Prioritize	1937	F8 07 91h	Enable
DotCode Inverse	1907	F8 07 73h	Autodetect
DotCode Mirrored	1908	F8 07 74h	Autodetect
Macro PDF			
Flush Macro PDF Buffer	N/A	N/A	N/A
Abort Macro PDF Entry	N/A	N/A	N/A
Postal Codes			
US Postnet	89	59h	Disable
US Planet	90	5Ah	Disable
Transmit US Postal Check Digit	95	5Fh	Enable
UK Postal	91	5Bh	Disable
Transmit UK Postal Check Digit	96	60h	Enable
Japan Postal	290	F0h 22h	Disable
Australia Post	291	F0h 23h	Disable
Australia Post Format	718	F1h CEh	Autodiscriminate
Netherlands KIX Code	326	F0h 46h	Disable
USPS 4CB/One Code/Intelligent Mail	592	F1h 50h	Disable
UPU FICS Postal	611	F1h 63h	Disable
Mailmark	1337	F8h 05h 39h	Disable

Standard Parameter Defaults

Table 44 Parameter Defaults (Continued)

Parameter	Parameter Number ^a	SSI Number ^b	Default
Posti LAPA 4-State Code	2031	F8 07EF	Disable
DL Parsing Parameters			
Driver's License Parsing	645	F1 85	No Driver's License Parsing
Parsing Driver's License Data Fields	N/A	N/A	N/A
Driver's License Parse Field Barcodes	N/A	N/A	N/A
AAMVA Parse Field Barcodes	N/A	N/A	N/A
Output Gender as M or F	N/A	N/A	N/A
Date Format	N/A	N/A	CCYYMMDD
No Separator	N/A	N/A	N/A
Send Keystroke Control Characters Keyboard Characters	N/A	N/A	N/A
Parsing Rule Example	N/A	N/A	N/A
Embedded Driver's License Parsing ADF Example	N/A	N/A	N/A
EAS Parameters			
Operating Modes	977	N/A	Disable
Sensormatic Deactivation Timeout	982	N/A	10 seconds
Sensormatic EAS Deactivation	979	N/A	Enable
Sensormatic Soft Tag Beeps	984	N/A	Soft Tag Beep 1
Sensormatic Hard Tag Beeps	985	N/A	Hard Tag Beep 1
Sensormatic Detected Any Time Beep	980	N/A	Enable
Sensormatic Request Communication Message	978	N/A	Enable
Checkpoint Interlock Polarity	983	N/A	Active Low
USB and Keyboard Wedge Country Keyboard Types (Country Codes)			
USB and Keyboard Wedge Country Keyboard Types (Country Codes)	N/A	N/A	US English (North American)
CJK Control Parameters			
Unicode Output Control	973	N/A	Universal Output
CJK Output Method to Windows Host	972	N/A	Universal CJK Output
Non-CJK UTF Barcode Output	960	N/A	N/A

^a Parameter number decimal values are used for programming via RSM commands.

^b SSI number hex values are used for programming via SSI commands.

Country Codes

This chapter provides instructions for programming the keyboard to interface with a USB or keyboard wedge host.

The host powers the scanner. For host setup information, see [USB Interface](#) and [Keyboard Wedge Interface](#).

To select a code page for the country keyboard type, see [Country Code Barcodes](#).

Throughout the programming barcode menus, default values are indicated with asterisks (*).

USB and Keyboard Wedge Country Keyboard Types (Country Codes)

Scan the barcode corresponding to the keyboard type. For a USB host, this setting applies only to the USB Keyboard (HID) device. If the keyboard type is not listed, see [Keypad Emulation](#) for the USB HID host. For a keyboard wedge host, see [Alternate Numeric Keypad Emulation](#).



NOTE: When changing USB country keyboard types the scanner automatically resets and issues the standard startup beep sequences.

For best results when using international keyboards, enable [USB Keyboard Emulation](#).



IMPORTANT: Some country keyboard barcode types are specific to certain Windows operating systems (i.e., XP and Windows 7 or higher). Barcodes requiring a specific Windows OS are noted in the barcode captions.

Use the French International barcode for Belgian French keyboards.

Country Code Barcodes



*US English (North American)



US English (Mac)



Albanian

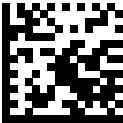

Arabic (101)



Arabic (102)



Arabic (102) AZERTY



Azeri (Latin)

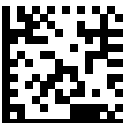

Azeri (Cyrillic)



Belarusian



Bosnian (Latin)

Country Codes



Bosnian (Cyrillic)



Bulgarian (Latin)



Bulgarian Cyrillic (Typewriter) (Bulgarian -Windows XP Typewriter - Windows 7 or higher)

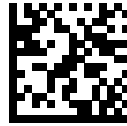

Canadian French Win7



Canadian French (Legacy)



Canadian Multilingual Standard



Chinese (ASCII)

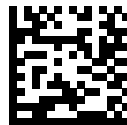

Chinese (Simplified)*



Chinese (Traditional)*

*For CJK keyboard types, see [CJK Decode Control](#).



Croatian



Czech

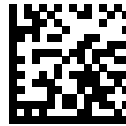

Czech (Programmer)



Czech (QWERTY)

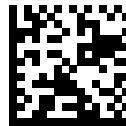

Danish



Dutch (Netherlands)



Estonian

Country Codes



Faeroese

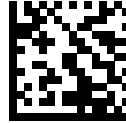

Finnish

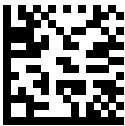

French (France)



French International (Belgian French)



French (Canada) 95/98



French (Canada) 2000/XP*

*Note that there is also a country code barcode for Canadian Multilingual Standard. Be sure to select the appropriate barcode for your host system.

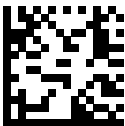

Galician



German



Greek Latin



Greek (220) Latin



Greek (319) Latin



Greek



Greek (220)



Greek (319)



Greek Polytonic



Hebrew Israel

Country Codes

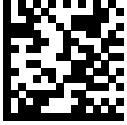

Hungarian



Hungarian_101KEY



Icelandic



Irish

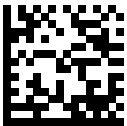

Italian



Italian (142)



Japanese (ASCII)



Japanese (SHIFT-JIS)*

*For CJK keyboard types, see [CJK Decode Control](#).



Kazakh



Korean (ASCII)



Korean (Hangul)*

*For CJK keyboard types, see [CJK Decode Control](#).



Kyrgyz



Latin American



Latvian



Latvian (QWERTY)



Lithuanian

Country Codes

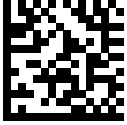

Lithuanian (IBM)

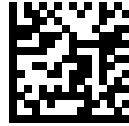

Macedonian (FYROM)



Maltese_47KEY

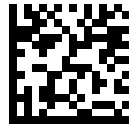

Mongolian



Norwegian



Polish (214)



Polish (Programmer)



Portuguese (Brazil) (Windows XP)



Portuguese (Brazilian ABNT)



Portuguese (Brazilian ABNT2)



Portuguese (Portugal)

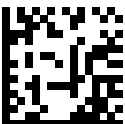

Romanian (Windows XP)



Romanian (Legacy) (Windows 7 or higher)



Romanian (Standard) (Windows 7 or higher)



Romanian (Programmer) (Windows 7 or higher)



Russian

Country Codes



Russian (Typewriter)

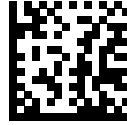

Serbian (Latin)



Serbian (Cyrillic)



Slovak



Slovak (QWERTY)

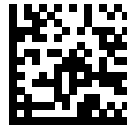

Slovenian

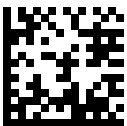

Spanish

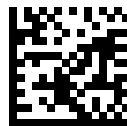

Spanish (Variation)

Country Codes



Swedish



Swiss French



Swiss German



Tatar



Thai (Kedmanee)



Turkish F



Turkish Q

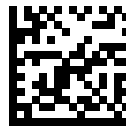

UK English

Country Codes



Ukrainian



US Dvorak



US Dvorak Left

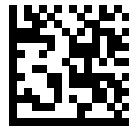

US Dvorak Right



US International



Uzbek



Vietnamese

Country Code Pages

This chapter provides barcodes for selecting code pages for the country keyboard type selected in Country Codes.

If the default code page in [Country Code Pages](#) is appropriate for your selected country keyboard type, you do not need to scan a country code page barcode.



NOTE: ADF rules can also specify a code page based on the symbology and other ADF criteria. Refer to the Advanced Data Formatting Programmer Guide.

Country Code Page Defaults

The table in this section lists the code page default for each country keyboard.

Table 45 Country Code Page Defaults

Country Keyboard	Code Page Default
US English (North American)	Windows 1252
US English (Mac)	Mac CP10000
Albanian	Windows 1250
Arabic 101	Windows 1256
Arabic 102	Windows 1256
Arabic 102 AZERTY	Windows 1256
Azeri Latin	Windows 1254
Azeri Cyrillic	Windows 1251
Belarusian	Windows 1251
Bosnian Latin	Windows 1250
Bosnian Cyrillic	Windows 1251
Bulgarian Latin	Windows 1250
Bulgarian Cyrillic	Windows 1251
Canadian French Win7	Windows 1252
Canadian French (Legacy)	Windows 1252
Canadian Multilingual	Windows 1252

Table 45 Country Code Page Defaults (Continued)

Country Keyboard	Code Page Default
Croatian	Windows 1250
Chinese ASCII	Windows 1252
Chinese (Simplified)	Windows 936, GBK
Chinese (Traditional)	Windows 950, Big5
Czech	Windows 1250
Czech Programmers	Windows 1250
Czech QWERTY	Windows 1250
Danish	Windows 1252
Dutch Netherland	Windows 1252
Estonian	Windows 1257
Faeroese	Windows 1252
Finnish	Windows 1252
French (France)	Windows 1252
French (Canada) 95/98	Windows 1252
French (Canada) 2000/XP	Windows 1252
French International (Belgian French)	Windows 1252
Galician	Windows 1252
German	Windows 1252
Greek Latin	Windows 1252
Greek220 Latin	Windows 1253
Greek319 Latin	Windows 1252
Greek	Windows 1253
Greek220	Windows 1253
Greek319	Windows 1253
Greek Polytonic	Windows 1253
Hebrew Israel	Windows 1255
Hungarian	Windows 1250
Hungarian_101KEY	Windows 1250
Icelandic	Windows 1252
Irish	Windows 1252
Italian	Windows 1252
Italian_142	Windows 1252
Japanese ASCII	Windows 1252

Table 45 Country Code Page Defaults (Continued)

Country Keyboard	Code Page Default
Japanese (Shift-JIS)	Windows 932, Shift-JIS
Kazakh	Windows 1251
Korean ASCII	Windows 1252
Korean (Hangul)	Windows 949, Hangul
Kyrgyz Cyrillic	Windows 1251
Latin America	Windows 1252
Latvian	Windows 1257
Latvian QWERTY	Windows 1257
Lithuanian	Windows 1257
Lithuanian_IBM	Windows 1257
Macedonian -FYROM	Windows 1251
Maltese_47KEY	Windows 1252
Mongolian-Cyrillic	Windows 1251
Norwegian	Windows 1252
Polish_214	Windows 1250
Polish Programmer	Windows 1250
Portuguese Brazil	Windows 1252
Portuguese Brazilian ABNT	Windows 1252
Portuguese Brazilian ABNT2	Windows 1252
Portuguese Portugal	Windows 1252
Romanian	Windows 1250
Romanian Legacy	Windows 1250
Romanian Standard	Windows 1250
Romanian Programmer	Windows 1250
Russian	Windows 1251
Russian Typewriter	Windows 1251
Serbian Latin	Windows 1250
Serbian Cyrillic	Windows 1251
Slovak	Windows 1250
Slovak QWERTY	Windows 1250
Slovenian	Windows 1250
Spanish	Windows 1252
Spanish Variation	Windows 1252

Table 45 Country Code Page Defaults (Continued)

Country Keyboard	Code Page Default
Swedish	Windows 1252
Swiss French	Windows 1252
Swiss German	Windows 1252
Tatar	Windows 1251
Thai-Kedmanee	Windows 874
Turkish F	Windows 1254
Turkish Q	Windows 1254
Ukrainian	Windows 1251
United Kingdom	Windows 1252
United States	Windows 1252
US Dvorak	Windows 1252
US Dvorak Left Hand	Windows 1252
US Dvorak Right Hand	Windows 1252
US International	Windows 1252
Uzbek Cyrillic	Windows 1251
Vietnamese	Windows 1258

Country Code Page Barcodes

Parameter # 961

Scan the barcode corresponding to the country keyboard code page.



Windows 1250 Latin 2, Central European

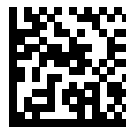

Windows 1251 Cyrillic, Slavic



Windows 1252 Latin 1, Western European



Windows 1253 Greek



Windows 1254 Latin 5, Turkish

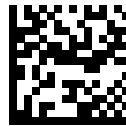

Windows 1255 Hebrew



Windows 1256 Arabic

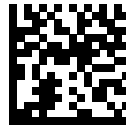

Windows 1257 Baltic



Windows 1258 Vietnamese



Windows 874 Thai



Windows 20866 Cyrillic KOI8-R



Windows 932 Japanese Shift-JIS



Windows 936 Simplified Chinese GBK



Windows 54936 Simplified Chinese GB18030



Windows 949 Korean Hangul

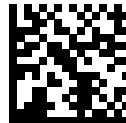

Windows 950 Traditional Chinese Big5



MS-DOS 437 Latin US



MS-DOS 737 Greek



MS-DOS 775 Baltic



MS-DOS 850 Latin 1



MS-DOS 852 Latin 2

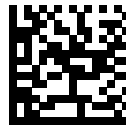

MS-DOS 855 Cyrillic



MS-DOS 857 Turkish



MS-DOS 860 Portuguese



MS-DOS 861 Icelandic

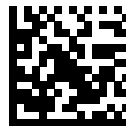

MS-DOS 862 Hebrew



MS-DOS 863 French Canada



MS-DOS 865 Nordic



MS-DOS 866 Cyrillic

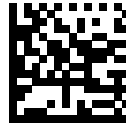

MS-DOS 869 Greek 2



ISO 8859-1 Latin 1, Western European



ISO 8859-2 Latin 2, Central European



ISO 8859-3 Latin 3, South European



ISO 8859-4 Latin 4, North European



ISO 8859-5 Cyrillic



ISO 8859-6 Arabic



ISO 8859-7 Greek

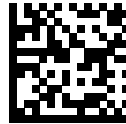

ISO 8859-8 Hebrew



ISO 8859-9 Latin 5, Turkish



ISO 8859-10 Latin 6, Nordic



ISO 8859-11 Thai



ISO 8859-13 Latin 7, Baltic



ISO 8859-14 Latin 8, Celtic

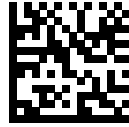

ISO 8859-15 Latin 9



ISO 8859-16 Latin 10, South-Eastern European

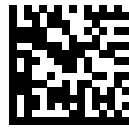

UTF-8



UTF-16LE UTF-16 Little Endian

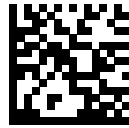

UTF-16BE UTF-16 Big Endian



Mac CP10000 Roman

CJK Decode Control

This appendix describes control parameters for CJK (Chinese, Japanese, Korean) barcode decode through USB HID Keyboard Emulation mode.



NOTE: Because ADF does not support CJK character processing, there is no format manipulation for CJK output.

CJK Control Parameters

Unicode Output Control

Parameter # 973

For a Unicode encoded CJK barcode, select one of the following options for Unicode output:

- Universal Output to Unicode and MBCS Application - This default method applies to Unicode and MBCS expected applications, such as MS Word and Notepad on a Windows host.



NOTE: To support Unicode universal output, set up the registry table for the Windows host. See [Unicode/CJK Decode Setup with Windows Host](#).

- Output to Unicode Application Only - This method applies only to Unicode expected applications, such as MS Word and WordPad, but not Notepad.



*Universal Output (0)



Unicode Application Only (1)

CJK Output Method to Windows Host

Parameter # 972

For a national standard encoded CJK barcode, select one of the following options for CJK output to a Windows host:

- **Universal CJK Output** - This is the default universal CJK output method for US English IME or Chinese/Japanese/Korean ASCII IME on a Windows host. This method converts CJK characters to Unicode and emulates the characters when transmitting to the host. Use the [Unicode Output Control](#) parameter to control Unicode output.



NOTE: To support universal CJK output, set up the registry table for the Windows host. See [Unicode/CJK Decode Setup Windows Host](#).

- **Other options for CJK output** - With the following methods, the scanner sends the CJK character hexadecimal internal code (Nei Ma) value to the host, or converts the CJK character to Unicode and sends the hexadecimal Unicode value to the host. When using these methods, the Windows host must select the corresponding IME to accept the CJK character. See [Unicode/CJK Decode Setup Windows Host](#).
- **Japanese Unicode Output**
- **Simplified Chinese GBK Code Output**
- **Simplified Chinese Unicode Output**
- **Korean Unicode Code Output**
- **Traditional Chinese Big5 Code Output** (Windows XP)
- **Traditional Chinese Big5 Code Output** (Windows 7)
- **Traditional Chinese Unicode Code Output** (Windows XP)
- **Traditional Chinese Unicode Code Output** (Windows 7)



NOTE: The Unicode emulate output method depends on the host system (Windows XP or Windows 7).



*Universal CJK Output (0)

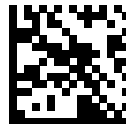

Japanese Unicode Output (34)



Chinese (Simplified) GBK Output (1)



Chinese (Simplified) Unicode Output (2)



Korean Unicode Output (50)

(for Korean Unicode Output, select Simplified Chinese Unicode IME on the Windows host)

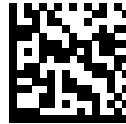

Chinese (Traditional) Big5 Output (Windows XP) (17)



Chinese (Traditional) Big5 Output (Windows 7) (19)



Chinese (Traditional) Unicode Output (Windows XP) (18)



Chinese (Traditional) Unicode Output (Windows 7) (20)

Non-CJK UTF Barcode Output

Parameter # 960

Some country keyboard type layouts contain characters that do not exist in the default code page (see below). Although the default code page can not encode these characters in a barcode, they can be encoded in the UTF-8 barcode. Scan the following barcode to output the Unicode values by emulation mode.



NOTE: Use this special country keyboard type to decode the non-CJK UTF-8 barcode. After decoding, re-configure the scanner to use the original country keyboard type.

Use US English IME on Windows. See [Unicode Output Control](#).



Non-CJK UTF-8 Emulation Output

Missing Characters for Country Keyboard Type: Tatar, Uzbek, Mongolian, Kyrgyz, Kazakh and Azeri

Default code page: CP1251

Missing characters:

#	#
#	#
#	#
#	#
#	#
#	#
#	#
#	#
#	#
#	#
ƒ	
#	#
#	#
#	#
#	#
#	#

Missing Characters for Country Keyboard Type: Romanian (Standard)

Default code page: CP1250

Missing characters:

ș	Ș
ț	Ț

Missing Characters for Country Keyboard Type: Portuguese-Brazilian (ABNT), Portuguese-Brazilian (ABNT2)

Default code page: CP1252

Missing character: #

Missing Characters for Country Keyboard Type: Azeri-Latin

Default code page: CP1254

Missing characters: ə, Ə

Unicode/CJK Decode Setup with Windows Host

This section describes how to set up CJK decode with a Windows host.

Setting Up the Windows Registry Table for Unicode Universal Output

To support the Unicode universal output method, set up the Windows host registry table as follows:

1. Select **Start > Run > regedt32** to start the registry editor.
2. Under **HKEY_Current_User\Control Panel\Input Method**, set **EnableHexNumpad** to **1** as follows:

```
[HKEY_CURRENT_USER\Control Panel\Input Method]
```

```
"EnableHexNumpad"="1"
```

If this key does not exist, add it as type **REG_SZ** (string value).

3. Reboot the computer to implement the registry change.

Adding CJK IME on Windows

To add the desired CJK input language:

1. Click **Start > Control Panel**.
2. If the Control Panel opens in category view, select **Switch to Classic View** in the top left corner.
3. Select **Regional and Language Options**.
4. Click the **Language** tab.
5. Under **Supplemental Language Support**, select the **Install Files for East Asian Languages** check box if not already selected, and click **Apply**. This may require a Windows installation CD to install the required files. This step ensures that the East Asian Languages (CJK) are available.
6. Under **Text Services and Input Language**, click **Details**.
7. Under **Installed Services**, click **Add**.
8. In the **Add Input Language** dialog box, choose the CJK input language and keyboard layout or Input Method Editor (IME) to add.
9. Click **OK** twice. The language indicator appears in the system tray (at bottom right corner of the desktop by default). To switch between input languages (keyboard languages) select the language indicator in the system tray.
10. Select the language indicator in the system tray to select the desired country keyboard type.
11. Verify that the characters displayed on each country's keyboard appear.

Selecting the Simplified Chinese Input Method on the Host

To select the Simplified Chinese input method:

- Select Unicode/GBK input on Windows XP: **Chinese (Simplified) - NeiMa**, then click the input bar to select **Unicode** or **GBK NeiMa** input.

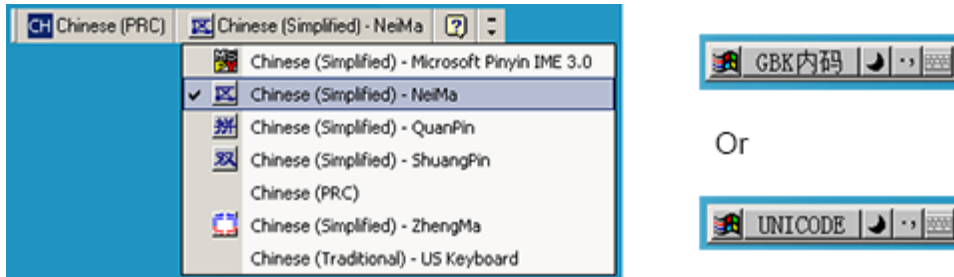

- Select Unicode/GBK input on Windows 7: **Chinese (Simplified) - Microsoft Pinyin New Experience Input Style**, then select **Tool Menu > Secondary Inputs > Unicode Input** or **GB Code Input**.

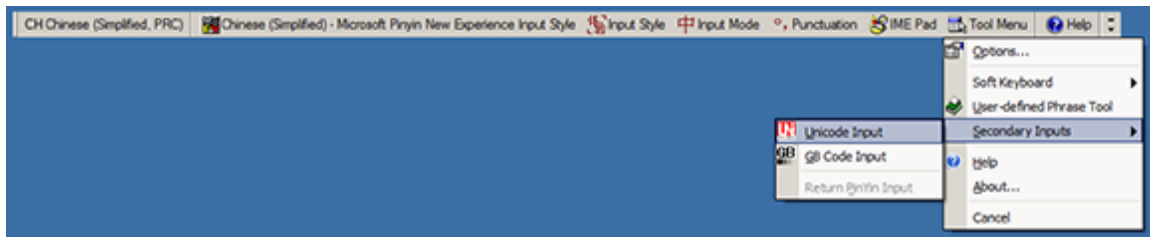

Selecting the Traditional Chinese Input Method on the Host

To select the Traditional Chinese input method:

- Select Unicode input on Windows XP: **Chinese (Traditional) - Unicode**

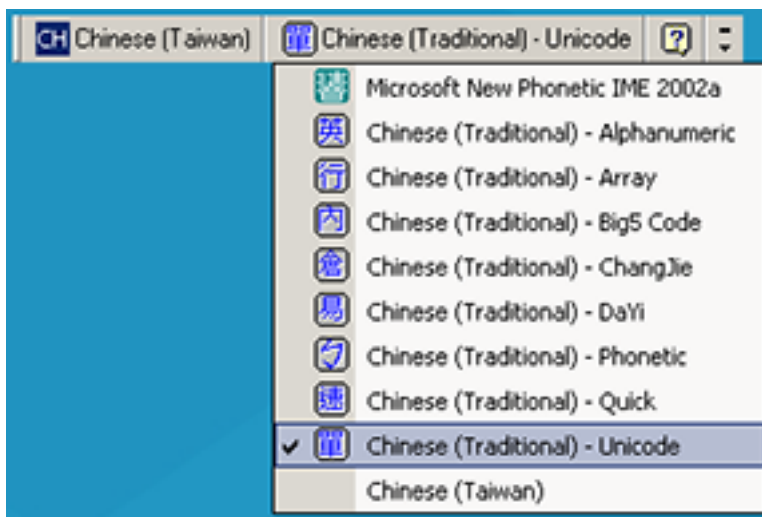

- Select Big5 input on Windows XP: **Chinese (Traditional) - Big5 Code**

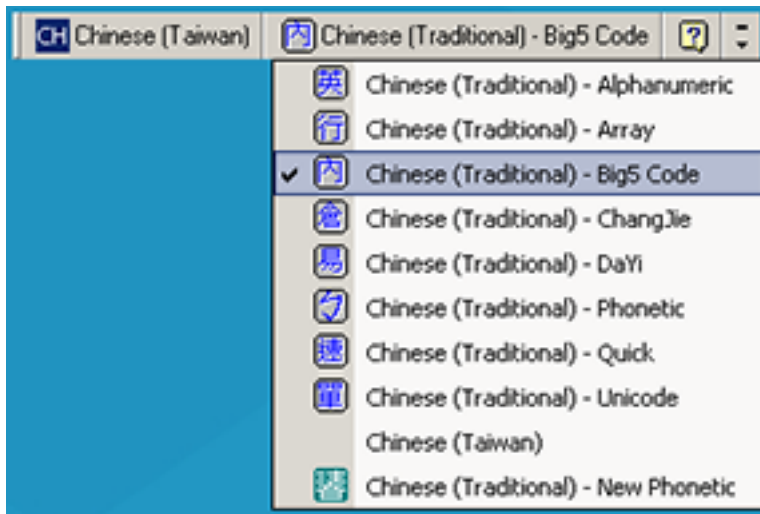

- Select Unicode/Big5 input on Windows 7: **Chinese (Traditional) - New Quick**. This option support both Unicode and Big5 input.

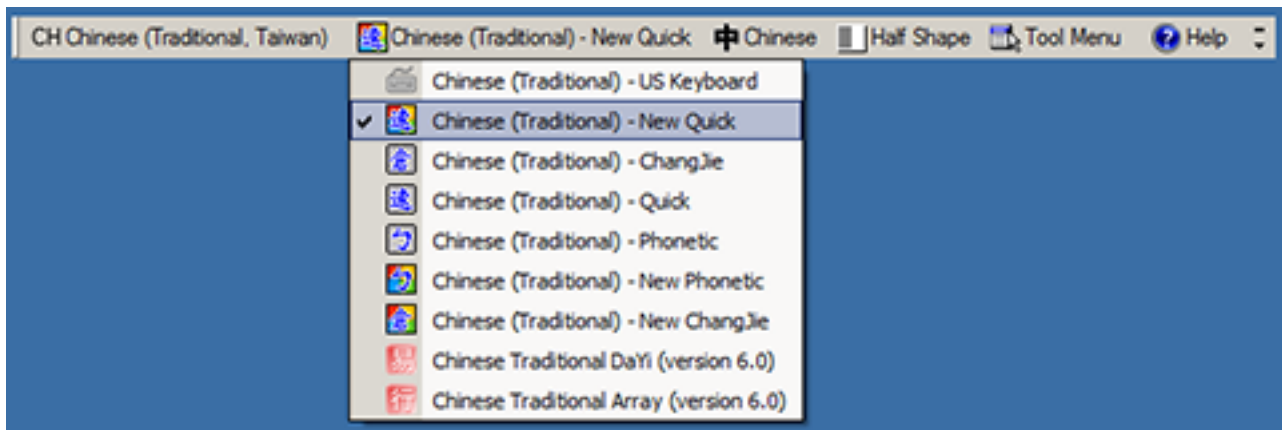

Non-Parameter Attributes

This appendix defines non-parameter attributes.

Model Number

Attribute #533

Model number of the scanner. This electronic output matches the printout on the physical device label.

For example, SP7208-SV00004CCWW

Type	S
Size (Bytes)	18
User Mode Access	R
Values	Variable

Serial Number

Attribute #534

Unique serial number assigned in the manufacturing facility. This electronic output matches the printout on the physical device label, for example M1J26F45V.

Type	S
Size (Bytes)	16
User Mode Access	R
Values	Variable

Date of Manufacture

Attribute #535

Date of device manufacture assigned in the manufacturing facility. This electronic output matches the printout on the physical device label, for example 30APR14 (which reads the 30th of April 2014).

Type	S
Size (Bytes)	7

User Mode Access	R
Values	Variable

Date of First Programming

Attribute #614

Date of first electronic programming represents the first time settings were electronically loaded to the scanner either by 123Scan or via SMS, for example 18MAY14 (which reads the 18th of May 2014).

Type	S
Size (Bytes)	7
User Mode Access	R
Values	Variable

Configuration Filename

Attribute #616

The name assigned to the configuration settings loaded electronically to the device either by 123Scan or via SMS.



NOTE: Scanning the Set Defaults barcode automatically changes the configuration filename to factory defaults.

To indicate the configuration settings loaded to the device were changed, the configuration filename changes to Modified upon scanning any parameter barcode.

Type	S
Size (Bytes)	17
User Mode Access	RW
Values	Variable

Beeper/LED

Attribute #6000

Activates the beeper and/or LED.

Type	X
Size (Bytes)	N/A
User Mode Access	W
Values	See Beeper/LED Values

Table 46 Beeper/LED Values

Beep / LED Action	Value	Beep / LED Action	Value
1 high short beep	0	1 low long beep	15
2 high short beeps	1	2 low long beeps	16
3 high short beeps	2	3 low long beeps	17
4 high short beeps	3	4 low long beeps	18
5 high short beeps	4	5 low long beeps	19
1 low short beep	5	Fast warble beep	20
2 low short beeps	6	Slow warble beep	21
3 low short beeps	7	High-low beep	22
4 low short beeps	8	Low-high beep	23
5 low short beeps	9	High-low-high beep	24
1 high long beep	10	Low-high-low beep	25
2 high long beeps	11	High-high-low-low beep	26
3 high long beeps	12	Green LED off	42
4 high long beeps	13	Green LED on	43
5 high long beeps	14	Red LED on	47
		Red LED off	48

Parameter Defaults

Attribute #6001

This attribute restores all parameters to their factory defaults.

Type	X
Size (Bytes)	N/A
User Mode Access	W
Values	0 = Restore Defaults 1 = Restore Factory Defaults 2 = Write Custom Defaults

Beep on Next Bootup

Attribute #6003

This attribute configures (enables or disables) beep on next boot up of scanner.

Type	X
Size (Bytes)	N/A
User Mode Access	W

Values	0 = Disable beep on next bootup 1 = Enable beep on next bootup
--------	--

Reboot

Attribute #6004

This attribute initiates a device reboot.

Type	X
Size (Bytes)	N/A
User Mode Access	W
Values	N/A

Host Trigger Session

Attribute #6005

This attribute triggers a decode session similar to manually depressing the scanner trigger button.

Type	X
Size (Bytes)	N/A
User Mode Access	W
Values	1 = Start Host Trigger Session 0 = Stop Host Trigger Session

Firmware Version

Attribute #20004

The scanner's operating system version. For example, NBRFMAAC or PAAAABS00-007-R03D0.

Type	S
Size (Bytes)	Variable
User Mode Access	R
Values	Variable

Scankit Version

Attribute #20008

Identifies the 1D decode algorithms resident on the device, for example SKIT4.33T02.

Type	S
Size (Bytes)	Variable
User Mode Access	R
Values	Variable

Sample Barcodes

This section provides sample barcodes.

Sample Code 39



Sample Code 93

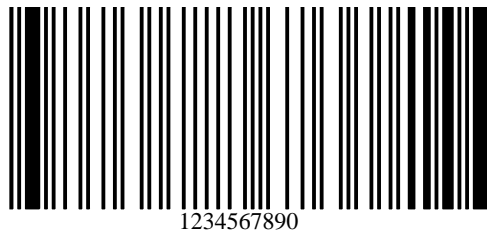

Sample UPC/EAN

UPC-A, 100%



UPC-E



EAN-8



EAN-13, 100%

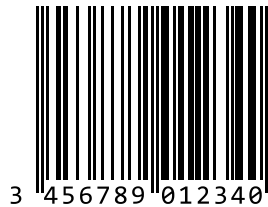

Sample Code 128



Sample Interleaved 2 of 5



Sample GS1 DataBar

GS1 DataBar Omnidirectional



NOTE: GS1 DataBar Omnidirectional must be enabled to read the following barcode (see [GS1 DataBar Omnidirectional \(formerly GS1 DataBar-14\)](#) on page 393).



GS1 DataBar Limited



NOTE: DataDataBar Limited must be enabled to read the following barcode (see [GS1 DataBar Limited](#) on page 394).



GS1 DataBar Expanded



NOTE: DataBar Expanded must be enabled to read the following barcode (see [GS1 DataBar Expanded](#) on page 395).



Sample PDF417

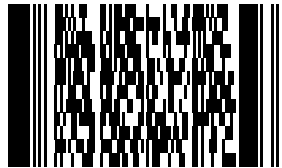

Sample Data Matrix

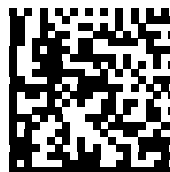

123456789abcdefghijklmnopqrstuvwxy

Sample Maxicode

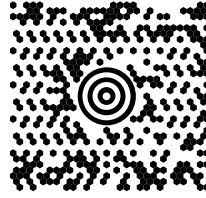

Sample QR Code

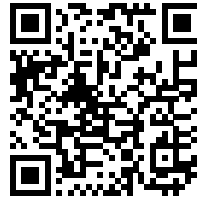

0123456789ABCDEFGHIJKLMN0PQRSTUVWXYZ0123456789ABCDEFGHIJKLMN0PQRSTUVWXYZ0123456789

Sample Aztec



0123456789ABCDEFGHIJKLMN0PQRSTUVWXYZ0123456789ABCDEFGHIJKLMN0PQRSTUVWXYZ
WXYZ01234567890123456789ABCDEFGHIJKLMN0PQRSTUVWXYZ0123456789ABCDEFGHI
JKLMN0PQRSTUVWXYZ0123456789

Sample Grid Matrix



NOTE: Grid Matrix must be enabled to read the following bar code (see [Grid Matrix](#)).

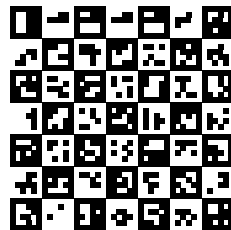

Sample US Postnet



Sample UK Postal



