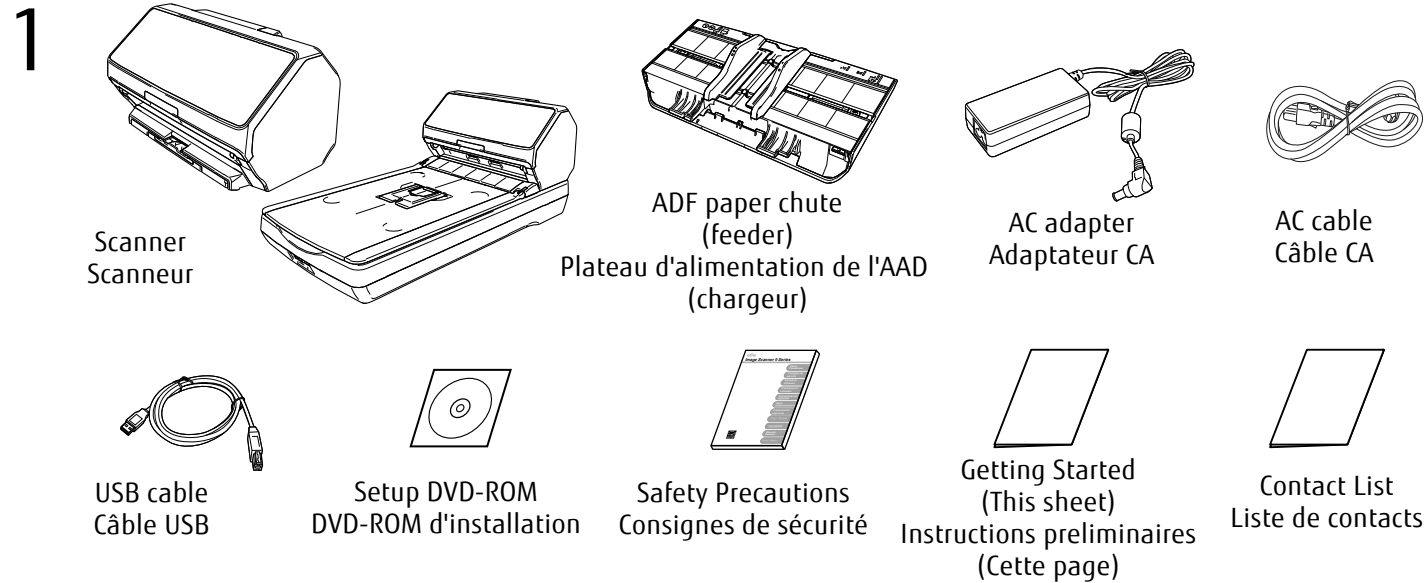



Image Scanner

fi-8190/fi-8290/fi-8170/fi-8270/fi-8150/fi-8250/fi-8150U/fi-8250U

Getting Started/Instructions préliminaires



The contents may vary depending on the country and the model purchased.
Le contenu risque de différer selon le pays d'achat et le modèle.
Je nach Land und Modell können sich die Inhalte unterscheiden.
I contenuti possono variare a seconda del Paese e del modello acquistato.
Los contenidos pueden diferir de acuerdo al modelo y al país donde adquirió.
Содержимое может изменяться в зависимости от страны и выбранной модели сканера.
O conteúdo pode variar dependendo do país e do modelo adquirido.
구입한 지역과 모델에 따라서 내용이 다를 수 있습니다.
內容根據國家與購買的機型而異。
Paket içeriği ülkeye ve satın alınmış modele göre farklılık gösterebilir.
قد تختلف المحتويات حسب البلد والطرز المشتري.

2 fi-8190/fi-8170/fi-8150/fi-8150U Step 1 may not be required for some models.
Peut-être, l'étape 1 n'est pas nécessaire pour certains modèles.

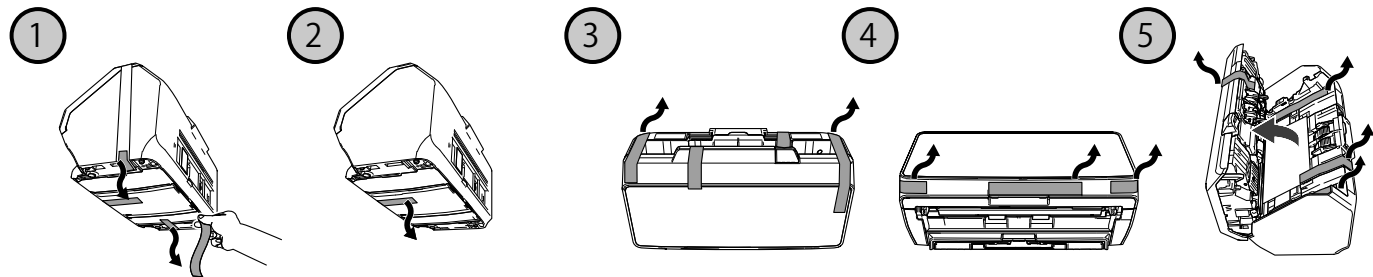

fi-8290/fi-8270/fi-8250/fi-8250U

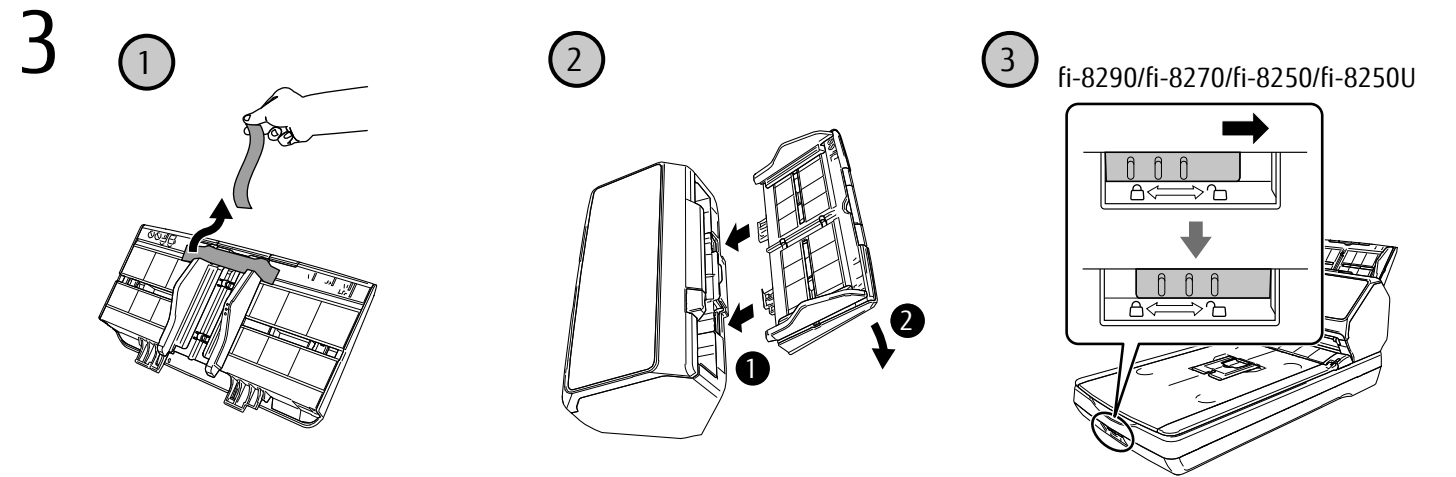
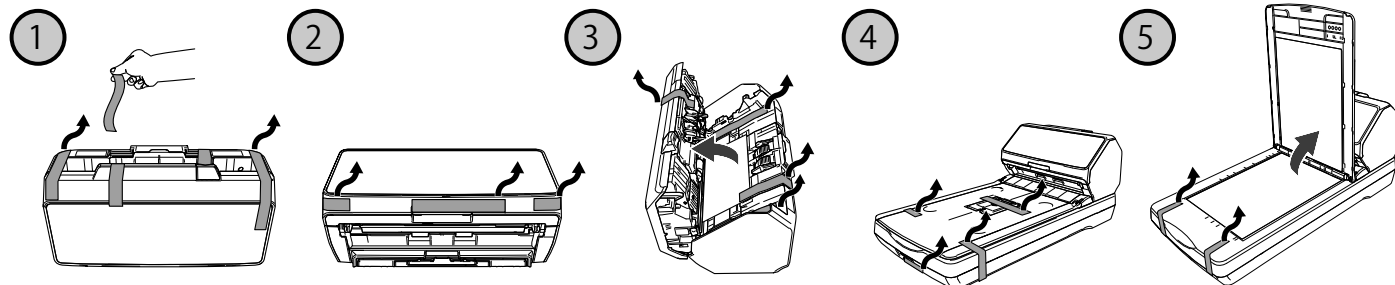

4 Check the operation and connection methods./Vérifiez le fonctionnement et les méthodes de connexion.

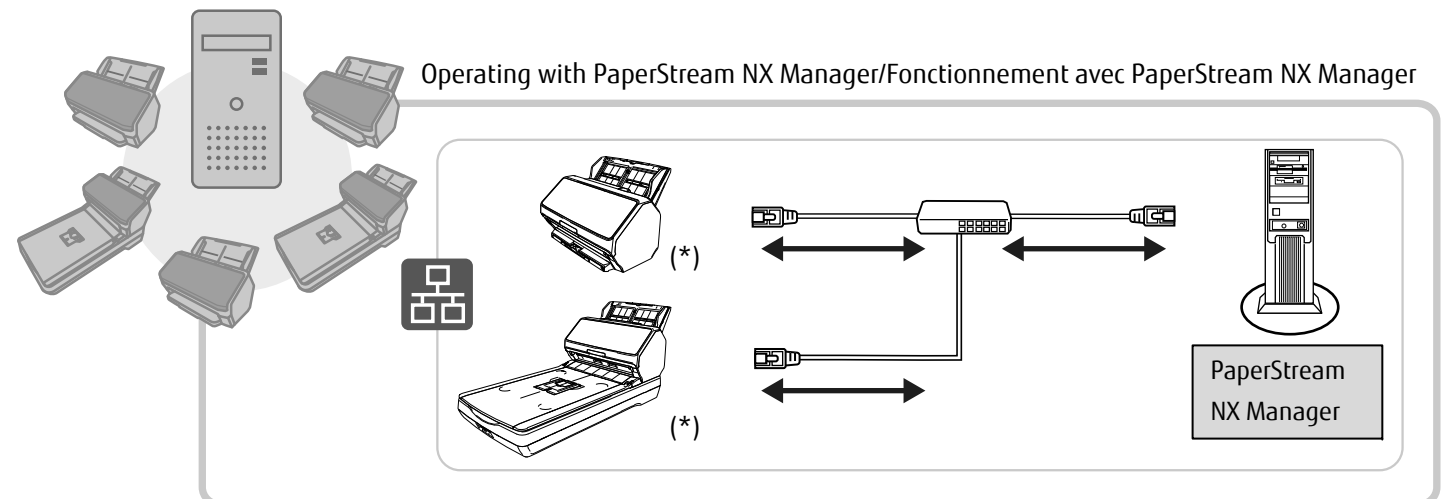
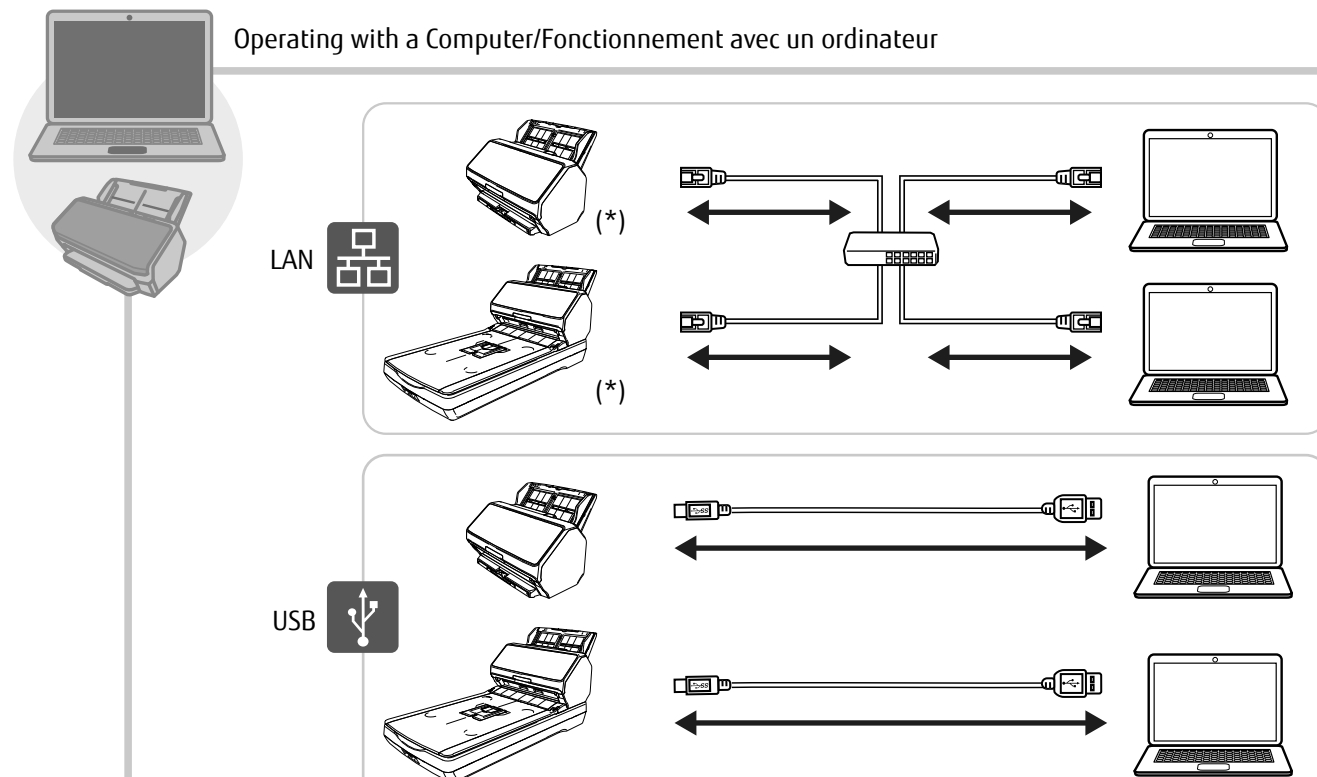

* fi-8190/fi-8290/fi-8170/fi-8270/fi-8150/fi-8250

5

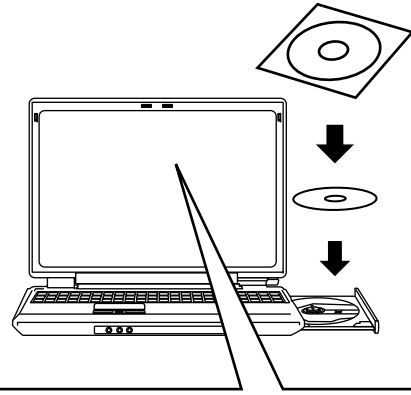
Setup DVD-ROM
DVD-ROM d'installation

1

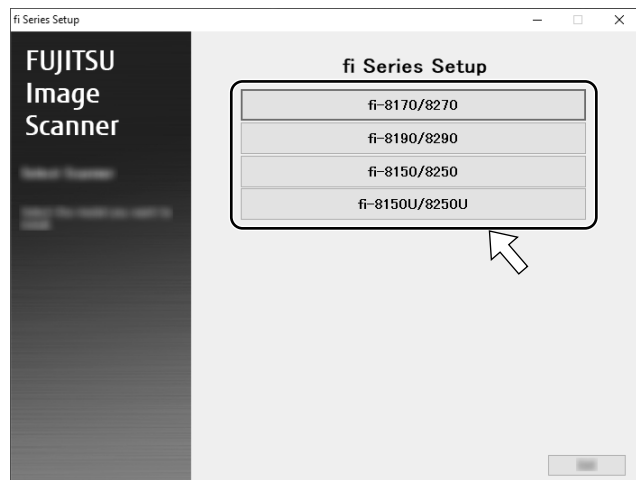

2

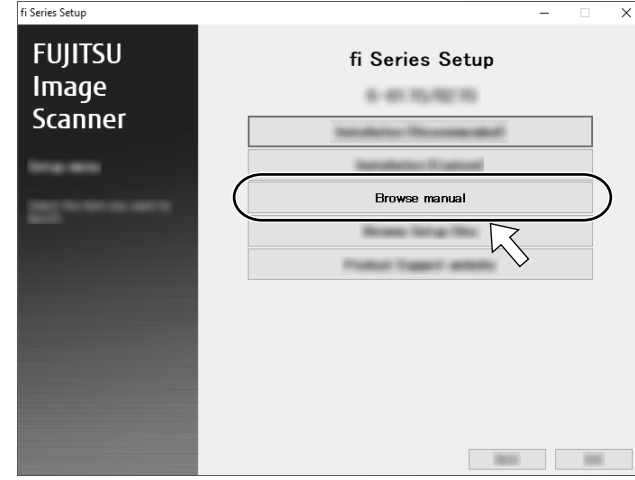

3

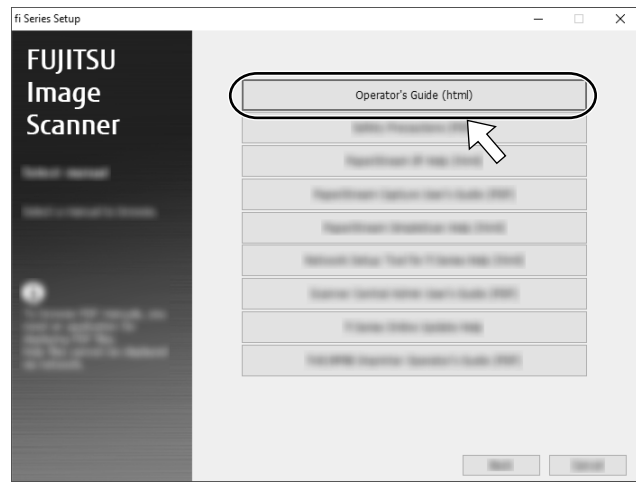

4



Refer to "Scanner Setup" in the Operator's Guide.
 Reportez-vous à la rubrique "Configuration du scanner" du Guide d'utilisation.
 Siehe "Scanner-Setup" im Bedienungshandbuch.
 Consultare "Installazione dello scanner" nella Guida dell'operatore.
 Consulte "Instalación del escáner" en la Guía del usuario.
 Смотрите "Настройка сканера" в Руководстве по эксплуатации.
 Consulte "Configuração do scanner" no Manual de instruções.
 사용 설명서의 "스캐너 설치"를 참고해 주십시오.
 請參閱操作指南中的「掃描器設定」。
 İşletmen Kılavuzunda "Tarayıcı Kurulumu" bölümüne bakın.
 ارجع إلى "إعداد الماسحة" في دليل المشغل.

Please keep this disc safe as it will not be reissued.
 Conservez ce disque dans un endroit sûr car ce sera votre seul et unique exemplaire.
 Bitte bewahren Sie diese Disk sicher auf, da keine Neuauflage erhältlich sein wird.
 Non danneggiare il disco perché non verrà ridistribuito.
 Mantenga seguro este disco, ya que no se emitirá de nuevo.
 Так как диск не будет переиздан, пожалуйста, бережно храните данный диск.
 Mantenha o disco em um local seguro. A segunda via do disco não pode ser emitida.
 본 디스크는 재발행되지 않으므로 잘 보관해 주십시오.
 此光盤將不會重新發行，故請妥善保管。
 Bu disk yeniden verilmeyecektir. Diski güvenli bir yerde saklayın.
 جاء حافظ على القرص حيث لن يتم إصدار نسخة أخرى منه.

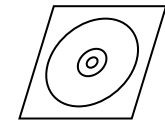
Setup DVD-ROM
DVD-ROM d'installation