

Vostro 3400

Service Manual



Notes, cautions, and warnings

 **NOTE:** A NOTE indicates important information that helps you make better use of your product.

 **CAUTION:** A CAUTION indicates either potential damage to hardware or loss of data and tells you how to avoid the problem.

 **WARNING:** A WARNING indicates a potential for property damage, personal injury, or death.

Chapter 1: Working on your computer	6
Safety instructions.....	6
Before working inside your computer.....	6
Safety instructions.....	7
Electrostatic discharge—ESD protection.....	7
ESD field service kit	8
After working inside your computer.....	9
Chapter 2: Technology and components	10
USB features.....	10
Power button LED behavior.....	12
HDMI 1.4.....	14
Chapter 3: Exploded View	15
Chapter 4: Major Components	18
Chapter 5: Disassembly and reassembly	19
Secure Digital Card.....	19
Removing the Secure Digital card.....	19
Installing the Secure Digital card.....	20
Base cover.....	21
Removing the base cover.....	21
Installing the base cover.....	23
Battery.....	25
Lithium-ion battery precautions.....	25
Disconnecting the battery.....	25
Reconnecting the battery.....	26
Removing the battery.....	27
Installing the battery.....	28
Memory modules.....	30
Removing the memory module.....	30
Installing the memory module.....	30
WLAN card.....	31
Removing the WLAN card.....	31
Installing the WLAN card.....	32
Solid-state drive.....	34
Removing the M.2 2230 Solid-state drive.....	34
Installing the M.2 2230 Solid-state drive.....	34
Removing the M.2 2280 Solid-state drive.....	35
Installing the M.2 2280 Solid-state drive.....	36
Hard drive.....	37
Removing the hard drive assembly.....	37
Installing the hard drive assembly.....	38

Coin-cell battery.....	40
Removing the coin-cell.....	40
Installing the coin-cell battery.....	41
System fan.....	41
Removing the system fan.....	41
Installing the system fan.....	42
Heat sink.....	43
Removing the Heatsink - UMA.....	43
Installing the Heatsink - UMA.....	44
Removing the Heatsink - Discrete.....	45
Installing the Heatsink - Discrete.....	46
Speakers.....	47
Removing the speakers.....	47
Installing the speakers.....	48
IO board.....	49
Removing the IO board.....	49
Installing the IO board.....	50
Touchpad.....	51
Removing the touch pad assembly.....	51
Installing the touch pad assembly.....	52
Display assembly.....	54
Removing the display assembly.....	54
Installing the display assembly.....	56
Display bezel.....	58
Removing the display bezel.....	58
Installing the display bezel	59
Display panel.....	59
Removing the display panel.....	59
Installation display panel.....	62
Camera.....	64
Removing the camera.....	64
Installing the camera.....	65
Display back-cover and antenna assembly.....	66
Removing the display back-cover.....	66
Installing the display back-cover.....	66
Power button.....	67
Removing the power button.....	67
Installing the power button.....	68
System board.....	69
Removing the system board - Realtek audio.....	69
Installing the system board - Realtek audio.....	72
Removing the system board - Cirrus Logic audio.....	74
Installing the system board - Cirrus Logic audio.....	75
Power-adapter port.....	78
Removing the power adapter port.....	78
Installing the power adapter port.....	79
Palm-rest and keyboard assembly.....	80
Removing the palmrest and keyboard assembly.....	80
Chapter 6: Troubleshooting.....	82

Handling swollen Lithium-ion batteries.....	82
Locate the Service Tag or Express Service Code of your Dell computer	83
SupportAssist On-board Diagnostics.....	83
System diagnostic lights.....	83
Real-Time Clock (RTC Reset).....	85
Updating the BIOS in Windows.....	85
Updating the BIOS using the USB drive in Windows.....	85
Backup media and recovery options.....	85
WiFi power cycle.....	86
Drain residual flea power (perform hard reset).....	86
Chapter 7: Getting help and contacting Dell.....	87

Working on your computer

Topics:

- [Safety instructions](#)

Safety instructions

Prerequisites

Use the following safety guidelines to protect your computer from potential damage and to ensure your personal safety. Unless otherwise noted, each procedure included in this document assumes that the following conditions exist:

- You have read the safety information that shipped with your computer.
- A component can be replaced or, if purchased separately, installed by performing the removal procedure in reverse order.

About this task

⚠ WARNING: Before working inside your computer, read the safety information that shipped with your computer. For additional safety best practices information, see the [Regulatory Compliance Homepage](#)

⚠ CAUTION: Many repairs may only be done by a certified service technician. You should only perform troubleshooting and simple repairs as authorized in your product documentation, or as directed by the online or telephone service and support team. Damage due to servicing that is not authorized by Dell is not covered by your warranty. Read and follow the safety instructions that came with the product.

⚠ CAUTION: To avoid electrostatic discharge, ground yourself by using a wrist grounding strap or by periodically touching an unpainted metal surface at the same time as touching a connector on the back of the computer.

⚠ CAUTION: Handle components and cards with care. Do not touch the components or contacts on a card. Hold a card by its edges or by its metal mounting bracket. Hold a component such as a processor by its edges, not by its pins.

⚠ CAUTION: When you disconnect a cable, pull on its connector or on its pull-tab, not on the cable itself. Some cables have connectors with locking tabs; if you are disconnecting this type of cable, press in on the locking tabs before you disconnect the cable. As you pull connectors apart, keep them evenly aligned to avoid bending any connector pins. Also, before you connect a cable, ensure that both connectors are correctly oriented and aligned.

ⓘ NOTE: Disconnect all power sources before opening the computer cover or panels. After you finish working inside the computer, replace all covers, panels, and screws before connecting to the power source.

⚠ CAUTION: Exercise caution when handling Lithium-ion batteries in laptops. Swollen batteries should not be used and should be replaced and disposed properly.

ⓘ NOTE: The color of your computer and certain components may appear differently than shown in this document.

Before working inside your computer

Steps

1. Save and close all open files and exit all open applications.
2. Shut down your computer. Click **Start** > **Power** > **Shut down**.

 **NOTE:** If you are using a different operating system, see the documentation of your operating system for shut-down instructions.

3. Disconnect your computer and all attached devices from their electrical outlets.
4. Disconnect all attached network devices and peripherals, such as keyboard, mouse, and monitor from your computer.
5. Remove any media card and optical disc from your computer, if applicable.
6. After the computer is unplugged, press and hold the power button for 5 seconds to ground the system board.

 **CAUTION:** Place the computer on a flat, soft, and clean surface to avoid scratches on the display.

7. Place the computer face down.

Safety instructions

Use the following safety guidelines to protect your computer from potential damage and to ensure your personal safety. Unless otherwise noted, each procedure included in this document assumes that you have read the safety information that shipped with your computer.

 **WARNING:** Before working inside your computer, read the safety information that is shipped with your computer. For more safety best practices, see the Regulatory Compliance home page at www.dell.com/regulatory_compliance.

 **WARNING:** Disconnect your computer from all power sources before opening the computer cover or panels. After you finish working inside the computer, replace all covers, panels, and screws before connecting your computer to an electrical outlet.

 **CAUTION:** To avoid damaging the computer, ensure that the work surface is flat, dry, and clean.

 **CAUTION:** To avoid damaging the components and cards, handle them by their edges, and avoid touching the pins and the contacts.

 **CAUTION:** You should only perform troubleshooting and repairs as authorized or directed by the Dell technical assistance team. Damage due to servicing that is not authorized by Dell is not covered by your warranty. See the safety instructions that is shipped with the product or at www.dell.com/regulatory_compliance.

 **CAUTION:** Before touching anything inside your computer, ground yourself by touching an unpainted metal surface, such as the metal at the back of the computer. While you work, periodically touch an unpainted metal surface to dissipate static electricity which could harm internal components.

 **CAUTION:** When you disconnect a cable, pull it by its connector or its pull tab, not the cable itself. Some cables have connectors with locking tabs or thumbscrews that you must disengage before disconnecting the cable. When disconnecting cables, keep them evenly aligned to avoid bending the connector pins. When connecting cables, ensure that the ports and the connectors are correctly oriented and aligned.

 **CAUTION:** Press and eject any installed card from the media-card reader.

 **CAUTION:** Exercise caution when handling Lithium-ion batteries in laptops. Swollen batteries should not be used and should be replaced and disposed properly.

 **NOTE:** The color of your computer and certain components may appear differently than shown in this document.

Electrostatic discharge—ESD protection

ESD is a major concern when you handle electronic components, especially sensitive components such as expansion cards, processors, memory DIMMs, and system boards. Very slight charges can damage circuits in ways that may not be obvious, such as intermittent problems or a shortened product life span. As the industry pushes for lower power requirements and increased density, ESD protection is an increasing concern.

Due to the increased density of semiconductors used in recent Dell products, the sensitivity to static damage is now higher than in previous Dell products. For this reason, some previously approved methods of handling parts are no longer applicable.

Two recognized types of ESD damage are catastrophic and intermittent failures.

- **Catastrophic** – Catastrophic failures represent approximately 20 percent of ESD-related failures. The damage causes an immediate and complete loss of device functionality. An example of catastrophic failure is a memory DIMM that has received a static shock and immediately generates a "No POST/No Video" symptom with a beep code emitted for missing or nonfunctional memory.
- **Intermittent** – Intermittent failures represent approximately 80 percent of ESD-related failures. The high rate of intermittent failures means that most of the time when damage occurs, it is not immediately recognizable. The DIMM receives a static shock, but the tracing is merely weakened and does not immediately produce outward symptoms related to the damage. The weakened trace may take weeks or months to melt, and in the meantime may cause degradation of memory integrity, intermittent memory errors, etc.

The more difficult type of damage to recognize and troubleshoot is the intermittent (also called latent or "walking wounded") failure.

Perform the following steps to prevent ESD damage:

- Use a wired ESD wrist strap that is properly grounded. The use of wireless anti-static straps is no longer allowed; they do not provide adequate protection. Touching the chassis before handling parts does not ensure adequate ESD protection on parts with increased sensitivity to ESD damage.
- Handle all static-sensitive components in a static-safe area. If possible, use anti-static floor pads and workbench pads.
- When unpacking a static-sensitive component from its shipping carton, do not remove the component from the anti-static packing material until you are ready to install the component. Before unwrapping the anti-static packaging, ensure that you discharge static electricity from your body.
- Before transporting a static-sensitive component, place it in an anti-static container or packaging.

ESD field service kit

The unmonitored Field Service kit is the most commonly used service kit. Each Field Service kit includes three main components: anti-static mat, wrist strap, and bonding wire.

Components of an ESD field service kit

The components of an ESD field service kit are:

- **Anti-Static Mat** – The anti-static mat is dissipative and parts can be placed on it during service procedures. When using an anti-static mat, your wrist strap should be snug and the bonding wire should be connected to the mat and to any bare metal on the system being worked on. Once deployed properly, service parts can be removed from the ESD bag and placed directly on the mat. ESD-sensitive items are safe in your hand, on the ESD mat, in the system, or inside a bag.
- **Wrist Strap and Bonding Wire** – The wrist strap and bonding wire can be either directly connected between your wrist and bare metal on the hardware if the ESD mat is not required, or connected to the anti-static mat to protect hardware that is temporarily placed on the mat. The physical connection of the wrist strap and bonding wire between your skin, the ESD mat, and the hardware is known as bonding. Use only Field Service kits with a wrist strap, mat, and bonding wire. Never use wireless wrist straps. Always be aware that the internal wires of a wrist strap are prone to damage from normal wear and tear, and must be checked regularly with a wrist strap tester in order to avoid accidental ESD hardware damage. It is recommended to test the wrist strap and bonding wire at least once per week.
- **ESD Wrist Strap Tester** – The wires inside of an ESD strap are prone to damage over time. When using an unmonitored kit, it is a best practice to regularly test the strap prior to each service call, and at a minimum, test once per week. A wrist strap tester is the best method for doing this test. If you do not have your own wrist strap tester, check with your regional office to find out if they have one. To perform the test, plug the wrist-strap's bonding-wire into the tester while it is strapped to your wrist and push the button to test. A green LED is lit if the test is successful; a red LED is lit and an alarm sounds if the test fails.
- **Insulator Elements** – It is critical to keep ESD sensitive devices, such as plastic heat sink casings, away from internal parts that are insulators and often highly charged.
- **Working Environment** – Before deploying the ESD Field Service kit, assess the situation at the customer location. For example, deploying the kit for a server environment is different than for a desktop or portable environment. Servers are typically installed in a rack within a data center; desktops or portables are typically placed on office desks or cubicles. Always look for a large open flat work area that is free of clutter and large enough to deploy the ESD kit with additional space to accommodate the type of system that is being repaired. The workspace should also be free of insulators that can cause an ESD event. On the work area, insulators such as Styrofoam and other plastics should always be moved at least 12 inches or 30 centimeters away from sensitive parts before physically handling any hardware components
- **ESD Packaging** – All ESD-sensitive devices must be shipped and received in static-safe packaging. Metal, static-shielded bags are preferred. However, you should always return the damaged part using the same ESD bag and packaging that the new part arrived in. The ESD bag should be folded over and taped shut and all the same foam packing material should be

used in the original box that the new part arrived in. ESD-sensitive devices should be removed from packaging only at an ESD-protected work surface, and parts should never be placed on top of the ESD bag because only the inside of the bag is shielded. Always place parts in your hand, on the ESD mat, in the system, or inside an anti-static bag.

- **Transporting Sensitive Components** – When transporting ESD sensitive components such as replacement parts or parts to be returned to Dell, it is critical to place these parts in anti-static bags for safe transport.

ESD protection summary

It is recommended that all field service technicians use the traditional wired ESD grounding wrist strap and protective anti-static mat at all times when servicing Dell products. In addition, it is critical that technicians keep sensitive parts separate from all insulator parts while performing service and that they use anti-static bags for transporting sensitive components.

After working inside your computer

About this task

 **NOTE:** Leaving stray or loose screws inside your computer may severely damage your computer.

Steps

1. Replace all screws and ensure that no stray screws remain inside your computer.
2. Connect any external devices, peripherals, or cables you removed before working on your computer.
3. Replace any media cards, discs, or any other parts that you removed before working on your computer.
4. Connect your computer and all attached devices to their electrical outlets.
5. Turn on your computer.

Technology and components

This chapter details the technology and components available in the system.

Topics:

- [USB features](#)
- [Power button LED behavior](#)
- [HDMI 1.4](#)

USB features

Universal Serial Bus, or USB, was introduced in 1996. It dramatically simplified the connection between host computers and peripheral devices like mice, keyboards, external drives, and printers.

Table 1. USB evolution

Type	Data Transfer Rate	Category	Introduction Year
USB 2.0	480 Mbps	High Speed	2000
USB 3.2 Gen 1	5 Gbps	Super-Speed	2010

USB 3.2 Gen 1 (Super-Speed USB)

For years, the USB 2.0 has been firmly entrenched as the de facto interface standard in the PC world with about 6 billion devices sold, and yet the need for more speed grows by ever faster computing hardware and ever greater bandwidth demands. The USB 3.2 Gen 1 finally has the answer to the consumer's demands with a theoretically 10 times faster than its predecessor. In a nutshell, USB 3.2 Gen 1 features are as follows:

- Higher transfer rates (up to 5 Gbps)
- Increased maximum bus power and increased device current draw to better accommodate power-hungry devices
- New power management features
- Full-duplex data transfers and support for new transfer types
- Backward USB 2.0 compatibility
- New connectors and cable

The topics below cover some of the most commonly asked questions regarding USB 3.2 Gen 1.



Speed

Currently, there are 3 speed modes that are defined by the latest USB 3.2 Gen 1 specification. They are Super-Speed, Hi-Speed, and Full-Speed. The new Super-Speed mode has a transfer rate of 4.8 Gbps. While the specification retains Hi-Speed, and Full-Speed USB mode, commonly known as USB 2.0 and 1.1 respectively, the slower modes still operate at 480 Mbps and 12 Mbps respectively and are kept to maintain backward compatibility.

USB 3.2 Gen 1 achieves the much higher performance by the technical changes below:

- An additional physical bus that is added in parallel with the existing USB 2.0 bus (see the figure below).
- USB 2.0 previously had four wires (power, ground, and a pair for differential data); USB 3.2 Gen 1 adds four more for two pairs of differential signals (receive and transmit) for a combined total of eight connections in the connectors and cabling.

- USB 3.2 Gen 1 utilizes the bi-directional data interface, rather than USB 2.0's half-duplex arrangement. This gives a 10-fold increase in theoretical bandwidth.

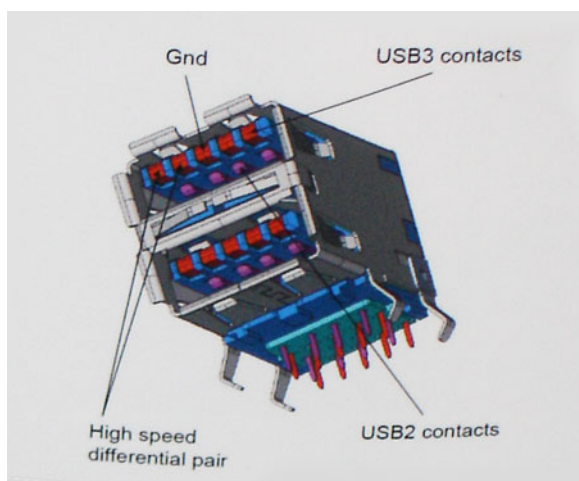

With today's ever increasing demands that are placed on data transfers with high-definition video content, terabyte storage devices, high megapixel count digital cameras etc., USB 2.0 may not be fast enough. Furthermore, no USB 2.0 connection could ever come close to the 480Mbps theoretical maximum throughput, making data transfer at around 320 Mbps (40 MB/s) — the actual real-world maximum. Similarly, USB 3.2 Gen 1 connections will never achieve 4.8Gbps. We will likely see a real-world maximum rate of 400 MB/s with overheads. At this speed, USB 3.2 Gen 1 is a 10x improvement over USB 2.0.

Applications

USB 3.2 Gen 1 opens up the laneways and provides more headroom for devices to deliver a better overall experience. Where USB video was barely tolerable previously (both from a maximum resolution, latency, and video compression perspective), it's easy to imagine that with 5-10 times the bandwidth available, USB video solutions should work that much better. Single-link DVI requires almost 2Gbps throughput. Where 480Mbps was limiting, 5Gbps is more than promising. With its promised 4.8Gbps speed, the standard will find its way into some products that previously weren't USB territory, like external RAID storage systems.

Listed below are some of the available Super-Speed USB 3.2 Gen 1 products:

- External Desktop USB 3.2 Gen 1 Hard Drives
- Portable USB 3.2 Gen 1 Hard Drives
- USB 3.2 Gen 1 Drive Docks & Adapters
- USB 3.2 Gen 1 Flash Drives & Readers
- USB 3.2 Gen 1 Solid-state Drives
- USB 3.2 Gen 1 RAID's
- Optical Media Drives
- Multimedia Devices
- Networking
- USB 3.2 Gen 1 Adapter Cards & Hubs

Compatibility

The good news is that USB 3.2 Gen 1 has been carefully planned from the start to peacefully co-exist with USB 2.0. First of all, while USB 3.2 Gen 1 specifies new physical connections and thus new cables to take advantage of the higher speed capability of the new protocol, the connector itself remains the same rectangular shape with the four USB 2.0 contacts in the exact same location as before. Five new connections to carry receive and transmitted data independently are present on USB 3.2 Gen 1 cables and only come into contact when connected to a proper Super-Speed USB connection.

Power button LED behavior

On certain Dell Latitude systems, the power button LED is used to provide an indication of the system status, and as a result the power button illuminates when pressed. The systems with the optional power button/fingerprint reader will have no LED under the power button and hence will apply the available LED's in the system to provide an indication of the system status.

Power button LED behavior without Fingerprint reader

- System is ON (S0) = LED illuminates solid white.
- System in Sleep/Standby (S3, SOix) = LED is off
- System is Off/Hibernating (S4/S5) = LED is off

Power On and LED behavior with Fingerprint reader

- Pressing the power button for a duration between 50 msec to 2 sec turns on the device.
- Power button does not register additional presses until the SOL (Sign-Of-Life) has been provided to the user.
- System LED's illuminates upon pressing the power button.
- All the available LED's (Keyboard backlit/ Keyboard caps lock LED/ Battery Charge LED) illuminates and displays specified behavior.
- The auditory tone is Off by default. It can be enabled in the BIOS setup.
- Safeguards do not time out if the device gets hung during the logon process.
- Dell logo: Turns on within 2 secs after pressing the power button.
- Full boot: Within 22 secs after pressing the power button.
- Below is the example timelines:

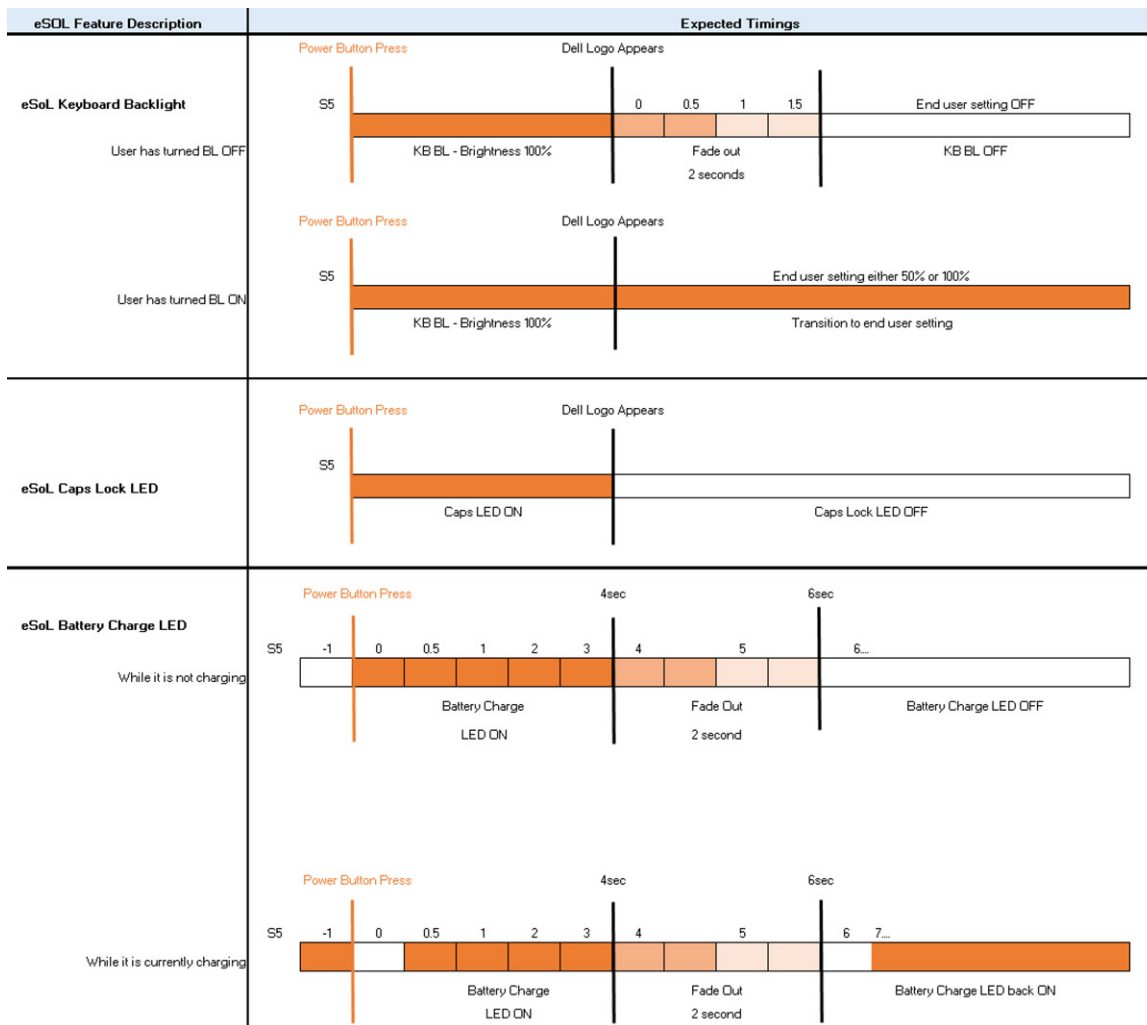

Power button with fingerprint reader will have no LED and will leverage the available LED's in the system to provide indication of the system status

- **Power Adapter LED:**
 - The LED on Power adapter connector illuminates white when power is supplied from electrical outlet.
- **Battery Indicator LED:**
 - If the computer is connected to an electrical outlet, the battery light operates as follows:
 1. Solid white -the battery is charging. When the charge is complete the LED turns off.
 - If the computer is running on a battery, the battery light operates as follows:
 1. Off -the battery is adequately charged (or the computer is turned off).
 2. Solid amber -the battery charge is critically low. A low battery state is approximately 30 minutes or less of battery life remaining.
- **Camera LED**
 - White LED activates when camera is on.
- **Mic Mute LED:**
 - When activated (muted), the mic mute LED on the F4 Key should illuminate WHITE.
- **RJ45 LEDs:**
 - [Table 2. LED on either side of RJ45 port](#)

Link speed indicator (LHS)	Activity indicator (RHS)
Green	Amber

HDMI 1.4

This topic explains the HDMI 1.4 and its features along with the advantages.

HDMI (High-Definition Multimedia Interface) is an industry-supported, uncompressed, all-digital audio/video interface. HDMI provides an interface between any compatible digital audio/video source, such as a DVD player, or A/V receiver and a compatible digital audio and/or video monitor, such as a digital TV (DTV). The primary advantage is cable reduction and content protection provisions. HDMI supports standard, enhanced, or high-definition video, plus multichannel digital audio on a single cable.

Advantages of HDMI

- Quality HDMI transfers uncompressed digital audio and video for the highest, crispest image quality.
- Low-cost HDMI provides the quality and functionality of a digital interface while also supporting uncompressed video formats in a simple, cost-effective manner.
- Audio HDMI supports multiple audio formats from standard stereo to multichannel surround sound.
- HDMI combines video and multichannel audio into a single cable, eliminating the cost, complexity, and confusion of multiple cables currently used in A/V systems.
- HDMI supports communication between the video source (such as a DVD player) and the DTV, enabling new functionality.

Exploded View

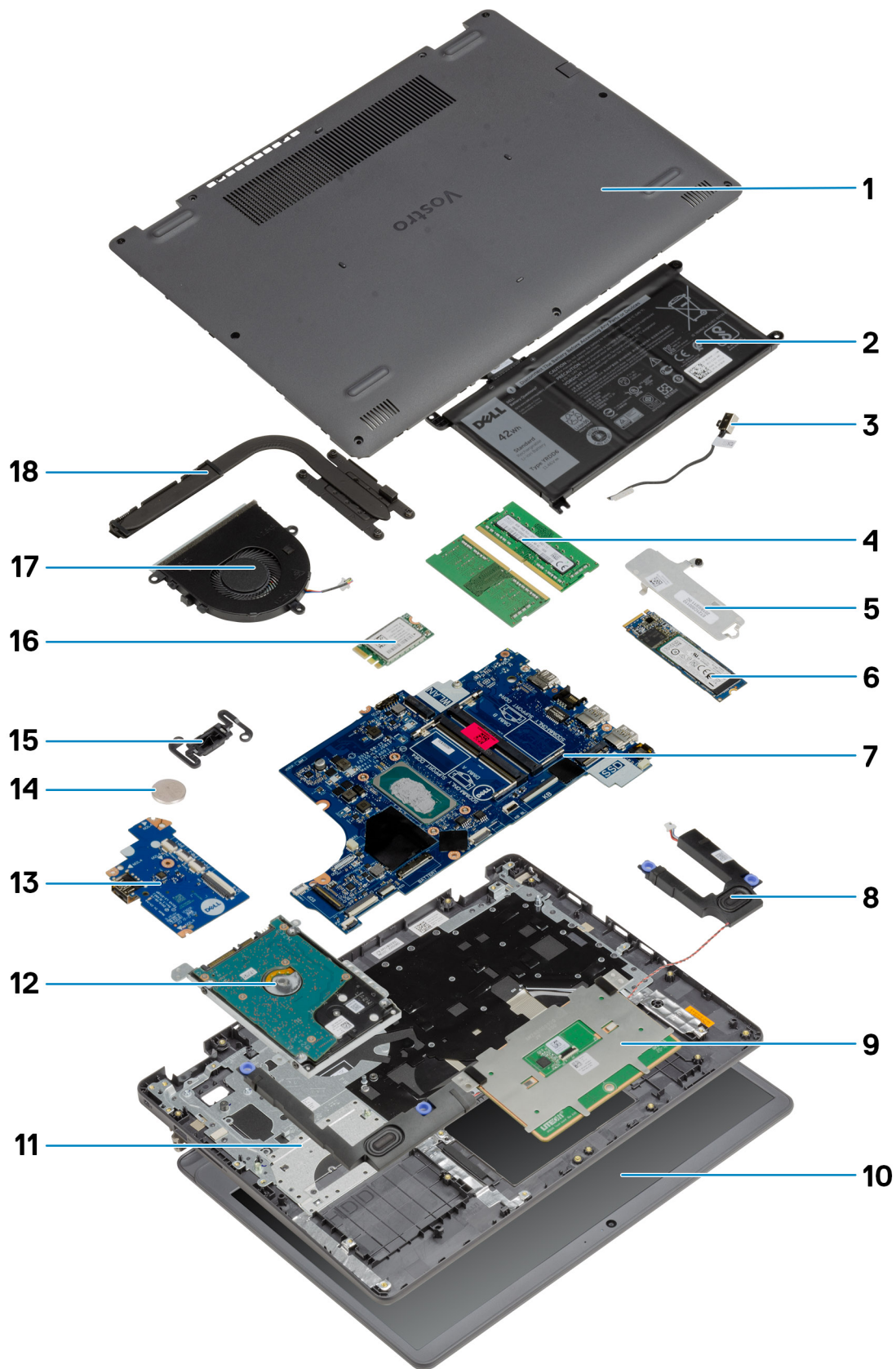

1. Base cover
2. Battery
3. DC-in Port
4. Memory modules
5. Solid-State Drive bracket
6. Solid-State Drive
7. System Board
8. Speakers
9. Touchpad
10. Display Assembly
11. Palmrest Assembly
12. HDD Assembly
13. IO Board
14. Coin Cell Battery
15. Power Button Module
16. WLAN Card
17. Fan Assembly
18. Heatsink assembly

 **NOTE:** Dell provides a list of components and their part numbers for the original system configuration purchased. These parts are available according to warranty coverages purchased by the customer. Contact your Dell sales representative for purchase options.

Major Components

Disassembly and reassembly

 **NOTE:** The images in this document may differ from your computer depending on the configuration you ordered.

Topics:

- [Secure Digital Card](#)
- [Base cover](#)
- [Battery](#)
- [Memory modules](#)
- [WLAN card](#)
- [Solid-state drive](#)
- [Hard drive](#)
- [Coin-cell battery](#)
- [System fan](#)
- [Heat sink](#)
- [Speakers](#)
- [IO board](#)
- [Touchpad](#)
- [Display assembly](#)
- [Display bezel](#)
- [Display panel](#)
- [Camera](#)
- [Display back-cover and antenna assembly](#)
- [Power button](#)
- [System board](#)
- [Power-adaptor port](#)
- [Palm-rest and keyboard assembly](#)

Secure Digital Card

Removing the Secure Digital card

Prerequisites

1. Follow the procedure in [Before working inside your computer](#).

About this task

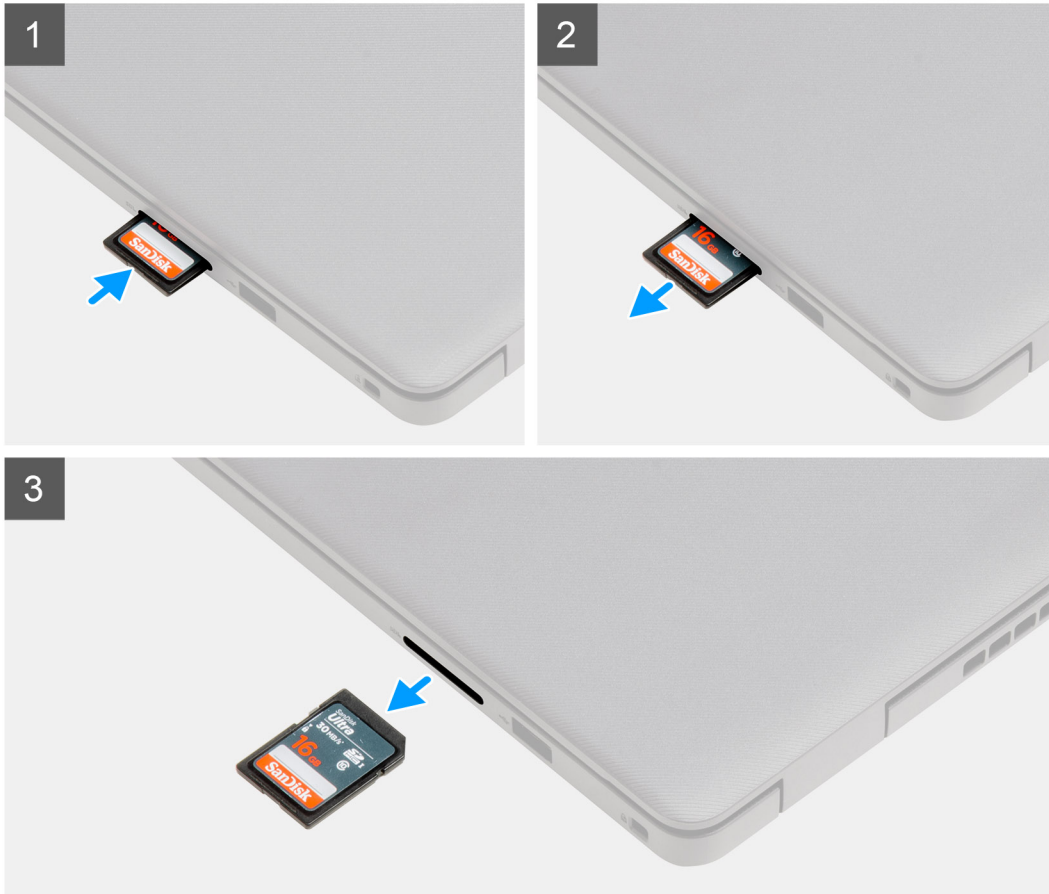

Steps

1. Push the secure digital card to release it from the computer.
2. Slide the secure digital card out of the computer.

Installing the Secure Digital card

Prerequisites

If you are replacing a component, remove the existing component before performing the installation procedure.

About this task

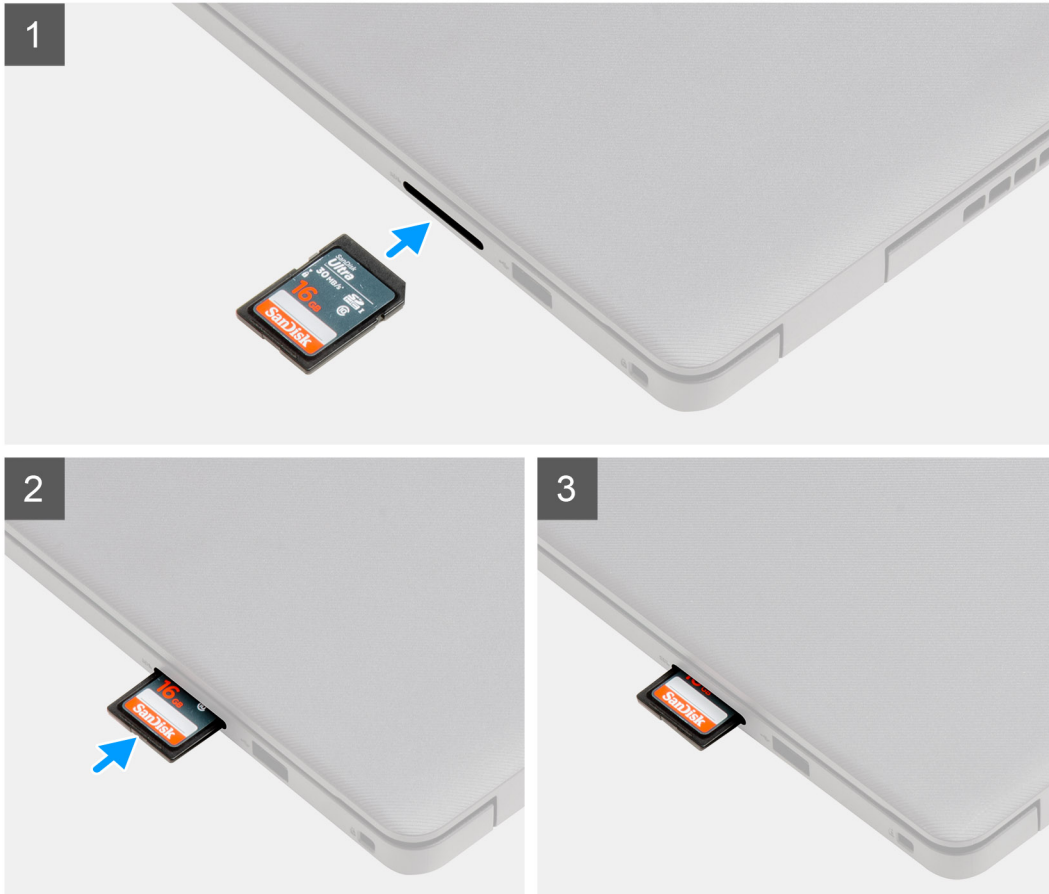

Steps

Slide the secure digital into the slot until it clicks into place.

Next steps

1. Follow the procedure in [after working inside your computer](#).

Base cover

Removing the base cover

Prerequisites

1. Follow the procedure in [before working inside your computer](#).
2. Remove the [SD card](#).

About this task



2x



7x
M2.5x5

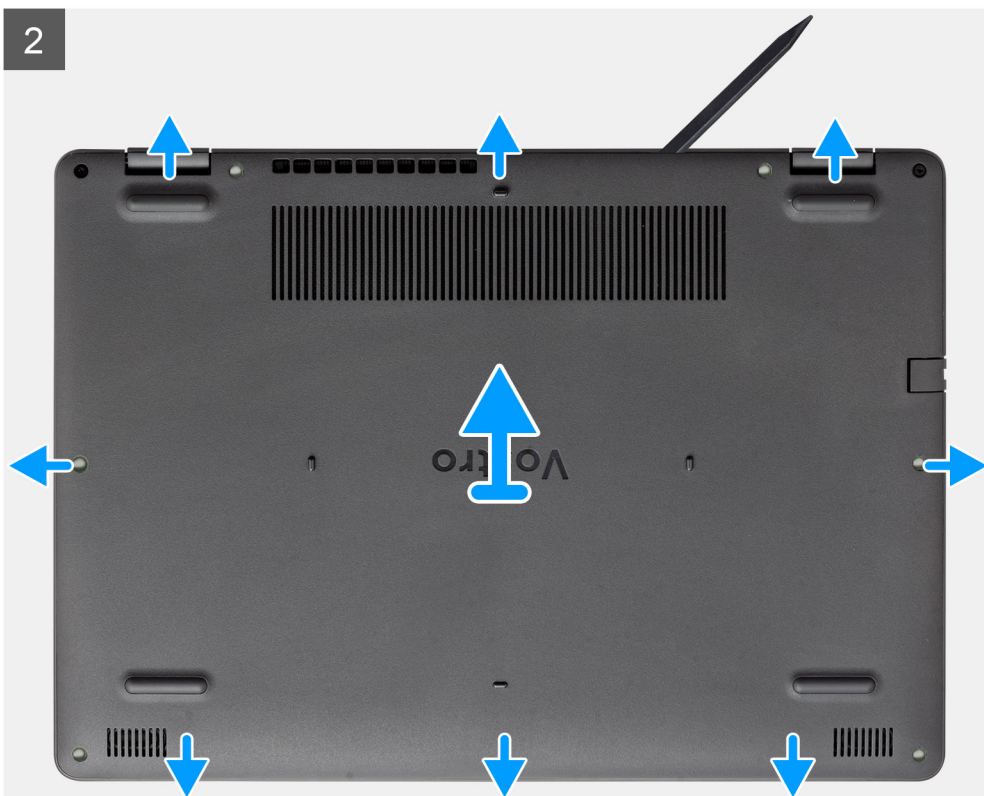
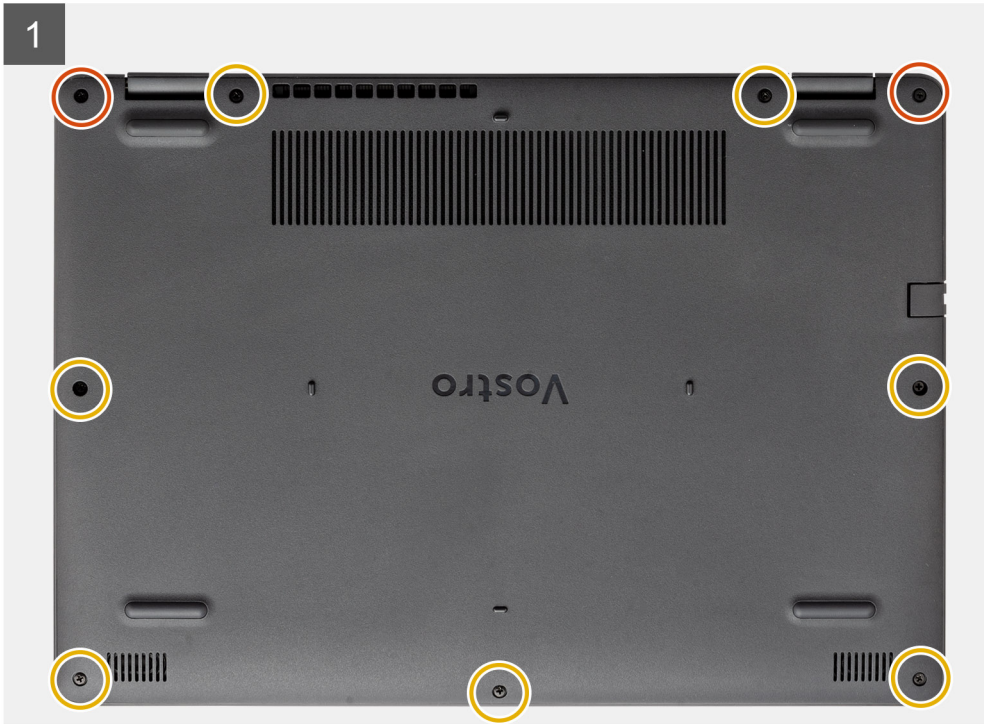

Steps

1. Remove the seven (M2.5x5) screws and loosen the two captive screws from the base cover.
2. Pry open the base cover starting from the recesses located in the U-shaped indents at the top edge of the base cover near the hinges.



NOTE: CAUTION: DO NOT pry up from the edge near the vents at the top side of the base cover as this may damage



the base cover.

3. Lift up the top side of the base cover and remove it from the system.

Installing the base cover

Prerequisites

If you are replacing a component, remove the existing component before performing the installation procedure.

About this task

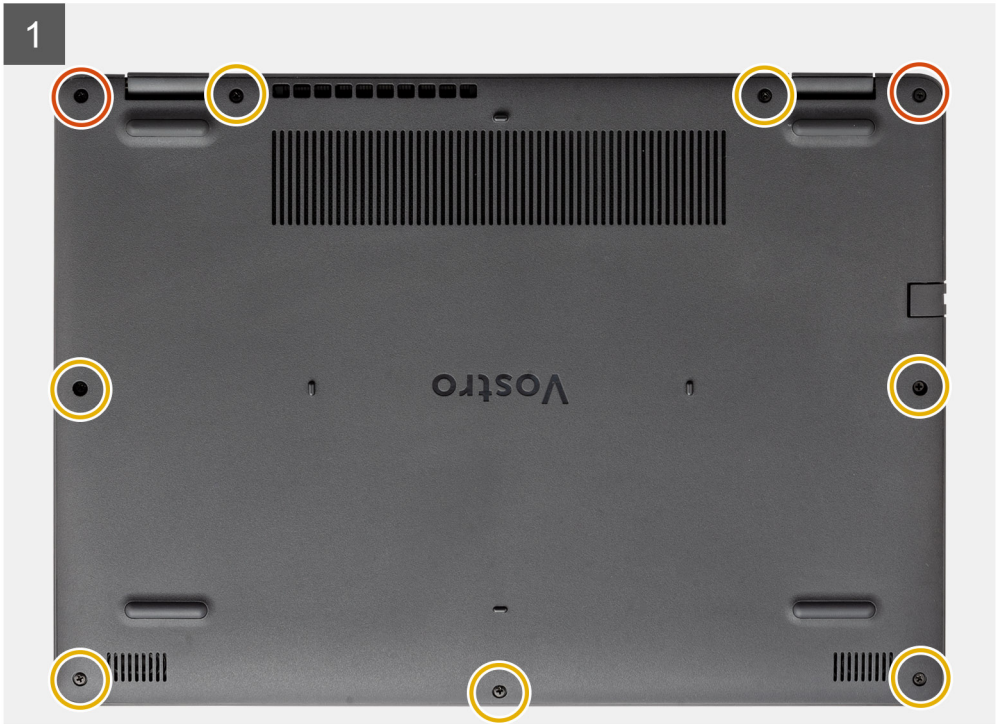
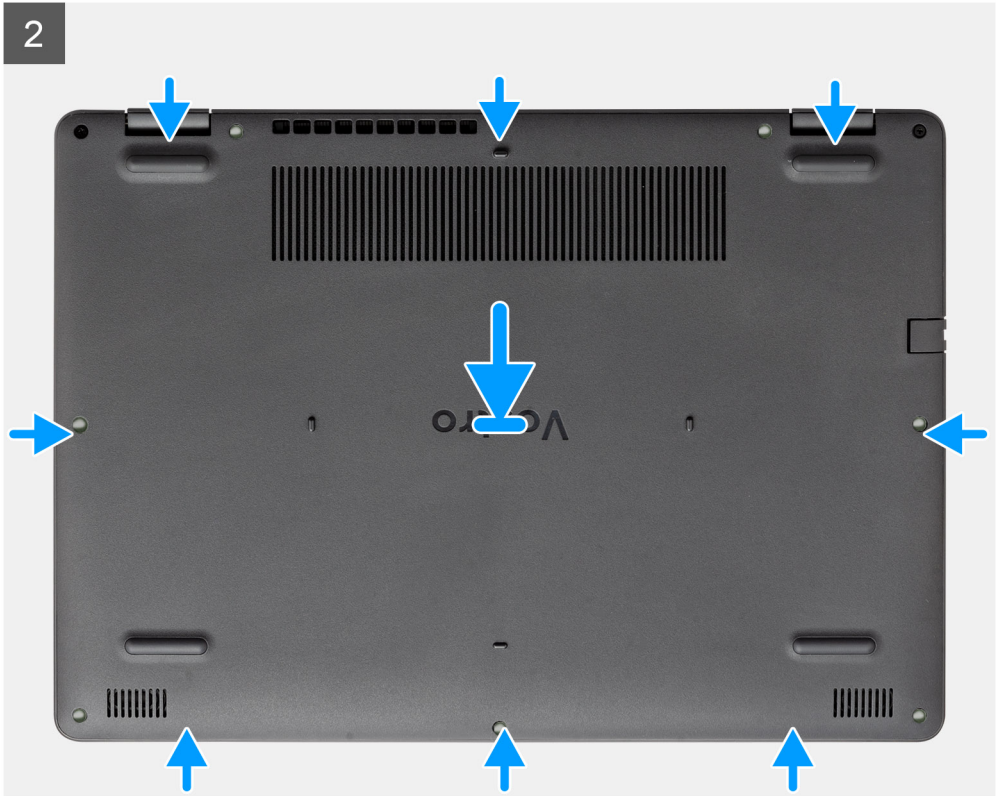

Steps

1. Align and place the base cover on the computer, press the edges and sides of the base cover until it snaps into place.
2. Tighten the seven (M2.5x5) screws and the two captive screws to secure the base cover to the computer.

Next steps

1. Replace the [SD card](#)
2. Follow the procedure in [after working inside your computer](#)

Battery

Lithium-ion battery precautions

CAUTION:

- Exercise caution when handling Lithium-ion batteries.
- Discharge the battery completely before removing it. Disconnect the AC power adapter from the system and operate the computer solely on battery power—the battery is fully discharged when the computer no longer turns on when the power button is pressed.
- Do not crush, drop, mutilate, or penetrate the battery with foreign objects.
- Do not expose the battery to high temperatures, or disassemble battery packs and cells.
- Do not apply pressure to the surface of the battery.
- Do not bend the battery.
- Do not use tools of any kind to pry on or against the battery.
- Ensure any screws during the servicing of this product are not lost or misplaced, to prevent accidental puncture or damage to the battery and other system components.
- If the battery gets stuck inside your computer as a result of swelling, do not try to release it as puncturing, bending, or crushing a lithium-ion battery can be dangerous. In such an instance, contact Dell technical support for assistance. See www.dell.com/contactdell.
- Always purchase genuine batteries from www.dell.com or authorized Dell partners and resellers.
- Swollen batteries should not be used and should be replaced and disposed properly. For guidelines on how to handle and replace swollen Lithium-ion batteries, see [Handling swollen Lithium-ion batteries](#).

Disconnecting the battery

Prerequisites

1. Follow the procedure in [before working inside your computer](#)
2. Remove the [SD card](#).
3. Remove the [base cover](#).

About this task

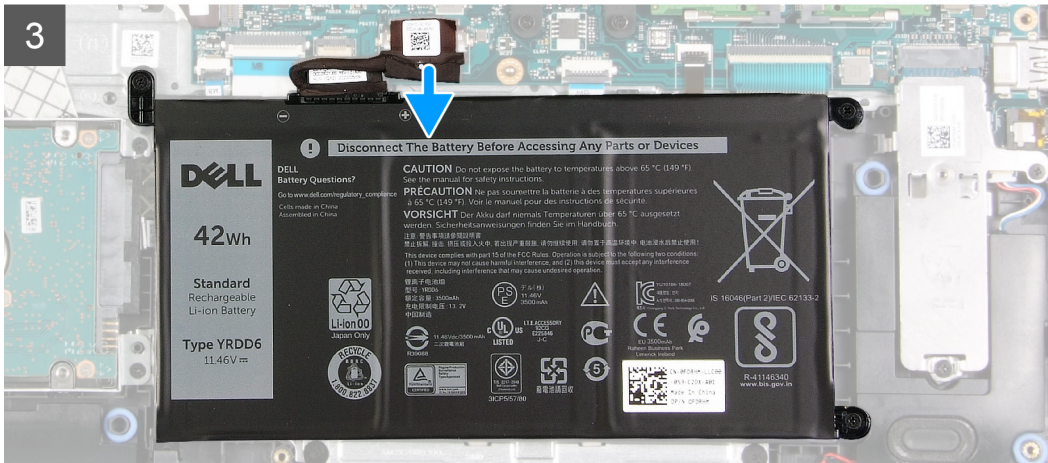
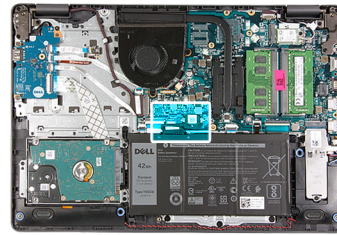

Steps

1. Peel back the tape covering the battery connector.
2. Disconnect the battery cable from the connector on the system board.

Reconnecting the battery

Prerequisites

If you are replacing a component, remove the existing component before performing the installation procedure.

About this task

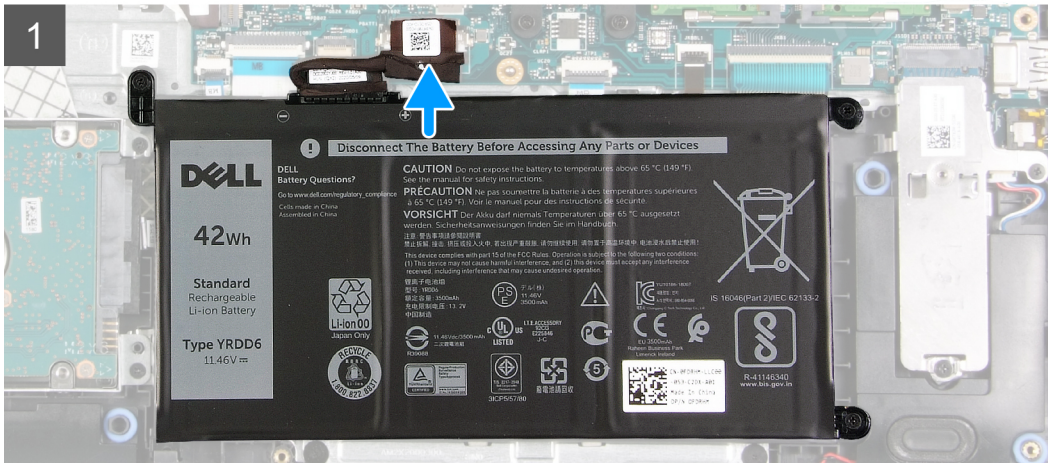
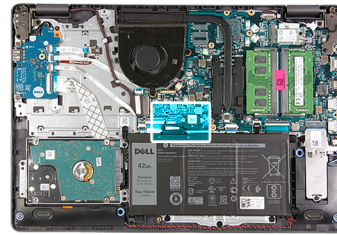

Steps

1. Connect the battery cable to the connector on the system board.
2. Replace the tape covering the battery connector.

Next steps

1. Install the [base cover](#).
2. Install the [SD card](#).
3. Follow the procedure in [after working inside your computer](#).

Removing the battery

Prerequisites

1. Follow the procedure in [before working inside your computer](#).
2. Remove the [SD card](#).
3. Remove the [base cover](#).

About this task

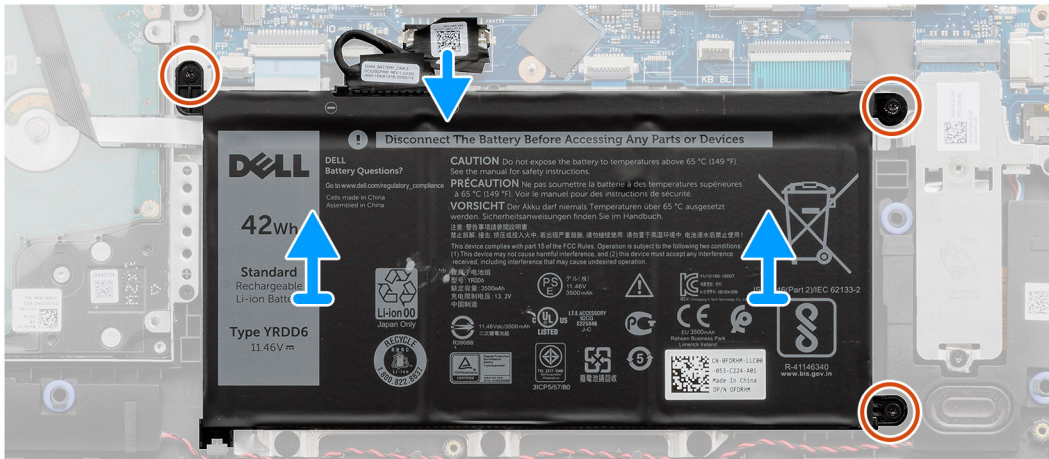
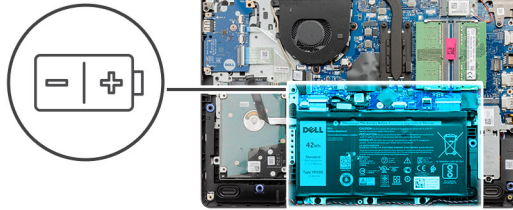

Steps

1. Remove the three (M2x3) screws that secure the battery to the palmrest.
2. Lift and move the battery away from the computer.

Installing the battery

Prerequisites

If you are replacing a component, remove the existing component before performing the installation procedure.

About this task



3x
M2x3

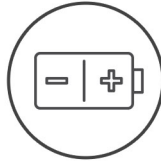

Steps

1. Align the tabs on the battery with the slots on the palm rest assembly.

NOTE: When installing the battery into the system, insert the tab at the bottom left corner of the battery into the hook on the bottom side of the palm rest.

2. Replace the three (M2x3) screws that secure the battery to the palmrest.
3. Reconnect the battery cable to the connector on the system board.

NOTE: When installing the battery into the system, insert the tab at the bottom left corner of the battery into the hook



on the bottom side of the palm rest.

Next steps

1. Install the [base cover](#).
2. Install the [SD card](#).
3. Follow the procedure in [after working inside your computer](#).

Memory modules

Removing the memory module

Prerequisites

1. Follow the procedure in [before working inside your computer](#).
2. Remove the [SD card](#).
3. Remove the [base cover](#).
4. Disconnect the [battery cable](#).

About this task

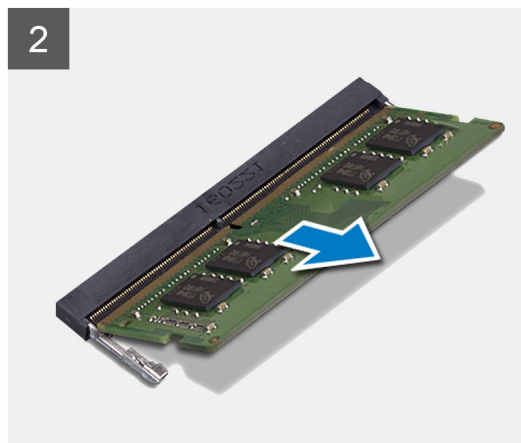
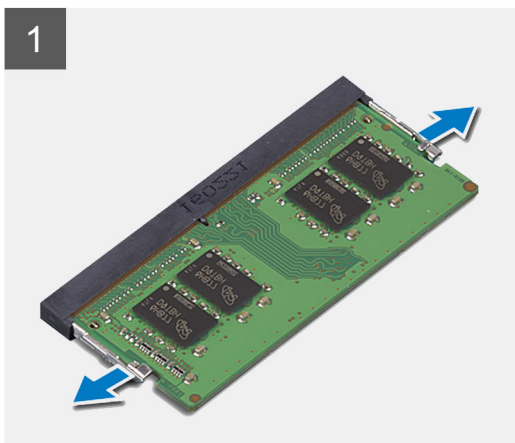
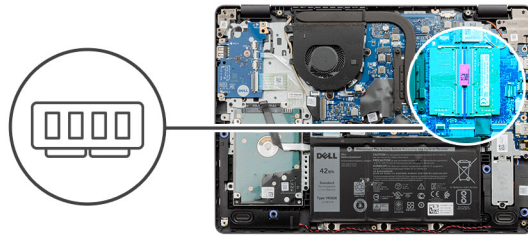

Steps

1. Pry the clips securing the memory module until the memory module pops-up.
2. Remove the memory module from the memory module slot.

Installing the memory module

Prerequisites

If you are replacing a component, remove the existing component before performing the installation procedure.

About this task

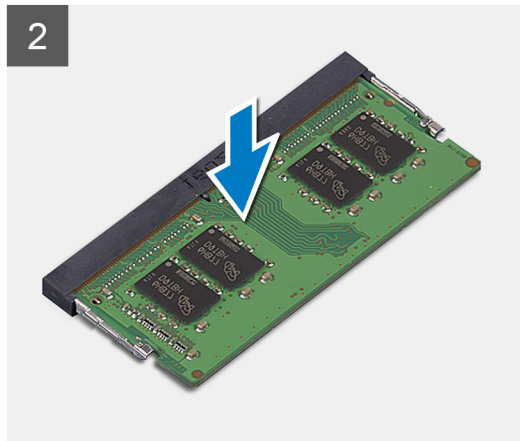
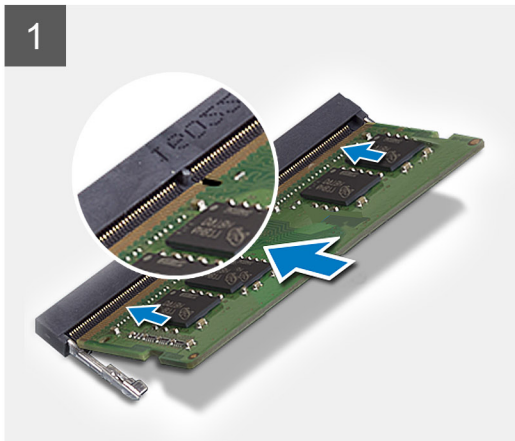
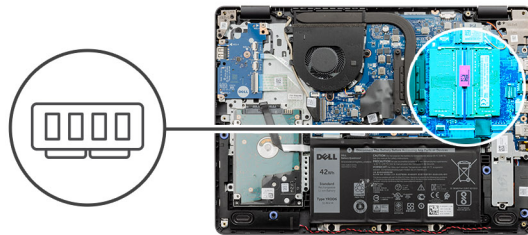

Steps

1. Align the notch on the memory module with the tab on the memory module slot and slide the memory module firmly into the slot at an angle.
2. Press the memory module down until the clips secure it.

 **NOTE:** If you do not hear the click, remove the memory module and reinstall it.

Next steps

1. Connect the [battery cable](#).
2. Install the [base cover](#).
3. Install the [SD card](#).
4. Follow the procedure in [after working inside your computer](#).

WLAN card

Removing the WLAN card

Prerequisites

1. Follow the procedure in [before working inside your computer](#).
2. Remove the [SD card](#).
3. Remove the [base cover](#).
4. Disconnect the [battery cable](#).

About this task



1x
M2x3

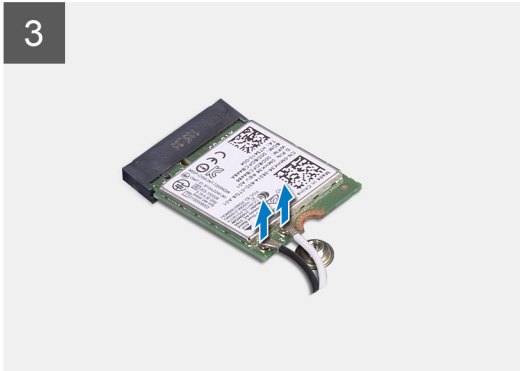
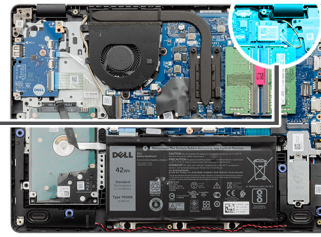

Steps

1. Remove the single (M2x3) screw that secures the WLAN card bracket to the system board.
2. Slide and remove the WLAN card bracket that secures the WLAN antenna cables.
3. Disconnect the WLAN antenna cables from the connectors on the WLAN card.
4. Pull out the WLAN card from the M.2 port on the system board.

Installing the WLAN card

Prerequisites

If you are replacing a component, remove the existing component before performing the installation procedure.

About this task



1x
M2x3

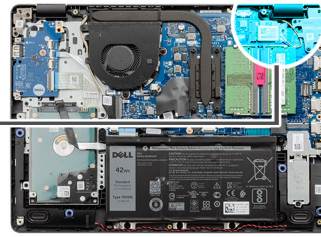

Steps

1. Replace the WLAN card into the M.2 Slot on the system board.
2. Connect the WLAN antenna cables to the connectors on the WLAN card.

NOTE:

Table 3. WLAN Antenna Cables

Cable color	Indicator on WLAN
Blue	White triangle
Orange	Black triangle

3. Place the WLAN card bracket to secure the WLAN antenna cables to the WLAN card.
4. Replace the single (M2x3) screw to secure the WLAN bracket and the WLAN card to the palmrest.

Next steps

1. Connect the [battery cable](#).
2. Install the [base cover](#).
3. Install the [SD card](#).
4. Follow the procedure in [after working inside your computer](#).

Solid-state drive

Removing the M.2 2230 Solid-state drive

Prerequisites

1. Follow the procedure in [before working inside your computer](#).
2. Remove the [SD card](#).
3. Remove the [base cover](#).
4. Disconnect the [battery cable](#).

About this task

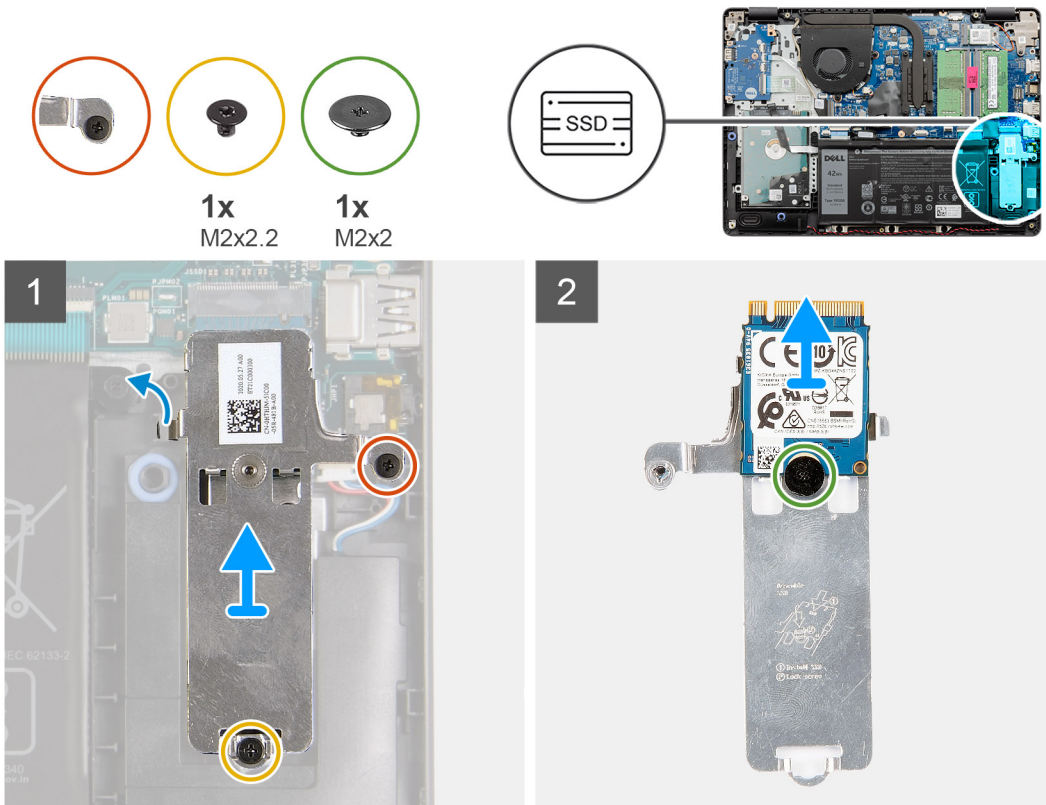

Steps

1. Remove the single (M2x2.2) screw and loosen the single captive screw, securing the SSD thermal plate to the palmrest, to lift it out of the system.
2. Turn the thermal plate over and remove the single (M2x2) screw securing the M.2 2230 SSD to the thermal plate.
3. Lift the solid-state drive off the thermal plate.

Installing the M.2 2230 Solid-state drive

Prerequisites

If you are replacing a component, remove the existing component before performing the installation procedure.

About this task

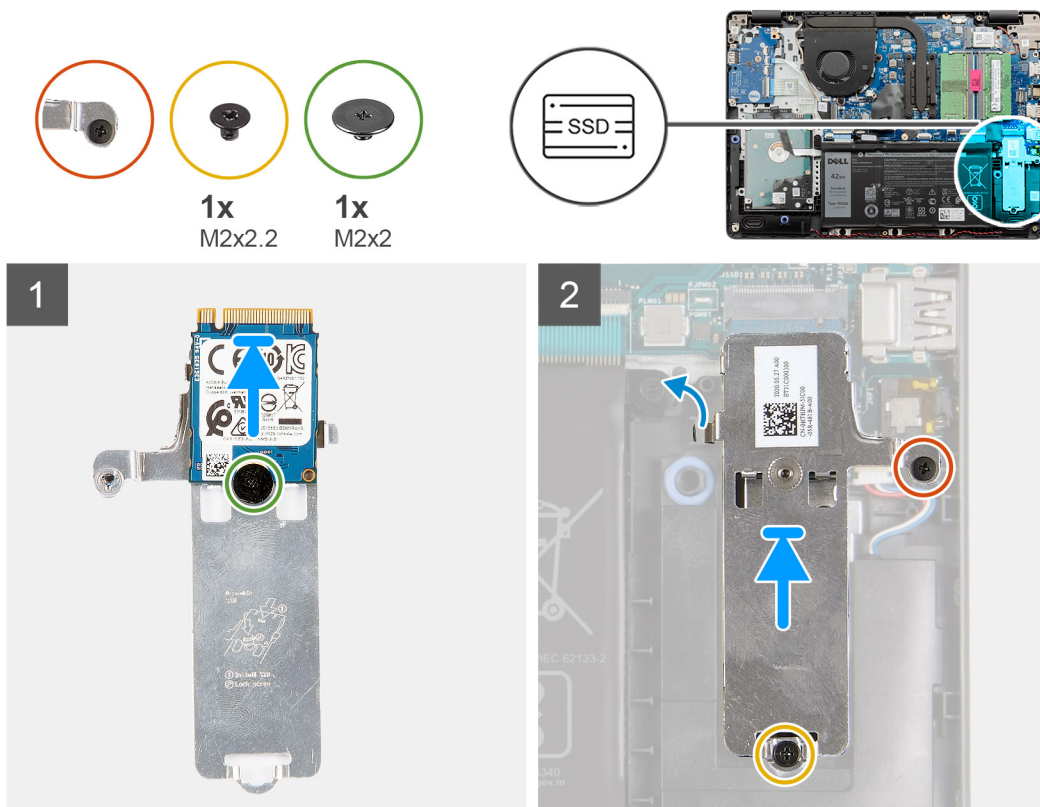

Steps

1. Place the solid-state drive into the thermal plate and install the single (M2x2) screw.
2. Slide and insert the tab of the solid-state drive into the solid-state drive slot.
3. Replace the single (M2x2.2) screw and tighten the single captive screw to secure the thermal plate to the palmrest.

Next steps

1. Connect the [battery cable](#).
2. Install the [base cover](#).
3. Install the [SD card](#).
4. Follow the procedure in [after working inside your computer](#).

Removing the M.2 2280 Solid-state drive

Prerequisites

1. Follow the procedure in [before working inside your computer](#).
2. Remove the [SD card](#).
3. Remove the [base cover](#).
4. Disconnect the [battery cable](#).

About this task

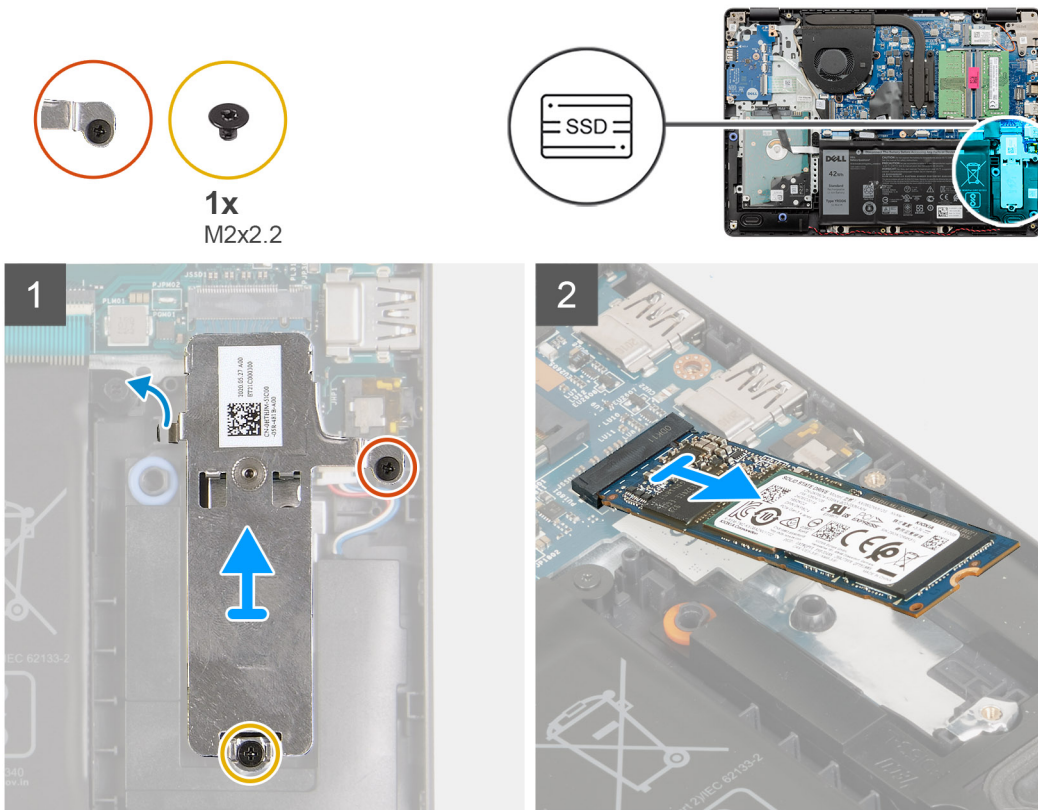

Steps

1. Remove the two (M2x2.2) screw from the thermal bracket and lift the bracket out of the system.
2. Lift the solid-state drive from the M.2 slot on the system board and remove it from the system.

Installing the M.2 2280 Solid-state drive

Prerequisites

If you are replacing a component, remove the existing component before performing the installation procedure.

About this task

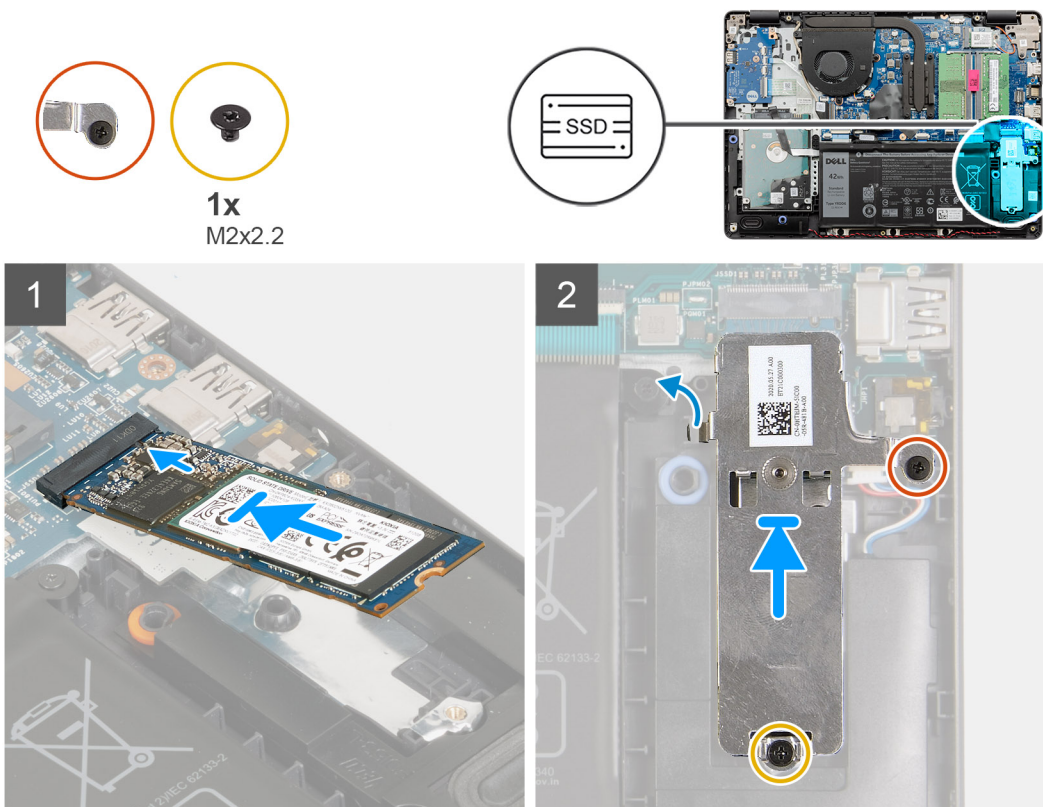

Steps

1. Slide and insert the Solid-state drive into the M.2 port on the system board.
2. Place the thermal bracket on the solid-state drive, replace the two (M2x2.2) screws to secure the thermal plate to the palmrest.

Next steps

1. Connect the [battery cable](#).
2. Install the [base cover](#).
3. Install the [SD card](#).
4. Follow the procedure in [after working inside your computer](#).

Hard drive

Removing the hard drive assembly

Prerequisites

1. Follow the procedure in [before working inside your computer](#).
2. Remove the [SD card](#).
3. Remove the [base cover](#).
4. Remove the [battery](#).

About this task



4x
M2x3



4x
M3x3

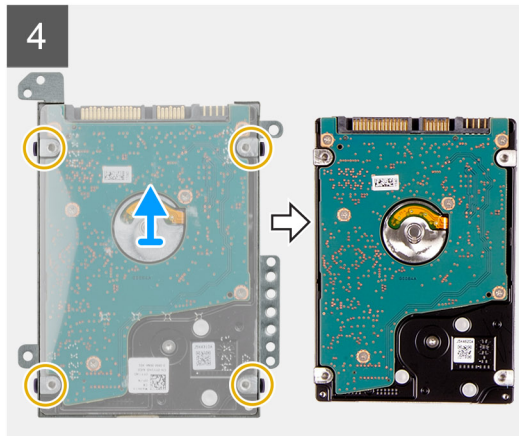
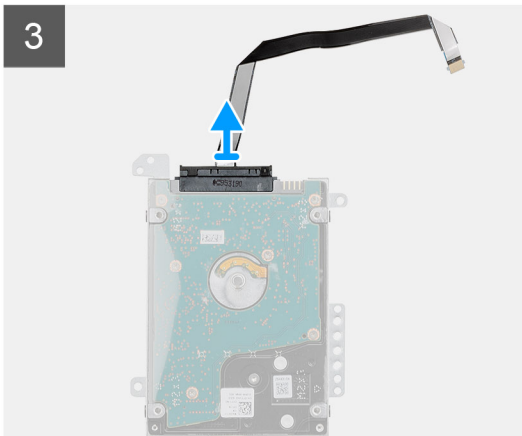
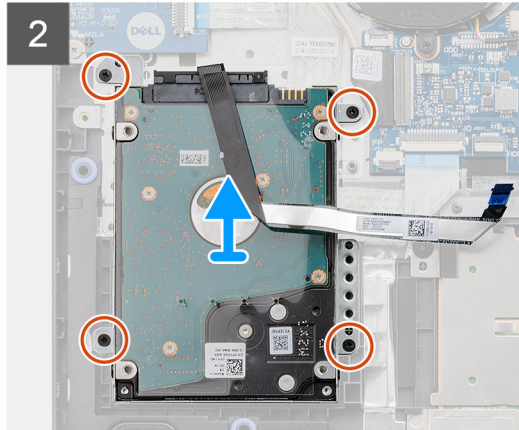
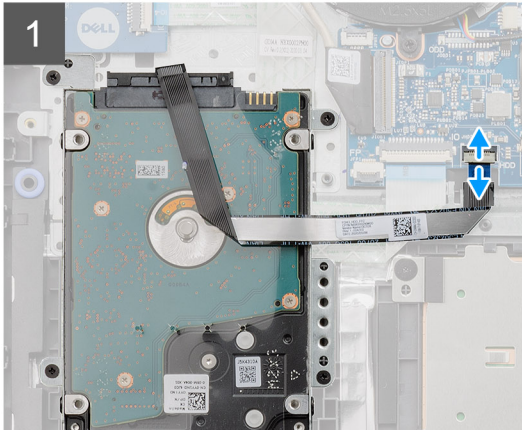
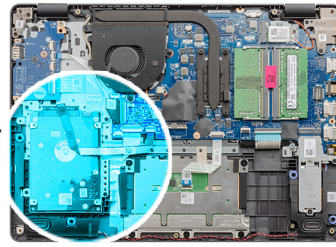

Steps

1. Lift the latch and disconnect the hard drive cable from the system board.
2. Remove the four (M2x3) screws that secure the hard drive assembly to the palmrest and lift the hard drive assembly along with its cable from the system.
3. Disconnect the interposer from the hard drive.
4. Remove the four (M3x3) screws from the hard drive bracket to free the hard drive.

Installing the hard drive assembly

Prerequisites

If you are replacing a component, remove the existing component before performing the installation procedure.

About this task



4x
M2x3



4x
M3x3

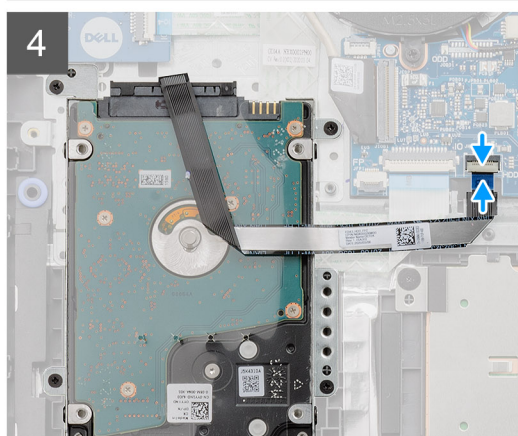
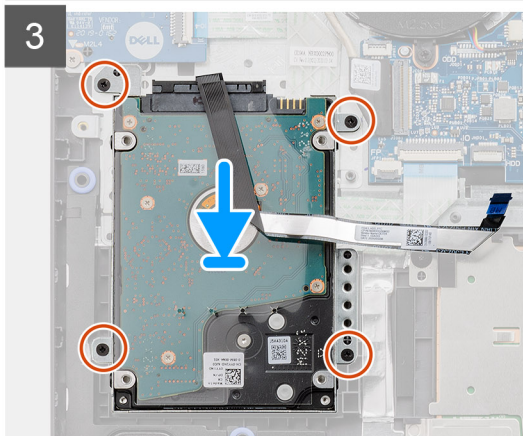
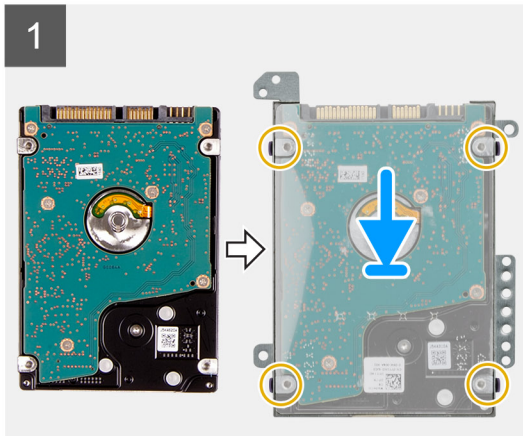
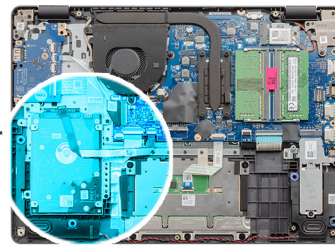

Steps

1. Align the hard drive with the hard drive bracket and replace the four (M3x3) screws.
2. Connect the interposer to the hard drive.
3. Align and place the hard drive assembly on the palmrest, then replace the four (M2x3) screws to secure the hard drive assembly to the palmrest.
4. Connect the hard drive cable to the system board and close the latch to secure the cable.

Next steps

1. Install the [battery](#).
2. Install the [base cover](#).
3. Install the [SD card](#).
4. Follow the procedure in [after working inside your computer](#).

Coin-cell battery

Removing the coin-cell

Prerequisites

1. Follow the procedure in [before working inside your computer](#).
2. Remove the [SD card](#).
3. Remove the [base cover](#).
4. Disconnect the [battery cable](#).
5. Remove the [IO board](#).

 **NOTE:** The Coin-cell is installed on the IO board.

About this task

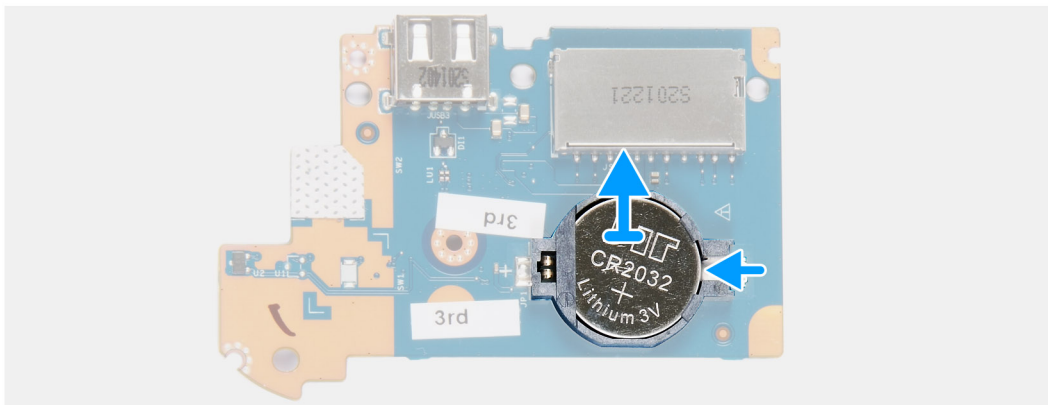
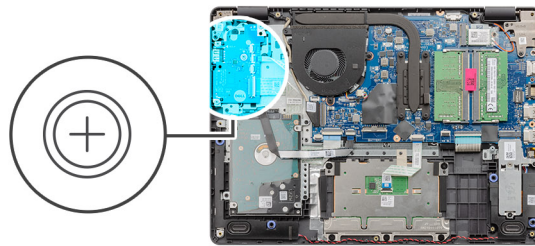

Steps

1. Use a plastic scribe to pry up the coin-cell battery from the slot on the IO daughter board.
2. Remove the coin-cell battery from the IO daughter board.

Installing the coin-cell battery

About this task

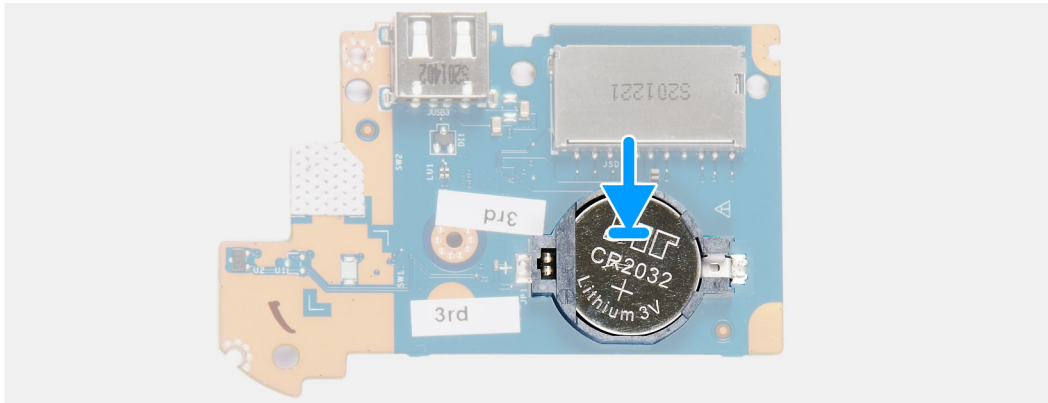
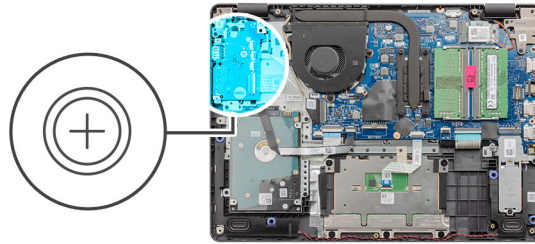

Steps

1. With the positive-side facing up, insert the coin-cell battery into the battery socket on the I/O board.
2. Press the battery until it clicks into place.

Next steps

1. Install the [IO board](#).
2. Connect the [battery cable](#).
3. Install the [base cover](#).
4. Install the [SD card](#).
5. Follow the procedure in [after working inside your computer](#).

System fan

Removing the system fan

Prerequisites

1. Follow the procedure in [before working inside your computer](#).
2. Remove the [SD card](#).
3. Remove the [base cover](#).
4. Disconnect the [battery cable](#).

About this task



2x
M2.5x5

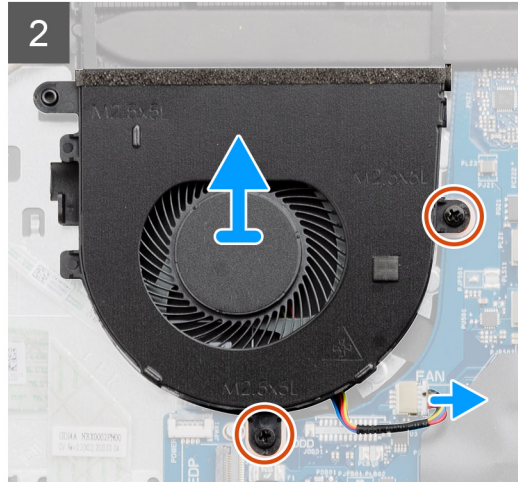
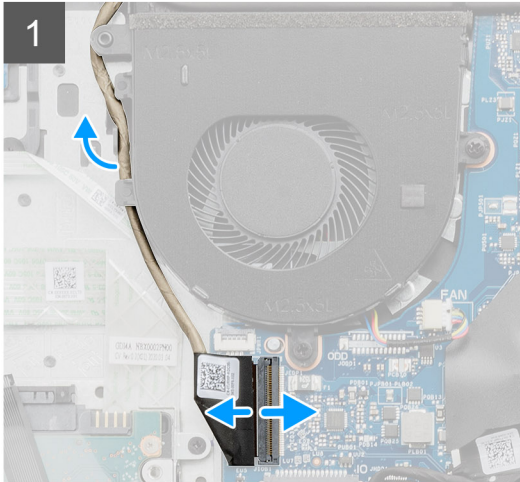
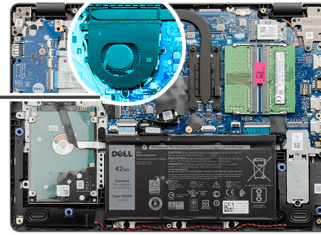
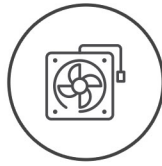

Steps

1. Disconnect the fan cable from the connector on the system board and unthread the cable from the routing points on the fan assembly.
2. Remove the two screws (M2.5x5) that secures the fan to the palmrest.

Installing the system fan

Prerequisites

If you are replacing a component, remove the existing component before performing the installation procedure.

About this task



2x
M2.5x5

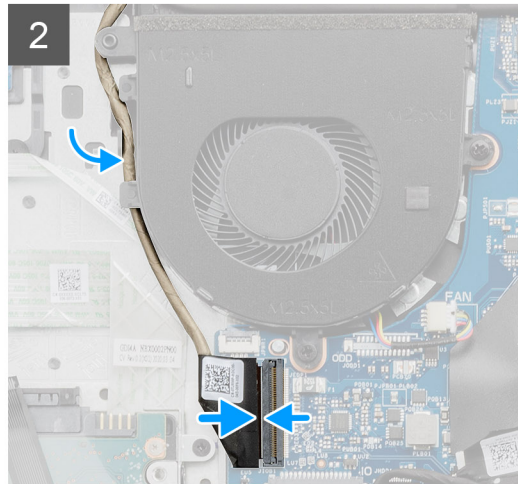
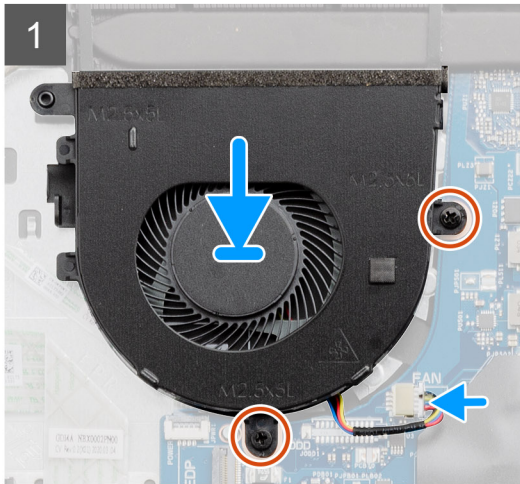
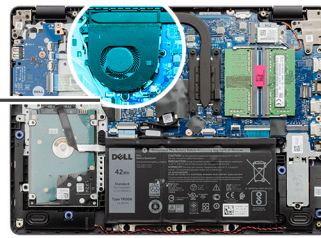
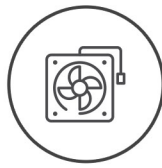

Steps

1. Align and place the fan on the palm rest.
2. Replace the two screws (M2.5x5) that secure the fan to the palmrest.
3. Route the display cable through the routing points on the fan assembly, and connect the fan cable to the connector on the system board.

Next steps

1. Reconnect the [battery cable](#).
2. Replace the [base cover](#).
3. Replace the [SD card](#).
4. Follow the procedure in [after working inside your computer](#).

Heat sink

Removing the Heatsink - UMA

Prerequisites

1. Follow the procedure in [before working inside your computer](#).
2. Remove the [SD card](#).
3. Remove the [base cover](#).
4. Disconnect the [battery cable](#).

About this task

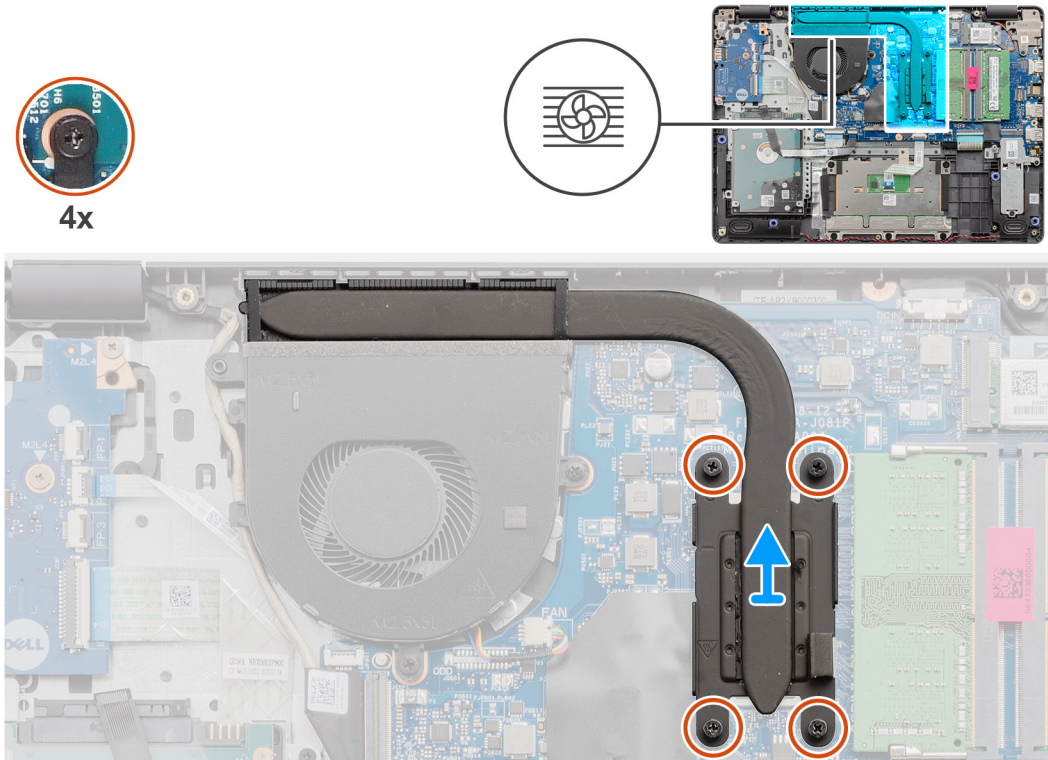

Steps

1. Loosen the four captive screws that secure the heatsink to the system board.
2. Lift the heatsink off the system board.

Installing the Heatsink - UMA

Prerequisites

If you are replacing a component, remove the existing component before performing the installation procedure.

About this task

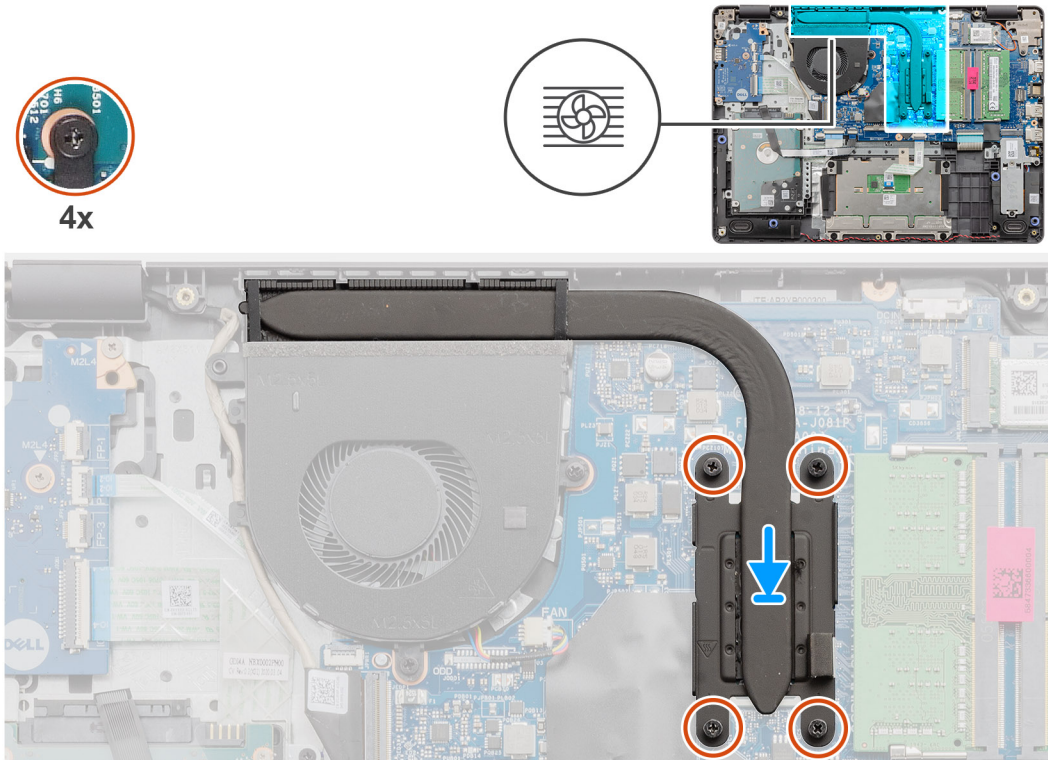

Steps

1. Place the heatsink on the system board and align the captive screws on the heatsink with the screw holes on the system board.
2. Tighten the four captive screws to secure the heatsink to the system board.

Next steps

1. Reconnect the [battery cable](#).
2. Install the [base cover](#).
3. Install the [SD card](#).
4. Follow the procedure in [after working inside your computer](#).

Removing the Heatsink - Discrete

Prerequisites

1. Follow the procedure in [before working inside your computer](#).
2. Remove the [SD card](#).
3. Remove the [base cover](#).
4. Disconnect the [battery cable](#).

About this task

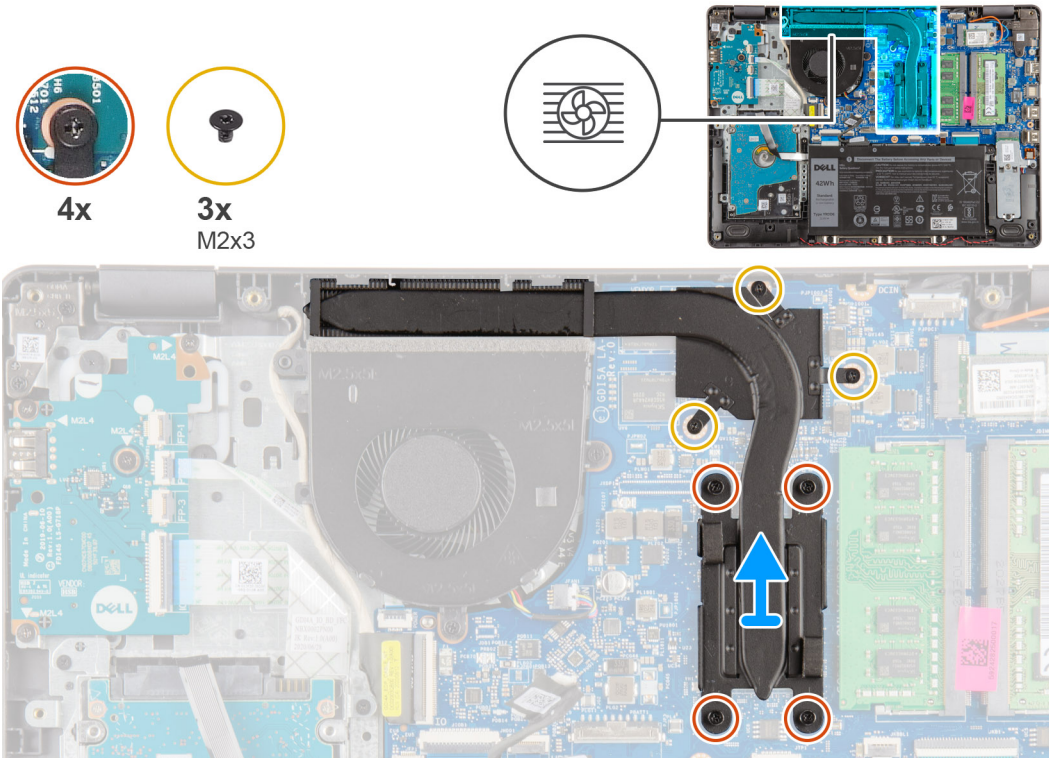

Steps

1. Loosen the four captive screws and remove the three (M2x3) screws that secure the heatsink to the system board.
2. Lift the heatsink off the system board.

Installing the Heatsink - Discrete

Prerequisites

If you are replacing a component, remove the existing component before performing the installation procedure.

About this task

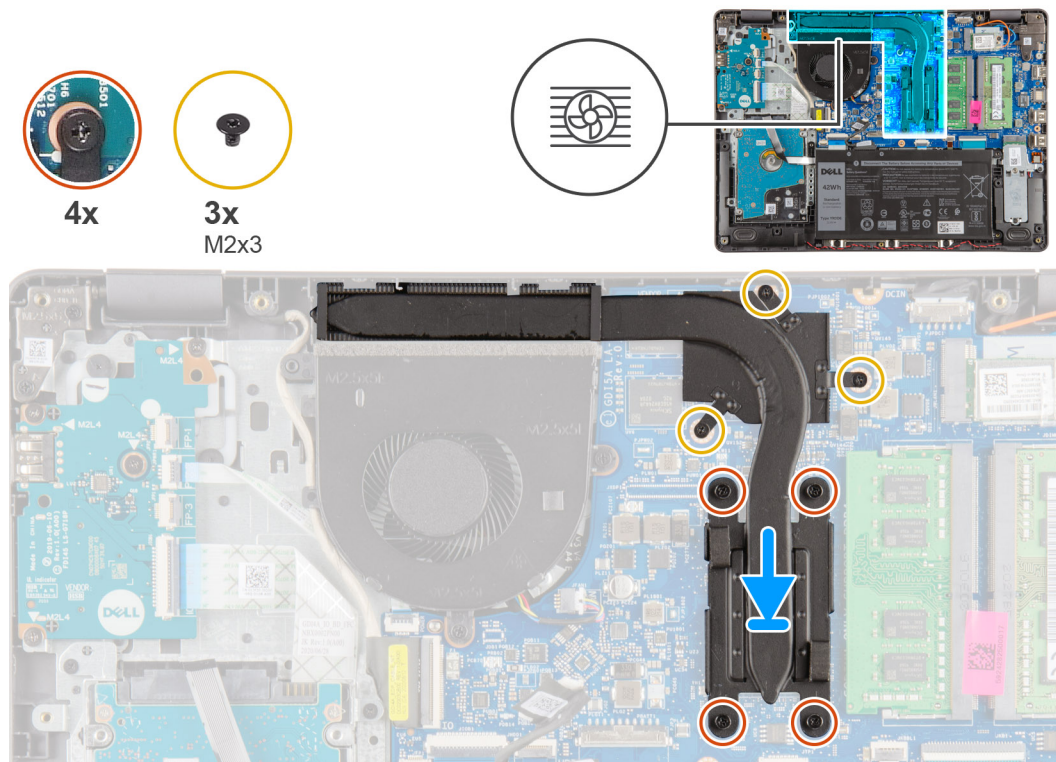

Steps

1. Place the heatsink on the system board and align the captive screws on the heatsink with the screw holes on the system board.
2. Tighten the four captive screws and install the three (M2x4) screws to secure the heatsink to the system board.

Next steps

1. Reconnect the [battery cable](#).
2. Install the [base cover](#).
3. Install the [SD card](#).
4. Follow the procedure in [after working inside your computer](#).

Speakers

Removing the speakers

Prerequisites

1. Follow the procedure in [before working inside your computer](#).
2. Remove the [SD card](#).
3. Remove the [base cover](#).
4. Disconnect the [battery cable](#).
5. Remove the [SSD](#).

About this task

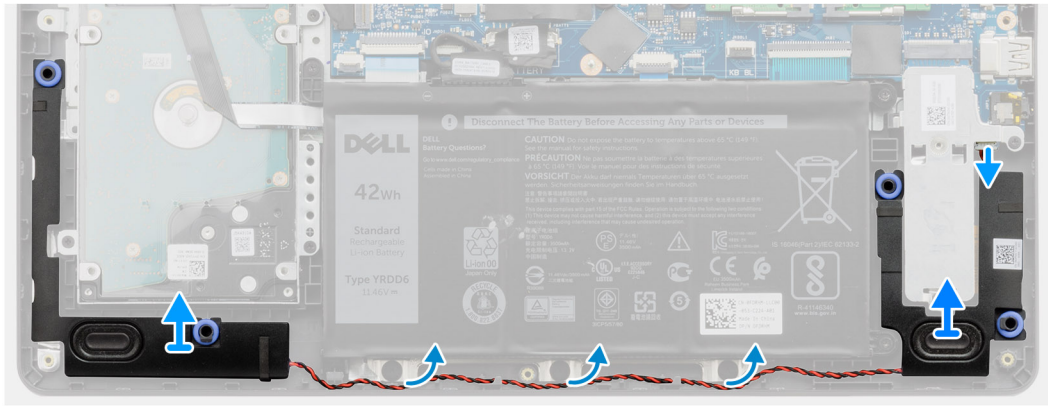
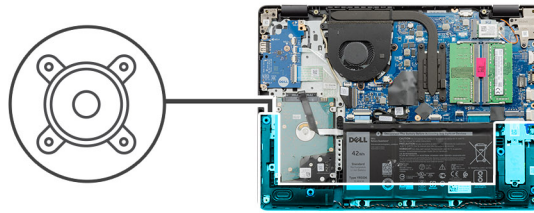

Steps

1. Disconnect the speaker cable from the system board.
2. Unroute and remove the speaker cable from the routing guides on palmrest.
3. Lift the speakers, along with the cable, off the system.

Installing the speakers

Prerequisites

If you are replacing a component, remove the existing component before performing the installation procedure.

About this task

NOTE: If the rubber grommets are pushed out when removing the speakers, push them back in before replacing the speakers.

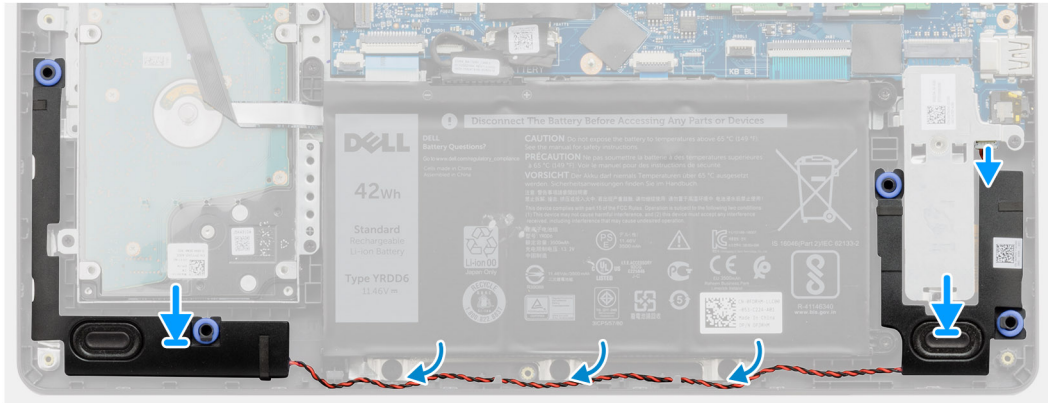
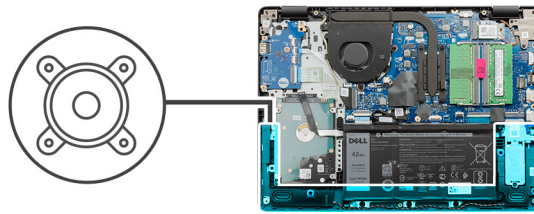

Steps

1. Using the alignment posts and rubber grommets, place the speakers in the slots on the palm rest.
2. Route the speaker cable through the routing guides on the palmrest.
3. Connect the speaker cable to the connector on the system board .

Next steps

1. Install the [SSD](#).
2. Reconnect the [battery cable](#).
3. Install the [base cover](#).
4. Install the [SD card](#).
5. Follow the procedure in [after working inside your computer](#) .

IO board

Removing the IO board

Prerequisites

1. Follow the procedure in [before working inside your computer](#) .
2. Remove the [SD card](#).
3. Remove the [base cover](#).
4. Disconnect the [battery cable](#).

About this task



4x
M2x4

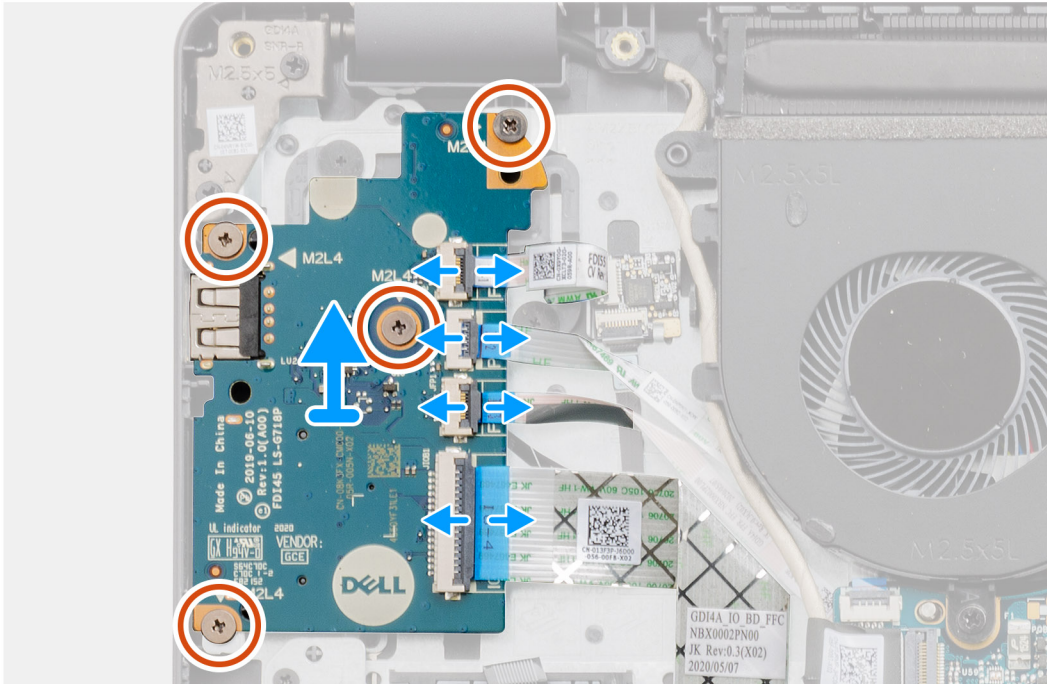

Steps

1. [For models shipped with a fingerprint reader] : Disconnect the fingerprint reader to IO daughter board FFC and IO daughter board to system board FFC from the IO daughter board.
2. [For models shipped without a fingerprint reader] : Disconnect the power button FFC, IO daughter board FFC, and display cable from the system board.
3. Peel back the power button FFC and IO daughter board FFC from the palm rest.
4. Remove the four (M2x4) screws that secure the IO board to the palmrest, and remove the IO board from the system.
5. Disconnect and remove the power button FFC and IO daughter board FFC from the IO daughter board.

Installing the IO board

Prerequisites

If you are replacing a component, remove the existing component before performing the installation procedure.

About this task



4x
M2x4

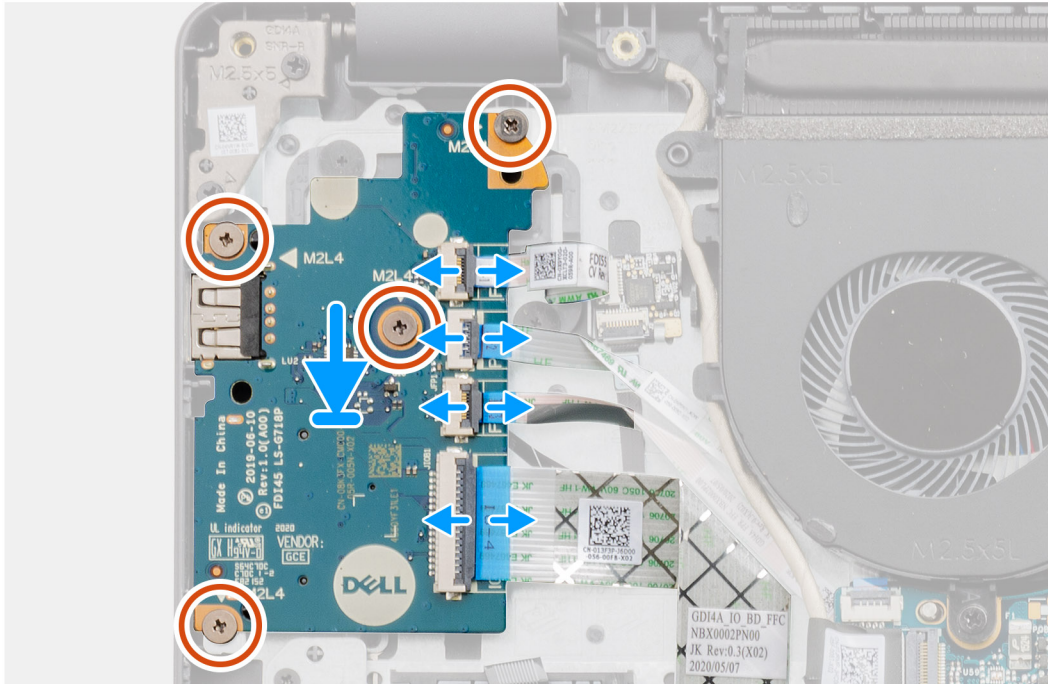
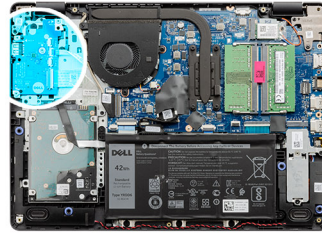

Steps

1. Reconnect the power button FFC and IO daughter board FFC to the IO daughter board.
2. Place the IO daughter board onto the from the system.
3. Replace the four (M2x4) screws to secure the IO daughter board to the palmrest.
4. [For models shipped without a fingerprint reader] : Reconnect the power button FFC, IO daughter board FFC, and display cable to the connectors on the system board.
5. [For models shipped with a fingerprint reader] : Reconnect the fingerprint reader to IO daughter FFC and IO daughter board to system board FFC from the IO daughter board.

Next steps

1. Connect the [battery cable](#).
2. Install the [base cover](#).
3. Install the [SD card](#).
4. Follow the procedure in [after working inside your computer](#).

Touchpad

Removing the touch pad assembly

Prerequisites

1. Follow the procedure in [before working inside your computer](#).

2. Remove the [SD card](#).
3. Remove the [base cover](#).
4. Remove the [battery](#).

About this task



5x
M2x2

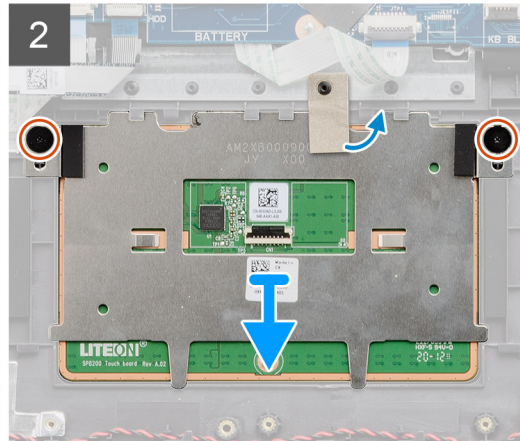
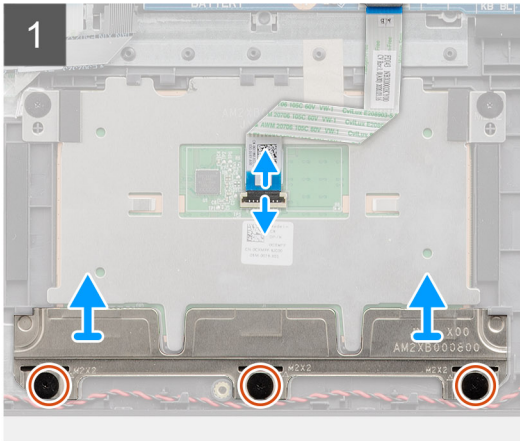
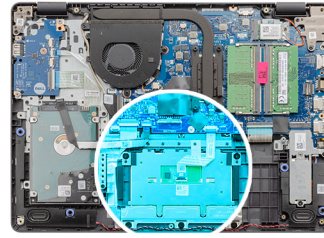

Steps

1. Disconnect the touchpad FFC from the system board.
2. Peel back the conductive tape from the touchpad module.
3. Remove the three (M2x2) screws securing the touchpad bracket in place.
4. Remove the touchpad bracket from the system.
5. Remove the two (M2x2) screws securing the touchpad module in place.
6. Remove the touchpad module with touchpad FFC from the system.
7. Disconnect the touchpad FFC from the touchpad module.

Installing the touch pad assembly

About this task

NOTE: Ensure that the touch pad is aligned with the guides available on the palm-rest and keyboard assembly, and the gap on either sides of the touch pad is equal.



5x
M2x2

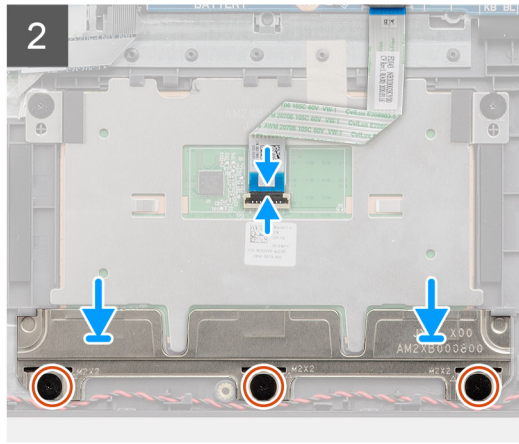
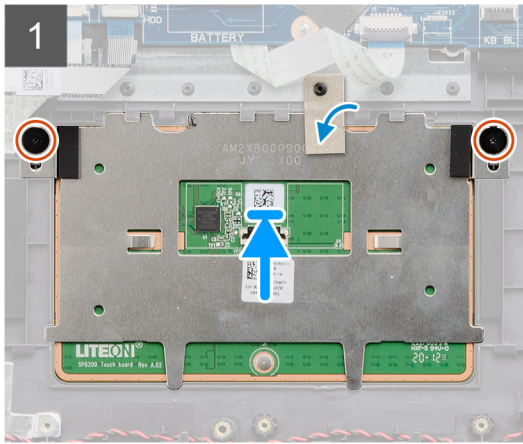
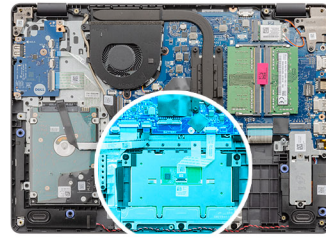

Steps

1. Reconnect the touchpad FFC to the touchpad module.
2. Align and place the touchpad module onto the system.

NOTE: When installing the touchpad bracket on the Vostro 3400, insert its top corners under the two tabs on the palm rest.

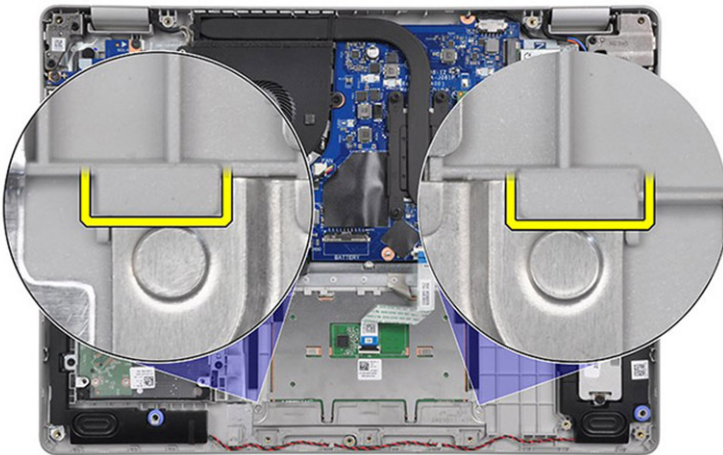

3. Install the two (M2x2) screws to secure the touchpad module to the palmrest.
4. Install the touchpad bracket on the touchpad and secure it using the three (M2x2) screws.
5. Peel back the conductive tape over the touchpad module.
6. Reconnect the touchpad FFC to the system board.

Next steps

1. Install the [battery](#).
2. Install the [base cover](#).
3. Install the [SD card](#).
4. Follow the procedure in [after working inside your computer](#).

Display assembly

Removing the display assembly

Prerequisites

1. Follow the procedure in [before working inside your computer](#).
2. Remove the [SD card](#).
3. Remove the [base cover](#).
4. Disconnect the [battery cable](#).
5. Remove the [WLAN](#).

About this task



4x
M2.5x5

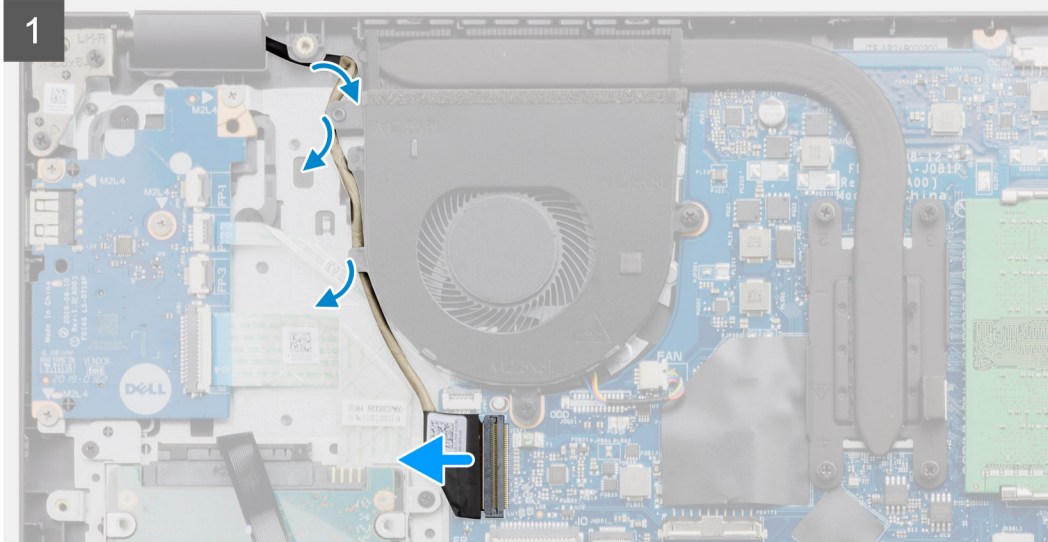
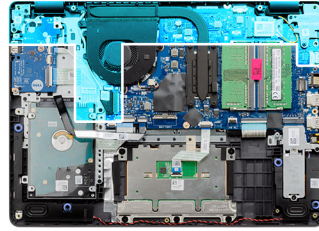

Steps

1. Disconnect the display cable from the connector on the system board.

2. Unthread the display cable and WLAN antenna cables from the routing channels.
3. Open the system to at least 90-degrees and place the system on the edge of a table so that the palm rest is laying flat on the table and the display assembly is over the edge.
4. Remove the four (M2.5x5) screws securing the display assembly in place.
5. Remove the display assembly from the system.

Installing the display assembly

Prerequisites

If you are replacing a component, remove the existing component before performing the installation procedure.

About this task

 **NOTE:** Ensure that the hinges are opened to the maximum before replacing the display assembly on the palmrest and keyboard assembly.



4x
M2.5x5

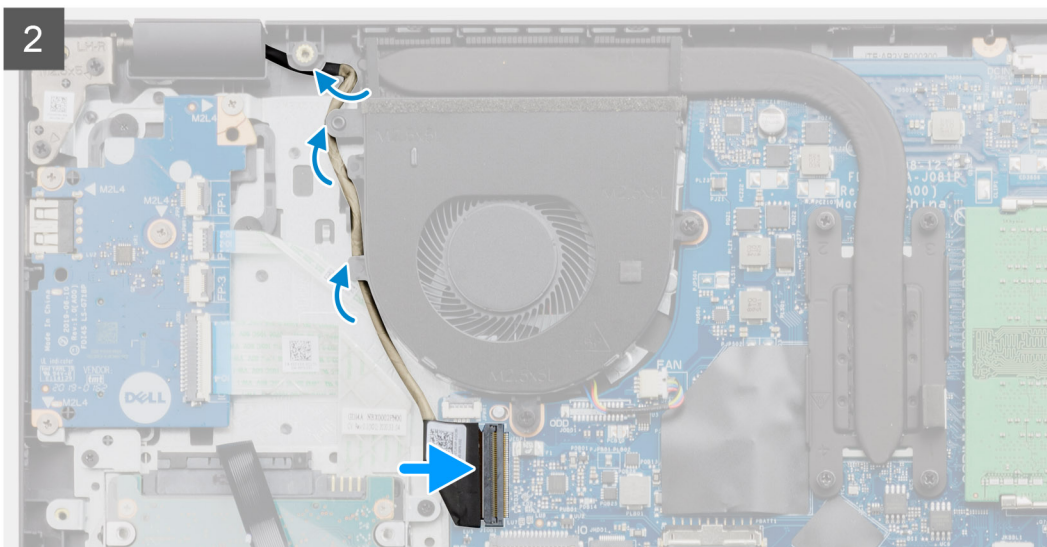
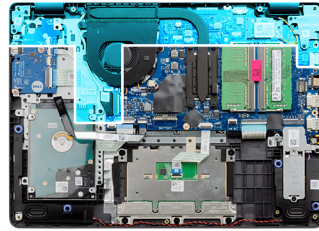

Steps

1. Align and place the system under the hinges on the display assembly.
2. Install the four (M2.5x5) screws securing the display assembly in place.

3. Re-route the display cable and WLAN antenna cables through the routing channels on the palmrest.
4. Reconnect the display cable to the connector on the system board.

Next steps

1. Install the [WLAN](#).
2. Install the [base cover](#).
3. Install the [SD card](#).
4. Follow the procedure in [after working inside your computer](#).

Display bezel

Removing the display bezel

Prerequisites

1. Follow the procedure in [before working inside your computer](#).
2. Remove the [SD card](#).
3. Remove the [base cover](#).
4. Remove the [battery cable](#).
5. Remove the [display assembly](#).

About this task

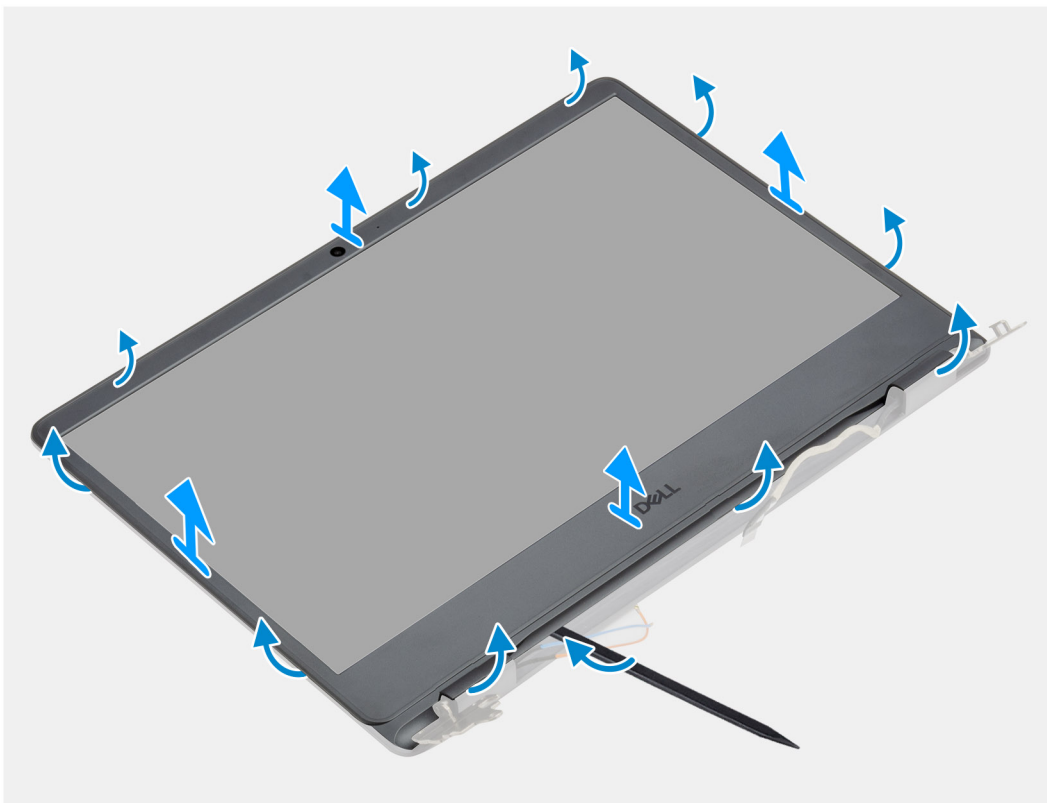

Steps

1. Using a plastic scribe, pry the display bezel from the outer edge to separate it from the display assembly.
2. Lift the display bezel from the display assembly.

Installing the display bezel

Prerequisites

If you are replacing a component, remove the existing component before performing the installation procedure.

About this task

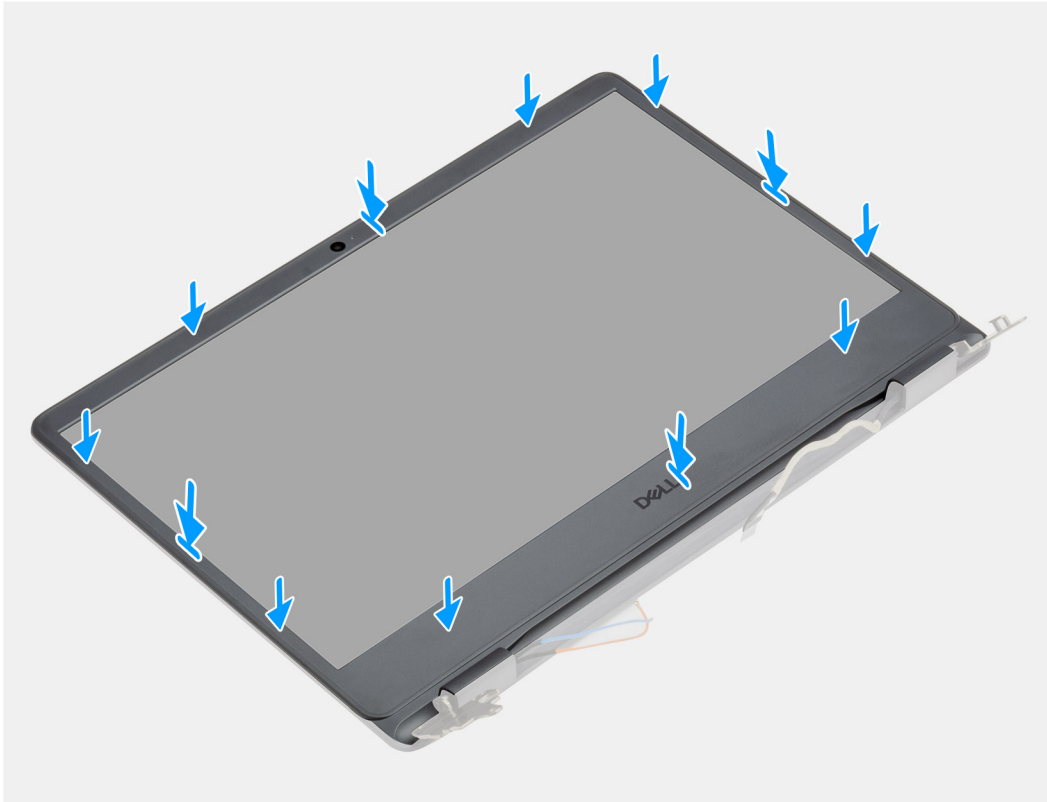

Steps

Align the display bezel with the display back-cover and antenna assembly, and then gently snap the display bezel into place.

Next steps

1. Install the [display assembly](#).
2. Reconnect the [battery cable](#).
3. Install the [base cover](#).
4. Install the [SD card](#).
5. Follow the procedure in [after working inside your computer](#).

Display panel

Removing the display panel

Prerequisites

1. Follow the procedure in [before working inside your computer](#).
2. Remove the [SD card](#).
3. Remove the [base cover](#).
4. Remove the [battery](#).
5. Remove the [WLAN](#).

6. Remove the [display assembly](#).
7. Remove the [display bezel](#).

About this task



6x
M2.5x2.5

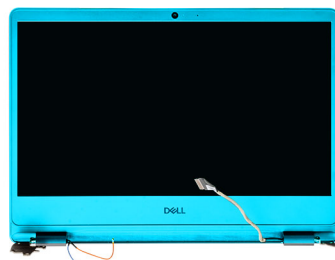

1

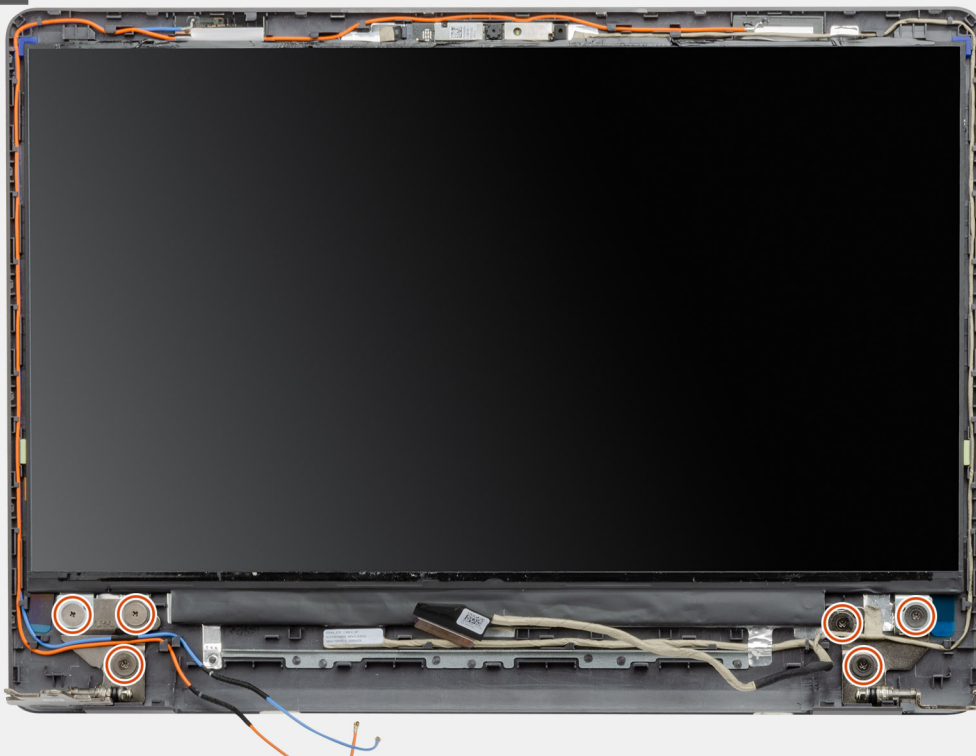

2

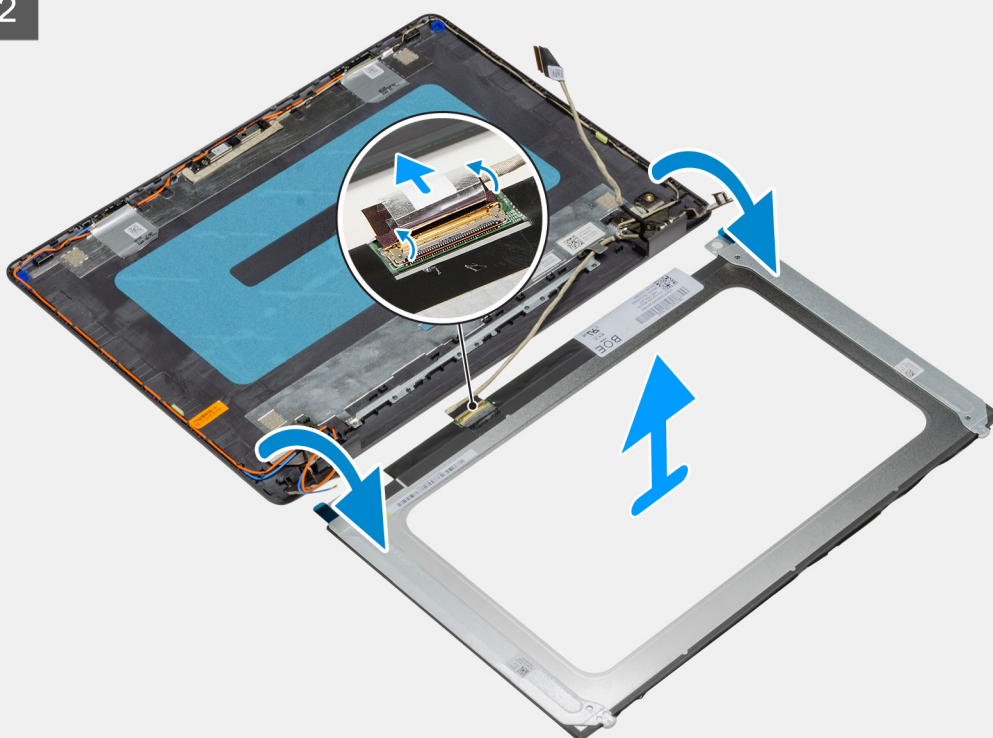

Steps

1. Remove the six (M2.5x2.5) screws securing the display panel to the hinges.
2. Gently flip the display panel assembly forward, peel back the mylar tape securing the display cable on the rear of the display panel.

 **NOTE:** Ensure the panel has a clean and smooth surface to rest on to prevent damage.

3. Disconnect the display cable from the display panel assembly and lift the display panel away from the system.

 **NOTE:** Do not remove the metal brackets from the panel.

Installation display panel

Prerequisites

If you are replacing a component, remove the existing component before performing the installation procedure.

About this task



6x
M2.5x2.5

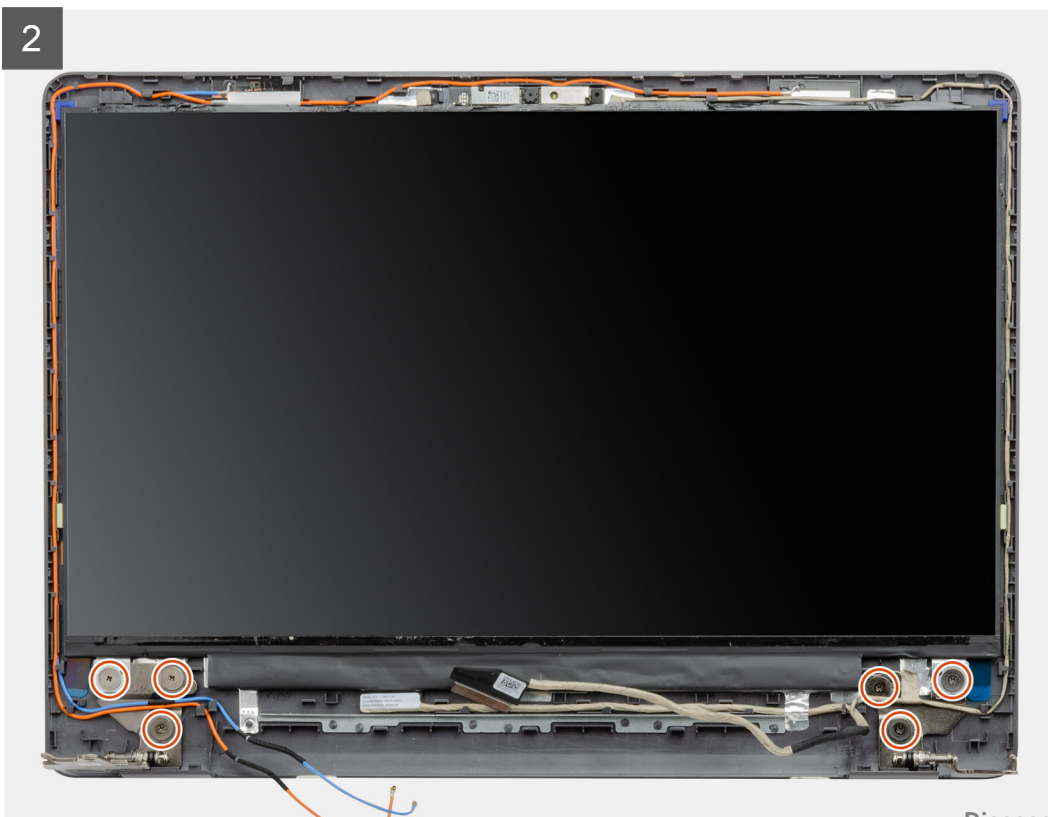
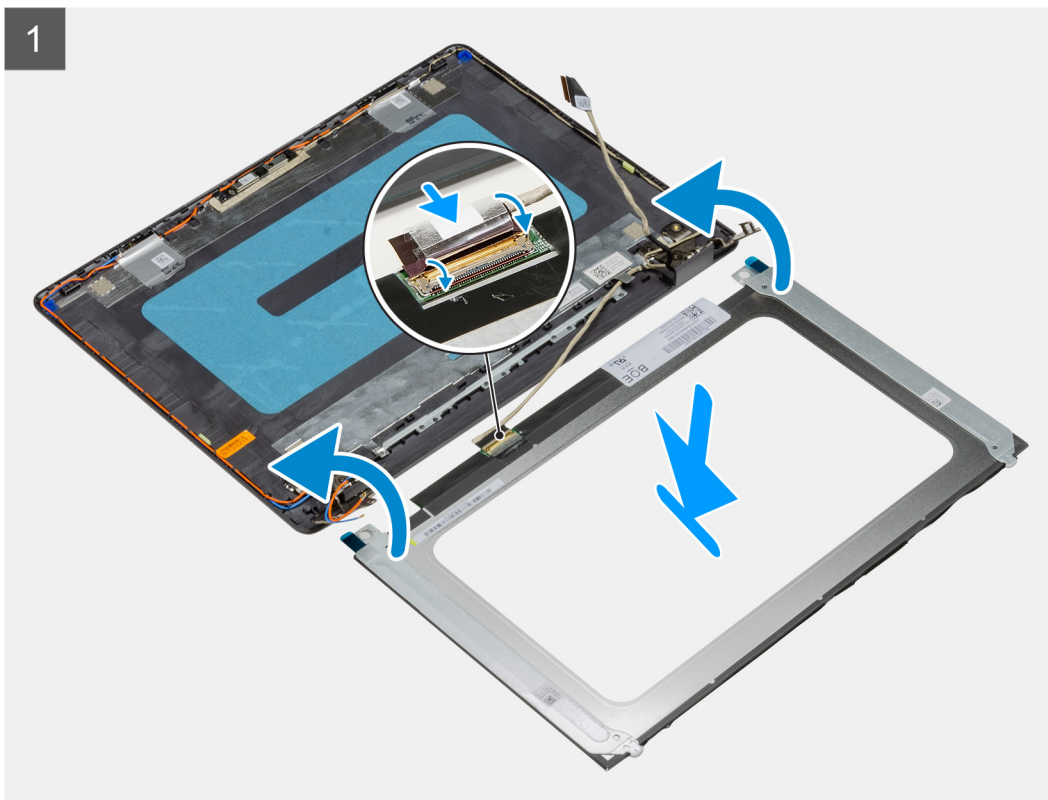
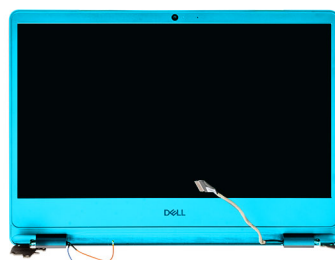

Steps

1. Place the display panel on a flat and clean surface .
2. Connect the display cable to the connector at the back of the display panel and close the latch to secure the cable .
3. Adhere the tape that secures the display cable to the back of the display panel .
4. Turn the display panel over and place it on the display back-cover .
5. Replace the six (M2.5x2.5) screws that secure the display panel to the display back-cover.

Next steps

1. Install the [display bezel](#).
2. Install the [display assembly](#).
3. Install the [WLAN](#).
4. Install the [battery](#).
5. Install the [base cover](#).
6. Install the [SD card](#).
7. Follow the procedure in [after working inside your computer](#).

Camera

Removing the camera

Prerequisites

1. Follow the procedure in [before working inside your computer](#).
2. Remove the [SD card](#).
3. Remove the [base cover](#).
4. Disconnect the [battery cable](#).
5. Remove the [WLAN](#).
6. Remove the [display assembly](#).
7. Remove the [display bezel](#).
8. Remove the [display panel](#).

About this task

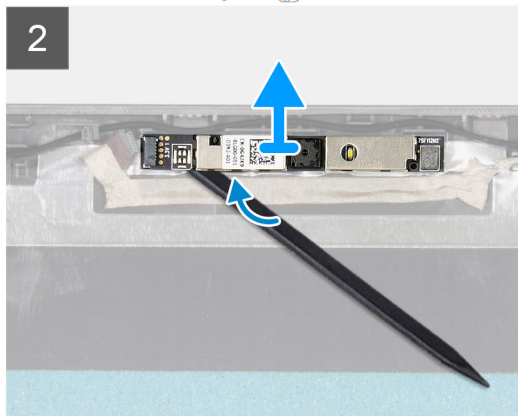
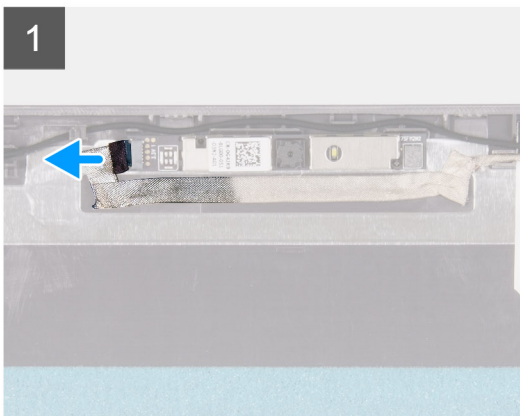
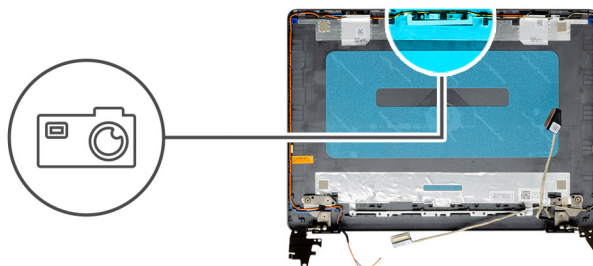

Steps

1. Disconnect the camera cable from the camera module.
2. Using a plastic scribe, gently pry the camera off the display back-cover and antenna assembly.

Installing the camera

Prerequisites

If you are replacing a component, remove the existing component before performing the installation procedure.

About this task

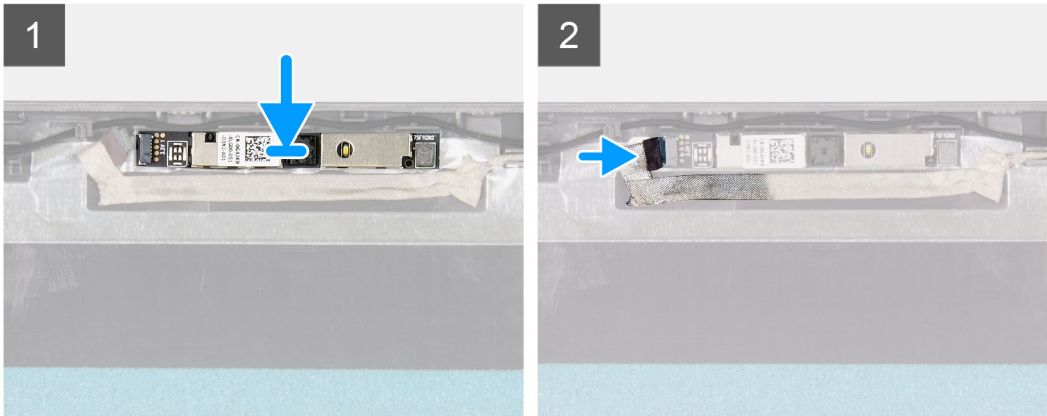
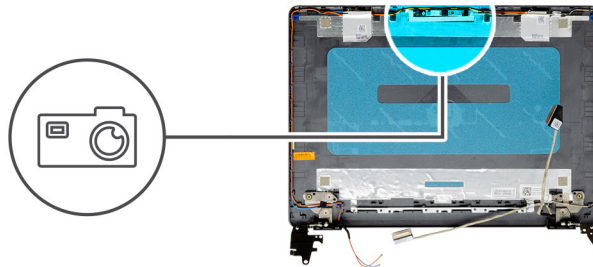

Steps

1. Using the alignment post, adhere the camera module on the display back-cover and antenna assembly.
2. Connect the camera cable to the camera module.

Next steps

1. Install the [display panel](#).
2. Install the [display bezel](#).
3. Install the [display assembly](#).
4. Install the [WLAN](#).
5. Connect the [battery cable](#).
6. Install the [base cover](#).
7. Install the [SD card](#).
8. Follow the procedure in [after working inside your computer](#).

Display back-cover and antenna assembly

Removing the display back-cover

Prerequisites

1. Follow the procedure in [before working inside your computer](#).
2. Remove the [SD card](#).
3. Remove the [base cover](#).
4. Disconnect the [battery cable](#).
5. Remove the [WLAN](#).
6. Remove the [display assembly](#).
7. Remove the [display bezel](#).
8. Remove the [display panel](#).
9. Remove the [camera](#).

About this task

After performing all the preceding steps, you are left with the display back-cover.

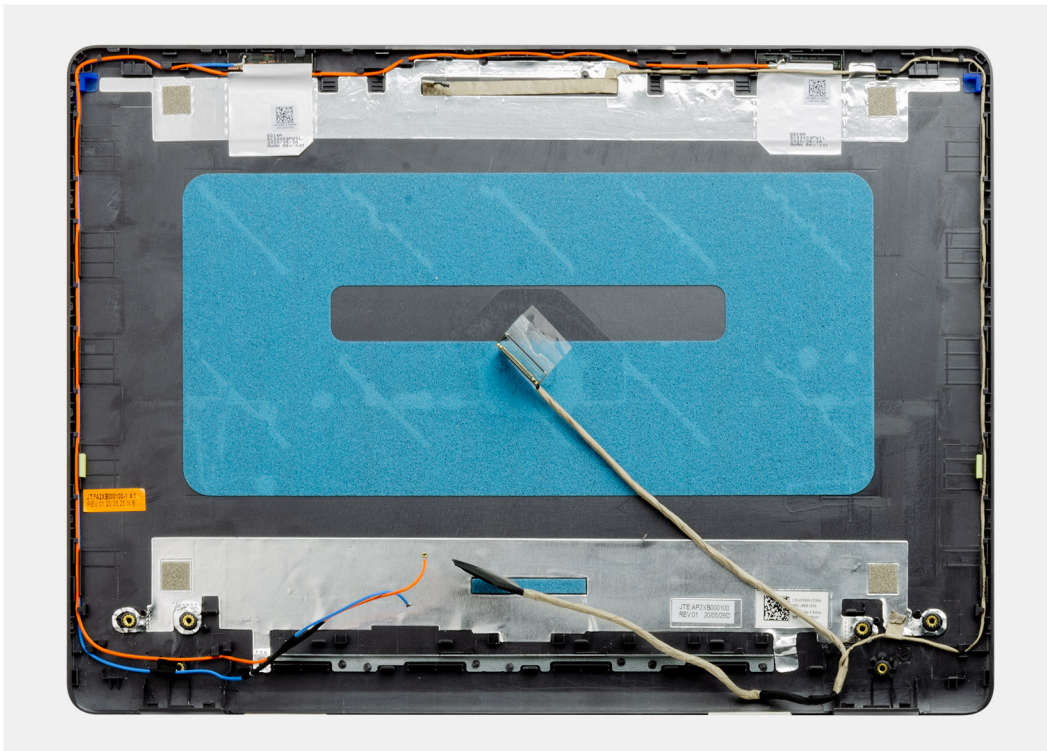

Installing the display back-cover

About this task

Place the display back-cover on a clean and flat surface.

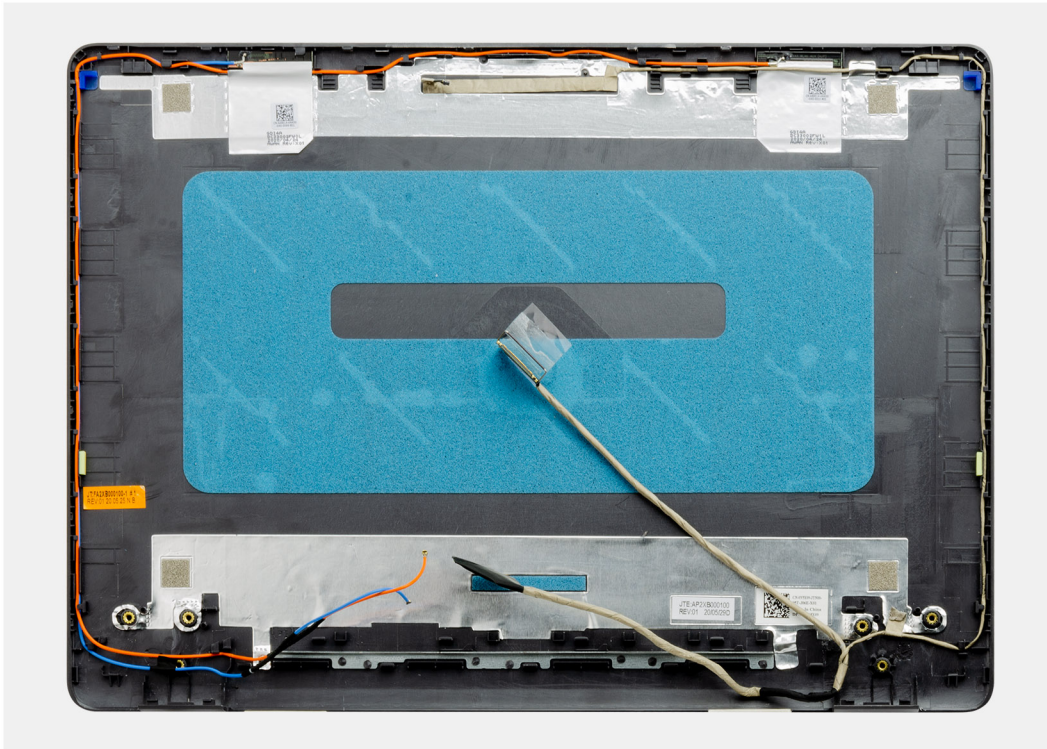

Next steps

1. Install the [camera](#).
2. Install the [display panel](#).
3. Install the [display bezel](#).
4. Install the [display assembly](#).
5. Install the [WLAN](#).
6. Connect the [battery cable](#).
7. Install the [base cover](#).
8. Install the [SD card](#).
9. Follow the procedure in [after working inside your computer](#).

Power button

Removing the power button

Prerequisites

1. Follow the procedure in [before working inside your computer](#).
2. Remove the [SD card](#).
3. Remove the [base cover](#).
4. Disconnect the [battery cable](#).
5. Remove the [IO board](#).

About this task



2x
M2x2

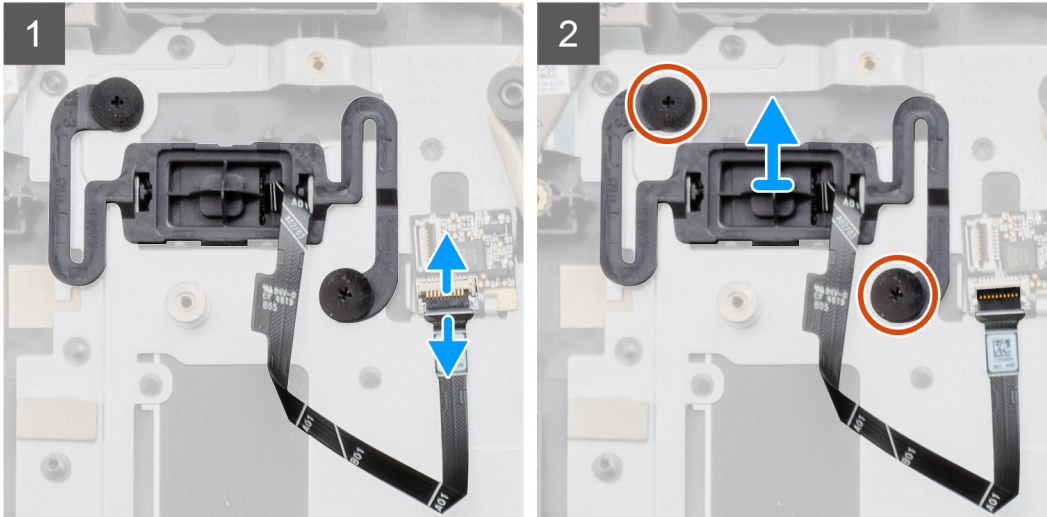
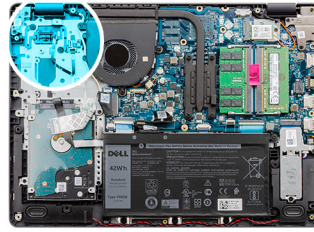

Steps

1. Remove the two (M2x2) screws securing the power button to the palmrest.
2. Disconnect the power button cable and remove the power button from the system.

Installing the power button

Prerequisites

If you are replacing a component, remove the existing component before performing the installation procedure.

About this task



2x
M2x2

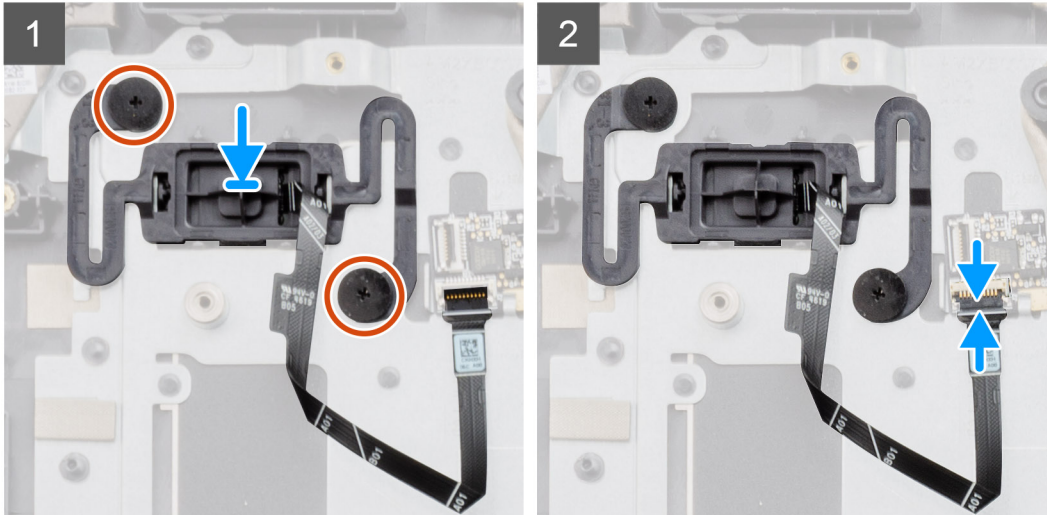
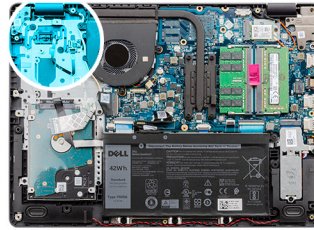

Steps

1. Place the power-button board into the slot on the palmrest.
2. Install the two (M2x2) screws to secure the power button to the palmrest.
3. Connect the power button cable to the connector on the system board.

Next steps

1. Install the [IO board](#).
2. Connect the [battery cable](#).
3. Install the [base cover](#).
4. Install the [SD card](#).
5. Follow the procedure in [after working inside your computer](#).

System board

Removing the system board - Realtek audio

Prerequisites

1. Follow the procedure in [before working inside your computer](#).
2. Remove the [SD card](#).
3. Remove the [base cover](#).
4. Remove the [battery](#).
5. Remove the [WLAN](#).
6. Remove the [SSD](#).
7. Remove the [hard drive assembly](#).
8. Remove the [memory](#)
9. Remove the [system fan](#).

10. Remove the [heatsink](#).

 **NOTE:** The system board can be removed along with the heat sink.

11. Remove the [display assembly](#).

About this task

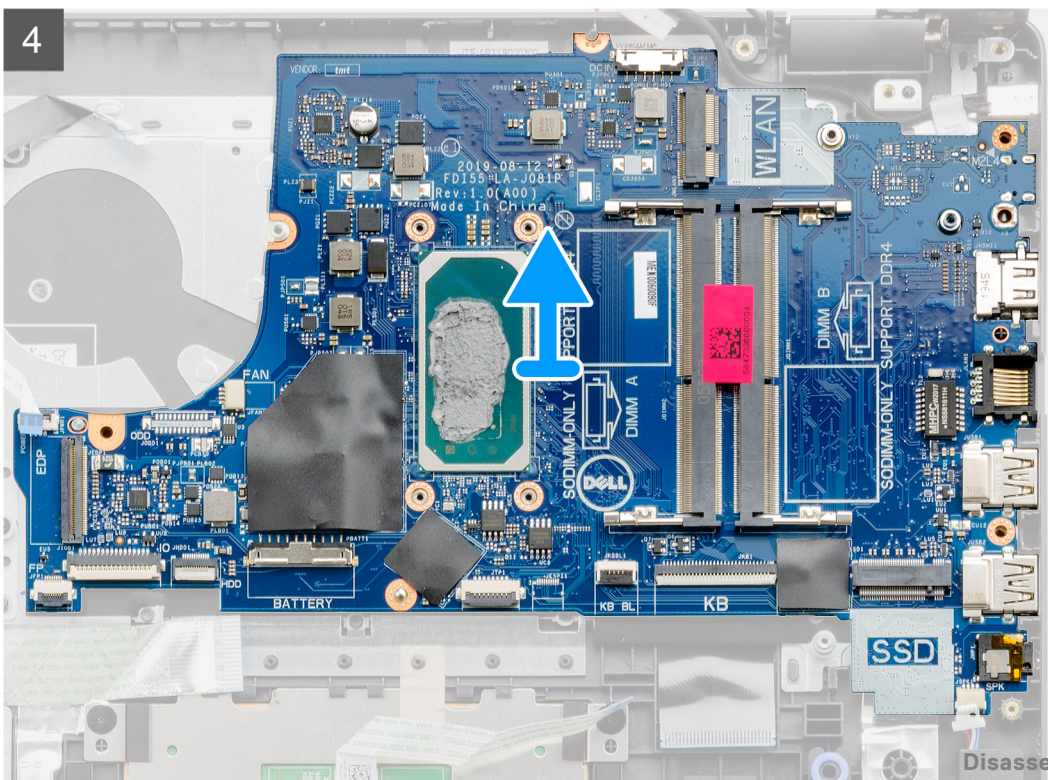
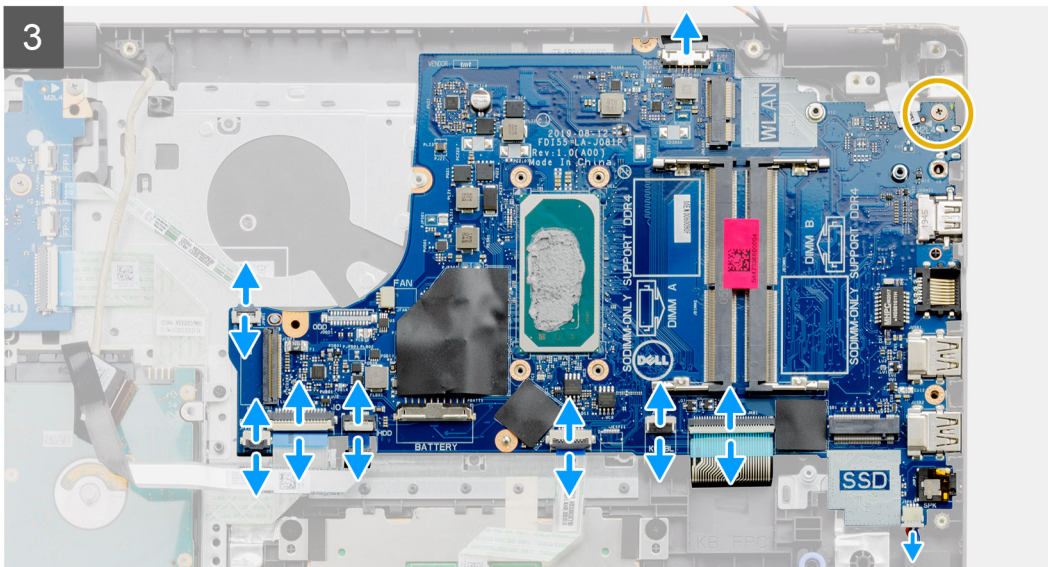
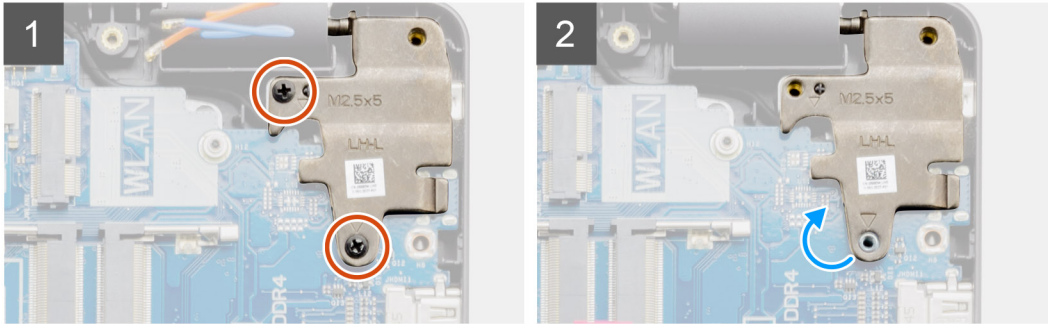
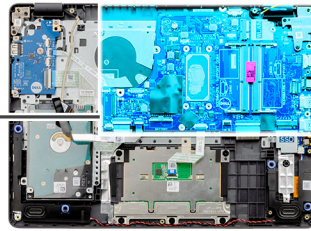

Steps

1. Remove the two (M2.5x5) screws from the right hinge, Fold the right hinge up.
2. Disconnect the following cables from the system board:
 - a. Speaker cable
 - b. Keyboard FFC
 - c. Power adapter port cable
 - d. Keyboard backlight FFC
 - e. Touchpad FFC
 - f. Hard drive FFC
 - g. IO board FFC
 - h. Fingerprint reader FFC
 - i. Power button FFC from the system board
3. Remove the single (M2x4) screw that secures the system board to the palmrest.
4. Carefully lift the system board away from the chassis.

Installing the system board - Realtek audio

Prerequisites

If you are replacing a component, remove the existing component before performing the installation procedure.

About this task

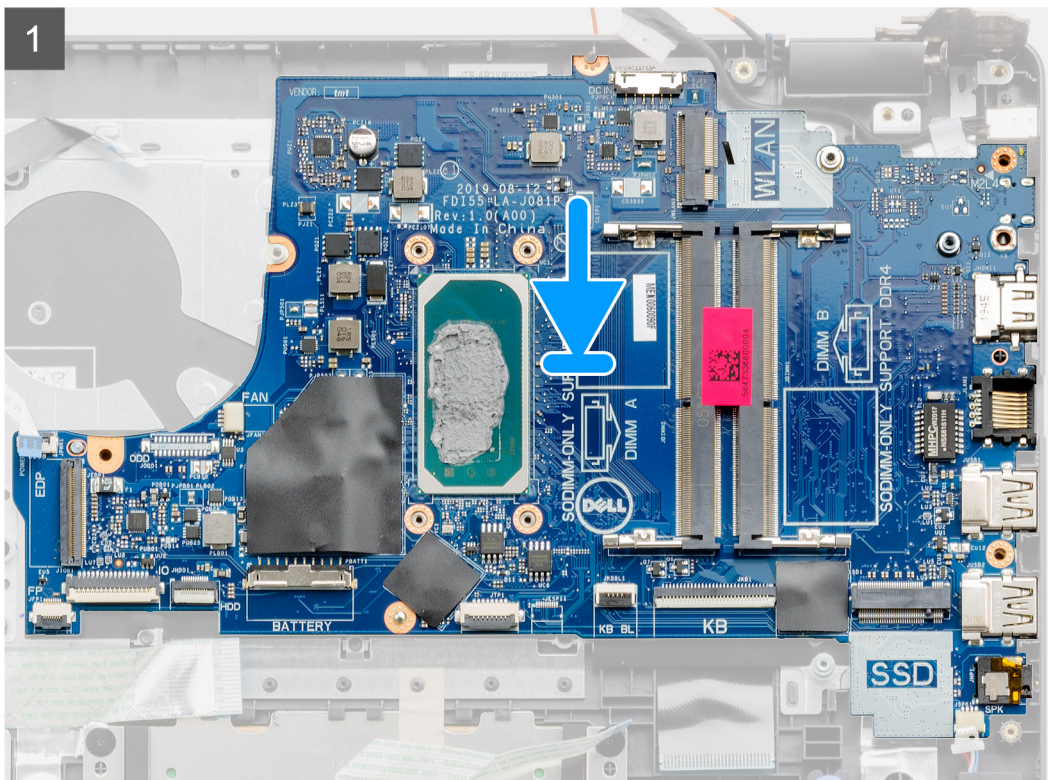
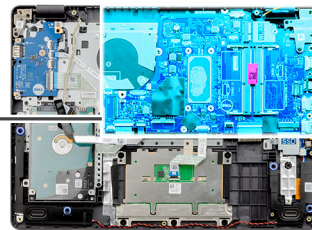

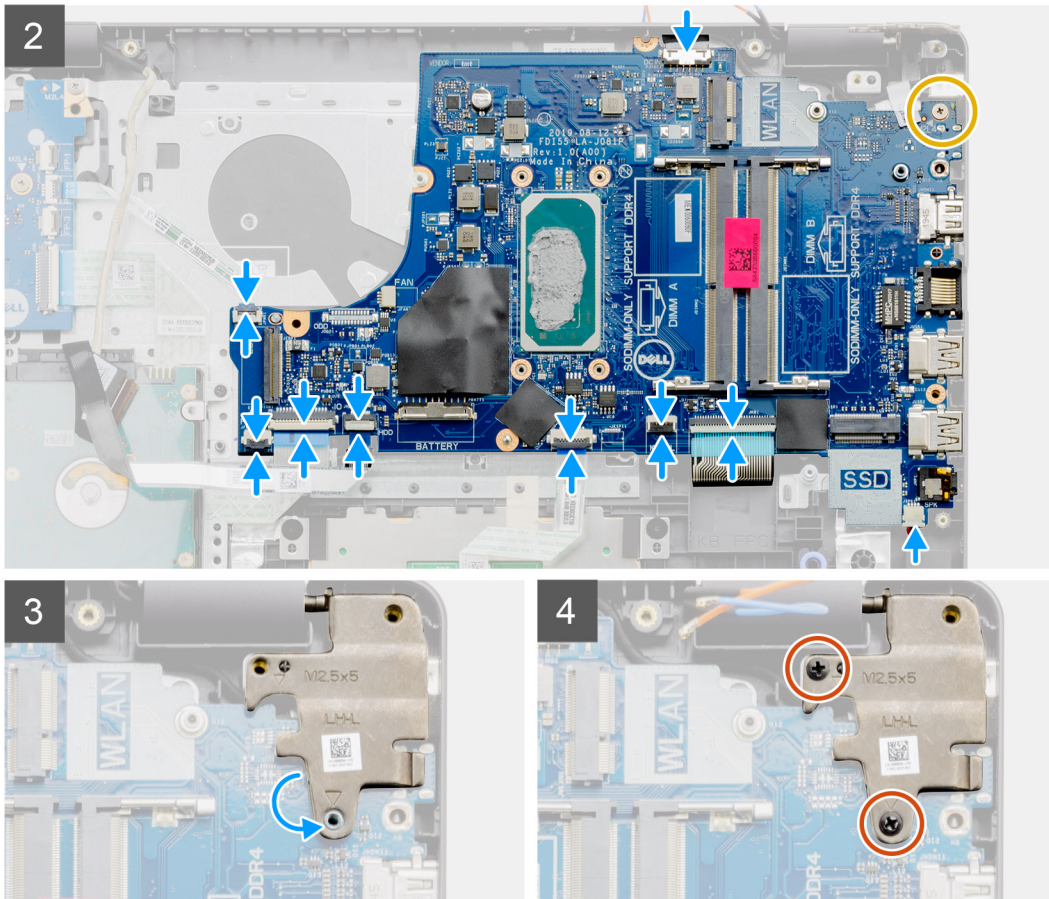

Steps

1. Align and place the system board on the palmrest.
2. Replace the single (M2x4) screw that secures the system board to the palmrest.
3. Connect the following cables to the system board:
 - a. Speaker cable
 - b. Keyboard FFC
 - c. Keyboard backlight FFC
 - d. Touchpad FFC
 - e. Hard drive FFC
 - f. IO board FFC
 - g. Power adapter port cable
 - h. Fingerprint reader FFC
 - i. Power button FFC from the system board
4. Fold back the right hinge and install the two (M2.5x5) screws to secure it to the palmrest.

Next steps

1. Install the [display assembly](#).
2. Install the [heatsink](#).
3. Install the [system fan](#).
4. Install the [memory](#)
5. Install the [SSD](#).
6. Install the [WLAN](#).
7. Install the [battery](#).
8. Install the [base cover](#).
9. Install the [SD card](#).
10. Follow the procedure in [after working inside your computer](#).

Removing the system board - Cirrus Logic audio

Prerequisites

1. Follow the procedure in [before working inside your computer](#).
2. Remove the [SD card](#).
3. Remove the [base cover](#).
4. Remove the [battery](#).
5. Remove the [WLAN](#).
6. Remove the [SSD](#).
7. Remove the [hard drive assembly](#).
8. Remove the [memory](#).
9. Remove the [system fan](#).
10. Remove the [heatsink](#).
 - NOTE:** The system board can be removed along with the heat sink.
11. Remove the [display assembly](#).

About this task

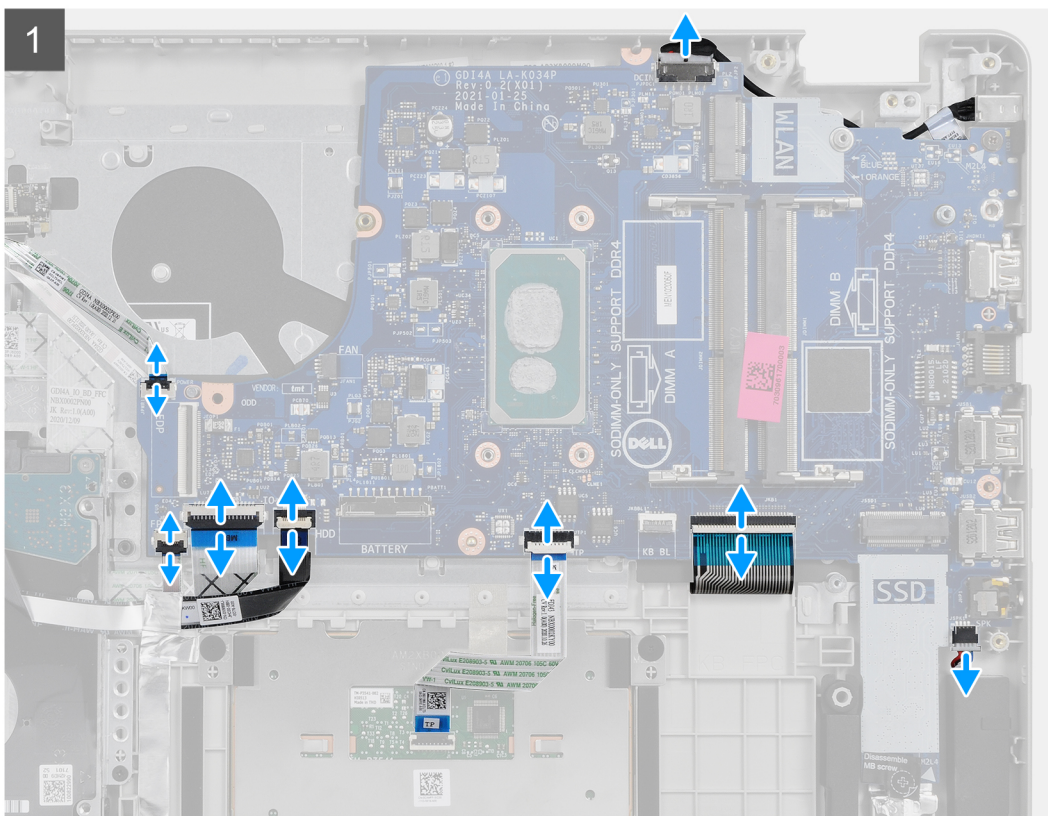
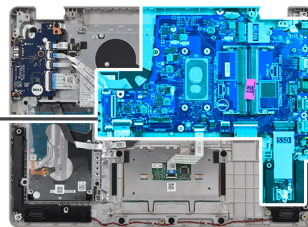

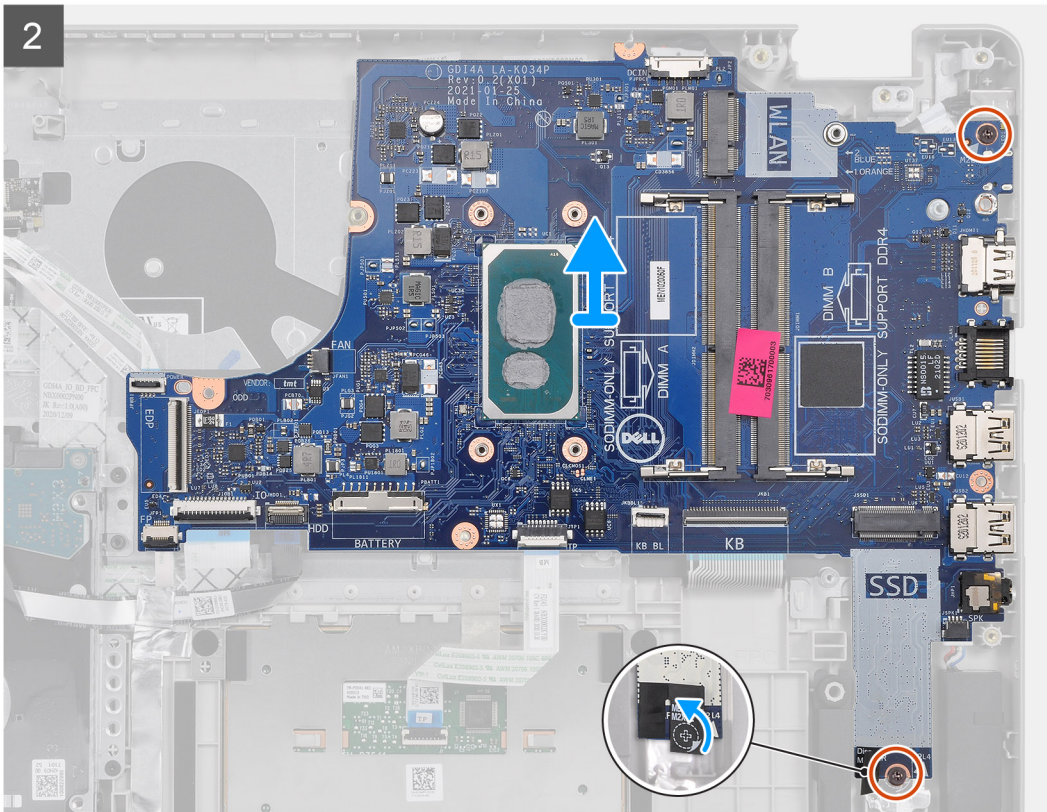

Steps

1. Disconnect the following cables from the system board:
 - a. Speaker cable
 - b. Keyboard FFC
 - c. Power adapter port cable
 - d. Keyboard backlight FFC
 - e. Touchpad FFC
 - f. Hard drive FFC
 - g. IO board FFC
 - h. Fingerprint reader FFC
 - i. Power button FFC from the system board
2. Peel back the Mylar tape from over the screw hole
3. Remove the two (M2x4) screws that secures the system board to the palmrest.
4. Carefully lift the system board away from the chassis.

Installing the system board - Cirrus Logic audio

Prerequisites

If you are replacing a component, remove the existing component before performing the installation procedure.

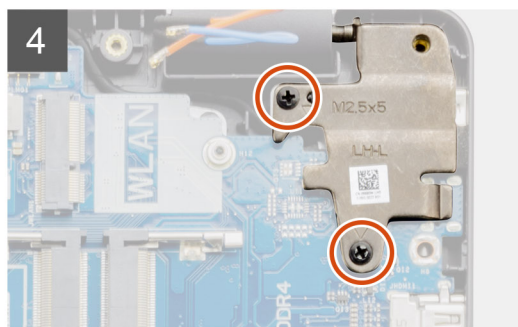
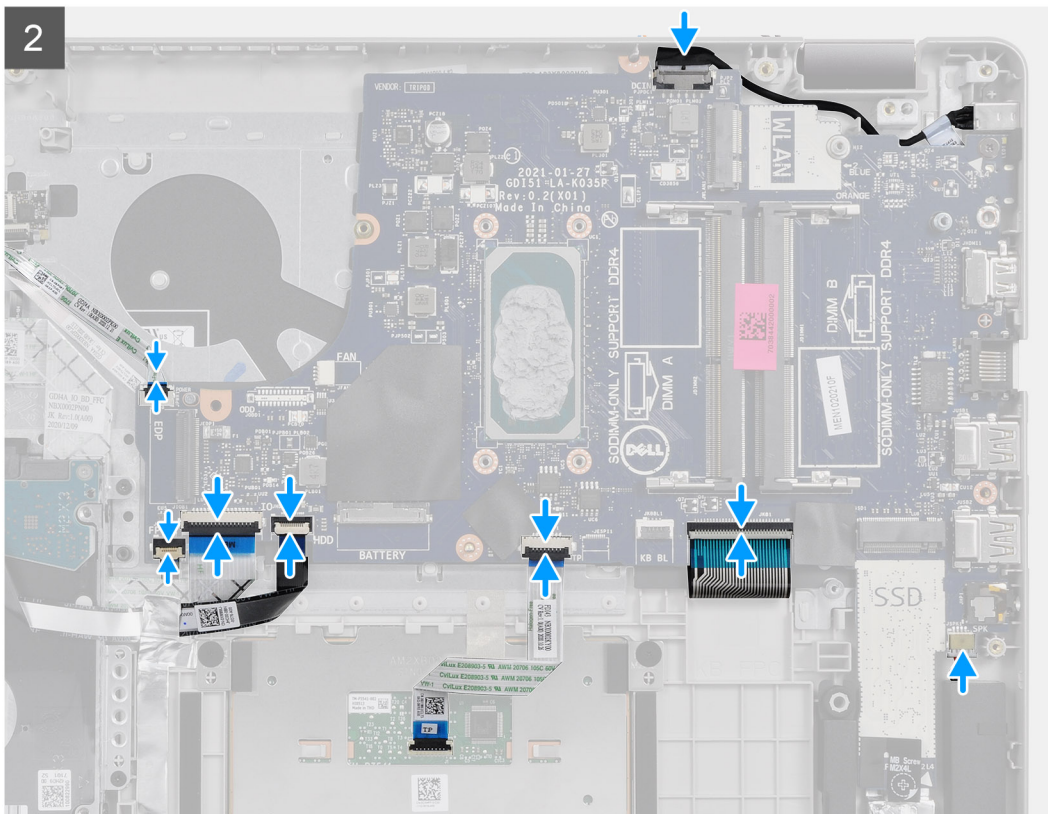

Steps

1. Align and place the system board on the palmrest.
2. Peel back the Mylar tape from over the screw hole.
3. Replace the two (M2x4) screws that secures the system board to the palmrest.
4. Connect the following cables to the system board:
 - a. Speaker cable
 - b. Keyboard FFC
 - c. Keyboard backlight FFC
 - d. Touchpad FFC
 - e. Hard drive FFC
 - f. IO board FFC
 - g. Power adapter port cable
 - h. Fingerprint reader FFC
 - i. Power button FFC from the system board
5. Fold back the right hinge and install the two (M2.5x5) screws to secure it to the palmrest.

Next steps

1. Install the [display assembly](#).
2. Install the [heatsink](#).

3. Install the [system fan](#).
4. Install the [memory](#)
5. Install the [SSD](#).
6. Install the [WLAN](#).
7. Install the [battery](#).
8. Install the [base cover](#).
9. Install the [SD card](#).
10. Follow the procedure in [after working inside your computer](#).

Power-adapter port

Removing the power adapter port

Prerequisites

1. Follow the procedure in [before working inside your computer](#).
2. Remove the [SD card](#).
3. Remove the [base cover](#).
4. Disconnect the [battery cable](#).
5. Remove the [WLAN](#).
6. Remove the [SSD](#).
7. Remove the [system fan](#).
8. Remove the [display assembly](#).
9. Remove the [system board](#)

 **NOTE:** The system board can be removed along with the heat sink.

About this task

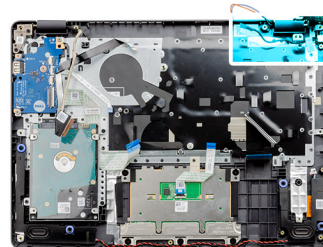

Steps

1. Disconnect and un-route the power adapter port module from the system board.
2. Remove the power adapter port module from the system.

Installing the power adapter port

Prerequisites

If you are replacing a component, remove the existing component before performing the installation procedure.

About this task

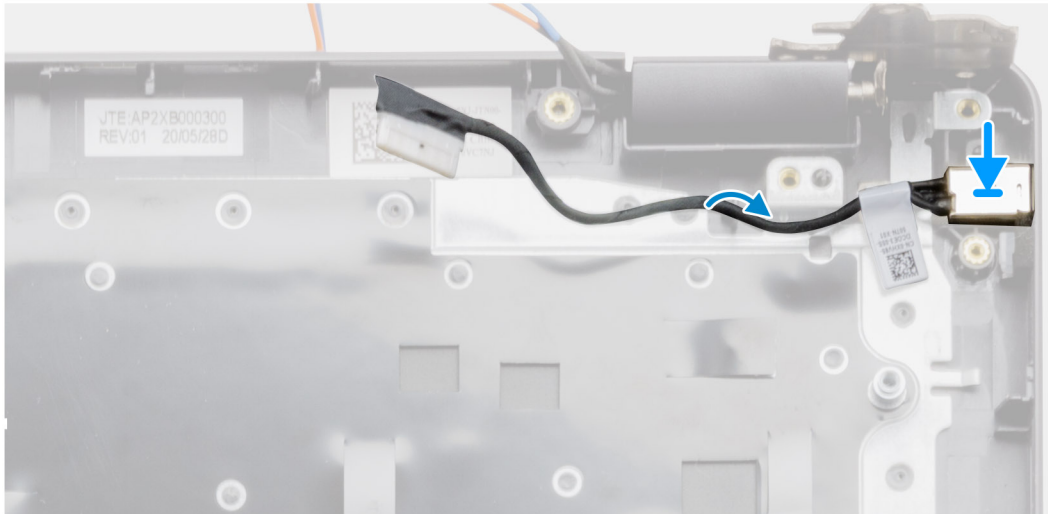
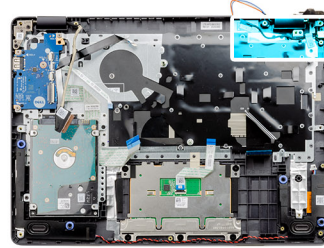

Steps

Place the power adapter port module into the slot provided on the palmrest.

Next steps

1. Install the [system board](#).
2. Install the [display assembly](#).
3. Install the [system fan](#).
4. Install the [SSD](#).
5. Install the [WLAN](#).
6. Connect the [battery cable](#).
7. Install the [base cover](#).
8. Install the [SD card](#).
9. Follow the procedure in [after working inside your computer](#).

Palm-rest and keyboard assembly

Removing the palmrest and keyboard assembly

Prerequisites

1. Follow the procedure in [before working inside your computer](#).
2. Remove the [SD card](#).
3. Remove the [base cover](#).
4. Remove the [battery](#).
5. Remove the [WLAN](#).
6. Remove the [memory](#)
7. Remove the [display assembly](#).
8. Remove the [SSD](#).
9. Remove the [hard drive assembly](#).
10. Remove the [speakers](#).
11. Remove the [coin-cell battery](#).
12. Remove the [system fan](#).
13. Remove the [heatsink](#).

i **NOTE:** The system board can be removed along with the heat sink.

14. Remove the [IO board](#).
15. Remove the [touchpad](#).
16. Remove the [power adapter port](#).
17. Remove the [system board](#).

About this task

i **NOTE:** The system board can be removed and installed together with the heatsink still attached.

After performing the preceding steps, you are left with the palmrest and keyboard assembly.

Palmrest for systems with Realtek Audio:

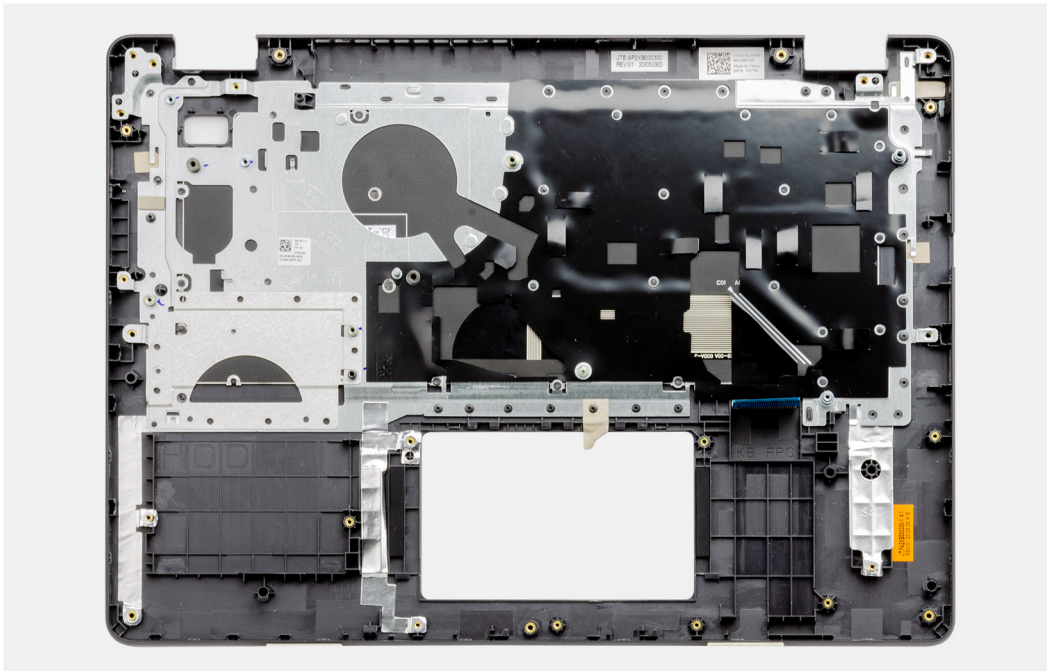

Palmrest for systems with Cirrus Logic audio:

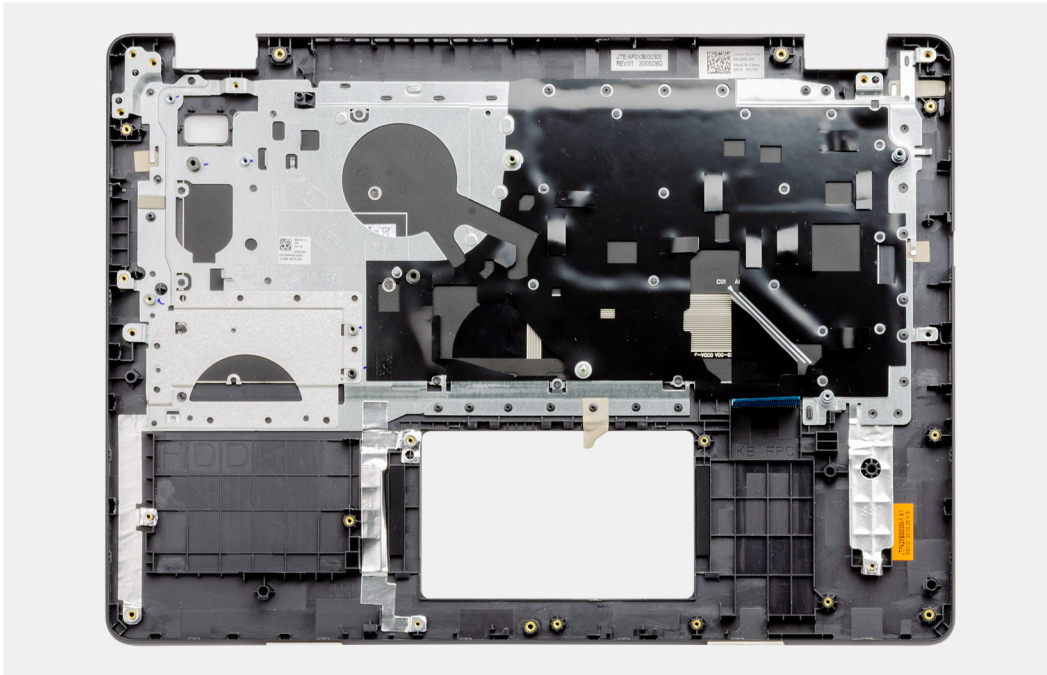

Next steps

1. Install the [system board](#).
2. Install the [power adapter port](#).
3. Install the [touchpad](#).
4. Install the [IO board](#).
5. Install the [heatsink](#).
6. Install the [system fan](#).
7. Install the [coin-cell battery](#).
8. Install the [speakers](#).
9. Install the [hard drive assembly](#).
10. Install the [SSD](#).
11. Install the [display assembly](#).
12. Install the [memory](#)
13. Install the [WLAN](#).
14. Install the [battery](#).
15. Install the [base cover](#).
16. Install the [SD card](#).
17. Follow the procedure in [after working inside your computer](#).

Troubleshooting

Topics:

- [Handling swollen Lithium-ion batteries](#)
- [Locate the Service Tag or Express Service Code of your Dell computer](#)
- [SupportAssist | On-board Diagnostics](#)
- [System diagnostic lights](#)
- [Real-Time Clock \(RTC Reset\)](#)
- [Updating the BIOS in Windows](#)
- [Updating the BIOS using the USB drive in Windows](#)
- [Backup media and recovery options](#)
- [WiFi power cycle](#)
- [Drain residual flea power \(perform hard reset\)](#)

Handling swollen Lithium-ion batteries

Like most laptops, Dell laptops use lithium-ion batteries. One type of lithium-ion battery is the lithium-ion polymer battery. Lithium-ion polymer batteries have increased in popularity in recent years and have become standard in the electronics industry due to customer preferences for a slim form factor (especially with newer ultra-thin laptops) and long battery life. Inherent to lithium-ion polymer battery technology is the potential for swelling of the battery cells.

Swollen battery may impact the performance of the laptop. To prevent possible further damage to the device enclosure or internal components leading to malfunction, discontinue the use of the laptop and discharge it by disconnecting the AC adapter and letting the battery drain.

Swollen batteries should not be used and should be replaced and disposed of properly. We recommend contacting Dell product support for options to replace a swollen battery under the terms of the applicable warranty or service contract, including options for replacement by a Dell authorized service technician.

The guidelines for handling and replacing Lithium-ion batteries are as follows:

- Exercise caution when handling Lithium-ion batteries.
- Discharge the battery before removing it from the system. To discharge the battery, unplug the AC adapter from the system and operate the system only on battery power. When the system will no longer power on when the power button is pressed, the battery is fully discharged.
- Do not crush, drop, mutilate, or penetrate the battery with foreign objects.
- Do not expose the battery to high temperatures, or disassemble battery packs and cells.
- Do not apply pressure to the surface of the battery.
- Do not bend the battery.
- Do not use tools of any type to pry on or against the battery.
- If a battery gets stuck in a device as a result of swelling, do not try to free it as puncturing, bending, or crushing a battery can be dangerous.
- Do not attempt to reassemble a damaged or swollen battery into a laptop.
- Swollen batteries that are covered under warranty should be returned to Dell in an approved shipping container (provided by Dell)—this is to comply with transportation regulations. Swollen batteries that are not covered under warranty should be disposed of at an approved recycling center. Contact Dell product support at <https://www.dell.com/support> for assistance and further instructions.
- Using a non-Dell or incompatible battery may increase the risk of fire or explosion. Replace the battery only with a compatible battery purchased from Dell that is designed to work with your Dell computer. Do not use a battery from other computers with your computer. Always purchase genuine batteries from <https://www.dell.com> or otherwise directly from Dell.

Lithium-ion batteries can swell for various reasons such as age, number of charge cycles, or exposure to high heat. For more information on how to improve the performance and lifespan of the laptop battery and to minimize the possibility of occurrence of the issue, see [Dell Laptop Battery - Frequently Asked Questions](#).

Locate the Service Tag or Express Service Code of your Dell computer

Your Dell computer is uniquely identified by a Service Tag or Express Service Code. To view relevant support resources for your Dell computer, we recommend entering the Service Tag or Express Service Code at www.dell.com/support.

For more information on how to find the Service Tag for your computer, see [Locate the Service Tag for your Dell Laptop](#).

SupportAssist | On-board Diagnostics

About this task

The SupportAssist | On-board Diagnostics performs a complete check of your hardware.

This diagnostic is the new on-board diagnostic tool and replaces the ePSA 3.0 diagnostics. It has a clean and modern user interface, quicker tests, simplified messaging.

SupportAssist | On-board Diagnostics can be initiated by one of the following methods:

- Pressing F12 to enter one-time Boot Menu and selecting Diagnostics to initiate the diagnostics OR Fn + Power
- BIOS POST detecting a hardware failure or error and initiating the diagnostics

The SupportAssist | On-board Diagnostics is embedded with the BIOS and is launched by the BIOS internally. The embedded system diagnostics provides a set of options for particular devices or device groups allowing you to:

- Run tests in either Quick Test Mode or Advanced Test Mode
- Run thorough tests to introduce additional test options to provide extra information about the failed device(s)
- Run tests in either Automatic Mode or Interactive Test Mode
- Run interactive tests on LCD panel and keyboard
- Display or save test results
- View status messages that indicate if the tests are completed successfully
- View error messages that indicate if problems were encountered during the test

NOTE: Some tests for specific devices require user interaction. Ensure that you are present at the computer terminal when the diagnostic tests are performed.

For more information, see [SupportAssist Pre-Boot System Performance Check](#).

System diagnostic lights

Power and battery-status light

Indicates the power and battery-charge status.

Solid white—Power adapter is connected and the battery has more than 5% charge.

Amber—Computer is running on battery and the battery has less than 5% charge.

Off

- Power adapter is connected, and the battery is fully charged.
- Computer is running on battery, and the battery has more than 5% charge.
- Computer is in sleep state, hibernation, or turned off.

The power and battery-status light blinks amber along with beep codes indicating failures.

For example, the power and battery-status light blinks amber two times followed by a pause, and then blinks white three times followed by a pause. This 2,3 pattern continues until the computer is turned off indicating no memory or RAM is detected.

The following table shows different power and battery-status light patterns and associated problems.

Table 4. LED codes

Diagnostic light codes	Problem description	Recommended solutions
1,1	TPM detection failure	Replace the system board.

Table 4. LED codes (continued)

Diagnostic light codes	Problem description	Recommended solutions
1,2	Unrecoverable SPI Flash failure	Replace the system board.
1,3	Short in hinge cable tripped OCP1	Check if the display cable (EDP) is seated properly or pinched at the hinges. If problem persists, replace either display cable (EDP) or display assembly (LCD).
1,4	Short in hinge cable tripped OCP2	Check if the display cable (EDP) is seated properly or pinched at the hinges. If problem persists, replace either display cable (EDP) or display assembly (LCD).
1,5	EC unable to program i-Fuse	Replace the system board.
1,6	Generic catch-all for ungraceful EC code flow errors	Disconnect all power source (AC, battery, coin cell) and drain flea power by pressing & holding down power button.
2,1	Processor failure	Run the Intel CPU diagnostics tools. If problem persists, replace the system board.
2,2	System board: BIOS or ROM (Read-Only Memory) failure	Flash latest BIOS version. If problem persists, replace the system board.
2,3	No memory or RAM (Random-Access Memory) detected	Confirm that the memory module is installed properly. If problem persists, replace the memory module.
2,4	Memory or RAM (Random-Access Memory) failure	Reset and swap memory modules amongst the slots. If problem persists, replace the memory module.
2,5	Invalid memory installed	Reset and swap memory modules among the slots. If problem persists, replace the memory module.
2,6	System-board or chipset error	Flash latest BIOS version. If problem persists, replace the system board.
2,7	LCD failure - SBIOS message	Replace display vable (EDP) if possible, otherwise replace the display assembly (LCD).
2,8	LCD failure - EC detection of power rail failure	Replace the system board.
3,1	Coin-cell battery failure	Reset the CMOS battery connection. If problem persists, replace the RTC battery.
3,2	PCI, video card/chip failure	Replace the system board.
3,3	Recovery image not found	Flash latest BIOS version. If problem persists, replace the system board.
3,4	Recovery image found but invalid	Flash latest BIOS version. If problem persists, replace the system board.
3,5	Power-rail failure	EC ran into power sequencing failure. If problem persists, replace the system board.
3,6	System BIOS Flash incomplete	Flash corruption detected by SBIOS. If problem persists, replace the system board.
3,7	Management Engine (ME) error	Timeout waiting on ME to reply to HECI message. If problem persists, replace the system board.

Camera status light: Indicates whether the camera is in use.

- Solid white—Camera is in use.
- Off—Camera is not in use.

Caps Lock status light: Indicates whether Caps Lock is enabled or disabled.

- Solid white—Caps Lock enabled.
- Off—Caps Lock disabled.

Real-Time Clock (RTC Reset)

The Real Time Clock (RTC) reset function allows you or the service technician to recover Dell Latitude systems from No POST/No Power/No Boot situations. The legacy jumper enabled RTC reset has been retired on these models.

Start the RTC reset with the system powered off and connected to AC power. Press and hold the power button for thirty (30) seconds. The system RTC Reset occurs after you release the power button.

Updating the BIOS in Windows

Steps

1. Go to www.dell.com/support.
2. Click **Product support**. In the **Search support** box, enter the Service Tag of your computer, and then click **Search**.
 **NOTE:** If you do not have the Service Tag, use the SupportAssist feature to automatically identify your computer. You can also use the product ID or manually browse for your computer model.
3. Click **Drivers & Downloads**. Expand **Find drivers**.
4. Select the operating system installed on your computer.
5. In the **Category** drop-down list, select **BIOS**.
6. Select the latest version of BIOS, and click **Download** to download the BIOS file for your computer.
7. After the download is complete, browse the folder where you saved the BIOS update file.
8. Double-click the BIOS update file icon and follow the on-screen instructions.
For more information, see knowledge base article [000124211](https://www.dell.com/support/000124211) at www.dell.com/support.

Updating the BIOS using the USB drive in Windows

Steps

1. Follow the procedure from step 1 to step 6 in [Updating the BIOS in Windows](#) to download the latest BIOS setup program file.
2. Create a bootable USB drive. For more information, see the knowledge base article [000145519](https://www.dell.com/support/000145519) at www.dell.com/support.
3. Copy the BIOS setup program file to the bootable USB drive.
4. Connect the bootable USB drive to the computer that needs the BIOS update.
5. Restart the computer and press **F12**.
6. Select the USB drive from the **One Time Boot Menu**.
7. Type the BIOS setup program filename and press **Enter**.
The **BIOS Update Utility** appears.
8. Follow the on-screen instructions to complete the BIOS update.

Backup media and recovery options

It is recommended to create a recovery drive to troubleshoot and fix problems that may occur with Windows. Dell proposes multiple options for recovering Windows operating system on your Dell PC. For more information, see [Dell Windows Backup Media and Recovery Options](#).

WiFi power cycle

About this task

If your computer is unable to access the internet due to WiFi connectivity issues a WiFi power cycle procedure may be performed. The following procedure provides the instructions on how to conduct a WiFi power cycle:

 **NOTE:** Some ISPs (Internet Service Providers) provide a modem/router combo device.

Steps

1. Turn off your computer.
2. Turn off the modem.
3. Turn off the wireless router.
4. Wait for 30 seconds.
5. Turn on the wireless router.
6. Turn on the modem.
7. Turn on your computer.

Drain residual flea power (perform hard reset)

About this task

Flea power is the residual static electricity that remains in the computer even after it has been powered off and the battery is removed.

For your safety, and to protect the sensitive electronic components in your computer, you are requested to drain residual flea power before removing or replacing any components in your computer.

Draining residual flea power, also known as a performing a "hard reset", is also a common troubleshooting step if your computer does not power on or boot into the operating system.

To drain residual flea power (perform a hard reset)

Steps

1. Turn off your computer.
2. Disconnect the power adapter from your computer.
3. Remove the base cover.
4. Remove the battery.
5. Press and hold the power button for 20 seconds to drain the flea power.
6. Install the battery.
7. Install the base cover.
8. Connect the power adapter to your computer.
9. Turn on your computer.



 **NOTE:** For more information about performing a hard reset, see the knowledge base article [000130881](https://www.dell.com/support) at www.dell.com/support.

Getting help and contacting Dell

Self-help resources

You can get information and help on Dell products and services using these self-help resources:

Table 5. Self-help resources

Self-help resources	Resource location
Information about Dell products and services	www.dell.com
My Dell	
Tips	
Contact Support	In Windows search, type Contact Support , and press Enter.
Online help for operating system	www.dell.com/support/windows www.dell.com/support/linux
Troubleshooting information, user manuals, setup instructions, product specifications, technical help blogs, drivers, software updates, and so on.	www.dell.com/support
Dell knowledge base articles for a variety of computer concerns.	<ol style="list-style-type: none"> 1. Go to https://www.dell.com/support/home/?app=knowledgebase. 2. Type the subject or keyword in the Search box. 3. Click Search to retrieve the related articles.
Learn and know the following information about your product: <ul style="list-style-type: none"> • Product specifications • Operating system • Setting up and using your product • Data backup • Troubleshooting and diagnostics • Factory and system restore • BIOS information 	See <i>Me and My Dell</i> at www.dell.com/support/manuals . To locate the <i>Me and My Dell</i> relevant to your product, identify your product through one of the following: <ul style="list-style-type: none"> • Select Detect Product. • Locate your product through the drop-down menu under View Products. • Enter the Service Tag number or Product ID in the search bar.

Contacting Dell

To contact Dell for sales, technical support, or customer service issues, see www.dell.com/contactdell.

 **NOTE:** Availability varies by country and product, and some services may not be available in your country.

 **NOTE:** If you do not have an active internet connection, you can find contact information on your purchase invoice, packing slip, bill, or Dell product catalog.