

### Overview

### HPE ProLiant DL325 Gen11

Are you looking for a scalable, low-cost performance server solution for your virtualized and software-defined compute workloads? The HPE ProLiant DL325 Gen11 server is a low-cost 1U 1P solution that delivers exceptional value balancing compute, memory and network bandwidth at 1P economics. Powered by 4th Generation AMD EPYC™ Processors with up to 96 cores, increased memory bandwidth (up to 3 TB\*), high-speed PCIe Gen5 I/O and EDSFF\* storage, and supporting up to 2 GPUs\* at the front, this server is a superb low-cost, 1U 1P, performance solution for your virtualized workloads. The silicon root of trust anchors the server firmware, creating a fingerprint for the AMD Secure Processor that must be matched exactly before the server will boot. The HPE ProLiant DL325 Gen11 server is an excellent choice for virtualized workloads such as software-defined compute, CDN, VDI, and secure edge apps that require balancing processor, memory, and network bandwidth.

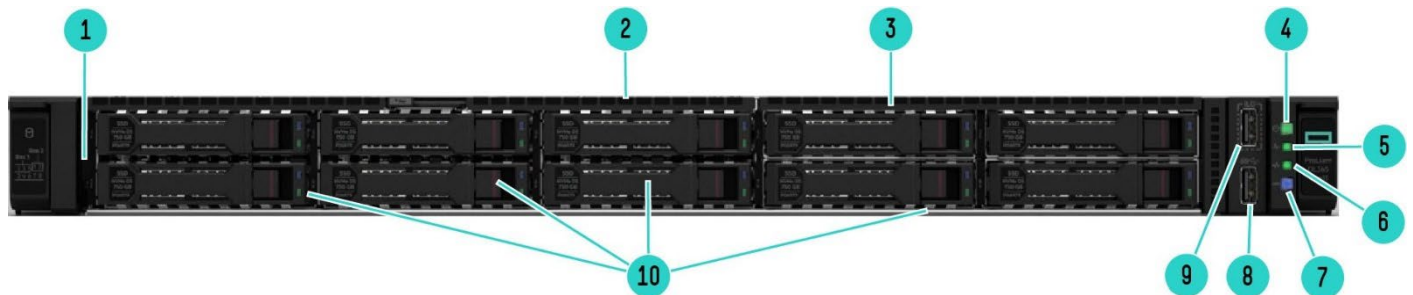

**Front View - 8 SFF + optional 2 SFF Drive Bay shown**

- |   |   |
|---|---|
| 1. Serial number pull tab                       | 6. Unit ID button/ LED                  |
| 2. Quick removal access panel                   | 7. iLO Service Port                     |
| 3. Power On/Standby button and system power LED | 8. 2 SFF Cage Bay (Optional - shown) ** |
| 4. Health LED                                   | 9. USB 3.2 Gen1 port                    |
| 5. NIC status LED                               | 10. 8 SFF Cage Bay                      |

#### Notes:

- \*Maximum Memory Capacity, EDSFF and GPU Mode-X support available 1H 2023, subject to change
- \*\*Optional: Optical Drives

## Overview

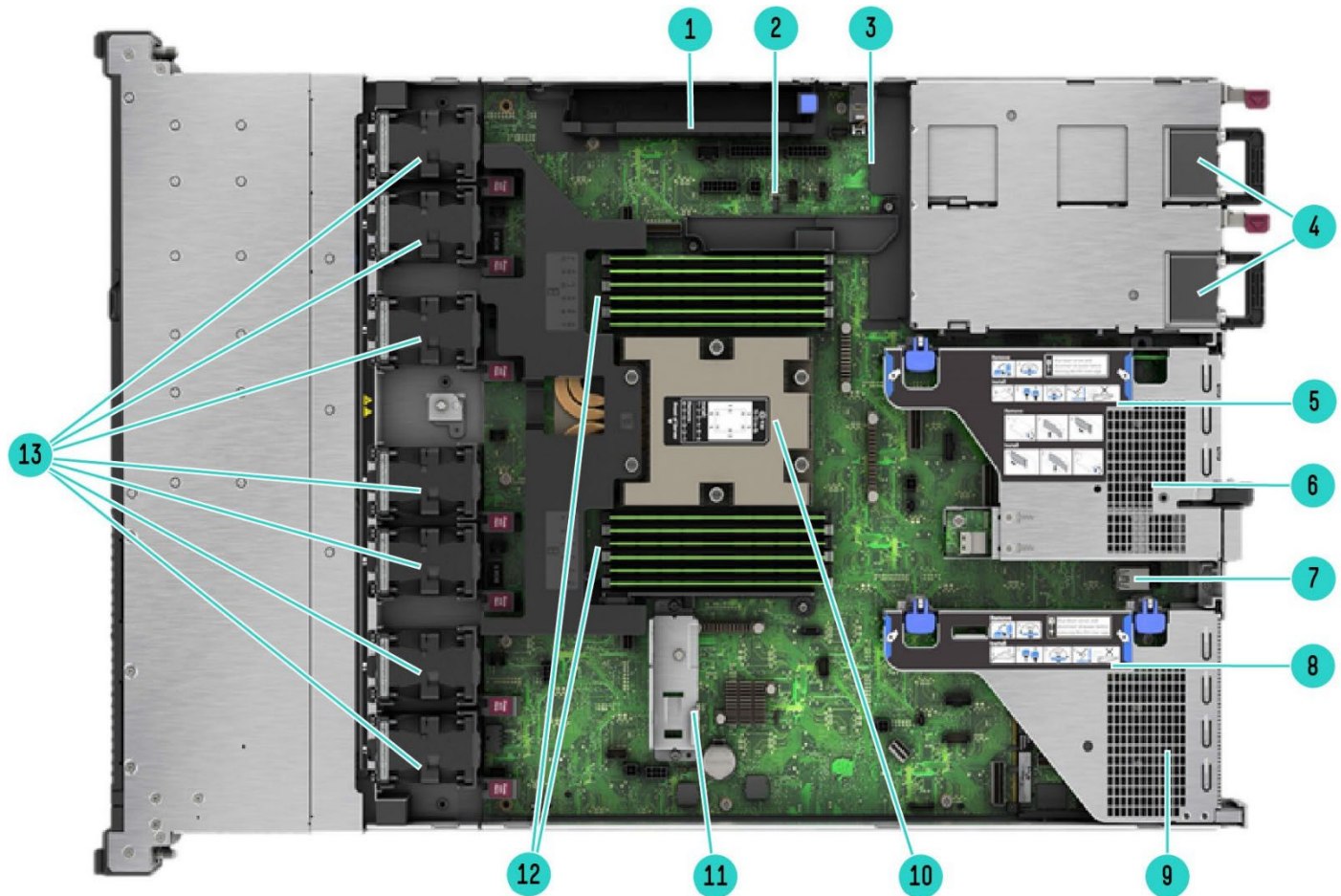

### Internal View – Standard for all HPE ProLiant DL325 Gen 11

- |  |  |
|--|--|
| 1. Megacell battery holder                                     | 8. Primary PCIe 5.0 riser  |
| 2. Hard drive backplane power connectors                       | 9. OCP 3.0 Slot 21 (Under)   |
| 3. Chassis intrusion detection connector                       | 10. Processor shown with standard heat sink <sup>1</sup> (Up to 1) |
| 4. Up to 2 Hot Plug redundant HPE Flexible Slot Power supplies | 11. FHFL PCIe card holder  |
| 5. Secondary PCIe 5.0 riser                                    | 12. DDR5 DIMM slots <sup>2</sup>                                   |
| 6. OCP 3.0 Slot 22 (Under)                                     | 13. Hot plug fans (3) <sup>3</sup>                                 |
| 7. Internal Dual USB 3.2 Gen1 port                             |  |

#### Notes:

- <sup>1</sup>Optional: Performance Heat Sink and Closed-Loop Liquid Cooling Heat Sink
- <sup>2</sup>Fully populated 12 DIMMs shown
- <sup>3</sup>7 dual rotor standard shown. Optional: Performance Fans and Liquid Cooling Fans



## Overview

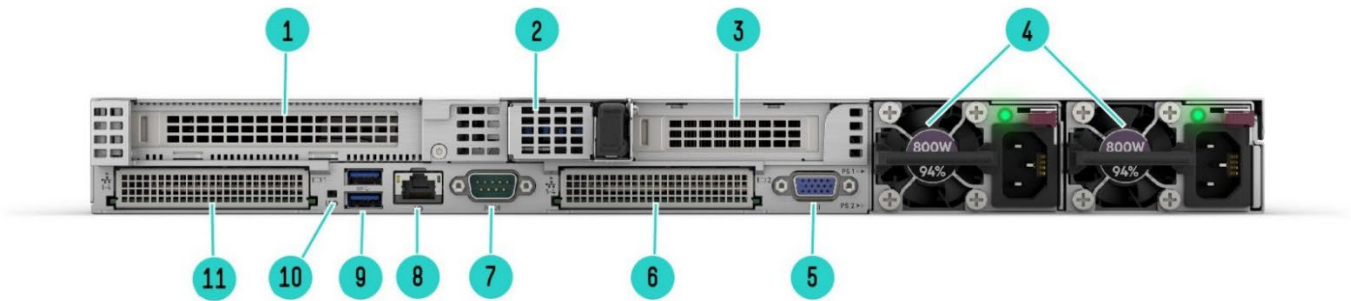

### Rear View – Secondary Low Profile Riser Shown

- |  |                                  |
|--|----------------------------------|
| 1. Primary PCIe 5.0 Riser                      | 7. Optional Serial port          |
| 2. Optional NS204i-u hot-plug NVMe boot device | 8. Dedicated iLO management port |
| 3. Secondary PCIe 5.0 Riser <sup>1</sup>       | 9. USB 3.1 Gen1 Ports (2)        |
| 4. Hot-plug Power Supply 1 and 2 <sup>2</sup>  | 10. Unit ID LED                  |
| 5. Video (VGA) port                            | 11. OCP 3.0 slot 21              |
| 6. OCP 3.0 slot 22                             |                                  |

#### Notes:

- <sup>1</sup>low profile and full height options
- <sup>2</sup>Hot-plug Power Supply 2 is optional

## What's New

- Supports the 4th Generation AMD EPYC™ Processors that supports up to 96 cores, 400W, and 384MB of L3 Cache.
- 12 DIMM channels per processor for up to 3TB\* total DDR5 memory 4800MT/s.
- Advanced data transfer rate and higher network speed from the PCIe Gen5 serial expansion bus
- Includes HPE Integrated Lights-Out 6 (iLO 6) server management software
- Supports hot-pluggable, high-availability RAID M.2 boot options.
- Supports up to 20 EDSFF Drive bay\*.
- Supports up to 2x Single Width or 2x Double Width GPU cards at the front chassis\*.

**Notes:** \*Maximum Memory Capacity, EDSFF and GPU Mode-X support available 1H 2023, subject to change

## Platform Information

### Form Factor

- 1U rack

### Chassis Types

- 8 SFF with options for additional 2 SFF drive bay.
- 4 LFF with options for additional optical drive
- 20 EDSFF\* drive bay.
- 2 Single Width or 2 Double Width GPUs\* with 8 EDSFF\* drive bay.

**Notes:** \*EDSFF and GPU Mode-X support available 1H 2023, subject to change

### System Fans

- Choice of Standard Fan Kit, Performance Fan and Liquid cooling Fan Kit

#### Notes:

- The DL325 Gen11 supports up to 7 fans with fan redundancy built in. One fan rotor failure will place server in degraded mode but fully functional. Two fan rotor failures could provide warning and imminent server shutdown.
- Each Fan kits are designated to operate under different configuration. For more information, please refer to the Cooling option message in the Unique option section.



## Standard Features

**Processors** – One of the following, depending on model.

**Notes:** For more information regarding AMD EPYC processors, please see the following:

<https://www.amd.com/en/products/epyc>

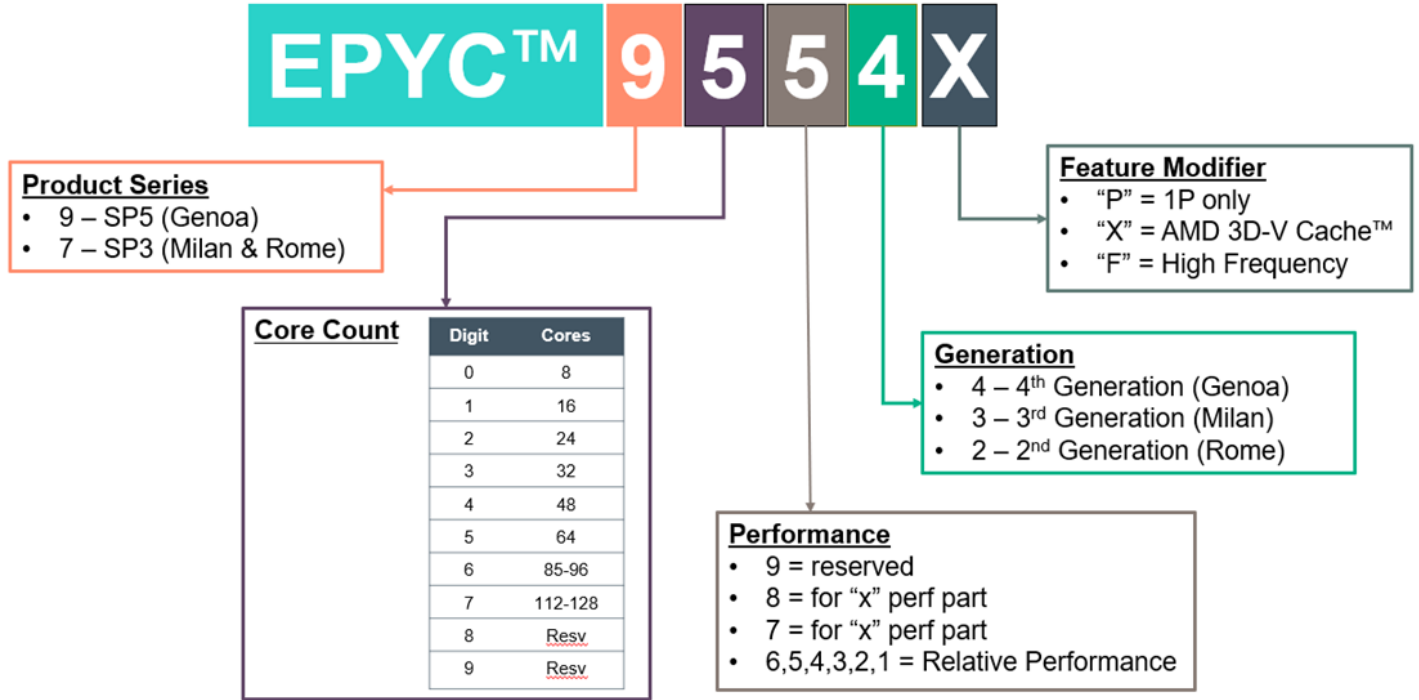

4 <sup>th</sup> Gen AMD EPYC Processor	Cores	Base Frequency	Max Frequency	Max Memory	Wattage	Cache	Memory
EPYC 9124	16	3.0 GHz	3.7 GHz	3TB	240W	64MB	4800MT/s
EPYC 9174F	16	4.1 GHz	4.4 GHz	3TB	400W	256MB	4800MT/s
EPYC 9224	24	2.5 GHz	3.7 GHz	3TB	240W	64MB	4800MT/s
EPYC 9354P	32	3.25 GHz	3.8 GHz	3TB	300W	256MB	4800MT/s
EPYC 9374F	32	3.85 GHz	4.3 GHz	3TB	400W	256MB	4800MT/s
EPYC 9554P	64	3.1 GHz	3.75 GHz	3TB	400W	256MB	4800MT/s
EPYC 9654P	96	2.4 GHz	3.7 GHz	3TB	400W	384MB	4800MT/s

**Notes:**

- 6096pin LGA SP5 new socket type.
- 1MB L2/Core, Up to 32MB L3/CCD
- All 4th generation AMD EPYC processors can support up to 3TB of memory each under 1DPC, 12 channel per processor.
- 128 PCIe 5.0 Lanes
- 64 IO Lanes support CXL1.1+ with bifurcations supported down to x4
- The wattage information indicates the cTDP (Configurable TDP) of the processor.

### Chipset

No chipset – System on Chip (SoC) design.

### On System Management Chipset

HPE iLO 6 ASIC

**Notes:** Read and learn more in the [iLO QuickSpecs](#).



## Standard Features

### Memory

One of the following depending on model

<b>Type:</b>	HPE DDR5 SmartMemory	Registered (RDIMM)
<b>DIMM Slots Available</b>	12	12 DIMM slots per processor, 12 channels per processor, 1 DIMMs per channel
<b>Maximum capacity (RDIMM)</b>	3.0 TB	12 x 256 GB RDIMM @ 4800 MT/s at 1 DPC

#### Notes:

- All processors support up to 3TB memory per server. Maximum Memory Capacity support available 1H 2023, subject to change
- LRDIMM and Persistent Memory is not supported.
- For additional information, please see the [HPE DDR5 SmartMemory QuickSpecs](#).
- For General Server Memory and Persistent Memory Population Rules and Guidelines, see details here: <http://www.hpe.com/docs/memory-population-rules>

### Memory Protection

#### Advanced ECC

Advanced ECC uses single device data correction to detect and correct single and all multibit error that occurs within a single DRAM chip.

#### Online Spare

Memory online spare mode detects a rank that is degrading and switches operation to the spare rank.

**Notes:** For more information see our [Memory RAS feature technical whitepaper](#).

### Expansion Slots

Primary Riser				
Slots #	Technology	Bus Width	Connector Width	Slot Form Factor
1 (Default Riser)	PCIe 5.0	X16	X16	Full-height, Full-length slot
Secondary Riser				
Slots #	Technology	Bus Width	Connector Width	Slot Form Factor
2	PCIe 5.0	X16	X16	Low Profile or Half-height, half-length slot

#### Notes:

- Secondary riser position supports both Low Profile or HHHL cards
- When NS204i-u Hot Plug Boot Optimized Storage Device is selected, low profile secondary riser (P55029-B21) must be in the order.
- When supporting GPU1 & Slot21 scenario, GPU1 & Slot21 combined can support up to 112GB/s bandwidth due to AMD CPU limitation.
- When supporting GPU2 & Slot1 scenario, GPU2 & Slot1 combined can support up to 112GB/s bandwidth due to AMD CPU limitation.



## Standard Features

### Storage Controllers

#### Boot Device

- HPE NS204i-u Gen11 NVMe Hot Plug Boot Optimized Storage Device
- HPE DL325 Gen11 NVMe/SATA M.2 Enablement kit

#### Notes:

- Both Boot Device not occupied a PCIe slot
- Only one(1) NS204i-u or M.2 enablement kit could be supported in HPE DL325 Gen 11.
- NS204i-u is external accessible and the M.2 enablement kit is internal accessible.
- Two(2) M.2 SATA/NVMe SSD must be selected with the M.2 enablement kit.
- NS204i-u had embedded two(2) 480GB M.2 NVMe SSD.
- RAID 1 supported on the NS204i-u Hot Plug Boot device. No RAID supported on the M.2 enablement kit.

### Smart Array Controllers

- HPE Smart Array E208e-p SR Gen10 Controller
- HPE MR216i-p Gen11 x16 Lanes without Cache PCI SPDM Plug-in Storage Controller
- HPE MR216i-o Gen11 x16 Lanes without Cache OCP SPDM Storage Controller
- HPE MR408i-o Gen11 x8 Lanes 4GB Cache OCP SPDM Storage Controller
- HPE MR416i-o Gen11 x16 Lanes 8GB Cache OCP SPDM Storage Controller
- HPE MR416i-p Gen11 x16 Lanes 8GB Cache PCI SPDM Plug-in Storage Controller
- HPE SR932i-p Gen11 x32 Lanes 8GB Wide Cache PCI SPDM Plug-in Storage

#### Notes:

- For additional details, please visit:  
[HPE Compute MR Gen11 Controllers Quick Spec](#)

## Internal Storage Devices

### Optical Drive

- Available on 8 SFF and 4 LFF CTO Servers as an option (DVD-ROM or DVD-RW)

### Drives

- None ship standard

Maximum Storage		
	Capacity	Configuration
Hot Plug LFF SAS HDD	80 TB	4 x 20 TB
Hot Plug LFF SATA HDD	80 TB	4 x 20 TB
Hot Plug SFF SAS SSD	76.8 TB	10 x 7.68 TB
Hot Plug SFF SATA SSD	76.8 TB	10 x 7.68 TB
Hot Plug SFF NVMe PCIe U.3 SSD	153.6 TB	10 x 15.36 TB
M.2 22110 NVMe SSD	3.84 TB	2 x 1.92 TB (via M.2 enablement Kit)
M.2 2280 SATA SSD	960 GB	2 x 480 GB (via M.2 enablement Kit)



## Standard Features

### Interfaces

<b>Serial</b>	1 port - Optional
<b>Video Port</b>	1 Rear VGA Port - Standard
<b>Network Ports</b>	None. Choice of OCP or stand up card, supporting a wide arrange of NIC adapters
<b>HPE iLO Remote Mgmt Port</b>	1 Gb Dedicated
<b>Front iLO Service Port</b>	1 standard
<b>USB 3.2 Gen1</b>	5 standard on all models: 1 front, 2 rear, 2 internal

### Graphics

#### Integrated Video Standard

- Video modes up to 1920 x 1200@60Hz (32 bpp)
- 16MB Video Memory

#### HPE iLO 6 on system management memory

- 64 MB Flash
- 8 Gbit DDR 4 with ECC protection

### Power Supply

- HPE 500W Flex Slot Platinum Hot Plug Low Halogen Power Supply Kit  
**Notes:** Available in 94% Efficiency.
- HPE 800W Flex Slot Platinum Hot Plug Low Halogen Power Supply Kit  
**Notes:** Available in 94% Power Efficiency.
- HPE 1600W Flex Slot Platinum Hot Plug Low Halogen Power Supply Kit  
**Notes:** Available in 94% Power Efficiency.
- HPE 1600W Flex Slot -48VDC Hot Plug Power Supply Kit  
**Notes:** Available in 94% Power Efficiency. 200-240VAC power input only.

HPE Flexible Slot (Flex Slot) Power Supplies share a common electrical and physical design that allows for hot plug, tool-less installation into HPE ProLiant Servers. Flex Slot power supplies are certified for high-efficiency operation and offer multiple power output options, allowing users to "right-size" a power supply for specific server configurations. This flexibility helps to reduce power waste, lower overall energy costs, and avoid "trapped" power capacity in the data center.

All pre-configured servers ship with a standard 6-foot IEC C-13/C-14 jumper cord (A0K02A). This jumper cord is also included with each standard AC power supply option kit. If a different power cord is required, please check the [ProLiant Power Cables](#) web page.

To review the power requirements for your selected system, please use the [HPE Power Advisor Tool](#).

For information on power specifications and technical content visit [HPE Server power supplies](#).

### Operating Systems and Virtualization Software Support for ProLiant Servers

- Windows Server 2019
- Windows Server 2022
- [Red Hat Enterprise Linux \(RHEL\) 8.6](#)
- [Red Hat Enterprise Linux \(RHEL\) 9.0](#)
- [SUSE Linux Enterprise Server \(SLES\) 15 SP4](#)

#### Notes:

- Pending VMware 7.0 U3 and VMware 8.0 certification.
- For more information on Hewlett Packard Enterprise Certified and Supported ProLiant Servers for OS and Virtualization Software and latest listing of software drivers available for your server.

<https://www.hpe.com/us/en/servers/server-operating-systems.html>



## Standard Features

### Industry Standard Compliance

- ACPI 6.1 Compliant
- PCIe 5.0 Compliant
- WOL Support
- Microsoft® Logo certifications
- PXE Support
- VGA/Display Port
- USB 3.2 Gen1 Compliant
- USB 2.0 Compliant
- Energy Star
- SMBIOS 3.1
- UEFI 2.9
- UEFI Class 3
- Redfish API
- IPMI 2.0
- Secure Digital 2.0
- Advanced Encryption Standard (AES)
- Triple Data Encryption Standard (3DES)
- SNMP v3
- TLS 1.2
- DMTF Systems Management Architecture for Server Hardware Command Line Protocol (SMASH CLP)
- Active Directory v1.0
- European Union (EU) eco-design regulations for server and storage products, known as Lot 9, go into effect on March 1st, 2020. Among other requirements, for servers this directive establishes power thresholds for idle state, as well as efficiency and performance in active state which vary among configurations. HPE ProLiant Gen11 servers are compliant with Lot9 requirements. For more information regarding HPE Lot 9 conformance, please visit: <https://www.hpe.com/us/en/about/environment/msds-specs-more.html>
- ASHRAE A3/A4  
**Notes:** For additional technical thermal details regarding ambient temperatures, humidity and features support please visit: <http://www.hpe.com/servers/ashrae>.
- UEFI (Unified Extensible Firmware Interface Forum)
- APML 1.0

---

### Embedded Management

#### HPE Integrated Lights-Out (HPE iLO)

Monitor your servers for ongoing management, service alerting, reporting and remote management with HPE iLO. Learn more at <http://www.hpe.com/info/ilo>.

#### UEFI

Configure and boot your servers securely with industry standard Unified Extensible Firmware Interface (UEFI).

#### Intelligent Provisioning

Hassle free server and OS provisioning for 1 or more servers with Intelligent Provisioning.

Learn more at [https://support.hpe.com/hpesc/public/docDisplay?docId=c04465280&docLocale=en\\_US](https://support.hpe.com/hpesc/public/docDisplay?docId=c04465280&docLocale=en_US)

#### iLO RESTful API

iLO RESTful API is DMTF Redfish API implementation and offers simplified server management automation such as configuration and maintenance tasks based on modern industry standards. Learn more at <http://www.hpe.com/info/restfulapi>.

---





## Standard Features

### HPE Server UEFI

Unified Extensible Firmware Interface (UEFI) is an industry standard that provides better manageability and more secured configuration than the legacy ROM while interacting with your server at boot time. HPE ProLiant Gen11 servers have a UEFI Class 3 implementation.

#### UEFI enables numerous new capabilities specific to HPE ProLiant servers such as

- Secure Boot and Secure Start enable for enhanced security
- Operating system specific functionality
- Support for > 2.2 TB (using GPT) boot drives
- USB 3.1 Gen1 Stack
- Embedded UEFI Shell
- Mass Configuration Deployment Tool using iLO RESTful API that is Redfish API Conformant
- PXE boot support for IPv6 networks
- Workload Profiles for simple performance optimization
- Embedded TPM Support

#### UEFI Boot Mode only

- NVMe Boot Support
- iSCSI Software Initiator Support.
- HTTP/HTTPS Boot support as a PXE alternative.
- Boot support for option cards that only support a UEFI option ROM

---

## Server Utilities

### Active Health System

The HPE Active Health System (AHS) is an essential component of the iLO management portfolio that provides continuous, proactive health monitoring of HPE servers. Learn more at <http://www.hpe.com/servers/ahs>.

### Active System Health Viewing

The Active System Health Viewer (AHSV) is deprecated as of March 2022. Users are now recommended to use the InfoSight for Servers Portal for AHS viewing capabilities. In InfoSight for Servers portal, users will also be able to view hardware configuration details, firmware and driver information, warranty and support status of a server, wellness alerts, and create support cases for servers under a valid warranty or support contract.

HPE InfoSight provides the same security assurances as that of AHSV. Furthermore, InfoSight can be used as an AHSV replacement even if customers do not want to share AHSV logs and telemetry data on an ongoing basis.

### Smart Update

Keep your servers up to date with the HPE Smart Update solution by using Smart Update Manager (SUM) to optimize the firmware and driver updates of the Service Pack for ProLiant (SPP). Learn more at <https://www.hpe.com/servers/smart-update.html>

### iLO Amplifier Pack

Designed for large enterprise and service provider environments with hundreds of HPE servers, the iLO Amplifier Pack is a free, downloadable open virtual application (OVA) that delivers the power to discover, inventory and update Gen8, Gen9, Gen10 and Gen10 Plus HPE servers. Use with an iLO Advanced License to unlock full capabilities.

Learn more at <http://www.hpe.com/servers/iLOamplifierpack>.



## Standard Features

### RESTful Interface Tool

RESTful Interface tool (iLOREST) is a single scripting tool to provision using iLO RESTful API to discover and deploy servers at scale. Learn more at <http://www.hpe.com/info/resttool>.

### Scripting Tools

Provision one to many servers using your own scripts to discover and deploy with Scripting Tool (STK) for Windows and Linux or Scripting Tools for Windows PowerShell. Learn more at <http://www.hpe.com/servers/powershell>.

### HPE OneView Standard

HPE OneView is an on premises, multi-generational server monitoring and management solution. HPE OneView Standard can be used for inventory, health monitoring, alerting, and reporting without additional fees. Customers can upgrade their management experience with an HPE OneView Advanced license, all provided by the same tool. Learn more at <http://www.hpe.com/info/oneview>.

### HPE GreenLake for Compute Ops Management

HPE is intelligently transforming compute management with a completely new As a Service experience that delivers greater security, simplicity, and efficiency. Discover a completely modernized compute management experience delivered through HPE GreenLake that securely streamlines operations from edge-to-cloud, and automates key lifecycle tasks (onboard, update, manage and monitor HPE servers), bringing the agility and greater efficiencies to wherever compute devices reside via a unified single browser-based interface.

Compute Ops Management is built on a unique cloud-native architecture that abstracts, manages and controls HPE servers regardless of physical location. The management application resides in the HPE GreenLake cloud platform (access via [console.greenlake.hpe.com](https://console.greenlake.hpe.com)) and leverages the HPE GreenLake architecture, security, and unified operations.

Each HPE ProLiant Gen11 rack, tower and micro server will include a 3-year subscription to HPE GreenLake for Compute Ops Management - Standard Tier. Upgrades to Standard Tier 5 Year term or to an Enhanced Tier, 3 or 5 Year term, subscription can be made at time of order. Upgrades to Enhanced tier or OneView can also be made at any time.

---

## Security

- UEFI Secure Boot and Secure Start support
  - Immutable Silicon Root of Trust
  - FIPS 140-3 validation (iLO 6 certification in progress)
  - Common Criteria certification (iLO 6 certification in progress)
  - Configurable for PCI DSS compliance
  - Advanced Encryption Standard (AES) and Triple Data Encryption Standard (3DES) on browser
  - Support for Commercial National Security Algorithms (CNSA)
  - Tamper-free updates – components digitally signed and verified
  - Secure Recovery – recover critical firmware to known good state on detection of compromised firmware
  - Ability to rollback firmware
  - Secure erase of NAND/User data
  - TPM (Trusted Platform Module) 2.0 option
  - Bezel Locking Kit option
  - Chassis Intrusion detection option
- 



---

## Standard Features

### Server Management

#### HPE iLO Advanced

HPE iLO Advanced licenses offer smart remote functionality without compromise, for all HPE ProLiant servers. The license includes the full integrated remote console, virtual keyboard, video, and mouse (KVM), multi-user collaboration, console record and replay, and GUI-based and scripted virtual media and virtual folders. You can also activate the enhanced security and power management functionality.

#### HPE OneView Advanced

HPE OneView Advanced offers a sophisticated level of automation to infrastructure management by taking a template driven approach to provisioning, updating, and integrating compute, storage, and networking infrastructure. It builds upon the base features of HPE OneView Standard, provides full-featured licenses which can be purchased for managing multiple HPE server generations. To learn more visit <http://www.hpe.com/info/oneview>.

#### HPE InfoSight for Servers

HPE InfoSight for Servers combines the cloud-based machine learning of InfoSight with the health and performance monitoring of Active Health System (AHS) and iLO to optimize performance and predict and prevent problems. The end result is an intelligent environment that modernizes IT operations and enhances the support experience by predicting and preventing the infrastructure issues that lead to application disruptions, wasted IT staff time and missed business opportunities.

Learn more at <https://www.hpe.com/servers/infosight>

---

### Warranty

This product is covered by a global limited warranty and supported by HPE Services and a worldwide network of HPE Authorized Channel Partners resellers. Hardware diagnostic support and repair is available for three years from date of purchase. Support for software and initial setup is available for 90 days from date of purchase. Enhancements to warranty services are available through HPE Pointnext operational services or customized service agreements. Hard drives have either a one year or three year warranty; refer to the specific hard drive QuickSpecs for details.

**Notes:** Server Warranty includes 3-Year Parts, 3-Year Labor, 3-Year Onsite support with next business day response. Warranty repairs may be accomplished through the use of Customer Self Repair (CSR) parts. These parts fall into two categories: 1) Mandatory CSR parts are designed for easy replacement. A travel and labor charge will result when customers decline to replace a Mandatory CSR part; 2) Optional CSR parts are also designed for easy replacement but may involve added complexity. Customers may choose to have Hewlett Packard Enterprise replace Optional CSR parts at no charge. Additional information regarding worldwide limited warranty and technical support is available at:

<http://h17007.www1.hpe.com/us/en/enterprise/servers/warranty/>.

---



## Optional Features

### Rack and Power Infrastructure

The story may end with servers, but it starts with the foundation that makes compute go – and business grow. We've reinvented our entire portfolio of rack and power products to make IT infrastructure more secure, more practical, and more efficient. In other words, we've created a stronger, smarter, and simpler infrastructure to help you get the most out of your IT equipment. As an industry leader, Hewlett Packard Enterprise is uniquely positioned to address the key concerns of power, cooling, cable management and system access.

HPE G2 Advanced and Enterprise Racks are perfect for the server room or today's modern data center with enhanced airflow and thermal management, flexible cable management, and a 10 year Warranty to support higher density computing.

HPE G2 PDUs offer reliable power in flexible form factors that operate at temperatures up to 60°C, include color-coded outlets and load segments and a low-profile design for optimal access to the rack and support for dense rack environments.

HPE Uninterruptible Power Systems are cost-effective power protection for any type workload. Some UPSs include options for remote management and extended runtime modules so your critical dense data center is covered in power outages.

HPE KVM Solutions include a console and switches designed to work with your server and IT equipment reliably. We've got a cost-effective KVM switch for your first rack and multiple connection IP switches with remote management and security capabilities to keep your data center rack up and running.

Learn more about HPE Racks, KVM, PDUs and UPSs at [HPE Rack and Power Infrastructure](#).

---

### One Config Simple (OCS/SCE)

OCS/SCE is a guided self-service tool to help sales and non-technical people provide customers with initial configurations in 3 to 5 minutes. You may then send the configuration on for configuration help, or use in your existing ordering processes. If you require "custom" rack configuration or configuration for products not available in SCE, please contact Hewlett Packard Enterprise Customer Business Center or an Authorized Partner for assistance. <https://h22174.www2.hpe.com/SimplifiedConfig/Welcome>

---



## Service and Support

### HPE Pointnext - Service and Support

No matter where you are in your digital transformation journey, you can count on HPE Pointnext Services to provide the expertise you need, when and where you need it.

#### Advisory and Professional Services

Our Digital Next Advisory approach can help you identify, prioritize, and implement the right transformation initiatives to create new edge experiences, get real-time insights from all your data, and modernize your IT to enable new opportunities.

#### Operational Services

Take your IT operations to the next level with expertise and tools that can help save your staff time, manage complexity, and identify new ways to drive efficiency and effectiveness in your IT.

#### HPE Pointnext Tech Care

HPE Pointnext Tech Care is the new operational service experience for HPE products. Tech Care goes beyond traditional support by providing access to product specific experts, an AI driven digital experience, and general technical guidance to not only reduce risk but constantly search for ways to do things better. HPE Pointnext Tech Care has been reimaged from the ground up to support a customer-centric, AI driven, and digitally enabled customer experience to move your business forward. HPE Pointnext Tech Care is available in three response levels. Basic, which provides 9x5 business hour availability and a 2-hour response time. Essential which provides a 15-minute response time 24x7 for most enterprise level customers, and Critical which includes a 6-hour repair commitment where available and outage management response for severity 1 incidents.

<https://www.hpe.com/services/techcare>

#### HPE Pointnext Complete Care

HPE Pointnext Complete Care is a modular, edge-to-cloud IT environment service that provides a holistic approach to optimizing your entire IT environment and achieving agreed upon IT outcomes and business goals through a personalized and customer-centric experience. All delivered by an assigned team of HPE Pointnext Services experts. HPE Pointnext Complete Care provides:

- A complete coverage approach -- edge to cloud
- An assigned HPE team
- Modular and fully personalized engagement
- Enhanced Incident Management experience with priority access
- Digitally enabled and AI driven customer experience

<https://www.hpe.com/services/complecare>

---

### HPE Lifecycle Services

Lifecycle Services provide a variety of options to help maintain your HPE systems and solutions at all stages of the product lifecycle. A few popular examples include:

- Installation and Startup Services: Various levels for physical installation and power on, remote access setup, installation and startup, and enhanced installation services with the operating system.
- HPE Firmware Update Service: Recommendations for firmware revision levels for selected HPE products, taking into account the relevant revision dependencies within your IT environment.
- HPE Firmware Update Implementation Service: Implementation of firmware updates for selected HPE server, storage, and solution products, taking into account the relevant revision dependencies within your IT environment.
- HPE Implementation Assistance Service: Highly trained technical service specialists to assist you with a variety of activities, ranging from design, implementation, and platform deployment to consolidation, migration, project management, and onsite technical forums.
- HPE Service Credits: Access to prepaid services for flexibility to choose from a variety of specialized service activities, including assessments, performance maintenance reviews, firmware management, professional services, and operational best practices.
  - For a list of the most frequently purchased services using service credits, see the [Universal Service Credits Menu](#)



## Service and Support

### Other related services from HPE Pointnext Services:

#### HPE Education Services

Provides comprehensive training designed to expand the skills of your IT staff and keep them up to speed with the latest technologies.

#### Defective Media Retention

An option available with HPE Pointnext Complete Care and HPE Pointnext Tech Care and applies only to Disk or eligible SSD/Flash Drives replaced by HPE due to malfunction.

Consult your HPE Sales Representative or Authorized Channel Partner of choice for any additional questions and support options.

#### Parts and Materials

HPE will provide HPE-supported replacement parts and materials necessary to maintain the covered hardware product in operating condition, including parts and materials for available and recommended engineering improvements.

Parts and components that have reached their maximum supported lifetime and/or the maximum usage limitations as set forth in the manufacturer's operating manual, product QuickSpecs, or the technical product data sheet will not be provided, repaired, or replaced as part of these services.

#### AI Powered and Digitally Enabled Support Experience

Achieve faster time to resolution with access to product-specific resources and expertise through a brand-new digital and data driven customer experience.

Sign into the new HPE Support Center experience, featuring streamlined self-serve case creation and management capabilities with inline knowledge recommendations. You will also find personalized task alerts, and powerful troubleshooting support through a new intelligent virtual agent with seamless transition when needed to a live support agent.

Learn more <https://support.hpe.com/hpesc/public/home/signin>

#### Consume IT on your terms

HPE Support Services are sold by Hewlett Packard Enterprise and Hewlett Packard Enterprise Authorized Service Partners:

- Services for customers purchasing from HPE or an enterprise reseller are quoted using HPE order configuration tools.
- Customers purchasing from a commercial reseller can find HPE Support Services at <https://ssc.hpe.com/portal/site/ssc/>

**HPE GreenLake** brings the cloud experience directly to your apps and data wherever they are—the edge, colocations, or your data center. It delivers cloud services for on-premises IT infrastructure specifically tailored to your most demanding workloads. With a pay-per-use, scalable, point-and-click self-service experience that is managed for you, HPE GreenLake accelerates digital transformation in a distributed, edge-to-cloud world.

- Get faster time to market
- Save on TCO, align costs to business
- Scale quickly, meet unpredictable demand
- Simplify IT operations across your data centers and clouds

#### Managed services to run your IT operations

**HPE GreenLake Management Services** provide services that monitor, operate, and optimize your infrastructure and applications, delivered consistently and globally to give you unified control and let you focus on innovation.

---



## Pre-configured Models

	Base	Performance
<b>SKU Number</b>	<b>P58690-B21</b> <b>P58690-291</b> <b>P58690-AA1</b>	<b>P58691-B21</b> <b>P58691-291</b> <b>P58691-AA1</b>
<b>Model Name</b>	HPE ProLiant DL325 Gen11 9124 3.0GHz 16C 1P 32GB-R MR408i-o 8SFF 800W PS Server	HPE ProLiant DL325 Gen11 9354P 3.25GHz 32C 1P 32GB-R MR408i-o 8SFF 800W PS Server
<b>Processor</b>	9124 (16-Core, 3.0 GHz, 240W)	9354P (32-Core, 3.25 GHz, 300W)
<b>Number of Processors</b>	One processor	One processor
<b>Memory</b>	32 GB RDIMM SR 4800 MT/s (1x 32 GB)	32 GB RDIMM SR 4800 MT/s (1x 32 GB)
<b>Network Controller</b>	HPE 1GbE 4-port OCP3 Adapter plus choice of OCP or standup card	HPE 10GbE 2-port OCP3 Adapter plus choice of OCP or standup card
<b>Storage Controller</b>	HPE MR408i-o Gen11 x8 Lanes 4GB Cache OCP SPDM Storage Controller	HPE MR408i-o Gen11 x8 Lanes 4GB Cache OCP SPDM Storage Controller
<b>Drive</b>	None ship as standard	None ship as standard
<b>Internal Storage</b>	8 SFF Chassis (upgradeable to 10 SFF front)	8 SFF Chassis (upgradeable to 10 SFF front)
<b>Optical Drive</b>	None ship as standard	None ship as standard
<b>PCI-Express Slots</b>	1 PCIe x16 Primary Riser	1 PCIe x16 Primary Riser
<b>Power Supply</b>	1x 800W HPE FlexSlot Power Supply	1x 800W HPE FlexSlot Power Supply
<b>Fans</b>	7- standard fans	7- Performance fans
<b>Management</b>	Default: HPE iLO Standard with Intelligent Provisioning, HPE OneView Standard (requires download)	Default: HPE iLO Standard with Intelligent Provisioning, HPE OneView Standard (requires download)
<b>Energy Star</b>	3.0 certified	3.0 certified
<b>Form Factor</b>	1U Rack	1U Rack
<b>Warranty</b>	3-year parts, 3-year labor, 3-year onsite support with next business day response.	3-year parts, 3-year labor, 3-year onsite support with next business day response.



## Pre-configured Models

SKU Number	P58690-421	P58691-421
<b>Model Name</b>	HPE ProLiant DL325 Gen11 9124 3.0GHz 16C 1P 32GB-R MR408i-o 8SFF 1000W PS Server	HPE ProLiant DL325 Gen11 9354P 3.25GHz 32C 1P 32GB-R MR408i-o 8SFF 1000W PS Server
<b>Processor</b>	9124 (16-Core, 3.0 GHz, 240W)	9354P (32-Core, 3.25 GHz, 300W)
<b>Number of Processors</b>	One processor	One processor
<b>Memory</b>	32 GB RDIMM SR 4800 MT/s (1x 32 GB)	32 GB RDIMM SR 4800 MT/s (1x 32 GB)
<b>Network Controller</b>	HPE 1GbE 4-port OCP3 Adapter plus choice of OCP or standup card	HPE 10GbE 2-port OCP3 Adapter plus choice of OCP or standup card
<b>Storage Controller</b>	HPE MR408i-o Gen11 x8 Lanes 4GB Cache OCP SPDM Storage Controller	HPE MR408i-o Gen11 x8 Lanes 4GB Cache OCP SPDM Storage Controller
<b>Drive</b>	None ship as standard	None ship as standard
<b>Internal Storage</b>	8 SFF Chassis (upgradeable to 10 SFF front)	8 SFF Chassis (upgradeable to 10 SFF front)
<b>Optical Drive</b>	None ship as standard	None ship as standard
<b>PCI-Express Slots</b>	1 PCIe x16 Primary Riser	1 PCIe x16 Primary Riser
<b>Power Supply</b>	1x 1000W HPE FlexSlot Power Supply <b>Notes:</b> EU Lot-9 compliant.	1x 1000W HPE FlexSlot Power Supply <b>Notes:</b> EU Lot-9 compliant.
<b>Fans</b>	7-standard fans	7- performance fans
<b>Management</b>	Default: HPE iLO Standard with Intelligent Provisioning, HPE OneView Standard (requires download)	Default: HPE iLO Standard with Intelligent Provisioning, HPE OneView Standard (requires download)
<b>Energy Star</b>	3.0 certified	3.0 certified
<b>Form Factor</b>	1U Rack	1U Rack
<b>Warranty</b>	3-year parts, 3-year labor, 3-year onsite support with next business day response.	3-year parts, 3-year labor, 3-year onsite support with next business day response.

## Country Code Key

xx1 = B21 Worldwide

xx1 = 291 Japan

xx1 = 421 EMEA

xx1 = AA1 China

**Notes:** The -B21 WW SKU is to be ordered in all countries other than Japan



## Configuration Information

### Smart Templates from HPE

HPE is releasing new Smart Template technology in the One Config Advanced (OCA) configurator. These Templates represent the CTO equivalents of the top-selling BTO configurations. They are intended to provide simple starting points to assist you in easily creating and customizing your desired Server solutions. HPE Servers that have Platform Templates, developed by HPE Product Managers, will have a separate tab in the HPE OCA configurator.

### Workload Solutions Templates from HPE

The Workload Solutions Templates build on the Smart Templates technology to easily develop working configurations of the most compelling Workload Solutions. The templates complement the Reference Builds developed by HPE. Workload Solutions templates preconfigure some of the key architecture decisions and make it easier for Sellers to get started and complete a differentiated server solution for your customer's specific workload.

### Mainstream SKUs

HPE launched the Mainstream SKU initiative as a market-driven approach to Demand Steering. It is a simplified portfolio of our top selling options that meet the current and future market trends. HPE has committed to provide a more predictable and faster experience for these options. Mainstream SKUs enjoy higher safety stock levels and have higher fulfillment service levels than non-Mainstream SKUs. Mainstream orders are fulfilled +30% faster than non-Mainstream orders, have fewer shortages and better recovery dates. This platform has Mainstream SKUs in the options portfolio, and is eligible for the improved Mainstream experience. Mainstream SKUs are designated with a Mainstream symbol in our configurators.

### Mainstream Configurations

HPE is using the new Smart Templates technology to present Mainstream configurations. All the options in a Mainstream configuration are pre-selected Mainstream SKUs to optimize the performance, predictability and fulfillment experience. Check the Template section in our configurators for eligible Mainstream configurations.

---

European Union (EU) eco-design regulations for server and storage products, known as Lot 9, go into effect on March 1st, 2020. Among other requirements, for servers this directive establishes power thresholds for idle state, as well as efficiency and performance in active state which vary among configurations. HPE ProLiant Gen11 servers are compliant with Lot9 requirements. For more information regarding HPE Lot 9 conformance, please visit:

<https://www.hpe.com/us/en/about/environment/msds-specs-more.html>

This section lists some of the steps required to configure a Factory Integrated Model. To ensure only valid configurations are ordered, Hewlett Packard Enterprise recommends the use of an HPE approved configurator. Contact your local sales representative for information on configurable product offerings and requirements.

- Factory Integrated Models must start with a CTO Server.
- FIO indicates that this option is only available as a factory installable option.
- All Factory Integrated Models will be populated with sufficient hard drive blanks based on the number of initial hard drives ordered with the server.
- Some options may not be integrated at the factory. Contact your local sales representative for additional information.



## Configuration Information

### Step 1: Base Configuration (choose one of the following configurable models)

<b>CTO Server</b>	HPE ProLiant DL325 Gen11 8SFF Configure-to-order Server	HPE ProLiant DL325 Gen11 4LFF Configure-to-order Server
<b>SKU Number</b>	P54199-B21	P54200-B21
<b>Processor</b>	Not included as standard	Not included as standard
<b>DIMM Slots</b>	12-DIMM slots	12-DIMM slots
<b>Storage Controller</b>	Choice of HPE Smart Array controllers	
<b>PCIe</b>	1 PCIe x16 Primary Riser	1 PCIe x16 Primary Riser
<b>Drive Cage - included</b>	8 SFF (Backplane is not included)	4 LFF (Backplane is included)
<b>Network Controller</b>	Choice of OCP and stand up card	
<b>Fans</b>	Not included as standard	
<b>Management</b>	Default: HPE iLO Standard with Intelligent Provisioning, HPE OneView Standard (requires download), HPE GreenLake for Compute Ops Management (subscription included)	
<b>USB</b>	Front: 1 USB 3.2 Gen1 + iLO service port Rear: 2 USB 3.2 Gen1 Internal: 2 USB 3.2 Gen1	Front: 1 USB 3.2 Gen1 + iLO service port Rear: 2 USB 3.2 Gen1 Internal: 2 USB 3.2 Gen1

#### Notes:

- HPE offers multiple Trade Agreement Act (TAA) compliant configurations to meet the needs of US Federal Government customers. These products are either manufactured or substantially transformed in a designated country. TAA compliance is only provided when HPE options are included as part of factory integrated orders (CTO).
- TAA compliant configuration requires TAA versions of the CTO Server SKUs.
- All CTO servers are Energy Star 3.0 compliant.
- CTO servers do not ship with rail kits, they need to be ordered separately

### Configuration Information

<b>CTO Server</b>	8 SFF Chassis	4 LFF Chassis
<b>Included Drive Cage</b>	8 SFF	4 LFF
<b>Universal Media Bay</b>	Optional	Not Available
<b>ODD</b>	1 Optional	1 Optional
<b>4 LFF SAS/SATA</b>	Not Available	1 Optional
<b>8 SFF SAS/SATA</b>	1 Optional	Not Available
<b>8 SFF NVMe</b>	1 Optional	Not Available
<b>2 SFF SAS/SATA</b>	1 Optional	Not Available
<b>2 SFF NVMe</b>	1 Optional	Not Available

#### Notes:

- This applies to CTO configurations, field upgrades may differ depending field configuration.
- Backplane kits need to be ordered separately for 8SFF CTO servers

## Step 2: Choose Required Options

### Step 2a: Choose Processors

#### Processor Option Kits

	<b>SKU</b>
AMD EPYC 9124 3.0GHz 16-core 200W Processor for HPE	P53702-B21
AMD EPYC 9174F 4.1GHz 16-core 320W Processor for HPE	P53698-B21
AMD EPYC 9224 2.5GHz 24-core 200W Processor for HPE	P58540-B21
AMD EPYC 9354P 3.25GHz 32-core 280W Processor for HPE	P53704-B21
AMD EPYC 9374F 3.85GHz 32-core 320W Processor for HPE	P53710-B21



## Configuration Information

AMD EPYC 9554P 3.1GHz 64-core 360W Processor for HPE	P53703-B21
AMD EPYC 9654P 2.4GHz 96-core 360W Processor for HPE	P53697-B21

### Notes:

- For processors less than or equal to 240W, one (1) standard heat sink (P58456-B21) and seven (7) standard FAN kit(P58461-B21) are required.
- For processors more than or equal to 260W and less or equal than 300W, one (1) performance heat sink kit (P58457-B21) and seven (7) performance FAN kit (P58462-B21) are required.
- For processors more than or equal to 320W, one (1) Closed-Loop Liquid Cooling Heat Sink FIO kit(P58463-B21) and seven (7) liquid cooling FAN kit (P59668-B21) are required.
- Above considerations are based on standard 8SFF & 4LFF CTO server.

### Step 2b: Choose Memory Options

Please select one or more memory from below.

### Notes:

- Quantity of memory DIMMs selected per socket must be 1, 2, 4, 6, 8, 10 or 12.
- Memory DIMM availability with a server platform is dependent upon completion of certification testing.
- The maximum memory speed and capacity is a function of the memory type, memory configuration, and processor model
- For additional information, please see the **HPE DDR5 SmartMemory QuickSpecs**.
- For General Server Memory and Persistent Memory Population Rules and Guidelines, see details here:
- <http://www.hpe.com/docs/memory-population-rules>
- HPE Server Memory compatibility for a specific server platform may vary or be limited within a server platform depending upon the specific configuration being requested. Because each server environment and requirements can vary, memory compatibility is based not only upon the server family, but may also be affected by the amount and type of additional hardware options installed within a specific server configuration. For this reason, some HPE memory DIMMs may be qualified for an HPE server model or family and yet occasionally not be supported with some configurations within that server family.

### Registered DIMMs (RDIMMs)

HPE 16GB (1x16GB) Single Rank x8 DDR5-5200 CAS-42-42-42 EC8 Registered Smart Memory Kit	P50309-B21
HPE 32GB (1x32GB) Single Rank x4 DDR5-5200 CAS-42-42-42 EC8 Registered Smart Memory Kit	P50310-B21
HPE 32GB (1x32GB) Dual Rank x8 DDR5-5200 CAS-42-42-42 EC8 Registered Smart Memory Kit	P50311-B21
HPE 64GB (1x64GB) Dual Rank x4 DDR5-5200 CAS-42-42-42 EC8 Registered Smart Memory Kit	P50312-B21

**Notes:** Mixing of x4 & x8 memory is not allowed

### Step 2c: Choose Power Supplies

Select one or two power supplies from below.

HPE 1600W Flex Slot Platinum Hot Plug Low Halogen Power Supply Kit	P38997-B21
HPE 500W Flex Slot Platinum Hot Plug Low Halogen Power Supply Kit	865408-B21
HPE 1600W Flex Slot -48VDC Hot Plug Power Supply Kit	P17023-B21
HPE 800W Flex Slot Platinum Hot Plug Low Halogen Power Supply Kit	P38995-B21

### Notes:

- Select one or more power supplies.
- Mixing of 2 different power supplies is NOT supported.
- Prior to making a power supply selection it is highly recommended that the HPE Power Advisor is run to determine the right size power supply for your server configuration. The HPE Power Advisor is located at: <https://poweradvisorex.it.hpe.com/?Page=Index>
- HPE ProLiant servers ship with an IEC-IEC power cord used for rack mounting with Power Distribution Units (PDUs). Visit **HPE Power Cords and Cables** for a full list of optional power cords.



## Configuration Information

### Step 2d: Choose Backplane (8 SFF server only)

If front drives are needed in the server, please select one backplane from list below

**Notes:** Mixing of U.3 and U.2 backplanes is not supported

HPE ProLiant DL325 Gen11 8SFF x1 Tri-Mode U.3 Backplane Kit P54999-B21

**Notes:**

- Supports 8 SFF SAS/SATA/ NVMe (U.3) Basic Carrier (BC) Drives.
- Includes Direct attach cables
- Tri-Mode controllers must be in the order if U.3 NVMe drives are selected with this backplane kit.
- if this 8SFF x1 U.3 Backplane kit is selected, one of the following cable options must in the order:
  - o with smart array controllers at PCIe slot: 8SFF x1 Tri-Mode Secondary Cable Kit (P57009-B21)
  - o with smart array controllers at OCP slot: 8SFF x1 OCP2 Tri-Mode Cable Kit (P59619-B21)
  - o Direct attach: no additional cable kit selection required

HPE ProLiant DL325 Gen11 8SFF x4 Tri-Mode U.3 BC Backplane Kit P55000-B21

**Notes:**

- Supports 8 SFF SAS/SATA/ NVMe (U.3) Basic Carrier (BC) Drives.
- Includes Direct attach cables
- Requires 7 Performance Fan Kit (P58462-B21) or 7 liquid cooling fan kit (P59668-B21)
- if this 8SFF x4 U.3 Backplane kit is selected, one of the following cable options must in the order:
  - o with smart array controller SR932i-p: 8SFF x4 Primary SR932i-p Tri-Mode Cable Kit (P57004-B21) or 8SFF x4 Secondary SR932i-p Tri-Mode Cable Kit (P57005-B21)
  - o with smart array controllers at PCIe slot: 8SFF x2 Tri-Mode Secondary Cable Kit (P57006-B21)
  - o Via smart array controllers at OCP slot: 8SFF x2 Tri-Mode OCP2 Cable Kit (P57008-B21)
  - o Direct attach: no additional cable kit selection required

### Step 3: Choose Additional Factory Integratable Options

One of the following from each list may be selected if desired at time of factory integration

HPE ProLiant DL325 Gen11 Liquid Cooling Heat Sink Kit P58463-B21

**Notes:**

- This Closed-Loop Liquid Cooling Heat Sink FIO is designed for processors more than or equal to 320W.
- Requires 7 Liquid cooling FAN kit (P59668-B21) in the order.
- The HPE DL325 Gen11 Closed-Loop Liquid Cooling Heat Sink FIO kit is subject to a Maximum Usage Limitation of not exceeding five (5) years operation and required to be replaced when reaching limitation. Parts and components that Hewlett Packard Enterprise determines have reached or exceeded their Maximum Usage limitations will not be provided, repaired, or replaced under warranty or service contract. Contact your local sales representative for additional information.

### HPE Converged Infrastructure Management Software

HPE OneView w/o iLO including 3yr 24x7 Support 1-server FIO LTU P8B31A

HPE OneView for ProLiant DL Server including 3yr 24x7 Support FIO Bundle Physical 1-server LTU E5Y43A



---

## Configuration Information

### HPE Security Options

HPE Trusted Supply Chain for HPE ProLiant

P36394-B21

HPE Trusted Supply Chain E-LTU

R6X85AAE

#### Notes:

- [Intrusion Cable Kit \(P55713-B21\)](#) must be selected with the Trusted Supply Chain Config
  - If Trusted Supply Chain config is selected, only one instance of the E-LTU software option is required per order (not per server): [HPE Trusted Supply Chain E-LTU](#).
- 

### Step 4: Choose additional options for Factory Integration from Core and Additional Options sections

#### below

Some options may not be integrated at the factory. To ensure only valid configurations are ordered, Hewlett Packard Enterprise recommends the use of an HPE approved configurator. Contact your local sales representative for additional information.

---



## Core Options

### Software as a Service Management

#### HPE GreenLake for Compute Ops Management

##### Base SKU

HPE GreenLake for Compute Ops Management Standard 3-year Upfront ProLiant SaaS R6Z89AAE

##### Upgrade SKUS

HPE GreenLake for Compute Ops Management Standard 1-year Upfront ProLiant SaaS R6Z88AAE

HPE GreenLake for Compute Ops Management Standard 5-year Upfront ProLiant SaaS R6Z90AAE

HPE GreenLake for Compute Ops Management Standard 1-year Monthly ProLiant SaaS R6Z91AAE

HPE GreenLake for Compute Ops Management Standard 3-year Monthly ProLiant SaaS R6Z92AAE

HPE GreenLake for Compute Ops Management Standard 5-year Monthly ProLiant SaaS R6Z93AAE

HPE GreenLake for Compute Ops Management Standard 1-year Quarterly ProLiant SaaS R6Z94AAE

HPE GreenLake for Compute Ops Management Standard 3-year Quarterly ProLiant SaaS R6Z95AAE

HPE GreenLake for Compute Ops Management Standard 5-year Quarterly ProLiant SaaS R6Z96AAE

HPE GreenLake for Compute Ops Management Standard 3-year Annual ProLiant SaaS R6Z97AAE

HPE GreenLake for Compute Ops Management Standard 5-year Annual ProLiant SaaS R6Z98AAE

HPE GreenLake for Compute Ops Management Enhanced 1-year Upfront ProLiant SaaS R7A10AAE

HPE GreenLake for Compute Ops Management Enhanced 3-year Upfront ProLiant SaaS R7A11AAE

HPE GreenLake for Compute Ops Management Enhanced 5-year Upfront ProLiant SaaS R7A12AAE

HPE GreenLake for Compute Ops Management Enhanced 1-year Monthly ProLiant SaaS R7A13AAE

HPE GreenLake for Compute Ops Management Enhanced 3-year Monthly ProLiant SaaS R7A14AAE

HPE GreenLake for Compute Ops Management Enhanced 5-year Monthly ProLiant SaaS R7A15AAE

HPE GreenLake for Compute Ops Management Enhanced 1-year Quarterly ProLiant SaaS R7A16AAE

HPE GreenLake for Compute Ops Management Enhanced 3-year Quarterly ProLiant SaaS R7A17AAE

HPE GreenLake for Compute Ops Management Enhanced 5-year Quarterly ProLiant SaaS R7A18AAE

HPE GreenLake for Compute Ops Management Enhanced 3-year Annual ProLiant SaaS R7A19AAE

HPE GreenLake for Compute Ops Management Enhanced 5-year Annual ProLiant SaaS R7A20AAE

##### HPE OneView

HPE OneView including 3yr 24x7 Support Flexible Quantity E-LTU E5Y35AAE

HPE OneView w/o iLO including 3yr 24x7 Support Flexible Quantity E-LTU P8B26AAE

**Notes:** For customers purchasing HPE GreenLake for Compute Ops Management, without a hardware purchase or a BTO purchase, use this base SKU within ASQ order:

HPE GreenLake for Compute Ops Management Base SaaS R6Z73AAE

For more information, visit the HPE GreenLake for Compute Ops Management QuickSpecs:

<https://www.hpe.com/psnow/doc/a50004263enw>

Supported Servers – CTO only. No OEM. – Complete list can be found here: Latest Supported Server List:

<https://www.hpe.com/info/com-supported-servers>



## Additional Options

### HPE Unique Options

#### Risers

**Notes:** Primary slot riser is default ship in the CTO server.

HPE ProLiant DL3X5 Gen11 1U x16 Low Profile Secondary Riser Kit

P55029-B21

HPE ProLiant DL3X5 Gen11 1U x16 Riser Kit

P56915-B21

#### Notes:

- Both riser kits are in the secondary slot.
- Low Profile Secondary riser kit (P55029-B21) requires NS204i-u Gen11 NVMe boot device (P48183-B21) in the order.

#### Cooling

HPE ProLiant DL3X5 Gen11 CPU Standard 1U Heat Sink Kit

P58456-B21

HPE ProLiant DL3X5 Gen11 CPU Performance 1U Heat Sink Kit

P58457-B21

#### Notes:

- For processors less than or equal to 240W, standard heat sink (P58456-B21) and 7 standard FAN kit(P58461-B21) are required.
- For processors more than or equal to 260W and less or equal than 300W, performance heat sink kit (P58457-B21) and 7 performance FAN kit (P58462-B21) are required.
- For processors more than or equal to 320W, Closed-Loop Liquid Cooling Heat Sink FIO kit(P58463-B21) and 7 liquid FAN kit (P59668-B21) are required.

HPE ProLiant DL3XX Gen11 1U Standard Fan Kit

P58461-B21

HPE ProLiant DL3XX Gen11 1U Performance Fan Kit

P58462-B21

HPE ProLiant DL325 Gen11 Liquid Cooling Fan Kit

P59668-B21

#### Notes:

- Requires to select 7 fan kits in every DL325 Gen11 server
- Mixing of different FAN kit is not supported
- The liquid cooling Fan kit must be selected when Closed-Loop Liquid Cooling Heat Sink FIO kit (P58463-B21) is in the order
- Performance Fan Kit (P58462-B21) must be selected if any of the below options is in the order
  - o 8SFF x4 U.3 backplane kit (P55000-B21)
  - o 2SFF x4 U.3 backplane kit (P56652-B21)
  - o 10 NVMe/SAS drives selected in the order
  - o Networking options: 10/25G options, 100/200G options, Infiniband options.

#### Cooling options summary – SFF and LFF CTO servers

CPU cTDP	= < 240W	260W – 300W	>= 320 W
Heatsink	Standard (P58456-B21)	Performance (P58457-B21)	Closed-Loop Liquid Cooling (P58436-B21)
Fans	7 Standard (P58461-B21)	7 Performance (P58462-B21)	7 Liquid Cooling (P59668-B21)

#### Cooling options summary – EDSFF CTO server

CPU cTDP	<= 300W	>= 320 W
Heatsink	Performance (P58457-B21)	Closed-Loop Liquid Cooling (P58436-B21)
Fans	7 Performance (P58462-B21)	7 Liquid Cooling (P59668-B21)

#### Notes:

- The cooling options summary of GPU CTO servers will be available soon.



## Additional Options

- When 4LFF CTO, standard FAN kit and standard heatsink kit are in the order, the recommended ambient temperature is 27c.

### Drive Cage

#### Notes:

- Maximum one(1) 2SFF backplane kits could be selected together with 8SFF backplane kit, to support up to 10SFF in total.

HPE ProLiant DL325 Gen11 1U 2SFF x4 NVMe U.3 BC Backplane Kit P56652-B21

#### Notes:

- Supports 2 SFF SAS/SATA/ NVMe (U.3) Basic Carrier (BC) Drives.
- Includes Direct attach cables
- When this 2SFF U.3 Backplane kit is selected, one of the following cable options must in the order:
  - o with smart array controllers at PCIe slot: 2SFF x4 Secondary Tri-Mode Cable Kit (P59621-B21)
  - o with smart array controllers at OCP slot: 2SFF x4 OCP2 Tri-Mode Cable Kit (P59620-B21)
  - o 2 SFF NVMe direct attach: no additional cable kit selection required
  - o 2 SFF SAS/SATA direct attach: 2SFF SATA Direct Attach Cable Kit (P59617-B21)
- Can be paired with either 8SFF x1 U.3 Backplane Kit (P54999-B21) or 8SFF x4 U.3 Backplane Kit (P55000-B21)
- Can not be selected if Optical drive (726536-B21 & 726537-B21) is in the order

### HPE Boot Controllers

HPE NS204i-u Gen11 NVMe Hot Plug Boot Optimized Storage Device P48183-B21

#### Notes:

- RAID 1 is preconfigured on this option and additional RAID cannot be applied on this Boot Device
- Requires 7 performance fan kit (P58462-B21) or 7 liquid cooling fan kit (P59668-B21) in the order
- If this boot storage device and 7 liquid cooling fan kit (P59668-B21) are selected, the 2SFF drive cage (P56652-B21) can not be selected and Recommended System Ambient Temperature is 25c.

HPE ProLiant DL3X5 Gen11 NS204i-u NVMe Hot Plug Boot Device Cable Kit P57013-B21

**Notes:** This cable kit and Secondary Low Profile riser kit (P55029-B21) must be selected together with the NS204i-u storage device (P48183-B21).

### HPE Optical Drives

HPE 9.5mm SATA DVD-ROM Optical Drive 726536-B21

HPE 9.5mm SATA DVD-RW Optical Drive 726537-B21

HPE Mobile USB DVD-RW Optical Drive 701498-B21

HPE ProLiant DL325 Gen11 8SFF Display Port/USB/Optical Drive Blank Kit P56654-B21

HPE ProLiant DL325 Gen11 4LFF Display Port/USB/Optical Drive Blank Kit P56655-B21

#### Notes:

- Maximum 1 Optical Drive is supported.
- 2SFF backplane kits (P56652-B21) could not be selected if Optical drives (726536-B21 & 726537-B21) is in the order.
- If optical drive is selected along with 8 SFF CTO server (P54199-B21) then 8SFF ODD blank kit (P56654-B21) must in the order.
- If optical drive is selected along with 4 LFF CTO server (P54200-B21) then 4LFF ODD blank kit (P56655-B21) must in the order.
- Both 8SFF ODD blank kit (P56654-B21) and 4LFF ODD blank kit (P56655-B21) support one(1) Display Port and one(1) USB 2.0 port.





## Additional Options

### HPE Smart Array Controllers

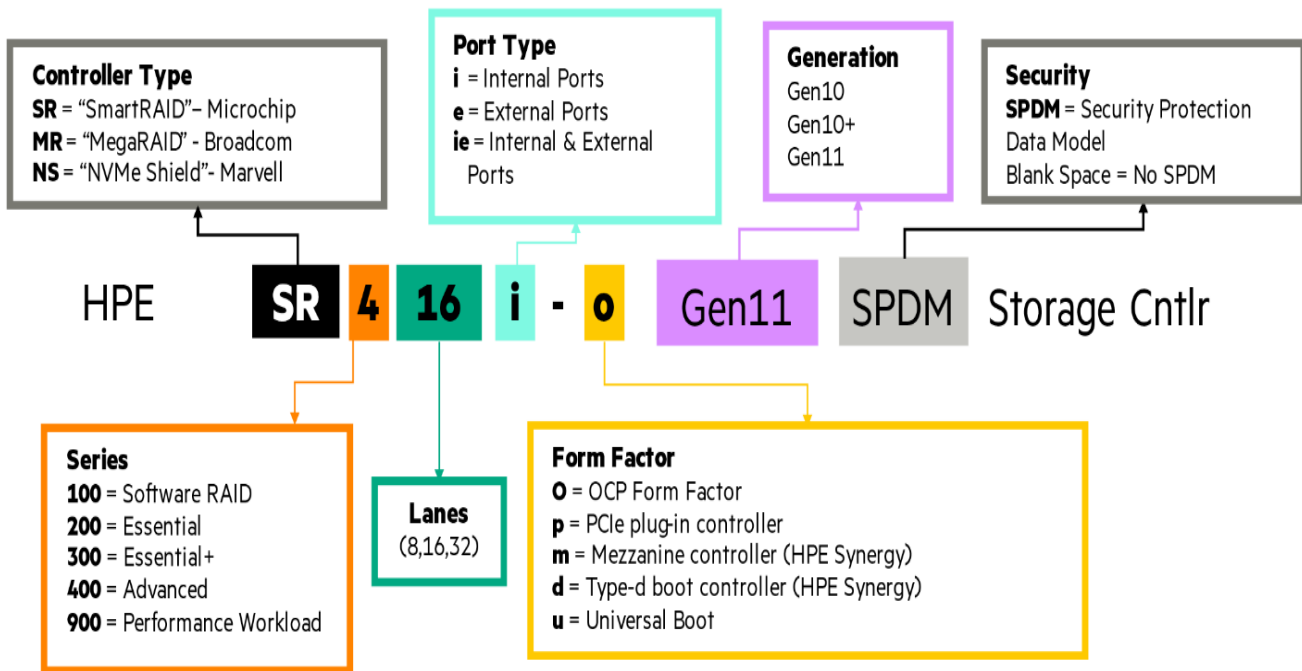
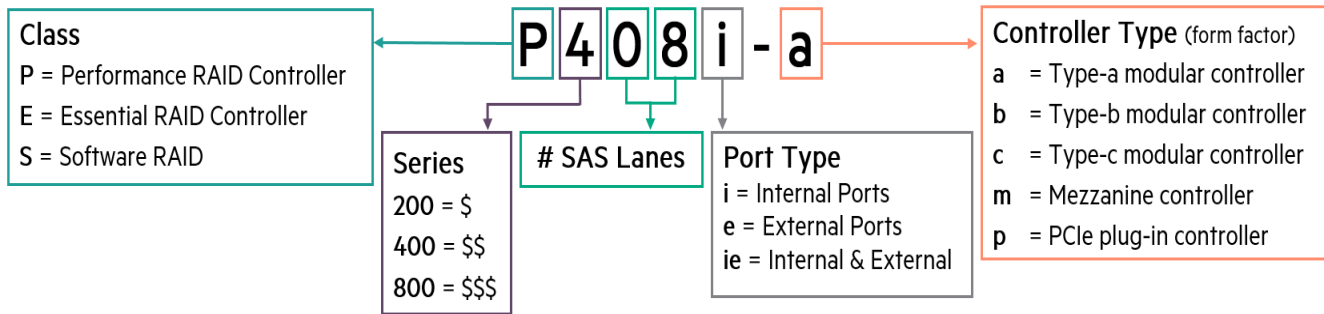

### Smart Array Controllers

**Notes:**

- When selecting SR RAID controllers for external storage (E208e, 804398-B21) and MR RAID controllers for internal storage (MR216i/MR416i/MR408i) in the order, please be aware these two products use different RAID configuration tools.
- Not supporting mixing of MR (MegaRAID) series internal controllers and SR (SmartRAID) series internal controllers
- For more information on the HPE Gen11 Storage Controller, please refer to: [HPE Compute MR Gen11 Controllers Quick Spec](#)

### Essential RAID Controllers

HPE Smart Array E208e-p SR Gen10 Controller

804398-B21

**Notes:**

- This controller supports up to 8 SAS/SATA Drives (external)
- For more information on the HPE Smart Array E208i-p SR Gen10 Controller, please refer to the [QuickSpecs](#)



## Additional Options

### Tri-mode RAID Controllers

HPE MR216i-o Gen11 x16 Lanes without Cache OCP SPDM Storage Controller P47789-B21

**Notes:**

- This controller supports up to 16 SAS/SATA/NVMe Drives
- Does not occupy a PCIe expansion slot

HPE MR408i-o Gen11 x8 Lanes 4GB Cache OCP SPDM Storage Controller P58335-B21

**Notes:**

- This controller supports up to 8 SAS/SATA/NVMe Drives
- Does not occupy a PCIe expansion slot
- 96W Smart Stg Li-ion Batt 145mm Kit (P01366-B21) OR Smart Hybrid Capacitor w/ 145mm Cbl (P02377-B21) must be selected with this controller

HPE MR416i-o Gen11 x16 Lanes 8GB Cache OCP SPDM Storage Controller P47781-B21

**Notes:**

- This controller supports up to 16 SAS/SATA/NVMe Drives
- Does not occupy a PCIe expansion slot
- 96W Smart Stg Li-ion Batt 145mm Kit (P01366-B21) OR Smart Hybrid Capacitor w/ 145mm Cbl (P02377-B21) must be selected with this controller.

HPE MR216i-p Gen11 x16 Lanes without Cache PCI SPDM Plug-in Storage Controller P47785-B21

**Notes:** This controller supports up to 16 SAS/SATA/NVMe Drives

HPE MR416i-p Gen11 x16 Lanes 8GB Cache PCI SPDM Plug-in Storage Controller P47777-B21

**Notes:**

- This controller supports up to 16 SAS/SATA/NVMe Drives
- 96W Smart Stg Li-ion Batt 145mm Kit (P01366-B21) OR Smart Hybrid Capacitor w/ 145mm Cbl (P02377-B21) must be selected with this controller.

HPE SR932i-p Gen11 x32 Lanes 8GB Wide Cache PCI SPDM Plug-in Storage Controller P47184-B21

**Notes:**

- This controller supports up to 32 SAS/SATA/NVMe Drives
- 96W Smart Stg Li-ion Batt 145mm Kit (P01366-B21) OR Smart Hybrid Capacitor w/ 145mm Cbl (P02377-B21) must be selected with this controller.

### Controller Battery Cable Kits

HPE Smart Storage Hybrid Capacitor with 145mm Cable Kit P02377-B21

HPE 96W Smart Storage Lithium-ion Battery with 145mm Cable Kit P01366-B21

HPE ProLiant DL325 Gen11 Megacell Extension Cable Kit P56659-B21

**Notes:**

- The two 145mm cable kit (P02377-b21 and P01366-B21) can't be selected together in the order.
- The megacell extension cable kit is required when M.2 enablement kit (P57014-B21) or one of the two 145mm cable kit (P02377-B21, P01366-B21) is in the order.



## Additional Options

### HPE Drives

#### Enterprise - 12G SAS - SFF Drives

HPE 300GB SAS 12G Mission Critical 15K SFF BC 3-year Warranty Multi Vendor HDD	P28028-B21
HPE 2.4TB SAS 12G Mission Critical 10K SFF BC 3-year Warranty 512e Multi Vendor HDD	P28352-B21
HPE 1.2TB SAS 12G Mission Critical 10K SFF BC 3-year Warranty Multi Vendor HDD	P28586-B21
HPE 300GB SAS 12G Mission Critical 10K SFF BC 3-year Warranty Multi Vendor HDD	P40430-B21
HPE 900GB SAS 12G Mission Critical 15K SFF BC 3-year Warranty Multi Vendor HDD	P40432-B21
HPE 600GB SAS 12G Mission Critical 15K SFF BC 3-year Warranty Multi Vendor HDD	P53560-B21
HPE 600GB SAS 12G Mission Critical 10K SFF BC 3-year Warranty Multi Vendor HDD	P53561-B21
HPE 1.8TB SAS 12G Mission Critical 10K SFF BC 3-year Warranty 512e Multi Vendor HDD	P53562-B21

#### Midline - 12G SAS - SFF Drives

HPE 2TB SAS 12G Business Critical 7.2K SFF BC 1-year Warranty 512e HDD	P28505-B21
HPE 1TB SAS 12G Business Critical 7.2K SFF BC 1-year Warranty HDD	P53563-B21

#### Midline - 12G SAS - LFF Drives

HPE 12TB SAS 12G Business Critical 7.2K LFF LP 1-year Warranty Helium 512e Multi Vendor HDD	881781-B21
HPE 14TB SAS 12G Business Critical 7.2K LFF LP 1-year Warranty Helium 512e Multi Vendor HDD	P09155-B21
HPE 8TB SAS 12G Business Critical 7.2K LFF LP 1-year Warranty 512e Multi Vendor HDD	834031-B21
HPE 2TB SAS 12G Business Critical 7.2K LFF LP 1-year Warranty Multi Vendor HDD	833926-B21
HPE 4TB SAS 12G Business Critical 7.2K LFF LP 1-year Warranty Multi Vendor HDD	833928-B21
HPE 6TB SAS 12G Business Critical 7.2K LFF LP 1-year Warranty 512e Multi Vendor HDD	861746-B21
HPE 16TB SAS 12G Business Critical 7.2K LFF LP 1-year Warranty Helium 512e ISE Multi Vendor HDD	P23608-B21
HPE 18TB SAS 12G Business Critical 7.2K LFF LP 1-year Warranty Helium 512e ISE Multi Vendor HDD	P37669-B21
HPE 10TB SAS 12G Business Critical 7.2K LFF LP 1-year Warranty 512e ISE Multi Vendor HDD	P53556-B21
HPE 20TB SAS 12G Business Critical 7.2K LFF LP 1-year Warranty Helium 512e ISE Multi Vendor HDD	P53553-B21

#### Midline - 6G SATA - SFF Drives

HPE 1TB SATA 6G Business Critical 7.2K SFF BC 1-year Warranty HDD	P28610-B21
HPE 2TB SATA 6G Business Critical 7.2K SFF BC 1-year Warranty 512e HDD	P28500-B21

#### Midline - 6G SATA - LFF Drives

HPE 2TB SATA 6G Business Critical 7.2K LFF LP 1-year Warranty Multi Vendor HDD	861681-B21
HPE 4TB SATA 6G Business Critical 7.2K LFF LP 1-year Warranty Multi Vendor HDD	861683-B21
HPE 1TB SATA 6G Business Critical 7.2K LFF LP 1-year Warranty Multi Vendor HDD	861686-B21
HPE 12TB SATA 6G Business Critical 7.2K LFF LP 1-year Warranty Helium 512e Multi Vendor HDD	881787-B21
HPE 14TB SATA 6G Business Critical 7.2K LFF LP 1-year Warranty Helium 512e Multi Vendor HDD	P09165-B21
HPE 8TB SATA 6G Business Critical 7.2K LFF LP 1-year Warranty 512e Multi Vendor HDD	834028-B21
HPE 6TB SATA 6G Business Critical 7.2K LFF LP 1-year Warranty 512e Multi Vendor HDD	861742-B21



## Additional Options

HPE 16TB SATA 6G Business Critical 7.2K LFF LP 1-year Warranty Helium 512e ISE Multi Vendor HDD	P23449-B21
HPE 18TB SATA 6G Business Critical 7.2K LFF LP 1-year Warranty Helium 512e ISE Multi Vendor HDD	P37678-B21
HPE 10TB SATA 6G Business Critical 7.2K LFF LP 1-year Warranty 512e ISE Multi Vendor HDD	P53557-B21
HPE 20TB SATA 6G Business Critical 7.2K LFF LP 1-year Warranty Helium 512e ISE Multi Vendor HDD	P53554-B21

### SED (Self-Encryption Drive)

HPE 2.4TB SAS 12G Mission Critical 10K SFF BC 3-year Warranty 512e Self-encrypting HDD	P28618-B21
HPE 1.2TB SAS 12G Mission Critical 10K SFF BC 3-year Warranty Self-encrypting HDD	P28622-B21

### Notes: Requirements for MR Tri-mode controller SED support

- TPM is not required for Local Key Management as key is stored in controller
- iLO Advanced is required for Remote Key Management. Key is stored in remote key manager
- (Ex. ESKM)

## SSD Selection

### Read Intensive - 12G SAS - SFF - Solid State Drives

HPE 960GB SAS 12G Read Intensive SFF BC Value SAS Multi Vendor SSD	P40506-B21
HPE 1.92TB SAS 12G Read Intensive SFF BC Value SAS Multi Vendor SSD	P40507-B21
HPE 3.84TB SAS 12G Read Intensive SFF BC Value SAS Multi Vendor SSD	P40508-B21
HPE 7.68TB SAS 12G Read Intensive SFF BC Value SAS Multi Vendor SSD	P40509-B21
HPE 1.92TB SAS 24G Read Intensive SFF BC Multi Vendor SSD	P49031-B21

### Mixed Use - 12G SAS - SFF - Solid State Drives

HPE 960GB SAS 12G Mixed Use SFF BC Value SAS Multi Vendor SSD	P40510-B21
HPE 1.92TB SAS 12G Mixed Use SFF BC Value SAS Multi Vendor SSD	P40511-B21
HPE 3.84TB SAS 12G Mixed Use SFF BC Value SAS Multi Vendor SSD	P40512-B21
HPE 1.6TB SAS 24G Mixed Use SFF BC Multi Vendor SSD	P49049-B21

### Mixed Use SAS- LFF- Solid State Drives

HPE 960GB SAS 12G Mixed Use LFF LPC Value SAS Multi Vendor SSD	P37009-B21
--	------------

### Mixed Use - 6G SATA - SFF - Solid State Drives

HPE 480GB SATA 6G Mixed Use SFF BC Multi Vendor SSD	P40502-B21
HPE 960GB SATA 6G Mixed Use SFF BC Multi Vendor SSD	P40503-B21
HPE 1.92TB SATA 6G Mixed Use SFF BC Multi Vendor SSD	P40504-B21
HPE 3.84TB SATA 6G Mixed Use SFF BC Multi Vendor SSD	P40505-B21
HPE 480GB SATA 6G Mixed Use SFF BC PM897 SSD	P44011-B21
HPE 960GB SATA 6G Mixed Use SFF BC PM897 SSD	P44012-B21
HPE 1.92TB SATA 6G Mixed Use SFF BC PM897 SSD	P44013-B21

### Read Intensive - 6G SATA - SFF - Solid State Drives

HPE 240GB SATA 6G Read Intensive SFF BC Multi Vendor SSD	P40496-B21
HPE 480GB SATA 6G Read Intensive SFF BC Multi Vendor SSD	P40497-B21
HPE 960GB SATA 6G Read Intensive SFF BC Multi Vendor SSD	P40498-B21
HPE 1.92TB SATA 6G Read Intensive SFF BC Multi Vendor SSD	P40499-B21
HPE 3.84TB SATA 6G Read Intensive SFF BC Multi Vendor SSD	P40500-B21
HPE 7.68TB SATA 6G Read Intensive SFF BC Multi Vendor SSD	P40501-B21
HPE 480GB SATA 6G Read Intensive SFF BC PM893 SSD	P44007-B21
HPE 960GB SATA 6G Read Intensive SFF BC PM893 SSD	P44008-B21
HPE 1.92TB SATA 6G Read Intensive SFF BC PM893 SSD	P44009-B21
HPE 3.84TB SATA 6G Read Intensive SFF BC PM893 SSD	P44010-B21



## Additional Options

### Read Intensive – 6G SATA - LFF – Solid State Drives

HPE 960GB SATA 6G Read Intensive LFF LPC Multi Vendor SSD P47808-B21

### Write Intensive – NVMe – SFF – Solid State Drives

HPE 400GB NVMe Gen4 High Performance Low Latency Write Intensive SFF BC U.2 P5800X SSD P51465-B21

HPE 800GB NVMe Gen4 High Performance Low Latency Write Intensive SFF BC U.2 P5800X SSD P51467-B21

### Read Intensive - NVMe - SFF - Solid State Drives

HPE 1.92TB NVMe Gen4 High Performance Read Intensive SFF BC U.2 P5520 SSD P51453-B21

HPE 3.84TB NVMe Gen4 High Performance Read Intensive SFF BC U.2 P5520 SSD P51455-B21

HPE 7.68TB NVMe Gen4 High Performance Read Intensive SFF BC U.2 P5520 SSD P51457-B21

HPE 1.92TB NVMe Gen4 High Performance Read Intensive SFF BC U.3 PM1733a SSD P50216-B21

HPE 3.84TB NVMe Gen4 High Performance Read Intensive SFF BC U.3 PM1733a SSD P50219-B21

HPE 7.68TB NVMe Gen4 High Performance Read Intensive SFF BC U.3 PM1733a SSD P50222-B21

HPE 15.36TB NVMe Gen4 High Performance Read Intensive SFF BC U.3 PM1733a SSD P50224-B21

### Mixed Use - NVMe - SFF - Solid State Drives

HPE 1.6TB NVMe Gen4 High Performance Mixed Use SFF BC U.2 P5620 SSD P51459-B21

HPE 3.2TB NVMe Gen4 High Performance Mixed Use SFF BC U.2 P5620 SSD P51461-B21

HPE 6.4TB NVMe Gen4 High Performance Mixed Use SFF BC U.2 P5620 SSD P51463-B21

HPE 1.6TB NVMe Gen4 High Performance Mixed Use SFF BC U.3 PM1735a SSD P50227-B21

HPE 3.2TB NVMe Gen4 High Performance Mixed Use SFF BC U.3 PM1735a SSD P50230-B21

HPE 6.4TB NVMe Gen4 High Performance Mixed Use SFF BC U.3 PM1735a SSD P50233-B21

### Internal M.2 Kit

HPE ProLiant DL325 Gen11 SATA PCIe Cable Kit P57014-B21

#### Notes:

- Requires two (2) M.2 SSD Drives In the same interface (SATA or NVMe).
- This M.2 enablement kit does not occupy a PCIe slot.
- No RAID is supported on this M.2 enablement kit.
- If this M.2 enablement kit and 7 liquid cooling fan kit (P59668-B21) are selected, the 2SFF drive cage (P56652-B21) can not be in the order and Recommended System Ambient Temperature is 25c.

### Read Intensive - 6G SATA - M.2 - Solid State Drives

HPE 240GB SATA 6G Read Intensive M.2 Multi Vendor SSD P47817-B21

HPE 480GB SATA 6G Read Intensive M.2 Multi Vendor SSD P47818-B21

### Read Intensive - NVMe - M.2 - Solid State Drives

HPE 480GB NVMe Gen3 Mainstream Performance Read Intensive M.2 Multi Vendor SSD P40513-B21

HPE 960GB NVMe Gen3 Mainstream Performance Read Intensive M.2 Multi Vendor SSD P40514-B21

HPE 1.92TB NVMe Gen3 Mainstream Performance Read Intensive M.2 Multi Vendor SSD P40515-B21

## HPE Networking

#### Notes:

- Maximum 2 OCP adapters and 2 PCIe adapters are supported.
- Direct Attach Cable (DAC) for copper environments or fiber transceivers and cables for fiber-optic environments must be purchased separately. Please see the related NIC QuickSpecs for Technical Specifications and additional information:

<https://h20195.www2.hp.com/v2/getpdf.aspx/A00002507ENW.pdf>



## Additional Options

### PCIe Adapters

#### 1 Gigabit Ethernet adapters

Intel I350-T4 Ethernet 1Gb 4-port BASE-T Adapter for HPE	P21106-B21
Broadcom BCM5719 Ethernet 1Gb 4-port BASE-T Adapter for HPE	P51178-B21

#### 10 Gigabit Ethernet adapters

Broadcom BCM57416 Ethernet 10Gb 2-port BASE-T Adapter for HPE	P26253-B21
Broadcom BCM57412 Ethernet 10Gb 2-port SFP+ Adapter for HPE	P26259-B21

#### 10/25 Gigabit Ethernet adapters

**Notes:** Require 7 performance fan kit (P58462-B21) or 7 liquid cooling fan kit (P59668-B21) in the order and subject to the recommended system ambient temperature.

Broadcom BCM57414 Ethernet 10/25Gb 2-port SFP28 Adapter for HPE	P26262-B21
Broadcom BCM57504 Ethernet 10/25Gb 4-port SFP28 Adapter for HPE	P26264-B21
Intel E810-XXVDA2 Ethernet 10/25Gb 2-port SFP28 Adapter for HPE	P08443-B21
Mellanox MCX631102AS-ADAT Ethernet 10/25Gb 2-port SFP28 Adapter for HPE	P42044-B21
Intel E810-XXVDA4 Ethernet 10/25Gb 4-port SFP28 Adapter for HPE	P08458-B21

#### 100/200 Gigabit Ethernet adapters

##### Notes:

- Require 7 performance fan kit (P58462-B21) or 7 liquid cooling fan kit (P59668-B21) in the order and subject to the recommended system ambient temperature
- Up to one(1) 100/200G Ethernet adapters or one(1) Infiniband card can be supported.

Mellanox MCX623106AS-CDAT Ethernet 100Gb 2-port QSFP56 Adapter for HPE	P25960-B21
Intel E810-CQDA2 Ethernet 100Gb 2-port QSFP28 Adapter for HPE	P21112-B21
Mellanox MCX623105AS-VDAT Ethernet 200Gb 1-port QSFP56 Adapter for HPE	P10180-B21

#### Recommended System Ambient Temperature – With 7 Performance Fan (P58462-B21)

PCIe Slot	P10180-B21	P42044-B21	P25960-B21	P08458-B21	P21112-B21	P26264-B21
Slot 1	35C	35C	35C	35C	35C	35C
Slot 2	Not Support	25C	Not Support	25C	25C	25C

#### Recommended System Ambient Temperature - With 7 Liquid Cooling Fan (P59668-B21)

PCIe Slot	P10180-B21	P42044-B21	P25960-B21	P08458-B21	P21112-B21	P26264-B21
Slot 1	25C	35C	25C	35C	35C	35C
Slot 2	Not Support	25C	Not Support	25C	25C	25C

## Additional Options

### OCP Adapter

#### 1 Gigabit Ethernet OCP adapters

Intel I350-T4 Ethernet 1Gb 4-port BASE-T OCP3 Adapter for HPE	P08449-B21
Broadcom BCM5719 Ethernet 1Gb 4-port BASE-T OCP3 Adapter for HPE	P51181-B21

#### 10 Gigabit Ethernet OCP Adapters

Broadcom BCM57412 Ethernet 10Gb 2-port SFP+ OCP3 Adapter for HPE	P26256-B21
Broadcom BCM57416 Ethernet 10Gb 2-port BASE-T OCP3 Adapter for HPE	P10097-B21

#### 10/25 Gigabit Ethernet OCP adapters

**Notes:** Requires 7 performance fan kit (P58462-B21) or 7 liquid cooling fan kit (P59668-B21) in the order and subject to the recommended system ambient temperature

Broadcom BCM57414 Ethernet 10/25Gb 2-port SFP28 OCP3 Adapter for HPE	P10115-B21
Broadcom BCM57504 Ethernet 10/25Gb 4-port SFP28 OCP3 Adapter for HPE	P26269-B21
Intel E810-XXVDA2 Ethernet 10/25Gb 2-port SFP28 OCP3 Adapter for HPE	P10106-B21
Mellanox MCX631432AS-ADAI Ethernet 10/25Gb 2-port SFP28 OCP3 Adapter for HPE	P42041-B21

#### 100/200 Gigabit Ethernet adapters

##### Notes:

- Requires 7 performance fan kit (P58462-B21) or 7 liquid cooling fan kit (P59668-B21) in the order and subject to the recommended system ambient temperature
- Up to one(1) 100/200G Ethernet adapters or one(1) Infiniband card can be supported.
- Requires OCP1 upgrade cable kit (P56658-B21) in the order to support PCIe Gen5 x16 bandwidth.

Intel E810-CQDA2 Ethernet 100Gb 2-port QSFP28 OCP3 Adapter for HPE	P22767-B21
--	------------

#### Recommended System Ambient Temperature – With 7 Performance Fan (P58462-B21)

OCP Slot	P26269-B21	P10106-B21	P42041-B21	P22767-B21
Slot 21	35C	35C	35C	35C
Slot 22	Not Support	25C	25C	Not Support

#### Recommended System Ambient Temperature– With 7 Liquid Cooling Fan (P59668-B21)

OCP Slot	P26269-B21	P10106-B21	P42041-B21	P22767-B21
Slot 21	35C	35C	35C	35C
Slot 22	Not Support	25C	25C	Not Support

## HPE InfiniBand

##### Notes:

- Require 7 performance fan kit (P58462-B21) or 7 liquid cooling fan kit (P59668-B21) in the order and subject to the recommended system ambient temperature
- Up to 1 100/200G Ethernet adapters or 1 Infiniband card can be supported
- Requires OCP1 upgrade cable kit (P56658-B21) in the order to support PCIe Gen5 x16 bandwidth.
- For more information, please visit: [HPE InfiniBand Options for HPE ProLiant and Apollo Servers](#)

HPE InfiniBand HDR100/Ethernet 100Gb 1-port QSFP56 PCIe4 x16 MCX653105A-ECAT Adapter	P23665-B21
HPE InfiniBand HDR100/Ethernet 100Gb 2-port QSFP56 PCIe4 x16 MCX653106A-ECAT Adapter	P23666-B21
HPE InfiniBand HDR/Ethernet 200Gb 1-port QSFP56 PCIe4 x16 MCX653105A-HDAT Adapter	P23664-B21
HPE InfiniBand HDR/Ethernet 200Gb 2-port QSFP56 PCIe4 x16 MCX653106A-HDAT Adapter	P31324-B21
HPE InfiniBand HDR/Ethernet 200Gb 1-port QSFP56 PCIe4 x16 OCP3 MCX653435A-HDAI Adapter	P31323-B21
HPE InfiniBand HDR/Ethernet 200Gb 2-port QSFP56 PCIe4 x16 OCP3 MCX653436A-HDAI Adapter	P31348-B21

## Additional Options

### Recommended System Ambient Temperature – With 7 Performance Fan (P58462-B21)

PCIe Slot	P23664-B21	P23666-B21	P31324-B21	P31323-B21	P31348-B21
Slot 1	35C	35C	35C	35C	35C
Slot 2	25C	25C	Not Support	Not Support	Not Support

### Recommended System Ambient Temperature– With 7 Liquid Cooling Fan (P59668-B21)

PCIe Slot	P23664-B21	P23666-B21	P31324-B21	P31323-B21	P31348-B21
Slot 1	35C	35C	25C	25C	Not Support
Slot 2	25C	25C	Not Support	Not Support	Not Support

HPE ProLiant DL325 Gen11 OCP Upgrade Cable Kit

P56658-B21

**Notes:** Support PCIe x16 bandwidth at OCP1 slot. Requires following options in the order

- OCP InfiniBand network adapters (P31323-B21, P31348-B21)
- BCM 57504 10/25GbE 4p SFP28 Adaptor (P26269-B21)
- E810 100GbE 2p QSFP28 OCP3 Adptr (P22767-B21)

## HPE Power Supplies

HPE Flexible Slot (Flex Slot) Power Supplies share a common electrical and physical design that allows for hot plug, tool-less installation into HPE ProLiant Servers. Flex Slot power supplies are certified for high-efficiency operation and offer multiple power output options, allowing users to "right-size" a power supply for specific server configurations. This flexibility helps to reduce power waste, lower overall energy costs, and avoid "trapped" power capacity in the data center.

### Notes:

- Prior to making a power supply selection it is highly recommended that the HPE Power Advisor is run to determine the right size power supply for your server configuration. The HPE Power Advisor is located at: <https://poweradviseorx.it.hpe.com/?Page=Index>
- HPE ProLiant servers ship with an IEC-IEC power cord used for rack mounting with Power Distribution Units (PDUs). Visit [HPE Power Cords and Cables](#) for a full list of optional power cords.

HPE 500W Flex Slot Platinum Hot Plug Low Halogen Power Supply Kit

865408-B21

**Notes:** Flex Slot Platinum Plus power supplies support power efficiency of up to 94% and include a C-14 power inlet connector that can support HPE Power Discovery Services (blue connector).

HPE 800W Flex Slot Platinum Hot Plug Low Halogen Power Supply Kit

P38995-B21

**Notes:** Flex Slot Platinum Plus power supplies support power efficiency of up to 94% and include a C-14 power inlet connector that can support HPE Power Discovery Services (blue connector).

HPE 1600W Flex Slot -48VDC Hot Plug Power Supply Kit

P17023-B21

### Notes:

- Flex Slot universal power supplies support power efficiency of up to 94% and support both 277VAC/380VDC power inputs.
- HPE 1600W DC PSU Power Lug Option Kit (P36877-B21) must be selected along with this power supplies.

HPE 1600W Flex Slot Platinum Hot Plug Low Halogen Power Supply Kit

P38997-B21

### Notes:

- Flex Slot Platinum Plus power supplies support power efficiency of up to 94% and include a C-14 power inlet connector that can support HPE Power Discovery Services (blue connector).
- The power supply selected only supports high line voltage (200VAC to 240VAC)

HPE 1600W -48VDC Power Cable Lug Kit

P36877-B21

**Notes:** Must be selected along with HPE 1600W Flex Slot -48VDC Hot Plug Power Supply Kit (P17023-B21)





## Additional Options

### Embedded Management

#### HPE iLO Advanced

HPE iLO Advanced Electronic License with 1yr Support on iLO Licensed Features	E6U59ABE
HPE iLO Advanced Electronic License with 3yr Support on iLO Licensed Features	E6U64ABE
HPE iLO for Open Distributed Infrastructure Management 3-year 24x7 LTU	R4H59A
HPE iLO for Open Distributed Infrastructure Management 1-year 24x7 LTU	R4H60A
HPE iLO for Open Distributed Infrastructure Management 3-year 24x7 E-LTU	R4H61AAE
HPE iLO for Open Distributed Infrastructure Management 1-year 24x7 E-LTU	R4H62AAE
HPE iLO for Open Distributed Infrastructure Management 3-year 24x7 AKA Tracking E-LTU	R4H63AAE
HPE iLO for Open Distributed Infrastructure Management 1-year 24x7 AKA Tracking E-LTU	R4H64AAE
HPE iLO Advanced 1-server License with 3yr Support on iLO Licensed Features	BD505A
HPE iLO Advanced Flexible Quantity License with 3yr Support on iLO Licensed Features	BD506A
HPE iLO Advanced AKA Tracking License with 3yr Support on iLO Licensed Features	BD507A
HPE iLO Advanced 1-server License with 1yr Support on iLO Licensed Features	512485-B21
HPE iLO Advanced Flexible Quantity License with 1yr Support on iLO Licensed Features	512486-B21
HPE iLO Advanced AKA Tracking License with 1yr Support on iLO Licensed Features	512487-B21

#### HPE Converged Infrastructure Management Software

HPE OneView Standard 1yr 9x5 Support Flexible Quantity E-RTU	K6F98AAE
HPE OneView w/o iLO including 3yr 24x7 Support 1-server LTU	P8B24A
HPE OneView w/o iLO including 3yr 24x7 Support Track 1-server LTU	P8B25A
HPE OneView w/o iLO including 3yr 24x7 Support Flexible Quantity E-LTU	P8B26AAE
HPE OneView including 3yr 24x7 Support Flexible Quantity E-LTU	E5Y35AAE
HPE OneView Upgrade from Insight Management 3yr 24x7 Support 1-server LTU	F6Q91A
HPE OneView including 3yr 24x7 Support Physical 1-server LTU	E5Y34A
HPE OneView including 3yr 24x7 Support Track 1-server LTU	E5Y36A
HPE OneView for ProLiant DL Server including 3yr 24x7 Support Bundle Track 1-server LTU	E5Y44A
HPE OneView Upgrade from Insight Management including 3yr 24x7 Support Flexible Quantity E-LTU	E5Y45AAE

**Notes:** Licenses ship without media. The HPE OneView Media Kit can be ordered separately, or can be downloaded.

#### HPE Security

HPE Bezel Lock Kit	875519-B21
HPE ProLiant DL3XX Gen11 Intrusion Cable Kit	P48922-B21
HPE ProLiant DL3X5 Gen11 1U Common Bezel Kit	P50450-B21

**Notes:** The Bezel lock kit(875519-B21) must be select along with the bezel kit(P50450-B21)



## Additional Options

### HPE Cable Options

HPE ProLiant DL325 Gen11 8SFF x4 NVMe SR932i-p Slot 1 Cable Kit	P57004-B21
<b>Notes:</b> supports 8 SFF U.3 NVMe/SAS/SATA connecting to SR932i-p controllers at the primary riser slot with up to x4 speed.	
HPE ProLiant DL325 Gen11 8SFF x4 NVMe SR932i-p Slot 2 Cable Kit	P57005-B21
<b>Notes:</b> supports 8 SFF U.3 NVMe/SAS/SATA connecting to SR932i-p controllers at the secondary riser slot with up to x4 speed.	
HPE ProLiant DL325 Gen11 8SFF x2 NVMe to Tri-Mode PCIe Cable Kit	P57006-B21
<b>Notes:</b> supports 8 SFF U.3 NVMe/SAS/SATA connecting with smart array controllers at primary riser slot with x2 speed.	
HPE ProLiant DL325 Gen11 8SFF x2 NVMe to Tri-Mode OCP Cable Kit	P57008-B21
<b>Notes:</b> supports 8 SFF U.3 NVMe/SAS/SATA connecting with smart array controllers at OCP2 with x2 speed.	
HPE ProLiant DL325 Gen11 8SFF x1 NVMe U.3 BC Cable Kit	P57009-B21
<b>Notes:</b> supports 8 SFF U.3 NVMe/SAS/SATA connecting with smart array controllers at secondary riser slot with x1 speed.	
HPE ProLiant DL325 Gen11 8SFF Cable Kit	P59619-B21
<b>Notes:</b> supports 8 SFF U.3 NVMe/SAS/SATA connecting with smart array controllers at OCP2 slot with x1 speed.	
HPE ProLiant DL325 Gen11 2SFF Cable Kit	P59617-B21
<b>Notes:</b> supports 2 SFF U.3 SATA direct attach.	
HPE ProLiant DL325 Gen11 2SFF x4 OCP2 NVMe Cable Kit	P59620-B21
<b>Notes:</b> supports 2 SFF U.3 NVMe/SAS/SATA connecting with smart array controllers at OCP2 slot with up to x4 speed.	
HPE ProLiant DL325 Gen11 2SFF x4 Secondary Cable Kit	P59621-B21
<b>Notes:</b> supports 2 SFF U.3 NVMe/SAS/SATA connecting with smart array controllers at secondary riser slot with up to x4 speed.	
HPE Alletra 41X0 Serial Port Cable and Enablement Kit	P50887-B21
<b>Notes:</b> This cable kit is used to support optional serial port at the rear of the server.	

### HPE Tape Backup

For the complete range of tape drives, autoloaders, libraries and media see:

<https://www.hpe.com/us/en/storage/storeever-tape-storage.html>.

For hardware and software compatibility of Hewlett Packard Enterprise tape backup products

<http://www.hpe.com/storage/BURACompatibility>.

### HPE Storage Options

#### Emulex Fibre Channel HBAs

HPE SN1610E 32Gb 1-port Fibre Channel Host Bus Adapter	R2J62A
HPE SN1610E 32Gb 2-port Fibre Channel Host Bus Adapter	R2J63A



## Additional Options

HPE SN1700E 64Gb 1-port Fibre Channel Host Bus Adapter	R7N77A
HPE SN1700E 64Gb 2-port Fibre Channel Host Bus Adapter	R7N78A

### QLogic Fibre Channel HBAs

HPE SN1610Q 32Gb 1-port Fibre Channel Host Bus Adapter	R2E08A
HPE SN1610Q 32Gb 2-port Fibre Channel Host Bus Adapter	R2E09A

## Rail Kits

### Notes:

- Hewlett Packard Enterprise recommends that a minimum of two people are required for all Rack Server installations. Please refer to your installation instructions for proper tools and number of people to use for any installation.
- CTO Models do not ship with rail kits, they need to be ordered separately

HPE ProLiant DL380 Gen11 2U SFF Rack Mount Kit	P52341-B21
--	------------

**Notes:** Should be selected with 4LFF CTO server

HPE DL3XX Gen11 Easy Install Rail 2 Kit	P52351-B21
---	------------

**Notes:** Should be selected with 8SFF CTO server

HPE ProLiant DL300 Gen10 Plus 1U Cable Management Arm for Rail Kit	P26489-B21
--	------------

## HPE Racks

- Please see the [HPE Advanced Series Racks QuickSpecs](#) for information on additional racks options and rack specifications.
- Please see the [HPE Enterprise Series Racks QuickSpecs](#) for information on additional racks options and rack specifications.
- Please see the [HPE Standard Series Racks QuickSpecs](#) for information on additional racks options and rack specifications.

## HPE Power Distribution Units (PDUs)

- Please see the [HPE Basic Power Distribution Units \(PDU\) QuickSpecs](#) for information on these products and their specifications.
- Please see the [HPE Metered Power Distribution Units \(PDU\) QuickSpecs](#) for information on these products and their specifications.
- Please see the [HPE Intelligent Power Distribution Unit \(PDU\) QuickSpecs](#) for information on these products and their specifications.
- Please see the [HPE Metered and Switched Power Distribution Units \(PDU\) QuickSpecs](#) for information on these products and their specifications.

## HPE Uninterruptible Power Systems (UPS)

- To learn more, please visit the [HPE Uninterruptible Power Systems \(UPS\) web page](#).
- Please see the [HPE DirectFlow Three Phase Uninterruptible Power System QuickSpecs](#) for information on these products and their specifications.
- Please see the [HPE Line Interactive Single Phase UPS QuickSpecs](#) for information on these products and their specifications.



---

## Additional Options

### HPE Rack Options

- Please see the [HPE KVM Switches web page](#) for information on these products and their specifications.
- 

### HPE Support Service

#### Installation Services

HPE Install ProLiant DL3xx Service	U4506E
------------------------------------	--------

HPE Installation and Startup DL3xx Service	U4507E
--	--------

#### Tech Care

HPE 3 Year Tech Care Essential DL325 GEN11 Service	H78S6E
--	--------

HPE 3 Year Tech Care Essential wDMR DL325 GEN11 Service	H78S7E
---	--------

HPE 5 Year Tech Care Essential DL325 GEN11 Service	H78V0E
--	--------

HPE 5 Year Tech Care Essential wDMR DL325 GEN11 Service	H78V1E
---	--------

---



## Memory

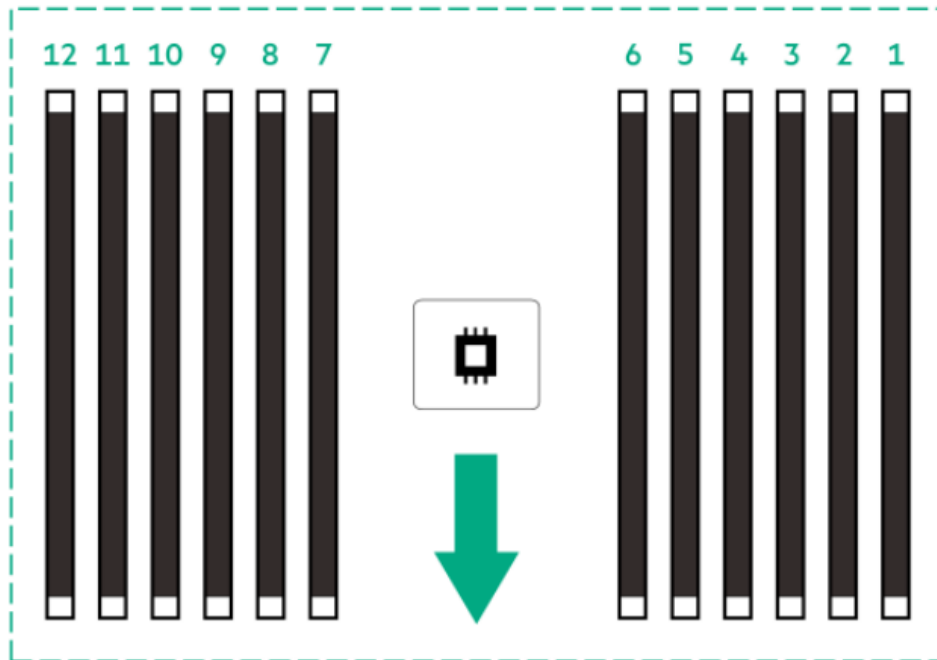

The arrow points to the front of the server

### General Memory Population Rules and Guidelines:

- Install DIMMs only if the corresponding processor is installed.
- To maximize performance, it is recommended to balance the total memory capacity between all installed processors.
- The maximum memory speed is a function of the memory type, memory configuration, and processor model.
- The maximum memory capacity is a function of the number of DIMM slots on the platform, the largest DIMM capacity qualified on the platform, the number and model of installed processors qualified on the platform.
- To realize the performance memory capabilities listed in this document, HPE DDR5 SmartMemory is required. For additional information, please see the: [HPE DDR5 Smart Memory QuickSpecs](#)
- For General Server Memory and Persistent Memory Population Rules and Guidelines, see details here: <http://www.hpe.com/docs/memory-population-rules>



Storage



4LFF drives



8SFF + Optional 2SFF (SAS/SATA/ NVMe) Shown



## Technical Specifications

### System Unit

#### Dimensions (Height x Width x Depth)

- 8SFF chassis:
  - 4.29 X 43.46 X 64.94 cm
  - 1.69 X 17.11 X 25.57 In
- 4LFF chassis:
  - 4.29 X 43.46 X 70.89 cm
  - 1.69 X 17.11 X 27.91 In
- Package
  - o 24.2 X 60 X 91.6 cm
  - o 9.53 X 23.6 X 36.06 In

#### Weight (approximate)

- 8 SFF chassis:
  - Minimum 8 SFF chassis with 0 drives, 1 processor, 1 power supply, 1 standard heatsinks, 1 DIMM, 1 Smart Array controller, and 7 standard fans.  
12.56 kg  
27.69 lb
  - Maximum 8 SFF chassis with 8 drives, 1 processor, 2 power supply, 1 standard heatsinks, 12 DIMM, 1 Smart Array controller, and 7 standard fans.  
15.54 kg  
34.27 lb
  - Package  
4.21 kg  
9.281 lb
- 4 LFF chassis:
  - Minimum 4 LFF chassis with 0 drives, 1 processor, 1 power supply, 1 performance heatsinks, 1 DIMM, 1 Smart Array controller, and 7 performance fans.  
14.31 kg  
31.54 lb
  - Maximum 4 LFF chassis with 4 drives, 1 processor, 1 power supply, 1 performance heatsinks, 1 DIMM, 1 Smart Array controller, and 7 performance fans.  
17.07 kg  
37.63 lb
  - Package  
4.145 kg  
9.138 lb

---

#### Input Requirements(per power supply)

##### Rated Line Voltage

- 100 to 120 VAC
  - 200 to 240 VAC
- 



## Technical Specifications

### BTU Rating

#### Maximum

- For 1600W Power Supply: 5918 BTU/hr (at 200 VAC), 5884 BTU/hr (at 240 VAC) for China
- For 800W Power Supply: 3207 BTU/hr (at 100 VAC), 3071 BTU/hr (at 200 VAC), 3112 BTU/hr (at 240 VAC) for China Only
- For 500W Power Supply: 1979 BTU/hr (at 100 VAC), 1911 BTU/hr (at 200 VAC), 1965 BTU/hr (at 240 VAC) for China Only

---

### Power Supply Output(per power supply)

- **Rated Steady-State Power**
  - For 1600W Power Supply: 1600W (at 240 VAC), 1600W (at 240 VAC)
  - For 800W Power Supply: 800W (at 100 VAC), 800W (at 240 VAC), 800W (at 240 VAC) input for China only
  - For 500W Power Supply: 500W (at 100 VAC), 500W (at 240 VAC), 500W (at 240 VAC) input for China only
- **Maximum Peak Power**
  - For 1600W Power Supply: 1600W (at 200 to 240 1VAC), 1600W (at 240 VAC) input for China only
  - For 800W Power Supply: 800W (at 100 to 127 VAC), 800W (at 200 to 240 1VAC), 800W (at 240 VAC) input for China only
  - For 500W Power Supply: 500W (at 100 to 127 VAC), 500W (at 200 to 240 VAC), 500W (at 240 VAC) input for China only

---

### System Inlet Temperature

- **Standard Operating Temperature**

10° to 35°C (50° to 95°F) at sea level with an altitude derating of 1.0°C per every 305 m (1.8°F per every 1000 ft) above sea level to a maximum of 3050 m (10,000 ft), no direct sustained sunlight. Maximum rate of change is 20°C/hr (36°F/hr). The upper limit and rate of change may be limited by the type and number of options installed.

System performance during standard operating support may be reduced if operating with a fan fault or above 30°C (86°F).
- **Extended Ambient Operating Temperature**

For approved hardware configurations, the supported system inlet range is extended to be: 5° to 10°C (41° to 50°F) and 35° to 40°C (95° to 104°F) at sea level with an altitude derating of 1.0°C per every 175 m (1.8°F per every 574 ft) above 900 m (2953 ft) to a maximum of 3050 m (10,000 ft). The approved hardware configurations for this system are listed at the URL: <http://www.hpe.com/servers/ashrae>

For approved hardware configurations, the supported system inlet range is extended to be: 40° to 45°C (104° to 113°F) at sea level with an altitude derating of 1.0°C per every 125 m (1.8°F per every 410 ft) above 900 m (2953 ft) to a maximum of 3050 m (10,000 ft). The approved hardware configurations for this system are listed at the URL: <http://www.hpe.com/servers/ashrae>

System performance may be reduced if operating in the extended ambient operating range or with a fan fault.
- **Non-operating**

-30° to 60°C (-22° to 140°F). Maximum rate of change is 20°C/hr (36°F/hr).

---

### Relative Humidity(non-condensing)

- **Operating**

8% to 90% - Relative humidity (Rh), 28°C maximum wet bulb temperature, non-condensing.
- **Non-operating**

5 to 95% relative humidity (Rh), 38.7°C (101.7°F) maximum wet bulb temperature, non-condensing.





## Technical Specifications

### Altitude

- **Operating**  
3050 m (10,000 ft). This value may be limited by the type and number of options installed. Maximum allowable altitude change rate is 457 m/min (1500 ft/min).
- **Non-operating**  
9144 m (30,000 ft). Maximum allowable altitude change rate is 457 m/min (1500 ft/min).

### Emissions Classification (EMC) – Regulatory Information

To view the regulatory information for your product, view the Safety and Compliance Information for Server, Storage, Power, Networking, and Rack Products, available at the Hewlett Packard Enterprise Support Center:

<http://www.hpe.com/support/Safety-Compliance-EnterpriseProducts>

### Acoustic Noise

Listed are the declared mean A-Weighted sound power levels (LwAm), declared average bystander position A-Weighted sound pressure levels (LpAm) and the statistical adder for verification, Kv, is a quantity to be added to the declared mean A-weighted sound power level, LwA,m when the product is operating in a 23°C ambient environment. Noise emissions were measured in accordance with ISO 7779 (ECMA 74) and declared in accordance with ISO 9296 (ECMA 109). The listed sound levels apply to standard shipping configurations. Additional options may result in increased sound levels. Please have your HPE representative provide information from the HPE EMESC website for further technical details regarding the configurations listed below.

<b>Idle</b>	
LWAd	5.1 B Perf 4.7 B Value
LpAm	37 dBA Perf 35 dBA Value
Kv	0.4 B Perf 0.4 B Value
<b>Operating</b>	
LWAd	5.9 B Perf 5.7 B Value
LpAm	47 dBA Perf 42 dBA Value
Kv	0.4 B Perf 0.4 B Value

#### Notes:

- The declared mean A-weighted sound power level, LwA,m, is computed as the arithmetic average of the measured.
- A-weighted sound power levels for a randomly selected sample, rounded to the nearest 0,1 B.
- The declared mean A-weighted emission sound pressure level, LpA,m, is computed as the arithmetic average of the measured A-weighted emission sound pressure levels at the bystander positions for a randomly selected sample, rounded to the nearest 1 dB.
- The statistical adder for verification, Kv, is a quantity to be added to the declared mean A-weighted sound power level, LwA,m, such that there will be a 95 % probability of acceptance, when using the verification procedures of ISO 9296, if no more than 6,5 % of the batch of new equipment, has A-weighted sound power levels greater than (LwA,m + Kv).
- The quantity, LwA,c (formerly called LWAd), can be computed from the sum of LwA,m and Kv.
- All measurements made to conform to ISO 7779 / ECMA-74 and declared to conform to ISO 9296 / ECMA-109.
- B, dB, abbreviations for bels and decibels, respectively, where 1 B = 10 dB.
- The results in this declaration apply only to the model numbers listed above when operating and tested according to the indicated modes and standards. A system with additional configuration components or increased operating functionality may increase the noise emission values.

## Technical Specifications

### **Environment-friendly Products and Approach - End-of-life Management and Recycling**

Hewlett Packard Enterprise offers **end-of-life product return, trade-in, and recycling programs** in many geographic areas, for our products. Products returned to Hewlett Packard Enterprise will be recycled, recovered or disposed of in a responsible manner.

The EU WEEE directive (2002/95/EC) requires manufacturers to provide treatment information for each product type for use by treatment facilities. This information (product disassembly instructions) is posted on the Hewlett Packard Enterprise web site. These instructions may be used by recyclers and other WEEE treatment facilities as well as Hewlett Packard Enterprise OEM customers who integrate and re-sell Hewlett Packard Enterprise equipment.

---



## Summary of Changes

Date	Version History	Action	Description of Change
05-Dec-2022	Version 2	Changed	All sections were updated.
10-Nov-2022	Version 1	New	New QuickSpecs.



## Copyright

Make the right purchase decision.  
Contact our presales specialists.



---

© Copyright 2022 Hewlett Packard Enterprise Development LP. The information contained herein is subject to change without notice. The only warranties for Hewlett Packard Enterprise products and services are set forth in the express warranty statements accompanying such products and services. Nothing herein should be construed as constituting an additional warranty. Hewlett Packard Enterprise shall not be liable for technical or editorial errors or omissions contained herein.

AMD® and EPYC® are registered trademarks of Advanced Micro Devices Corporation in the U.S. and other countries.

Microsoft®, Windows®, and Windows Server® are U.S. registered trademarks of the Microsoft group of companies.

For hard drives, 1GB = 1 billion bytes. Actual formatted capacity is less

a50004297enw - 16901 - Worldwide - V2 - 05-December-2022