

ET40/45

Enterprise Tablet



ZEBRA

Product Reference Guide

ZEBRA and the stylized Zebra head are trademarks of Zebra Technologies Corporation, registered in many jurisdictions worldwide. All other trademarks are the property of their respective owners. ©2022 Zebra Technologies Corporation and/or its affiliates. All rights reserved.

Information in this document is subject to change without notice. The software described in this document is furnished under a license agreement or nondisclosure agreement. The software may be used or copied only in accordance with the terms of those agreements.

For further information regarding legal and proprietary statements, please go to:

SOFTWARE: zebra.com/linkoslegal.

COPYRIGHTS: zebra.com/copyright.

WARRANTY: zebra.com/warranty.

END USER LICENSE AGREEMENT: zebra.com/eula.

Terms of Use

Proprietary Statement

This manual contains proprietary information of Zebra Technologies Corporation and its subsidiaries ("Zebra Technologies"). It is intended solely for the information and use of parties operating and maintaining the equipment described herein. Such proprietary information may not be used, reproduced, or disclosed to any other parties for any other purpose without the express, written permission of Zebra Technologies.

Product Improvements

Continuous improvement of products is a policy of Zebra Technologies. All specifications and designs are subject to change without notice.

Liability Disclaimer

Zebra Technologies takes steps to ensure that its published Engineering specifications and manuals are correct; however, errors do occur. Zebra Technologies reserves the right to correct any such errors and disclaims liability resulting therefrom.

Limitation of Liability

In no event shall Zebra Technologies or anyone else involved in the creation, production, or delivery of the accompanying product (including hardware and software) be liable for any damages whatsoever (including, without limitation, consequential damages including loss of business profits, business interruption, or loss of business information) arising out of the use of, the results of use of, or inability to use such product, even if Zebra Technologies has been advised of the possibility of such damages. Some jurisdictions do not allow the exclusion or limitation of incidental or consequential damages, so the above limitation or exclusion may not apply to you.

Contents

About this Guide.....	11
Configurations.....	11
Notational Conventions.....	13
Icon Conventions.....	13
Service Information.....	14
Determining Software Versions.....	14
Determining the Serial Number.....	15
Getting Started.....	16
Unpacking the Device.....	16
Device Features.....	17
Setting Up the Device.....	19
Installing the nano SIM Card.....	19
Device Charging.....	22
Powering on the Device.....	26
Turning off the Display.....	26
Turning off the Device.....	26
Using the Device.....	27
Home Screen.....	27
Setting the Home Screen Rotation.....	28
Status Bar.....	29
Notification Icons.....	29
Status Icons.....	30
Managing Notifications.....	32

Quick Access Panel Icons.....	33
Opening the Quick Access Panel.....	34
Editing Icons on the Quick Settings Bar.....	35
Battery Management.....	35
Checking Battery Status.....	36
Monitoring Battery Usage.....	36
Low Battery Notification.....	36
Interactive Sensor Technology.....	36
Waking the Device.....	37
USB Communication.....	37
Transferring Files.....	37
Transferring Photos.....	38
Disconnecting from the Host Computer.....	38
Settings.....	39
Accessing Settings.....	39
Display Settings.....	39
Setting the Screen Brightness Manually.....	39
Setting the Screen Brightness Automatically.....	39
Setting Night Light.....	40
Setting Screen Rotation.....	40
Setting Screen Timeout.....	40
Setting Lock Screen Notifications.....	41
Setting Font Size.....	41
Setting Display Size.....	41
Setting Touch Panel Mode.....	41
Setting the Date and Time.....	42
General Sound Setting.....	42
Sound Options.....	42
Zebra Volume Controls.....	43
Remapping a Button.....	43
Remappable Keys.....	44
Keyboards.....	44
Keyboard Configuration.....	44

Enabling Keyboards.....	44
Switching Between Keyboards.....	45
Using the Android and Gboard Keyboards.....	45
Edit Text.....	45
Entering Numbers, Symbols, and Special Characters.....	45
Enterprise Keyboard.....	45
Language Usage.....	46
Changing the Language Setting.....	46
Adding Words to the Dictionary.....	46
Notifications.....	47
Enabling Blink Light.....	47
Applications.....	48
Installed Applications.....	48
Accessing Apps.....	49
Switching Between Recent Apps.....	50
Battery Manager.....	50
Opening Battery Manager.....	50
Battery Manager Information.....	50
Camera.....	52
Taking Photos.....	52
Recording Videos.....	54
Camera Settings.....	54
DWDemo.....	56
DWDemo Icons.....	56
Selecting a Scanner.....	57
RxLogger.....	57
RxLogger Configuration.....	58
Configuration File.....	58
Enabling Logging.....	58
Disabling Logging.....	58
Extracting Log Files.....	58
Backing Up Data.....	58
RxLogger Utility.....	58

Data Capture.....	60
Imaging.....	60
Scanning Considerations.....	61
Scanning with an Internal Scanner.....	61
Scanning with the Camera.....	62
Scanning with the RS507/RS507X Hands-Free Imager.....	63
Scanning with the RS5100 Ring Scanner.....	65
Scanning with the RS6000 Bluetooth Ring Scanner.....	66
Scanning with the DS2278 Digital Scanner.....	69
Scanning with the DS3678 Bluetooth Scanner.....	70
Scanning with the DS8178 Digital Scanner.....	72
Scanning with the LI3678 Linear Imager.....	73
DataWedge.....	74
Enabling DataWedge.....	74
Disabling DataWedge.....	75
Supported Decoders.....	75
Camera Supported Decoders.....	75
SE4100 Internal Imager Supported Decoders.....	76
SE4710 Internal Imager Supported Decoders.....	77
SE4720 Internal Imager Supported Decoders.....	77
SE55 Internal Imager Supported Decoders.....	78
RS507/RS507x Supported Decoders.....	79
RS5100 Supported Decoders.....	80
RS6000 Supported Decoders.....	80
DS2278 Supported Decoders.....	81
DS3678 Supported Decoders.....	82
DS8178 Supported Decoders.....	83
LI3678 Supported Decoders.....	84
Wireless.....	85
Wireless Wide Area Networks.....	85
Sharing the Mobile Data Connection.....	85
Data Usage.....	87
Cellular Network Settings.....	88

Wireless Local Area Network.....	89
Connecting to a Wi-Fi Network.....	90
Removing a Wi-Fi Network.....	91
WLAN Configuration.....	91
Bluetooth.....	96
Adaptive Frequency Hopping.....	96
Security.....	97
Bluetooth Profiles.....	97
Bluetooth Power States.....	98
Enabling Bluetooth.....	98
Disabling Bluetooth.....	98
Discovering Bluetooth Device(s).....	98
Changing the Bluetooth Name.....	99
Connecting to a Bluetooth Device.....	99
Selecting Profiles on the Bluetooth Device.....	99
Unpairing a Bluetooth Device.....	99
Cast.....	100
Near Field Communications.....	100
Reading NFC Cards.....	100
Enterprise NFC Settings.....	102
Accessories.....	103
Accessories List.....	103
Device Charging.....	106
Charging Indicators.....	106
Charging Temperature.....	107
1-Slot Charge Only Cradle.....	107
Charging Using a 1-Slot Cradle.....	109
4-Slot Charge Only Cradle.....	111
Installing the Insert.....	114
Charging Using a 4-Slot Cradle.....	117
Installing the Battery Charger.....	118
4-Slot Battery Charger.....	119
Power Setup.....	120

Charging the Power Pack Using the 4-Slot Battery Charger.....	120
Power Pack Charging Indicators.....	121
Power Pack.....	122
Installing the Power Pack.....	123
Rugged Boot.....	124
Installing the Rugged Boot.....	124
D-Clips.....	126
Attaching the Shoulder Strap.....	128
Healthcare Hand Strap.....	129
Installing the Handstrap.....	129
Expansion Back.....	130
Installing the Expansion Back.....	130
Removing the Expansion Back.....	131
Application Deployment.....	133
Android Security.....	133
Secure Certificates.....	133
Installing a Secure Certificate.....	133
Android Development Tools.....	134
Android Development Workstation.....	134
Enabling Developer Options.....	134
EMDK for Android.....	134
StageNow for Android.....	135
GMS Restricted.....	135
ADB USB Setup.....	135
Enabling USB Debugging.....	135
Entering Android Recovery Manually.....	136
Application Installation.....	136
Installing Applications Using the Android Debug Bridge.....	137
Installing Applications Using the Wireless Android Debug Bridge.....	137
Installing Applications Using the USB Connection.....	139
Installing Applications Using a USB Drive.....	139
Uninstalling an Application.....	140
Android System Update.....	140

Performing a System Update Using ADB.....	140
Performing a System Update Using Wireless ADB.....	141
Performing a System Update Using USB Drive.....	143
Verifying System Update Installation.....	143
Android Enterprise Reset.....	144
Performing an Enterprise Reset Using ADB.....	144
Performing an Enterprise Reset Using Wireless ADB.....	145
Performing an Enterprise Reset Using USB Drive.....	147
Android Factory Reset.....	147
Performing a Factory Reset Using ADB.....	147
Performing a Factory Reset Using Wireless ADB.....	148
Performing a Factory Reset Using a USB Drive.....	150
Android Storage.....	151
Random Access Memory.....	151
Internal Storage.....	151
External Storage.....	152
Enterprise Folder.....	152
Managing Apps.....	152
App Details.....	153
Managing Downloads.....	153
Maintenance and Troubleshooting.....	154
Maintaining the Device.....	154
Battery Safety Guidelines.....	154
Best Practices for Enterprise Mobile Computing Devices Operating in Hot Environments and Direct Sunlight.....	155
Cleaning Instructions.....	155
Approved Cleanser Active Ingredients.....	156
Approved Cleanser Active Ingredients for Healthcare Devices.....	156
Harmful Ingredients.....	156
Special Cleaning Notes.....	156
Cleaning Frequency.....	157
Device Cleaning Instructions.....	157
Display.....	157

Housing.....	157
Camera and Exit Window.....	157
Cleaning Cradle Connectors.....	157
Troubleshooting.....	158
Resetting the Device.....	158
Troubleshooting the Device.....	158
Charge Only Cradle.....	161
4-Slot Battery Charger.....	161
Technical Specifications.....	162
SE4100 Decode Distances.....	162
SE4710 Decode Distances.....	162
SE4720 Decode Distances.....	163
SE5500 Decode Distances.....	163
1-Slot Charge Only Cradle Specifications.....	164
4-Slot Charge Only Cradle Specifications.....	165
8 in. Expansion Back Specifications.....	165
10 in. Expansion Back Specifications.....	166

About this Guide

This guide provides information about setting up and using the ET40 and ET45 tablets. Some screens shown in this guide may differ from the actual screens shown on the device.

Configurations

This guide covers the following configurations of the ET40/45 tablets.

Table 1 Configurations

Configuration	Operating System	Radios	Display	Memory/Storage	Data Capture
ET40 ET40AA-001C1B0	Android 11 GMS	WLAN: WiFi-6 (802.11 ax) WPAN: Bluetooth 5.1 with BLE	8 inch WXGA 1280X800 (~189 pp1, 500 NITS)	4 GB RAM/ 64 GB Flash	SE4100 Integrated scanner
ET40 China Only ET40AA-002C1B0	Android 11 AOSP	WLAN: WiFi-6 (802.11 ax) WPAN: Bluetooth 5.1 with BLE	8 inch WXGA 1280X800 (~189 pp1, 500 NITS)	4 GB RAM/ 64 GB Flash	SE4100 Integrated scanner
ET40 ET40AB-001C1B0	Android 11 GMS	WLAN: WiFi-6 (802.11 ax) WPAN: Bluetooth 5.1 with BLE	10 inch WXGA 1920X1200 (~226 pp1, 500 NITS)	4 GB RAM/ 64 GB Flash	SE4100 Integrated scanner
ET40 China Only ET40AB-002C1B0	Android 11 AOSP	WLAN: WiFi-6 (802.11 ax) WPAN: Bluetooth 5.1 with BLE	10 inch WXGA 1920X1200 (~226 pp1, 500 NITS)	4 GB RAM/ 64 GB Flash	SE4100 Integrated scanner
ET40-HC Healthcare ET40AB-0H1C1B0	Android 11 GMS	WLAN: WiFi-6 (802.11 ax) WPAN: Bluetooth 5.1 with BLE	10 inch WXGA 1920X1200 (~226 pp1, 500 NITS)	4 GB RAM/ 64 GB Flash	SE4100 Integrated scanner

Table 1 Configurations (Continued)

Configuration	Operating System	Radios	Display	Memory/Storage	Data Capture
ET40-HC Healthcare China Only ET40AB-0H2C1B0	Android 11 AOSP	WLAN: WiFi-6 (802.11 ax) WPAN: Bluetooth 5.1 with BLE	10 inch WXGA 1920X1200 (~226 pp1, 500 NITS)	4 GB RAM/ 64 GB Flash	SE4100 Integrated scanner
ET45 ET45BA-101D1B0	Android 11 GMS	WLAN: WiFi-6 (802.11 ax) WPAN: Bluetooth 5.1 with BLE WWAN: 5G	8 inch WXGA 1280X800 (~189 pp1, 500 NITS)	4 GB RAM/ 64 GB Flash	SE4710 Integrated scanner
ET45 ET45BB-101D1B0	Android 11 GMS	WLAN: WiFi-6 (802.11 ax) WPAN: Bluetooth 5.1 with BLE WWAN: 5G	10 inch WXGA 1920X1200 (~226 pp1, 500 NITS)	4 GB RAM/ 64 GB Flash	SE4710 Integrated scanner
ET45 ET45-Advanced ET45BB-101K2B0 ET45CB-101K2B0	Android 11 GMS	WLAN: WiFi-6 (802.11 ax) WPAN: Bluetooth 5.1 with BLE WWAN: 5G	10 inch WXGA 1920X1200 (~226 pp1, 500 NITS)	8 GB RAM/ 128 GB Flash	SE5500 Integrated scanner
ET45-HC Healthcare ET45BB-1H1C1B0 ET45CB-1H1C1B0	Android 11 GMS	WLAN: WiFi-6 (802.11 ax) WPAN: Bluetooth 5.1 with BLE WWAN: 5G	10 inch WXGA 1920X1200 (~226 pp1, 500 NITS)	4 GB RAM/ 64 GB Flash	SE4100 Integrated scanner
ET45 ET45CA-101D1B0	Android 11 GMS	WLAN: WiFi-6 (802.11 ax) WPAN: Bluetooth 5.1 with BLE WWAN: 5G	8 inch WXGA 1280X800 (~189 pp1, 500 NITS)	4 GB RAM/ 64 GB Flash	SE4710 Integrated scanner
ET45 China Only ET45CA-102D1B0	Android 11 AOSP	WLAN: WiFi-6 (802.11 ax) WPAN: Bluetooth 5.1 with BLE WWAN: 5G	8 inch WXGA 1280X800 (~189 pp1, 500 NITS)	4 GB RAM/ 64 GB Flash	SE4710 Integrated scanner

Table 1 Configurations (Continued)

Configuration	Operating System	Radios	Display	Memory/Storage	Data Capture
ET45 ET45CB-101D1B0	Android 11 GMS	WLAN: WiFi-6 (802.11 ax) WPAN: Bluetooth 5.1 with BLE WWAN: 5G	10 inch WXGA 1920X1200 (~226 pp1, 500 NITS)	4 GB RAM/ 64 GB Flash	SE4710 Integrated scanner
ET45 China Only ET45CB-102D1B0	Android 11 AOSP	WLAN: WiFi-6 (802.11 ax) WPAN: Bluetooth 5.1 with BLE WWAN: 5G	10 inch WXGA 1920X1200 (~226 pp1, 500 NITS)	4 GB RAM/ 64 GB Flash	SE4710 Integrated scanner

Notational Conventions

The following conventions are used in this document:

- **Bold** text is used to highlight the following:
 - Dialog box, window, and screen names
 - Drop-down list and list box names
 - Checkbox and radio button names
 - Icons on a screen
 - Key names on a keypad
 - Button names on a screen
- Bullets (•) indicate:
 - Action items
 - List of alternatives
 - Lists of required steps that are not necessarily sequential.
- Sequential lists (for example, those that describe step-by-step procedures) appear as numbered lists.

Icon Conventions

The documentation set is designed to give the reader more visual clues. The following visual indicators are used throughout the documentation set.



NOTE: The text here indicates information that is supplemental for the user to know and that is not required to complete a task.



IMPORTANT: The text here indicates information that is important for the user to know.



CAUTION: If the precaution is not heeded, the user could receive a minor or moderate injury.



WARNING: If danger is not avoided, the user CAN be seriously injured or killed.



DANGER: If danger is not avoided, the user WILL be seriously injured or killed.

Service Information

If you have a problem with your equipment, contact Zebra Global Customer Support for your region. Contact information is available at: zebra.com/support.

When contacting support, please have the following information available:

- Serial number of the unit
- Model number or product name
- Software type and version number

Zebra responds to calls by email, telephone, or fax within the time limits set forth in support agreements.

If your problem cannot be solved by Zebra Customer Support, you may need to return your equipment for servicing and will be given specific directions. Zebra is not responsible for any damages incurred during shipment if the approved shipping container is not used. Shipping the units improperly can possibly void the warranty.

If you purchased your Zebra business product from a Zebra business partner, contact that business partner for support.

Determining Software Versions

Before contacting Customer Support, determine the current software version on your device.

1. Swipe down from the Status bar with two fingers to open the Quick Access panel, and then touch .
2. Touch **About tablet**.
3. Scroll to view the following information:
 - Android version
 - Android Security Update
 - Google Play system update
 - Baseband version
 - Kernel version
 - Build number

To determine the device International Mobile Equipment Identity (IMEI) information (WWAN only), touch **About phone > IMEI**.

- **IMEI** - Displays the IMEI number for the device.
- **IMEI SV** - Displays the IMEI software version (SV) number for the device.

Determining the Serial Number

Before contacting Customer Support, determine the serial number of your device.

1. Touch **About phone**.
2. Touch **Model**.

Getting Started

This section provides information to get the tablet up and running for the first time.

Unpacking the Device

1. Carefully remove all protective material from the device and save the shipping container for later storage and shipping.
2. Verify the following items are in the box:
 - Tablet
 - Regulatory Guide
3. Inspect the equipment for damage. If any equipment is missing or damaged, contact the Global Customer Support Center immediately.
4. Before using the device for the first time, remove the protective shipping film that covers the scan window, display, and camera window.

Device Features

Figure 1 Front View

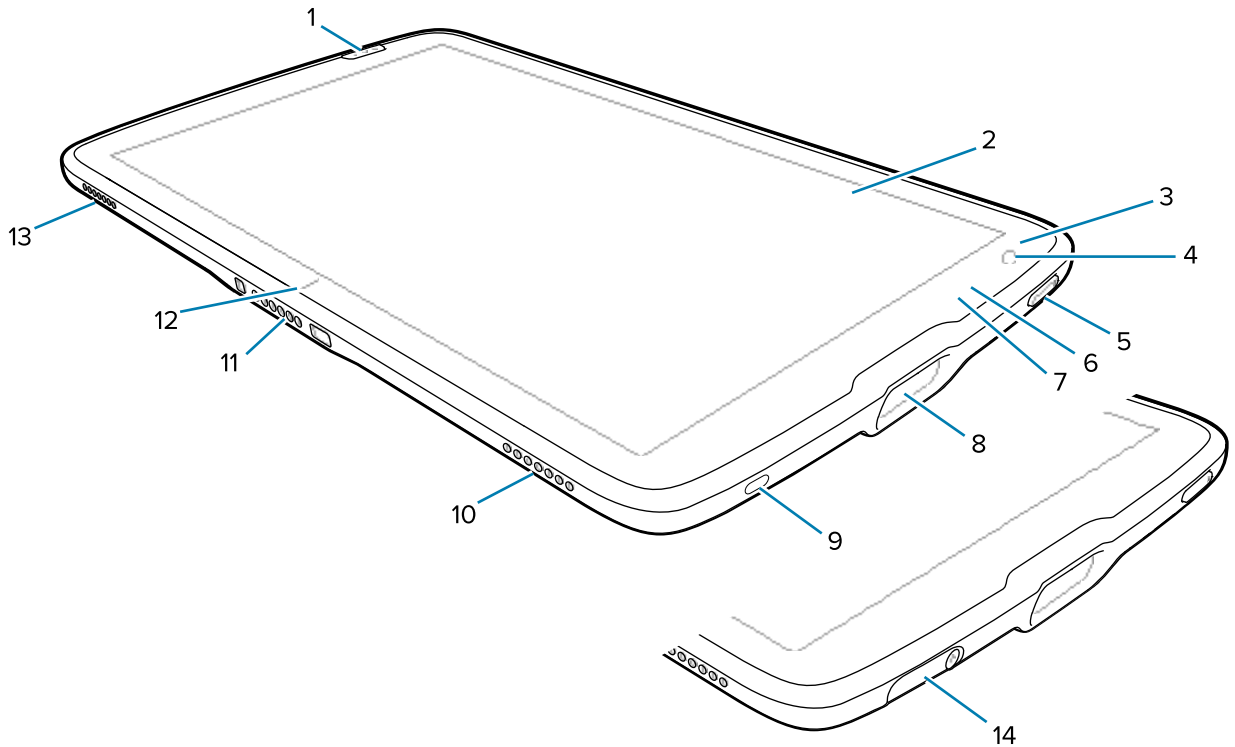

Table 2 Device Front View

Number	Item	Description
1	Front scan button	Initiates barcode data capture when a scan-enabled application is active.
2	Touch screen	Displays all information needed to operate the device.
3	Light sensor	Determines ambient light for controlling display back light intensity.
4	Front camera	Use for video conferencing.
5	Power button	Turns the display on and off. Press and release to power on the device. Press and hold to reset the device or power off.
6	Data capture LED	Illuminates during data capture.
7	Charging indicator LED	Indicates power state and battery charging status while charging and application generated notifications.
8	Scan window	Provides data capture using the imager.
9	USB-C port	Provides USB host and client communications.
10	Right speaker	Provides audio output.
11	Interface connector	Provides communication to the device from the dock.
12	Cradle alignment indicator	Use to assist in aligning the tablet with a cradle.

Table 2 Device Front View (Continued)

Number	Item	Description
13	Left speaker	Provides audio output.
14	USB port cover	Use to seal the USB port. Available on healthcare devices only.

Figure 2 Rear View

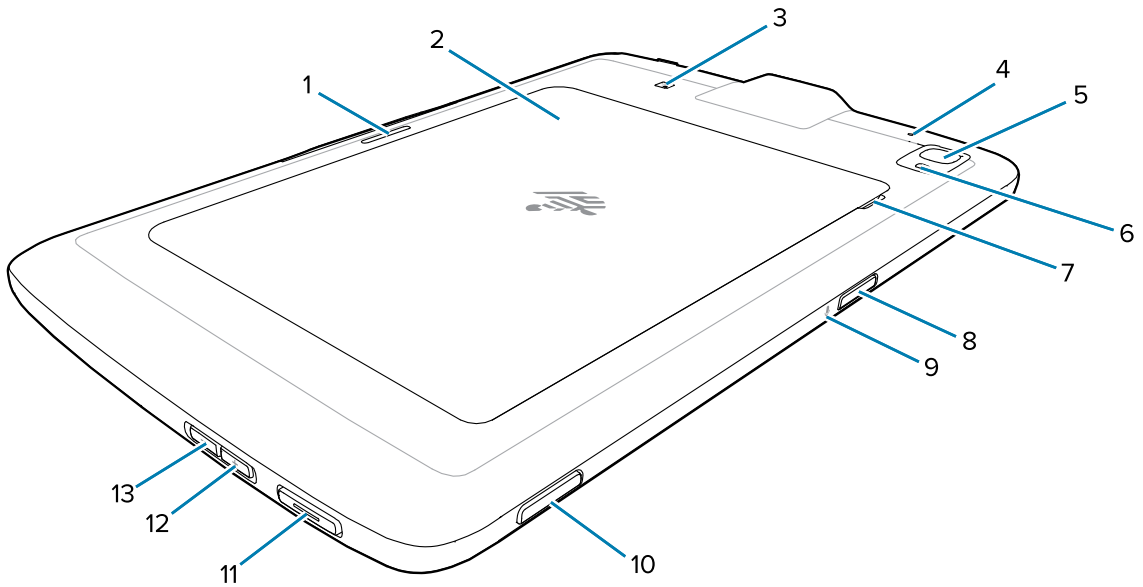

Table 3 Device Rear View

Number	Item	Description
1	Cradle latching slot	Used by cradles to secure the tablet.
2	Battery cover	Provides access to the replaceable battery.
3	NFC antenna position	Use to read NFC cards.
4	Rear Microphone	Use for audio recordings.
5	Rear camera	Autofocus camera that takes photos.
6	Rear camera LED flash	Provides illumination for the camera.
7	Battery cover notch	Lift the notched section of the battery cover to remove the battery cover from the tablet.
8	Top scan button	Initiates barcode data capture when a scan-enabled application is active (programmable).
9	Top Microphone	Use for voice communications or audio recordings.
10	Programmable button	Button that is configurable for use with applications.

Table 3 Device Rear View (Continued)

Number	Item	Description
11	PTT button	Typically used for Push-to-Talk communications. Where regulatory restrictions exist, button is configurable for use with other applications.
12	Volume up button	Increases audio volume.
13	Volume down button	Decreases audio volume.

Setting Up the Device

Set up the device before using it for the first time.

1. Install the nano SIM Card. (ET45 only)
2. Charge the device.
3. Power on the device.

Installing the nano SIM Card

A nano-SIM card slot is available only on ET45 devices. The following steps only apply when installing or replacing a nano SIM card.

1. Ensure the tablet is powered off.



CAUTION: Do not attempt to remove the battery while the tablet is powered on.

- a) Press and hold the Power button until the menu appears.
- b) Touch **Power off**.

2. Lift the corner of the battery cover up (1) from the notched area and carefully remove the battery cover from the device (2) as shown.



CAUTION: Do not use any tool for battery cover or battery removal. Puncturing the battery or seal may cause a hazardous condition and a potential risk of injury.

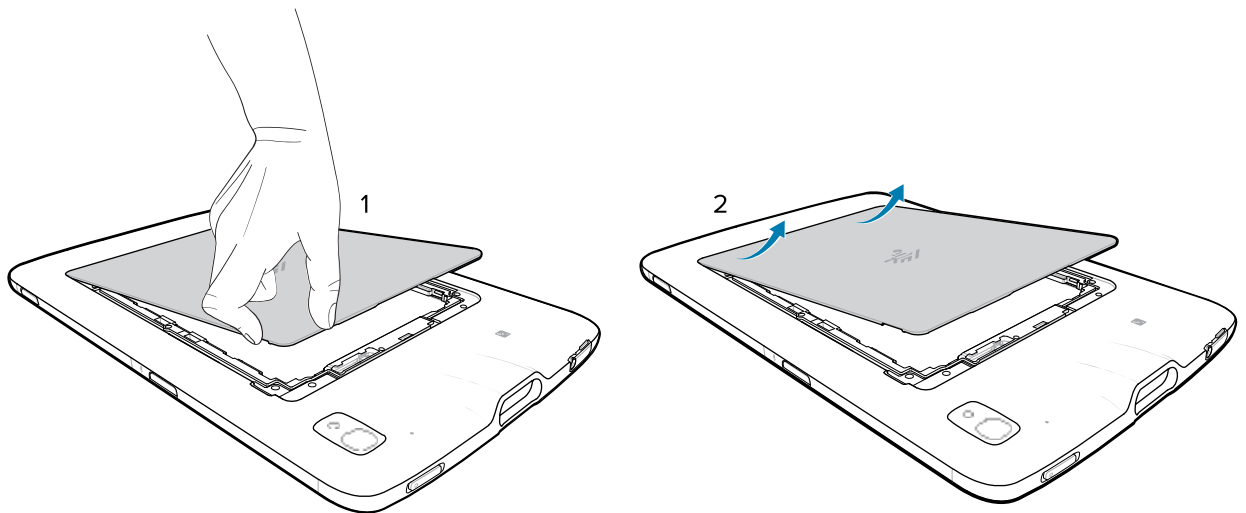

3. Using your fingernail, slide and hold the battery lock switch in the unlock position (1).
4. While the switch is in the unlock position, lift the battery from the notched area (2), rotate the battery up and then remove it from the battery well (3).

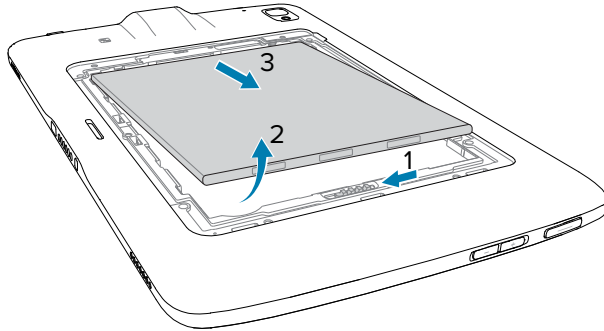

5. After removing the battery from the tablet, release the battery lock switch.
6. If replacing the nano SIM card, remove the existing card.
 - a) Push in the installed SIM card and release.
 - b) The card ejects slightly so that you can remove it.
 - c) Remove the SIM card from the card slot. The card should easily slide out. If not, the SIM card was not ejected correctly. Repeat step A.
7. Insert the nano SIM card with the contacts facing up.

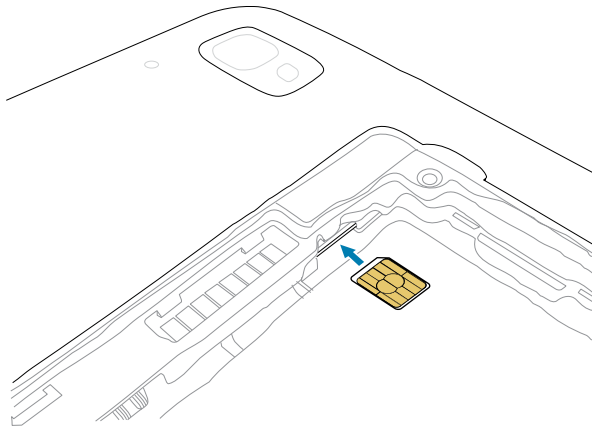

8. Push the SIM card in and ensure that it locks into place.

9. Replace the battery, contacts side first.

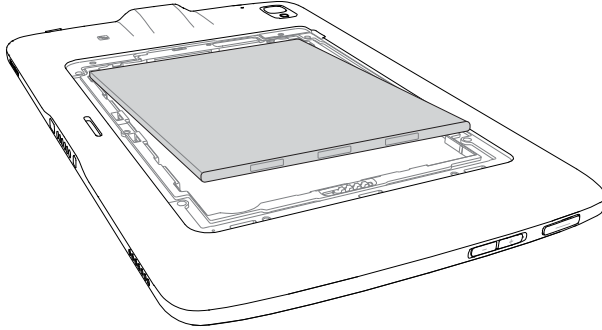

10. Gently push the battery towards the contacts (1) while rotating the battery down into the battery well (2), ensuring it is seated properly.

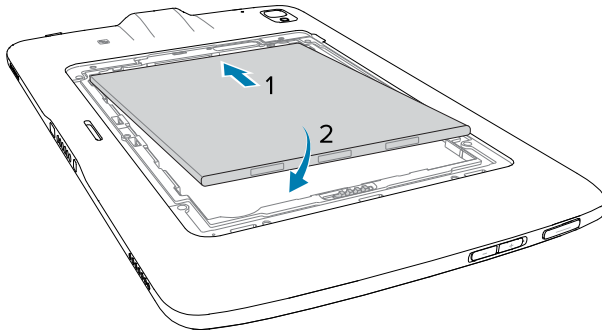

CAUTION: Be aware of the orientation of the battery cover. Failure to replace the battery cover properly may cause damage.

11. Insert the tabbed end of the battery cover into the slots in the battery well (1).
12. Rotate the cover down (2).

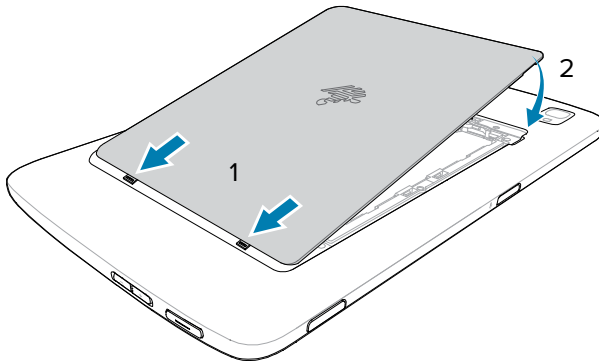

13. Carefully press down around the edges of the cover. Make sure that the cover is seated properly.

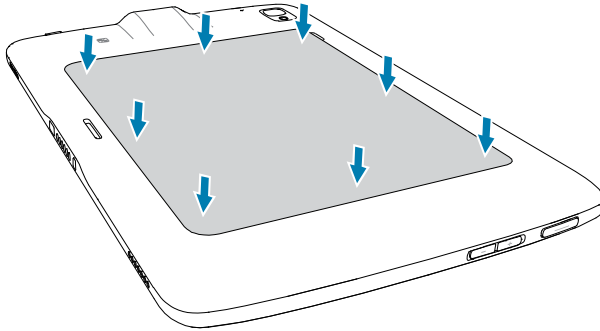

Device Charging

Before using the tablet for the first time, connect it to an external power source. Keep the tablet connected to the external power source until fully charged. The Charging Indicator LED turns green when the tablet is fully charged. You may use the tablet while it is charging.

Charging Indicators

Charge the tablet's battery before using the tablet.

The 8 in. tablet battery charges from fully depleted to 80% in approximately 3 hours.

The 10 in. tablet battery charges from fully depleted to 80% in approximately 4 hours.



NOTE: The Charging indicator only illuminates when the device is connected to a power source.

Table 4 Charging Indicators

LED	Indication
Off	Device is not in cradle; not seated properly; or cradle is not powered.
Slow blinking orange (1 blink every 4 seconds)	Device is charging.
Slow blinking red (1 blink every 4 seconds)	Device is charging but the battery is at end of useful life.
Fast blinking orange (2 blinks/second)	Charging error. Possible charging errors include: <ul style="list-style-type: none"> • Temperature is too low or too high. • Charging has gone on too long without completion (typically eight hours).
Fast blinking red (2 blinks/second)	Charging error and the battery is at end of useful life. Possible charging errors include: <ul style="list-style-type: none"> • Temperature is too low or too high. • Charging has gone on too long without completion (typically eight hours).

Table 4 Charging Indicators (Continued)

LED	Indication
Solid Green	Charging complete.
Solid Red	Charging complete but the battery is at end of useful life.

Charging Temperature

Charge batteries in ambient temperatures from 0°C to +40°C (32°F to 104°F) as reported by the battery. Charging is intelligently controlled by the charger. To accomplish this, for small periods of time, the charger alternately enables and disables battery charging to keep the battery at acceptable temperatures.

Charging Using a 1-Slot Cradle

This section describes how to charge the device using an ET40/ET45 1-Slot Cradle.

1. Align the device with the alignment marks (1) on the cradle.

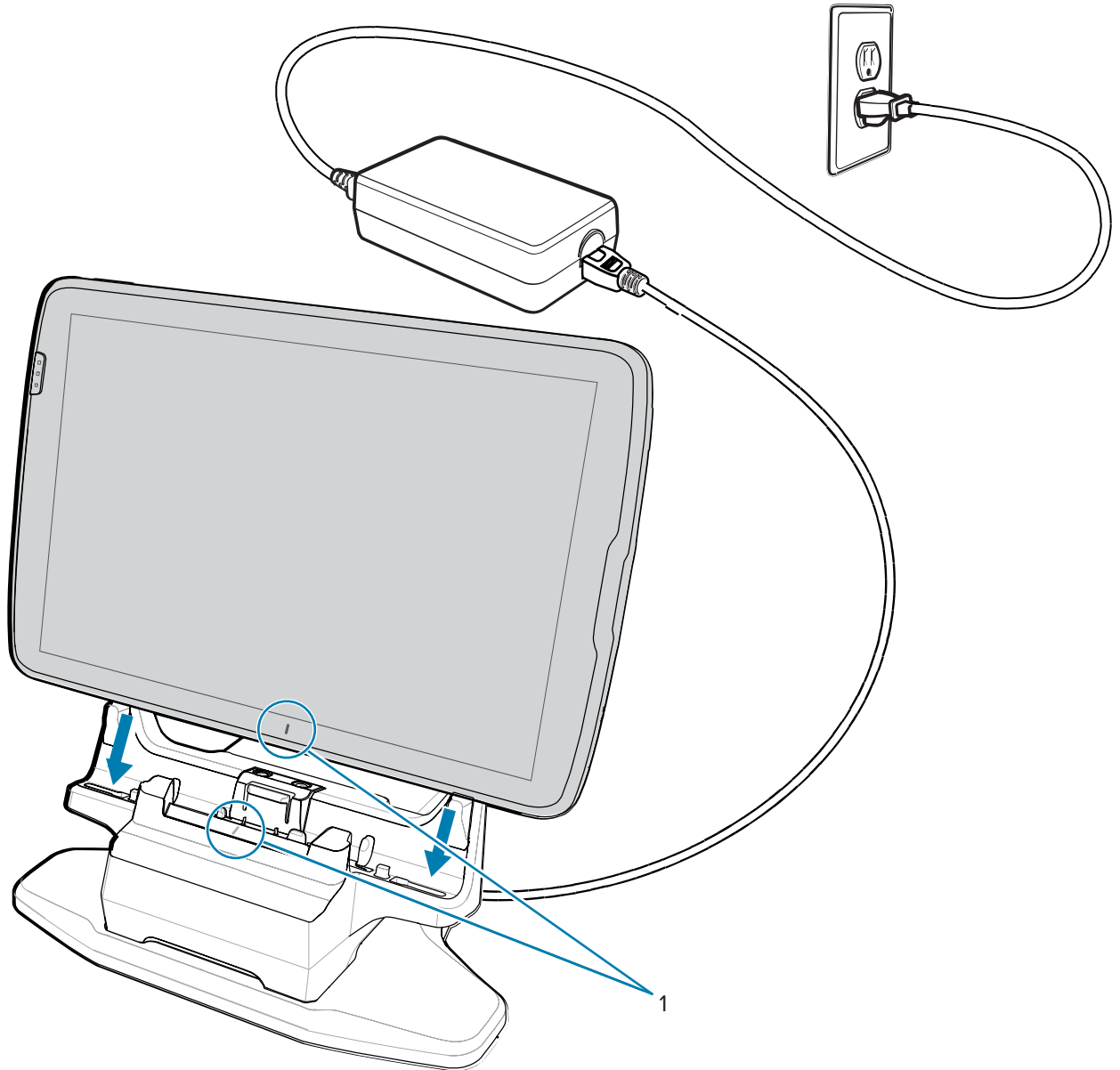

2. Insert the device into the cradle (1) and rotate it backwards (2) until it clicks.

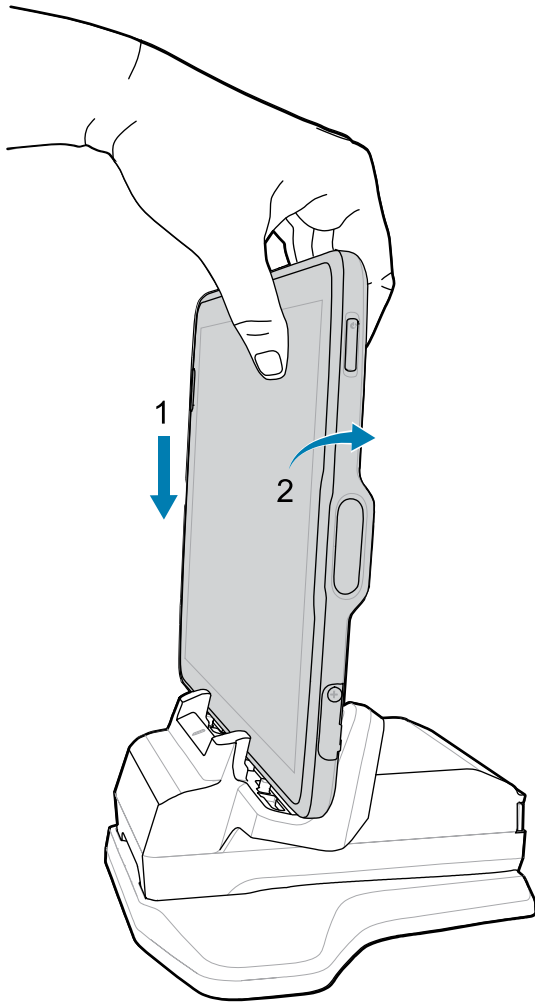

The device is locked in the cradle and the device Charging LED indicates charging.

3. To remove the device from the cradle, rotate the device forward slightly (1) and lift it out of the cradle (2).

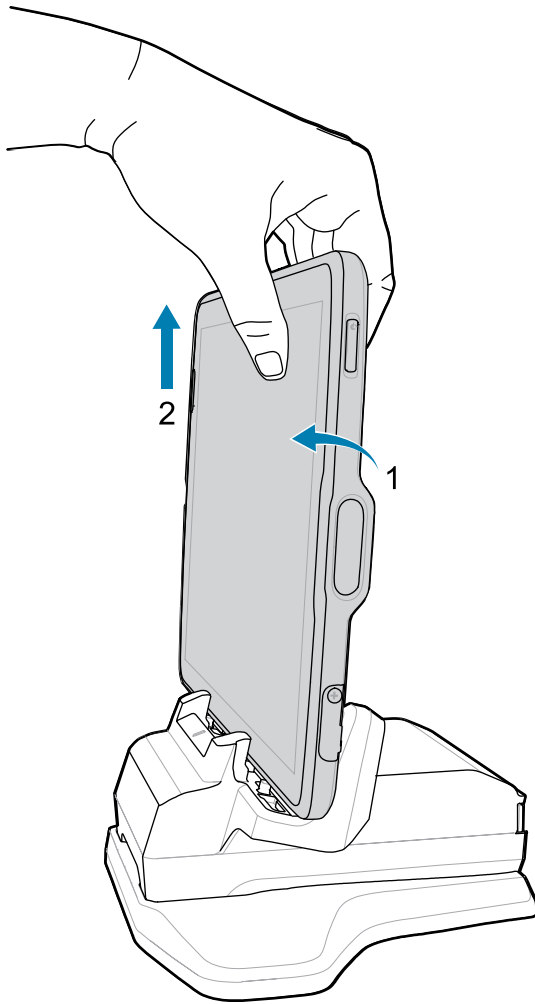

Powering on the Device

Press and hold the Power button until the menu appears.

Turning off the Display

To turn off the display press and release the Power button.

Turning off the Device

This section provides information on how to turn off the tablet.



NOTE: After the device is powered off and external power is applied to the device, the device will automatically power on. This includes powered cradles, Expansion Back with Power Pack, Rugged Charge Connector, and power supply/USB-C cable.

1. Press and hold the Power button until the menu appears.
2. Touch **Power off**.

Using the Device

This section explains how to use the device.

Home Screen

Turn on the device to display the Home screen. Depending on how your system administrator configured your device, your Home screen may appear differently than the graphics in this section.

After the device goes into Sleep mode, the Home screen displays with the lock slider. Touch the screen and slide up to unlock. The Home screen provides four additional screens to place widgets and shortcuts. Swipe the screen left or right to view the additional screens.



NOTE: By default, AOSP devices do not have the same icons on the Home screen as GMS devices. Icons are shown below for example only.

Home screen icons can be configured by the user and may look different than shown.

Figure 3 Home Screen

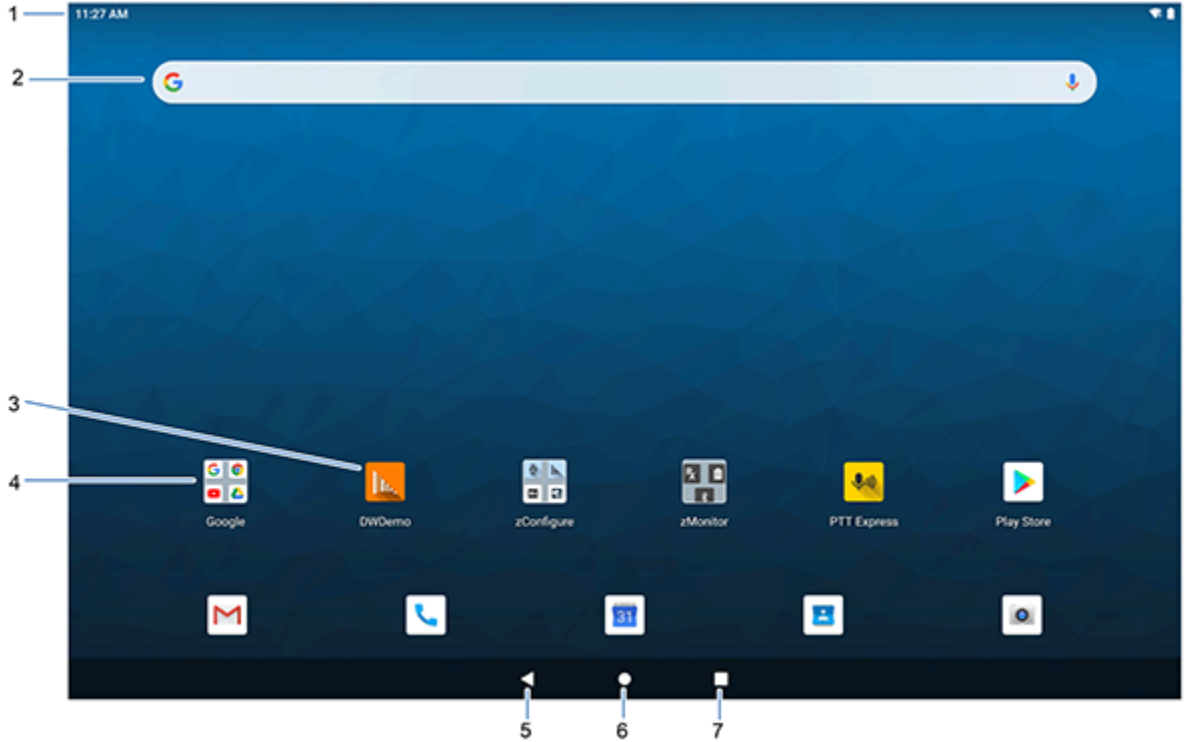

1	Status bar	Displays the time, status icons (right side), and notification icons (left side).
2	Widgets	Launches stand-alone apps that run on the Home screen.
3	Shortcut icons	Opens apps installed on the device.
4	Folder	Contains apps.
5	Back	Displays the previous screen.
6	Home	Displays the home screen.
7	Recent	Displays recently used applications.

Setting the Home Screen Rotation

By default, the Home screen rotation is disabled.

1. Touch and hold anywhere on the Home screen until the options appear.
2. Touch **Home settings**.
3. Touch the **Allow Home screen rotation** switch.
4. Touch **Home**.
5. Rotate the device.

Status Bar

The Status bar displays the time, notification icons (left side), and status icons (right side).

If there are more notifications than can fit in the Status bar, a dot displays indicating that more notifications exist. Swipe down from the Status bar to open the Notification panel and view all notifications and status.

Figure 4 Notifications and Status Icons











1	Notification icons
2	Status icons

Notification Icons

Table 5 Notification Icons

Icon	Description
	Main battery is low.
	More notifications are available for viewing.
	Data is syncing.
	Indicates an upcoming event. AOSP devices only.
	Indicates an upcoming event. GMS devices only.
	Open Wi-Fi network is available.
	Audio is playing.
	Problem with sign-in or sync has occurred.
	Device is uploading data.
	Animated: the device is downloading data. Static: the download is complete.

Table 5 Notification Icons (Continued)

Icon	Description
	Device is connected to or disconnected from a virtual private network (VPN).
	Preparing internal storage by checking it for errors.
	USB debugging is enabled on the device.
	Wired headset with a boom module is connected to the device.
	Wired headset without a boom module is connected to the device.
	PTT Express Voice client status.
	Indicates the RxLogger app is running.
	Indicates the Bluetooth scanner is connected to the device.
	Indicates the ring scanner is connected to the device in HID mode.

Status Icons

Status icons display system information for the device.

Table 6 Status Icons





Icon	Description
	Alarm is active.
	Main battery is fully charged.
	Main battery is partially drained.
	Main battery charge is low.
	Main battery charge is very low.

Table 6 Status Icons (Continued)













Icon	Description
	Main battery is charging.
	UPS battery is fully charged.
	All sounds, except media and alarms, are muted. Vibrate mode is active.
	Do Not Disturb mode active.
	Airplane Mode is active. All radios are turned off.
	Bluetooth is on.
	Connected to a Bluetooth device.
	Connected to a Wi-Fi network. Indicates the Wi-Fi version number.
	Not connected to a Wi-Fi network or no Wi-Fi signal.
	Connected to an Ethernet network.
	Speakerphone enabled.
	Portable Wi-Fi hotspot is active (WWAN only).
4G LTE	Connected to a 4G LTE/LTE-CA network (WWAN only). ^a
4G	Connected to a DC-HSPA, HSDPA, HSPA+, HSUPA, LTE/LTE-CA or WCDMA network (WWAN only). ^a
3G	Connected to a WCDMA network (WWAN only). ^a
H	Connected to a DC - HSPA, HSDPA, HSPA+ or HSUPA network (WWAN only). ^a
E	Connected to an EDGE network (WWAN only). ^a

Table 6 Status Icons (Continued)

Icon	Description
G	Connected to a GPRS network (WWAN only). ^a
R ↓↑	Roaming from a network (WWAN only).
	No SIM card installed (WWAN only).
^a Cellular network icon that appears is dependent upon the carrier/network.	

Managing Notifications

Notification icons report the arrival of new messages, calendar events, alarms, and ongoing events. When a notification occurs, an icon appears in the Status bar with a brief description.

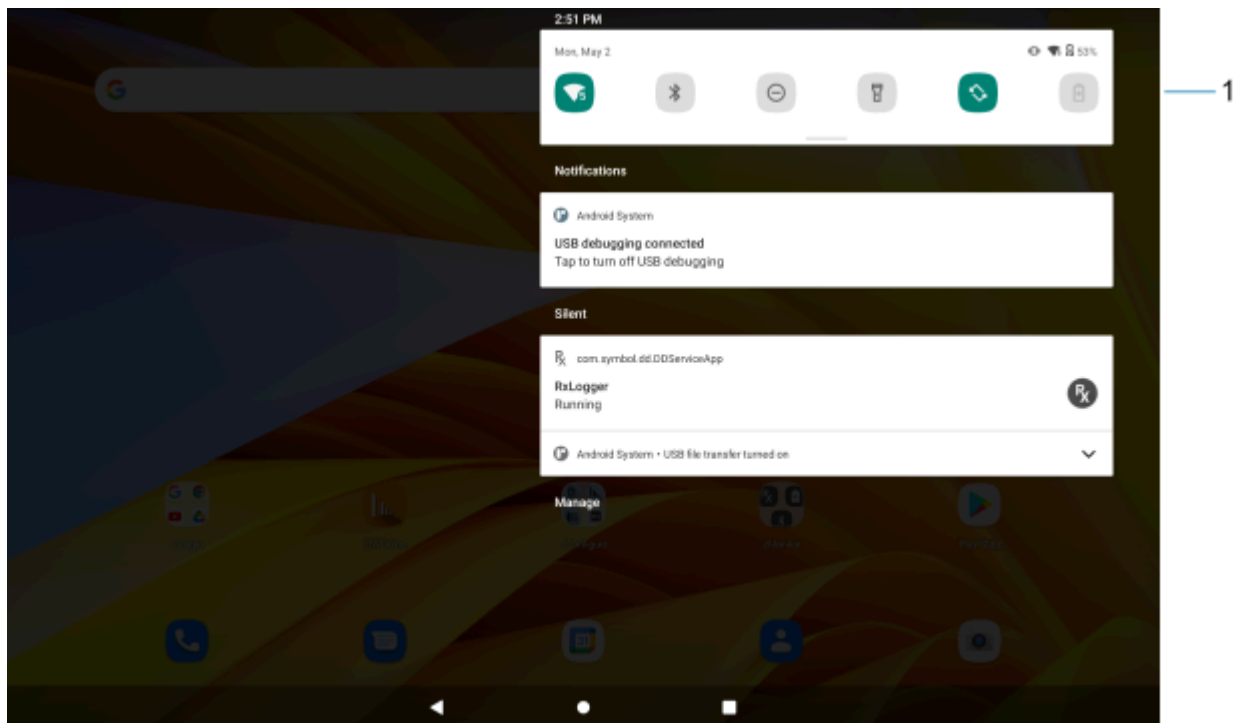
Figure 5 Notification Panel

1	Quick settings bar
---	--------------------

- To view a list of all notifications, open the Notification panel by dragging the Status bar down from the top of the screen.
- To respond to a notification, open the Notification panel and then touch a notification. The Notification panel closes and the corresponding app opens.

- To manage recent or frequently used notifications, open the Notification panel and then touch Manage notifications. Touch the toggle switch next to an app to turn off all notifications, or touch an app for more notification options.
- To clear all notifications, open the Notification panel and then touch CLEAR ALL. All event-based notifications are removed. Ongoing notifications remain in the list.
- To close the Notification panel, swipe the Notification panel up.

Quick Access Panel Icons

Quick Access panel icons indicate frequently used settings (for example, Airplane mode).

Table 7 Quick Access Panel Icons





















Icon	Description
	Display brightness - Use the slider to decrease or increase the brightness of the screen.
	Wi-Fi network - Turn Wi-Fi on or off. To open Wi-Fi settings, touch the Wi-Fi network name.
	Bluetooth settings - Turn Bluetooth on or off. To open Bluetooth settings, touch Bluetooth.
	Battery saver - Turn Battery saver mode on or off. When Battery saver mode is on the performance of the device is reduced to preserve battery power (not applicable).
	Invert colors - Invert the display colors.
	Do not disturb - Control how and when to receive notifications.
	Mobile data - Turns cellular radio on or off. To open Mobile data settings, touch and hold (WWAN only).
	Airplane mode - Turn Airplane mode on or off. When Airplane mode is on the device does not connect to Wi-Fi or Bluetooth.
	Auto-rotate - Lock the device's orientation in portrait or landscape mode or set to automatically rotate.
	Flashlight - Turn flashlight on or off. Turn camera flash on or off. On camera-only devices without an internal scan engine, the flashlight turns off when an app is opened. This ensures the camera is available for scanning.
	Location - Enable or disable locationing feature.
	Hotspot - Turn on to share the device's mobile data connection with other devices.

Table 7 Quick Access Panel Icons (Continued)

Icon	Description
	Data Saver - Turn on to prevent some apps from sending or receiving data in the background.
	Night Light - Tint the screen amber to make it easier to look at the screen in dim light. Set Night Light to turn on automatically from sunset to sunrise, or at other times.
	Screen Cast - Share phone content on Chromecast or a television with Chromecast built-in. Touch cast screen to display a list of devices, then touch a device to begin casting.
	Dark Theme - Toggles dark theme on and off. Dark themes reduce the luminance emitted by the screen, while meeting minimum color contrast ratios. It helps improve visual ergonomics by reducing eye strain, adjusting brightness to current lighting conditions, and facilitating screen use in dark environments, while conserving battery power.
	Focus mode - Turn on to pause distracting apps. To open Focus mode settings, touch and hold.
	Bedtime mode - Turn grayscale on and off. Grayscale turns the screen black and white, reducing phone distractions and improving battery life.
	Nearby Share - Helps find and interact with services and devices close to the device.
	Screen Record - Makes a video recording of everything that happens on the screen, with options to include audio and screen touches.
	NFC - Enable or disable NFC communication.

Opening the Quick Access Panel

Use the Quick Access panel to access frequently used settings (for example, Airplane mode).

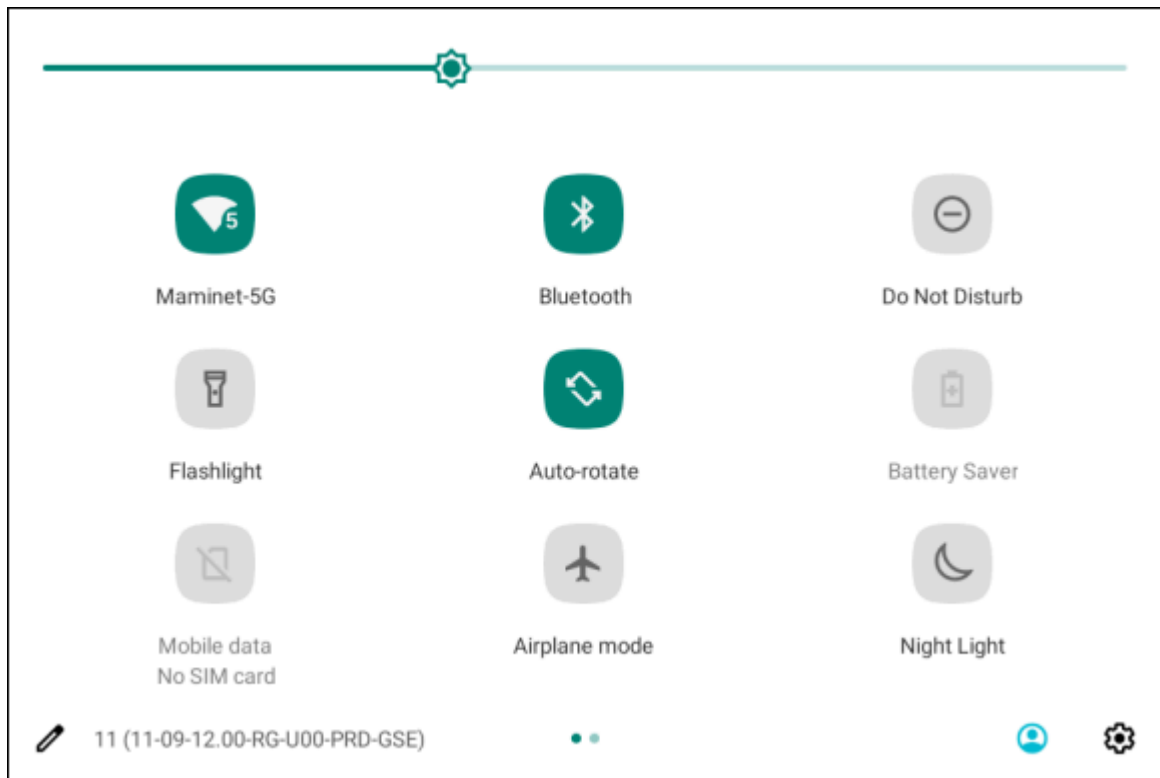

NOTE: Not all icons are pictured. Icons may vary.

Figure 6 Quick Access Panel

- If the device is locked, swipe down once.
- If the device is unlocked, swipe down once with two fingers, or twice with one finger.
- If the Notification panel is open, swipe down from the Quick Settings bar.

Editing Icons on the Quick Settings Bar

The first several setting tiles from the Quick Access panel become the Quick Settings bar.

- Open the Quick Access panel and touch  to edit, add, or remove settings tiles.

Battery Management

Observe the recommended battery optimization tips for the device.

- Set the screen to turn off after a short period of inactivity.
- Reduce screen brightness.
- Turn off all wireless radios when not in use.
- Turn off automatic syncing for Email, Calendar, Contacts, and other apps.
- Minimize the use of apps that keep the device from sleeping, for example, music and video apps.



NOTE: Before checking the battery charge level, remove the device from any AC power source (cradle or cable).

Checking Battery Status

- Open **Settings** and touch **About phone** > **Battery Information**. Or, swipe up from the bottom of the screen and touch  to open the **Battery Manager** app.

Battery present status indicates if the battery is present.

Battery level lists the battery charge (as a percentage of fully charged).

- Swipe down with two fingers from the status bar to open the quick access panel.

Battery percentage is displayed next to the battery icon.

Monitoring Battery Usage

The Battery screen provides battery charge details and power management options to extend battery life. Different apps display different information. Some apps include buttons that open screens with settings to adjust power use. Use the **DISABLE**, or **FORCE STOP** buttons to turn off apps that consume too much power.

- Go to **Settings**.
- Touch **Battery**.

To display battery information and power management options for a specific app:

- Go to **Settings**.
- Touch **Apps & notifications**.
- Touch an app.
- Touch **Advanced** > **Battery**.

Low Battery Notification

When the battery charge level drops below the change level in the table below, the device displays a notice to connect the device to power. Charge the battery using one of the charging accessories.

Table 8 Low Battery Notification

Charge Level Drops Below	Action
18%	The user should charge the battery soon.
10%	The user must charge the battery.
4%	The device turns off. The user must charge the battery.

Interactive Sensor Technology

To take advantage of these sensors, applications use API commands. Refer to the Google Android Sensor APIs for more information. For information on the Zebra Android EMDK, go to: techdocs.zebra.com.

The device contains sensors that monitor movement, orientation, and ambient light.

- Gyroscope - Measures angular rotational velocity to detect rotation of the device.
- Accelerometer - Measures the linear acceleration of movement to detect the orientation of the device.

- Digital Compass - The digital compass or magnetometer provides simple orientation in relation to the Earth's magnetic field. As a result, the device always knows which way is North so it can auto rotate digital maps depending on the physical orientation of the device.
- Light Sensor - Detects ambient light and adjusts the screen brightness.

Waking the Device

The device goes into Sleep mode when you press **Power** or after a period of inactivity (set in the Display settings window).

1. To wake the device from Sleep mode, press **Power** or the configured wake-up sources.

The Lock screen displays.

2. Swipe the screen up to unlock.

- If the Pattern screen unlock feature is enabled, the Pattern screen appears instead of the Lock screen.
- If the PIN or Password screen unlock feature is enabled, enter the PIN or password after unlocking the screen.



NOTE: If you enter the PIN, password, or pattern incorrectly five times, you must wait 30 seconds before trying again.

- If you forget the PIN, password, or pattern, contact your system administrator.

USB Communication

Connect the device to a host computer to transfer files between the device and the host computer.

When connecting the device to a host computer, follow the host computer's instructions for connecting and disconnecting USB devices, to avoid damaging or corrupting files.

Transferring Files

Use Transfer files to copy files between the device and the host computer.

1. Connect the device to a host computer using a USB accessory.
2. On the device, pull down the Notification panel and touch **Charging this device via USB**.

By default, **No data transfer** is selected.

3. Touch **File Transfer**.



NOTE: After changing the setting to **File Transfer**, and then disconnecting the USB cable, the setting reverts back to **No data transfer**. If the USB cable is reconnected, select **File Transfer** again.

4. On the host computer, open **File Explorer**.
5. Locate the **device** as a portable device.
6. Open the **Internal storage** folder.
7. Copy files to and from the device or delete files as required.

Transferring Photos

Use PTP to copy photos from the device to the host computer.

1. Connect the device to a host computer using a USB accessory.
2. On the device, pull down the Notification panel and touch **Charging this device via USB**.
3. Touch **PTP**.
4. On the host computer, open a file explorer application.
5. Open the SD card or the Internal storage folder.
6. Copy or delete photos as required.

Disconnecting from the Host Computer



CAUTION: Carefully follow the host computer's instructions to disconnect USB devices correctly to avoid losing information.



1. On the host computer, unmount the device.
2. Remove the device from the USB accessory.

Settings

This section describes the settings on the device.

Accessing Settings

There are multiple ways to access settings on a device.

- Swipe down with two fingers from the top of the Home screen to open the Quick Access panel and touch .
- Double-swipe down from the top of the Home screen to open the Quick Access panel and touch .
- Swipe up from the bottom of the Home screen to open APPS and touch  **Settings**.

Display Settings

Use Display settings to change the screen brightness, enable night light, change the background image, enable screen rotation, set screen timeout, and change font size.

Setting the Screen Brightness Manually

Manually set the screen brightness using the touchscreen.

1. Swipe down with two fingers from the Status bar to open the Quick Access panel.
2. Slide the icon to adjust the screen brightness level.



Setting the Screen Brightness Automatically

Automatically adjust the screen brightness using the built-in light sensor.

1. Go to **Settings**.
2. Touch **Display**.
3. If disabled, touch **Adaptive brightness** to automatically adjust the brightness.

By default, **Adaptive brightness** is enabled. Toggle the switch to disable.

Setting Night Light

The Night Light setting tints the screen amber, making the screen easier to look at in low light.

1. Go to **Settings**.
2. Touch **Display**.
3. Touch **Night Light**.
4. Touch **Schedule**.
5. Select one of the schedule values:
 - None (default)
 - Turns on at custom time
 - Turns on from sunset to sunrise.
6. By default, **Night Light** is disabled. Touch **TURN ON NOW** to enable.
7. Adjust the tint using the **Intensity** slider.

Setting Screen Rotation

By default, screen rotation is enabled.



NOTE: To change the Home screen rotation, see [Setting the Home Screen Rotation](#) on page 28.

1. Go to **Settings**.
2. Touch **Display > Advanced**.
3. Touch **Auto-rotate screen**.
4. Touch **Home**.

Setting Screen Timeout

The screen turns off and goes into Sleep mode after the selected period of inactivity.

1. Go to **Settings**.
2. Touch **Display > Advanced > Screen timeout**.
3. Select one of the screen timeout values:
 - **15 seconds**
 - **30 minutes**
 - **1 minute** (default)
 - **2 minutes**
 - **5 minutes**
 - **10 minutes**
 - **30 minutes**

Setting Lock Screen Notifications

The lock screen display setting wakes the screen when notifications are received.

1. Go to **Settings**.
2. Touch **Display > Advanced**.
3. Touch **Lock screen**.
4. In the **When to show** section, enable or disable an option using the switch.

Setting Font Size

Set the size of the font in system apps.

1. Go to **Settings**.
2. Touch **Display > Advanced**.
3. Touch **Font size**.
4. Select an option to choose how long the touch key light stays on:
 - **Small**
 - **Default**
 - **Large**
 - **Largest**.

Setting Display Size

By default, display size is set to default.

1. Go to **Settings**.
2. Touch **Display > Advanced**.
3. Touch **Display size**.
4. Touch - and + to change the display size.
 - **Small**
 - **Default**
 - **Large**
 - **Larger**
 - **Largest**

Setting Touch Panel Mode

The device display is able to detect touches using a finger, a conductive-tip stylus, or gloved finger.



NOTE: A glove can be made of medical latex, leather, cotton, or wool. For optimal performance use a Zebra certified stylus.

1. Go to **Settings**.
2. Touch **Display > Advanced**.

3. Touch **Touch panel mode**.
4. Select:
 - **Glove and Finger (Screen Protector OFF)** to use a finger or a gloved finger on the screen without a screen protector.
 - **Stylus and Finger (Screen Protector OFF)** to use a finger or a stylus on the screen without a screen protector.
 - **Finger Only** to use a finger on the screen.
 - **Stylus, Glove and Finger** to use a stylus, gloved finger, or a finger on the screen.
5. Touch **Home**.

Setting the Date and Time

The date and time are automatically synchronized using a NITZ server when the device is connected to a cellular/wireless network. You are only required to set the time zone or set the date and time if the wireless LAN does not support Network Time Protocol (NTP) or when not connected to a cellular/wireless network.

1. Go to **Settings**.
2. Touch **System** > **Date & time**.
3. Touch **Use network-provided time** to disable automatic date and time synchronization.
4. Touch **Use network-provided time zone** to disable automatic time zone synchronization.
5. Touch **Date** to select the date in the calendar.
6. Touch **OK**.
7. Touch **Time**.
 - a) Touch the green circle, drag to the current hour, and then release.
 - b) Touch the green circle, drag to the current minute, and then release.
 - c) Touch **AM** or **PM**.
8. Touch **Time zone** to select the current time zone from the list.
9. Touch **Update Interval** to select an interval to synchronize the system time from the network.
10. In **TIME FORMAT**, choose either **Use local default** or **Use 24-hour format**.

General Sound Setting

Press the volume buttons on the device to display on-screen volume controls.

Use the Sound settings to configure media and alarm volumes.

1. Go to **Settings**.
2. Touch **Sound**.
3. Touch an option to set sounds.

Sound Options

- **Media volume** - Controls the music, games, and media volume.

- **Call volume** - Controls the volume during a call.
- **Ring & notification volume** - Controls the ringtone and notification volume.
- **Alarm volume** - Controls the alarm clock volume.
- **Vibrate for calls** - Switch on or off.
- **Do Not Disturb** - Mutes some or all sounds and vibrations.
- **Media** - Shows the media player in Quick Settings while sound is playing, allowing quick access.
- **Shortcut to prevent ringing** - Turn on the switch to make the device vibrate when a call is received (default – disabled).
- **Default notification sound** - Select a sound to play for all system notifications.
- **Default alarm sound** - Select a sound to play for alarms.
- **Other sounds and vibrations**
 - **Dial pad tones** - Play a sound when pressing keys on dial pad (default - disabled).
 - **Screen locking sounds** - Play a sound when locking and unlocking the screen (default – enabled).
 - **Charging sounds and vibration** - Play a sound and vibrate when power is applied to the device (default - enabled).
 - **Touch sounds** - Play a sound when making screen selections (default – enabled).
 - **Touch vibration** - Vibrate the device when making screen selections (default – enabled).

Zebra Volume Controls

In addition to the default sound settings, Zebra Volume Controls display when the volume buttons are pressed.

Zebra Volume Controls are configured using Audio Volume UI Manager (AudioVolUIMgr). Administrators can use AudioVolUIMgr to add, delete and replace Audio Profiles, select an Audio Profile to use the device, and modify the default Audio Profile. For information on how to configure Zebra Volume Controls using AudioVolUIMgr, refer to techdocs.zebra.com.

Remapping a Button

Buttons on the device can be programmed to perform different functions or as shortcuts to installed apps. For a list of key names and descriptions, refer to: techdocs.zebra.com.

1. Go to **Settings**.
2. Touch **Key Programmer**. A list of programmable buttons displays.
3. Select the button to remap.
4. Touch the **SHORTCUT**, the **KEYS and BUTTONS**, or the **TRIGGERS** tabs that list the available functions, applications, and triggers.
5. Touch a function or application shortcut to map to the button.



NOTE: If you select an application shortcut, the application icon appears next to the button on the Key Programmer screen.

6. Touch **Home**.

Remappable Keys

Indicates the button on the device that can be remapped.

Figure 7 Key Positions

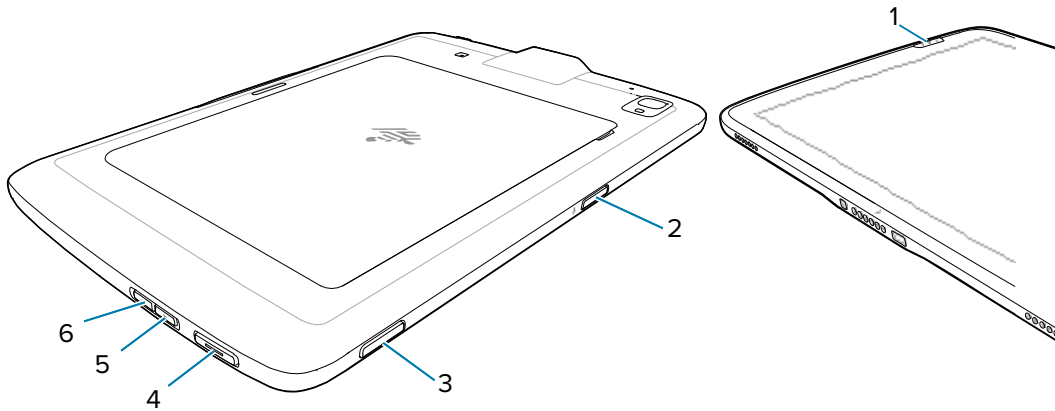

1	SCAN
2	RIGHT_TRIGGER_1
3	P1
4	LEFT_TRIGGER
5	VOLUMEUP
6	VOLUMEDOWN
	GRIP_TRIGGER (not shown)

Keyboards

The device provides multiple keyboard options.



NOTE: The Enterprise Keyboard is available for download from the [Zebra Support Site](#).

- Android Keyboard - AOSP devices only
- Gboard - GMS devices only
- Enterprise Keyboard - Not pre-installed on the device. Contact Zebra Support for more information.

Keyboard Configuration

This section describes configuring the device's keyboard.

Enabling Keyboards

1. Go to **Settings**.



2. Touch **System** > **Languages & input** > **On-screen keyboard** > **Manage on-screen keyboards**.
3. Touch a keyboard to enable.

Switching Between Keyboards

To switch between keyboards, touch in a text box to display the current keyboard.



NOTE: By default, the Gboard is enabled. All other virtual keyboards are disabled.

- On the Gboard keyboard, touch and hold  (GMS devices only).
- On the Android keyboard, touch, and hold  (AOSP devices only).
- On the Enterprise keyboard, touch . Only available with Mobility DNA Enterprise License. Not pre-installed on the device. Contact Zebra Support for more information.

Using the Android and Gboard Keyboards

Use the Android or Gboard keyboards to enter text in a text field.

- To configure the keyboard settings, touch and hold "," (comma) and then select **Android keyboard settings**.

Edit Text

Edit entered text and use menu commands to cut, copy, and paste text within or across apps. Some apps do not support editing some or all of the text they display; others may offer their own way to select text.

Entering Numbers, Symbols, and Special Characters

1. Enter numbers and symbols.
 - Touch and hold one of the top-row keys until a menu appears then select a number or special character.
 - Touch the Shift key once for a single capital letter. Touch the Shift key twice to lock in uppercase. Touch the Shift key a third time to unlock Capslock.
 - Touch **?123** to switch to the numbers and symbols keyboard.
 - Touch the  key on the numbers and symbols keyboard to view additional symbols.
2. Enter special characters.
 - Touch and hold a number or symbol key to open a menu of additional symbols. A larger version of the key displays briefly over the keyboard.

Enterprise Keyboard

The Enterprise Keyboard contains multiple keyboard types.



NOTE: Only available with Mobility DNA Enterprise License.

- Numeric

- Alpha
- Special characters
- Data capture.

Numeric Tab

The numeric keyboard is labeled **123**. The keys displayed vary on the app being used. For example, an arrow displays in **Contacts**, however **Done** displays in **Email** account setup.

Alpha Tab

The alpha keyboard is labeled using the language code. For English, the alpha keyboard is labeled **EN**.

Additional Character Tab

The additional characters keyboard is labeled **#*/**.

- Touch  to enter emoji icons in a text message.
- Touch **ABC** to return to the Symbols keyboard.

Scan Tab

The Scan tab provides an easy data capture feature for scanning barcodes.

Language Usage

Use the **Language & input** settings to change the device's language, including words added to the dictionary.

Changing the Language Setting

1. Go to **Settings**.
2. Touch **System > Languages & input**.
3. Touch **Languages**. A list of available languages displays.
4. If the desired language is not listed, touch **Add a language** and select a language from the list.
5. Touch and hold  to the right of the desired language, then drag it to the top of the list.
6. The operating system text changes to the selected language.

Adding Words to the Dictionary

1. Go to **Settings**.
2. Touch **System > Languages & input > Advanced > Personal dictionary**.
3. If prompted, select the language where this word or phrase is stored.

4. Touch + to add a new word or phrase to the dictionary.
5. Enter the word or phrase.
6. In the Shortcut text box, enter a shortcut for the word or phrase.

Notifications

The user can configure notifications for the device and for specific apps. Device notifications settings allow the user to configure how notifications occur on the device. App notification settings allow the user to configure how notifications for a specific app occur.

To view device notification settings, touch **Settings > Apps & notifications > Notifications**. To view app notifications, **Settings > Apps & notifications > App info**, and then select an app.

Enabling Blink Light

The Notification LED lights blue when an app, such as email and VoIP, generates a programmable notification or to indicate when the device is connected to a Bluetooth device. By default, LED notifications are enabled.

1. Go to **Settings**.
2. Touch **Apps & notifications > Notifications > Advanced** .
3. Touch **Blink light** to toggle the notification on or off.

Applications

Apart from the standard pre-installed Android applications, the following table lists Zebra-specific applications installed on the device.

Installed Applications

Aside from the common Google apps, the Zebra-specific apps that are installed on the device are described in this section.

Table 9 Apps



















Item	Description
	Battery Manager - Displays battery information, including charge level, status, health and wear level, and use to place device in Battery Swap mode when replacing the battery.
	Bluetooth Pairing Utility – Use to pair a Zebra Bluetooth scanner with the device by scanning a barcode.
	Camera - Take photos or record videos.
	DataWedge - Enables data capture using the imager.
	DisplayLink Presenter - Use to present the device screen onto a connected monitor.
	DWDemo - Provides a way to demonstrate the data capture features using the imager.
	License Manager - Use to manage software licenses on the device.

Table 9 Apps (Continued)

Item	Description
	MSRN - Use to verify the authenticity of the paired Snap-on MSR and to provision the Snap-on MSR.
	Phone - Use to dial a phone number when used with some Voice over IP (VoIP) clients (VoIP telephony ready only).
	PTT Express - Use to launch PTT Express client for VoIP communication.
	RxLogger - Use to diagnose device and app issues.
	Settings - Use to configure the device.
	StageNow - Allows the device to stage a device for initial use by initiating the deployment of settings, firmware, and software.
	VC Settings - Use to control settings for the device.
	VoD - The Video on Device basic app provides a how-to video for proper device cleaning. For Video on Device licensing information, go to learning.zebra.com .
	Wireless Analyzer - A diagnostic intelligent app. Use to diagnose surrounding area and display network stats, such as coverage hole detection, or AP in the vicinity. Refer to the Worry Free Wi-Fi Analyzer Administrator Guide for Android. Only available with Mobility DNA Enterprise License.
	Zebra Bluetooth Settings - Use to configure Bluetooth logging.
	Zebra Data Services - Use to enable or disable Zebra Data Services. Some options are set by the system administrator.

Accessing Apps

Access all apps installed on the device using the APPS window.

1. On the Home screen, swipe up from the bottom of the screen.
2. Slide the **APPS** window up or down to view more app icons.

3. Touch an icon to open the app.

Switching Between Recent Apps

1. Touch **Recent**.
A window appears on the screen with icons of recently used apps.
2. Slide the apps displayed up and down to view all recently used apps.
3. Swipe left or right to remove the app from the list and force close the app.
4. Touch an icon to open an app or touch **Back** to return to the current screen.

Battery Manager

The Battery Manager provides detailed information about the battery.

This section also provides battery swap procedures for supported devices.



Opening Battery Manager

- To open the Battery Manager app, swipe up from the bottom of the Home screen, and then touch .

Battery Manager Information

The Battery Manager displays detailed information about battery charging, health, and status.

Table 10 Battery Icons

Battery Icon	Description
	Battery charge level is between 85% and 100%.
	Battery charge level is between 19% and 84%.
	Battery charge level is between 0% and 18%.

- **Level** - The current battery charge level as a percentage. Displays -% when the level is unknown.
- **Wear** - The health of the battery in graphical form. When the wear level exceeds 80%, the bar color changes to red.

- **Health** - The health of the battery. If a critical error occurs,  appears. Touch to view the error description.
 - **Decommission** - The battery is past its useful life and should be replaced. See system administrator.
 - **Good** - The battery is good.
 - **Charge error** - An error occurred while charging. See system administrator.
 - **Over Current** - An over-current condition occurred. See system administrator.
 - **Dead** - The battery has no charge. Replace the battery.
 - **Over Voltage** - An over-voltage condition occurred. See system administrator.
 - **Below Temperature** - The battery temperature is below the operating temperature. See system administrator.
 - **Failure Detected** - A failure has been detected in the battery. See system administrator.
 - **Unknown** - See system administrator.
- **Charge Status**
 - **Not charging** - The device is not connected to AC power.
 - **Charging-AC** - The device is connected to AC power and charging or is fast charging via USB.
 - **Charging-USB** - The device is connected to a host computer with a USB cable and charging.
 - **Discharging** - The battery is discharging.
 - **Full** - The battery is fully charged.
 - **Unknown** - The battery status is unknown.
- **Time until Full** - The amount of time until the battery is fully charged.

- **Time since charging** - The amount of time since the device began charging.
- **Advanced info** - Touch to view additional battery information.
 - **Battery present status** - Indicates that the battery is present.
 - **Battery scale** - The battery scale level used to determine battery level (100).
 - **Battery level** - The battery charge level as a percentage of scale.
 - **Battery voltage** - The current battery voltage in millivolts.
 - **Battery temperature** - The current battery temperature in degrees Centigrade.
 - **Battery technology** - The type of battery.
 - **Battery current** - The average current into or out of the battery over the last second in mAh.
 - **Battery manufacture date** - The date of manufacture.
 - **Battery serial number** - The battery serial number. The number matches the serial number printed on the battery label.
 - **Battery part number** - The battery part number.
 - **Battery decommission status** - Indicates if the battery is past its life span.
 - **Battery Good** - The battery is in good health.
 - **Decommissioned Battery** - The battery is past its useful life and should be replaced.
 - **Base cumulative charge** - Cumulative charge using Zebra charging equipment only.
 - **Battery present capacity** - Maximum amount of charge that could be pulled from the battery under the present discharge conditions if the battery were fully charged.
 - **Battery health percentage** - With a range from 0 to 100, this is the ratio of “present_capacity” to “design_capacity” at a discharge rate of “design_capacity”.
 - **% decommission threshold** - The default % decommission threshold for a gifted battery as 80%.
 - **Battery present charge** - Amount of usable charge remaining in the battery at present under the current discharge conditions.
 - **Battery total cumulative charge** - The total accumulated charge in all chargers.
 - **Battery time since first use** - The time passed since the battery was placed in a Zebra terminal for the first time.
 - **Battery error status** - The error status of the battery.
 - **App version** - The application version number.

Camera

This section provides information for taking photos and recording videos using the integrated digital cameras.

Taking Photos



NOTE: See [Photo Settings](#) for camera settings descriptions.

1. Swipe up from the bottom of the Home screen and touch **Camera**.

Figure 8

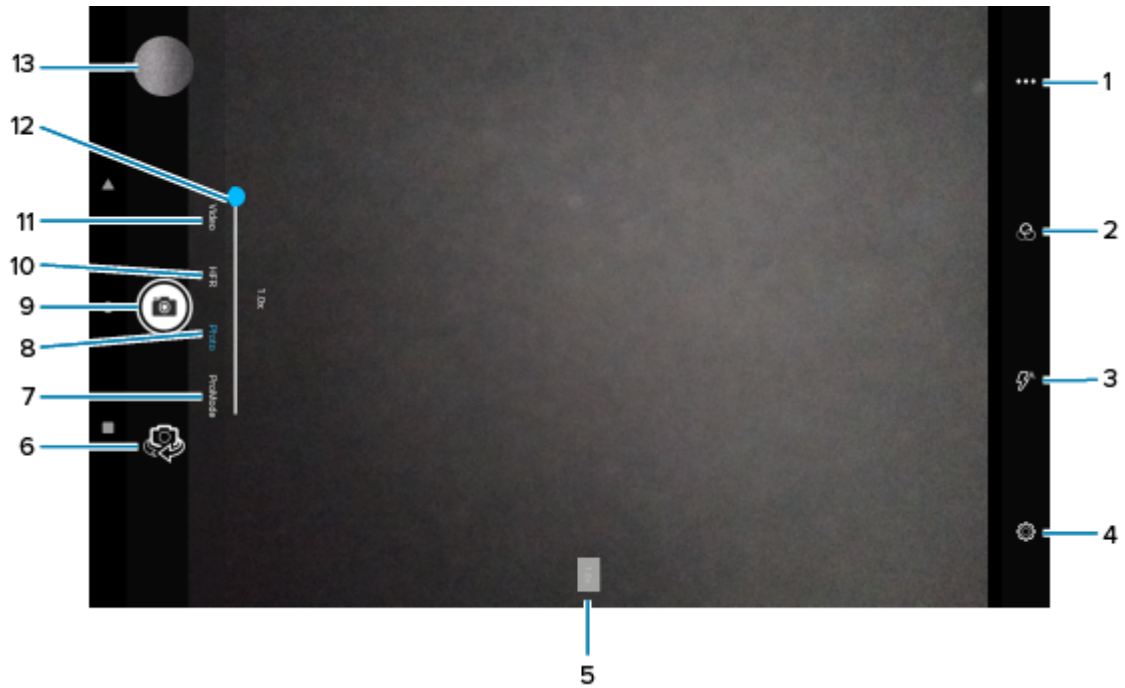



1	Scene mode and settings
2	Filters
3	Flash (rear camera only)
4	Settings
5	Quick zoom button (1.0x, 2.0x, 3.0x)
6	Camera switch (rear camera only)
7	Professional mode
8	Photo mode
9	Camera shutter button/Video record button/Video stop button
10	High frame rate video mode
11	Video mode
12	Zoom

2. Select Photo mode.
3. To switch between the rear camera and front camera (if available), touch .
4. Frame the subject on the screen.
5. To zoom in or out, use the Zoom slider or the Quick Zoom button.
6. Touch an area on the screen to focus. The focus circle appears. The two bars turn green when in focus.

7. Touch .

Recording Videos

Record videos using the device.

1. Swipe up from the bottom of the Home screen and touch **Camera**.
2. Select Video mode.
3. To switch between the rear camera and front camera (if available), touch .
4. Point the camera and frame the scene.
5. To zoom in or out, use the Zoom slider or the Quick Zoom button.
6. Touch  to start recording.

The video time remaining appears in the top left of the screen.

7. Touch  to end the recording.

Camera Settings

In the Camera app, touch  to display the camera settings options. Settings vary depending on whether the front or rear camera is active and which camera mode is active.

- General
 - **GPS location** - Turn On (default) or Off.
 - **Face Detection** - Select to turn face detection Off (default) or On.
 - **Storage** – Set the location to store the photo to: Phone or SD Card.
 - **Picture Format** - All still images are saved in JPEG format.

- Still Camera
 - **Countdown timer** - Select Off (default), 2 seconds, 5 seconds or 10 seconds.
 - **Continuous Shot** - Select to take a series of photos quickly while holding the capture button. Off (default) or On.
 - **Grid line** - Enable to apply a 3x3 grid guide to the camera viewport.
 - **Selfie Mirror** - Select to save a mirror image of the photo. Available for the front camera only. Options: Off (default) or On.
 - **Picture size** - The size (in pixels) of the photo to: 13M pixels (rear camera default), 8M pixels (rear camera only), 5M pixels (front camera default), 3M pixels, HD1080, 2M pixels, HD720, 1M pixels, WVGA, VGA, or QVGA.
 - **Picture quality** - Set the picture quality setting to: Low, Standard, or High (default).
 - **Redeye reduction** - Helps eliminate the redeye effect. Available for the rear camera only. Options: Disabled (default), or Enable.
 - **Exposure** - Set the exposure settings to: -2, -1.5, -1, -0.5, 0 (default), +0.5, +1, +1.5, +2.
 - **Selfie Flash** - Turns the screen white to help produce a little extra light in dimmer settings. Available for the front camera only. Options: Off (default), or On.
 - **Shutter Sound** - Select to play a shutter sound when taking a photo. Options: Disable or Enable (default).
 - **White balance** - Select how the camera adjusts colors in different kinds of light, to achieve the most natural-looking colors:
 - **Incandescent** - Adjust the white balance for incandescent lighting.
 - **Fluorescent** - Adjust the white balance for fluorescent lighting.
 - **Auto** - Adjust the white balance automatically (default).
 - **Daylight** - Adjust the white balance for daylight.
 - **Cloudy** - Adjust the white balance for a cloudy environment.

- Video Camera
 - **Video quality** - Set video quality to: HD 1080p (default), HD 720p, SD 480p, VGA, CIF, or QVGA.
 - **Video duration** - Set to: 30 seconds (MMS), 10 minutes, 30 minutes (default), or no limit.
 - **Image Stabilization** - Set to reduce blurry videos due to device movement. Options: On or Off (default).
 - **Noise Reduction** - Off (default), Fast, or High Quality.
 - **Video Encoder** - Set the video encoder to: MPEG4, H264 (default), or H265.
 - **Audio Encoder** - Set the audio encoder to: AMRNB, or AAC (default).
 - **Video Rotation** - Set the rotation of the video to: 0 (default), 90, 180, or 270.
 - **White balance** - Select how the camera adjusts colors in different kinds of light, to achieve the most natural-looking colors:
 - **Incandescent** - Adjust the white balance for incandescent lighting.
 - **Fluorescent** - Adjust the white balance for fluorescent lighting.
 - **Auto** - Adjust the white balance automatically (default).
 - **Daylight** - Adjust the white balance for daylight.
 - **Cloudy** - Adjust the white balance for a cloudy environment.
 - **Time Lapse** - Set the time lapse interval to: Off (default), or a time between 0.5 seconds and 24 hours.
- System
 - **Restore default** - Select to restore all settings to the default values.
 - **Version Info** - Displays the software version of the camera app.

DWDemo

Use DataWedge Demonstration (DWDemo) to demonstrate data capture functionality. To configure DataWedge, refer to techdocs.zebra.com/datawedge/.



NOTE: DataWedge is enabled on the Home screen. To disable this feature, go to the DataWedge settings and disable the **Launcher** profile.

DWDemo Icons

This table lists the icons available on the DWDemo app.

Table 11 DataWedge Demonstration Icons













Category	Icon	Description
Illumination		Imager illumination is on. Touch to turn illumination off.
Illumination		Imager illumination is off. Touch to turn illumination on.

Table 11 DataWedge Demonstration Icons (Continued)

Category	Icon	Description
Data Capture		Indicates a USB scanner is connected to the device.
Data Capture		Indicates a USB scanner is not connected to the device.
Data Capture		The data capture function is through the internal imager or USB scanner.
Data Capture		The data capture function is through the rear camera.
Data Capture		A Bluetooth scanner is connected.
Data Capture		A Bluetooth scanner is not connected.
Scan Mode		Imager is in picklist mode. Touch to change to normal scan mode.
Scan Mode		Imager is in normal scan mode. Touch to change to picklist mode.
Menu		Opens a menu to view the application information or to set the application DataWedge profile.

Selecting a Scanner

See the [Data Capture](#) on page 60 section for more information.

1. To select a scanner, touch  > **Settings** > **Scanner Selection**.
2. Press the programmable button or touch the yellow scan button to capture data. The data appears in the text field below the yellow button.

RxLogger

RxLogger is a comprehensive diagnostic tool that provides application and system metrics, and diagnoses device and application issues.

RxLogger logs the following information: CPU load, memory load, memory snapshots, battery consumption, power states, wireless logging, cellular logging, TCP dumps, Bluetooth logging, GPS logging, logcat, FTP push/pull, ANR dumps, etc. All generated logs and files are saved onto flash storage on the device (internal or external).

RxLogger logs the following information: CPU load, memory load, memory snapshots, battery consumption, power states, wireless logging, TCP dumps, Bluetooth logging, logcat, FTP push/pull, ANR dumps, etc. All generated logs and files are saved onto flash storage on the device (internal or external).

RxLogger Configuration

RxLogger is built with an extensible plug-in architecture and comes packaged with a number of plug-ins already built-in. For information on configuring RxLogger, refer to techdocs.zebra.com/rxlogger/.

To open the configuration screen, from the RxLogger home screen touch **Settings**.

Configuration File

RxLogger configuration can be set using an XML file.

The config.xml configuration file is located in the RxLogger\config folder. Copy the file from the device to a host computer using a USB connection. Edit the configuration file and then replace the XML file on the device. There is no need to stop and restart the RxLogger service since the file change is automatically detected.

The config.xml configuration file is located on the microSD card in the RxLogger\config folder. Copy the file from the device to a host computer using a USB connection. Edit the configuration file and then replace the XML file on the device. There is no need to stop and restart the RxLogger service since the file change is automatically detected.

Enabling Logging

1. Swipe the screen up and select .
2. Touch **Start**.

Disabling Logging

1. Swipe the screen up and select .
2. Touch **Stop**.

Extracting Log Files

1. Connect the device to a host computer using a USB connection.
2. Using a file explorer, navigate to the RxLogger folder.
3. Copy the file from the device to the host computer.
4. Disconnect the device from the host computer.

Backing Up Data

RxLogger Utility allows the user to make a zip file of the RxLogger folder in the device, which by default contains all the RxLogger logs stored in the device.

- To save the backup data, touch  > **BackupNow**.

RxLogger Utility

RxLogger Utility is a data monitoring application for viewing logs in the device while RxLogger is running. Logs and RxLogger Utility features are accessed using Main Chat Head.

Initiating the Main Chat Head

1. Open **RxLogger**.
2. Touch  > **Toggle Chat Head**.
The Main Chat Head icon appears on the screen.
3. Touch and drag the Main Chat Head icon to move it around the screen.

Removing the Main Chat Head

1. Touch and drag the icon.
A circle with an X appears.
2. Move the icon over the circle and then release.

Viewing Logs

1. Touch the Main Chat Head icon.
The RxLogger Utility screen appears.
2. Touch a log to open it.
The user can open many logs with each displaying a new Sub Chat Head.
3. If necessary, scroll left or right to view additional Sub Chat Head icons.
4. Touch a Sub Chat Head to display the log contents.

Removing a Sub Chat Head Icon

- To remove a Sub Chat Head icon, press and hold the icon until it disappears.

Backing Up In Overlay View

RxLogger Utility allows the user to make a zip file of the RxLogger folder in the device, which by default contains all the RxLogger logs stored in the device.

The Backup icon is always available in Overlay View.

1. Touch .
The Backup dialog box appears.
2. Touch **Yes** to create the backup.

Data Capture

This section provides information for capturing barcode data using various scanning options.

The tablets support data capture using:

- Camera
- SE4100 Internal Imager
- SE4710 Internal Imager
- SE4720 Internal Imager
- SE5500 Internal Imager
- RS507/RS507X
- RS5100
- RS6000
- DS2278
- DS3678
- DS8178
- LI3678

Imaging

The device with an integrated 2D imager has the following features:

- Omnidirectional reading of a variety of barcode symbologies, including the most popular linear, postal, PDF417, Digimarc, and 2D matrix code types.
- The ability to capture and download images to a host for a variety of imaging applications.
- Advanced intuitive laser aiming cross-hair and dot aiming for easy point-and-shoot operation.

The imager uses imaging technology to take a picture of a barcode, stores the resulting image in memory, and executes state-of-the-art software decoding algorithms to extract the barcode data from the image.

Scanning Considerations

Typically, scanning is a simple matter of aim, scan, and decode, with a few quick trial efforts to master it.

However, consider the following to optimize scanning performance:

- **Range** — Scanners decode best over a particular working range — minimum and maximum distances from the barcode. This range varies according to barcode density and scanning device optics. Scan within range for quick and constant decodes; scanning too close or too far away prevents decodes. Move the scanner closer and further away to find the right working range for the barcodes being scanned.
- **Angle** — Scanning angle is important for quick decodes. When the illumination/flash reflects directly back into the imager, the specular reflection can blind/saturate the imager. To avoid this, scan the barcode so that the beam does not bounce directly back. Do not scan at too sharp an angle; the scanner needs to collect scattered reflections from the scan to make a successful decode. Practice quickly shows what tolerances to work within.
- Hold the device farther away for larger symbols.
- Move the device closer for symbols with bars that are close together.



NOTE: Scanning procedures depend on the app and device configuration. An app may use different scanning procedures from the one listed above.

Scanning with an Internal Scanner

Use the internal scanner to capture barcode data.



NOTE: To read a barcode, a scan-enabled app is required. The device contains the DataWedge app that allows the user to enable the scanner to decode barcode data and display the barcode content.

1. Ensure that an app is open on the device and a text field is in focus (text cursor in the text field).
2. Point the exit window of the device at a barcode.

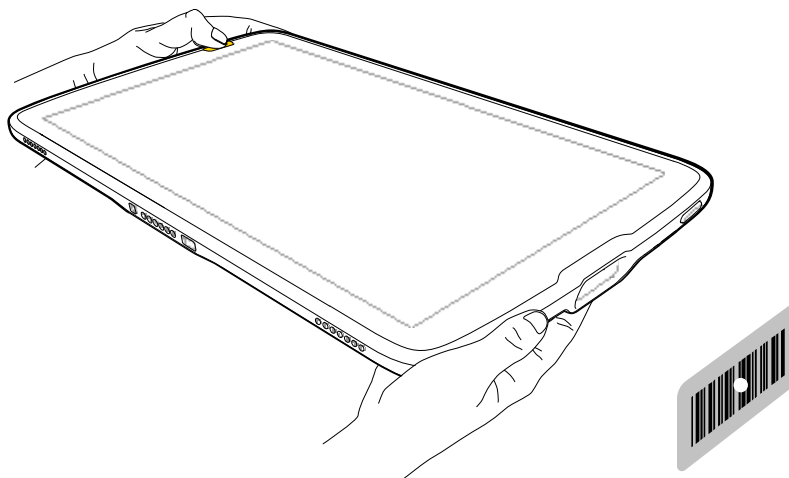

3. Press and hold one of the scan buttons.

The aiming dot with illumination turns on to assist in aiming.



NOTE: When the device is in Pick List Mode, the device does not decode the barcode until the center of the aiming dot touches the barcode.

4. Ensure the barcode is within the area formed by the aiming pattern. The aiming dot is used for increased visibility in bright lighting conditions.

The Data Capture LED lights green and a beep sounds, by default, to indicate the barcode was decoded successfully.

Scanning with the Camera

Use the internal camera to capture barcode data.



NOTE: To read a barcode, a scan-enabled app is required. The device contains the DataWedge app that allows the user to enable the scanner to decode barcode data and display the barcode content.



NOTE: The integrated camera is intended for light-duty barcode scanning. For heavy-duty scanning, 100 or more scans per day, use the 2D imager.

When capturing barcode data in poor lighting, turn on Illumination mode in the DataWedge application.

To scan with the internal camera:

1. Launch a scanning application.
2. Point the camera window at a barcode.

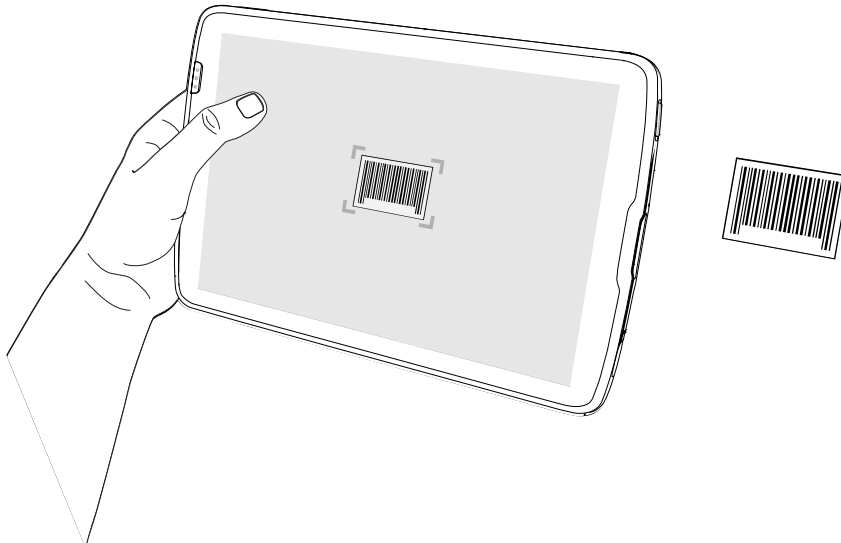

3. Press and hold the scan button. By default, a preview window appears on the screen.
4. Move the device until the barcode is visible on the screen.
5. If Picklist mode is enabled, move the device until the barcode is centered under the aiming dot on the screen.

The Decode LED lights green, a beep sounds and the device vibrates, by default, to indicate the barcode is decoded successfully.

The captured data appears in the text field.

Scanning with the RS507/RS507X Hands-Free Imager

Use the RS507/RS507X Hands-Free Imager to capture barcode data.

Figure 9 RS507/RS507X Hands-Free Imager

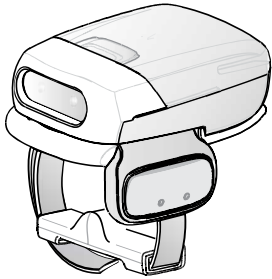

Refer to the RS507/RS507X Hands-free Imager Product Reference Guide for more information.



NOTE: To read a barcode, a scan-enabled app is required. The device contains the DataWedge app that allows the user to enable the scanner to decode barcode data and display the barcode content.

To scan with the RS507/RS507x:

1. Pair the RS507/RS507X with the device.
2. Ensure that an app is open on the device and a text field is in focus (text cursor in text field).
3. Point the RS507/RS507X at a barcode.

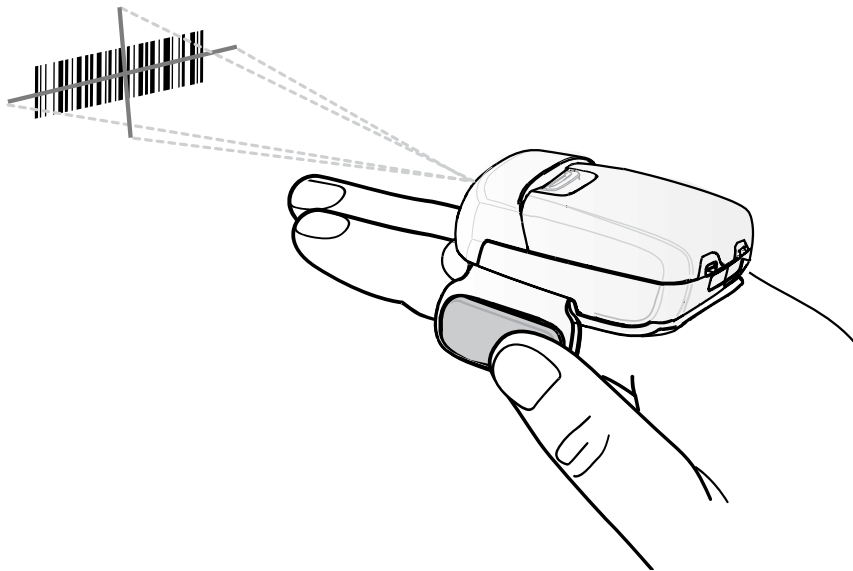

4. Press and hold the trigger.

The red laser aiming pattern turns on to assist in aiming. Ensure the barcode is within the area formed by the cross-hairs in the aiming pattern. The aiming dot increases visibility in bright lighting conditions.

Figure 10 RS507/RS507X Aiming Pattern

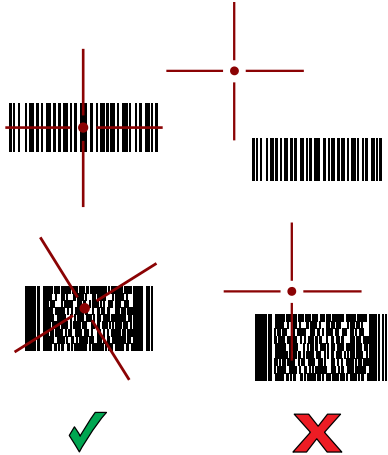

When the RS507/RS507X is in Pick List mode, the RS507/RS507X does not decode the barcode until the center of the crosshair touches the barcode.

Figure 11 RS507/RS507X Pick List Mode with Multiple Barcodes in Aiming Pattern



The RS507/RS507X LEDs light green and a beep sounds to indicate the barcode was decoded successfully.

The captured data appears in the text field.

Scanning with the RS5100 Ring Scanner

Use the RS5100 Ring Scanner to capture barcode data.

Figure 12 RS5100 Ring Scanner

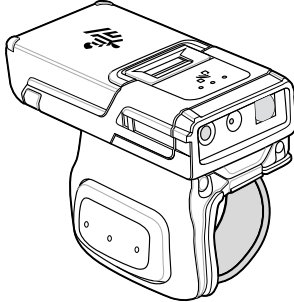

Refer to the RS5100 Ring Scanner Product Reference Guide for more information.



NOTE: To read a barcode, a scan-enabled app is required. The device contains the DataWedge app that allows the user to enable the scanner to decode barcode data and display the barcode content.

To scan with the RS5100:

1. Pair the RS5100 with the device.
2. Ensure that an app is open on the device and a text field is in focus (text cursor in text field).
3. Point the RS5100 at a barcode.

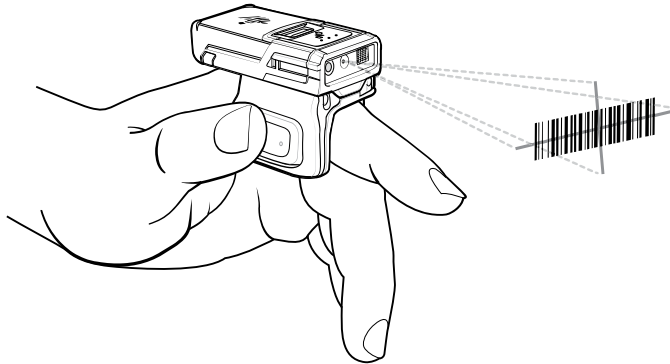

4. Press and hold the trigger.

The red laser aiming pattern turns on to assist in aiming. Ensure the barcode is within the area formed by the cross-hairs in the aiming pattern. The aiming dot increases visibility in bright lighting conditions.

Figure 13 RS5100 Aiming Pattern

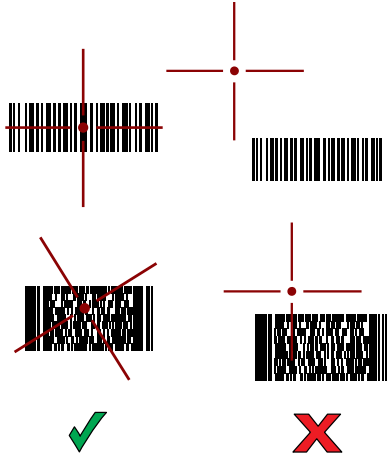

When the RS5100 is in Pick List mode, the RS5100 does not decode the barcode until the center of the crosshair touches the barcode.

Figure 14 RS5100 Pick List Mode with Multiple Barcodes in Aiming Pattern



The RS5100 LEDs light green and a beep sounds to indicate the barcode was decoded successfully. The captured data appears in the text field.

Scanning with the RS6000 Bluetooth Ring Scanner

Use the RS6000 Bluetooth Ring Scanner to capture barcode data.

Figure 15 RS6000 Bluetooth Ring Scanner

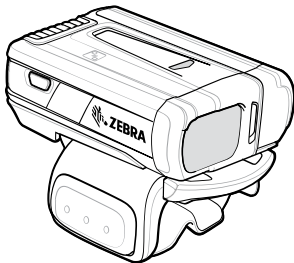

Refer to the RS6000 Bluetooth Ring Scanner Product Reference Guide for more information.



NOTE: To read a barcode, a scan-enabled app is required. The device contains the DataWedge app that allows the user to enable the scanner to decode barcode data and display the barcode content.

To scan with the RS6000:

1. Pair the RS6000 with the device.
2. Ensure that an app is open on the device and a text field is in focus (text cursor in text field).
3. Point the RS6000 at a barcode.

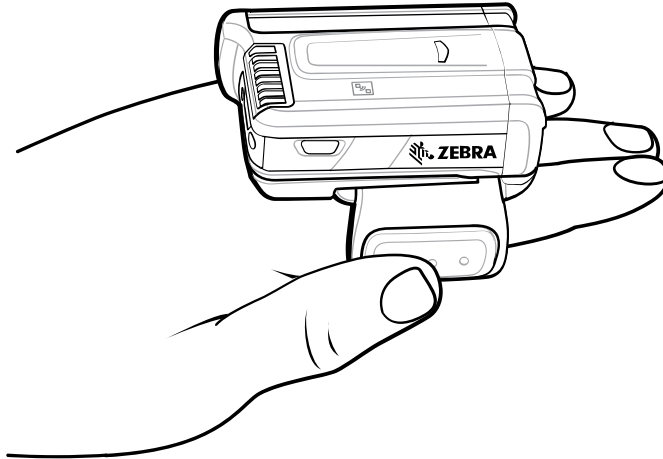

4. Press and hold the trigger.

The red laser aiming pattern turns on to assist in aiming. Ensure the barcode is within the area formed by the cross-hairs in the aiming pattern. The aiming dot increases visibility in bright lighting conditions.

Figure 16 RS6000 Aiming Pattern

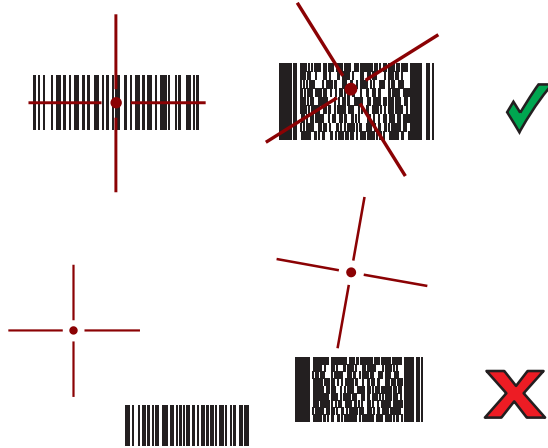

When the RS6000 is in Pick List mode, the RS6000 does not decode the barcode until the center of the crosshair touches the barcode.

Figure 17 RS6000 Pick List Mode with Multiple Barcodes in Aiming Pattern



The RS6000 LEDs light green and a beep sounds to indicate the barcode was decoded successfully. The captured data appears in the text field.

Scanning with the DS2278 Digital Scanner

Use the DS2278 Digital Scanner to capture barcode data.

Figure 18 DS2278 Digital Scanner



Refer to the DS2278 Digital Scanner Product Reference Guide for more information.



NOTE: To read a barcode, a scan-enabled app is required. The device contains the DataWedge app that allows the user to enable the scanner to decode barcode data and display the barcode content.

To scan with the DS2278:

1. Pair the DS2278 with the device. See [Pairing a Bluetooth Scanner](#) for more information.
2. Ensure that an app is open on the device and a text field is in focus (text cursor in text field).
3. Point the scanner at a barcode.

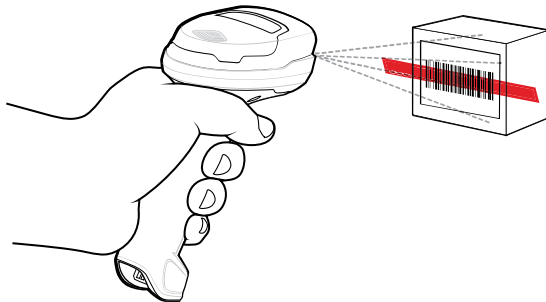

4. Press and hold the trigger.

5. Ensure the aiming pattern covers the barcode.



6. Upon successful decode, the scanner beeps and the LED flashes, and the scan line turns off. The captured data appears in the text field.

Scanning with the DS3678 Bluetooth Scanner

Use the DS3678 Bluetooth Scanner to capture barcode data.

Figure 19 DS3678 Digital Scanner

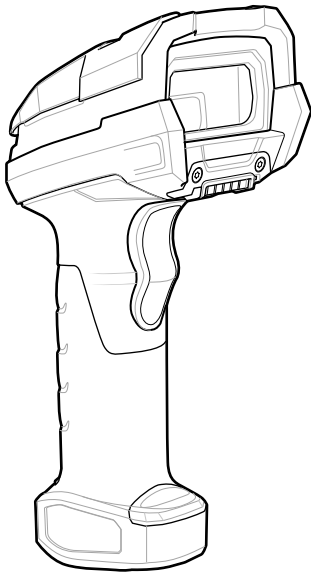

Refer to the DS3678 Product Reference Guide for more information.



NOTE: To read a barcode, a scan-enabled app is required. The device contains the DataWedge app that allows the user to enable the scanner to decode barcode data and display the barcode content.

To scan with the DS3678 scanner:

1. Pair the scanner with the device. See [Pairing Bluetooth Scanners](#) for more information.
2. Ensure that an app is open on the device and a text field is in focus (text cursor in text field).

3. Point the scanner at a barcode.

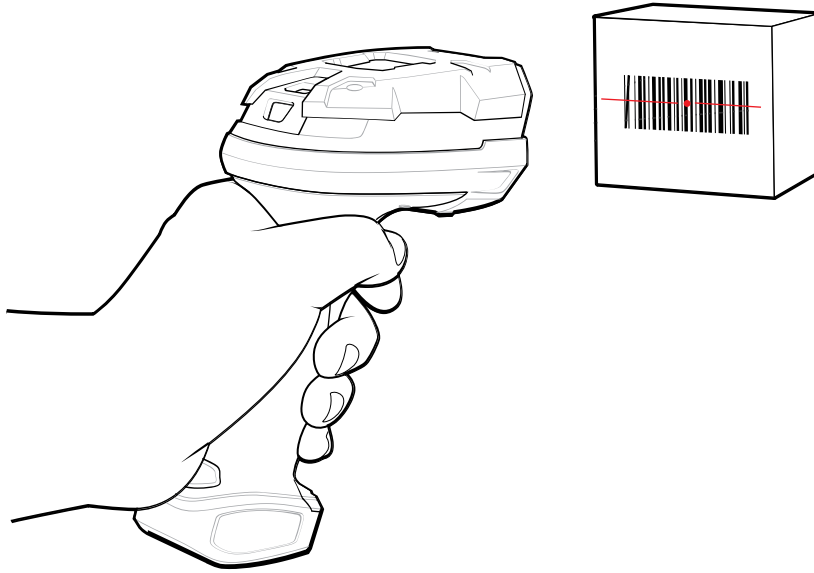

4. Press and hold the trigger.

Ensure the barcode is within the area formed by the aiming pattern. The aiming dot increases visibility in bright lighting conditions.

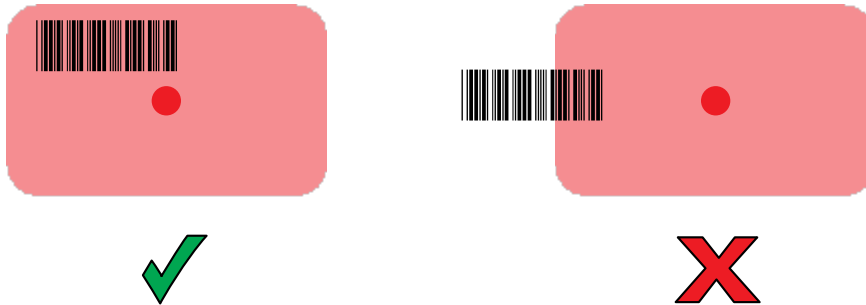

The captured data appears in the text field.

Scanning with the DS8178 Digital Scanner

Use the DS8178 Bluetooth Scanner to capture barcode data.

Figure 20 DS8178 Digital Scanner

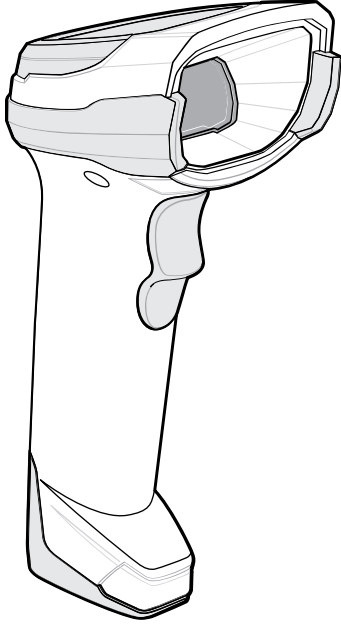

Refer to the DS8178 Digital Scanner Product Reference Guide for more information.



NOTE: To read a barcode, a scan-enabled app is required. The device contains the DataWedge app that allows the user to enable the scanner to decode barcode data and display the barcode content.

To scan with the DS8178 scanner:

1. Pair the scanner with the device. See [Pairing Bluetooth Scanners](#) for more information.
2. Ensure that an app is open on the device and a text field is in focus (text cursor in text field).
3. Point the scanner at a barcode.

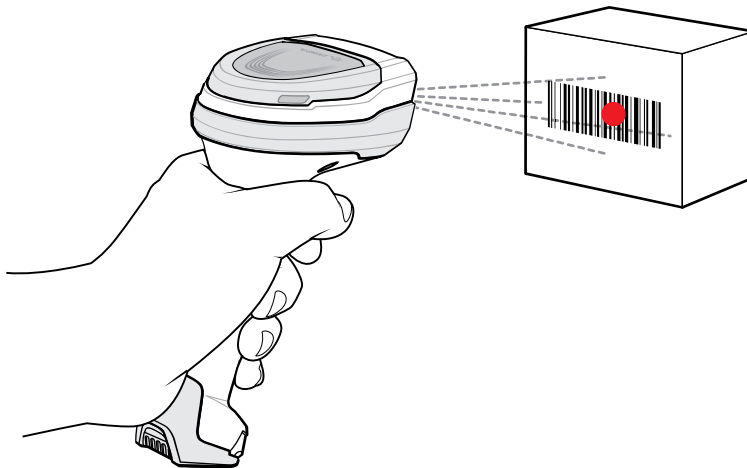

4. Press and hold the trigger.

5. Ensure the barcode is within the area formed by the aiming pattern. The aiming dot increases visibility in bright lighting conditions.

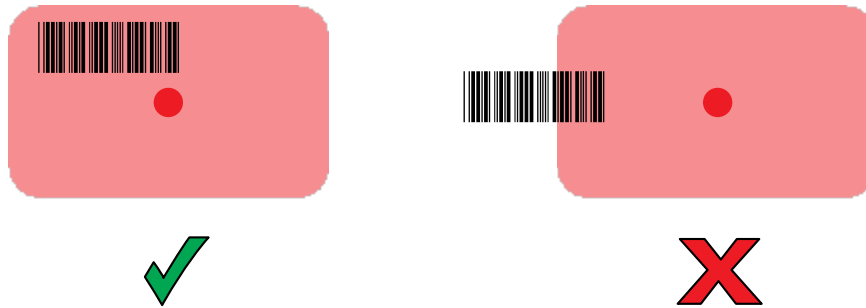

6. Upon successful decode, the scanner beeps and the LED flashes, and the scan line turns off. The captured data appears in the text field.

Scanning with the LI3678 Linear Imager

Use the LI3678 linear imager to capture barcode data.

Figure 21 LI3678 Bluetooth Scanner

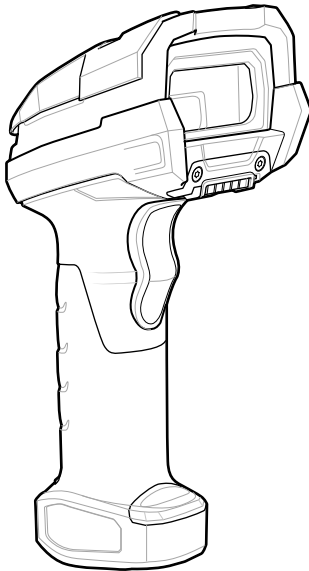

Refer to the LI3678 Product Reference Guide for more information.



NOTE: To read a barcode, a scan-enabled app is required. The device contains the DataWedge app that allows the user to enable the scanner to decode barcode data and display the barcode content.

To scan with the LI3678:

1. Pair the LI3678 with the device. See [Pairing a Bluetooth Scanner](#) for more information.
2. Ensure that an app is open on the device and a text field is in focus (text cursor in text field).
3. Point the LI3678 at a barcode.

4. Press and hold the trigger.

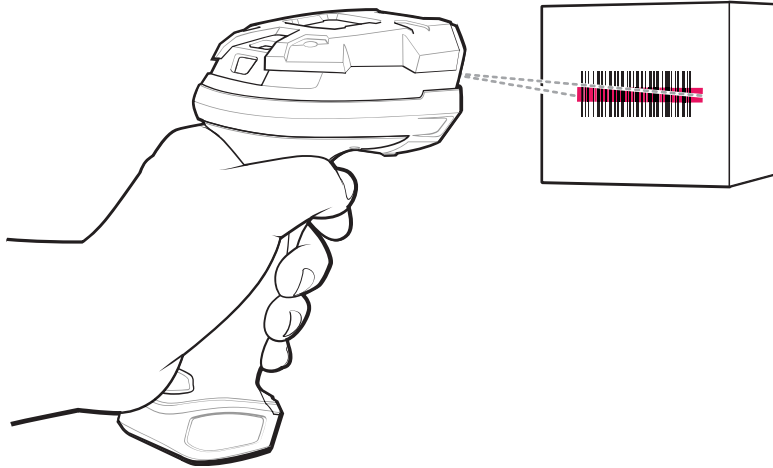

5. Ensure the aiming pattern covers the barcode.

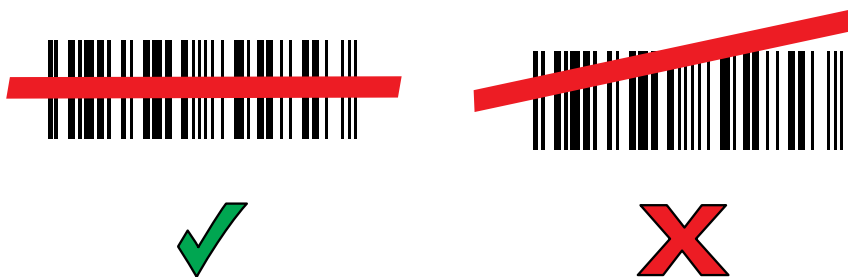

Upon successful decode, the scanner beeps and the LED displays a single green flash.

The captured data appears in the text field.

DataWedge

DataWedge is a utility that adds advanced barcode scanning capability to any application without writing code. It runs in the background and handles the interface to built-in barcode scanners. The captured barcode data is converted to keystrokes and sent to the target application as if it was typed on the keypad.

DataWedge allows any app on the device to get data from input sources such as a barcode scanner, MSR, RFID, voice, or serial port and manipulate the data based on options or rules.

Configure DataWedge to:

- Provide data capture services from any app.
- Use a particular scanner, reader, or other peripheral devices.
- Properly format and transmit data to a specific app.

To configure DataWedge, refer to techdocs.zebra.com/datawedge/.

Enabling DataWedge



This procedure provides information on how to enable DataWedge on the device.

1. Swipe up from the bottom of the Home screen and touch .

2. Touch  > **Settings**.
3. Touch the **DataWedge enabled** checkbox.
A blue checkmark appears in the checkbox indicating that DataWedge is enabled.

Disabling DataWedge

This procedure provides information on how to disable DataWedge on the device.

1. Swipe up from the bottom of the Home screen and touch .
2. Touch .
3. Touch **Settings**.
4. Touch **DataWedge enabled**.

Supported Decoders

The device supports the decoders listed in the following sections.

Camera Supported Decoders

Lists the supported decoders for the internal camera.

Table 12 Camera Supported Decoders

Decoder	Default State	Decoder	Default State	Decoder	Default State
Australian Postal	O	EAN8	X	MSI	O
Aztec	X	Grid Matrix	O	PDF417	X
Canadian Postal	O	GS1 DataBar	X	QR Code	X
Chinese 2 of 5	O	GS1 DataBar Expanded	X	Decoder Signature	O
Codabar	X	GS1 DataBar Limited	O	TLC 39	O
Code 11	O	GS1 Datamatrix	O	Trioptic 39	O
Code 128	X	GS1 QRCode	O	UK Postal	O
Code 39	X	HAN XIN	O	UPCA	X
Code 93	O	Interleaved 2 of 5	O	UPCE0	X
Composite AB	O	Japanese Postal	O	UPCE1	O
Composite C	O	Korean 3 of 5	O	US4state	O
Discrete 2 of 5	O	MAIL MARK	X	US4state FICS	O
Datamatrix	X	Matrix 2 of 5	O	US Planet	O

Table 12 Camera Supported Decoders (Continued)

Decoder	Default State	Decoder	Default State	Decoder	Default State
Dutch Postal	O	Maxicode	X	US Postnet	O
DotCode	X	MicroPDF	O		
EAN13	X	MicroQR	O		

Key: X = Enabled, O = Disabled, - = Not Supported

SE4100 Internal Imager Supported Decoders

Lists the supported decoders for the internal SE4100 imager.

Table 13 Internal SE4100 Imager Supported Decoders

Decoder	Default State	Decoder	Default State	Decoder	Default State
Australian Postal	O	EAN8	X	MSI	O
Aztec	X	Grid Matrix	O	PDF417	X
Canadian Postal	—	GS1 DataBar	X	QR Code	X
Chinese 2 of 5	O	GS1 DataBar Expanded	X	Decoder Signature	—
Codabar	X	GS1 DataBar Limited	X	TLC 39	O
Code 11	O	GS1 Datamatrix	O	Trioptic 39	O
Code 128	X	GS1 QRCode	—	UK Postal	O
Code 39	X	HAN XIN	O	UPCA	X
Code 93	O	Interleaved 2 of 5	X	UPCE0	X
Composite AB	O	Japanese Postal	O	UPCE1	O
Composite C	O	Korean 3 of 5	O	US4state	—
Discrete 2 of 5	O	MAIL MARK	O	US4state FICS	—
Datamatrix	X	Matrix 2 of 5	O	US Planet	O
Dutch Postal	—	Maxicode	O	US Postnet	O
DotCode	O	MicroPDF	O		
EAN13	X	MicroQR	X		

Key: X = Enabled, O = Disabled, - = Not Supported

SE4710 Internal Imager Supported Decoders

Lists the supported decoders for the SE4710 internal imager.

Table 14 Internal Imager SE4710 Supported Decoders

Decoder	Default State	Decoder	Default State	Decoder	Default State
Australian Postal	O	EAN8	X	MSI	O
Aztec	X	Grid Matrix	O	PDF417	X
Canadian Postal	O	GS1 DataBar	X	QR Code	X
Chinese 2 of 5	O	GS1 DataBar Expanded	X	Decoder Signature	O
Codabar	X	GS1 DataBar Limited	O	TLC 39	O
Code 11	O	GS1 Datamatrix	O	Trioptic 39	O
Code 128	X	GS1 QRCode	O	UK Postal	O
Code 39	X	HAN XIN	O	UPCA	X
Code 93	O	Interleaved 2 of 5	O	UPCE0	X
Composite AB	O	Japanese Postal	O	UPCE1	O
Composite C	O	Korean 3 of 5	O	US4state	O
Discrete 2 of 5	O	MAIL MARK	X	US4state FICS	O
Datamatrix	X	Matrix 2 of 5	O	US Planet	O
Dutch Postal	O	Maxicode	X	US Postnet	O
DotCode	O	MicroPDF	O		
EAN13	X	MicroQR	O		

Key: X = Enabled, O = Disabled, - = Not Supported

SE4720 Internal Imager Supported Decoders

Lists the supported decoders for the SE4720 internal imager.

Table 15 SE4720 Internal Imager Supported Decoders

Decoder	Default State	Decoder	Default State	Decoder	Default State
Australian Postal	O	EAN8	X	MSI	O
Aztec	X	Grid Matrix	O	PDF417	X
Canadian Postal	O	GS1 DataBar	X	QR Code	X

Table 15 SE4720 Internal Imager Supported Decoders (Continued)

Decoder	Default State	Decoder	Default State	Decoder	Default State
Chinese 2 of 5	O	GS1 DataBar Expanded	X	Decoder Signature	O
Codabar	X	GS1 DataBar Limited	O	TLC 39	O
Code 11	O	GS1 Datamatrix	O	Trioptic 39	O
Code 128	X	GS1 QRCode	O	UK Postal	O
Code 39	X	HAN XIN	O	UPCA	X
Code 93	O	Interleaved 2 of 5	O	UPCE0	X
Composite AB	O	Japanese Postal	O	UPCE1	O
Composite C	O	Korean 3 of 5	O	US4state	O
Discrete 2 of 5	O	MAIL MARK	X	US4state FICS	O
Datamatrix	X	Matrix 2 of 5	O	US Planet	O
Dutch Postal	O	Maxicode	X	US Postnet	O
DotCode	O	MicroPDF	O		
EAN13	X	MicroQR	O		

Key: X = Enabled, O = Disabled, - = Not Supported

SE55 Internal Imager Supported Decoders

Lists the supported decoders for the SE55 internal imager.

Table 16 SE55 Internal Imager Supported Decoders

Decoder	Default State	Decoder	Default State	Decoder	Default State
Australian Postal	O	EAN8	X	MSI	O
Aztec	X	Grid Matrix	O	PDF417	X
Canadian Postal	O	GS1 DataBar	X	QR Code	X
Chinese 2 of 5	O	GS1 DataBar Expanded	X	Decoder Signature	O
Codabar	X	GS1 DataBar Limited	O	TLC 39	O
Code 11	O	GS1 Datamatrix	O	Trioptic 39	O
Code 128	X	GS1 QRCode	O	UK Postal	O
Code 39	X	HAN XIN	O	UPCA	X

Table 16 SE55 Internal Imager Supported Decoders (Continued)

Decoder	Default State	Decoder	Default State	Decoder	Default State
Code 93	O	Interleaved 2 of 5	O	UPCE0	X
Composite AB	O	Japanese Postal	O	UPCE1	O
Composite C	O	Korean 3 of 5	O	US4state	O
Discrete 2 of 5	O	MAIL MARK	X	US4state FICS	O
Datamatrix	X	Matrix 2 of 5	O	US Planet	O
Dutch Postal	O	Maxicode	X	US Postnet	O
DotCode	O	MicroPDF	O		
EAN13	X	MicroQR	O		

RS507/RS507x Supported Decoders

Lists the supported decoders for the RS507/RS507x Ring Scanner.

Table 17 RS507/RS507x Supported Decoders

Decoder	Default State	Decoder	Default State	Decoder	Default State
Australian Postal	O	EAN8	X	MSI	O
Aztec	X	Grid Matrix	O	PDF417	X
Canadian Postal	-	GS1 DataBar	X	QR Code	X
Chinese 2 of 5	O	GS1 DataBar Expanded	X	Decoder Signature	O
Codabar	X	GS1 DataBar Limited	O	TLC 39	O
Code 11	O	GS1 Datamatrix	-	Trioptic 39	O
Code 128	X	GS1 QRCode	-	UK Postal	O
Code 39	O	HAN XIN	-	UPCA	X
Code 93	O	Interleaved 2 of 5	O	UPCE0	X
Composite AB	O	Japanese Postal	O	UPCE1	O
Composite C	O	Korean 3 of 5	O	US4state	O
Discrete 2 of 5	O	MAIL MARK	-	US4state FICS	O
Datamatrix	X	Matrix 2 of 5	O	US Planet	O
Dutch Postal	O	Maxicode	X	US Postnet	O
DotCode	O	MicroPDF	O		

Table 17 RS507/RS507x Supported Decoders (Continued)

Decoder	Default State	Decoder	Default State	Decoder	Default State
EAN13	X	MicroQR	O		

Key: X = Enabled, O = Disabled, - = Not Supported

RS5100 Supported Decoders

Lists the supported decoders for the RS5100 Ring Scanner.

Table 18 RS5100 Supported Decoders

Decoder	Default State	Decoder	Default State	Decoder	Default State
Australian Postal	O	EAN8	X	MSI	O
Aztec	X	Grid Matrix	O	PDF417	X
Canadian Postal	O	GS1 DataBar	X	QR Code	X
Chinese 2 of 5	O	GS1 DataBar Expanded	X	Decoder Signature	O
Codabar	X	GS1 DataBar Limited	O	TLC 39	O
Code 11	O	GS1 Datamatrix	O	Trioptic 39	O
Code 128	X	GS1 QRCode	O	UK Postal	O
Code 39	X	HAN XIN	O	UPCA	X
Code 93	O	Interleaved 2 of 5	O	UPCE0	X
Composite AB	O	Japanese Postal	O	UPCE1	O
Composite C	O	Korean 3 of 5	O	US4state	O
Discrete 2 of 5	O	MAIL MARK	X	US4state FICS	O
Datamatrix	X	Matrix 2 of 5	O	US Planet	O
Dutch Postal	O	Maxicode	X	US Postnet	O
DotCode	O	MicroPDF	O		
EAN13	X	MicroQR	O		

Key: X = Enabled, O = Disabled, - = Not Supported

RS6000 Supported Decoders

Lists the supported decoders for the RS6000 Ring Scanner.

Table 19 RS6000 Supported Decoders

Decoder	Default State	Decoder	Default State	Decoder	Default State
Australian Postal	O	EAN8	X	MSI	O
Aztec	X	Grid Matrix	O	PDF417	X
Canadian Postal	O	GS1 DataBar	X	QR Code	X
Chinese 2 of 5	O	GS1 DataBar Expanded	X	Decoder Signature	O
Codabar	X	GS1 DataBar Limited	O	TLC 39	O
Code 11	O	GS1 Datamatrix	O	Trioptic 39	O
Code 128	X	GS1 QRCode	O	UK Postal	O
Code 39	X	HAN XIN	O	UPCA	X
Code 93	O	Interleaved 2 of 5	O	UPCE0	X
Composite AB	O	Japanese Postal	O	UPCE1	O
Composite C	O	Korean 3 of 5	O	US4state	O
Discrete 2 of 5	O	MAIL MARK	X	US4state FICS	O
Datamatrix	X	Matrix 2 of 5	O	US Planet	O
Dutch Postal	O	Maxicode	X	US Postnet	O
DotCode	O	MicroPDF	O		
EAN13	X	MicroQR	O		

Key: X = Enabled, O = Disabled, - = Not Supported

DS2278 Supported Decoders

Lists the supported decoders for the DS2278 Digital Scanner.

Table 20 DS2278 Digital Scanner Supported Decoders

Decoder	Default State	Decoder	Default State	Decoder	Default State
Australian Postal	O	EAN8	X	MSI	O
Aztec	X	Grid Matrix	O	PDF417	X
Canadian Postal	—	GS1 DataBar	X	QR Code	X
Chinese 2 of 5	O	GS1 DataBar Expanded	X	Decoder Signature	O
Codabar	X	GS1 DataBar Limited	O	TLC 39	O

Table 20 DS2278 Digital Scanner Supported Decoders (Continued)

Decoder	Default State	Decoder	Default State	Decoder	Default State
Code 11	O	GS1 Datamatrix	O	Trioptic 39	O
Code 128	X	GS1 QRCode	O	UK Postal	O
Code 39	X	HAN XIN	—	UPCA	X
Code 93	O	Interleaved 2 of 5	O	UPCE0	X
Composite AB	O	Japanese Postal	O	UPCE1	O
Composite C	O	Korean 3 of 5	O	US4state	O
Discrete 2 of 5	O	MAIL MARK	X	US4state FICS	O
Datamatrix	X	Matrix 2 of 5	O	US Planet	O
Dutch Postal	O	Maxicode	X	US Postnet	O
DotCode	O	MicroPDF	O		
EAN13	X	MicroQR	O		

Key: X = Enabled, O = Disabled, — = Not Supported

DS3678 Supported Decoders

Lists the supported decoders for the DS3678 scanner.

Table 21 DS3678 Supported Decoders

Decoder	Default State	Decoder	Default State	Decoder	Default State
Australian Postal	O	EAN8	X	MSI	O
Aztec	X	Grid Matrix	O	PDF417	X
Canadian Postal	—	GS1 DataBar	X	QR Code	X
Chinese 2 of 5	O	GS1 DataBar Expanded	X	Decoder Signature	—
Codabar	X	GS1 DataBar Limited	O	TLC 39	O
Code 11	O	GS1 Datamatrix	O	Trioptic 39	O
Code 128	X	GS1 QRCode	O	UK Postal	O
Code 39	X	HAN XIN	O	UPCA	X
Code 93	O	Interleaved 2 of 5	O	UPCE0	X
Composite AB	O	Japanese Postal	O	UPCE1	O
Composite C	O	Korean 3 of 5	O	US4state	O

Table 21 DS3678 Supported Decoders (Continued)

Decoder	Default State	Decoder	Default State	Decoder	Default State
Discrete 2 of 5	O	MAIL MARK	X	US4state FICS	O
Datamatrix	X	Matrix 2 of 5	O	US Planet	O
Dutch Postal	O	Maxicode	X	US Postnet	O
DotCode	O	MicroPDF	O		
EAN13	X	MicroQR	O		

Key: X = Enabled, O = Disabled, — = Not Supported

DS8178 Supported Decoders

Lists the supported decoders for the DS8178 Digital scanner.

Table 22 DS8178 Digital Scanner Supported Decoders

Decoder	Default State	Decoder	Default State	Decoder	Default State
Australian Postal	O	EAN8	X	MSI	O
Aztec	X	Grid Matrix	O	PDF417	X
Canadian Postal	—	GS1 DataBar	X	QR Code	X
Chinese 2 of 5	O	GS1 DataBar Expanded	X	Decoder Signature	—
Codabar	X	GS1 DataBar Limited	O	TLC 39	O
Code 11	O	GS1 Datamatrix	O	Trioptic 39	O
Code 128	X	GS1 QRCode	O	UK Postal	O
Code 39	X	HAN XIN	—	UPCA	X
Code 93	O	Interleaved 2 of 5	O	UPCE0	X
Composite AB	O	Japanese Postal	O	UPCE1	O
Composite C	O	Korean 3 of 5	O	US4state	O
Discrete 2 of 5	O	MAIL MARK	X	US4state FICS	O
Datamatrix	X	Matrix 2 of 5	O	US Planet	O
Dutch Postal	O	Maxicode	X	US Postnet	O
DotCode	O	MicroPDF	O		
EAN13	X	MicroQR	O		

Key: X = Enabled, O = Disabled, — = Not Supported

LI3678 Supported Decoders

Lists the supported decoders for the LI3678 scanner.

Table 23 LI3678 Supported Decoders

Decoder	Default State	Decoder	Default State	Decoder	Default State
Australian Postal	—	EAN8	X	MSI	O
Aztec	—	Grid Matrix	O	PDF417	—
Canadian Postal	—	GS1 DataBar	X	QR Code	—
Chinese 2 of 5	O	GS1 DataBar Expanded	X	Decoder Signature	—
Codabar	X	GS1 DataBar Limited	O	TLC 39	O
Code 11	O	GS1 Datamatrix	—	Trioptic 39	O
Code 128	X	GS1 QRCode	—	UK Postal	—
Code 39	X	HAN XIN	O	UPCA	X
Code 93	O	Interleaved 2 of 5	O	UPCE0	X
Composite AB	—	Japanese Postal	—	UPCE1	O
Composite C	—	Korean 3 of 5	O	US4state	—
Discrete 2 of 5	O	MAIL MARK	—	US4state FICS	—
Datamatrix	—	Matrix 2 of 5	O	US Planet	—
Dutch Postal	—	Maxicode	—	US Postnet	—
DotCode	O	MicroPDF	—		
EAN13	X	MicroQR	—		

Key: X = Enabled, O = Disabled, — = Not Supported

Wireless

This section provides information on the wireless features of the device.

Wireless Wide Area Networks

Use Wireless wide area networks (WWANs) to access data over a cellular network.



NOTE: ET45 only.

This section provides information on:

- Sharing a data connection
- Monitoring data usage
- Changing Cellular Network settings

Sharing the Mobile Data Connection

The **Tethering & Portable Hotspot** settings allow sharing the mobile data connection with a single computer via USB tethering or Bluetooth tethering.

Share the data connection with up to eight devices at once, by turning it into a portable Wi-Fi hotspot. While the device is sharing its data connection, an icon displays at the top of the screen and a corresponding message appears in the notification list.

Enabling USB Tethering



NOTE: USB tethering is not supported on computers running Mac OS. If the computer is running Windows or a recent version of Linux (such as Ubuntu), follow these instructions without any special preparation. If running a version of Windows that precedes Windows 7, or some other operating system, you may need to prepare the computer to establish a network connection via USB.

1. Connect the device to a host computer with a USB cable.

The notification **Charging this device via USB** appears in the Notifications panel.

2. Go to **Settings**.
3. Touch **Network & Internet**.
4. Touch **Hotspot & tethering**.

5. Touch the **USB tethering** switch to enable.

The host computer is now sharing the device's data connection.

To stop sharing the data connection, touch the **USB tethering** switch again or disconnect the USB cable.

Enabling Bluetooth Tethering

Use Bluetooth tethering to share the data connection with a host computer.

Configure the host computer to obtain its network connection using Bluetooth. For more information, see the host computer's documentation.

1. Pair the device with the host computer.
2. Go to **Settings**.
3. Touch **Networking & Internet**.
4. Touch **Hotspot & tethering**.
5. Touch the **Bluetooth tethering** switch to enable.

The host computer is now sharing the device's data connection.

To stop sharing the data connection, touch the **Bluetooth tethering** switch again.

Enabling Wi-Fi Hotspot

1. Go to **Settings**.
2. Touch **Networking & Internet**.
3. Touch **Hotspot & tethering**.
4. Touch **Wi-Fi hotspot**.
5. Toggle the switch to enable.

After a moment, the device starts broadcasting its Wi-Fi network name (SSID). Connect to it with up to eight computers or other devices. The Hotspot  icon appears in the Status bar.

To stop sharing the data connection, touch the toggle switch again.

Configuring the Wi-Fi Hotspot

1. Go to **Settings**.
2. Touch **Networking & Internet**.
3. Touch **Hotspot & tethering**.
4. Touch **Wi-Fi hotspot**.
5. In the **Hotspot** name text field, edit the name for the hotspot.

6. Touch **Security** and select a security method from the drop-down list.
 - **WPA3-Personal**
 - a. Touch **Hotspot password**.
 - b. Enter a password.
 - c. Touch **OK**.
 - **WPA2-Personal**
 - a. Touch **Hotspot password**.
 - b. Enter a password.
 - c. Touch **OK**.
 - **None** - If **None** is selected in the Security option, a password is not required.
7. Touch **Advanced**.
8. In the **AP Band** drop-down list, select **2.4 GHz Band** or **5.0 GHz Band**.
9. If desired, touch **Turn off hotspot automatically** to turn off Wi-Fi Hotspot when no devices are connected.

Data Usage

Data usage refers to the amount of data uploaded or downloaded by the device during a given period. Depending on the wireless plan, you may be charged additional fees when your data usage exceeds your plan's limit.

Data usage settings allow:

- Enable Data Saver.
- Set the data usage warning level.
- Set a data usage limit.
- View or restrict data usage by app.
- Identify mobile hotspots and restrict background downloads that may result in extra charges.

Setting Data Usage Warning

Set a warning alert when the device has used a certain amount of mobile data.

1. Go to **Settings**.
2. Touch **Network & internet > Mobile network > Data warning & limit**.
3. If necessary, touch **Set data warning** to enable it.
4. Touch **Data warning**.
5. Enter a number.

To switch between megabytes (MB) and gigabytes (GB), touch the down arrow.
6. Touch **SET**.

When the data usage reaches the set level, a notification appears.

Setting Data Limit

1. Go to **Settings**.
2. Touch **Network & internet > Mobile network > Data warning & limit**.
3. Touch **Set data limit**.
4. Touch **OK**.
5. Touch **Data limit**.
6. Enter a number.
To switch between megabytes (MB) and gigabytes (GB), touch the down arrow.
7. Touch **Set**.

When the limit is reached, data automatically turns off and a notification appears.

Cellular Network Settings

Cellular network settings applies to WWAN devices only.

Data When Roaming

Roaming is disabled by default to prevent the device from transmitting data over other carriers' mobile networks when leaving an area that is covered by the carrier's networks. This is useful for controlling expenses if the service plan does not include data roaming.

Enabling MMS Messages

When mobile data is disabled, this feature allows you to send and receive MMS messages using Wi-Fi. This option only displays when mobile data is disabled.

1. Go to **Settings**.
2. Touch **Network & Internet > Mobile network > Mobile data**.
3. Touch **MMS messages**.
4. If desired, touch **Mobile data** to turn mobile data back on.

You can now send and receive MMS messages using Wi-Fi whenever mobile data is disabled.

Setting Preferred Network Type

Change the network operating mode.

1. Go to **Settings**.
2. Touch **Network & Internet > Mobile network > Preferred network type**.
3. In the **Preferred network type** dialog box, select a mode to set as default.
 - Automatic(NLW)
 - NR 5G only
 - LTE only
 - 3G only

Setting Preferred Network

Change the network operating mode.

1. Go to **Settings**.
2. Touch **Network & Internet > Mobile network > Advanced**.
3. Touch **Automatically select network**.
4. Touch **Network**.
5. In the **Available network** list, select a carrier network.

Configuring the Access Point Name

To use the data on a network, configure the APN information.



NOTE: Many service provider Access Point Name (APN) data are pre-configured in the device. The APN information for all other service providers must be obtained from the wireless service provider.

1. Go to **Settings**.
2. Touch **Network & Internet > Mobile network > Advanced**.
3. Touch **Access Point Names**.
4. Touch an APN name in the list to edit an existing APN or touch + to create a new APN.
5. Touch each APN setting and enter the appropriate data obtained from the wireless service provider.
6. When finished, touch **⋮ > Save**.
7. Touch the radio button next to the APN name to start using it.

Locking the SIM Card

Locking the SIM card requires the user to enter a PIN every time the device is turned on. If the correct PIN is not entered, only emergency calls can be made.

1. Go to **Settings**.
2. Touch **Security > SIM card lock**.
3. Touch **Lock SIM card**.
4. Enter the PIN associated with the card.
5. Touch **OK**.
6. Reset the device.

Wireless Local Area Network

Wireless local area networks (WLANs) allow the device to communicate wirelessly inside a building. Before using the device on a WLAN, the facility must be set up with the required hardware to run the WLAN (sometimes known as infrastructure). The infrastructure and the device must both be properly configured to enable this communication.



NOTE: To extend the life of the battery, turn off Wi-Fi when not in use.

Refer to the documentation provided with the infrastructure (access points (APs), access ports, switches, Radius servers, etc.) for instructions on how to set up the infrastructure.

Once the infrastructure is set up to enforce the chosen WLAN security scheme, use the **Wireless & networks** settings to configure the device to match the security scheme.

The device supports the following WLAN security options:

- None
- Enhanced Open
- Wireless Equivalent Privacy (WEP)
- Wi-Fi Protected Access (WPA)/WPA2 Personal (PSK)
- WPA3-Personal
- WPA/WPA2/WPA3 Enterprise (EAP)
 - Protected Extensible Authentication Protocol (PEAP) - with MSCHAPV2 and GTC authentication.
 - Transport Layer Security (TLS)
 - Tunneled Transport Layer Security (TTLS) - with Password Authentication Protocol (PAP), MSCHAP and MSCHAPv2 authentication.
 - Password (PWD).
 - Extensible Authentication Protocol Method for Subscriber Identity Module (SIM)
 - Extensible Authentication Protocol Method for Authentication and Key Agreement (AKA)
 - Improved Extensible Authentication Protocol Method for Authentication and Key Agreement (AKA')
 - Lightweight Extensible Authentication Protocol (LEAP).
- WPA3-Enterprise 192-bit

The **Status** bar displays icons that indicate Wi-Fi network availability and Wi-Fi status.

Connecting to a Wi-Fi Network

1. Go to **Settings**.
2. Touch **Network & internet**.
3. Touch **Wi-Fi** to open the **Wi-Fi** screen. The device searches for WLANs in the area and lists them.
4. Scroll through the list and select the desired WLAN network.
5. For open networks, touch profile once or press and hold and then select **Connect** or for secure networks enter the required password or other credentials then touch **Connect**. See the system administrator for more information.

The device obtains a network address and other required information from the network using the dynamic host configuration protocol (DHCP) protocol. To configure the device with a fixed internet protocol (IP) address, see [Configuring the Device to Use a Static IP Address](#).

6. In the Wi-Fi setting field, **Connected** appears indicating that the device is connected to the WLAN.

Removing a Wi-Fi Network

Remove a remembered or connected Wi-Fi network.

1. Go to **Settings**.
2. Touch **Network & Internet > Wi-Fi**.
3. Scroll down to the bottom of the list and touch **Saved networks**.
4. Touch the name of the network.
5. Touch **FORGET**.

WLAN Configuration

This section provides information on configuring Wi-Fi settings.

Configuring a Secure Wi-Fi Network

1. Go to **Settings**.
2. Touch **Network & Internet > Wi-Fi**.
3. Slide the switch to the **ON** position.
4. The device searches for WLANs in the area and lists them on the screen.
5. Scroll through the list and select the desired WLAN network.
6. Touch the desired network. If network security is **Open**, the device automatically connects to the network. For all other network security, a dialog box appears.
7. If network security is **WPA/WPA2-Personal**, **WPA3-Personal**, or **WEP**, enter the required password and then touch **Connect**.
8. If network security is **WPA/WPA2/WPA3 Enterprise**:
 - a) Touch the **EAP method** drop-down list and select one of the following:
 - **PEAP**
 - **TLS**
 - **TTLS**
 - **PWD**
 - **SIM**
 - **AKA**
 - **AKA'**
 - **LEAP**
 - b) Fill in the appropriate information. Options vary depending on the **EAP method** chosen.
 - When selecting **CA certificate**, Certification Authority (CA) certificates are installed using the **Security** settings.
 - When using the EAP methods PEAP, TLS, or TTLS, specify a domain.
 - Touch **Advanced options** to display additional network options.

9. If the network security is **WPA3-Enterprise 192-bit**:
 - Touch **CA certificate** and select a Certification Authority (CA) certificate. Note: Certificates are installed using the Security settings.
 - Touch **User certificate** and select a user certificate. Note: User certificates are installed using the Security settings.
 - In the **Identity** text box, enter the username credentials.



NOTE: By default, the network Proxy is set to None and the IP settings is set to DHCP. See [Configuring for a Proxy Server](#) on page 93 for setting the connection to a proxy server and see [Configuring the Device to Use a Static IP Address](#) on page 94 for setting the device to use a static IP address.

10. Touch **Connect**.

Manually Adding a Wi-Fi Network

Manually add a Wi-Fi network if the network does not broadcast its name (SSID) or to add a Wi-Fi network when out of range.

1. Go to **Settings**.
2. Touch **Network & Internet > Wi-Fi**.
3. Slide the Wi-Fi switch to the **On** position.
4. Scroll to the bottom of the list and select **Add network**.
5. In the **Network name** text box, enter the name of the Wi-Fi network.
6. In the **Security** drop-down list, set the type of security to:
 - **None**
 - **Enhanced Open**
 - **WEP**
 - **WPA/WPA2-Personal**
 - **WPA3-Personal**
 - **WPA/WPA2/WPA3-Enterprise**
 - **WPA3-Enterprise 192-bit**
7. If the network security is **None** or **Enhanced Open**, touch **Save**.
8. If the network security is **None**, touch **Save**.
9. If the network security is **WEP**, **WPA3-Personal**, or **WPA/WPA2-Personal**, enter the required password and then touch **Save**.

10. If network security is **WPA/WPA2/WPA3 Enterprise**:
 - a) Touch the **EAP method** drop-down list and select one of the following:
 - **PEAP**
 - **TLS**
 - **TTLS**
 - **PWD**
 - **LEAP**
 - b) Fill in the appropriate information. Options vary depending on the **EAP method** chosen.
 - When selecting **CA certificate**, Certification Authority (CA) certificates are installed using the **Security** settings.
 - When using the EAP methods PEAP, TLS, or TTLS, specify a domain.
 - Touch **Advanced options** to display additional network options.
 11. If the network security is WPA3-Enterprise 192-bit:
 - Touch **CA certificate** and select a Certification Authority (CA) certificate. Note: Certificates are installed using the Security settings.
 - Touch **User certificate** and select a user certificate. Note: User certificates are installed using the Security settings.
 - In the **Identity** text box, enter the username credentials.
-  **NOTE:** By default, the network Proxy is set to None and the IP settings is set to DHCP. See [Configuring for a Proxy Server](#) on page 93 for setting the connection to a proxy server and see [Configuring the Device to Use a Static IP Address](#) on page 94 for setting the device to use a static IP address.
12. Touch **Save**. To connect to the saved network, touch and hold on the saved network and select **Connect to network**.

Configuring for a Proxy Server

A proxy server is a server that acts as an intermediary for requests from clients seeking resources from other servers. A client connects to the proxy server and requests some service, such as a file, connection, web page, or other resource, available from a different server. The proxy server evaluates the request according to its filtering rules. For example, it may filter traffic by IP address or protocol. If the request is validated by the filter, the proxy provides the resource by connecting to the relevant server and requesting the service on behalf of the client.

It is important for enterprise customers to be able to set up secure computing environments within their companies, making proxy configuration essential. Proxy configuration acts as a security barrier ensuring that the proxy server monitors all traffic between the Internet and the intranet. This is normally an integral part of security enforcement in corporate firewalls within intranets.

1. Go to **Settings**.
2. Touch **Network & Internet > Wi-Fi**.
3. Slide the Wi-Fi switch to the **On** position.
4. In the network dialog box, select and touch a network.

5. If configuring the connected network, touch  to edit the network details and then touch the down arrow to hide the keyboard.
6. Touch **Advanced options**.
7. Touch **Proxy** and select **Manual**.
8. In the **Proxy hostname** text box, enter the address of the proxy server.
9. In the **Proxy port** text box, enter the port number for the proxy server.
10. In the **Bypass proxy for** text box, enter addresses for web sites that are not required to go through the proxy server. Use a comma “,” between addresses. Do not use spaces or carriage returns between addresses.
11. If configuring the connected network, touch **Save** otherwise, touch **Connect**.
12. Touch **Connect**.

Configuring the Device to Use a Static IP Address

By default, the device is configured to use Dynamic Host Configuration Protocol (DHCP) to assign an Internet protocol (IP) address when connecting to a wireless network.

1. Go to **Settings**.
2. Touch **Network & Internet > Wi-Fi**.
3. Slide the Wi-Fi switch to the **On** position.
4. In the network dialog box, select and touch a network.
5. If configuring the connected network, touch  to edit the network details and then touch the down arrow to hide the keyboard.
6. Touch **Advanced options**.
7. Touch **IP settings** and select **Static**.
8. In the **IP address** text box, enter an IP address for the device.
9. If required, in the **Gateway** text box, enter a gateway address for the device.
10. If required, in the **Network prefix length** text box, enter the prefix length.
11. If required, in the **DNS 1** text box, enter a Domain Name System (DNS) address.
12. If required, in the **DNS 2** text box, enter a DNS address.
13. If configuring the connected network, touch **Save** otherwise, touch **Connect**.

Wi-Fi Preferences

Use the Wi-Fi preferences to configure advanced Wi-Fi settings. From the Wi-Fi screen scroll down to the bottom of the screen and touch Wi-Fi preferences.

- **Turn on Wi-Fi automatically** - When enabled, Wi-Fi automatically turns back on when near high-quality saved networks.
- **Notify for public networks** - When enabled, notifies the user when a high quality public network is available.

- **Advanced** - Touch to expand options.
 - **Additional settings** - See [Additional Wi-Fi Settings](#).
 - **Install Certificates** – Touch to install certificates.
 - **Network rating provider** - Disabled (AOSP devices). To help determine what constitutes a good Wi-Fi network, Android supports external Network rating providers that provide information about the quality of open Wi-Fi networks. Select one of the providers listed or **None**. If none are available or selected, the Connect to open networks feature is disabled.
 - **Wi-Fi Direct** - Displays a list of devices available for a direct Wi-Fi connection.

Additional Wi-Fi Settings

Use the Additional Settings to configure additional Wi-Fi settings. To view the additional Wi-Fi settings, scroll to the bottom of the Wi-Fi screen and touch **Wi-Fi Preferences > Advanced > Additional settings**.



NOTE: Additional Wi-Fi settings are for the device, not for a specific wireless network.

- **Regulatory**
 - **Country Selection** - Displays the acquired country code if 802.11d is enabled, else it displays the currently selected country code.
 - **Region code** - Displays the current region code.
- **Band and Channel Selection**
 - **Wi-Fi frequency band** - Set the frequency band to: **Auto** (default), **5 GHz only** or **2.4 GHz only**.
 - **Available channels (2.4 GHz)** - Touch to display the **Available channels** menu. Select specific channels and touch **OK**.
 - **Available channels (5 GHz)** - Touch to display the **Available channels** menu. Select specific channels and touch **OK**.
- **Logging**
 - **Advanced Logging** – Touch to enable advanced logging or change the log directory.
 - **Wireless logs** - Use to capture Wi-Fi log files.
 - **Fusion Logger** - Touch to open the **Fusion Logger** application. This application maintains a history of high level WLAN events which helps to understand the status of connectivity.
 - **Fusion Status** - Touch to display live status of WLAN state. Also provides information about the device and connected profile.
- **About**
 - **Version** - Displays the current version information. Touch the version to display additional version details.

Wi-Fi Direct

Wi-Fi Direct devices can connect to each other without having to go through an access point. Wi-Fi Direct devices establish their own ad-hoc network when required, letting you see which devices are available and choose which one you want to connect to.

1. Go to **Settings**.

2. Touch **Wi-Fi** > **Wi-Fi preferences** > **Advanced** > **Wi-Fi Direct**. The device begins searching for another Wi-Fi Direct device.
3. Under **Peer devices**, touch the other device name.
4. On the other device, select **Accept**.

Connected appears on the device. On both devices, in their respective Wi-Fi Direct screens, the other device name appears in the list.

Bluetooth

Bluetooth devices can communicate without wires, using frequency-hopping spread spectrum (FHSS) radio frequency (RF) to transmit and receive data in the 2.4 GHz Industry Scientific and Medical (ISM) band (802.15.1). Bluetooth wireless technology is specifically designed for short-range (10 m (32.8 ft)) communication and low power consumption.

Devices with Bluetooth capabilities can exchange information (for example, files, appointments, and tasks) with other Bluetooth enabled devices such as printers, access points, and other mobile devices.

The device supports Bluetooth Low Energy. Bluetooth Low Energy is targeted at applications in the healthcare, fitness, security, and home entertainment industries. It provides reduced power consumption and cost while maintaining standard Bluetooth range.

Adaptive Frequency Hopping

Adaptive Frequency Hopping (AFH) is a method of avoiding fixed frequency interferers, and can be used with Bluetooth voice. All devices in the piconet (Bluetooth network) must be AFH-capable in order for AFH to work. There is no AFH when connecting and discovering devices. Avoid making Bluetooth connections and discoveries during critical 802.11b communications.

AFH for Bluetooth consists of four main sections:

- Channel Classification - A method of detecting an interference on a channel-by-channel basis, or pre-defined channel mask.
- Link Management - Coordinates and distributes the AFH information to the rest of the Bluetooth network.
- Hop Sequence Modification - Avoids interference by selectively reducing the number of hopping channels.
- Channel Maintenance - A method for periodically re-evaluating the channels.

When AFH is enabled, the Bluetooth radio “hops around” (instead of through) the 802.11b high-rate channels. AFH coexistence allows enterprise devices to operate in any infrastructure.

The Bluetooth radio in this device operates as a Class 2 device power class. The maximum output power is 2.5 mW and the expected range is 10 m (32.8 ft). A definition of ranges based on power class is difficult to obtain due to power and device differences, and whether in open space or closed office space.

The Bluetooth radio in this device operates as a Class 1 device power class. The maximum output power is 7.5 mW and the expected range is 30 m (98.4 ft). A definition of ranges based on power class is difficult to obtain due to power and device differences, and whether in open space or closed office space.



NOTE: It is not recommended to perform Bluetooth wireless technology inquiry when high rate 802.11b operation is required.

Security

The current Bluetooth specification defines security at the link level. Application-level security is not specified. This allows application developers to define security mechanisms tailored to their specific need. Link-level security occurs between devices, not users, while application-level security can be implemented on a per-user basis. The Bluetooth specification defines security algorithms and procedures required to authenticate devices, and if needed, encrypt the data flowing on the link between the devices. Device authentication is a mandatory feature of Bluetooth while link encryption is optional.

Pairing of Bluetooth devices is accomplished by creating an initialization key used to authenticate the devices and create a link key for them. Entering a common personal identification number (PIN) in the devices being paired generates the initialization key. The PIN is never sent over the air. By default, the Bluetooth stack responds with no key when a key is requested (it is up to user to respond to the key request event). Authentication of Bluetooth devices is based-upon a challenge-response transaction. Bluetooth allows for a PIN or passkey used to create other 128-bit keys used for security and encryption. The encryption key is derived from the link key used to authenticate the pairing devices. Also worthy of note is the limited range and fast frequency hopping of the Bluetooth radios that makes long-distance eavesdropping difficult.

Recommendations are:

- Perform pairing in a secure environment
- Keep PIN codes private and do not store the PIN codes in the device
- Implement application-level security.

Bluetooth Profiles

The device supports the Bluetooth services listed.

Table 24 Bluetooth Profiles

Profile	Description
Service Discovery Protocol (SDP)	Handles the search for known and specific services as well as general services.
Serial Port Profile (SPP)	Allows use of RFCOMM protocol to emulate serial cable connection between two Bluetooth peer devices. For example, connecting the device to a printer.
Object Push Profile (OPP)	Allows the device to push and pull objects to and from a push server.
Advanced Audio Distribution Profile (A2DP)	Allows the device to stream stereo-quality audio to a wireless headset or wireless stereo speakers.
Audio/Video Remote Control Profile (AVRCP)	Allows the device to control A/V equipment to which a user has access. It may be used in concert with A2DP.
Personal Area Network (PAN)	Allows the use of Bluetooth Network Encapsulation Protocol to provide L3 networking capabilities over a Bluetooth link. Only PANU role is supported.
Human Interface Device Profile (HID)	Allows Bluetooth keyboards, pointing devices, gaming devices and remote monitoring devices to connect to the device.
Headset Profile (HSP)	Allows a hands-free device, such as a Bluetooth headset, to place and receive calls on the device.
Hands-Free Profile (HFP)	Allows car hands-free kits to communicate with the device in the car.

Table 24 Bluetooth Profiles (Continued)

Profile	Description
Phone Book Access Profile (PBAP)	Allows exchange of Phone Book Objects between a car kit and a mobile device to allow the car kit to display the name of the incoming caller; allow the car kit to download the phone book so you can initiate a call from the car display.
Generic Attribute Profile (GATT)	Provides profile discovery and description services for Bluetooth Low Energy protocol. It defines how attributes are grouped together into sets to form services.
HID Over GATT Profile (HOGP)	Defines the procedures and features used by Bluetooth low energy HID Devices using GATT and Bluetooth HID Hosts using GATT.
Dial Up Networking (DUN)	Provides a standard to access the Internet and other dial-up services over Bluetooth.
Generic Access Profile (GAP)	Use for device discovery and authentication.
OBject EXchange (OBEX)	Facilitates the exchange of binary objects between devices.

Bluetooth Power States

The Bluetooth radio is off by default.

- **Suspend** - When the device goes into Sleep mode, the Bluetooth radio stays on.
- **Airplane Mode** -
 - Android A10 OS version and previous versions - When the device is placed in Airplane Mode, the Bluetooth radio turns off. When Airplane mode is disabled, the Bluetooth radio returns to the prior state. When in Airplane Mode, the Bluetooth radio can be turned back on if desired.
 - Android A11 OS version and versions onward - When the device is placed in Airplane Mode, the Bluetooth radio is not turned off when the device is connected to a Bluetooth headset or hearing device.

Enabling Bluetooth

1. Swipe down from the Status bar to open the Notification panel.
2. Touch  to turn Bluetooth on.

Disabling Bluetooth

1. Swipe down from the Status bar to open the Notification panel.
2. Touch  to turn Bluetooth off.

Discovering Bluetooth Device(s)

The device can receive information from discovered devices without pairing. However, once paired, the device and a paired device exchange information automatically when the Bluetooth radio is on.

1. Ensure that Bluetooth is enabled on both devices.

2. Ensure that the Bluetooth device to discover is in discoverable mode.
3. Ensure that the two devices are within 10 meters (32.8 feet) of one another.
4. Swipe down from the Status bar to open the Quick Access panel.
5. Touch and hold **Bluetooth**.
6. Touch **Pair new device**. The device begins searching for discoverable Bluetooth devices in the area and displays them under **Available devices**.
7. Scroll through the list and select a device. The Bluetooth pairing request dialog box appears.
8. Touch **Pair** on both devices.
9. The Bluetooth device is added to the **Paired devices** list and a trusted (“paired”) connection is established.

Changing the Bluetooth Name

By default, the device has a generic Bluetooth name that is visible to other devices when connected.

1. Go to **Settings**.
2. Touch **Connected devices > Connection preferences > Bluetooth**.
3. If Bluetooth is not on, move the switch to turn Bluetooth on.
4. Touch **Device name**.
5. Enter a name and touch **RENAME**.

Connecting to a Bluetooth Device

Once paired, connect to a Bluetooth device.

1. Go to **Settings**.
2. Touch **Connected devices > Connection preferences > Bluetooth**.
3. In the list, touch the unconnected Bluetooth device.

When connected, **Connected** appears below the device name.

Selecting Profiles on the Bluetooth Device

Some Bluetooth devices have multiple profiles.

1. Go to **Settings**.
2. Touch **Connected devices > Connection preferences > Bluetooth**.
3. In the **Paired Devices** list, touch  next to the device name.
4. Turn on or off a profile to allow the device to use that profile.

Unpairing a Bluetooth Device

Unpairing a Bluetooth device erases all pairing information.

1. Go to **Settings**.
2. Touch **Connected devices > Connection preferences > Bluetooth**.

3. In the **Paired Devices** list, touch  next to the device name.
4. Touch **FORGET**.

Cast

Use **Cast** to mirror the device screen on a Miracast enabled wireless display.

1. Go to **Settings**.
2. Touch **Connected devices** > **Connection preferences** > **Cast**.
3. Touch  > **Enable wireless display**.
The device searches for nearby Miracast devices and lists them.
4. Touch a device to begin casting.

Near Field Communications

NFC/HF RFID is a short-range wireless connectivity technology standard that enables a secure transaction between a reader and a contactless smartcard.

The technology is based on ISO/IEC 14443 type A and B (proximity) ISO/IEC 15693 (vicinity) standards, using the HF 13.56 MHz unlicensed band.

The device supports the following operating modes:

- Reader mode
- Peer-to-Peer Communication
- Card Emulation mode.

Using NFC, the device can:

- Read contactless cards such as contactless tickets, ID cards and ePassport.
- Read and write information to contactless cards such as SmartPosters and tickets, as well as devices with NFC interface such as vending machines.
- Read information from supported medical sensors.
- Pair with supported Bluetooth devices such as printers, ring scanners (for example, RS6000), and headsets (for example, HS3100).
- Exchange data with another NFC device.
- Emulate a contactless card such as ticket.

The device NFC antenna is positioned to read NFC cards from the top of the device while the device is being held.

Reading NFC Cards

Read contactless cards using NFC.

1. Launch an NFC enabled application.
2. Hold device as shown.

3. Align the card with the NFC antenna (1) on the back of the device.

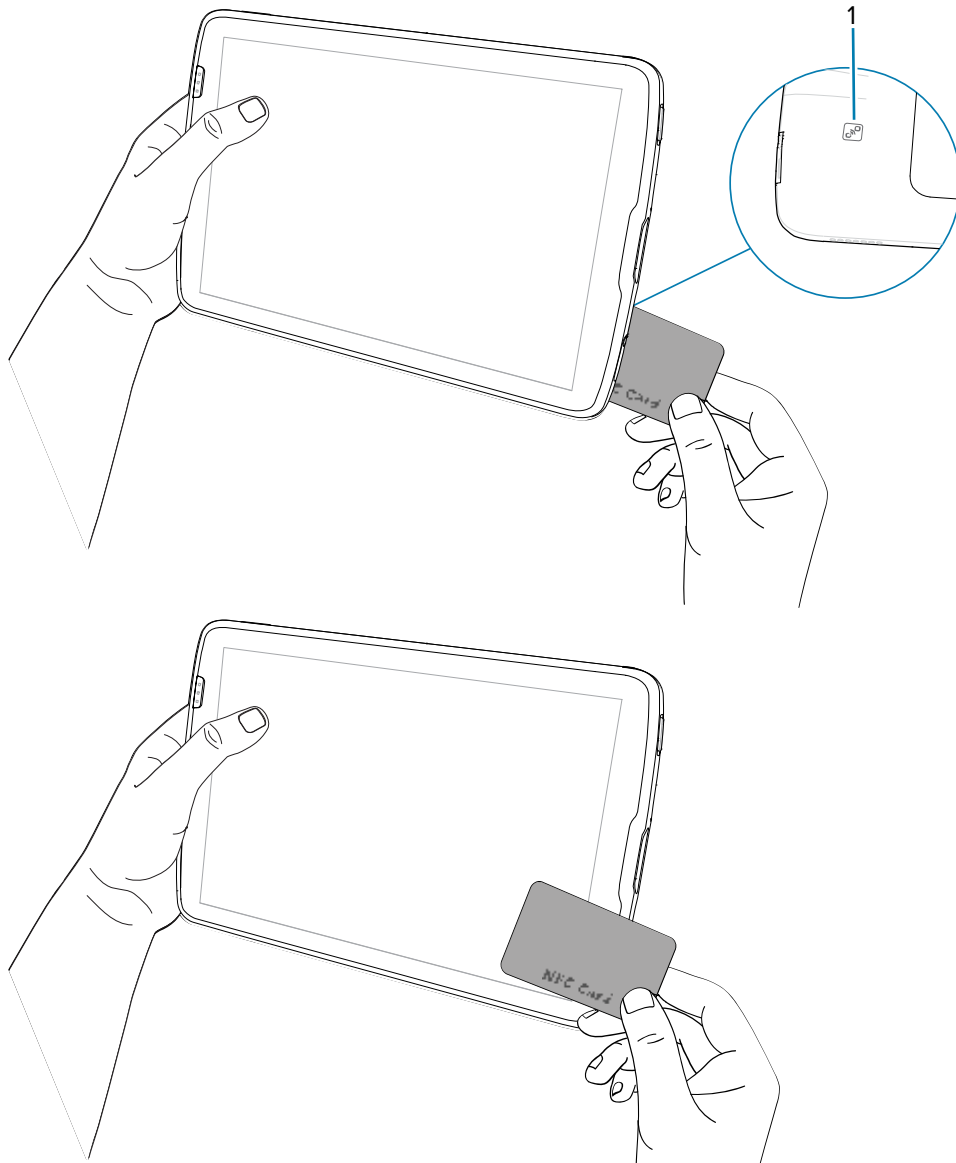

The tablet can read NFC cards from the front or back of the device.

4. Hold the card steadily until the transaction is complete (usually indicated by the application).

Enterprise NFC Settings

Improve NFC performance or increase battery life by selecting which NFC features to use on the device.

- **Card Detection Mode** - Select a card detection mode.
 - **Low** - Increases battery life by lowering the NFC detection speed.
 - **Hybrid** - Provides a balance between NFC detection speed and battery life (default).
 - **Standard** - Provides the optimal NFC detection speed, but reduces battery life.
- **Supported Card Technology** - Select an option to detect only one NFC tag type, increasing battery life, but reducing detection speed.
 - **ISO 14443 Type A**
 - **ISO 14443 Type B**
 - **FeliCa**
 - **ISO 15693**
- **NFC Debug Logging** - Use to enable or disable debug logging for NFC.
- **Other NFC settings available with Zebra administrator tools (CSP)** - Allows configuration of additional Enterprise NFC Settings through staging tools and Mobile Device Management (MDM) solutions with an MX version that supports the Enterprise NFC Settings Configuration Service Provider (CSP). For more information on using the Enterprise NFC Settings CSP, refer to: techdocs.zebra.com.

Accessories

The device accessories provide a variety of product support capabilities.

Accessories List

A comprehensive list of ET40/45 accessories, including descriptions and Zebra part numbers.

Cradles

1-Slot Charge Only Cradle

CRD-ET4X-1SCG1-01

Charges the main battery and optional Power Pack installed in the Expansion Back. Requires power supply PWRBGA12V50W0WW, DC line cord CBL-DC-388A1-01 and country-specific AC line cord.

4-Slot Charge Only Cradle

CRD-ET4X-4S8I1-01 (8" tablet)

CRD-ET4X-4S10I1-01 (10" tablet)

Charges up to four main batteries and optional Power Pack installed in the Expansion Back and up to four Power Packs in the optional 4-Slot Battery Charger. Requires power supply PWR-BGA12V108W0WW, DC line cord CBL-DC-388A1-01, and country-specific AC line cord.

Batteries and Chargers

Replacement Internal Battery

BTRY-ET4X-8IN1-01 (8" tablet)

BTRY-ET4X-10IN1-01 (10" tablet)

Replacement standard battery (single pack) tablet.

Power Pack

BTRY-ET5X-PRPK2-01

Additional power for charging the device battery using an Expansion Back.

4-Slot Battery Charger

SAC-ET5X-4PPK1-01

Chargers up to four Power Packs. Requires power supply PWR-BGA12V50W0WW, DC Line cord CBL-DC-388A1-01, and country-specific AC line cord.

Charge and Communication Cables

USB-C Communication and Charge Cable

CBL-TC5X-USBC2A-01

UBC-A to USB-C communication and power to the device.

Audio Accessories

USB-C to 3.5 mm Audio Adapter

ADP-USBC-35MM1-01

Plugs into the device and provides audio to a wired headset with collared 3.5 mm plug.

USB-C Headset

HDST-USBC-PTT1-01

Use for PTT and VoIP calls.

3.5 mm Headset

HDST-35MM-PTVP-01

Use for PTT and VoIP calls.

Carrying Solutions

Breakaway Shoulder Strap

SG-ET5X-SHDRSTP-01

Use with the rugged boot and D-clips to carry tablet on shoulder.

D Clips

SG-ET4X-DCLIPS-01

Replacement D-clips for use with the Breakaway Should Strap.

Healthcare Handstrap

SG-ET4X-HCHNDSTR1-01

Disinfectant ready hand strap. ET4X-HC Only.

Miscellaneous

Rugged Boot

SG-ET4X-8EXOSKL1-01 (8" tablet)

SG-ET4X-10EXOSKL1-01 (10" tablet)

Additional protection for the device.

Expansion Back (Power)

ZBK-ET4X-8BTRYBK1-01 (8" tablet)

ZBK-ET4X-10BTRYBK1-01 (10" tablet)

Rotating hand strap and slot for optional Power Pack.

Expansion Back (Payment)

ZBK-ET4X-8PAY2500I1-01 (Ingenico Link 2500i)

ZBK-ET4X-8PAYPD201-01 (PD20)

Rotating hand strap and slot for payment device. Only available for 8" tablets.

VESA Mount Adapter

ZBK-ET4X-10VESA-01 (10" standard tablet)

ZBK-ET4X-10HCVESA-01 (10" healthcare tablet)

Standard VESA mounting adapter for the device.

Stylus and Coiled Tether

SG-TC7X-STYLUS-03

Plastic stylus with coiled tether (3-pack).

Metal Stylus

SG-STYLUS-TCXMTL- 03

Stainless steel and brass stylus with micro-knit hybrid mesh fiber tip, especially for use in rain or snow (3- pack).

Coiled Stylus Tether

SG-ET5X-SLTETR-01

Secures a stylus to the rugged boot.

Power Supplies

Power Supply (108 W)

PWR-BGA12V108W0WW

Provides power to the 4-Slot Charge Only Cradle.

Power Supply (50 W)

PWR-BGA12V50W0WW

Provides power to the 1-Slot Charge Only Cradle and 4-Slot Battery Charger for Optional Battery Power Pack.

Power Supply (USB)

PWR-WUA5V12W0US

Provides 12 VDC, 2.5 A power to the USB cable. Includes plug adapter for use in the United States.

Power Supply (USB)

PWR-WUA5V12W0EU

Provides 12 VDC, 2.5 A power to the USB cable. Includes plug adapter for use in the European Union.

Power Supply (USB)

PWR-WUA5V12W0GB

Provides 12 VDC, 2.5 A power to the USB cable. Includes plug adapter for use in the United Kingdom.

Power Supply (USB)

PWR-WUA5V12W0AU

Provides 12 VDC, 2.5 A power to the USB cable. Includes plug adapter for use in the Australia.

Power Supply (USB)

PWR-WUA5V12W0CN

Provides 12 VDC, 2.5 A power to the USB cable. Includes plug adapter for use in the China.

Power Supply (USB)

PWR-WUA5V12W0IN

Provides 12 VDC, 2.5 A power to the USB cable. Includes plug adapter for use in the India.

Power Supply (USB)

PWR-WUA5V12W0KR

Provides 12 VDC, 2.5 A power to the USB cable. Includes plug adapter for use in the Korea.

Power Supply (USB)

PWR-WUA5V12W0BR

Provides 12 VDC, 2.5 A power to the USB cable. Includes plug adapter for use in the Brazil.

DC Line Cord

CBL-DC-381A1-01

Provides power from the power supply (PWR-BGA12V108W0WW) to the 4-Slot Charge Only Cradle.

DC Line Cord

CBL-DC-388A1-01

Provides power from the power supply (PWR-BGA12V50W0WW) to the 1-Slot Charge Only Cradle and 4-Slot Battery Charger.

US AC Line Cord

23844-00-00R

Provide power to power supplies.

Device Charging

Before using the tablet for the first time, connect it to an external power source. Keep the tablet connected to the external power source until fully charged. The Charging Indicator LED turns green when the tablet is fully charged. You may use the tablet while it is charging.

Charging Indicators

Charge the tablet's battery before using the tablet.

The 8 in. tablet battery charges from fully depleted to 80% in approximately 3 hours.

The 10 in. tablet battery charges from fully depleted to 80% in approximately 4 hours.



NOTE: The Charging indicator only illuminates when the device is connected to a power source.

Table 25 Charging Indicators

LED	Indication
Off	Device is not in cradle; not seated properly; or cradle is not powered.
Slow blinking orange (1 blink every 4 seconds)	Device is charging.
Slow blinking red (1 blink every 4 seconds)	Device is charging but the battery is at end of useful life.
Fast blinking orange (2 blinks/second)	Charging error. Possible charging errors include: <ul style="list-style-type: none"> • Temperature is too low or too high. • Charging has gone on too long without completion (typically eight hours).
Fast blinking red (2 blinks/second)	Charging error and the battery is at end of useful life. Possible charging errors include: <ul style="list-style-type: none"> • Temperature is too low or too high. • Charging has gone on too long without completion (typically eight hours).
Solid Green	Charging complete.
Solid Red	Charging complete but the battery is at end of useful life.

Charging Temperature

Charge batteries in ambient temperatures from 0°C to +40°C (32°F to 104°F) as reported by the battery. Charging is intelligently controlled by the charger. To accomplish this, for small periods of time, the charger alternately enables and disables battery charging to keep the battery at acceptable temperatures.

1-Slot Charge Only Cradle

Use a 1-Slot Charge Only cradle to charge one 8" or 10" tablet.



CAUTION: Ensure that you follow the guidelines for battery safety described in [Battery Safety Guidelines](#).

The 1-Slot Charge Only Cradle:

- Provides power for operating the device.
- Charges the device's battery and optional Power Pack installed in an Expansion Back.

Figure 22 1-Slot Charge Only Cradle - Front View

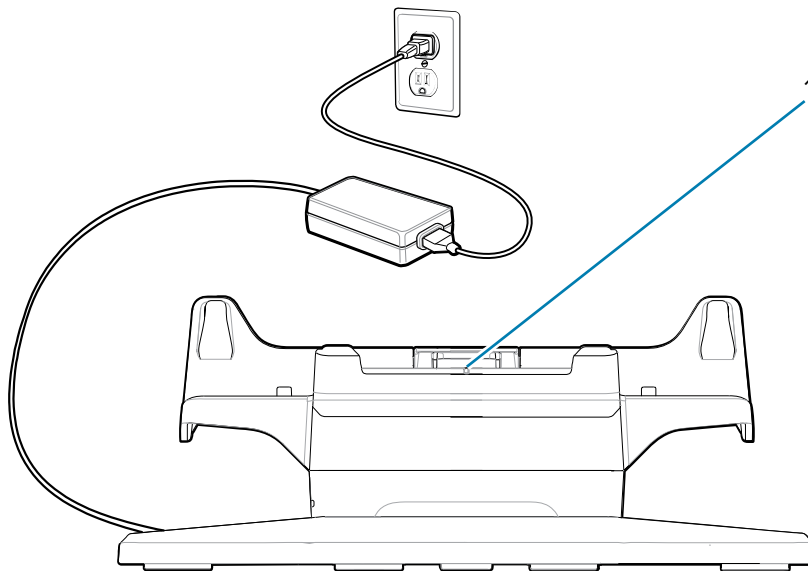

Number	Item	Description
1	Cradle alignment indicator	Use to assist in aligning the cradle with the tablet.

Figure 23 1-Slot Charge Only Cradle - Rear View

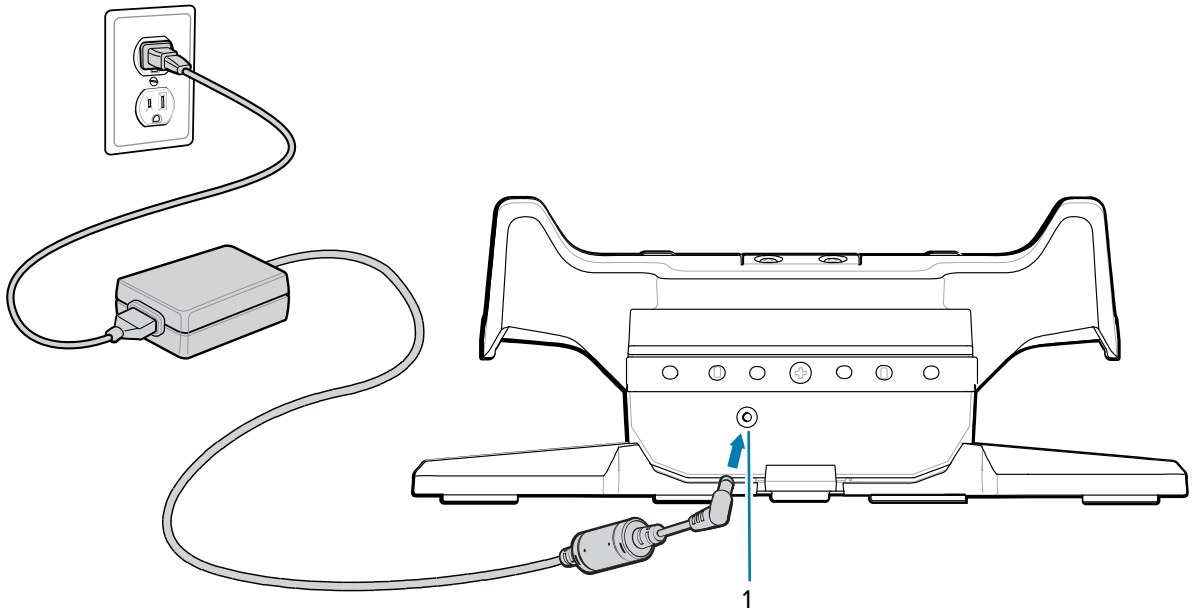

Number	Item	Description
1	AC power input	Use to connect AC power to the cradle.

Charging Using a 1-Slot Cradle

This section describes how to charge the device using an ET40/ET45 1-Slot Cradle.

1. Align the device with the alignment marks (1) on the cradle.

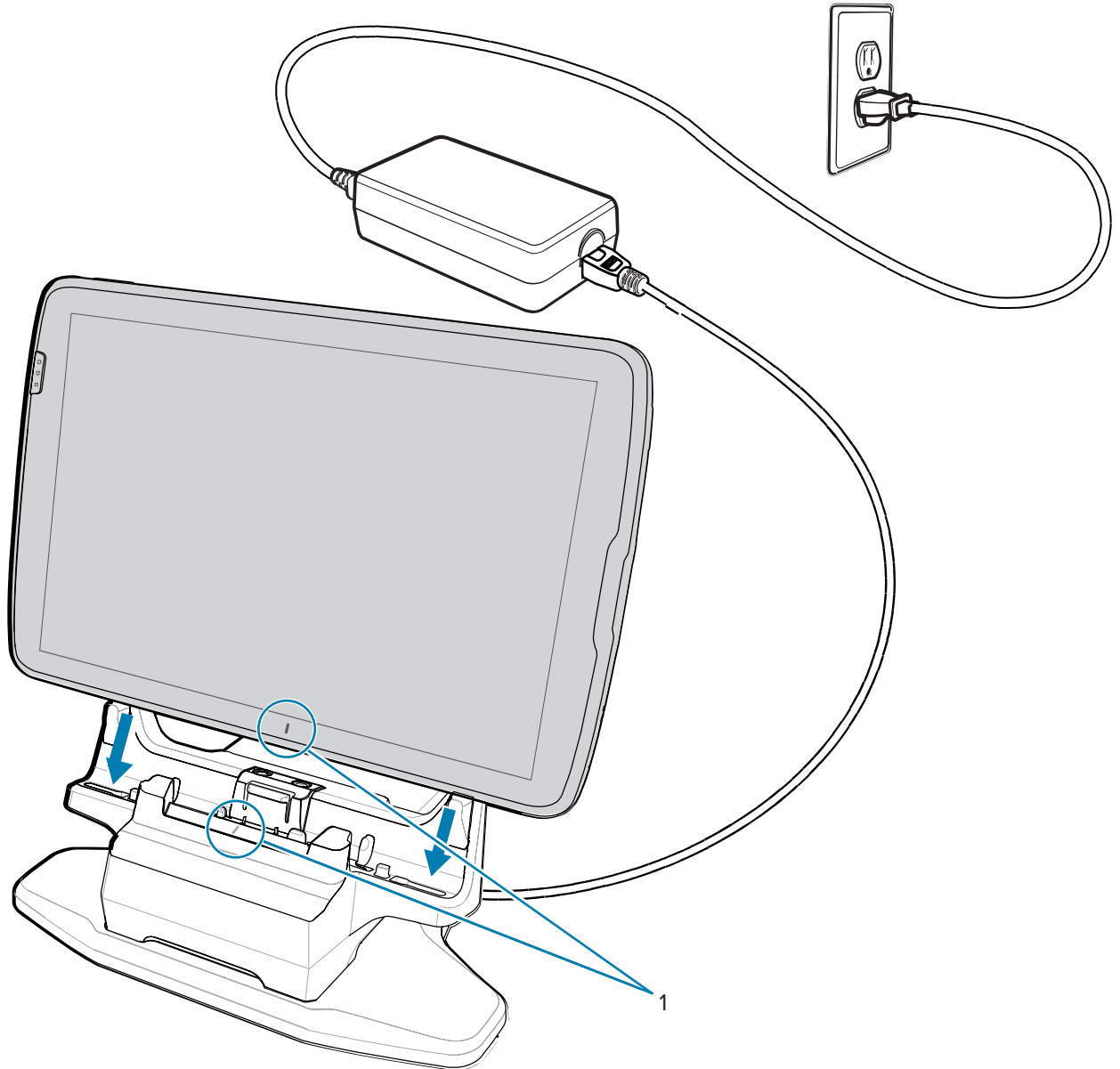

2. Insert the device into the cradle (1) and rotate it backwards (2) until it clicks.

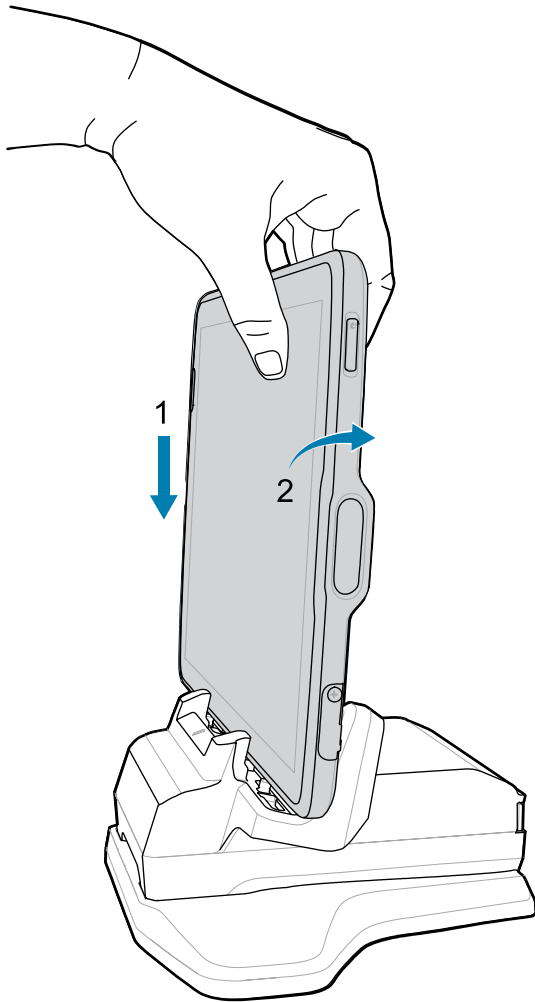

The device is locked in the cradle and the device Charging LED indicates charging.

3. To remove the device from the cradle, rotate the device forward slightly (1) and lift it out of the cradle (2).

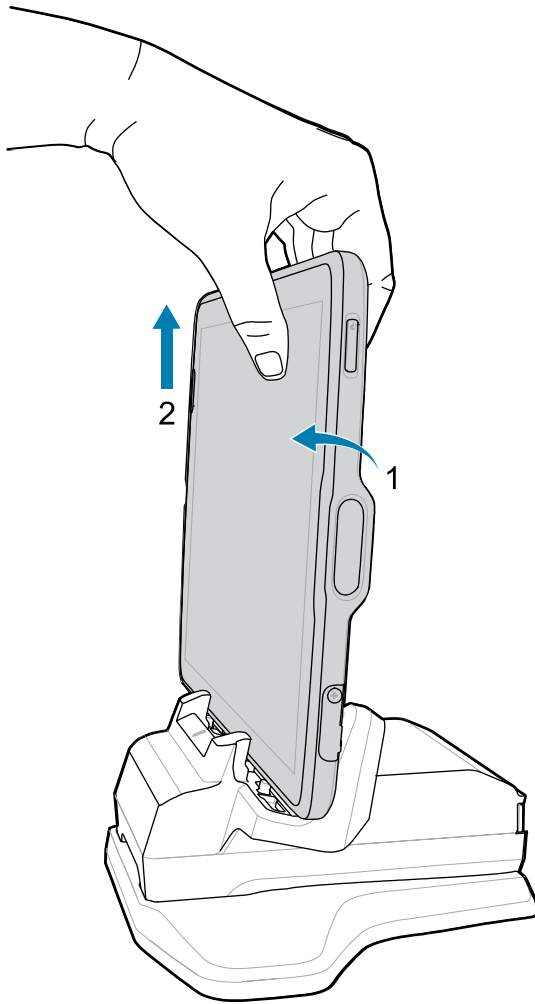

4-Slot Charge Only Cradle

Use the 4-Slot Charge Only Cradle to charge up to four 8" or 10" tablets and up to four Power Packs.



CAUTION: Ensure that you follow the guidelines for battery safety described in [Battery Safety Guidelines](#).

The 4-Slot Charge Only Cradle:

- Provides power for operating the device.
- Simultaneously charges up to four devices and up to four Power Packs using the optional Battery Charger Adapter.

Figure 24 4-Slot Charge Only Cradle - Front View

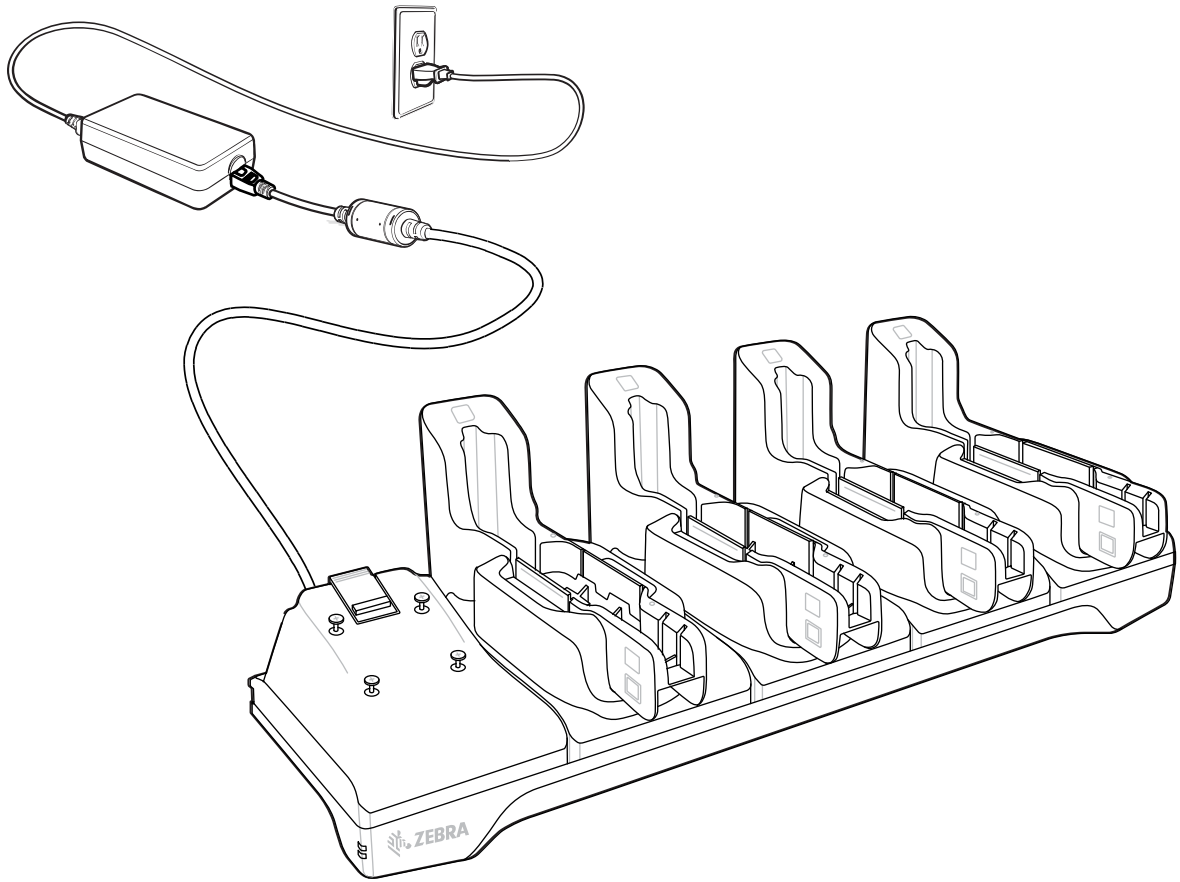
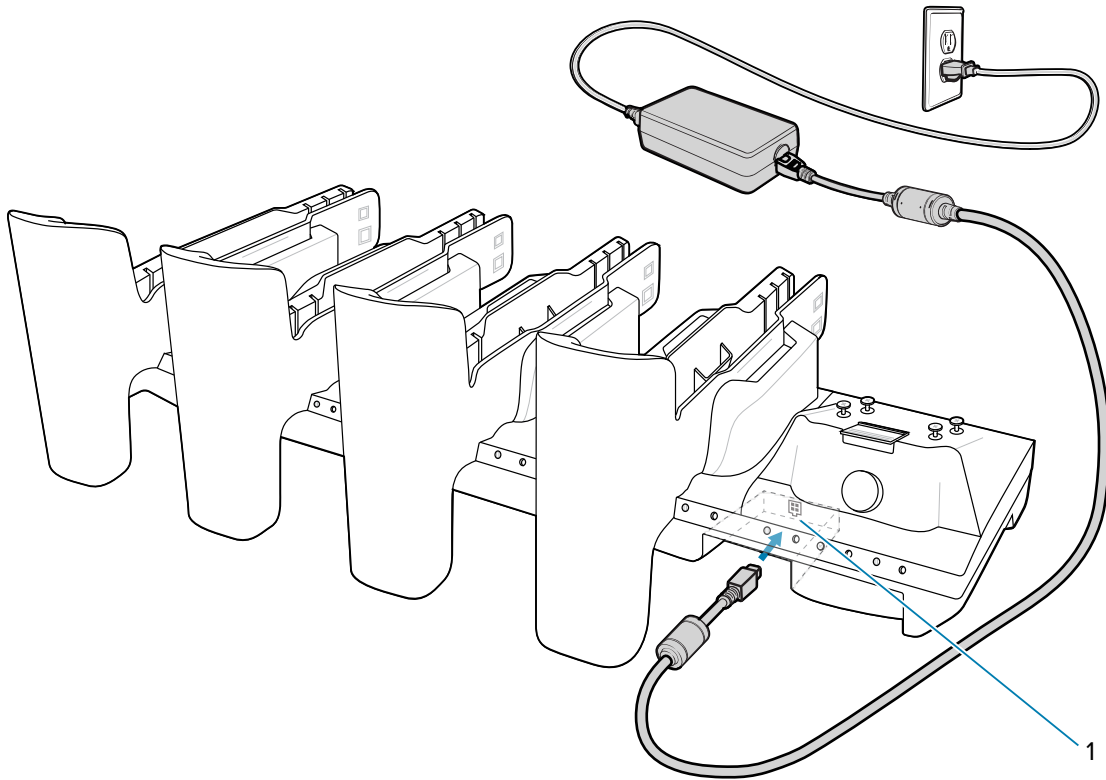

Figure 25 4-Slot Charge Only Cradle - Rear View





Number	Item	Description
1	Power input	Use to connect power to the cradle.

Installing the Insert

The 4-Slot Charge Only cradle comes with four inserts. The 8" cradle inserts are marked **S** and the 10" inserts are marked **L**. Each insert can be used with or without a rugged boot depending on how it is installed.

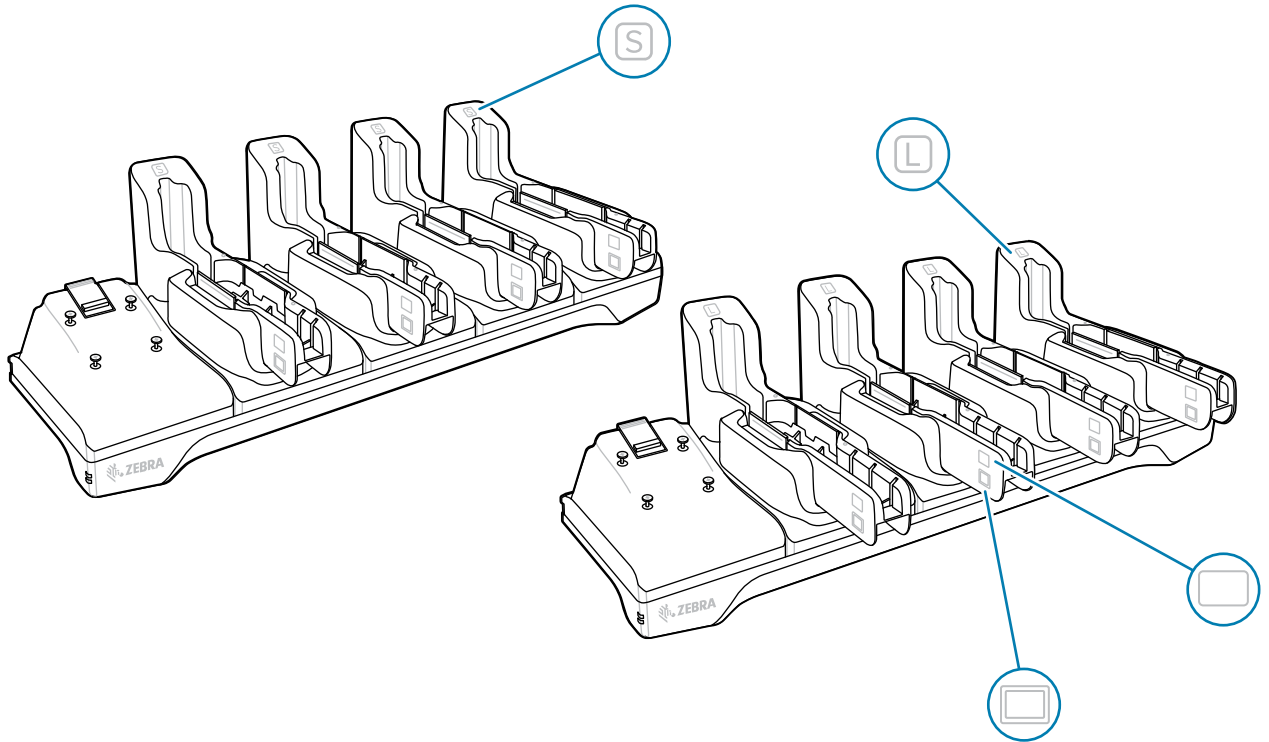
Figure 26 4-Slot Charge Only Cradles



1. To charge a tablet without the rugged boot, hold the insert so that the tablet icon  is on top.

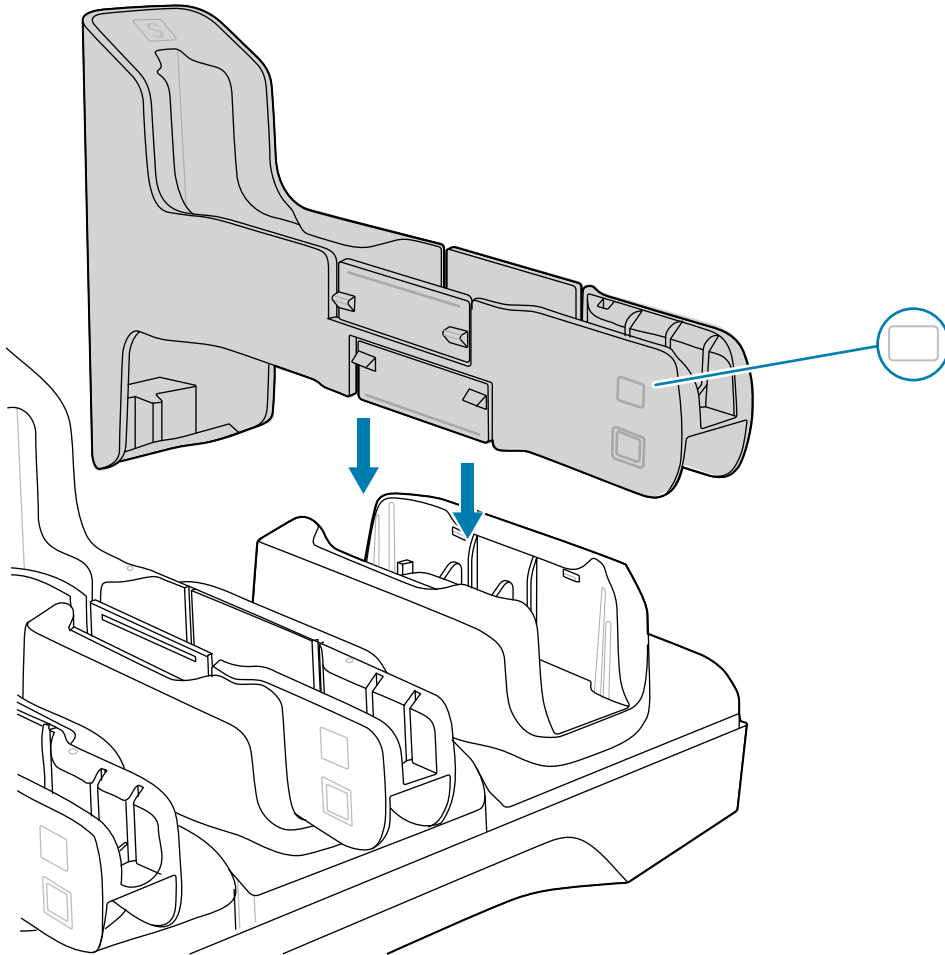

2. To charge a tablet with the rugged boot, hold the insert so that the rugged boot icon  is on top.

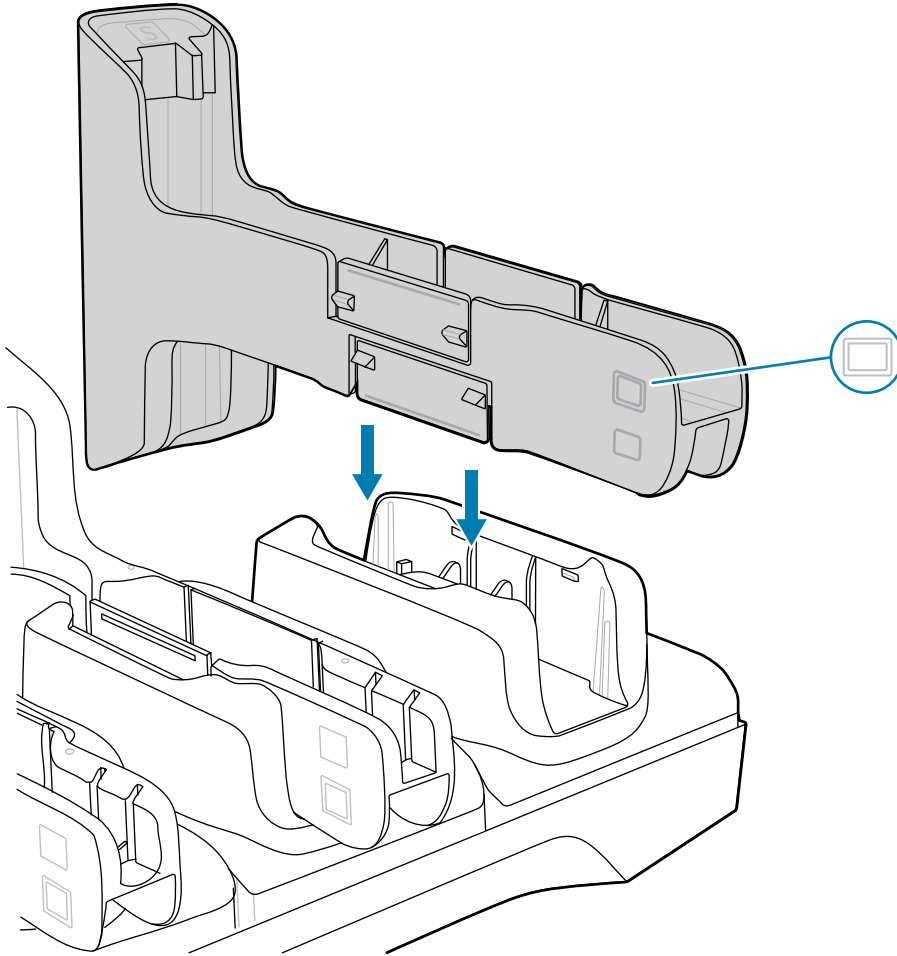

3. Align the insert with the cradle slot.
4. Press the insert down until it is fully seated.

To remove an insert, gently squeeze the tabs (1) and then lift the insert out of the cradle (2).

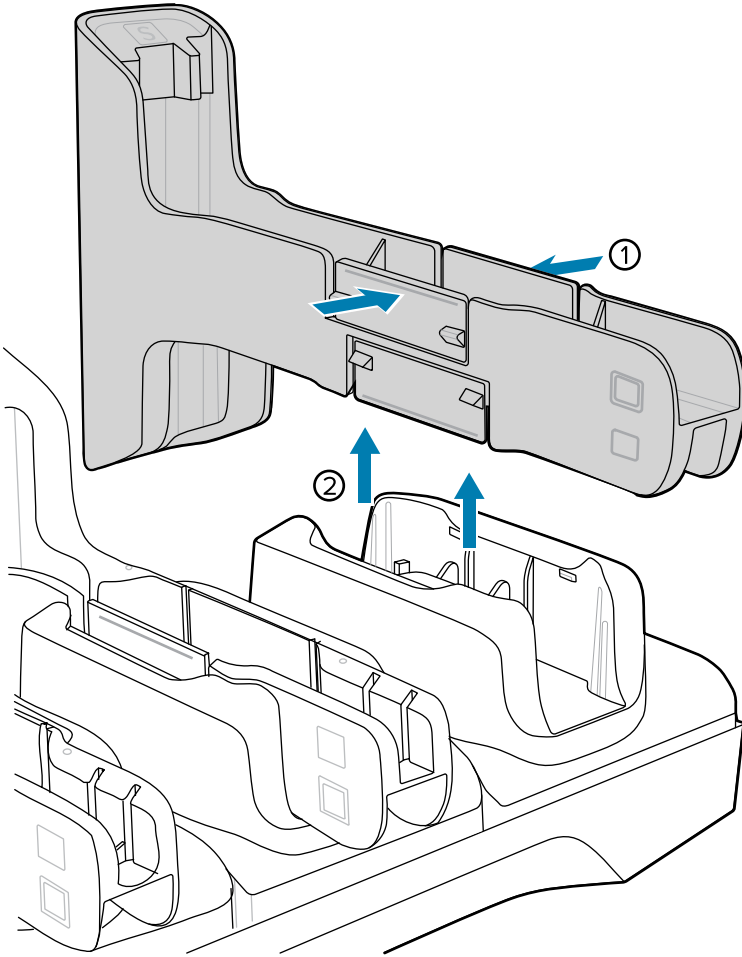

Charging Using a 4-Slot Cradle

Charge up to four tablets.

1. If applicable, adjust the insert to accommodate a table with or without the rugged boot.
2. Slide the device over the slot until it touches the guide.

3. Ensure that the alignment indicators on the tablet (1) and the cradle (2) are aligned.

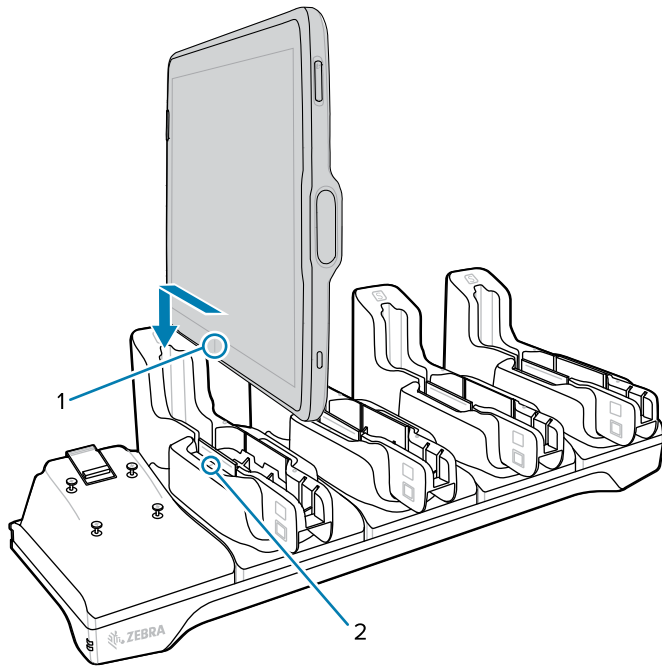

4. Place the device down into the slot with the display facing towards the Battery Charger.

Installing the Battery Charger

The 4-Slot Battery Charger is optional.

1. Align the mounting holes on the bottom of the charger with the four studs on the cradle.

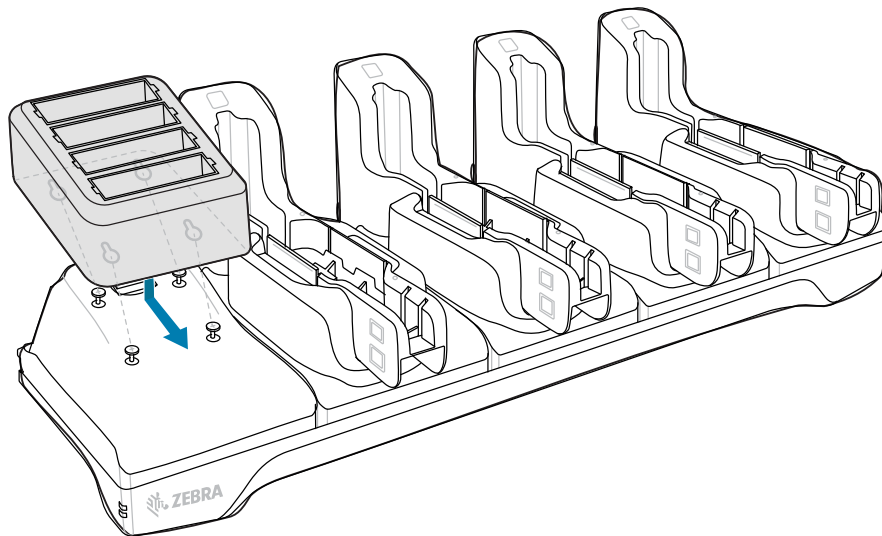

2. Place the charger on the cradle and then slide it toward the front of the cradle.

4-Slot Battery Charger

Use the 4-Slot Battery Charger to charge up to four Power Packs.



CAUTION: Ensure that you follow the guidelines for battery safety described in [Battery Safety Guidelines](#).

The 4-Slot Battery Charger:

- Provides 12 VDC power for charging the Power Packs.
- Simultaneously charges up to four Power Packs.

Figure 27 4-Slot Battery Charger

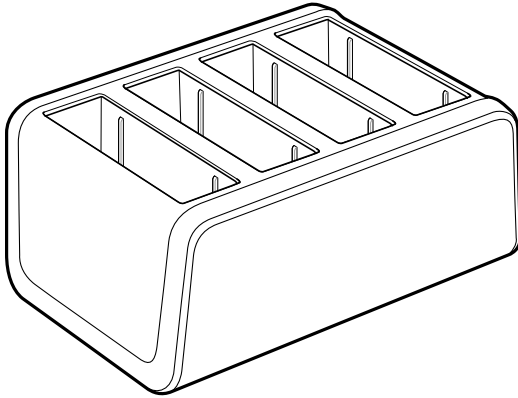

Power Setup

This section provides charger setup information.

Figure 28 4-Slot Battery Charger Setup

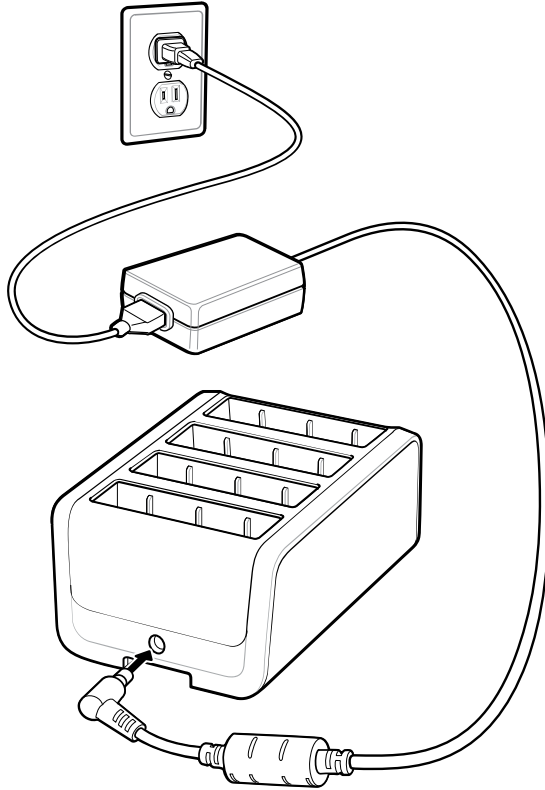

Charging the Power Pack Using the 4-Slot Battery Charger

Use the 4-Slot Battery Charger to charge up to four Power Packs.

To charge a Power Pack:

1. Connect the 4-Slot Battery Charger to AC outlet.

2. Insert the Power Pack into a slot.

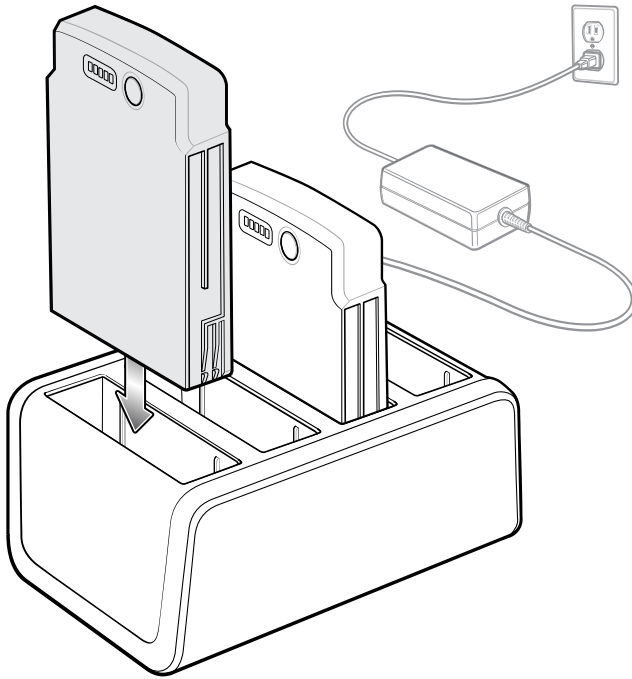

Power Pack Charging Indicators

Charge Power Packs in ambient temperatures from 0°C to +40°C (32°F to 104°F) as reported by the Power Pack. Charging is intelligently controlled by the charger. To accomplish this, for small periods of time, the charger alternately enables and disables Power Pack charging to keep the battery at acceptable temperatures.





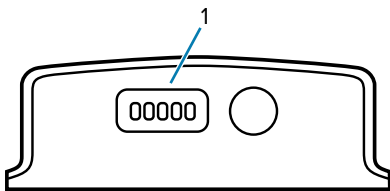





The Power Pack charge LED shows the status of the battery charging. The Power Pack charges in less than three hours. When charging, the Charge LEDs indicate the charge level.

Figure 29 Power Pack Charge LEDs



1	Charge level indicators
---	-------------------------

Table 26 Power Pack Charge Status Indicators

Power Pack Indicators	Description
	Solid Green LED
	Blinking Green LED
	Blinking Red LED
	Power not applied to Power Pack.
	Charge level is between 0% and 20%.
	Charge level is between 20% and 40%.
	Charge level is between 40% and 60%.
	Charge level is between 60% and 80%.
	Charge level is between 80% and 100%.
	Fully charged.
	Charging error.

Power Pack

The optional Power Pack provides additional power for charging the main battery.



NOTE: If the tablet is equipped with an Expansion Back and Power Pack, it produces recurring beep alerts when there is no user activity and the internal battery is fully charged by the Power Pack. To avoid the beeping alerts, the user is advised to remove the Power Pack from the Expansion Pack once the internal battery reaches 100%.

Figure 30 Power Pack

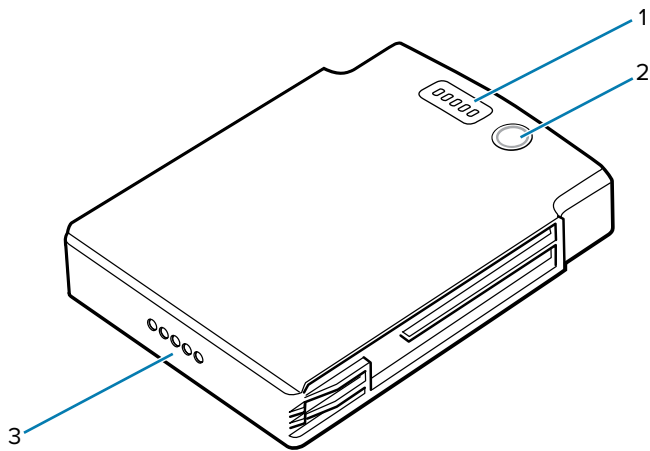

1	Charge level indicators
2	Charge indicator button
3	Power output contacts

Installing the Power Pack

The Power Pack Battery fits onto the Expansion Back.

1. Install one of the optional Expansion Backs. See [Expansion Back](#) for more information.
2. Press the two release buttons (1) on the side of the Expansion Back. The dummy battery insert ejects slightly.

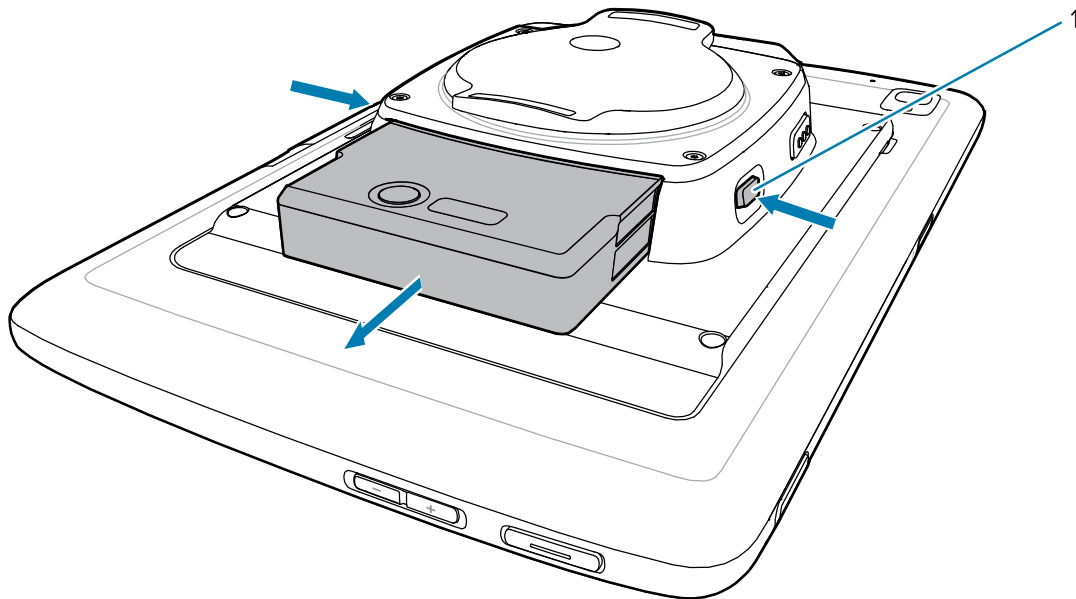

3. Remove dummy battery insert.

4. Insert Power Pack into slot until it snaps into place.

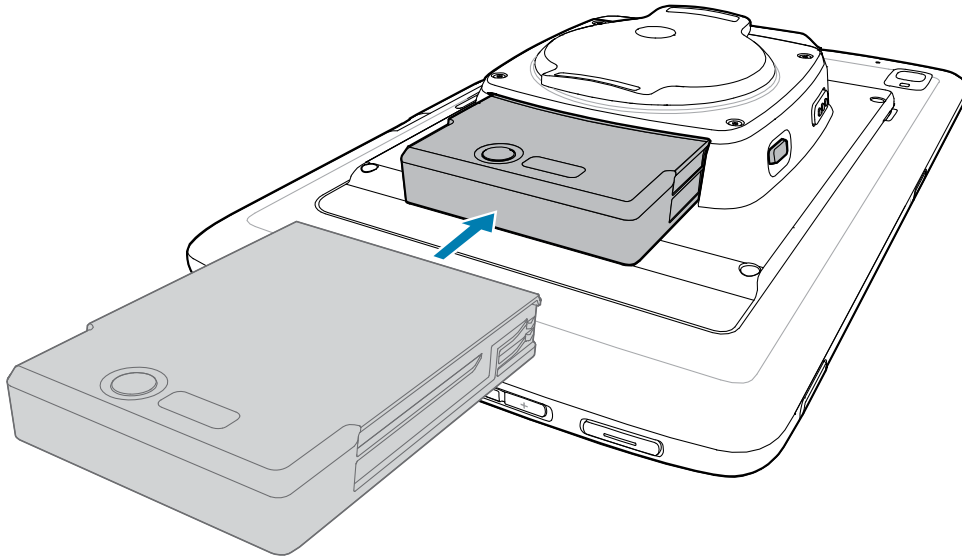

Rugged Boot

The rugged boot provides additional protection for the device.

Installing the Rugged Boot

1. Insert one side of the device into the rugged boot.

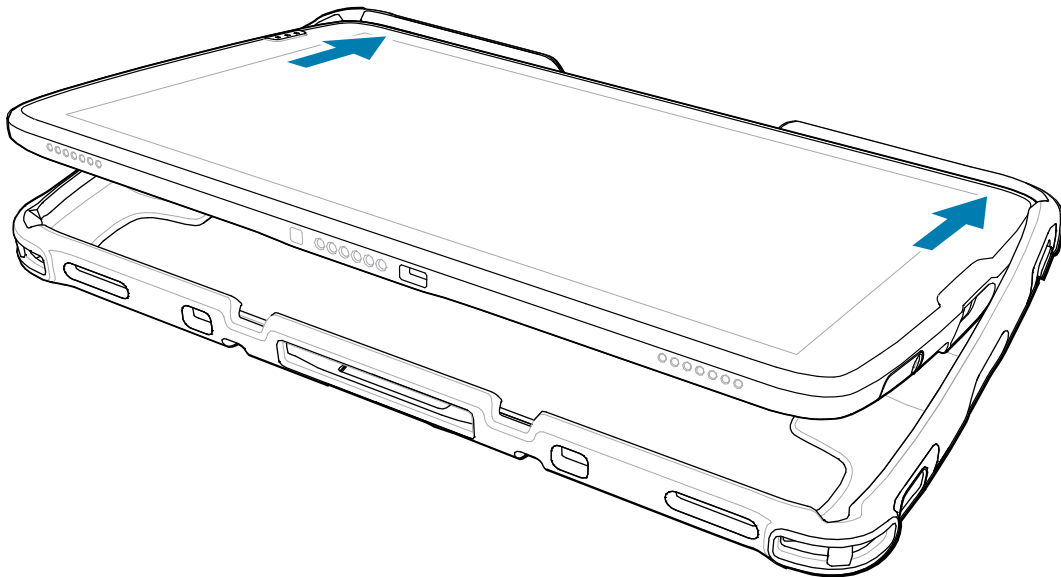

2. Push the other side of the device into the rugged boot.

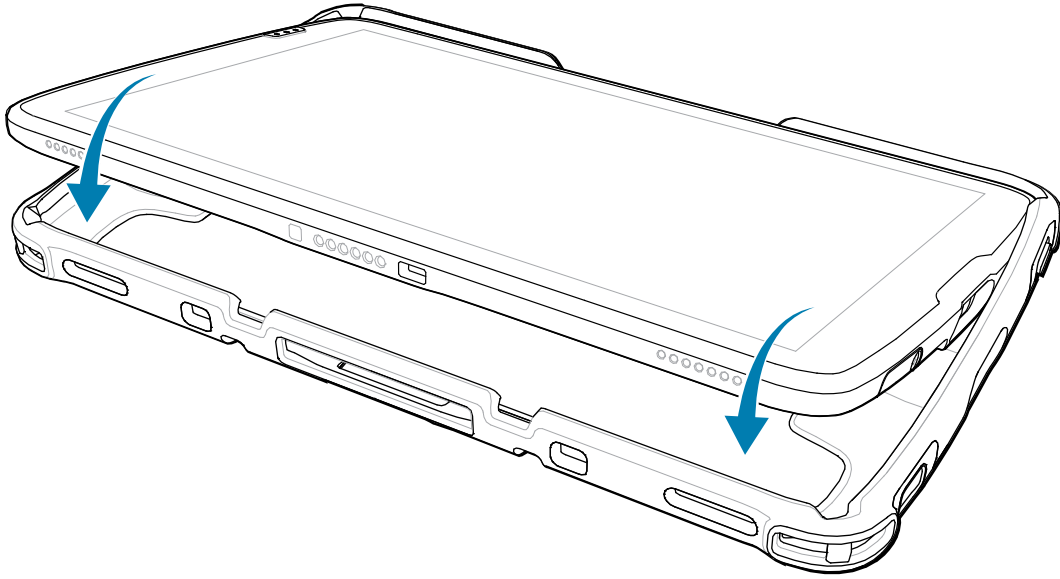

D-Clips

Attach the D-Clips to the rugged boot on the device either in portrait or landscape orientation.

Figure 31 D-Clips - Portrait

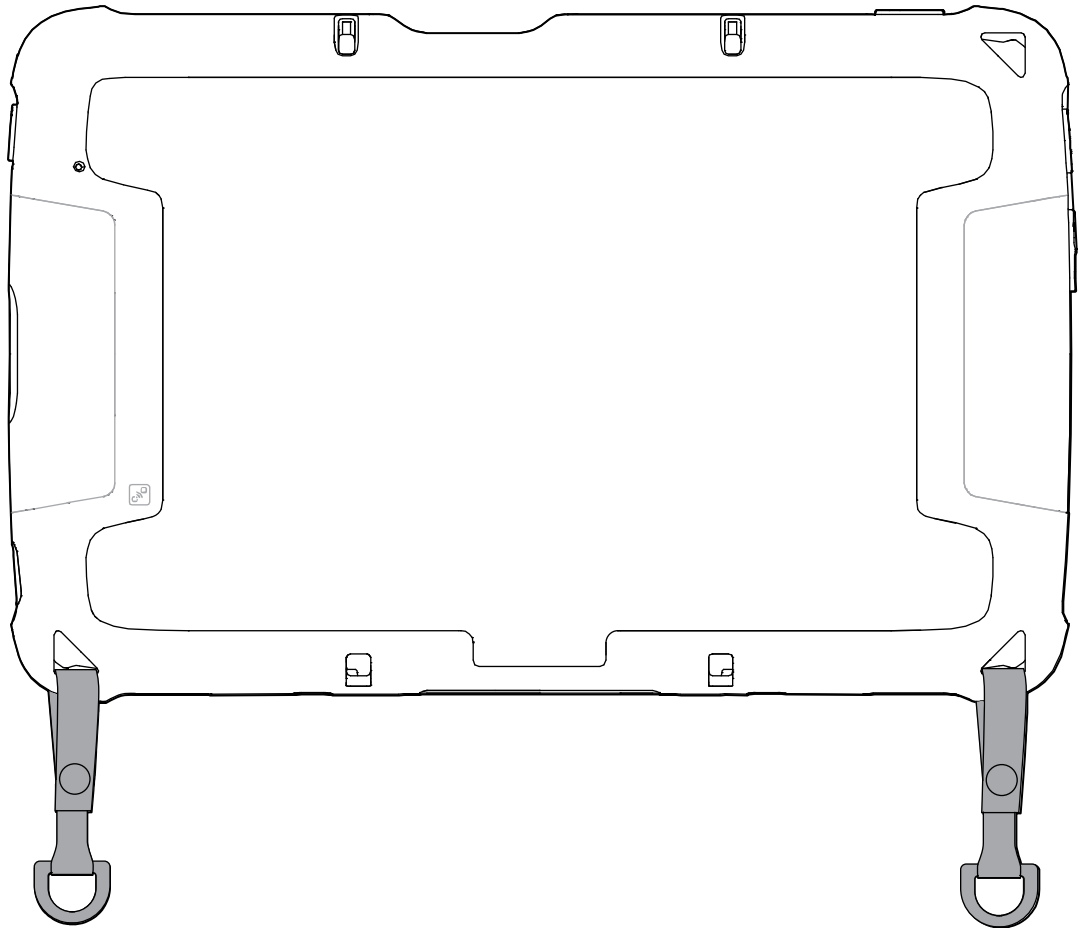
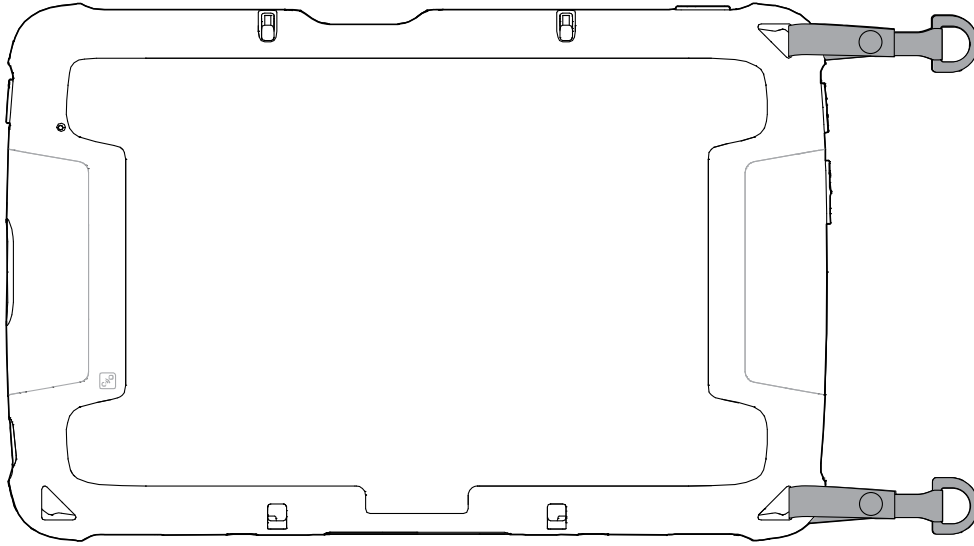

Figure 32 D-Clips - Landscape



Attaching the Shoulder Strap

The Shoulder Strap attaches to the D-Clips and allowed the user to sling the device over the shoulder.

The D-Clips must be attached to the rugged boot.

- Attach either end of the shoulder strap to each D-Clip.

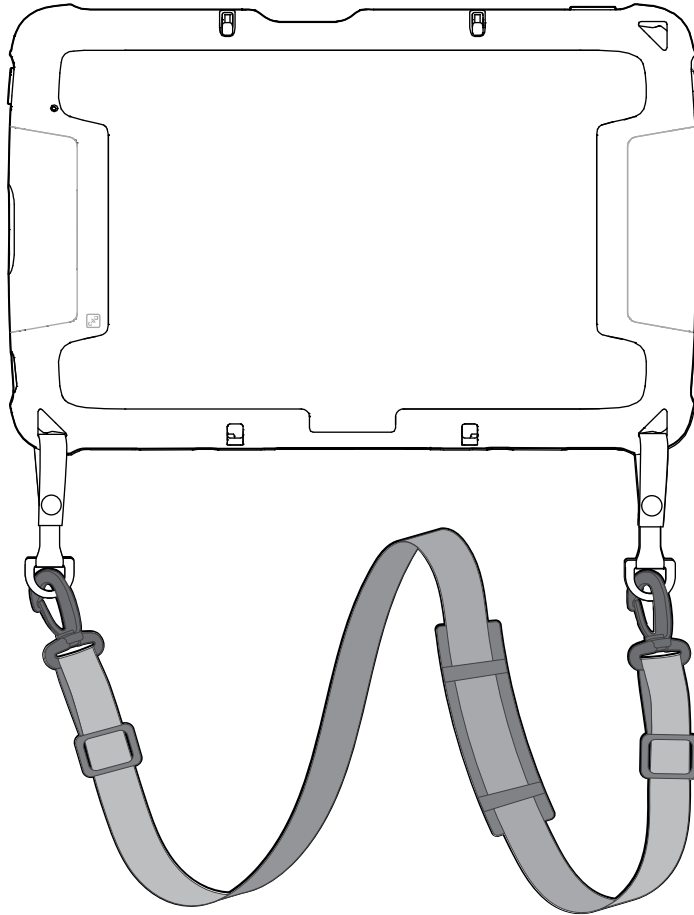

Healthcare Hand Strap

The Healthcare Hand Strap is adjustable and suitable for use in healthcare environments.

Figure 33 Healthcare Handstrap

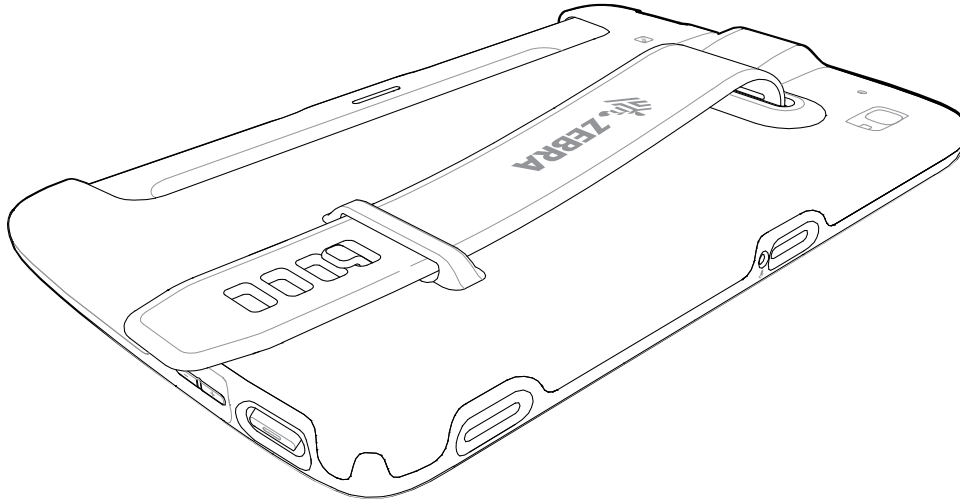

Installing the Handstrap

1. Insert the device into the closed side of the handstrap.

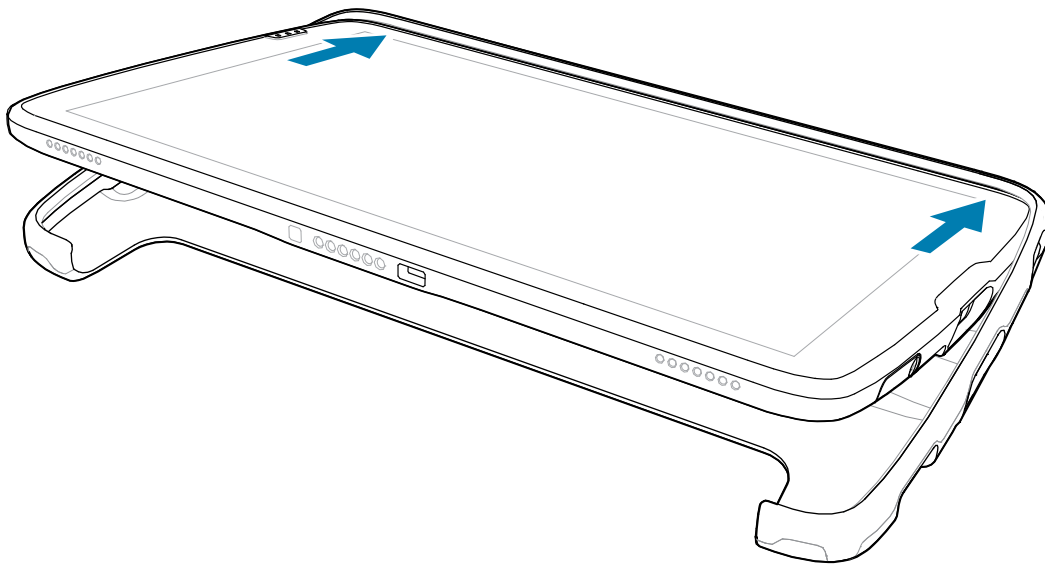

2. Push the device into the open side of the handstrap.

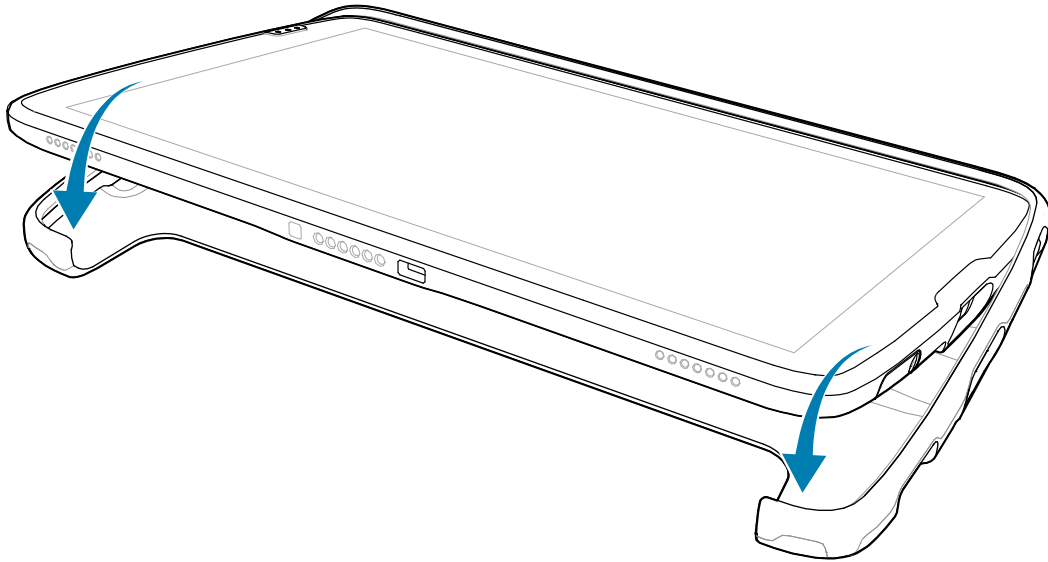

Expansion Back

The Expansion Back provides a handstrap and Power Pack slot for the device.

Installing the Expansion Back



CAUTION: Power off the device before installing or removing the Expansion Back.



CAUTION: Do not use any tool for battery cover removal. Puncturing the battery or seal may cause a hazardous condition and a potential risk of injury.

1. Remove battery cover and store in safe place.

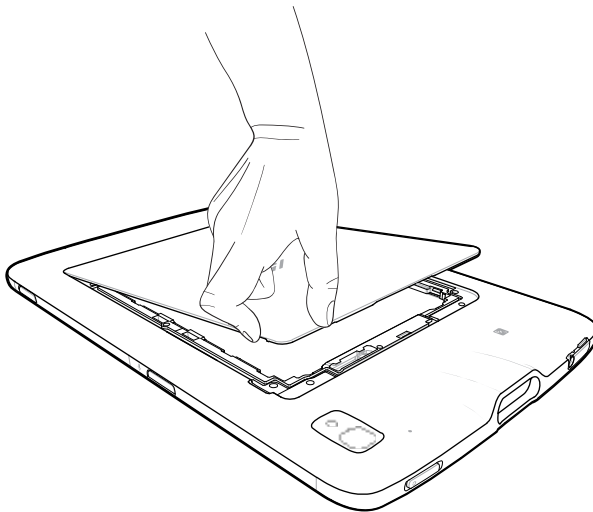

2. Insert the tabbed end of the expansion back into the battery well (1). Ensure that the tabs on the expansion back are aligned with the slots in the battery well.

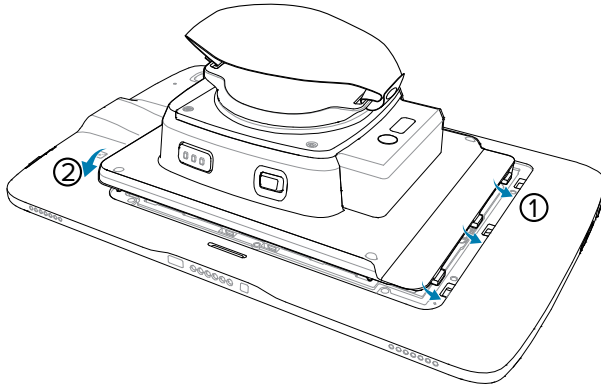

3. Rotate the expansion back down into the battery well (2).
4. Using a T5 Torx screwdriver, secure expansion back to device using four M2 screws. Torque to 0.43 N·m (3.8 lbf·in).

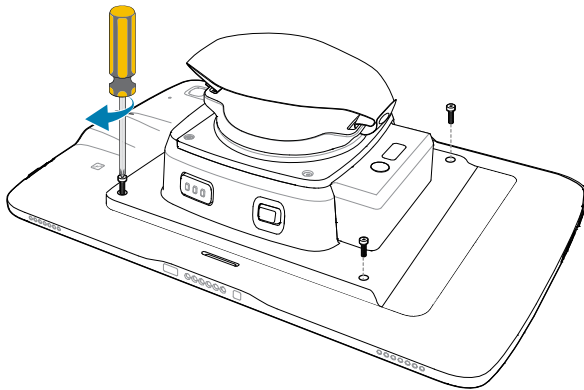

Removing the Expansion Back

Follow this procedure to safely remove the Expansion Back.



CAUTION: Power off the device before removing the Expansion Back.

1. Using a T5 Torx screwdriver, remove four screws securing expansion back to the device.
2. Lift Expansion Back off the device.
3. Insert the tabbed end of the battery cover into the slots in the battery well (1).

4. Rotate the cover down (2).

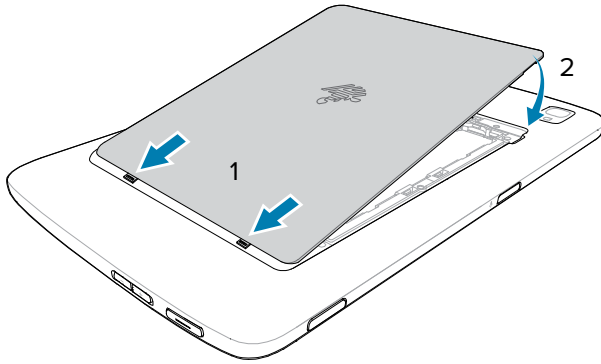

5. Carefully press down around the edges of the cover. Make sure that the cover is seated properly.

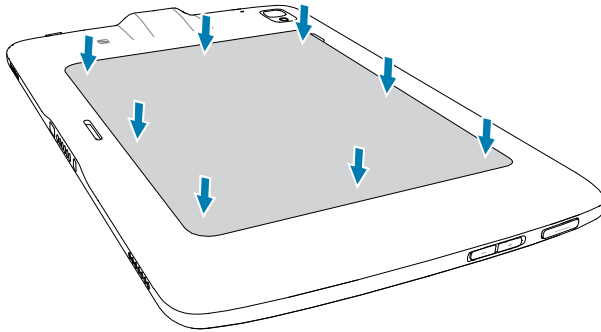

6. Press **Power** to turn on the device.

Application Deployment

This section provides an overview of device security, app development, and app management. It also provides instructions for installing apps and updating the device software.

Android Security

The device implements a set of security policies that determine whether an application is allowed to run and, if allowed, with what level of trust. To develop an application, you must know the security configuration of the device, and how to sign an application with the appropriate certificate to allow the application to run (and to run with the needed level of trust).



NOTE: Ensure the date is set correctly before installing certificates or when accessing secure web sites.

Secure Certificates

If the VPN or Wi-Fi networks rely on secure certificates, obtain the certificates and store them in the device's secure credential storage, before configuring access to the VPN or Wi-Fi networks.

If downloading the certificates from a web site, set a password for the credential storage. The device supports X.509 certificates saved in PKCS#12 key store files with a .p12 extension (if key store has a .pfx or other extension, change to .p12).

The device also installs any accompanying private key or certificate authority certificates contained in the key store.

Installing a Secure Certificate

If required by the VPN or Wi-Fi network, install a secure certificate on the device.

1. Copy the certificate from the host computer to the root of the device's internal memory. See [USB Communication](#) for information about connecting the device to a host computer and copying files.
2. Go to **Settings**.
3. Touch **Security > Encryption & credentials**.
4. Touch **Install a certificate**.
5. Select the desired certificate type.
6. Navigate to the location of the certificate file.
7. Touch the filename of the certificate to install.

8. If prompted, enter the password for credential storage. If a password has not been set for the credential storage, enter a password for it twice, and then touch **OK**.
9. If prompted, enter the certificate's password and touch **OK**.
10. Enter a name for the certificate and in the Credential use drop-down, select **VPN and apps** or **Wi-Fi**.
11. Touch **OK**.

Android Development Tools

Development tools for Android include Android Studio, EMDK for Android, and StageNow.

Android Development Workstation

Android development tools are available at developer.android.com.

To start developing applications for the device, download Android Studio. Development can take place on a Microsoft® Windows®, Mac® OS X®, or Linux® operating system.

Applications are written in Java or Kotlin, but compiled and executed in the Dalvik virtual machine. Once the Java code is compiled cleanly, the developer tools make sure the application is packaged properly, including the AndroidManifest.xml file.

Android Studio contains a full featured IDE as well as SDK components required to develop Android applications.

Enabling Developer Options

The **Developer options** screen sets development-related settings. By default, the Developer Options are hidden.

1. Go to **Settings**.
2. Touch **About phone**.
3. Scroll down to **Build number**.
4. Tap **Build number** seven times.
The message **You are now a developer!** appears.
5. Touch **Back**.
6. Touch **System > Advanced > Developer options**.
7. Slide the **USB debugging** switch to the **ON** position.

EMDK for Android

EMDK for Android provides developers with tools to create business applications for enterprise mobile devices. It is designed for use with Google's Android Studio and includes Android class libraries such as Barcode, sample applications with source code, and the associated documentation.

EMDK for Android allows applications to take full advantage of the capabilities that Zebra devices have to offer. It embeds Profile Manager technology within Android Studio IDE, providing a GUI-based development tool designed specifically for Zebra devices. This allows fewer lines of code, resulting in reduced development time, effort, and errors.

See Also

[For more information go to techdocs.zebra.com.](https://techdocs.zebra.com)

StageNow for Android

StageNow is Zebra's next-generation Android Staging Solution built on the MX platform. It allows quick and easy creation of device profiles, and can deploy to devices simply by scanning a barcode, reading a tag, or playing an audio file.

The StageNow Staging Solution includes the following components:

- The StageNow Workstation tool installs on the staging workstation (host computer) and lets the administrator easily create staging profiles for configuring device components, and perform other staging actions such as checking the condition of a target device to determine suitability for software upgrades or other activities. The StageNow Workstation stores profiles and other created content for later use.
- The StageNow Client resides on the device and provides a user interface for the staging operator to initiate staging. The operator uses one or more of the desired staging methods (print and scan a barcode, read an NFC tag or play an audio file) to deliver staging material to the device.

See Also

[For more information go to techdocs.zebra.com.](https://techdocs.zebra.com)

GMS Restricted

GMS Restricted mode deactivates Google Mobile Services (GMS). All GMS apps are disabled on the device and communication with Google (analytics data collection and location services) is disabled.

Use StageNow to disable or enable GMS Restricted mode. After a device is in GMS Restricted mode, enable and disable individual GMS apps and services using StageNow. To ensure GMS Restricted mode persists after an Enterprise Reset, use the Persist Manager option in StageNow.

See Also

[For more information on StageNow, refer to techdocs.zebra.com.](https://techdocs.zebra.com)

ADB USB Setup

To use the ADB, install the development SDK on the host computer then install the ADB and USB drivers.

Before installing the USB driver, make sure that the development SDK is installed on the host computer. Go to developer.android.com/sdk/index.html for details on setting up the development SDK.

The ADB and USB drivers for Windows and Linux are available on the Zebra Support Central web site at zebra.com/support. Download the ADB and USB Driver Setup package. Follow the instructions with the package to install the ADB and USB drivers for Windows and Linux.

Enabling USB Debugging

By default, USB debugging is disabled.

1. Go to **Settings**.
2. Touch **About phone**.

3. Scroll down to **Build number**.
4. Tap **Build number** seven times.
The message **You are now a developer!** appears.
5. Touch **Back**.
6. Touch **System > Advanced > Developer options** .
7. Slide the **USB debugging** switch to the **ON** position.
8. Touch **OK**.
9. Connect the device to the host computer using the Rugged Charge/USB Cable.
The **Allow USB debugging?** dialog box appears on the device.
If the device and host computer are connected for the first time, the **Allow USB debugging?** dialog box with the **Always allow from this computer** check box displays. Select the check box, if required.
10. Touch **OK**.
11. Touch **OK** or **Allow**.
12. On the host computer, navigate to the **platform-tools** folder and open a command prompt window.
13. Type `adb devices`.
The following displays:

```
List of devices attached          XXXXXXXXXXXXXXXXXXXX device
```

Where XXXXXXXXXXXXXXXXXXXX is the device number.



NOTE: If device number does not appear, ensure that ADB drivers are installed properly.

14. Return to the Home screen.

Entering Android Recovery Manually

Many of the update methods discussed in this section require putting the device into Android Recovery mode. If you are unable to enter Android Recovery mode through `adb` commands, use the following steps to manually enter Android Recovery mode.

1. Press and hold the Power button until the menu appears.
2. Touch **Restart**.
3. Press and hold the volume up button until the System Recovery screen appears.

Application Installation

After an application is developed, install the application onto the device using one of the supported methods.

- Android Debug Bridge
- Wireless Android Debug Bridge
- USB connection

- USB drive
- Mobile device management (MDM) platforms that have application provisioning. Refer to the MDM software documentation for details.

Installing Applications Using the Android Debug Bridge

Use ADB commands to install applications onto the device.

1. Ensure that the ADB drivers are installed on the host computer.
2. Connect the device to a host computer using a USB cable.
3. Enable **Developer options**.
4. Go to **Settings**.
5. Touch **System > Advanced > Developer options**.
6. Slide the **USB debugging** switch to the **ON** position.
7. If the device and host computer are connected for the first time, the **Allow USB debugging?** dialog box with the **Always allow from this computer** check box displays. Select the check box, if required.
8. Touch **OK**.
9. Type `adb install <application>`.
where: <application> = the path and filename of the apk file.
10. Disconnect the device from the host computer.

Installing Applications Using the Wireless Android Debug Bridge

Use ADB commands to install an application onto the device.



IMPORTANT: Ensure the latest adb files are installed on the host computer.



NOTE: If device number does not appear, ensure that ADB drivers are installed properly.

1. Go to **Settings**.
2. Touch **System > Advanced > Developer options**.
3. Slide the **USB debugging** switch to the **ON** position.
4. Slide the **Wireless debugging** switch to the **ON** position.
5. If the device and host computer are connected for the first time, the **Allow wireless debugging on this network?** dialog box with the **Always allow from this network** check box displays. Select the check box, if required.
6. Touch **ALLOW**.
7. Touch **Wireless debugging**.

8. Touch **Pair with pairing code**.

The **Pair with device** dialog box displays.

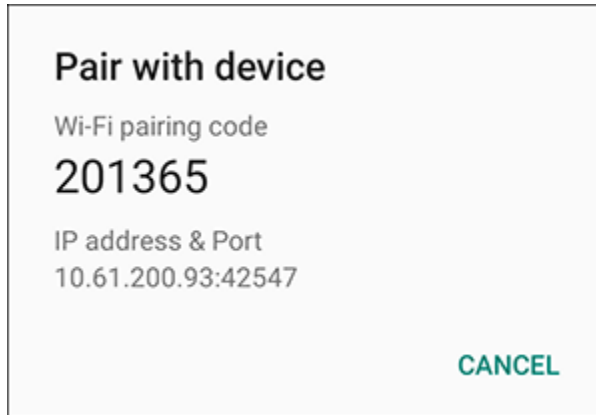

9. On the host computer, navigate to the **platform-tools** folder and open a command prompt window.
10. Type `adb pair XX.XX.XX.XX.XXXXXX`.
where `XX.XX.XX.XX.XXXXXX` is the IP address and port number from the **Pair with device** dialog box.
11. Press **Enter**.
12. Type the pairing code from the **Pair with device** dialog box.
13. Press **Enter**.
14. Type `adb connect XX.XX.XX.XX:XXXXXX`.
where `XX.XX.XX.XX:XXXXXX` is the IP address and port number from the **Pair with device** dialog box.
15. Press **Enter**.
The device is now connected to the host computer.
16. Type `adb devices`.
The following displays:

```
List of devices attached      XXXXXXXXXXXXXXXXXXXX device
```

Where `XXXXXXXXXXXXXXXXXX` is the device number.



NOTE: If device number does not appear, ensure that ADB drivers are installed properly.

17. On the host computer command prompt window type:

```
adb install <application>
```

where: `<file>` = the path and filename of the apk file.

18. On the host computer, type:
`adb disconnect`.

Installing Applications Using the USB Connection

Use the USB connection to install applications onto the device.

1. Connect the device to a host computer using the USB-C cable.
2. On the device, pull down the Notification panel and touch **Charging this device via USB**.
By default, **No data transfer** is selected.
3. Touch **File Transfer**.
4. On the host computer, open a file explorer application.
5. On the host computer, copy the application APK file from the host computer to the device.



CAUTION: Carefully follow the host computer's instructions to unmount the microSD card and disconnect USB devices correctly to avoid losing information.

6. Disconnect the device from the host computer.
7. Swipe the screen up and select  to view files on the Internal Storage.
8. Locate the application APK file.
9. Touch the application file.
10. Touch **Continue** to install the app or **Cancel** to stop the installation.
11. To confirm installation and accept what the application affects, touch **Install** otherwise touch **Cancel**.
12. Touch **Open** to open the application or **Done** to exit the installation process.

The application appears in the App list.

Installing Applications Using a USB Drive

Use a USB drive to install applications on the device.



IMPORTANT: USB Drive must have FAT32 format.

1. Plug the USB drive into the USB port on the host computer.
2. On the host computer, open a file explorer application.
3. Copy the application APK file from the host computer to the USB drive.



CAUTION: Follow the host computer's instructions to eject the USB drive correctly to avoid losing information.

4. Eject the USB drive from the host computer.
5. Plug the USB drive into the USB port on the device.
A notification appears indicating that the device detected the USB drive.
6. Swipe the screen up and select  to view files on the USB drive.
7. Touch **General USB drive**.
8. Locate the application APK file.
9. Touch the application file.
10. Touch **Continue** to install the app or **Cancel** to stop the installation.

11. To confirm installation and accept what the application affects, touch **Install** otherwise touch **Cancel**.
12. Touch **Open** to open the application or **Done** to exit the installation process.
The application appears in the App list.
13. Disconnect the USB drive from the host computer.

Uninstalling an Application

Free up device memory by removing unused apps.

1. Go to **Settings**.
2. Touch **Apps & notifications**.
3. Touch **See all apps** to view all apps in the list.
4. Scroll through the list to the app.
5. Touch the app. The **App info** screen appears.
6. Touch **Uninstall**.
7. Touch **OK** to confirm.

Android System Update

System Update packages can contain either partial or complete updates for the operating system. Zebra distributes the System Update packages on the Zebra Support & Downloads website. Perform a system update using either a microSD card or using ADB.

Performing a System Update Using ADB

Use ADB to perform a system update.

1. Connect the device to a host computer using a USB-C cable or by inserting the device into the Workstation Cradle.
2. Go to **Settings**.
3. Touch **System > Advanced > Developer options**.
4. Slide the **USB debugging** switch to the **ON** position.
5. If the device and host computer are connected for the first time, the **Allow USB debugging?** dialog box with the **Always allow from this computer** check box displays. Select the check box, if required.
6. Touch **OK**.
7. On the host computer, navigate to the **platform-tools** folder and open a command prompt window.

8. Type `adb devices`.

The following displays:

```
List of devices attached          XXXXXXXXXXXXXXXXXXXX device
```

Where XXXXXXXXXXXXXXXXXXXX is the device number.



NOTE: If device number does not appear, ensure that ADB drivers are installed properly.

9. Type:

```
adb reboot recovery
```

10. Press **Enter**.

The System Update installs (progress appears as percentage in the Command Prompt window) and then the System Recovery screen appears on the device.

11. Press **Volume Up** and **Volume Down** to navigate to **Apply upgrade from ADB**.

12. Press **Enter**.

The System Recovery screen appears on the device.

13. Press **Power**.

14. On the host computer command prompt window type:

```
adb sideload <file>
```

where: <file> = the path and filename of the zip file.

15. Press **Enter**.

The System Update installs (progress appears as percentage in the Command Prompt window) and then the System Recovery screen appears on the device.

16. Press **Power** to reboot the device.

Performing a System Update Using Wireless ADB

Use wireless ADB to perform a system update.

Go to the Zebra Support & Downloads web site at zebra.com/support and download the appropriate System Update package to a host computer.



IMPORTANT: Ensure the latest adb files are installed on the host computer.



IMPORTANT: The device and the host computer must be on the same wireless network.

1. Go to **Settings**.
2. Touch **System > Advanced > Developer options**.
3. Slide the **USB debugging** switch to the **ON** position.
4. Slide the **Wireless debugging** switch to the **ON** position.

5. Touch **Wireless debugging**.
6. If the device and host computer are connected for the first time, the **Allow wireless debugging on this network?** dialog box with the **Always allow from this network** check box displays. Select the check box, if required.
7. Touch **ALLOW**.
8. Touch **Pair with pairing code**.

The **Pair with device** dialog box displays.

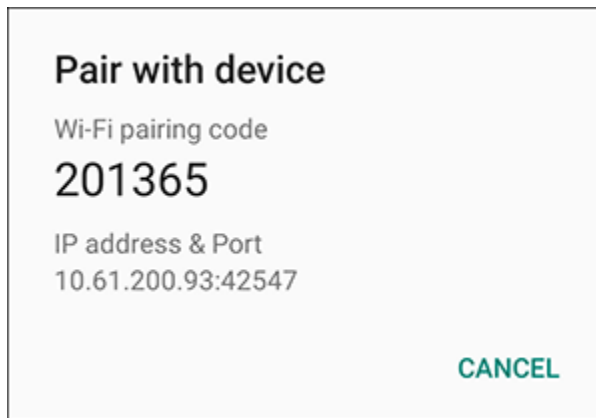

9. On the host computer, navigate to the **platform-tools** folder and open a command prompt window.
10. Type `adb pair XX.XX.XX.XX.XXXXX`.
where `XX.XX.XX.XX.XXXXX` is the IP address and port number from the **Pair with device** dialog box.
11. Press **Enter**.
12. Type the pairing code from the **Pair with device** dialog box.
13. Press **Enter**.
14. Type `adb connect XX.XX.XX.XX.XXXXX`.
where `XX.XX.XX.XX.XXXXX` is the IP address and port number from the **Pair with device** dialog box.
15. Press **Enter**.
The device is now connected to the host computer.
16. Type:
`adb reboot recovery`
17. Press **Enter**.
The System Recovery screen appears on the device.
18. Press **Volume Up** and **Volume Down** to navigate to **Apply upgrade from ADB**.
19. Press **Power**.
20. On the host computer command prompt window type:

```
adb sideload <file>
```

where: `<file>` = the path and filename of the zip file.

21. Press **Enter**.

The System Update installs (progress appears as percentage in the Command Prompt window) and then the System Recovery screen appears on the device.

22. Navigate to **Reboot system now** and press the Power button to reboot the device.

23. On the host computer, type:

```
adb disconnect.
```

Performing a System Update Using USB Drive

Update the operating system on the device using a USB drive.

Go to the Zebra Support & Downloads web site at zebra.com/support and download the appropriate System Update package to a host computer.



WARNING: Do not remove the USB drive during system update. Damage to device can occur.



IMPORTANT: USB drive must have FAT32 format.

1. Install the USB drive into the host computer USB port.
2. Copy the System Update zip file to the root of a USB drive.
3. Properly eject the USB drive from host computer and remove the USB drive.
4. Remove the dust cover from the back of the device.
5. Insert the USB drive into the USB port.
6. Press and hold **Power** until the menu appears.
7. Touch **Restart**.
8. Press and hold **blue+** until the Zebra logo screen appears.
The System Recovery screen appears.
9. Press **Volume Up** and **Volume Down** to navigate to **apply upgrade from USB drive**.
10. Press **Power**.
11. Use **Volume Up** and **Volume Down** to navigate to the System Update zip file.
12. Press **Power**.
The System Update installs and then the device returns to the Recovery screen.
13. Press **Power** to reboot the device.

Verifying System Update Installation

Verify that the system update was successful.

1. Go to **Settings**.
2. Touch **About phone**.
3. Scroll down to **Build number**.
4. Ensure that the build number matches the new system update package file number.

Android Enterprise Reset

An Enterprise Reset erases all user data in the /data partition, including data in the primary storage locations (emulated storage). Zebra distributes the Enterprise Reset packages on the Zebra Support & Downloads website.

Before performing an Enterprise Reset, provision all necessary configuration files and restore after the reset.

Performing an Enterprise Reset Using ADB

Perform an Enterprise Reset using ADB.

Go to the Zebra Support & Downloads web site at zebra.com/support and download the appropriate Enterprise Reset file to a host computer.

1. Connect the device to a host computer using a USB-C cable or by inserting the device into the Workstation Cradle.
2. Go to **Settings**.
3. Touch **System > Advanced > Developer options**.
4. Slide the **USB debugging** switch to the **ON** position.
5. If the device and host computer are connected for the first time, the **Allow USB debugging?** dialog box with the **Always allow from this computer** check box displays. Select the check box, if required.
6. Touch **OK**.
7. On the host computer command prompt window type:

```
adb sideload <file>
```

where: <file> = the path and filename of the zip file.

8. Type `adb devices`.

The following displays:

```
List of devices attached          XXXXXXXXXXXXXXXXXXXX device
```

Where XXXXXXXXXXXXXXXXXXXX is the device number.



NOTE: If device number does not appear, ensure that ADB drivers are installed properly.

9. Press **Enter**.
The System Recovery screen appears on the device.
10. Press **Volume Up** and **Volume Down** to navigate to **Apply upgrade from ADB**.
11. Press **Power**.

- On the host computer command prompt window type:

```
adb sideload <file>
```

where: <file> = the path and filename of the zip file.

- Press **Enter**.

The Enterprise Reset package installs and then the System Recovery screen appears on the device.

- Press **Power** to reboot the device.

Performing an Enterprise Reset Using Wireless ADB

Perform an Enterprise Reset using Wireless ADB.

Go to the Zebra Support & Downloads web site at zebra.com/support and download the appropriate Enterprise Reset file to a host computer.



IMPORTANT: Ensure the latest adb files are installed on the host computer.



IMPORTANT: The device and host computer must be on the same wireless network.

- Go to **Settings**.
- Touch **System > Advanced > Developer options**.
- Slide the **USB debugging** switch to the **ON** position.
- Slide the **Wireless debugging** switch to the **ON** position.
- If the device and host computer are connected for the first time, the **Allow wireless debugging on this network?** dialog box with the **Always allow from this network** check box displays. Select the check box, if required.
- Touch **ALLOW**.
- Touch **Wireless debugging**.
- Touch **Pair with pairing code**.

The **Pair with device dialog** box displays.

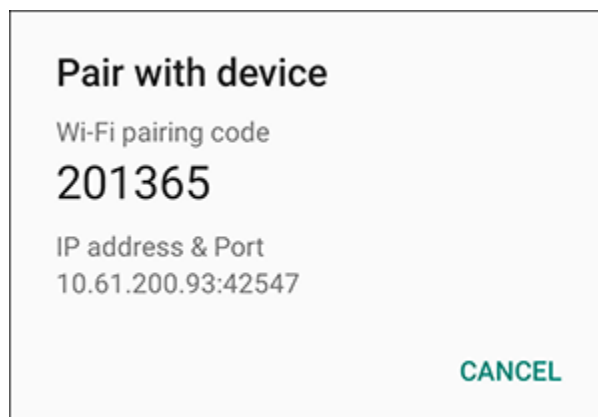

- On the host computer, navigate to the **platform-tools** folder and open a command prompt window.

10. Type `adb pair XX.XX.XX.XX.XXXXX`.
where `XX.XX.XX.XX.XXXXX` is the IP address and port number from the **Pair with device** dialog box.
11. Press **Enter**.
12. Type the pairing code from the **Pair with device** dialog box
13. Press **Enter**.
14. Type `adb connect XX.XX.XX.XX.XXXXX`.
where `XX.XX.XX.XX.XXXXX` is the IP address and port number from the **Pair with device** dialog box.
15. Press **Enter**.
The device is now connected to the host computer.
16. Type `adb devices`.
The following displays:

```
List of devices attached      XXXXXXXXXXXXXXXXXXXX device
```

Where XXXXXXXXXXXXXXXXXXXX is the device number.



NOTE: If device number does not appear, ensure that ADB drivers are installed properly.

17. On the host computer command prompt window type:

```
adb sideload <file>
```

where: <file> = the path and filename of the zip file.

18. Type:
`adb reboot recovery`
19. Press **Enter**.
The Factory Recovery screen appears on the device.
20. Press **Volume Up** and **Volume Down** to navigate to **Apply upgrade from ADB**.
21. Press **Power**.
22. On the host computer command prompt window type:

```
adb sideload <file>
```

where: <file> = the path and filename of the zip file.

23. Press **Enter**.
The Enterprise Reset package installs and then the System Recovery screen appears on the device.
24. Press **Power** to reboot the device.
25. On the host computer, type:
`adb disconnect`.

Performing an Enterprise Reset Using USB Drive

Perform an Enterprise Reset using a USB drive.

Go to the Zebra Support & Downloads web site at zebra.com/support and download the appropriate Enterprise Reset file to a host computer.

1. Copy the Enterprise Reset zip file to the root of the USB drive.
 - Copy the zip file to a USB drive using a host computer and then install the microSD card into the device. See Getting Started for more information.
 - Connect the device with a microSD card already installed to the host computer and copy zip file to the microSD card. See USB Communication for more information. Disconnect the device from the host computer.
2. Press and hold **Power** until the menu appears.
3. Touch **Restart**.
4. Press and hold **Blue** until the Zebra boot screen appears.

The Android Recovery screen appears.
5. Press **Up** and **Down** to navigate to the **apply update from USB drive**.
6. Press **Power**.
7. Press **Up** and **Down** to navigate to the Enterprise Reset file.
8. Press **Power**.

The Enterprise Reset occurs and then the device returns to the Recovery screen.
9. Press **Power**.

Android Factory Reset

A Factory Reset erases all data in the /data and /enterprise partitions in internal storage and clears all device settings. A Factory Reset returns the device to the last installed operating system image. To revert to a previous operating system version, re-install that operating system image. Zebra distributes the Factory Reset packages on the Zebra Support & Downloads website.

Performing a Factory Reset Using ADB

Perform a Factory Reset using ADB.

Go to the Zebra Support & Downloads web site at zebra.com/support and download the appropriate Factory Reset file to a host computer.

1. Connect the device to a host computer using a USB-C cable or by inserting the device into the Workstation Cradle.
2. Go to **Settings**.
3. Touch **System** > **Advanced** > **Developer options**.
4. Slide the **USB debugging** switch to the **ON** position.
5. If the device and host computer are connected for the first time, the **Allow USB debugging?** dialog box with the **Always allow from this computer** check box displays. Select the check box, if required.

6. Touch **OK**.
7. On the host computer, navigate to the **platform-tools** folder and open a command prompt window.
8. Type `adb devices`.

The following displays:

```
List of devices attached          XXXXXXXXXXXXXXXXXXXX device
```

Where XXXXXXXXXXXXXXXXXXXX is the device number.



NOTE: If device number does not appear, ensure that ADB drivers are installed properly.

9. Type:
`adb reboot recovery`
10. Press **Enter**.
The System Recovery screen appears on the device.
11. Press **Volume Up** and **Volume Down** buttons to navigate to **Apply upgrade from ADB**.
12. Press **Power**.
13. On the host computer command prompt window type:

```
adb sideload <file>
```

where: <file> = the path and filename of the zip file.

14. Press **Enter**.
The Factory Reset package installs and then the System Recovery screen appears on the device.
15. Press **Power** to reboot the device.

Performing a Factory Reset Using Wireless ADB

Perform a Factory Reset using Wireless ADB.

Go to the Zebra Support & Downloads web site at zebra.com/support and download the appropriate Factory Reset file to a host computer.



IMPORTANT: Ensure the latest adb files are installed on the host computer.



IMPORTANT: The device and host computer must be on the same wireless network.

1. Go to **Settings**.
2. Touch **System > Advanced > Developer options**.
3. Slide the **USB debugging** switch to the **ON** position.
4. Slide the **Wireless debugging** switch to the **ON** position.

5. If the device and host computer are connected for the first time, the **Allow wireless debugging on this network?** dialog box with the **Always allow from this network** check box displays. Select the check box, if required.
6. Touch **ALLOW**.
7. Touch **Wireless debugging**.
8. Touch **Pair with pairing code**.

The **Pair with device** dialog box displays.

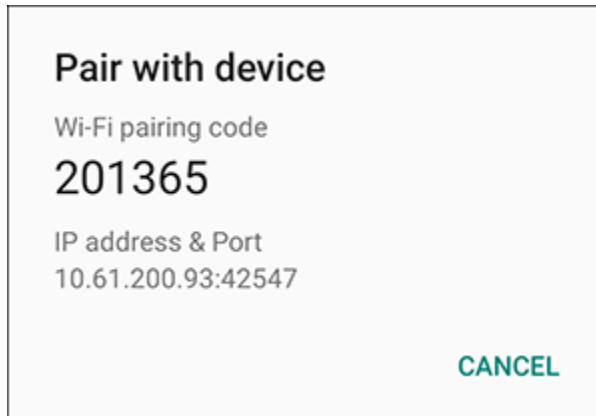

9. On the host computer, navigate to the **platform-tools** folder and open a command prompt window.
10. Type `adb pair XX.XX.XX.XX.XXXXXX`
where `XX.XX.XX.XX.XXXXXX` is the IP address and port number from the **Pair with device** dialog box.
11. Press **Enter**.
12. Type the pairing code from the **Pair with device** dialog box
13. Press **Enter**.
14. Type `adb connect XX.XX.XX.XX:XXXXXX`
where `XX.XX.XX.XX:XXXXXX` is the IP address and port number from the **Pair with device** dialog box.
15. Press **Enter**.

The device is now connected to the host computer.

16. Type `adb devices`.
The following displays:

```
List of devices attached          XXXXXXXXXXXXXXXXXXXX device
```

Where XXXXXXXXXXXXXXXXXXXX is the device number.



NOTE: If device number does not appear, ensure that ADB drivers are installed properly.

17. Type:
`adb reboot recovery`

18. Press **Enter**.

The Factory Reset package installs and then the System Recovery screen appears on the device.

19. Press **Volume Up** and **Volume Down** to navigate to **Apply upgrade from ADB**.

20. Press **Power**.

21. On the host computer command prompt window type:

```
adb sideload <file>
```

where: <file> = the path and filename of the zip file.

22. Press **Enter**.

The Factory Reset package installs and then the System Recovery screen appears on the device.

23. Press **Power** to reboot the device.

24. On the host computer, type:

```
adb disconnect.
```

Performing a Factory Reset Using a USB Drive

Perform a Factory Reset using a USB drive.

Go to the Zebra Support & Downloads web site at zebra.com/support and download the appropriate Factory Reset file to a host computer.

1. Copy the Factory Reset zip file to the root of the USB drive.
 - Copy the zip file to a USB drive using a host computer and then installing the USB drive into the device.
 - Connect the device with a USB drive already installed to the host computer and copy the zip file to the USB drive. Disconnect the device from the host computer.
2. Press and hold **Power** until the menu appears.
3. Touch **Restart**.

The device resets.
4. Press and hold **Blue** until the Zebra boot screen.

The System Recovery screen appears.
5. Press **Up** and **Down** to navigate to the **apply update from USB drive**.
6. Press **Power**.
7. Press **Up** and **Down** to navigate to the Android Reset file.
8. Press **Power**.

The Factory Reset occurs and then the device returns to the Recovery screen.
9. Press **Power**.

Android Storage

The device contains multiple types of file storage.

- Random Access Memory (RAM)
- On-device Storage

Random Access Memory

Executing programs use RAM to store data. Data stored in RAM is lost upon a reset.

The operating system manages how applications use RAM. It only allows applications and component processes and services to use RAM when required. It may cache recently used processes in RAM, so they restart more quickly when opened again, but it will erase the cache if it needs the RAM for new activities.

The screen displays the amount of used and free RAM.

- **Performance** - Indicates memory performance.
- **Total memory** - Indicates the total amount of RAM available.
- **Average used (%)** - Indicates the average amount of memory (as a percentage) used during the period of time selected (default - 3 hours).
- **Free** - Indicates the total amount of unused RAM.
- **Memory used by apps** - Touch to view RAM usage by individual apps.

Viewing Memory

View the amount of memory used and free RAM.

1. Go to **Settings**.
2. Touch **System > Advanced > Developer options**.
3. Touch **Memory**.

Internal Storage

The device has internal storage. The internal storage content can be viewed and files copied to and from when the device is connected to a host computer. Some applications are designed to be stored on the internal storage rather than in internal memory.

Viewing Internal Storage

View available and used internal storage on the device.

1. Go to **Settings**.
2. Touch **Storage**.

Internal Storage displays the total amount of space on internal storage and amount used.

If the device has removable storage installed, touch **Internal shared storage** to display the amount of internal storage used by apps, photos, videos, audio, and other files.

External Storage

The device can have a removable USB drive. The USB drive content can be viewed and files copied to and from when the device is connected to a host computer.

Viewing External Storage

Portable storage displays the total amount of space on the installed USB drive and the amount used.

1. Go to **Settings**.
2. Touch **Storage**.
Touch **USB Drive** to view the contents of the card.
3. To unmount the USB drive, touch .

Formatting a USB Drive as Portable Storage

Format a USB drive as portable storage on the device.

1. Touch **USB drive**.
2. Touch  > **Storage settings**.
3. Touch **Format**.
4. Touch **FORMAT USB DRIVE**.
5. Touch **DONE**.

Enterprise Folder

The Enterprise folder (within internal flash) is a super-persistent storage that is persistent after a reset and an Enterprise Reset.

The Enterprise folder is erased during a Factory Reset. The Enterprise folder is used for deployment and device-unique data. The Enterprise folder is approximately 128 MB (formatted). Applications can persist data after an Enterprise Reset by saving data to the enterprise/user folder. The folder is ext4 formatted and is only accessible from a host computer using ADB or from an MDM.

Managing Apps

Apps use two kinds of memory: storage memory and RAM. Apps use storage memory for themselves and any files, settings, and other data they use. They also use RAM when they are running.

1. Go to **Settings**.
2. Touch **Apps & notifications**.
3. Touch **See all XX apps** to view all apps on the device.
4. Touch  > **Show system** to include system processes in the list.
5. Touch an app, process, or service in the list to open a screen with details about it and, depending on the item, to change its settings, permissions, notifications and to force stop or uninstall it.



App Details

Apps have different kinds of information and controls.

- **Force stop** - Stop an app.
- **Disable** - Disable an app.
- **Uninstall** - Remove the app and all of its data and settings from the device.
- **Notifications** - Set the app notification settings.
- **Permissions** - Lists the areas on the device that the app has access to.
- **Storage & cache** - Lists how much information is stored and includes buttons for clearing it.
- **Mobile data & Wi-Fi** - Provides information about data consumed by an app.
- **Advanced**
 - **Screen time** - Displays the amount of time the app has displayed on the screen.
 - **Battery** - Lists the amount of computing power used by the app.
 - **Open by default** - If you have configured an app to launch certain file types by default, you can clear that setting here.
 - **Display over other apps** - Allows an app to display on top of other apps.
 - **App details** - Provides a link to additional app details on the Play store.
 - **Additional settings in the app** - Opens settings in the app.
 - **Modify system settings** - Allows an app to modify the system settings.

Managing Downloads

Files and apps downloaded using the Browser or Email are stored on the USB drive or Internal storage in the Download directory. Use the Downloads app to view, open, or delete downloaded items.

1. Swipe the screen up and touch .
2. Touch **Downloads**.
3. Touch and hold an item, select items to delete and touch . The item is deleted from the device.

Maintenance and Troubleshooting

This section explains how to maintain and troubleshoot the device.

Maintaining the Device

Follow these guidelines to maintain the device properly.

- To avoid scratching the screen, use a Zebra approved capacitive compatible stylus intended for use with a touch-sensitive screen. Never use an actual pen or pencil or other sharp object on the surface of the device screen.
- The touch-sensitive screen of the device is glass. Do not drop the device or subject it to strong impact.
- Protect the device from temperature extremes. Do not leave it on the dashboard of a car on a hot day, and keep it away from heat sources.
- Do not store the device in any location that is dusty, damp, or wet.
- Use a soft lens cloth to clean the device. If the surface of the device screen becomes soiled, clean it with a soft cloth moistened with an approved cleanser.
- Periodically replace the rechargeable battery to ensure maximum battery life and product performance. Battery life depends on individual usage patterns.

Battery Safety Guidelines

To use the device safely, you must follow the battery guidelines.

- The area in which the units are charged should be clear of debris and combustible materials or chemicals. Particular care should be taken where the device is charged in a non-commercial environment.
- Follow battery usage, storage, and charging guidelines found in this guide.
- Improper battery use may result in a fire, explosion, or other hazard.
- To charge the mobile device battery, the ambient battery and charger temperatures must be between 0°C and +40°C (+32°F and +104°F).
- Do not use incompatible batteries and chargers, including non-Zebra batteries and chargers. Use of an incompatible battery or charger may present a risk of fire, explosion, leakage, or other hazard. If you have any questions about the compatibility of a battery or a charger, contact the Global Customer Support Center.

- For devices that utilize a USB port as a charging source, the device shall only be connected to products that bear the USB-IF logo or have completed the USB-IF compliance program.
- Do not disassemble or open, crush, bend or deform, puncture, or shred the battery.
- Severe impact from dropping any battery-operated device on a hard surface could cause the battery to overheat.
- Do not short circuit a battery or allow metallic or conductive objects to contact the battery terminals.
- Do not modify or remanufacture, attempt to insert foreign objects into the battery, immerse or expose to water or other liquids, or expose to fire, explosion, or other hazard.
- Do not leave or store the equipment in or near areas that might get very hot, such as in a parked vehicle or near a radiator or other heat source. Do not place battery into a microwave oven or dryer.
- Battery usage by children should be supervised.
- Please follow local regulations to properly dispose of used rechargeable batteries.
- Do not dispose of batteries in fire.
- In the event of a battery leak, do not allow the liquid to come in contact with the skin or eyes. If contact has been made, wash the affected area with water for 15 minutes, and seek medical advice.
- If you suspect damage to your equipment or battery, contact Customer Support to arrange for inspection.

Best Practices for Enterprise Mobile Computing Devices Operating in Hot Environments and Direct Sunlight

Exceeding the operating temperature by external hot environments will cause the device's thermal sensor to notify the user of a shutdown of the WAN modem or shutdown the device until the device's temperature returns to the operational temperature range.

- Avoid direct sunlight to the device - The easiest way to prevent overheating is to keep the device out of direct sunlight. The device absorbs light and heat from the sun and retains it, getting hotter the longer it remains in sunlight and heat.
- Avoid leaving the device in a vehicle on a hot day or hot surface - Similar to leaving the device out in direct sunlight, the device will also absorb the thermal energy from a hot surface or when left on the dashboard of a vehicle or seat, getting warmer the longer it remains on the hot surface or inside the hot vehicle.
- Turn off unused apps on the device. Open, unused apps running in the background can cause the device to work harder, which in turn may cause it to heat up. This will also improve your mobile computer device's battery life performance.
- Avoid turning your screen brightness up - Just the same as running background apps, turning your brightness up will force your battery to work harder and create more heat. Minimizing your screen brightness may extend operating the mobile computer device in hot environments.

Cleaning Instructions



CAUTION: Always wear eye protection. Read the warning label on alcohol product before using. If you have to use any other solution for medical reasons please contact the Global Customer Support Center for more information.



WARNING: Avoid exposing this product to contact with hot oil or other flammable liquids. If such exposure occurs, unplug the device and clean the product immediately in accordance with these guidelines.

Approved Cleanser Active Ingredients

100% of the active ingredients in any cleaner must consist of one or some combination of the following: isopropyl alcohol or mild dish soap.



IMPORTANT: Use pre-moistened wipes and do not allow liquid cleaner to pool.

Approved cleaners include:

- Purell Ethanol Wipes
- 409 Glass Cleaner
- Windex Blue

Approved Cleanser Active Ingredients for Healthcare Devices

100% of the active ingredients in any cleaner must consist of one or some combination of the following: isopropyl alcohol, bleach/sodium hypochlorite¹ (see important note below), hydrogen peroxide, ammonium chloride, or mild dish soap.



IMPORTANT: Use pre-moistened wipes and do not allow liquid cleaner to pool.

Due to the powerful oxidizing nature of sodium hypochlorite, the metal surfaces on the device are prone to oxidation (corrosion) when exposed to this chemical in the liquid form (including wipes). In the event that these type of disinfectants come in contact with metal on the device, prompt removal with an alcohol-dampened cloth or cotton swab after the cleaning step is critical.

Harmful Ingredients

The following chemicals are known to damage the plastics on the device and should not come in contact with the device: acetone; ketones; ethers; aromatic and chlorinated hydrocarbons; aqueous or alcoholic alkaline solutions; ethanolamine; toluene; trichloroethylene; benzene; carbolic acid and TB-lysoform.

Many vinyl gloves contain phthalate additives, which are often not recommended for medical use and are known to be harmful to the housing of the device.

Special Cleaning Notes

Do not handle the device while wearing vinyl gloves containing phthalates. Remove vinyl gloves and wash hands to eliminate any residue left from the gloves.

If products containing any of the harmful ingredients listed above are used prior to handling the device, such as a hand sanitizer that contains ethanolamine, hands must be completely dry before handling the device to prevent damage to the device.

¹ When using sodium hypochlorite (bleach) based products, always follow the manufacturer's recommended instructions: use gloves during application and remove the residue afterwards with a damp alcohol cloth or a cotton swab to avoid prolonged skin contact while handling the device.



IMPORTANT: If the battery connectors are exposed to cleaning agents, thoroughly wipe off as much of the chemical as possible and clean with an alcohol wipe. It is also recommended to install the battery in the terminal prior to cleaning and disinfecting the device to help minimize buildup on the connectors. When using cleaning/disinfectant agents on the device, it is important to follow the directions prescribed by the cleaning/disinfectant agent manufacturer.

Cleaning Frequency

The cleaning frequency is at the customer's discretion due to the varied environments in which the mobile devices are used and may be cleaned as frequently as required. When dirt is visible, it is recommended to clean the mobile device to avoid the build-up of particles, which makes the device more difficult to clean later on.

Device Cleaning Instructions

Do not apply liquid directly to the device. Dampen a soft cloth or use pre-moistened wipes. Do not wrap the device in the cloth or wipe, instead gently wipe the unit. Be careful not to let liquid pool around the display window or other places. Before use, allow the unit to air dry.



NOTE: For thorough cleaning, it is recommended to first remove all accessory attachments, such as hand straps or cradle cups from the mobile device and to clean them separately.

Display

The display can be wiped down with an approved alcohol wipe, but care should be taken not to allow any pooling of liquid around the edges of the display. Immediately dry the display with a soft, non-abrasive cloth to prevent streaking.

Housing

Thoroughly wipe the housing, including all buttons and triggers, using an approved alcohol wipe.

Camera and Exit Window

Wipe the camera and exit window periodically with lens tissue or other material suitable for cleaning optical material such as eyeglasses.

Cleaning Cradle Connectors

1. Remove the DC power cable from the cradle.
2. Dip the cotton portion of the cotton-tipped applicator in isopropyl alcohol.
3. Rub the cotton portion of the cotton-tipped applicator along the pins of the connector. Slowly move the applicator back and forth from one side of the connector to the other. Do not leave any cotton residue on the connector.
4. All sides of the connector should also be rubbed with the cotton-tipped applicator.
5. Remove any lint left by the cotton-tipped applicator.
6. If grease and other dirt can be found on other areas of the cradle, use a lint-free cloth and alcohol to remove.

7. Allow at least 10 to 30 minutes (depending on ambient temperature and humidity) for the alcohol to air dry before applying power to cradle.

If the temperature is low and humidity is high, longer drying time is required. Warm temperature and low humidity requires less drying time.



CAUTION: After cleaning the cradle connectors with bleach-based chemicals, follow the Cleaning Cradle Connectors instructions to remove bleach from the connectors.

Troubleshooting

In rare circumstances, to troubleshoot the device, you may need to reset the device.

Resetting the Device

There are two reset functions, soft reset and hard reset.

Performing a Soft Reset

Perform a soft reset if applications stop responding.

1. Press and hold **Power** until the menu appears.
2. Touch **Restart**.

The device reboots.

Performing a Hard Reset

Perform a hard reset if the device stops responding.



CAUTION: Performing a hard reset with a microSD card installed in the device may cause damage or data corruption to the microSD card. All un-saved data is lost after performing a hard reset.

1. Press and hold the Power, Volume Up, and top Scan buttons.
2. When the screen turns off, release the buttons.

The device reboots.

Troubleshooting the Device

This section provides troubleshooting options for the device.

Table 27 Troubleshooting the Device

Problem	Cause	Solution
After installing the battery, the device does not boot up.	Power button was not pressed.	Press the Power button.

Table 27 Troubleshooting the Device (Continued)

Problem	Cause	Solution
When pressing the power button the device does not turn on.	Battery not charged.	Charge or replace the battery in the device.
	Battery not installed properly.	Install the battery properly.
	System crash.	Perform a hard reset.
When pressing the power button the device does not turn on but two LEDs blink.	Battery charge is at a level where data is maintained but battery should be re-charged.	Charge or replace the battery in the device.
Battery did not charge.	Battery failed.	Replace battery. If the device still does not operate, perform a hard reset.
	Device removed from cradle while battery was charging.	Insert the tablet into the cradle and begin charging.
	Extreme battery temperature.	The ambient temperature must be between 0°C and 40°C (32 °F and 104°F).
Cannot see characters on display.	Device not powered on.	Press the Power button.
During data communication with a host computer, no data transmitted, or transmitted data was incomplete.	Device removed from cradle or disconnected from host computer during communication.	Replace the device in the cradle, or reattach the communication cable and re-transmit.
	Incorrect cable configuration.	See the system administrator.
	Communication software was incorrectly installed or configured.	Perform setup.
During data communication over Wi-Fi, no data transmitted, or transmitted data was incomplete.	Wi-Fi radio is not on.	Turn on the Wi-Fi radio.
	You moved out of range of an access point.	Move closer to an access point.
During data communication over Bluetooth, no data transmitted, or transmitted data was incomplete.	Bluetooth radio is not on.	Turn on the Bluetooth radio.
	You moved out of range of another Bluetooth device.	Move within 10 meters (32.8 feet) of the other device.
During data communication over mobile data, no data transmitted, or transmitted data was incomplete.	Mobile data is not on.	Turn on mobile data. If it is already on, turn it off and on again.
	You moved out of the coverage area.	Move into a coverage area.
No sound.	Volume setting is low or turned off.	Adjust the volume.

Table 27 Troubleshooting the Device (Continued)

Problem	Cause	Solution
Device shuts off.	Device is inactive.	The display turns off after a period of inactivity. Set this period to 15 seconds, 30 seconds, 1, 2, 5, 10 or 30 minutes.
	Battery is depleted.	Replace the battery.
The multi-touch screen responds slowly or improperly.	Finger or screen is wet.	Ensure that your hands are clean and dry when touching the screen. Restart the tablet to try again.
A message appears stating that the device memory is full.	Too many files stored on the device.	Delete unused files. If necessary, save the files on a host computer.
	Too many applications installed on the device.	Remove user-installed applications on the device to recover memory. Select Settings > Apps & notifications . Select the app in the list and select UNINSTALL .
The device does not decode with reading bar code.	Scanning application is not loaded.	Load a scanning application on the device or enable DataWedge. See the system administrator.
	Unreadable bar code.	Ensure the symbol is not defaced.
	Distance between exit window and bar code is incorrect.	Place the device within proper scanning range.
	Device is not programmed for the bar code.	Program the device to accept the type of bar code being scanned. Refer to the EMDK or DataWedge application.
	Device is not programmed to generate a beep.	If the device does not beep on a good decode, set the application to generate a beep on good decode.
	Battery is low.	If the scanner stops emitting a laser beam upon a trigger press, check the battery level. When the battery is low, the scanner shuts off before the device low battery condition notification. Note: If the scanner is still not reading symbols, contact the distributor or the Global Customer Support Center.
Device cannot find any Bluetooth devices nearby.	Too far from other Bluetooth devices.	Move closer to the other Bluetooth device(s), within a range of 10 meters (32.8 feet).
	The Bluetooth device(s) nearby are not turned on.	Turn on the Bluetooth device(s) to find.
	The Bluetooth device(s) are not in discoverable mode.	Set the Bluetooth device(s) to discoverable mode. If needed, refer to the device's user documentation for help.
Cannot unlock device.	User enters incorrect password.	If the user enters an incorrect password five times, the user is requested to wait for 30 seconds when using a PIN, Pattern or Password.
Multi-User mode is causing undefined behavior.	Multi-User mode is not supported by the Mobility DNA Enterprise License.	Perform a soft or hard reset on the device.

Charge Only Cradle

This section provides troubleshooting options for charge only cradles.

Table 28 Troubleshooting the Charge only Cradle

Symptom	Possible Cause	Solution
Battery is not charging.	Tablet was removed from cradle or cradle was unplugged from AC power.	Ensure cradle is receiving power. Ensure tablet is seated correctly. Confirm main battery is charging. The battery fully charges in approximately four hours.
	Battery is faulty.	Verify that other batteries charge properly. If so, replace the faulty battery.
	The tablet is not fully seated in the cradle.	Remove and re-insert the tablet into the cradle, ensuring it is firmly seated.
	Ambient temperature of the cradle is too warm or too cold.	Move the cradle to an area where the ambient temperature is between 0°C and 40°C (32°F and 104°F).

4-Slot Battery Charger

This section provides troubleshooting options for the 4-Slot Battery Charger.

Table 29 Troubleshooting the 4-Slot Battery Charger

Symptom	Possible Cause	Solution
Power Pack Charging LED does not light when inserted.	Power Pack is not correctly seated.	Remove and re-insert the spare battery into the charging slot, ensuring it is correctly seated.
Power Pack is not charging.	Power Pack was removed from charger or charger was unplugged from AC power.	Ensure charger is receiving power. Ensure Power Pack is seated correctly. Confirm Power Pack is charging. The Power Pack fully charges in approximately four hours.
	Power Pack is faulty.	Verify that other Power Pack charge properly. If so, replace the faulty Power Pack.
	The Power Pack is not fully seated in the charger.	Remove and re-insert the Power Pack into the charger, ensuring it is firmly seated.
	Ambient temperature of the charger is too warm or too cold.	Move the charger to an area where the ambient temperature is between 0°C and 40°C (32°F and 104°F).

Technical Specifications

For device technical specifications, go to zebra.com/support.

SE4100 Decode Distances

The table below lists the typical distances for selected bar code densities. The minimum element width (or “symbol density”) is the width in mils of the narrowest element (bar or space) in the symbol.

Table 30 SE4100 Decode Distances

Symbol Density/ Bar Code Type	Typical Working Ranges	
	Near	Far
5 mil Code 39	6.1 cm (2.4 in.)	24.1 cm (9.5 in.)
5 mil Code 128	7.1 cm (2.8 in.)	22.9 cm (9.0 in.)
6.67 mil PDF417	6.1 cm (2.4 in.)	20.3 cm (8.0 in.)
10 mil Data Matrix	7.4 cm (2.9 in.)	22.9 cm (9.0 in.)
100% UPCA	4.6 cm (1.8 in.)*	49.5 cm (19.5 in.)
15 mil QR Code	3.05 cm (1.2 in.)*	30.5 cm (12.0 in.)
20 mil QR Code	3.05 cm (1.2 in.)*	35.6 cm (14.0 in.)
20 mil Code 39	5.08 cm (2.0 in.)*	66.0 cm (26.0 in.)

*Limited by width of bar code in field of view. Notes: Photographic quality bar code at 15° tilt pitch angle under 30 fcd ambient illumination. Distances measured from front edge of scan engine chassis.

SE4710 Decode Distances

The following table provides the decode distances for the SE4710 scan engine.

Table 31 SE4710 Decode Distances

Symbol Density/ Bar Code Type	Typical Working Ranges	
	Near	Far
4 mil Code 39	8.4 cm (3.3 in.)	22.4 cm (8.8 in.)

Table 31 SE4710 Decode Distances (Continued)

Symbol Density/ Bar Code Type	Typical Working Ranges	
	Near	Far
5.0 mil Code 128	7.1 cm (2.8 in.)	20.8 cm (8.2 in.)
5 mil Code 39	5.08 cm (2.0 in.)	34.3 cm (13.5 in.)
5 mil PDF417	8.5 cm (3.35 in.)	21.3 cm (8.4 in.)
10 mil Data Matrix	7.4 cm (2.9 in.)	25.7 cm (10.1 in.)
100% UPCA	4.6 cm* (1.8 in.)	66.0 cm (26.0 in.)
20 mil Code 39	5.08 cm* (2.0 in.)	76.2 cm (30.0 in.)
20 mil QR Code	8.1 cm (3.2 in.)	40.1 cm (15.8 in.)
*Limited by width of bar code in field of view. Notes: Photographic quality bar code at 15° tilt pitch angle under 30 fcd ambient illumination. Distances measured from front edge of scan engine chassis.		

SE4720 Decode Distances

The following table provides the decode distances for the SE4720 scan engine.

Table 32 SE4720 Decode Distances

Symbol Density/ Bar Code Type	Typical Working Ranges	
	Near	Far
4 mil Code 39	8.4 cm (3.3 in.)	22.4 cm (8.8 in.)
5.0 mil Code 128	7.1 cm (2.8 in.)	20.8 cm (8.2 in.)
5 mil Code 39	5.08 cm (2.0 in.)	34.3 cm (13.5 in.)
5 mil PDF417	7.9 cm (3.1 in.)	21.3 cm (8.4 in.)
10 mil Data Matrix	7.4 cm (2.9 in.)	25.7 cm (10.1 in.)
100% UPCA	4.6 cm* (1.8 in.)	66.0 cm (26.0 in.)
20 mil Code 39	5.08 cm* (2.0 in.)	76.2 cm (30.0 in.)
20 mil QR Code	8.1 cm (3.2 in.)	40.1 cm (15.8 in.)
*Limited by width of bar code in field of view. Notes: Photographic quality bar code at 15° tilt pitch angle under 30 fcd ambient illumination. Distances measured from front edge of scan engine chassis.		

SE5500 Decode Distances

The following table provides the decode distances for the SE5500 scan engine.

Table 33 SE5500 Decode Distances

Symbol Density/ Bar Code Type	Typical Working Ranges	
	Near	Far
3 mil Code 39	6.9 cm (2.7 in.)	41 cm (16.2 in.)
5 mil Code 39	6.35 cm (2.5 in.)	68 cm (26.6 in.)
5 mil PDF417	10.8 cm (4.25 in.)	47.8 cm (19.6 in.)
6.67 mil PDF417	6.6 cm* (2.6 in.)	65 cm* (25.6 in.)
80% UPCA	5 cm* (2 in.)	136 cm* (53.6 in.)
100% UPCA	6.4 cm* (2.5 in.)	170 cm (67 in.)
10 mil Data Matrix	6.4 cm (2.5 in.)	68.8 cm (27.1 in.)
15 mil Code 128	*	182.8 cm* (72 in.)
20 mil Code 39	*	276.9 cm* (109 in.)
55 mil Code 39	*	744 cm* (293 in.)
100 mil Code 39	*	1351 cm (532 in.)
15 mil Code 128 (4 in. wide)	18.2 cm (7.2 in.)	182 cm (72 in.)

*Limited by width of bar code in field of view.
 Notes: Photographic quality bar code at 15° tilt pitch angle under 30 fcd ambient illumination.
 Distances measured from front edge of scan engine chassis.

1-Slot Charge Only Cradle Specifications

This section provides specification information on the 1-Slot Charge Only Cradle.

Table 34 1-Slot Charge Only Cradle

Feature	Description
Dimensions	Height: 10.5 cm (4.1 in.) Width: 18.3 cm (7.2 in.) Depth: 24.5 cm (9.6 in.)
Weight	659 g (23.2 oz)
Input Voltage	12 VDC
Power Consumption	18 watts
Operating Temperature	0°C (32°F) to +50°C (+122°F)
Storage Temperature	-40°C (-40°F) to +70°C (+158°F)
Charging Temperature	0°C to 40°C (32°F to 104°F)
Humidity	5% to 95% non-condensing
Drop	75 cm (30 in.) to concrete, 2 drops per side for a total 12 drops at room temperature 23°C (73.4°F).

Table 34 1-Slot Charge Only Cradle (Continued)

Feature	Description
Electrostatic Discharge (ESD)	+/- 20 kV air +/- 10 kV contact

4-Slot Charge Only Cradle Specifications

This section provides specification information on the 4-Slot Charge Only Cradle with Battery Charger.

Table 35 Charge Only Cradle

Feature	Description
Dimensions	Height: 15.6 cm (6.1 in.) Width: 21.6 cm (8.5 in.) Depth: 52.4 cm (20.6 in.)
Weight	3133 g (110.5 oz)
Input Voltage	12 VDC
Power Consumption	100 watts (including the 4-Slot Battery Charger)
Operating Temperature	0°C (32°F) to +50°C (+122°F)
Storage Temperature	-40°C (-40°F) to +70°C (+158°F)
Charging Temperature	0°C to 40°C (32°F to 104°F)
Humidity	5% to 95% non-condensing
Drop	75 cm (30 in.) to concrete, 2 drops per side for a total 12 drops at room temperature 23°C (73.4°F).
Electrostatic Discharge (ESD)	+/- 20 kV air +/- 10 kV contact

8 in. Expansion Back Specifications

This section provides specification information on the 8 in. Expansion Back.

Table 36 8 in. Expansion Back

Feature	Description
Dimensions	Height: 104.6 mm (41.2 in.) Width: 151.4 mm (59.6 in.) Depth: 50.8 mm (20 in.)
Weight	Without power pack: 167 g (5.9 oz) With power pack: 334 g (11.8 oz)

Table 36 8 in. Expansion Back (Continued)

Feature	Description
Operating Temperature	0°C to 50°C (32°F to 122°F)
Storage Temperature	-20°C to 60°C (-40°F to 158°F)
Humidity	5% to 95% non-condensing
Drop	1.0 m (3.28 ft) drop to plywood over concrete per MIL-STD 810G across operating temperatures without rugged frame. 1.2 m (4 ft) drop to plywood over concrete per MIL-STD 810G across operating temperatures with rugged frame.
Electrostatic Discharge (ESD)	+/- 8 kV air +/- 4 kV contact

10 in. Expansion Back Specifications

This section provides specification information on the 10 in. Expansion Back.

Table 37 10 in. Expansion Back

Feature	Description
Dimensions	Height: 124.9 mm (4.9 in.) Width: 168.2 mm (6.6 in.) Depth: 52.3 mm (2.1 in.)
Weight	Without power pack: 183 g (6.5 oz) With power pack: 350 g (12.3 oz)
Operating Temperature	0°C to 50°C (32°F to 122°F)
Storage Temperature	-20°C to 60°C (-40°F to 158°F)
Humidity	5% to 95% non-condensing
Drop	1.0 m (3.28 ft) drop to plywood over concrete per MIL-STD 810G across operating temperatures without rugged frame. 1.2 m (4 ft) drop to plywood over concrete per MIL-STD 810G across operating temperatures with rugged frame.
Electrostatic Discharge (ESD)	+/- 8 kV air +/- 4 kV contact

