

LDM216-251

All-in-one Direct View LED Display

Quick Start Guide

快速安装说明

快速入門指南

Guide de démarrage rapide

Schnellstartanleitung

Guía rápida de inicio

Hızlı Başlangıç Kılavuzu





Aan de slag

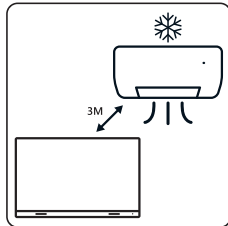
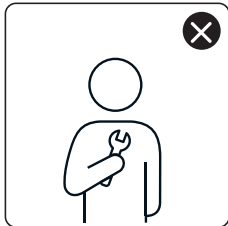
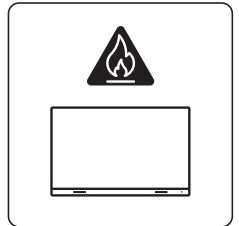
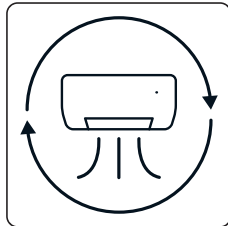
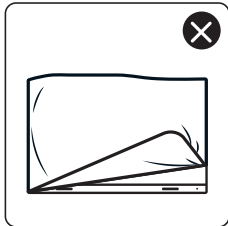
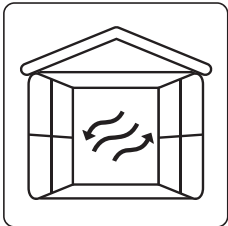
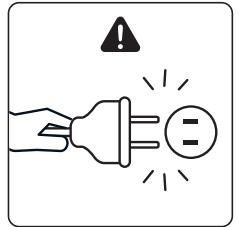
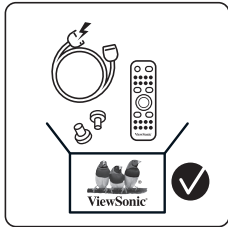
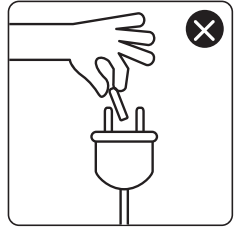
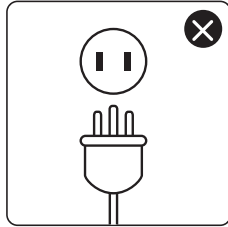
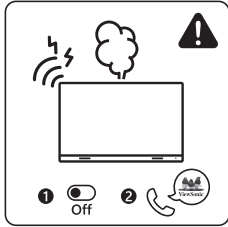
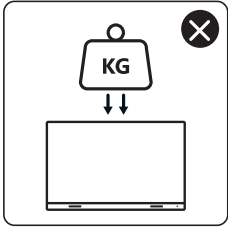
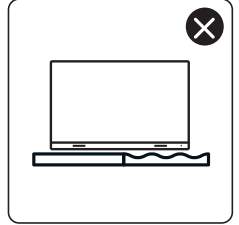
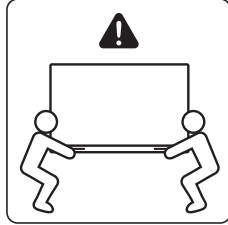
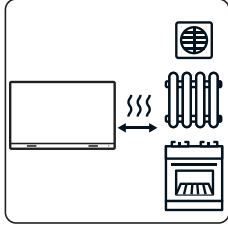
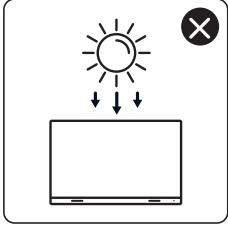
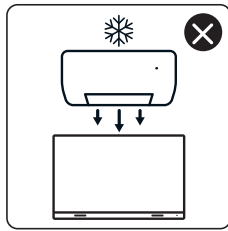
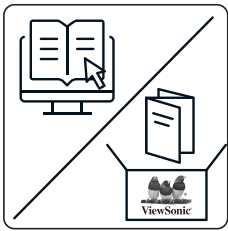

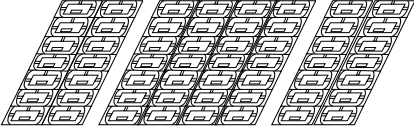
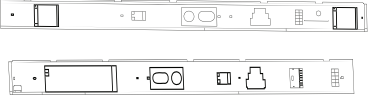
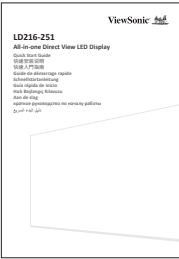
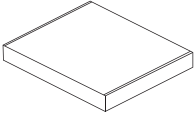

краткое руководство по началу работы

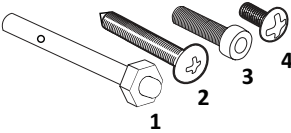
دليل البدء السريع

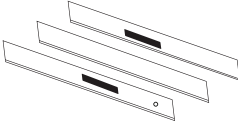

Package Contents

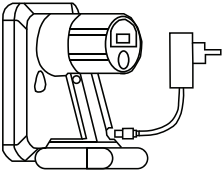
	Item	Quantity	Note
Cabinet Sections		8 sections total	
System Control Box (Left and Right sides)		2 sides	
Quick Start Guide		1	
LED Modules		128 modules	The quantity of spare LED modules will vary by country.
Remote Control		1	
Screws			48 x M6x50mm Expansion (1) 48 x TA6x30mm (2) 32 x M6x16mm (3) 18 x KM3x6mm (4)
Hex Tool (Allen wrench)		2	1 x 5 mm 1 x 8 mm

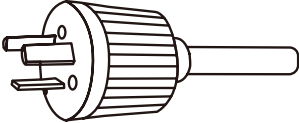
Item	Quantity	Note
System Control Box Covers (Left, Middle, and Right sides)		3
Wall Mounting Brackets		4
Vacuum Suction Tool		1
Anti-Static Gloves		2 pairs
USB-A to USB-B Cable (5m)		1
Power Cord		2 Power consumption is large, so two power cords and two dedicated power outlets are required.

NOTE:

- This product is packed in an air transport box.
- Due to the size and weight, it is recommended that two or more people handle it.

Product Overview

Front Panel

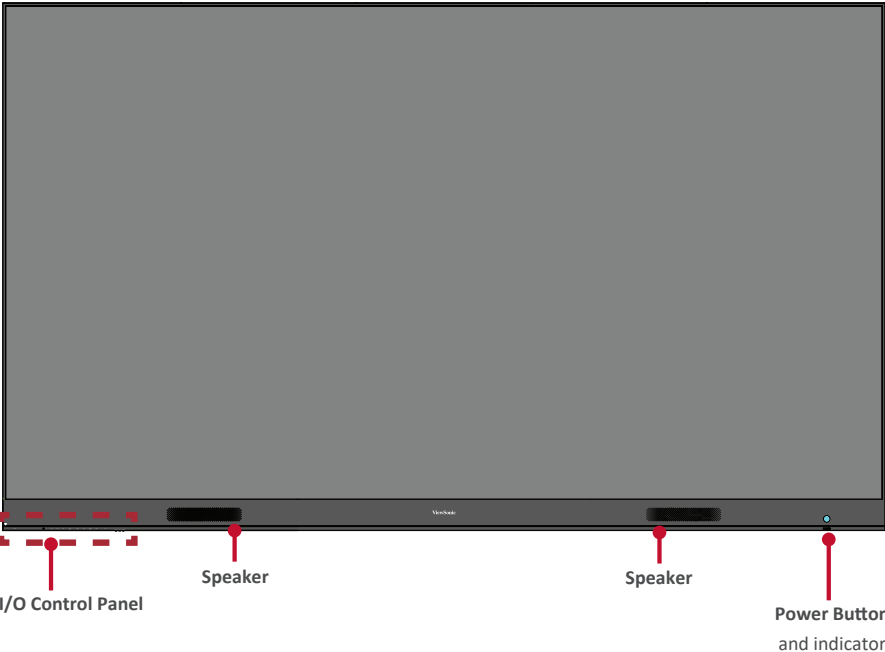

Rear Panel

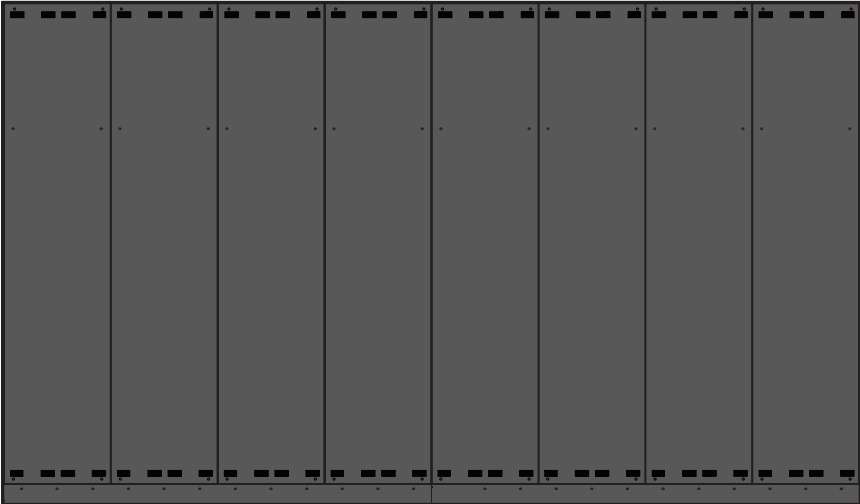

Introduction

Before Installing

- ! Maintain an adequate air gap between the back of the display and any wall for proper ventilation.
- ! Ensure there is no direct airflow from air conditioning or heating vents blowing on the display.
- ! Avoid installing the display in places with high humidity.
- ! Due to high power usage, always use power cords specifically designed for this product.

Wall Mounting

Installing the Upper and Lower Wall Mount Brackets

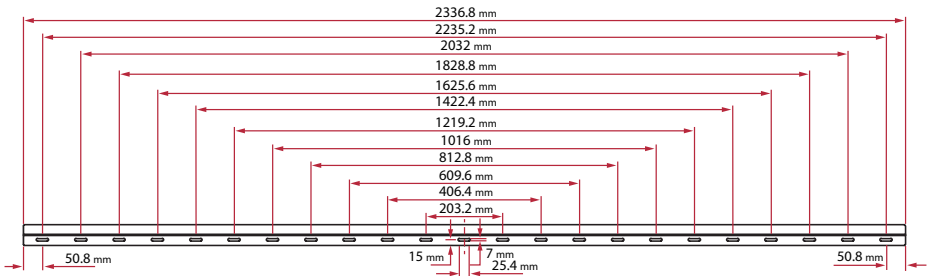

1. Ensure the wall area and size is an appropriate installation site.
NOTE: The height of the Upper Wall Mount Brackets must not be less than 129.92" (3.3 meters) from the ground.
2. Using the *Wall Mount Bracket* (pictured above) as a guide, mark at least twelve (12) holes and pre-drill them.
3. Install the first Upper *Wall Mount Bracket* with the provided screws (M6x50mm Expansion for masonry; TA6x30mm for load bearing wood).
4. Repeat **Step 2**, ensuring the second Upper *Wall Mount Bracket* is level with the first upper bracket.



5. Install the Lower *Wall Mount Brackets* in the same manner as the Upper *Wall Mount Brackets*. The distance between the Upper and Lower *Wall Mount Brackets* is 103.94" (2640 mm).

NOTE: You can also install the Upper *Wall Mount Brackets*, hang the screen, and then install the Lower *Wall Mount Brackets* for a more precise fit.

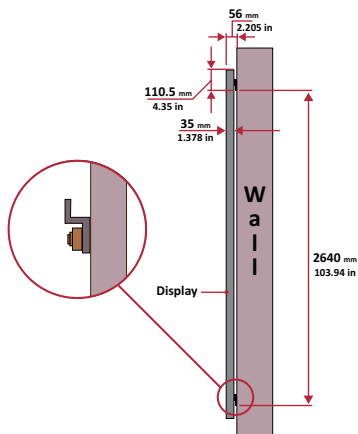

- ❗ Ensure the wall can safely support 749.57 lbs. (340 kg).
 - ❗ Ensure the deviation of wall surface must be <5mm (0.197 inches).
6. After installing both Upper and Lower *Wall Mount Brackets*, the installation wall should look like:

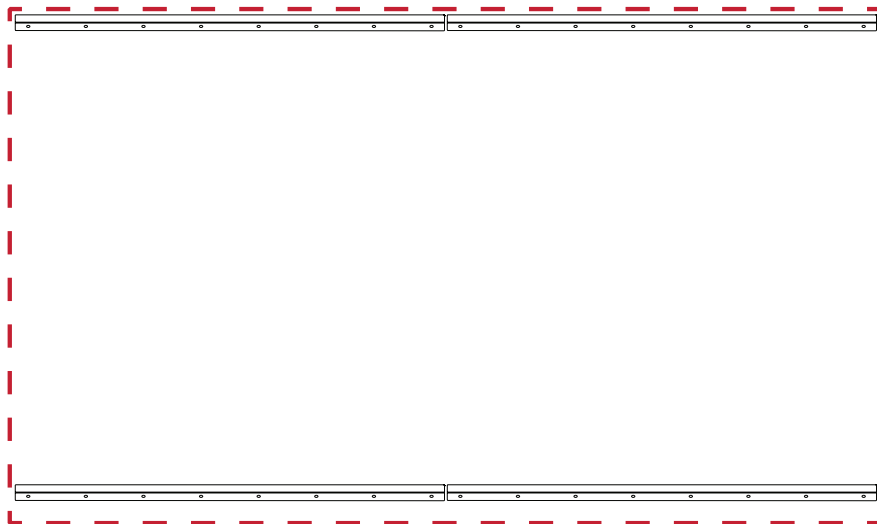

Installing the Middle Cabinets

1. Ensure the *Mounting Brackets* on the rear of the six (6) Middle Cabinets are positioned at the top and bottom mounting positions as shown below:

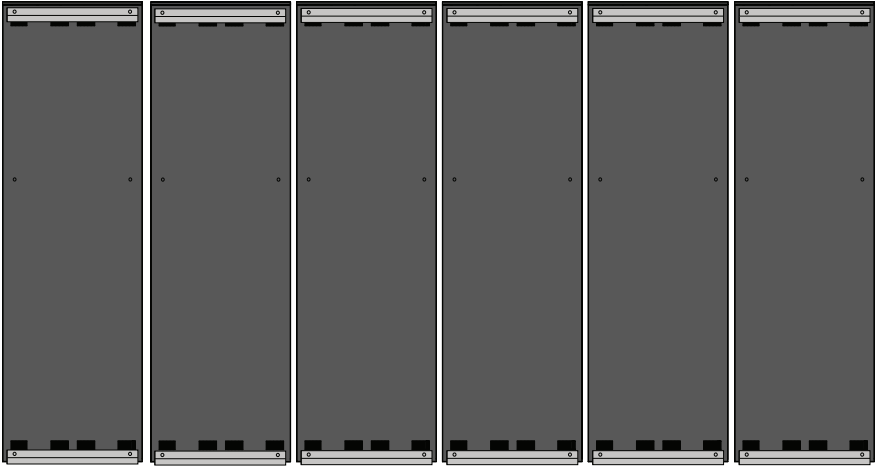

2. Carefully lift each *Middle Cabinet* up onto the *Upper Wall Mount Brackets*.

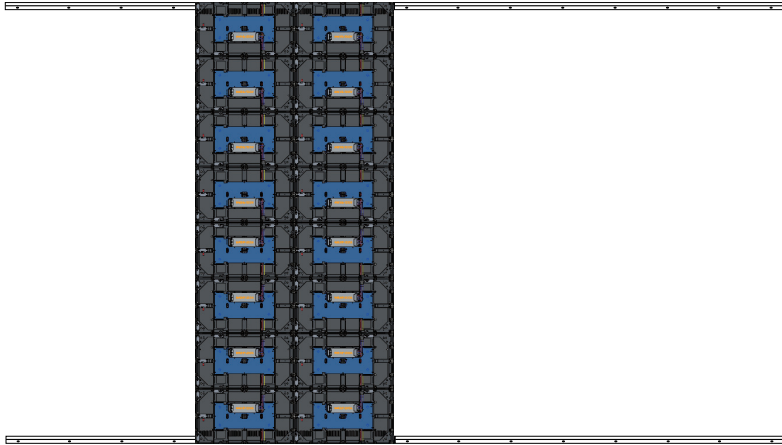

3. Ensure the *Mounting Brackets* sit securely on the *Wall Mount Brackets* as shown below.

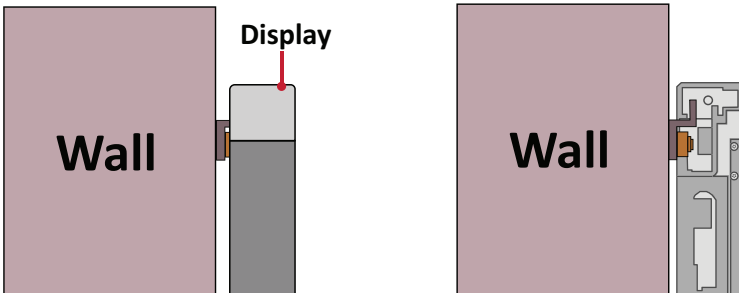

4. Push each *Locking Bolt* and lock each *Hook* with the hex tool to securely connect each cabinet together. It may be necessary to align the hole with an Allen wrench in order to engage the *Locking Bolt*.

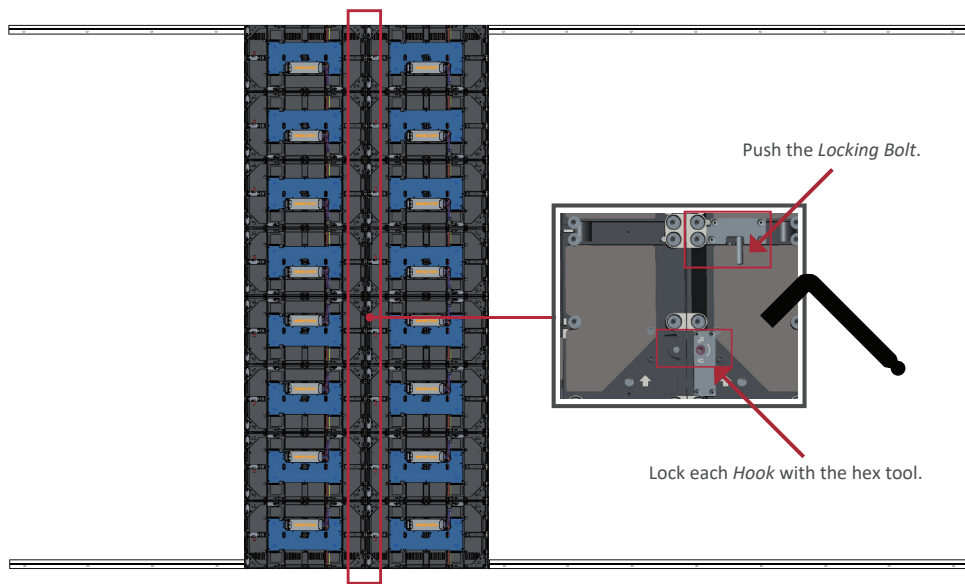

NOTE: There are eight (8) Locking Bolts and 16 Hooks between each cabinet.

5. Lift the remaining *Middle Cabinet* up onto the *Upper Wall Mount Brackets*, ensuring the *Mounting Brackets* sit securely on the *Wall Mount Brackets*.
6. Repeat Step 4, securing the cabinets together with each *Locking Bolt* and Hook.

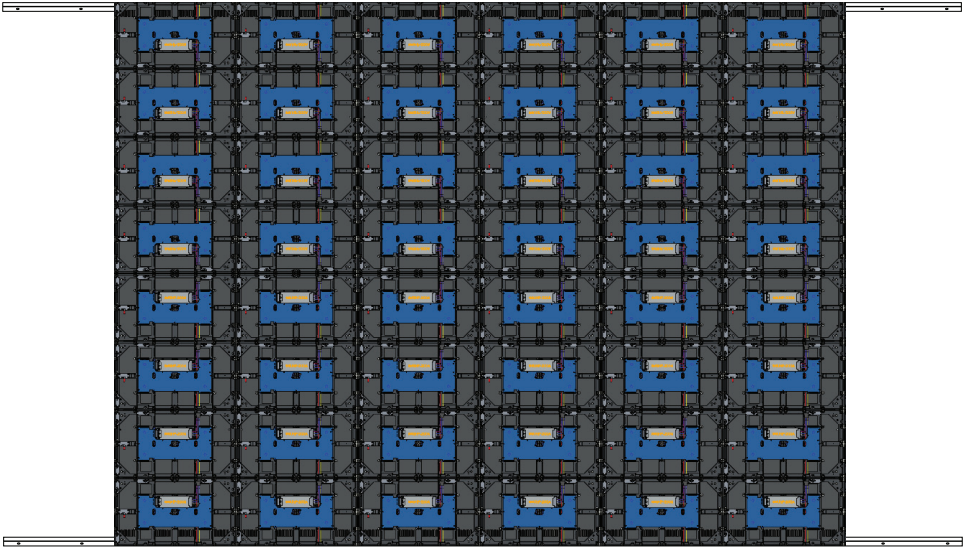

Installing the Left and Right Cabinet

1. Ensure the *Mounting Brackets* on the rear of the *Left* and *Right Cabinet* are positioned at the top and bottom mounting positions as shown below:

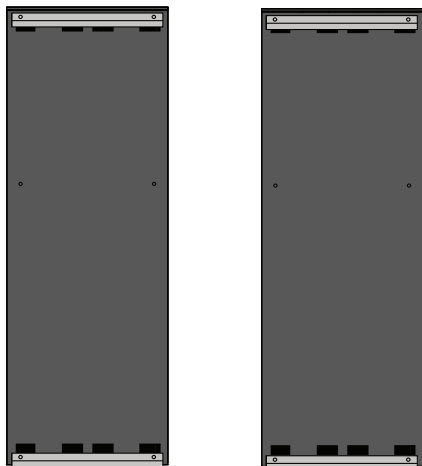

2. Carefully lift the *Left* and *Right Cabinet* up onto the *Upper Wall Mount Brackets*, ensuring the *Mounting Brackets* sit securely on the *Wall Mount Brackets*.



3. Adjust the *Left* or *Right Cabinet* so that they fit seamlessly with the *Middle Cabinets*.

4. Push each *Locking Bolt* and lock each *Hook* with the hex tool to securely connect the *Left* and *Right Cabinets*. It may be necessary to align the hole with an Allen wrench in order to engage the *Locking Bolt*.

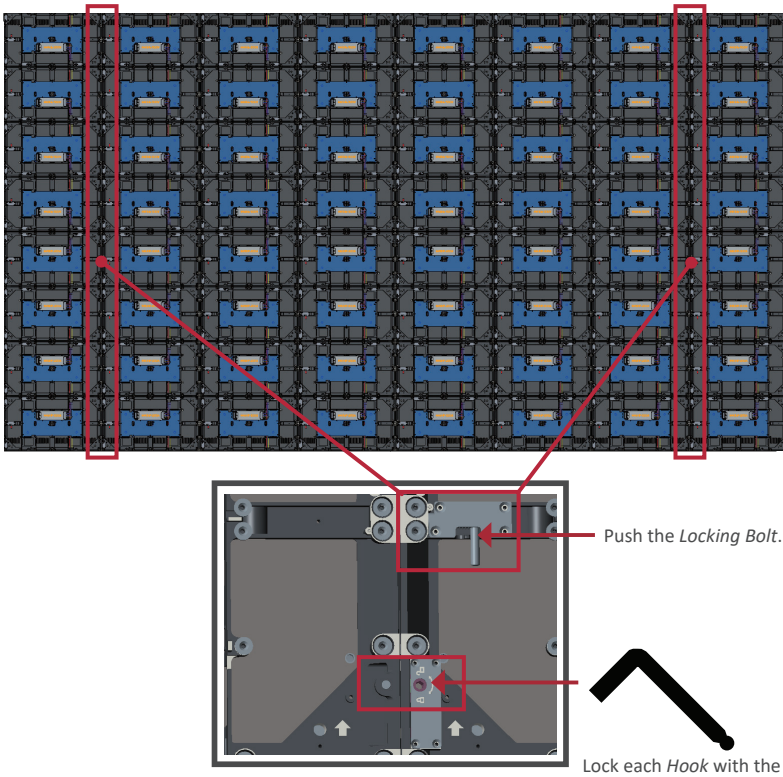

NOTE: There are eight (8) Locking Bolts and 16 Hooks between each cabinet.

Connecting the System Control Box

1. Carefully unfold the *System Control Box* panel. Ensure the main system control board is on the left.
NOTE: Use caution as the *System Control Box* panel is separated into two pieces with wires attached.
2. Align the holes of the *Cabinet* with the *System Control Box* to attach.

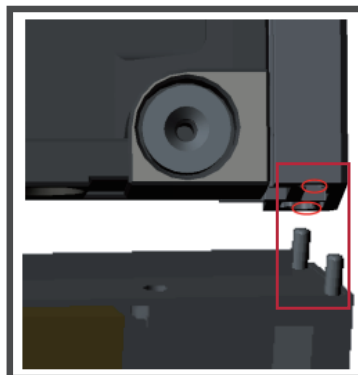
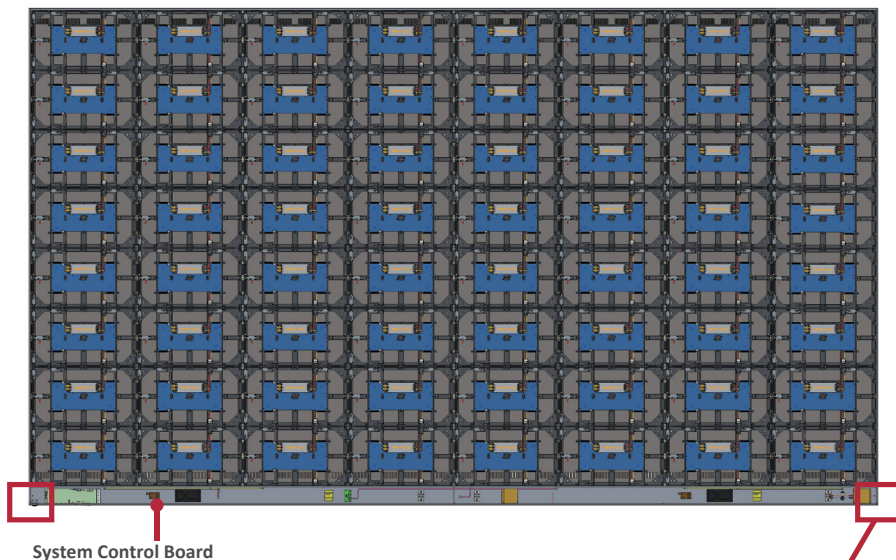

3. You can also reinstall the power cable for an attractive appearance, Loosen the three(3) PWM 4x6mm screws, pull the power cable out,thread the power cable through the back hole and then fasten the screws tightly.

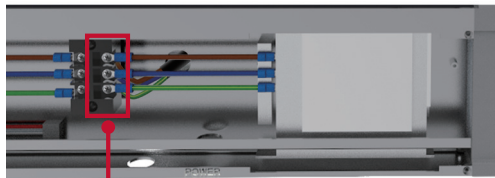
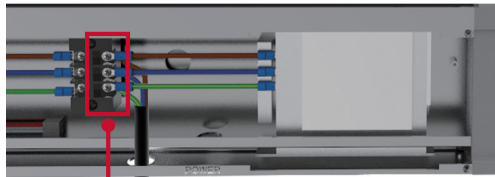
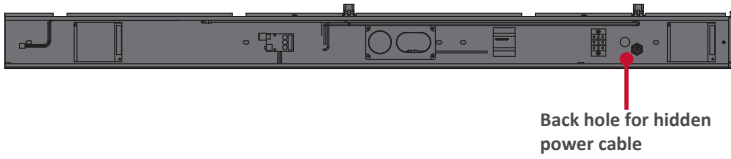

! Operating by professional only.

- Further secure the *System Control Box* to the *Cabinets* with the 32 provided M6x16mm screws.

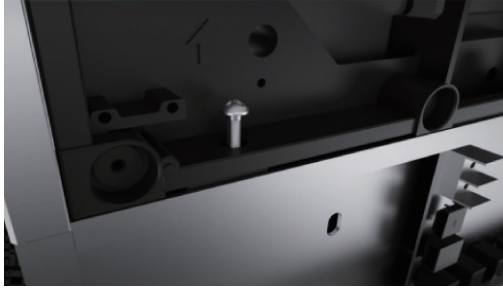

- Connect the Network and Power cables of the *Cabinets* to the *System Control Box*.

NOTE: There are four (4) Network and eight (8) Power cables to connect.

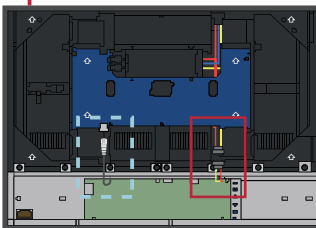
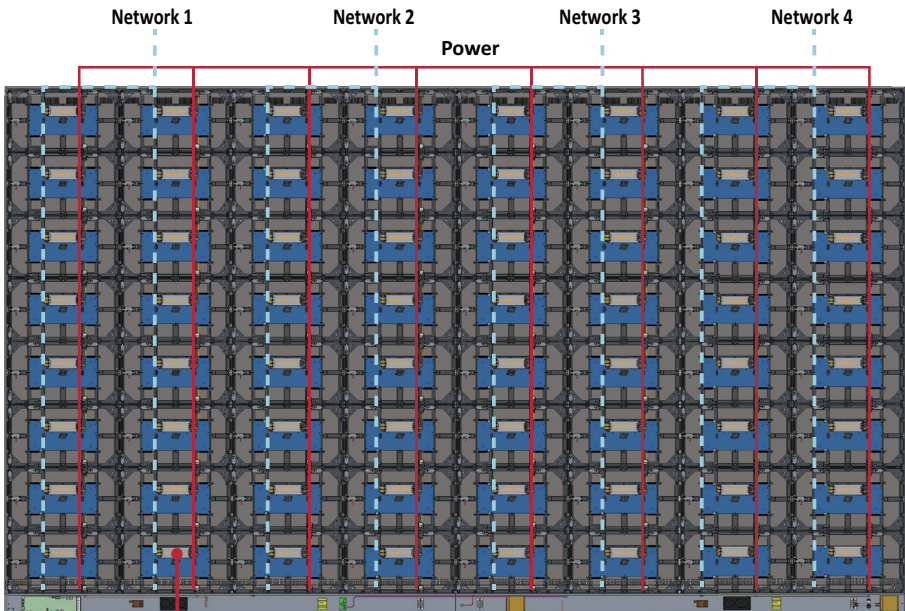

Installing the LED Modules

Install each *LED Module* onto the *Cabinets*, being sure to match the corresponding numbers on the *Module* to the *Cabinet*.

! Please wear Anti-Static Gloves before handling the LED modules.



Ensure each *Module* is flush and that there is little to no gap between each. It may be necessary to gently tap the module to make it flush.

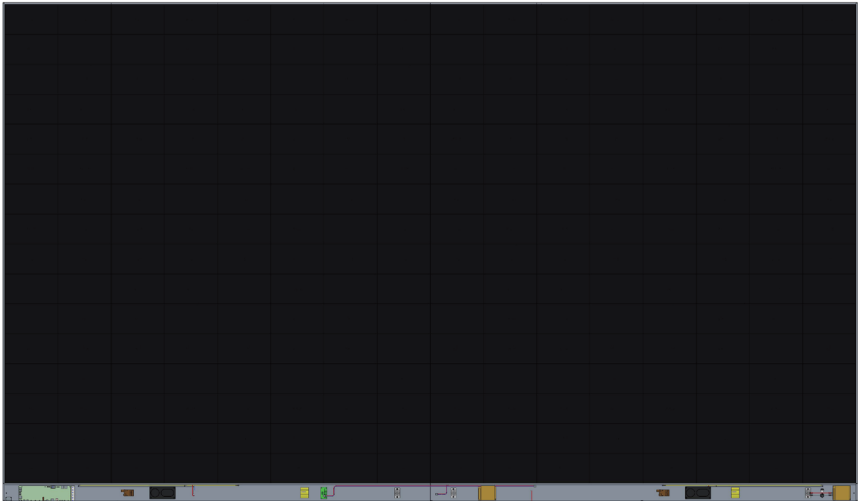

Installing System Control Box Covers

There are three (3) System Control Box Covers: Left, Middle, and Right.



1. Begin by installing the *Right Cover* onto the *System Control Box*.

NOTE: Ensure the **Power Button** cable is connected to the *System Control Box* Power cable before securing the *Cover*.

2. After connecting the **Power Button** cable, ensure the *Right Cover* is properly aligned with the *System Control Box*; then secure it with the 18 provided KM3x6mm screws.

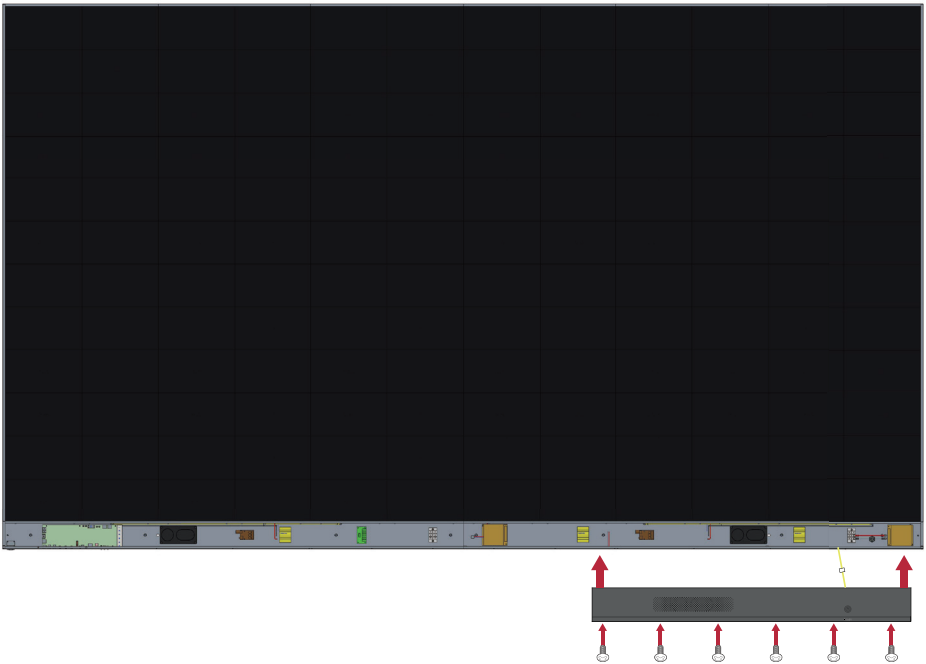

3. Repeat the above steps for the *Middle* and *Left Cover*.





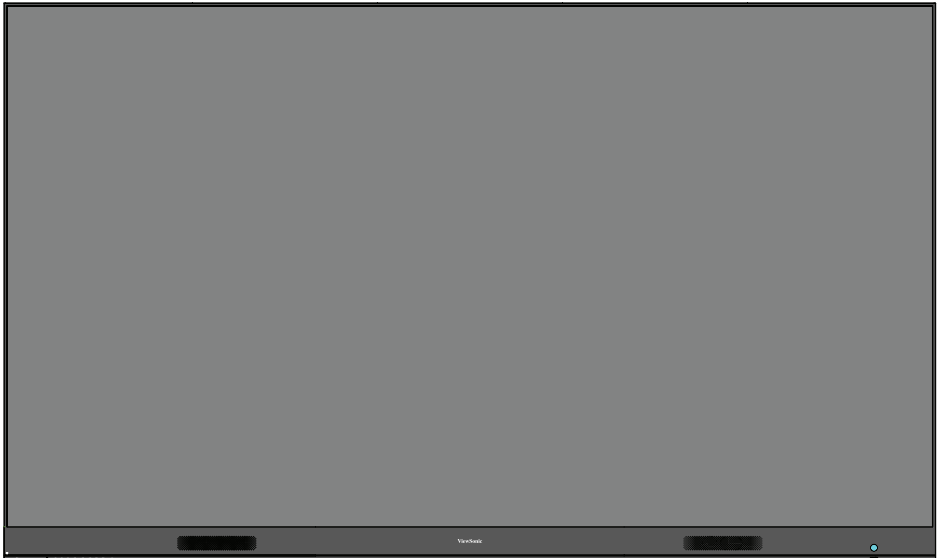

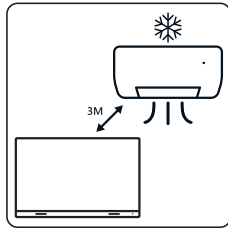
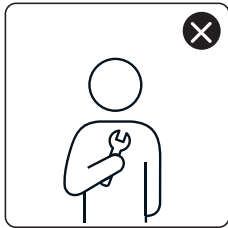
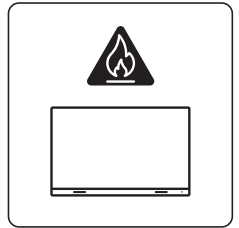
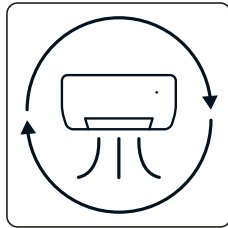
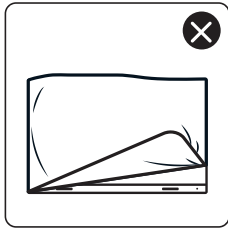
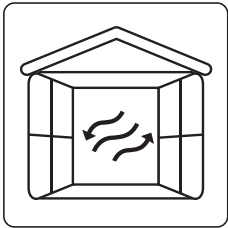
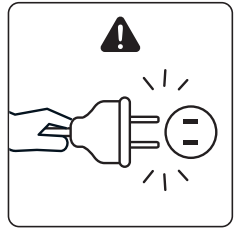
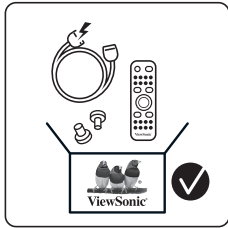
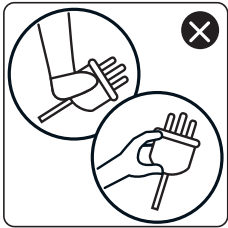
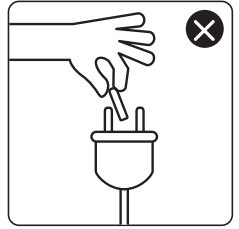
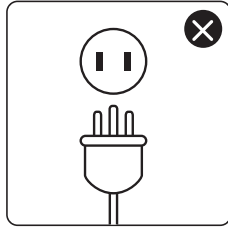
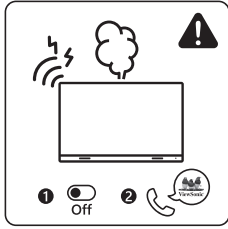
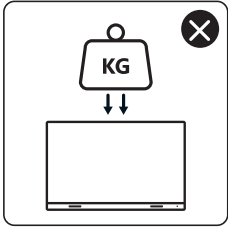
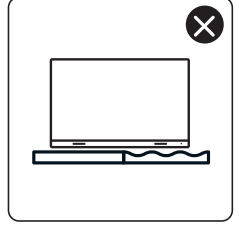
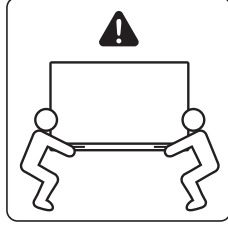
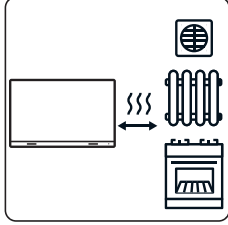
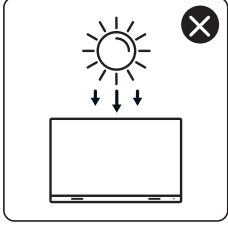
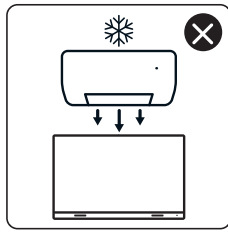
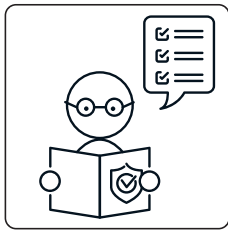
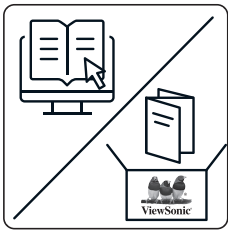
4. Your display is now ready to power on.



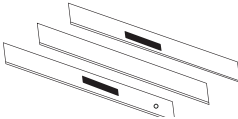

包裝內容物

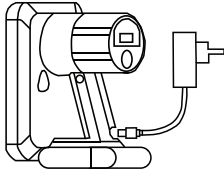
項目	數量	注意
機櫃部分		共 8 個部分
系統控制箱 (左右兩側)		2 側
快速入門手冊		1
LED 模組		128 個模組 備用 LED 模組的數量，因國家而異。
遙控器		1
螺絲		48 x M6x50mm 膨脹螺絲 (1) 48 x TA6x30mm (2) 32 x M6x16mm (3) 18 x KM3x6mm (4)
六角工具 (內六角扳手)		2 1 x 5 mm 1 x 8 mm

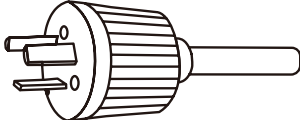
項目		數量	注意
系統控制箱 護蓋 (左側、中 間、右側)		3	
壁掛架		4	
真空抽吸工具		1	
防靜電手套		2 對	
USB-A 轉 USB-B 纜線 (5m)		1	
電源線		2	耗電量大，因 此需要兩條電 源線與兩個專 屬電源插座。

備註：

- 本產品包裝在空運箱中。
- 由於尺寸和重量，建議由多人搬運。

產品概述

前面板

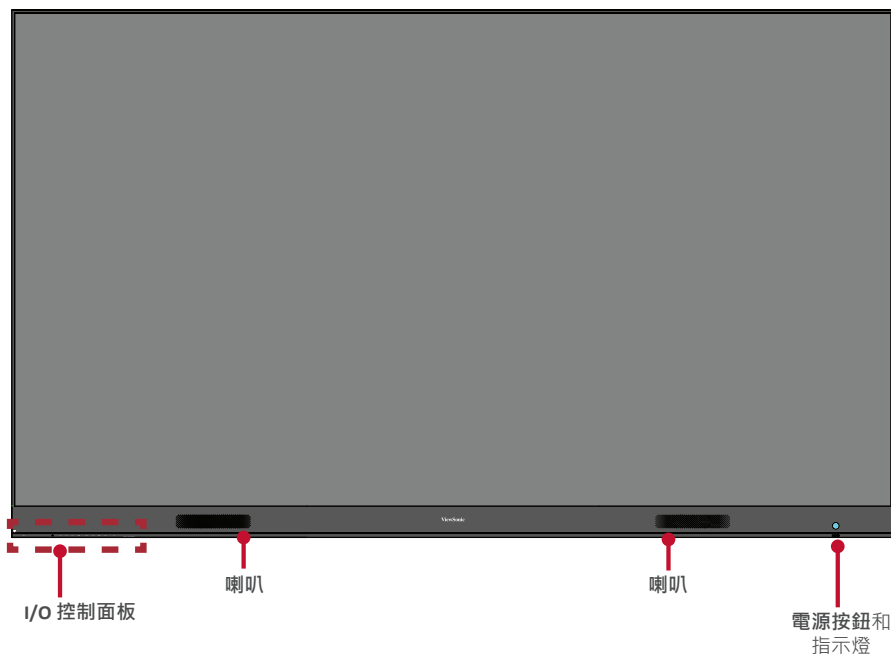

後面板

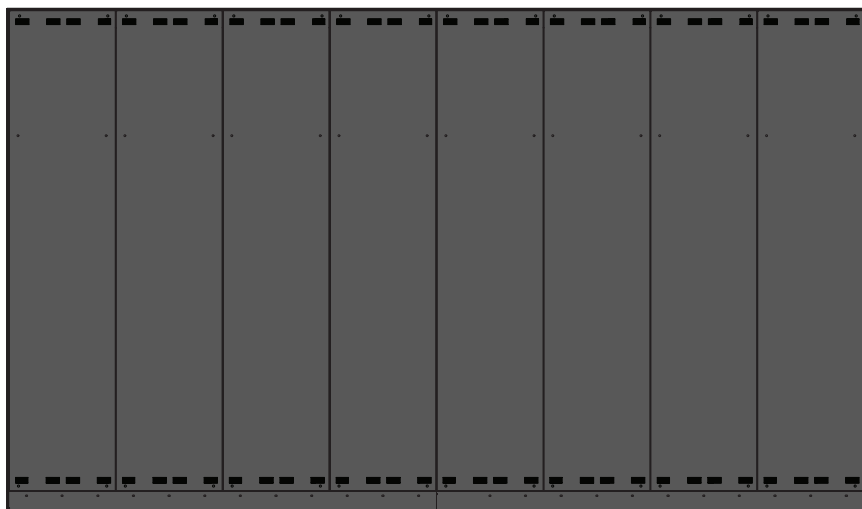

介紹

安裝前

- ❗ 請在顯示器背面與任何牆壁之間，保留足夠的氣隙以確保適度通風。
- ❗ 確保沒有來自空調或暖氣通風口的直接氣流吹向顯示器。
- ❗ 避免將顯示器安裝在高濕度場所。
- ❗ 由於功耗高，請務必使用專為本產品而設計的電源線。

壁掛

安裝上下壁掛架

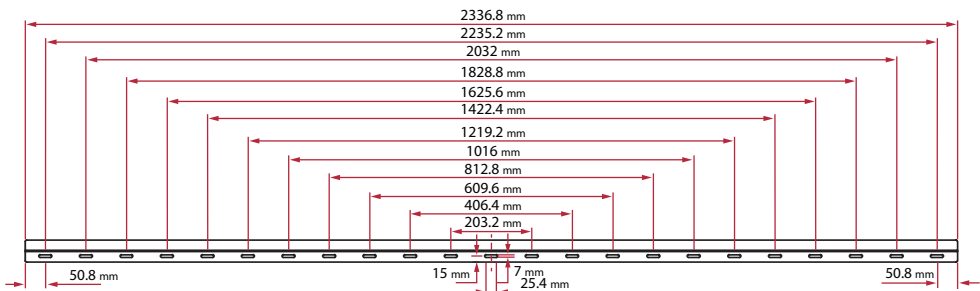

1. 確保牆壁面積和大小適合安裝。

備註：上壁掛架的離地高度不得小於 129.92" (3.3 公尺)。

2. 以壁掛架 (上圖) 為基準，至少標記 12 個孔並預先鑽孔。
3. 使用隨附的螺絲 (M6x50mm 膨脹螺絲用於石材；TA6x30mm 用於承重木材) 安裝第一個上壁掛架。
4. 重複步驟 2，確保第二個上壁掛架與第一個上架齊平。



5. 安裝下壁掛架，方式與上壁掛架相同。上下壁掛架之間的距離為 103.94" (2640 mm)。

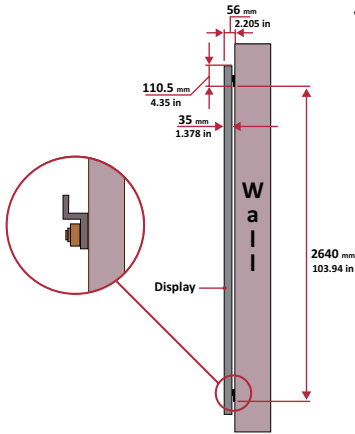

備註：您也可以安裝上壁掛架，懸掛螢幕，然後安裝下壁掛架以便更精準地安裝。

- ❗ 確保牆壁可安全地支撐 749.57 lbs (340 kg)。
 - ❗ 確保牆面的偏差小於5公釐 (0.197 英吋)。
6. 安裝上下壁掛架後，安裝牆應如下所示：

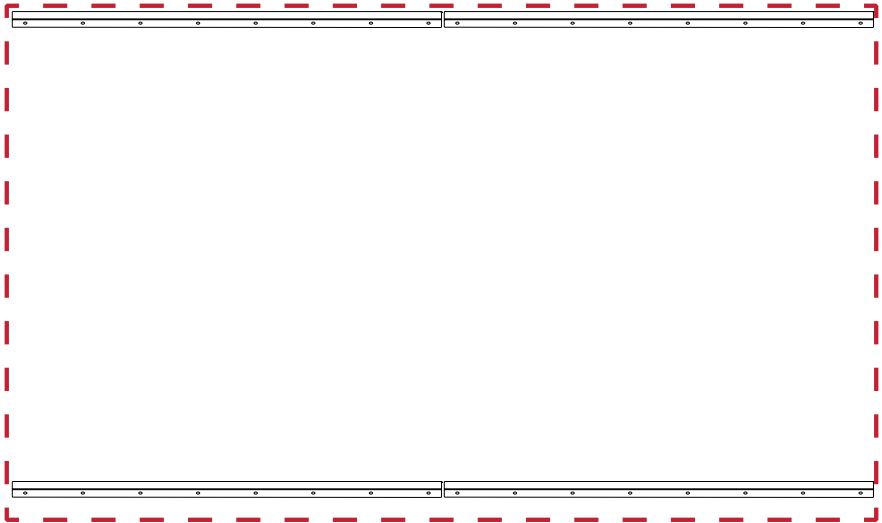

安裝中間機櫃

1. 確保六 (6) 個中間機櫃後側的安裝架位於上下安裝位置，如下所示：



2. 小心地將各個中間機櫃抬到上壁掛架上。

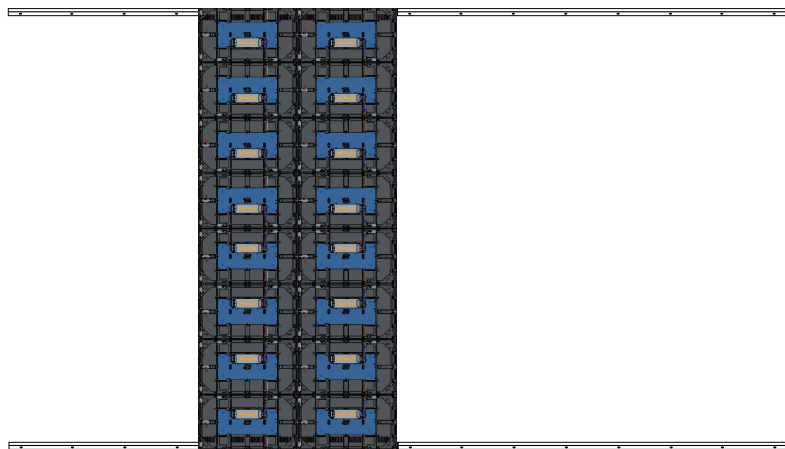

3. 確保安裝架固定在壁掛架上，如下所示。

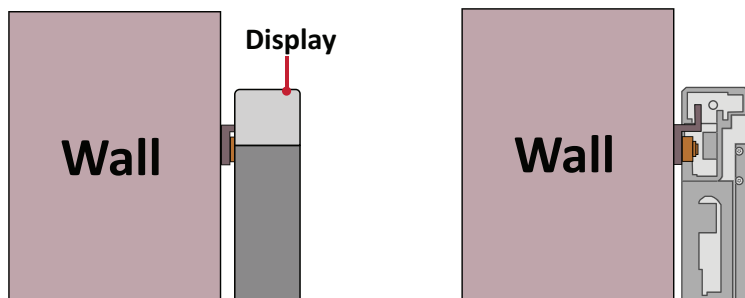

4. 推入鎖定螺栓並用六角工具鎖緊鉤子，將機櫃牢牢連接在一起。可能必須使用內六角扳手對準孔洞，以接合鎖定螺栓。

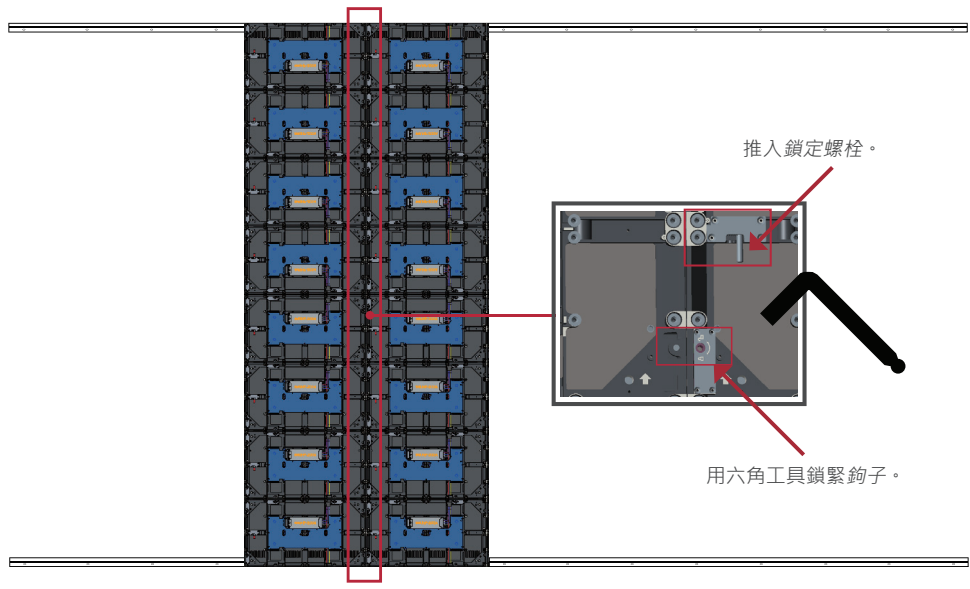

備註： 每個機櫃之間有八 (8) 個鎖定螺栓和十六 (16) 個鉤子。

- 將中間機櫃向上抬至上壁掛架，並確保安裝架確實固定於壁掛架上。
- 重複步驟4，使用每個鎖定螺栓與掛鉤固定機櫃。

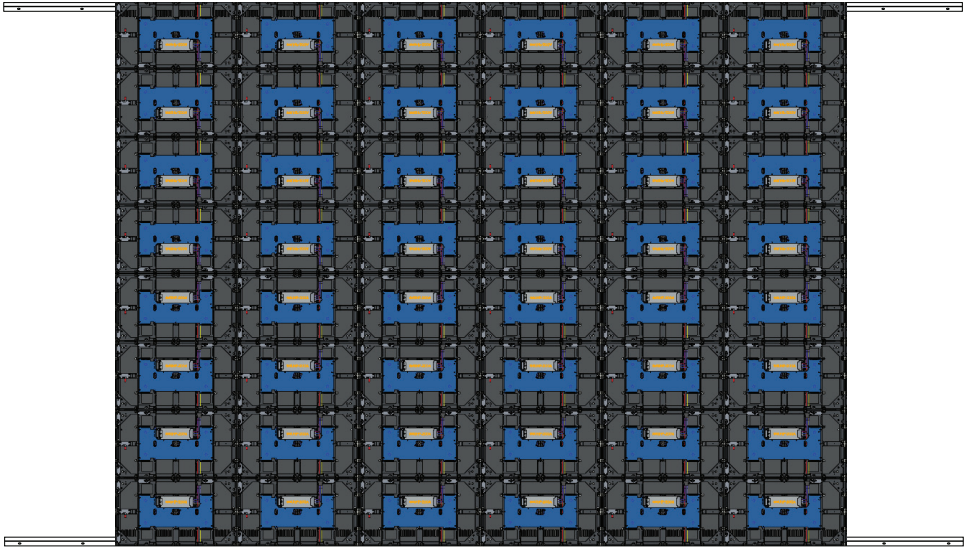

安裝左右機櫃

1. 確保左側和右側機櫃後側的安裝架位於上下安裝位置，如下所示：

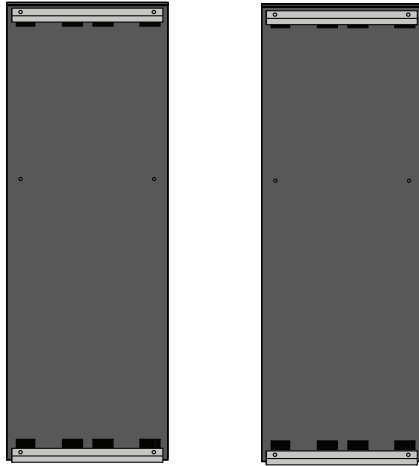

2. 小心地將左側和右側機櫃抬到上壁掛架上，確保安裝架固定在壁掛架上。

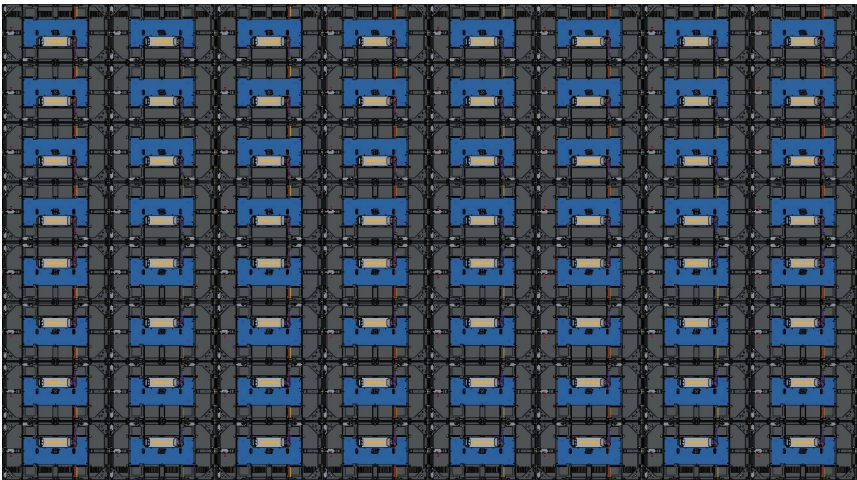

3. 調整左側或右側機櫃，使其與中間機櫃無縫對齊。

4. 推入鎖定螺栓並用六角工具鎖緊鉤子，將左側與右側機櫃牢牢連接。可能必須使用內六角扳手對準孔洞，以接合鎖定螺栓。

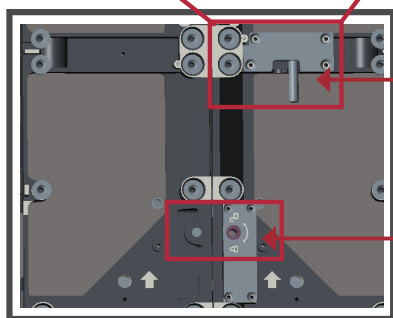
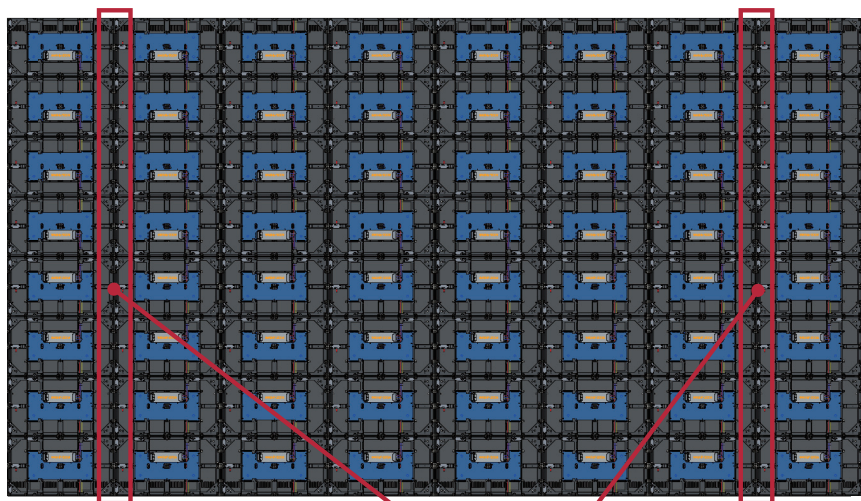

推入鎖定螺栓。



用六角工具鎖緊鉤子。

備註： 每個機櫃之間有八 (8) 個鎖定螺栓和十六 (16) 個鉤子。

連接系統控制箱

1. 小心地展開系統控制箱面板。確保主系統控制機板位於左側。

備註：請小心，因為系統控制箱面板分成兩部分，已連接電線。

2. 將機櫃的孔對準系統控制箱以裝上。

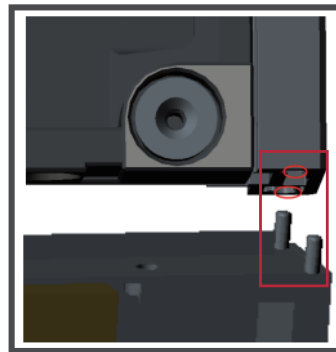
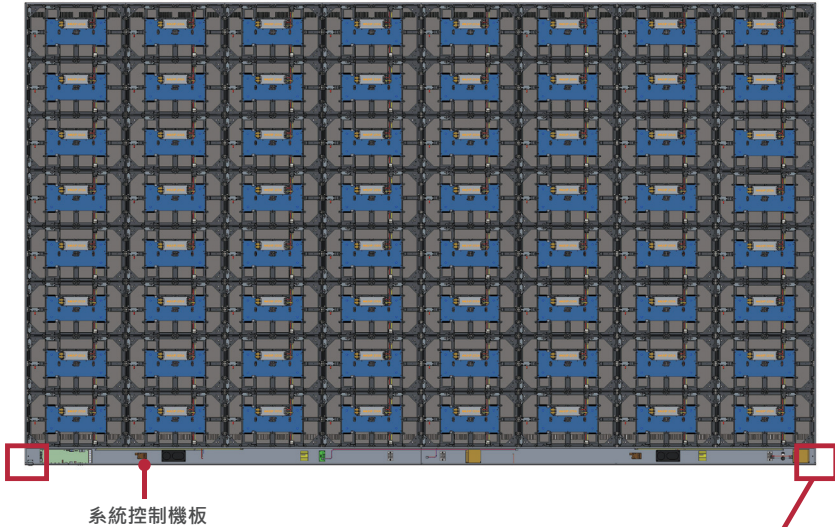

3. 您也可以重新安裝電源線以確保美觀，鬆開三 (3) 個 PWM 4x6mm 螺絲，拉出電源線，將電源線穿過後孔，然後鎖緊螺絲。

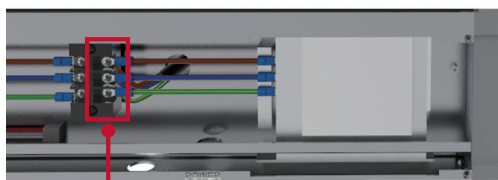
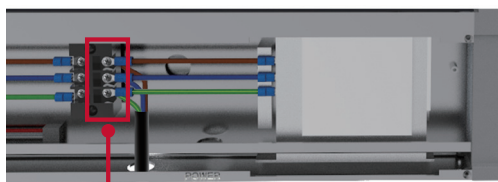
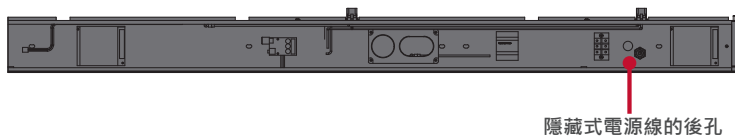

⚠ 僅限由專業人員操作。

4. 使用 32 支隨附的 M6x16mm 螺絲進一步將系統控制箱固定至機櫃。

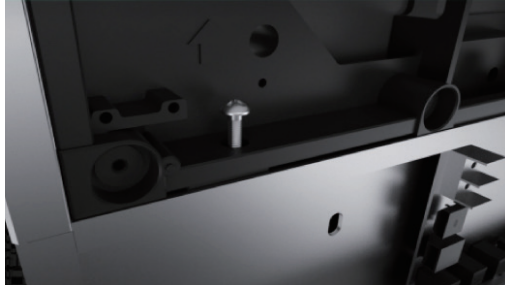

5. 將機櫃的網路線和電源線連接至系統控制箱。

備註：有四 (4) 條網路線和八 (8) 條電源線要連接。

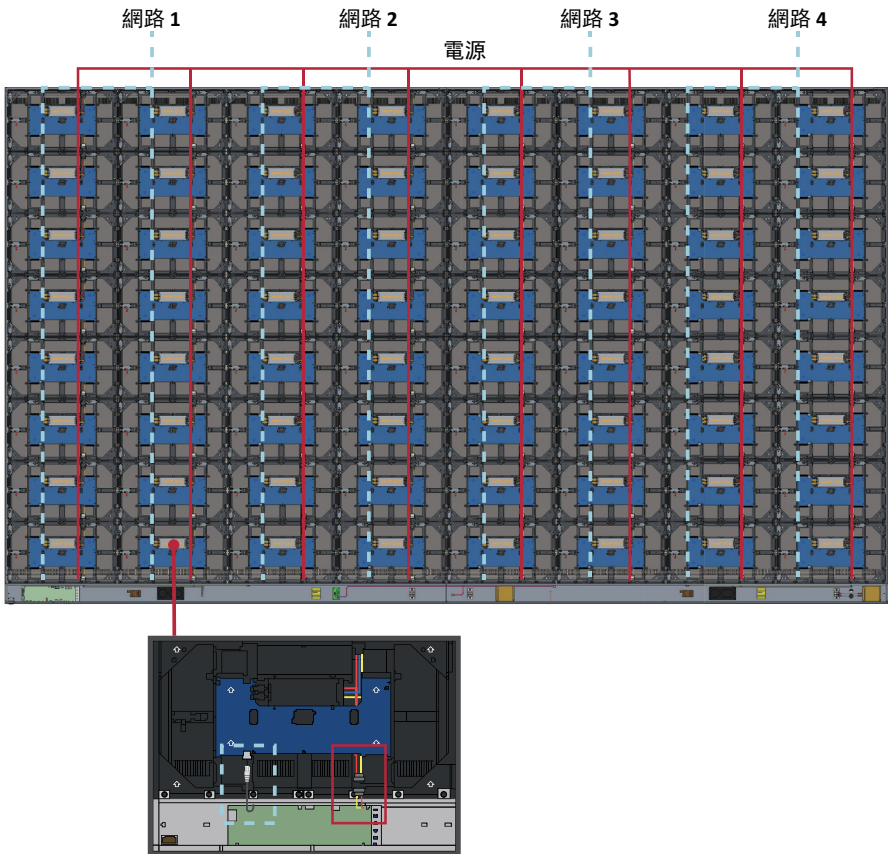

安裝 LED 模組

將 LED 模組安裝到機櫃上，務必使模組上的對應編號與機櫃相符。

❗ 處理 LED 模組前，請先戴上防靜電手套。



確保模組齊平，且彼此之間幾乎沒有間隙。可能必須輕敲模組，以使模組齊平。

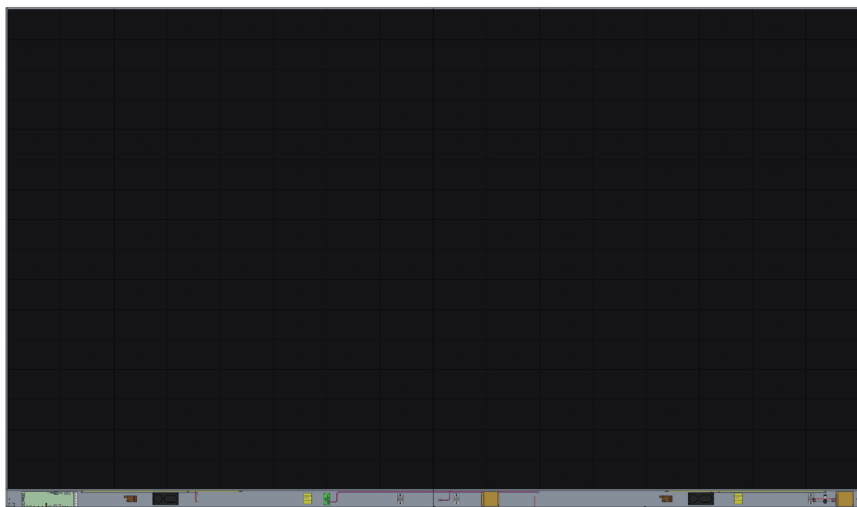

安裝系統控制箱護蓋

有三 (3) 個系統控制箱護蓋：左側、中間、右側。



1. 首先將右側護蓋安裝到系統控制箱上。

備註： 固定護蓋之前，請務必先將**電源按鈕**纜線，連接至系統控制箱電源線。

2. 連接**電源按鈕**纜線後，確保右側護蓋與系統控制箱正確對齊；然後用 18 支隨附的 KM3x6mm 螺絲加以固定。



3. 對中間和左側護蓋重複上述步驟。





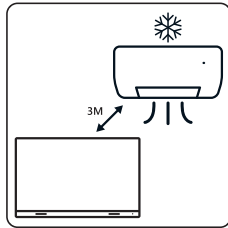
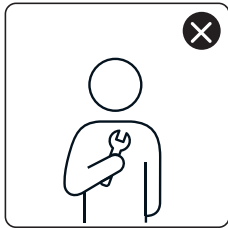
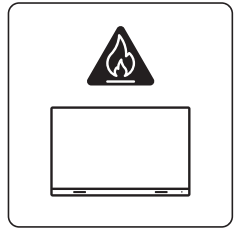
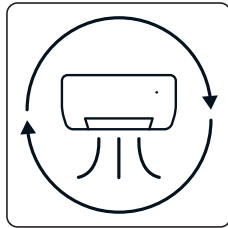
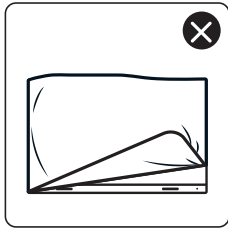
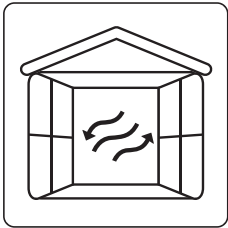
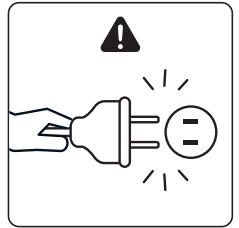
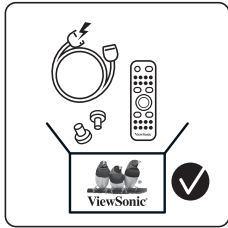
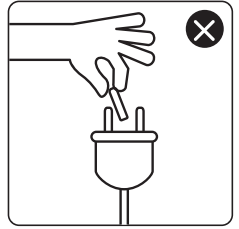
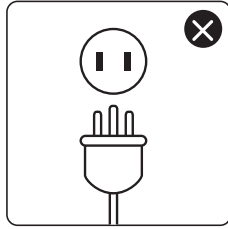
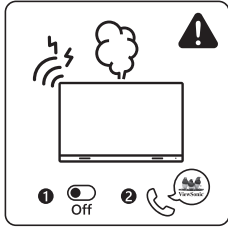
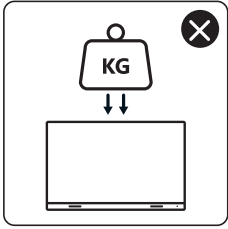
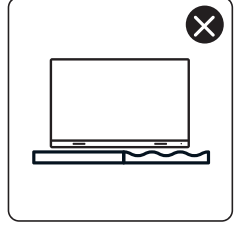
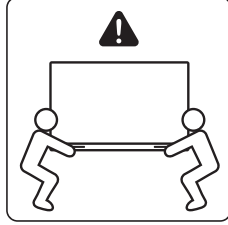
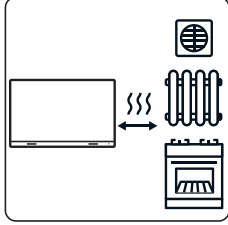
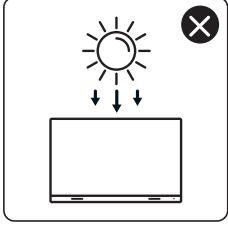
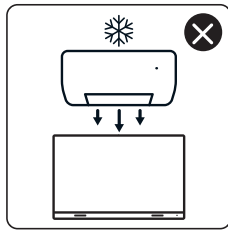
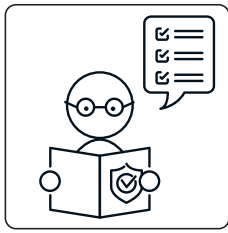
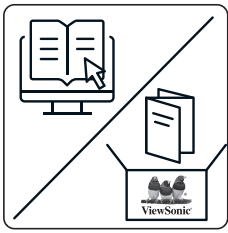

4. 顯示器現在已可啟動。



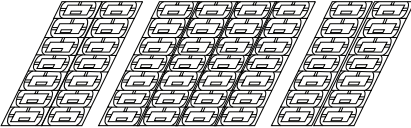

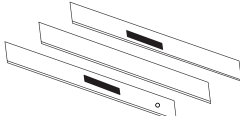
包装物品

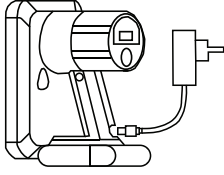
项目		数量	注意
机壳部分		共有 8 部分	
系统控制盒 (左侧和右侧)		2 侧	
快速使用手册		1	
LED 模块		128 个模块	备用 LED 模块的数量因国家/地区而异。
遥控器		1	
螺丝		48 x M6x50mm 膨胀螺丝 (1) 48 x TA6x30mm (2) 32 x M6x16mm (3) 18 x KM3x6mm (4)	
六角工具 (艾伦扳手)		2	1 x 5 mm 1 x 8 mm

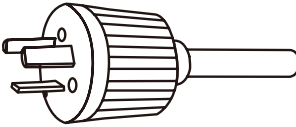
项目		数量	注意
系统控制盒封盖 (左侧、中间和右侧)		3	
墙壁装配架		4	
吸真空工具		1	
防静电手套		2 副	
USB-A连 USB-B电缆 (5m)		1	
电源线		2	由于功耗较大，需要两根电源线和两个专用电源插座。

注：

- 本产品包装在航空运输箱中。
- 由于尺寸和重量的原因，建议由两个或两人以上进行搬运。

产品概览

前面板

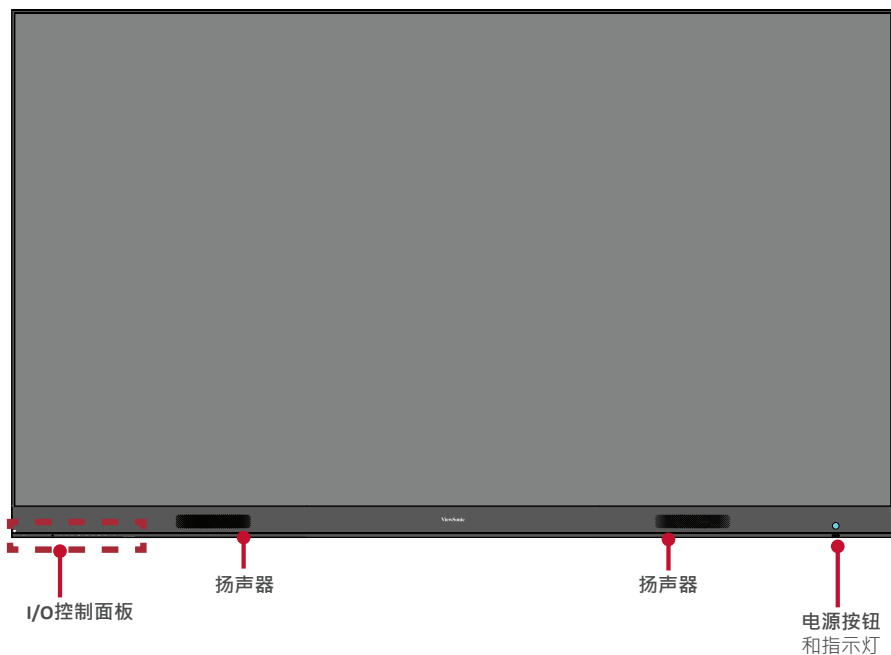

后面板

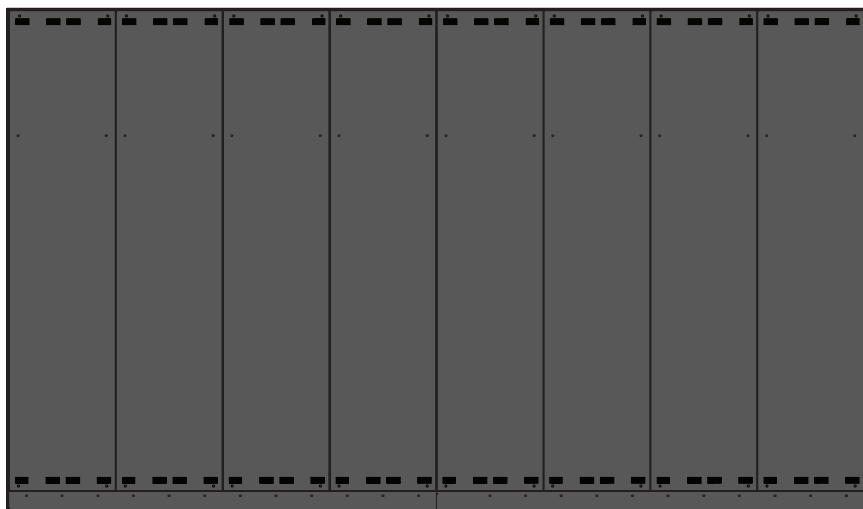

5. 按照安装上方墙壁装配架的方式安装下方墙壁装配架。上方墙壁装配架与下方墙壁装配架之间的距离为 103.94" (2460 mm)。

注：或者，安装上方墙壁装配架、挂起屏幕，然后安装下方墙壁装配架，以便更准确地调试。

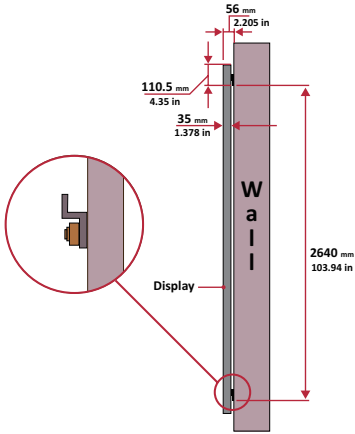

- ❗ 确保墙壁可安全支撑 749.57 磅 (340 千克) 的重量。
 - ❗ 墙壁表面偏差务必 < 5mm (0.197 英寸)。
6. 安装上下墙壁装配架后，安装墙壁外观如图所示：

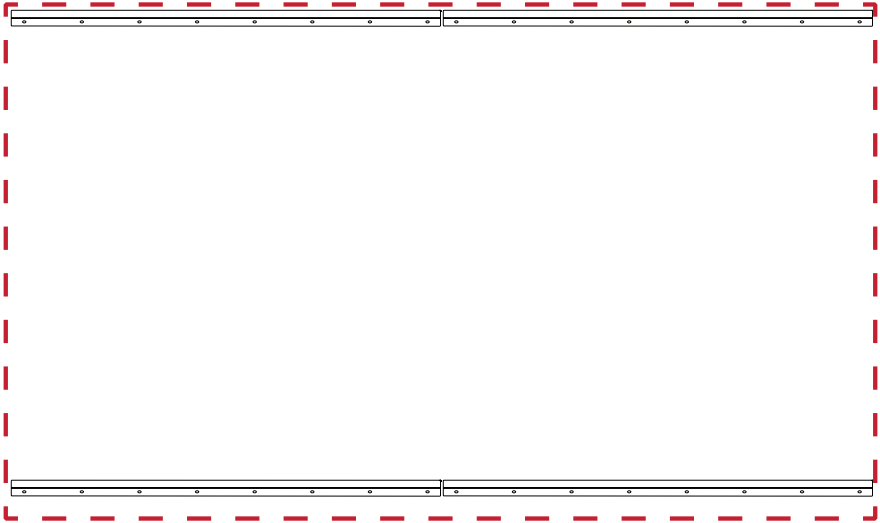

安装中间机壳

1. 确保六 (6) 各中间机壳后方的安装支架位于下图所示的上下安装位置：



2. 小心地将每个中间机壳提起并放在上方墙壁装配架上。

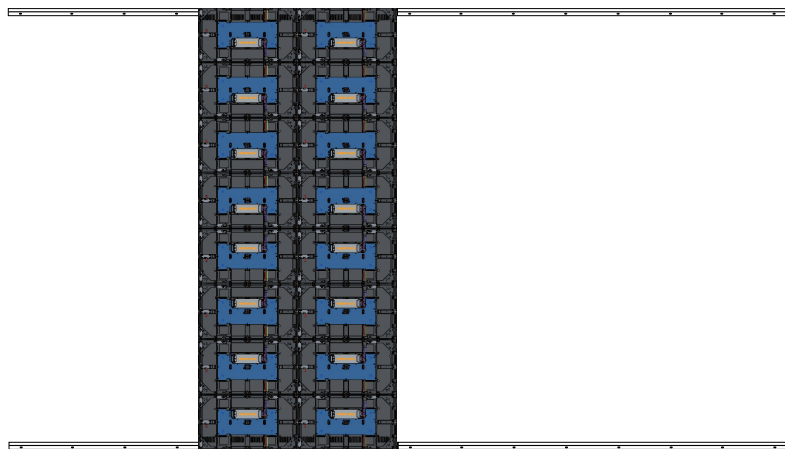

3. 确保安装支架稳定地放置在墙壁装配架上，如下图所示。

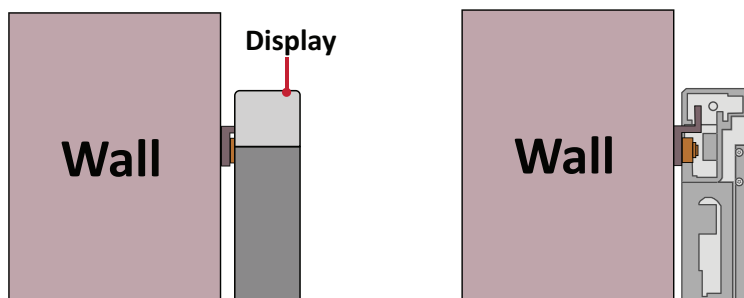

4. 按压各个锁紧螺栓，然后使用六角工具锁定每个卡钩，使各个机壳牢固地连接在一起。其中可能需要使用艾伦扳手将孔对齐使锁紧螺栓扣合。

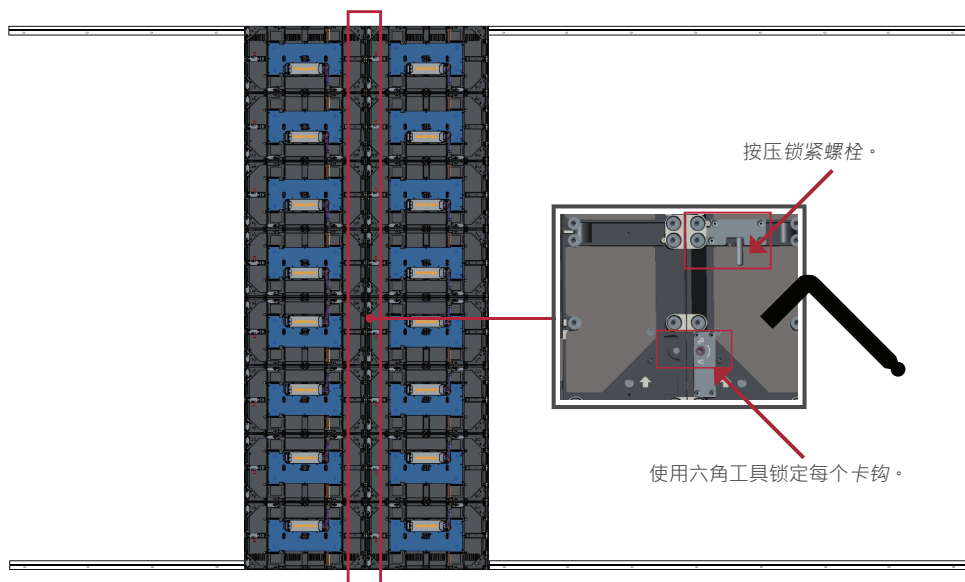

注：每个机壳对应应有八 (8) 个锁紧螺栓和十六 (16) 个卡钩。

5. 抬起中间机壳的剩余部分，将其放置在上方墙壁装配架上，确保装配架牢固地固定在墙壁装配架上。
6. 重复步骤4，将机壳与每个锁紧螺栓和挂钩固定在一起。

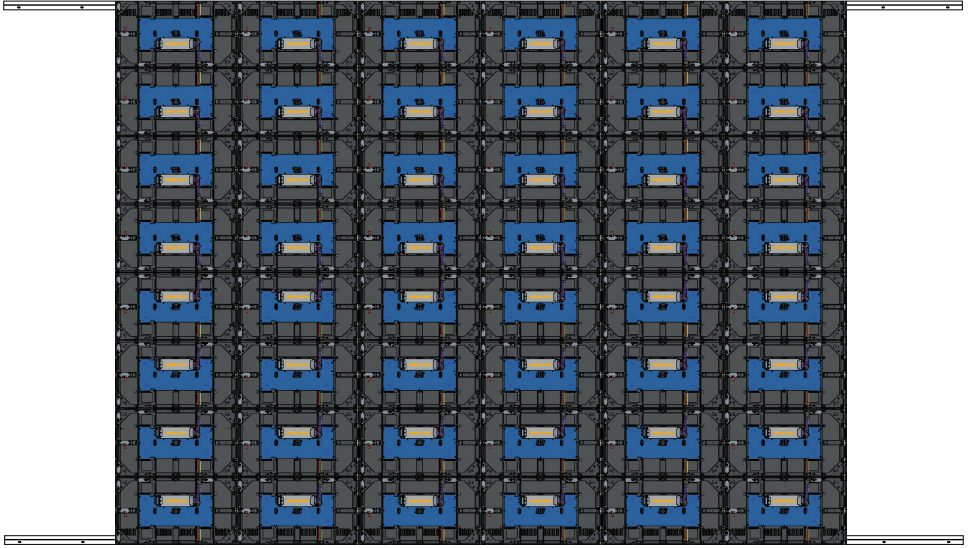

安装左机壳和右机壳

1. 确保左侧和右侧机壳后方的安装支架位于下图所示的上下安装位置：

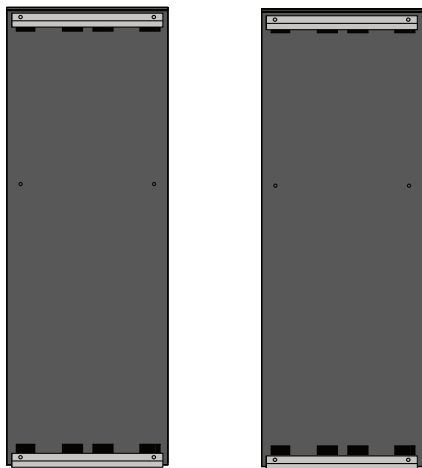

2. 小心地提起左侧和右侧机壳并放置在墙壁装配架上，确保安装支架稳定地放置在墙壁装配架上。

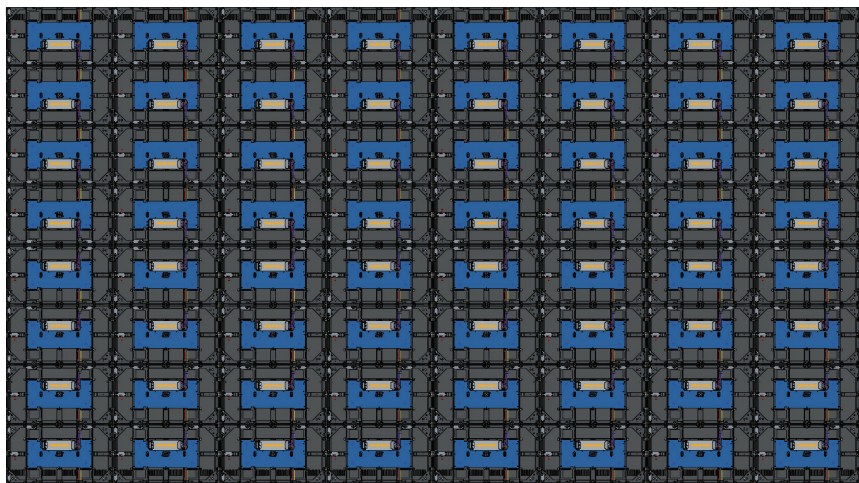

3. 调整左侧或右侧机壳，使其无缝适配到中间机壳。

4. 按压各个锁紧螺栓，然后使用六角工具锁定每个卡钩，以连接左侧和右侧机壳。其中可能需要使用艾伦扳手将孔对齐使锁紧螺栓扣合。

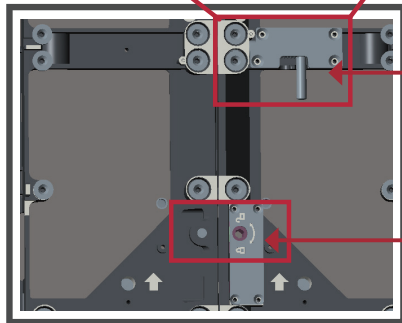
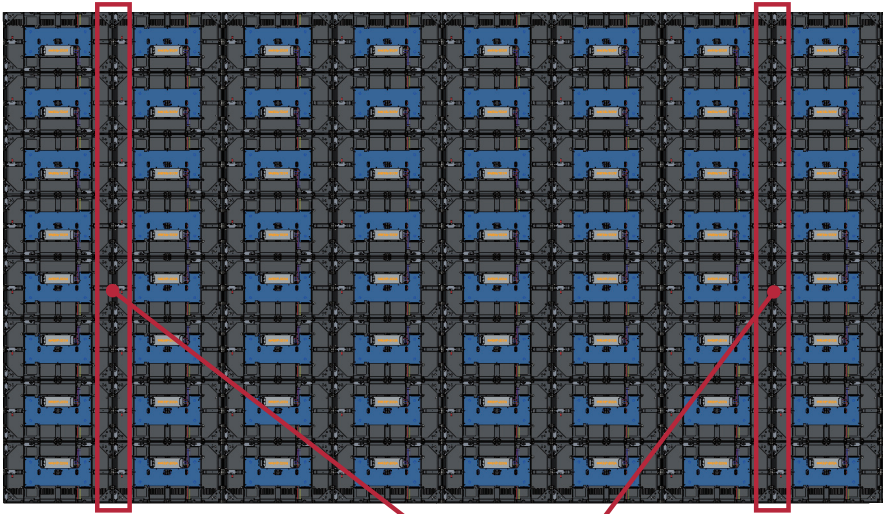

按压锁紧螺栓。

使用六角工具锁定每个卡钩。

注：每个机壳对应有八 (8) 个锁紧螺栓和十六 (16) 个卡钩。

连接系统控制盒

1. 将系统控制盒面板小心展开。确保主系统控制板位于左侧。

注：注意，系统控制盒面板分为两个部分并由导线相连。

2. 将机壳上的孔与系统控制盒对齐。



系统控制板件

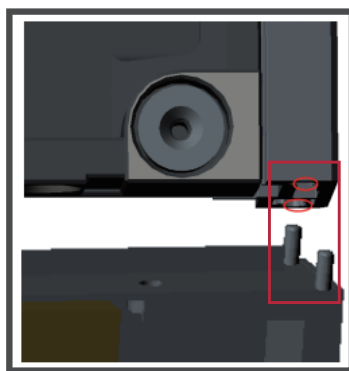

3. 为确保外型美观，还可重新安装电源线，拧松三 (3) 个 PWM 4x6mm 螺丝，拔出电源线，将电源线穿过后盖孔，然后拧紧螺丝。

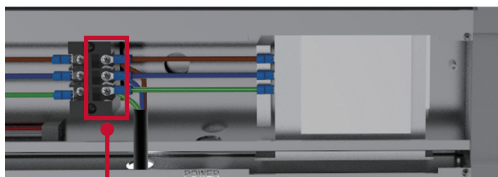
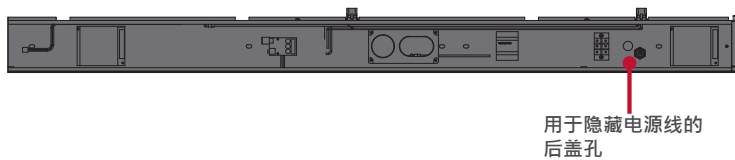

三 (3) 个 PWM 4x6mm 螺丝

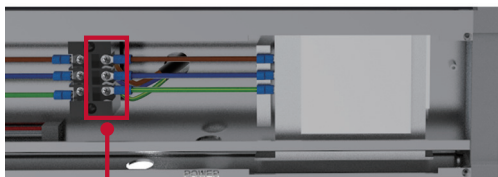

三 (3) 个 PWM 4x6mm 螺丝

! 仅可由专业人员操作。

4. 用随附的 32 个 M6x16mm 螺丝进一步将系统控制盒固定到机壳上。

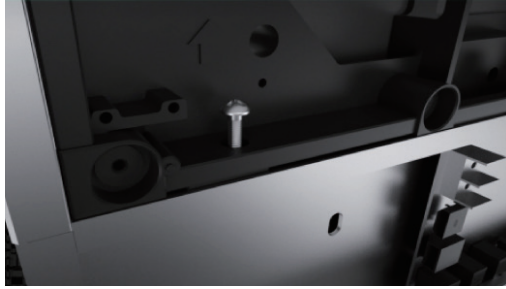

5. 将机壳的网线和电源线连接至系统控制盒上。

注：其中四(4)根网线和八(8)根电源线。

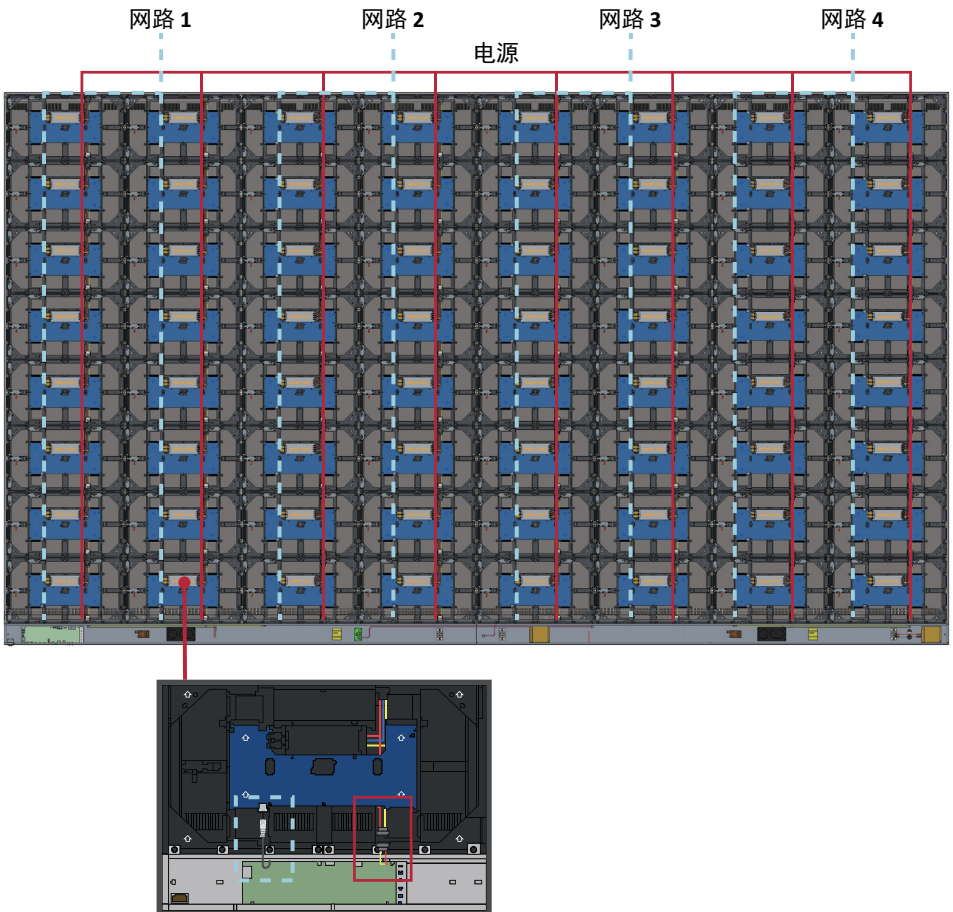

安装LED模块

将各个 LED 模块安装在机壳上，同时确保模块上的数字与机壳上的数字对应。

❗ 操作 LED 模块之前，请佩戴防静电手套。



确保各个模块齐平，每个模块之间基本无间隙或完全无间隙。其间可能需要轻轻敲击模块使其与其他模块齐平。

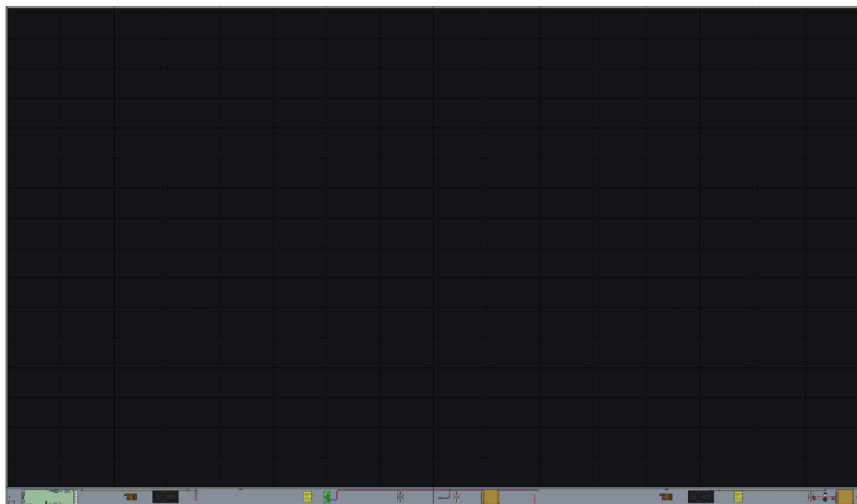

安装系统控制盒封盖

系统控制盒封盖共有三 (3) 个：左侧、中间和右侧。



1. 首先，将右封盖安装在系统控制盒上。

注：在固定封盖之前，务必将电源按钮线与系统控制盒电源线相连。

2. 在连接**电源按钮线**之后，确保右封盖与系统控制盒正确对齐，然后使用附送的 18 个 KM3x6mm 螺丝将其固定。



3. 对中间封盖和左封盖重复上述操作步骤。



4. 显示器现已准备好开机。



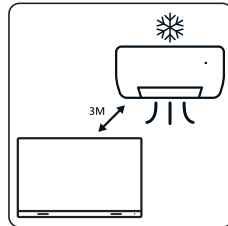
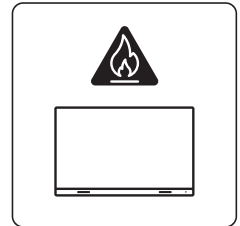
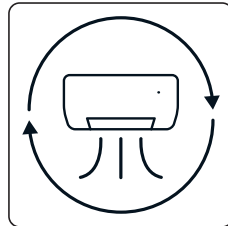
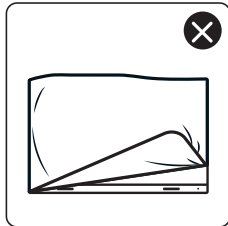
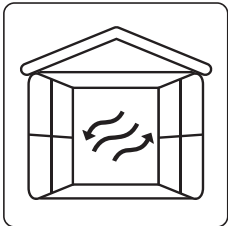
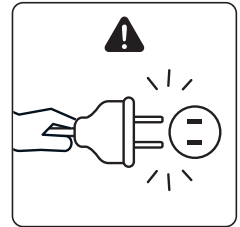
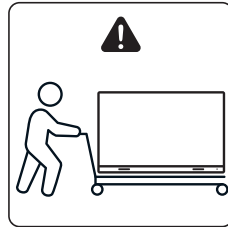
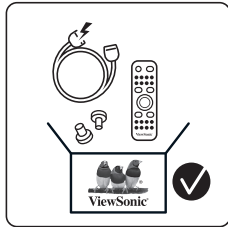
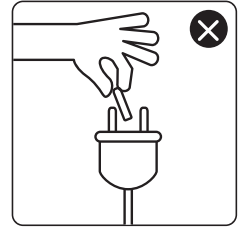
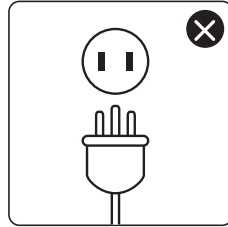
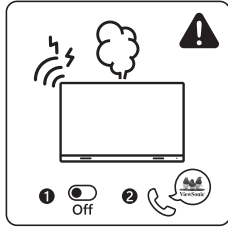
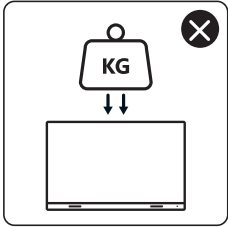
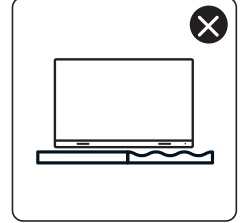
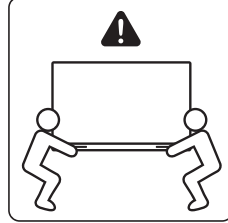
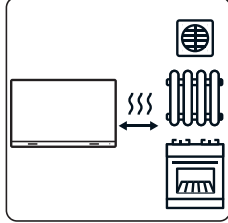
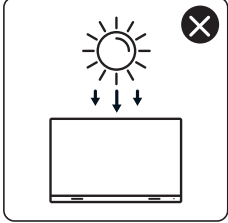
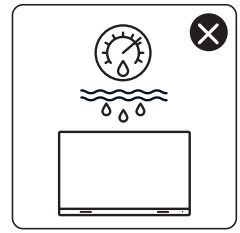
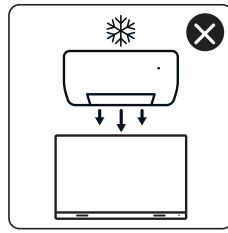
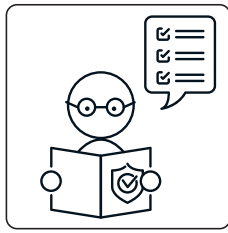
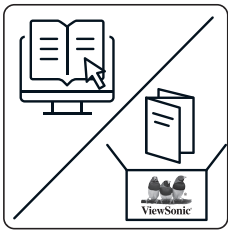

Contenu de la boîte

Élément	Quantité	Remarque
Sections du boîtier	8 sections au total	
Boîtier de commande du système (Côtés gauche et droit)	2 côtés	
Guide de démarrage rapide	1	
Modules LED	128 modules	Le nombre de modules LED de rechange varie selon les pays.
Télécommande	1	
Vis	48 x M6x50mm à expansion (1) 48 x TA6x30mm (2) 32 x M6x16mm (3) 18 x KM3x6mm (4)	
Outil hexagonal (clé Allen)	2	1 x 5 mm 1 x 8 mm

Élément	Quantité	Remarque
Couvercles du boîtier de commande du système (Côtés gauche, central et droit)	3	
Vis de montage mural	4	
Outil d'aspiration sous vide	1	
Gants antistatiques	2 paires	
Câble USB-A vers USB-B (5 m)	1	
Cordon d'alimentation	2	La consommation électrique est importante, par conséquent deux cordons d'alimentation et deux prises électriques dédiées sont nécessaires.

REMARQUE :

- Ce produit est emballé dans une boîte de transport aérien.
- En raison de sa taille et de son poids, il est recommandé de le manipuler à deux personnes ou plus.

Présentation du produit

Panneau frontal

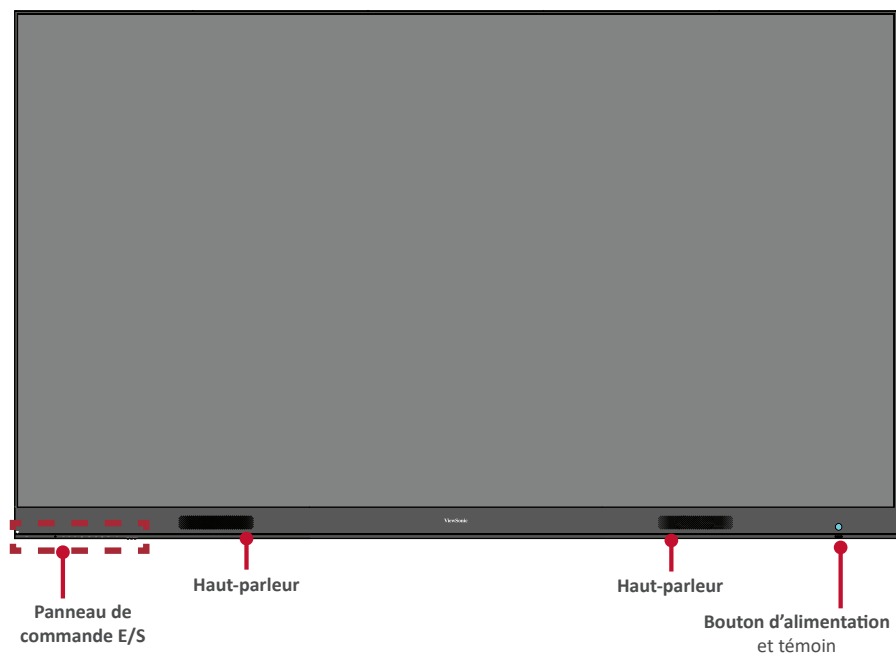

Panneau arrière

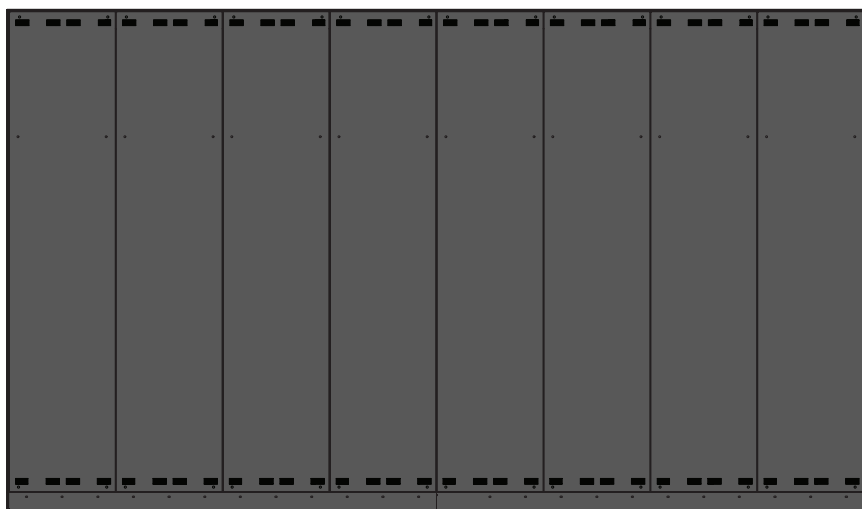

Introduction

Avant l'installation

- ! Maintenez un espace d'air suffisant entre l'arrière de l'écran et le mur pour une bonne ventilation.
- ! Veillez à ce qu'aucun flux d'air direct provenant des bouches de climatisation ou de chauffage ne soit dirigée vers l'écran.
- ! Évitez d'installer l'écran dans des endroits où l'humidité est élevée.
- ! En raison de la forte consommation électrique, utilisez toujours des cordons d'alimentation spécialement conçus pour ce produit.

Montage mural

Installation des supports muraux supérieurs et inférieurs

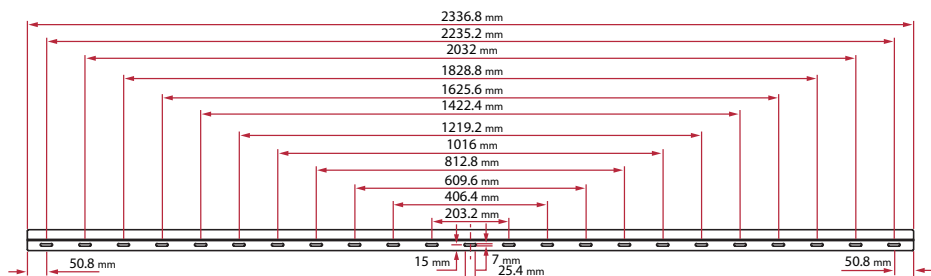

1. Assurez-vous que la surface et les dimensions du mur constituent un site d'installation approprié.

REMARQUE : La hauteur des supports muraux supérieurs ne doit pas être inférieure à 129,92" (3,3 mètres) par rapport au sol.

2. En utilisant le *support mural* (photo ci-dessus) comme guide, marquez au moins 12 trous et pré-percez-les.
3. Installez le premier *support mural* supérieur avec les vis fournies (M6 x 50 mm à expansion pour maçonnerie ; TA6 x 30 mm pour le bois porteur).
4. Répétez l'étape 2, en vous assurant que le deuxième *support mural* supérieur est de niveau avec le premier support supérieur.



5. Installez les *supports muraux* inférieurs de la même manière que les *supports muraux* supérieurs. La distance entre les *supports muraux* supérieur et inférieur est de 2640 mm.

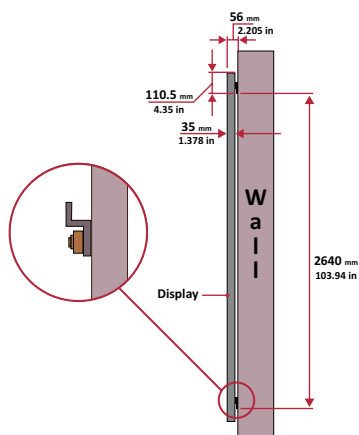

REMARQUE : Vous pouvez également installer les supports muraux supérieurs, suspendre l'écran, puis installer les supports muraux inférieurs pour un ajustement plus précis.

- ! Assurez-vous que le mur peut supporter en toute sécurité un poids de 749,57 livres. (340 kg).
 - ! Assurez-vous que l'angle de la surface du mur soit <5mm (0,197 pouces).
6. Après avoir installé les *supports muraux* supérieurs et inférieurs, le mur d'installation devrait avoir cette apparence :

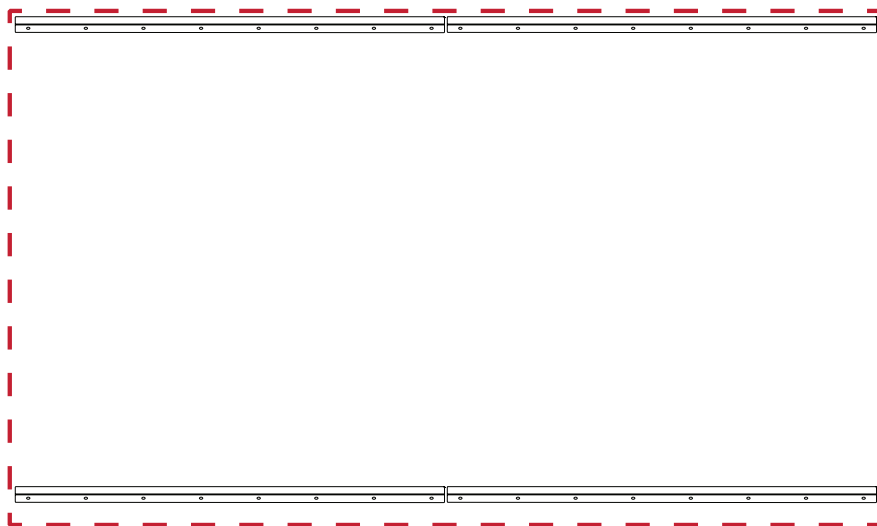

Installation des boîtiers centraux

1. Assurez-vous que les supports de montage à l'arrière des 6 boîtiers centraux sont placés aux positions de montage supérieure et inférieure comme indiqué ci-dessous :



2. Soulevez prudemment chaque *boîtier central* pour le placer sur les *supports muraux* supérieurs.

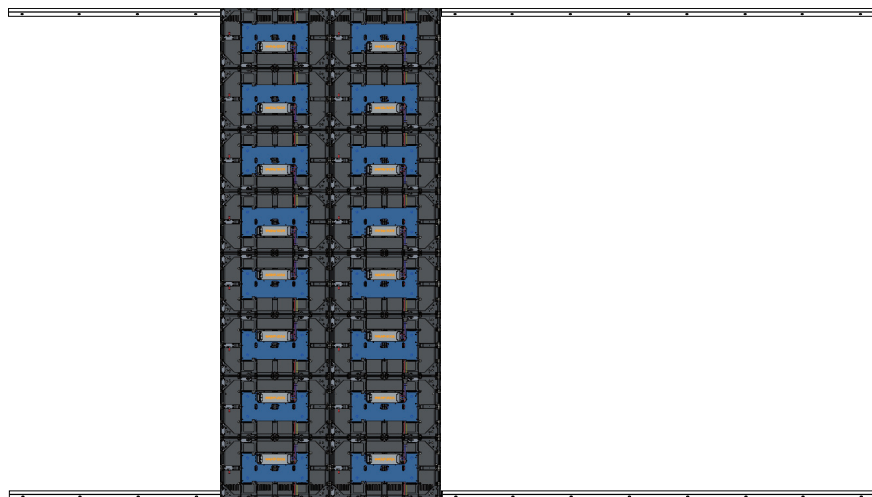

3. Assurez-vous que les *supports de montage* tiennent bien sur les *supports muraux* comme indiqué ci-dessous.

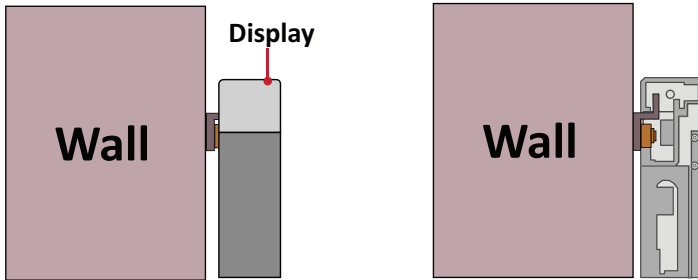

4. Poussez chaque *boulon de verrouillage* et verrouillez chaque *crochet* avec l'outil hexagonal pour solidariser fermement les boîtiers. Il peut être nécessaire d'aligner le trou avec une clé Allen afin d'engager le boulon de verrouillage.

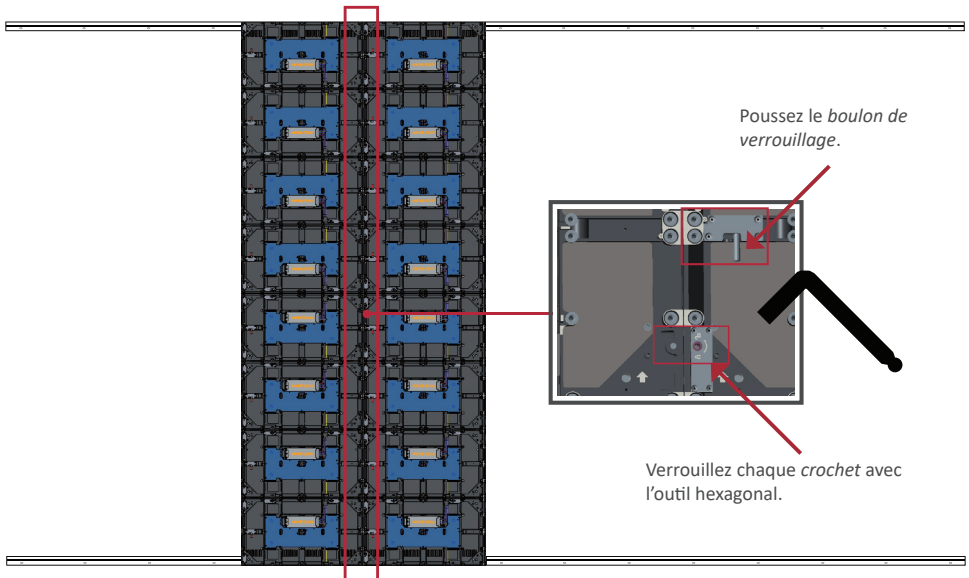

REMARQUE : Il y a 8 boulons de verrouillage et 16 crochets entre chaque boîtier.

Installation du boîtier gauche et du boîtier droit

1. Assurez-vous que les *supports de montage* à l'arrière du boîtier *gauche* et du boîtier *droit* sont placés aux positions de montage supérieures et inférieures comme indiqué ci-dessous :

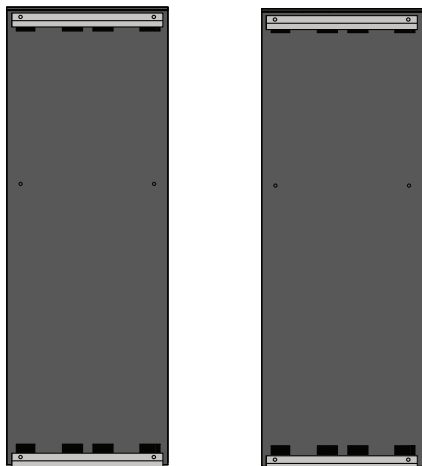

2. Soulevez prudemment le boîtier *gauche* et le boîtier *droit* pour les placer sur les *supports muraux* supérieurs, en vous assurant que les *supports de montage* tiennent bien sur les *supports muraux*.

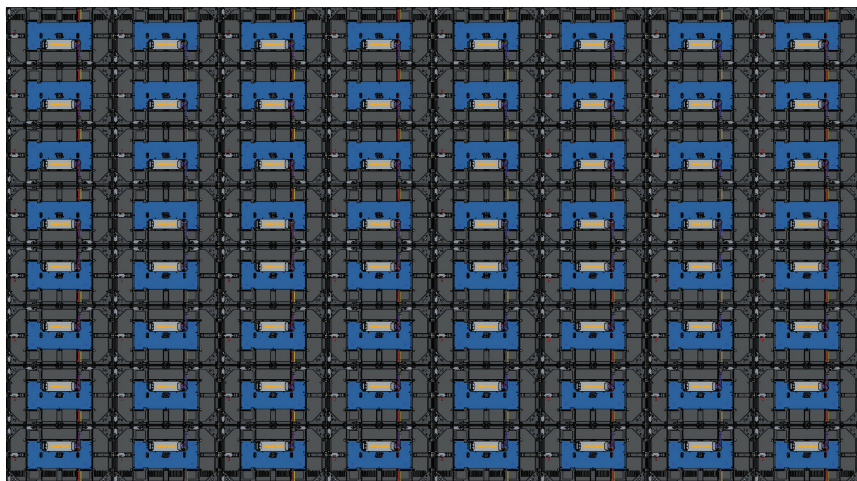

3. Ajustez le boîtier *gauche* ou le boîtier *droit* de manière à ce qu'il s'adapte parfaitement aux boîtiers *centraux*.

4. Poussez chaque *boulon de verrouillage* et verrouillez chaque *crochet* avec l'outil hexagonal pour solidariser fermement les boîtiers *gauche* et *droit*. Il peut être nécessaire d'aligner le trou avec une clé Allen afin d'engager le boulon de verrouillage.

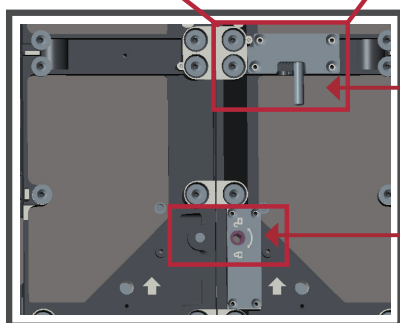
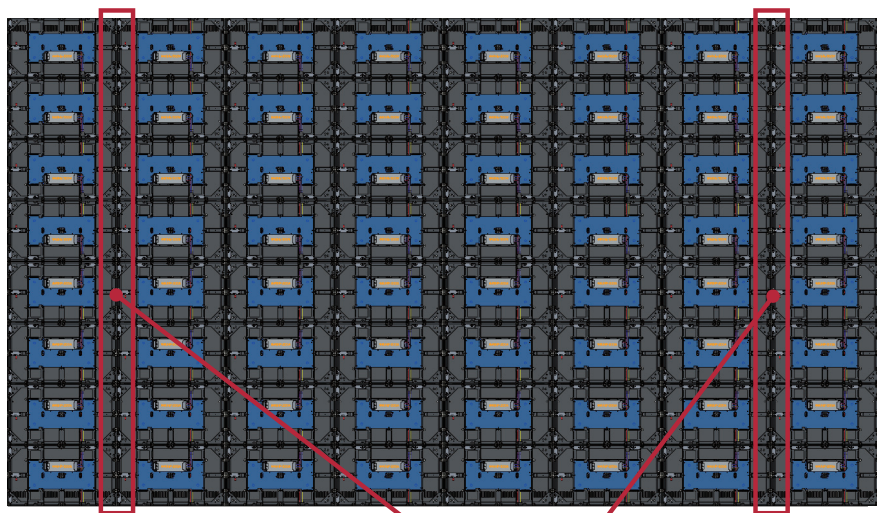

Poussez le *boulon de verrouillage*.



Verrouillez chaque *crochet* avec l'outil hexagonal.

REMARQUE : Il y a 8 *boulons de verrouillage* et 16 *crochets* entre chaque boîtier.

5. Soulevez le boîtier central restant sur les supports de la fixation murale supérieure, en vous assurant que les supports de montage sont bien installés sur les supports de la fixation murale.
6. Répétez l'étape 4, en fixant les boîtiers ensemble avec chaque boulon de verrouillage et chaque crochet.

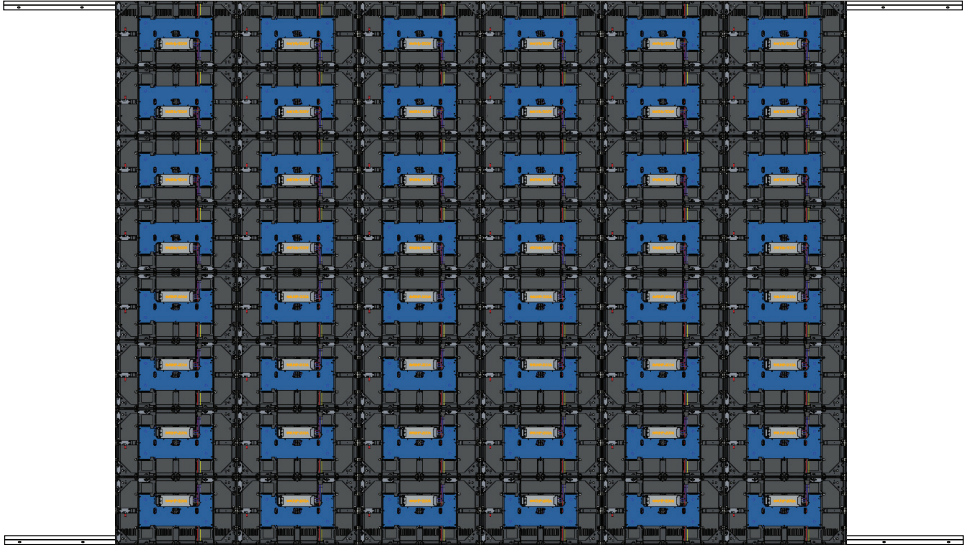

Connexion du boîtier de commande du système

1. Dépliez soigneusement le panneau du *boîtier de commande du système*. Assurez-vous que la carte de contrôle du système principal est sur la gauche.

REMARQUE : Faites preuve de prudence lorsque le *boîtier de commande du système* est séparé en deux éléments avec des fils attachés.

2. Alignez les trous du *boîtier* avec le *boîtier de commande du système* à fixer.

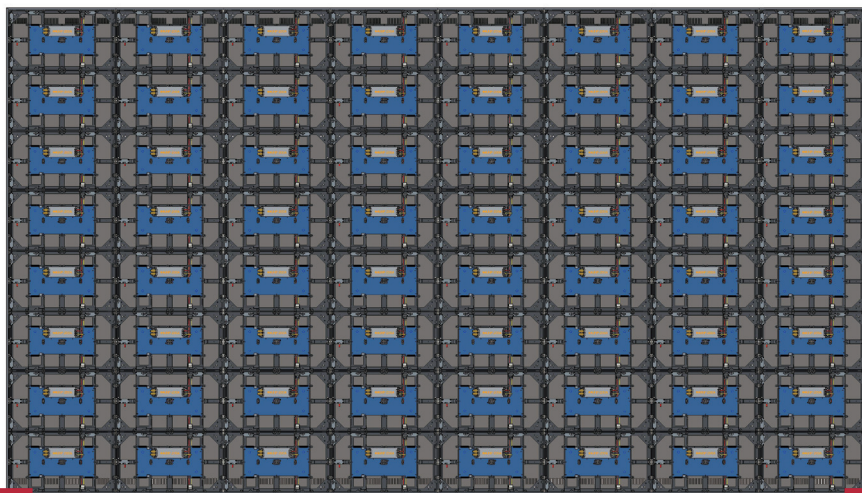

Carte de contrôle du système

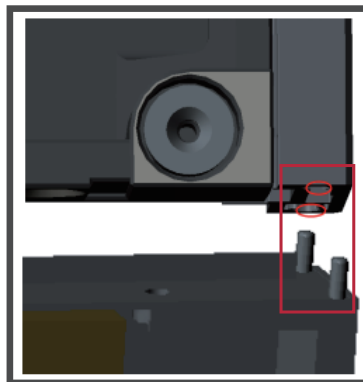

3. Vous pouvez également réinstaller le câble d'alimentation pour lui donner une apparence attrayante. Desserrez les trois (3) vis PWM 4x6mm, tirez le câble d'alimentation, faites passer le câble d'alimentation par le trou arrière, puis fixez les vis fermement.

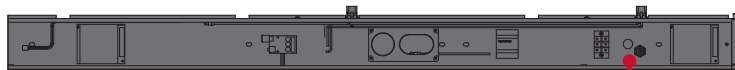

Trou arrière pour câble électrique caché

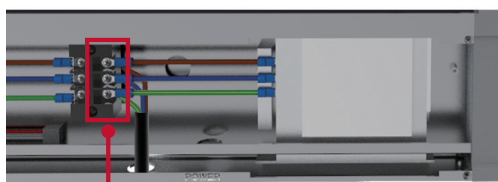

Trois(3) vis PWM 4x6mm

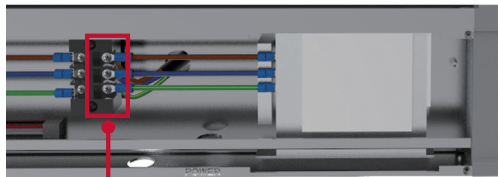

Trois(3) vis PWM 4x6mm

! Utilisation par un professionnel uniquement.

4. Fixez ensuite le *boîtier de commande du système* aux *boîtiers* avec les 32 vis M6x16mm fournies.

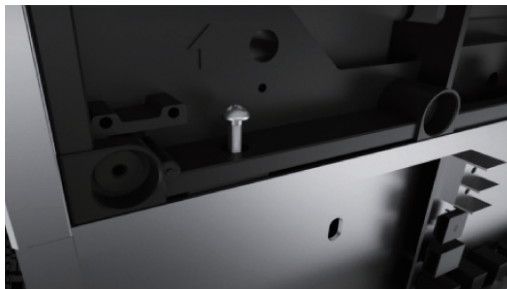

5. Raccordez les câbles réseau et d'alimentation des *boîtiers* au *boîtier de commande du système*.

REMARQUE : Il y a 4 câbles de réseau et 8 câbles d'alimentation à connecter.

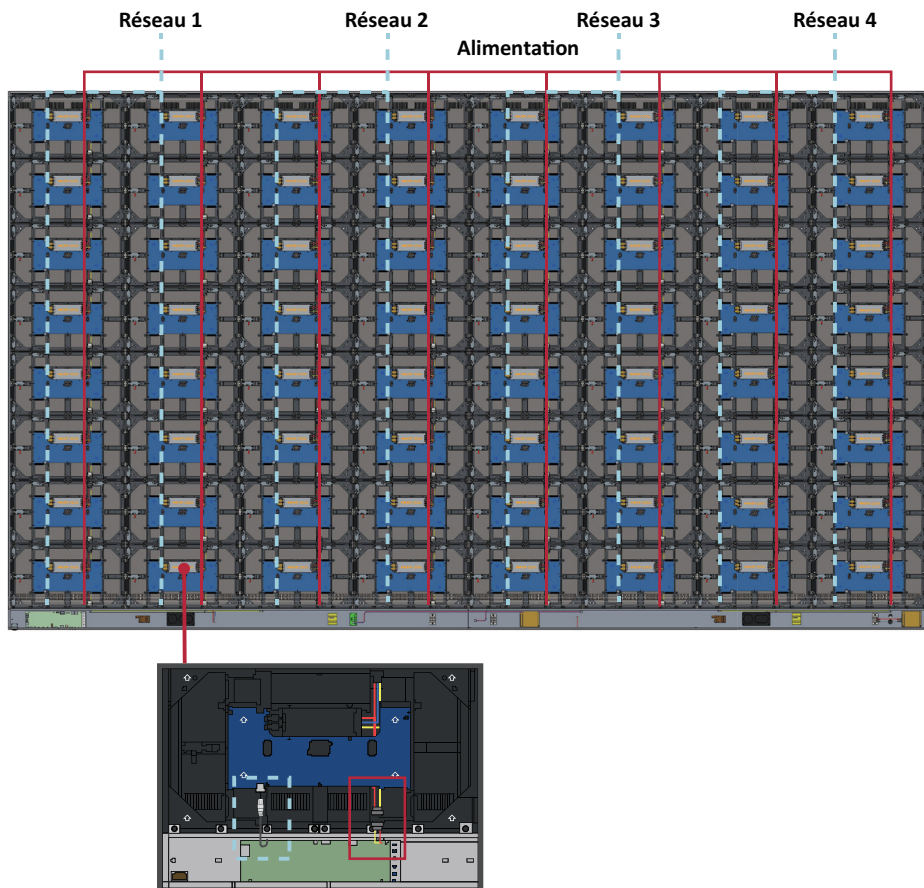

Installation des modules LED

Installez chaque *module LED* sur les *boîtiers*, en vous assurant de faire correspondre les numéros du *module* avec ceux du *boîtier*.

! Veuillez porter des gants antistatiques avant d'installer les modules LED.



Assurez-vous que chaque *module* est affleurant et qu'il n'y a peu voire pas d'espace entre eux. Il peut être nécessaire de tapoter doucement le module pour le faire affleurant.

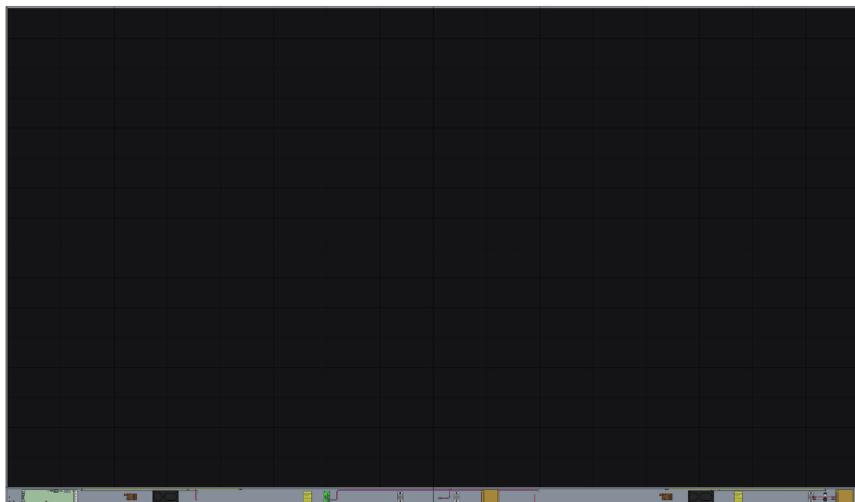

Installation des couvercles du boîtier de commande du système

Il y a trois (3) couvercles du boîtier de commande du système : Gauche, Central et Droit.



1. Commencez par installer le *couvercle droit* sur le *boîtier de commande du système*.

REMARQUE : Assurez-vous que le câble du **bouton d'alimentation** est raccordé au câble d'alimentation du *boîtier de commande du système* avant de fixer le *couvercle*.

2. Après avoir raccordé le câble du **bouton d'alimentation**, assurez-vous que le *couvercle droit* est correctement aligné avec le *boîtier de commande du système* ; puis fixez-le avec les 18 vis KM3x6mm fournies.



3. Répétez les étapes ci-dessus pour le couvercle *central* et le couvercle *gauche*.







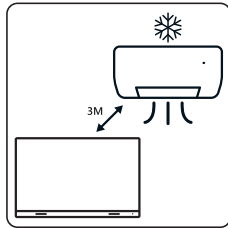
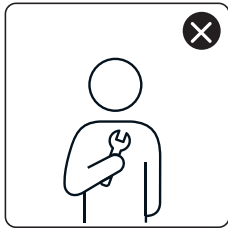
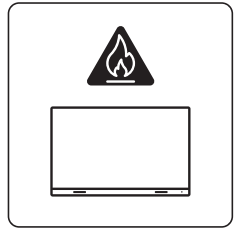
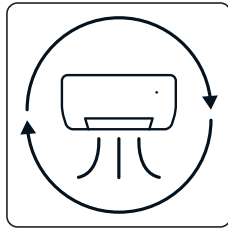
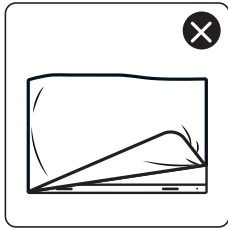
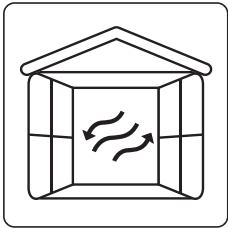
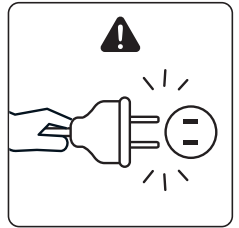
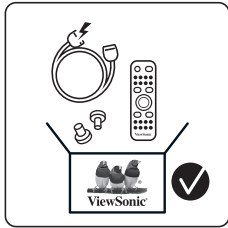
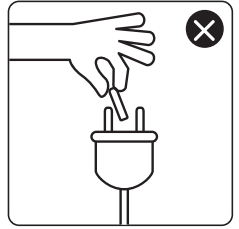
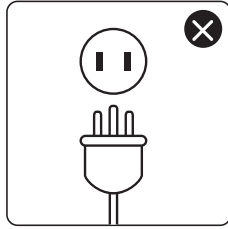
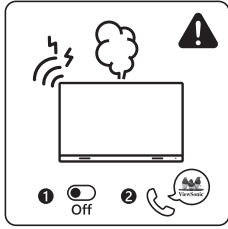
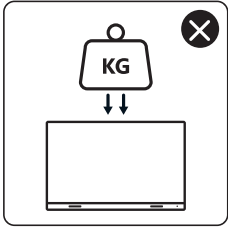
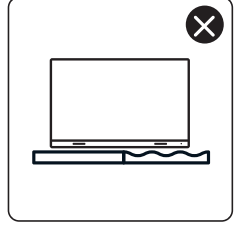
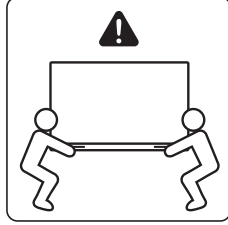
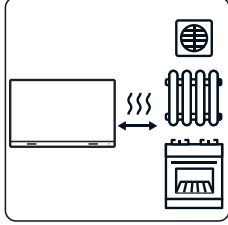
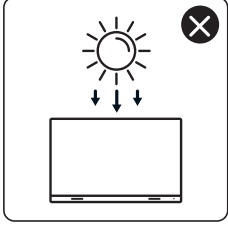
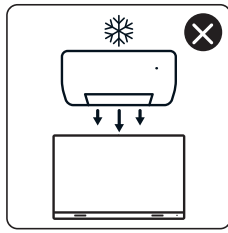
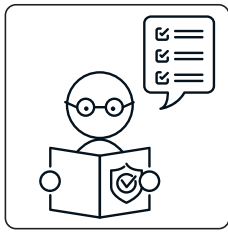
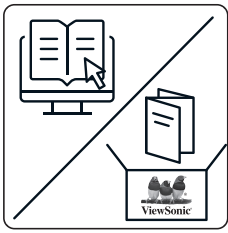

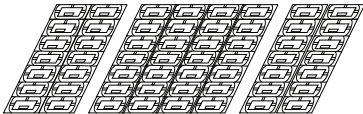
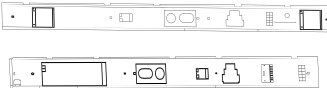
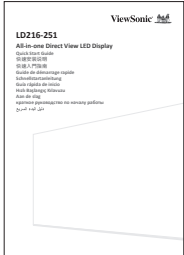
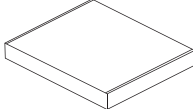

4. Votre écran est maintenant prêt à s'allumer.

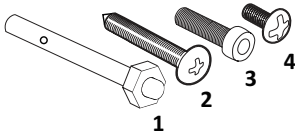

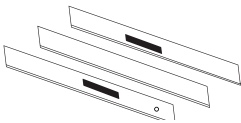

Lieferumfang

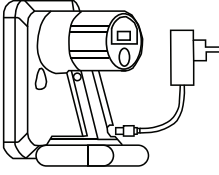
Element		Menge	Hinweis
Gehäuseabschnitte		8 Abschnitte insgesamt	
Systemsteuerbox (Linke und rechte Seite)		2 Seiten	
Schnellstartanleitung		1	
LED-Module		128 Module	Die Anzahl Ersatz-LED-Module variiert je nach Land.
Fernbedienung		1	
Schrauben		48 x M6x50mm Dübel (1) 48 x TA6x30mm (2) 32 x M6x16mm (3) 18 x KM3x6mm (4)	
Sechskantschlüssel (Inbusschlüssel)		2	1 x 5 mm 1 x 8 mm

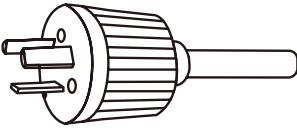
Element		Menge	Hinweis
Abdeckungen der Systemsteuerbox (Linke, mittlere und rechte Seite)		3	
Wandmontagehalterungen		4	
Vakuumsaugwerkzeug		1	
Antistatikhandschuhe		2 Paar	
USB-A-zu-USB-B-Kabel (5 m)		1	
Netzkabel		2	Der Stromverbrauch ist hoch, sodass zwei Netzkabel und zwei separate Steckdosen benötigt werden.

Hinweis:

- Dieses Produkt ist in einer Flugtransportbox verpackt.
- Aufgrund von Größe und Gewicht sollte es von zwei oder mehr Personen transportiert werden.

Übersicht

Frontblende

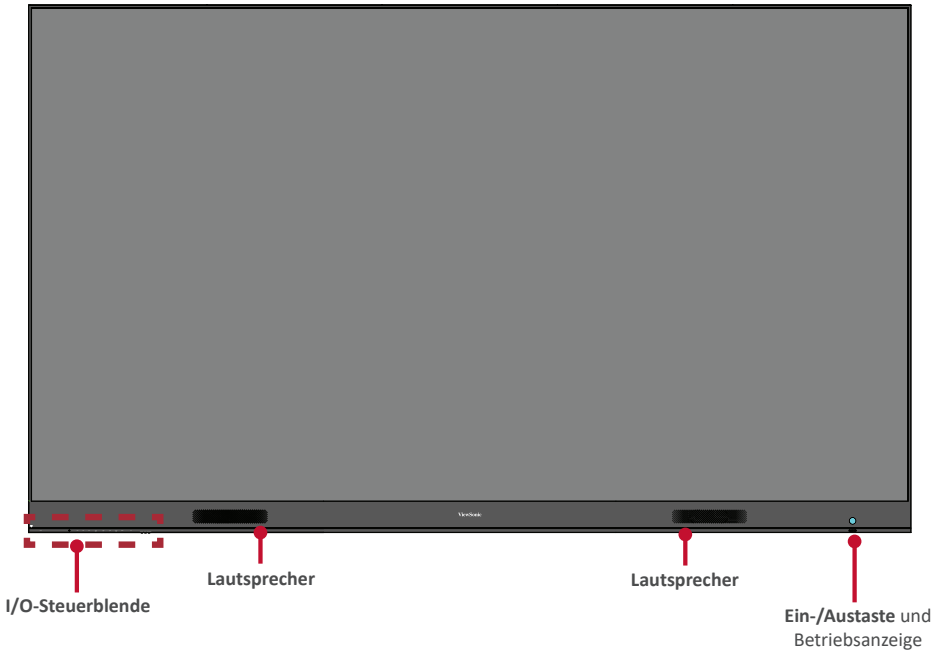

Rückwand

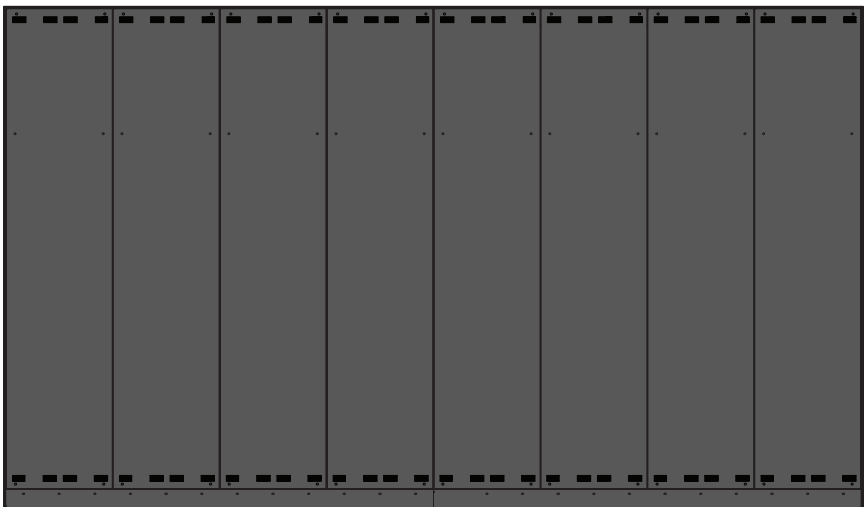

Einleitung

Vor der Installation

- ! Halten Sie für eine angemessene Belüftung einen ausreichenden Abstand zwischen der Rückseite des Displays und jeglichen Wänden ein.
- ! Stellen Sie sicher, dass Klimaanlage oder Heizgitter nicht direkt auf das Display gerichtet sind.
- ! Installieren Sie das Display nicht an sehr feuchten Orten.
- ! aufgrund des hohen Strombedarfs dürfen Sie nur speziell für dieses Produkt entwickelte Netzkabel verwenden.

Wandmontage

Obere und untere Wandhalterungen installieren

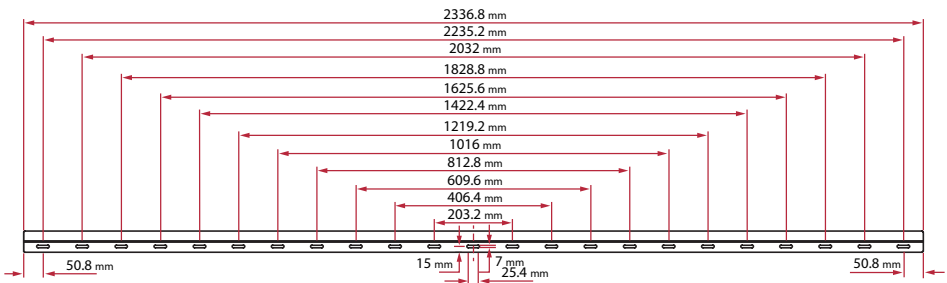

1. Stellen Sie sicher, dass Fläche und Größe der Wand für eine Installation geeignet sind.

Hinweis: Die Höhe der oberen Wandhalterungen darf nicht weniger als 3,3 Meter vom Boden betragen.

2. Verwenden Sie die *Wandhalterung* (oben abgebildet) als Schablone und markieren Sie mindestens 12 Löcher. Bohren Sie die Löcher vor.
3. Installieren Sie die erste obere *Wandhalterung* mit den mitgelieferten Schrauben (M6 x 50 mm Dübel bei Mauerwerk; TA6 x 30 mm bei lasttragendem Holz).
4. Wiederholen Sie **Schritt 2**, wobei Sie darauf achten, dass die zweite obere *Wandhalterung* parallel zur ersten oberen Halterung verläuft.



5. Installieren Sie die unteren *Wandhalterungen* ebenso wie die oberen *Wandhalterungen*. Der Abstand zwischen oberen und unteren *Wandhalterungen* beträgt 2640 mm.

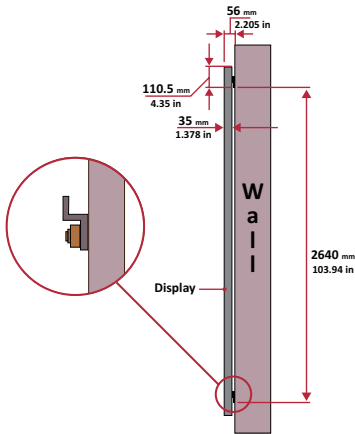

Hinweis: Sie können auch die oberen *Wandhalterungen* anbringen, den Bildschirm aufhängen und dann die unteren *Wandhalterungen* installieren. Dies sorgt für eine präzisere Passform.

- ❗ Stellen Sie sicher, dass die Wand 340 kg zuverlässig halten kann.
 - ❗ Stellen Sie sicher, dass die Abweichung der Wandfläche < 5 mm beträgt.
6. Nach Installation der oberen und unteren *Wandhalterungen* sollte die Installationswand so aussehen:

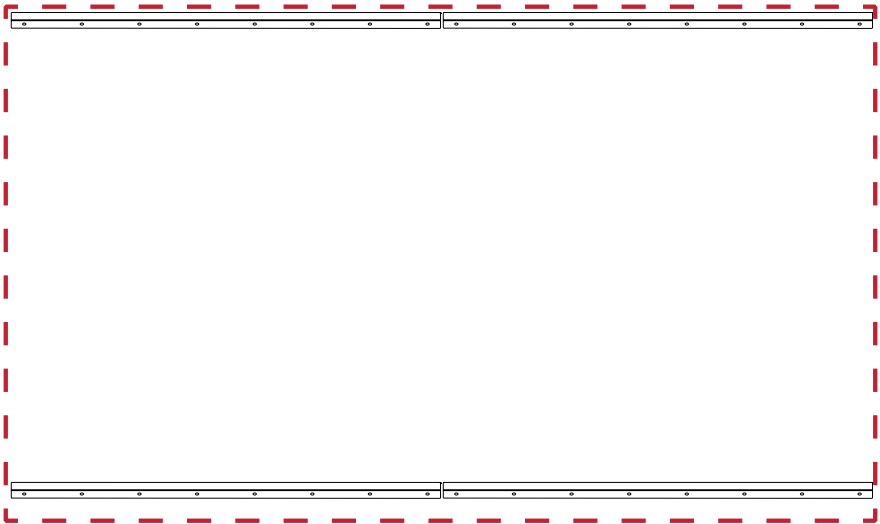

Mittlere Gehäuse installieren

1. Vergewissern Sie sich, dass die Halterungen auf der Rückseite der 6 mittleren Gehäuse wie nachstehend abgebildet an den oberen und unteren Montagepositionen positioniert sind:



2. Heben Sie jedes *mittlere Gehäuse* vorsichtig bis zu den oberen *Wandhalterungen*.

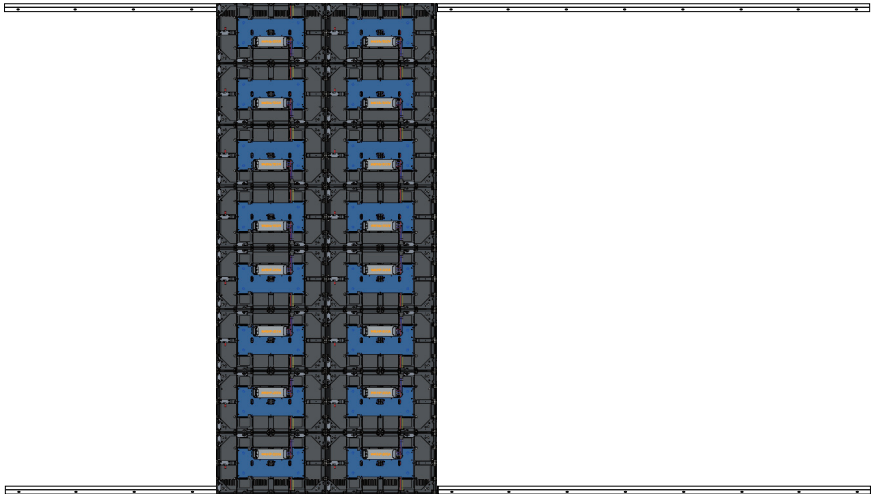

DEUTSCH

3. Vergewissern Sie sich, dass die *Halteungen* wie nachstehend gezeigt sicher auf den *Wandhalterungen* sitzen.

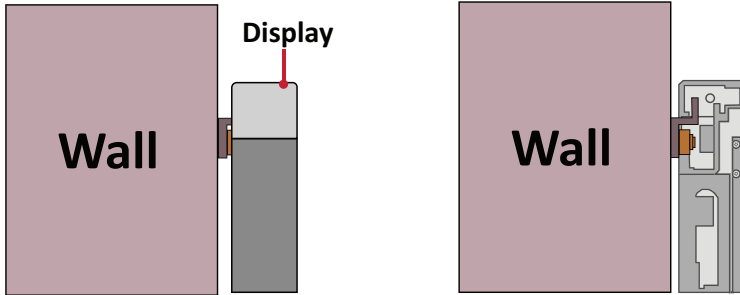

4. Drücken Sie jede *Sperrschraube* und verriegeln Sie jeden *Haken* mit dem Sechskantwerkzeug, damit die Schränke zuverlässig miteinander verbunden sind. Möglicherweise müssen Sie das Loch an einem Inbusschlüssel ausrichten, um die Sperrschraube festzuziehen.

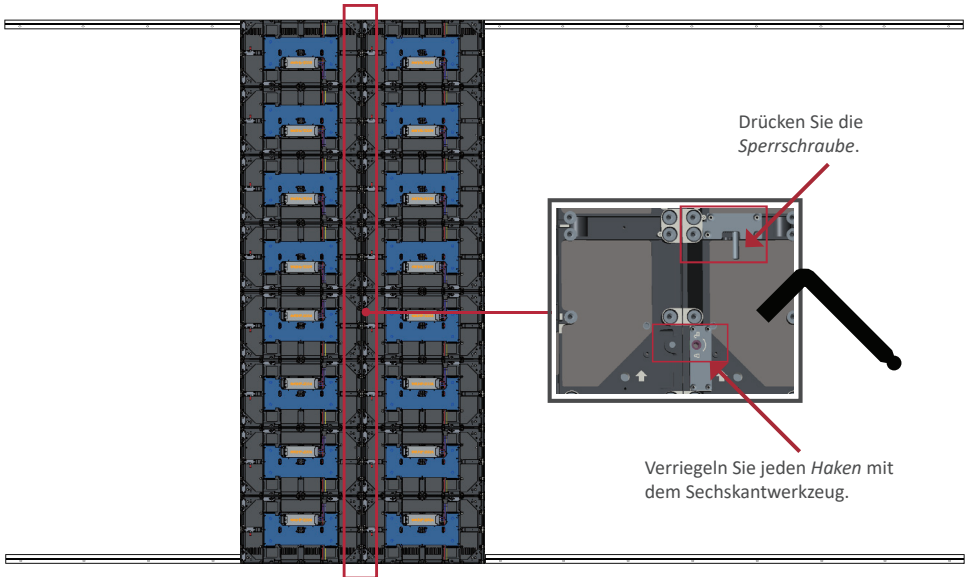

Hinweis: Es befinden sich 8 Sperrschrauben und 16 Haken zwischen jedem Gehäuse.

5. Heben Sie den verbleibenden mittleren Schrank auf die oberen Wandhalterungen. Achten Sie darauf, dass die Halterungen sicher an den Wandhalterungen sitzen.
6. Wiederholen Sie Schritt 4. Befestigen Sie die Schränke mit den jeweiligen Schrauben und Haken aneinander.

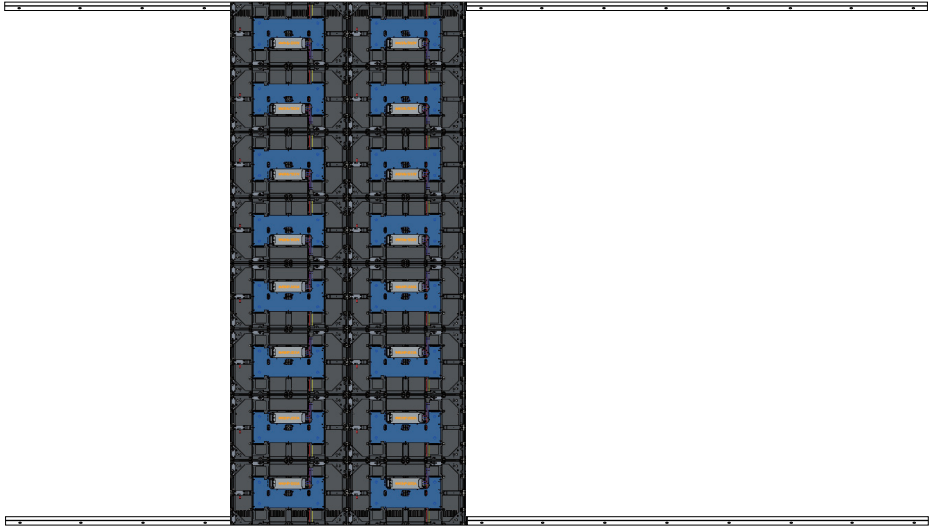

Linkes und rechtes Gehäuse installieren

1. Vergewissern Sie sich, dass die *Halteungen* auf der Rückseite des *linken* und *rechten Gehäuses* wie nachstehend abgebildet an den oberen und unteren Montagepositionen positioniert sind:

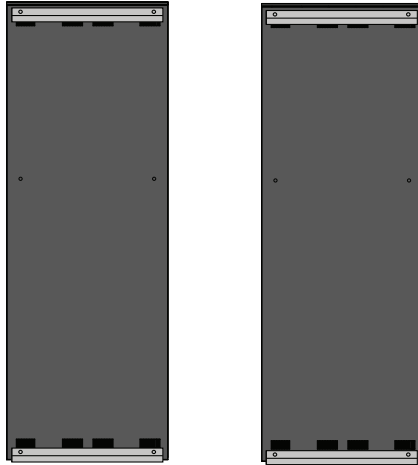

2. Heben Sie das *linke* und *rechte Gehäuse* vorsichtig auf die oberen *Wandhalterungen*, wobei Sie darauf achten, dass die *Halteungen* sicher auf den *Wandhalterungen* sitzen.

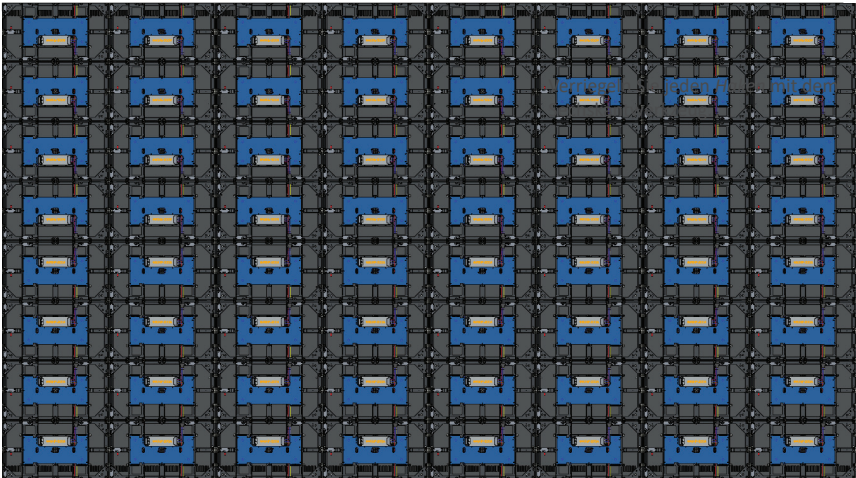

3. Passen Sie das *linke* oder *rechte Gehäuse* so an, dass sie nahtlos an den *mittleren Gehäusen* anliegen.

4. Drücken Sie jede *Sperrschraube* und verriegeln Sie jeden *Haken* mit dem Sechskantwerkzeug, damit *linke* und *rechte Gehäuse* zuverlässig verbunden sind. Möglicherweise müssen Sie das Loch an einem Inbusschlüssel ausrichten, um die Sperrschraube festzuziehen.

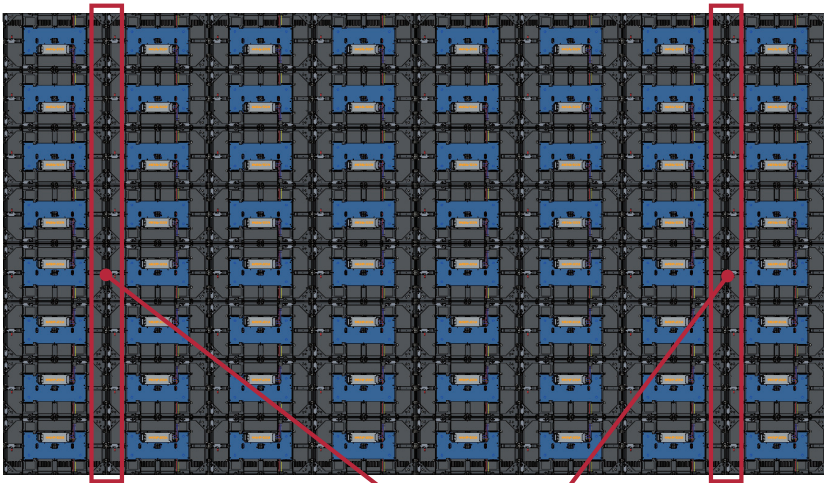

DEUTSCH

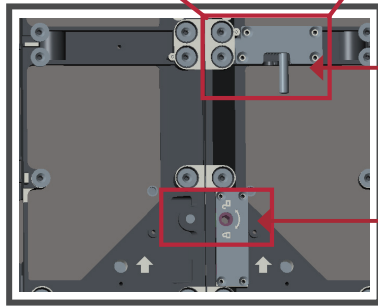

Drücken Sie die *Sperrschraube*.

Verriegeln Sie jeden *Haken* mit dem Sechskantwerkzeug.

Hinweis: Es befinden sich 8 *Sperrschrauben* und 16 *Haken* zwischen jedem Gehäuse.

Systemsteuerbox verbinden

1. Klappen Sie vorsichtig den Bildschirm der *Systemsteuerbox* auf. Vergewissern Sie sich, dass sich die Hauptsystemplatine links befindet.

Hinweis: Seien Sie vorsichtig, da die Blende der *Systemsteuerbox* in zwei Teile mit angebrachten Drähten unterteilt ist.

2. Richten Sie die Löcher des *Gehäuses* zur Bestätigung an der *Systemsteuerbox* aus.

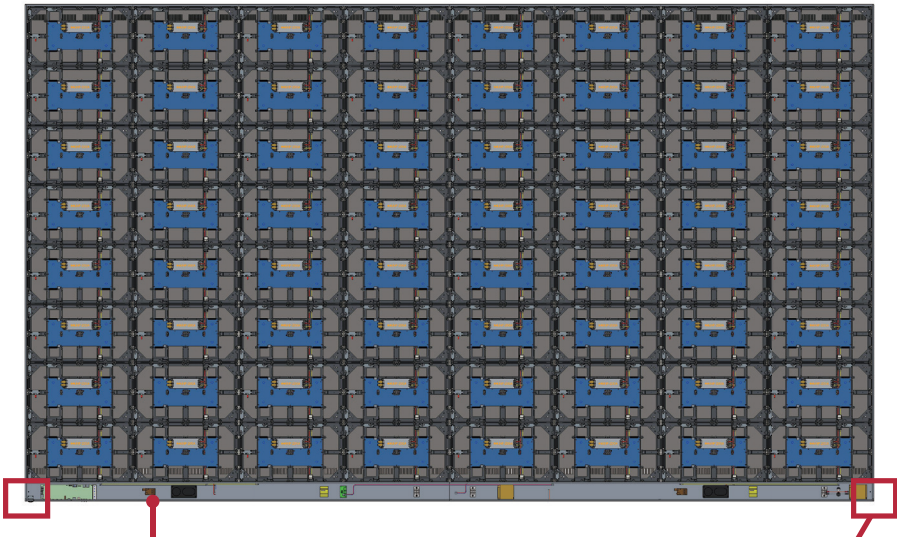

Systemsteuerungstafel

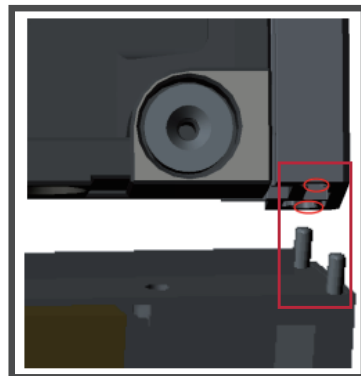

3. Sie können auch das Netzkabel für ein ansprechenderes Aussehen neu installieren. Lösen Sie die drei (3) PWM-Schrauben (4 x 6 mm), ziehen Sie das Netzkabel heraus, führen Sie das Netzkabel durch die hintere Öffnung und ziehen Sie die Schrauben fest.

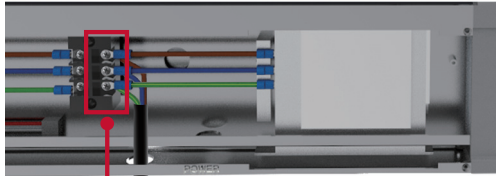
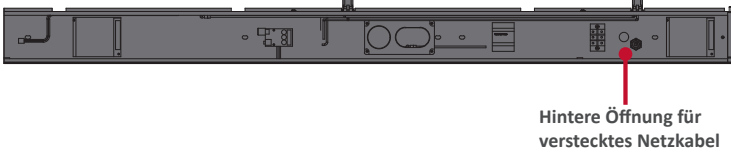

Drei (3) PWM-Schrauben (4 x 6 mm)

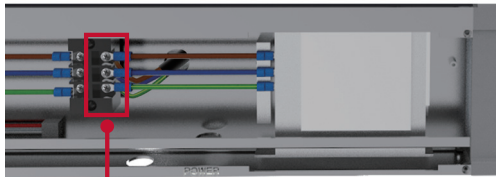

Drei (3) PWM-Schrauben (4 x 6 mm)

! Nur von Profis auszuführen.

4. Sichern Sie die *Systemsteuerbox* weiterhin an den *Gehäusen*; nutzen Sie dazu die 32 mitgelieferten Schrauben (M6 x 16 mm).

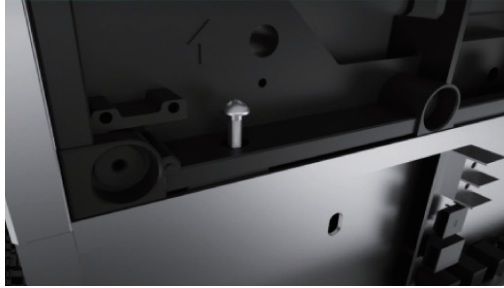

5. Schließen Sie Netzwerk- und Stromkabel der *Gehäuse* an die *Systemsteuerbox* an.
Hinweis: Es gibt 4 Netzwerk- und 8 Stromkabel zum Anschließen.

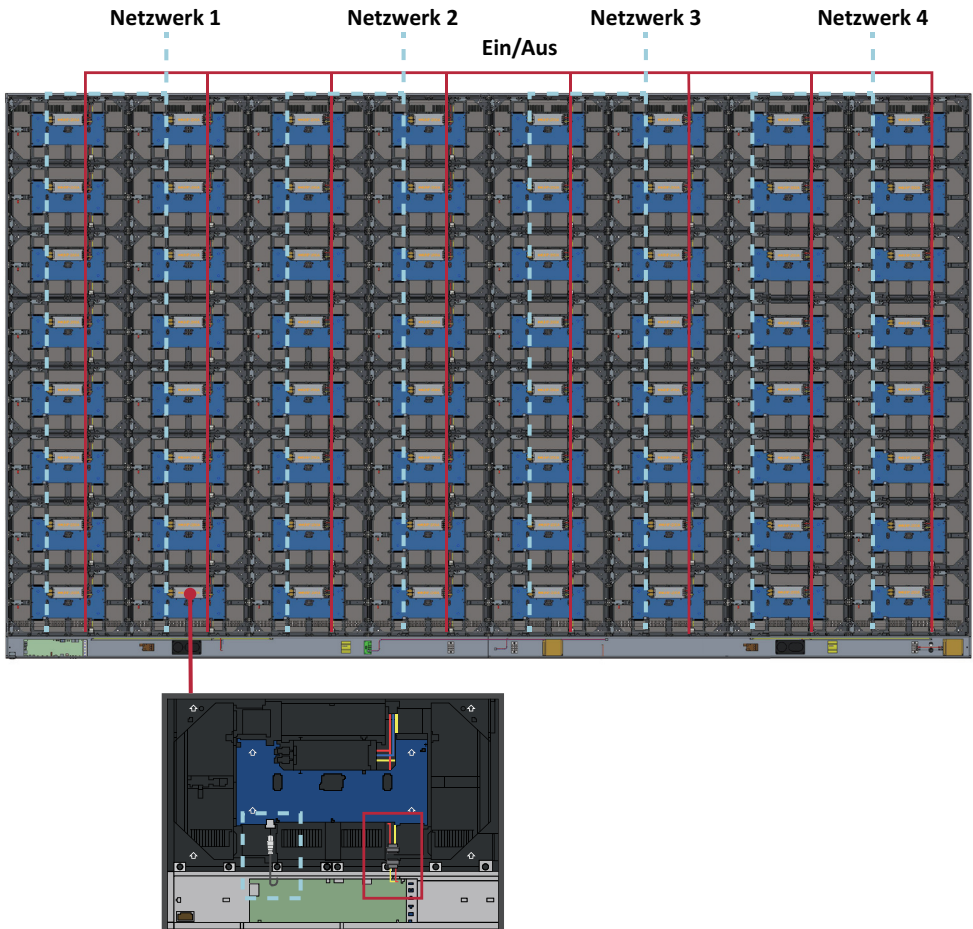

LED-Module installieren

Installieren Sie die jeweiligen *LED-Module* an den *Gehäusen*. Achten Sie darauf, die entsprechenden Zahlen an *Modul* und *Gehäuse* abzustimmen.

! Bitte ziehen Sie vor Handhabung der LED-Module Antistatikhandschuhe an.



Achten Sie darauf, dass jedes *Modul* bündig sitzt und kein Abstand zwischen diesen besteht. Möglicherweise müssen Sie sanft auf das Modul tippen, damit es bündig anliegt.

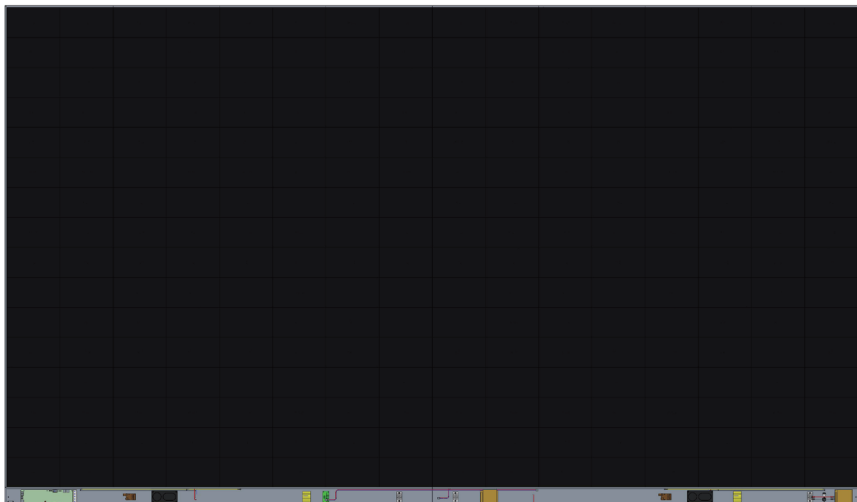

Abdeckungen der Systemsteuerbox installieren

Es gibt drei (3) Abdeckungen der Systemsteuerbox: Links, in der Mitte und rechts.



1. Beginnen Sie durch Installation der *rechten Abdeckung* an der *Systemsteuerbox*.

Hinweis: Vergewissern Sie sich, dass das Kabel der **Ein-/Austaste** mit dem Stromkabel der *Systemsteuerbox* verbunden ist, bevor Sie die *Abdeckung* befestigen.

2. Stellen Sie nach Anschluss des Kabels der **Ein-/Austaste** sicher, dass die *rechte Abdeckung* richtig an der *Systemsteuerbox* angeschlossen ist; sichern Sie sie dann mit den 18 mitgelieferten Schrauben (KM3 x 6 mm).



3. Wiederholen Sie die obigen Schritte bei der *mittleren* und *linken* Abdeckung.







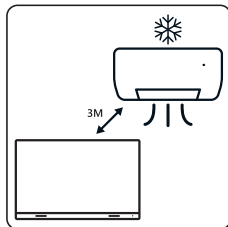
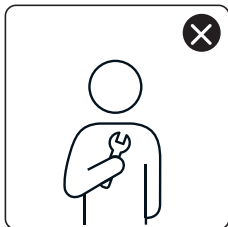
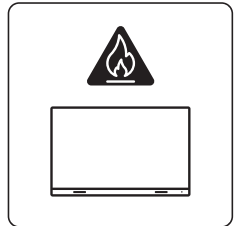
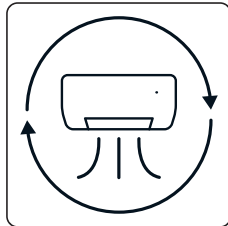
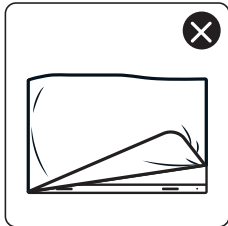
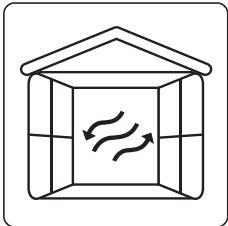
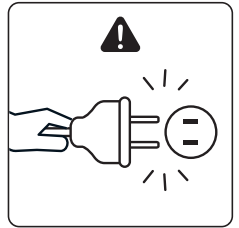
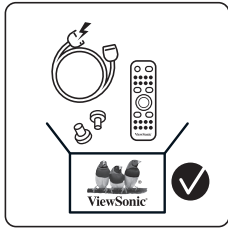
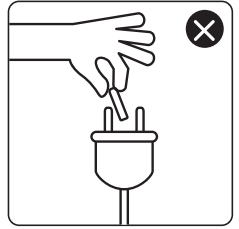
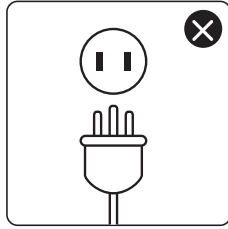
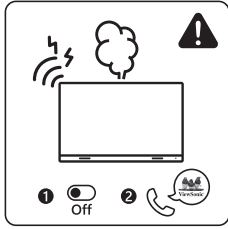
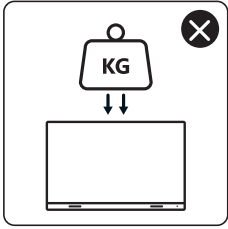
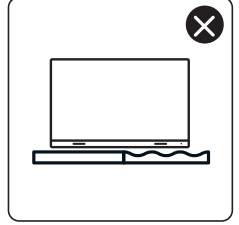
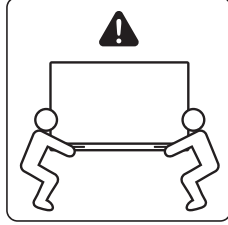
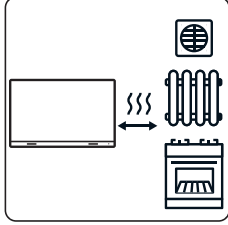
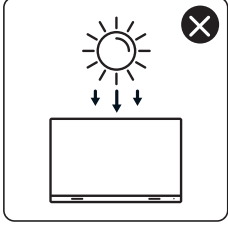
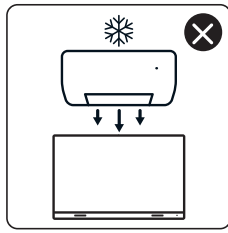
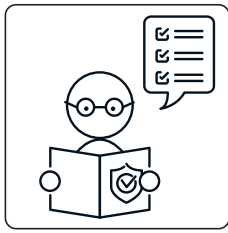
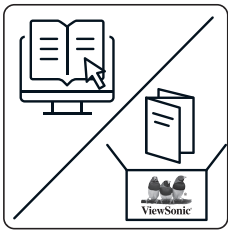

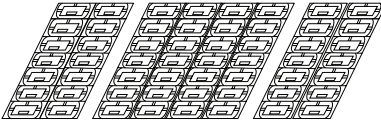
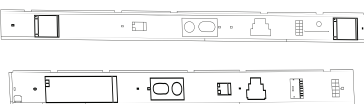
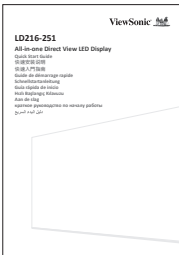
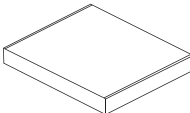

4. Ihr Display kann nun eingeschaltet werden.

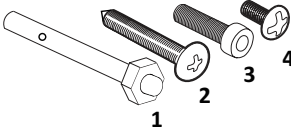

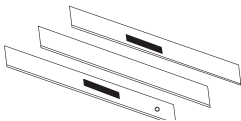

Contenido del paquete

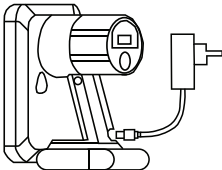
Elemento	Cantidad	Nota
Secciones de armario		8 secciones en total
Caja de control del sistema (Lados izquierdo y derecho)		2 lados
Guía de inicio rápido		1
Módulos de LED		128 módulos La cantidad de módulos LED de repuesto variará según el país.
Mando a distancia		1
Tornillos		48 x Expansión de M6x50mm (1) 48 x TA6x30mm (2) 32 x M6x16mm (3) 18 x KM3x6mm (4)
Herramienta hexagonal (llave Allen)		2 1 x 5 mm 1 x 8 mm

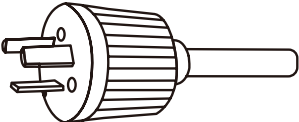
Elemento		Cantidad	Nota
Cubiertas de la caja de control del sistema (Lados izquierdo, central y derecho)		3	
Soportes para instalación en pared		4	
Herramienta de succión al vacío		1	
Guantes antiestáticos		2 pares	
Cable USB-A a USB-B (5 m)		1	
Cable de alimentación		2	El consumo de energía es grande, por lo que se requieren dos cables de alimentación y dos tomas de corriente dedicadas.

NOTA:

- Este producto está empaquetado en una caja para transporte aéreo.
- Debido al tamaño y peso, se recomienda que la manejen dos personas o más.

Descripción del producto

Panel frontal



Panel de control de E/S

Altavoz

Altavoz

Indicador y botón de alimentación

Panel posterior

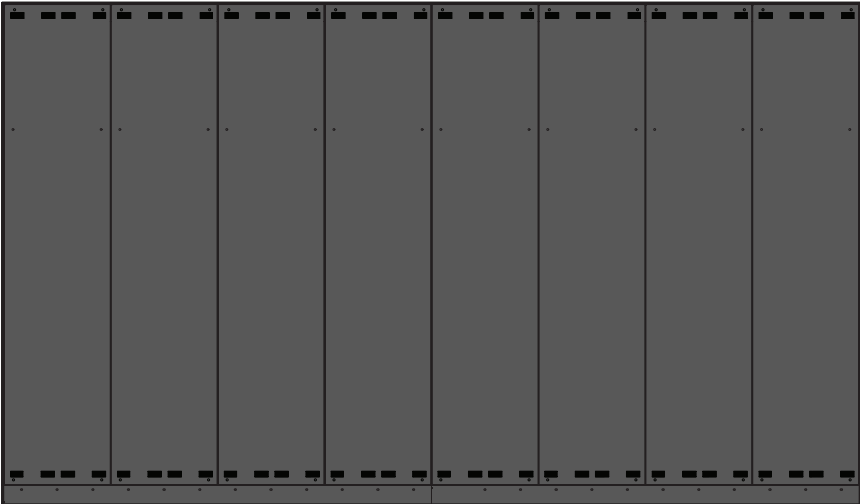

Introducción

Antes de realizar la instalación

- ! Mantenga un espacio de aire apropiado entre la parte posterior de la pantalla y cualquier pared para conseguir una ventilación adecuada.
- ! Asegúrese de que no haya flujo de aire directo procedente del aire acondicionado o de las aperturas de calefacción dirigido a la pantalla.
- ! Evite la instalación de la pantalla en lugares en los que haya mucha humedad.
- ! Debido al alto consumo de energía, utilice siempre cables de alimentación diseñados específicamente para este producto.

Instalación en pared

Instalación de los soportes de montaje en pared superior e inferior

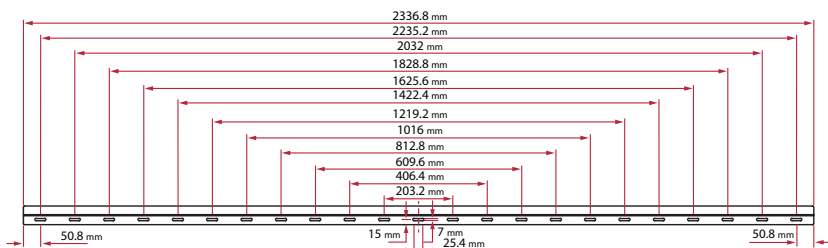

1. Asegúrese de que el área y el tamaño de la pared se encuentren en un sitio de instalación adecuado.

NOTA: La altura de los soportes para instalación en pared superiores no deben estar a menos de 3,3 metros (129,92") del suelo.

2. Sirviéndose del *soporte para instalación en pared* (en la imagen de arriba) como guía, marque al menos 12 orificios y pretaladre cada uno de ellos.
3. Instale el primer *soporte para instalación en pared* con los tornillos proporcionados (M6x50 mm de expansión para mampostería; TA6x30 mm para madera de soporte de carga).
4. Repita el **paso 2**, asegurándose de que el segundo *soporte para instalación en pared* está a nivel con el primer soporte superior.



5. Instale los *soportes para instalación en pared inferiores* de la misma manera que los *soportes para instalación en pared superiores*. La distancia entre los *soportes para instalación en pared superiores* e inferiores es de 2640 mm (103,94").

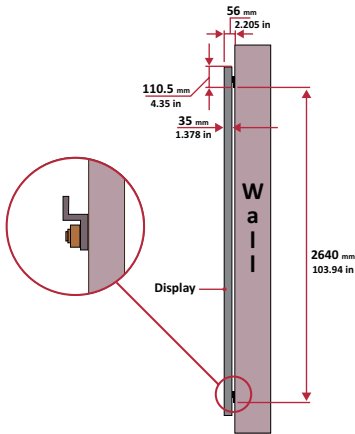

NOTA: También puede instalar los soportes para instalación en pared superiores, colgar la pantalla y, a continuación, instalar los soportes para instalación en pared para un ajuste más preciso.

- ! Asegúrese de que la pared pueda soportar de forma segura 749,57 lb. (340 kg).
 - ! Asegúrese de que la desviación de la superficie de la pared debe ser inferior a 5 mm (0,197 pulgadas)
6. Después de instalar los *soportes para instalación en pared superiores* e inferiores, la pared de instalación debe tener el aspecto siguiente:

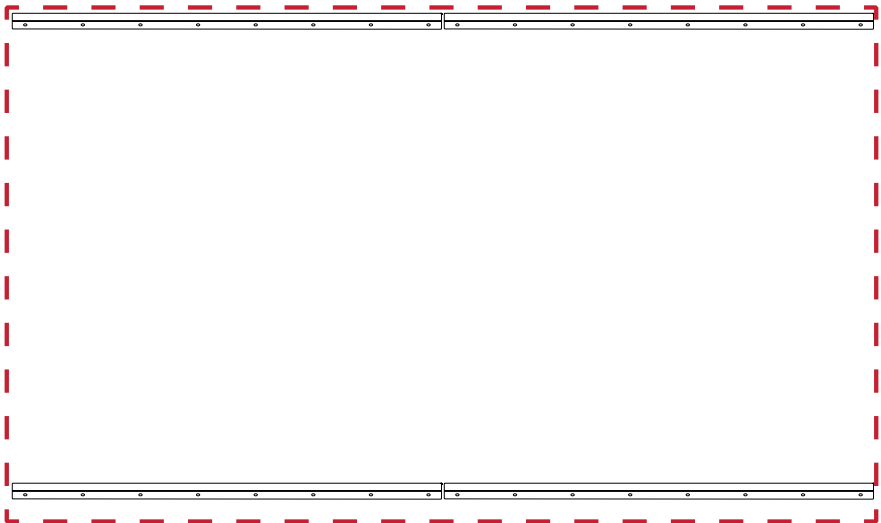

Instalar los armarios centrales

1. Asegúrese de que los soportes de instalación situados en la parte posterior de los 6 armarios centrales se encuentran colocados en las posiciones de instalación superior e inferior tal y como se muestra a continuación:



2. Levante con cuidado cada *armario central* hasta los *soportes para instalación en pared*.

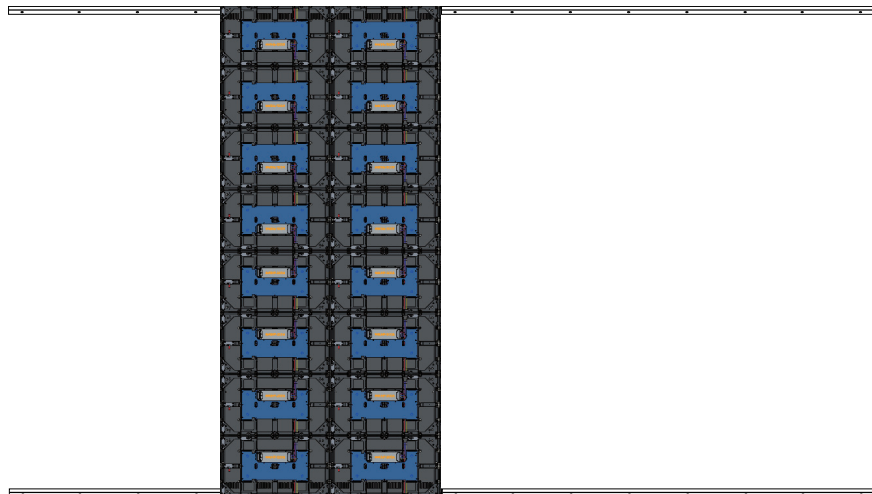

3. Asegúrese de que los *soportes de instalación* se asientan de forma segura en los *soportes para instalación en pared* tal y como se muestra a continuación.

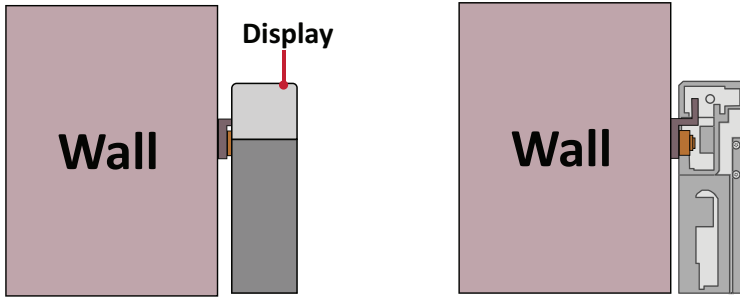

4. Empuje cada *tornillo de bloqueo* y bloquee cada *gancho* con la llave Allen para conectar de forma segura cada armario junto. Puede ser necesario alinear el orificio con una llave Allen para enganchar el tornillo de bloqueo.

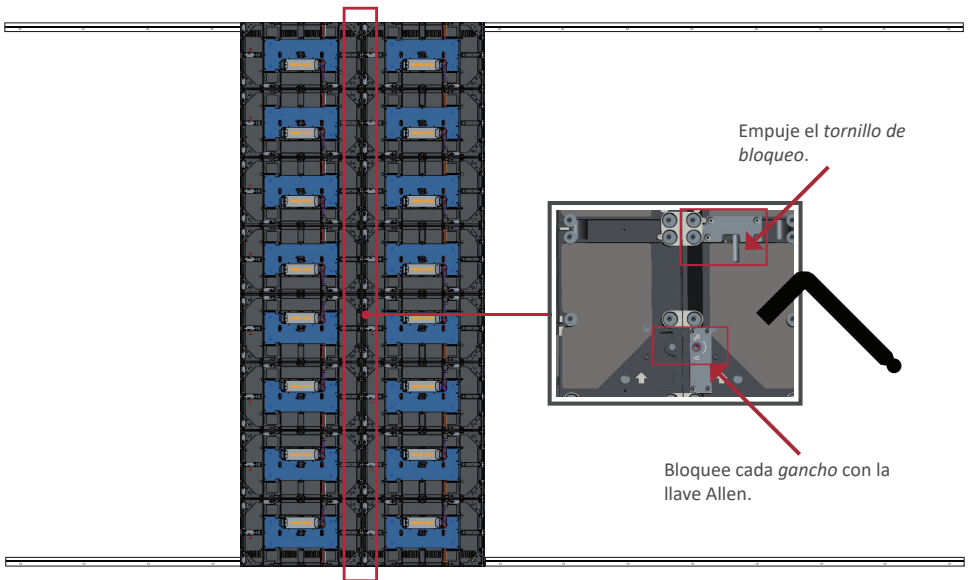

NOTA: Hay 8 tornillos de bloqueo y 16 ganchos entre cada armario.

5. Levante el armario central restante hasta los soportes para instalación en pared superiores, asegurándose de que los soportes de instalación se asientan de forma segura en los soportes para instalación en pared.
6. Repita el paso 4 fijando los armarios juntos con cada gancho y tornillo de bloqueo.

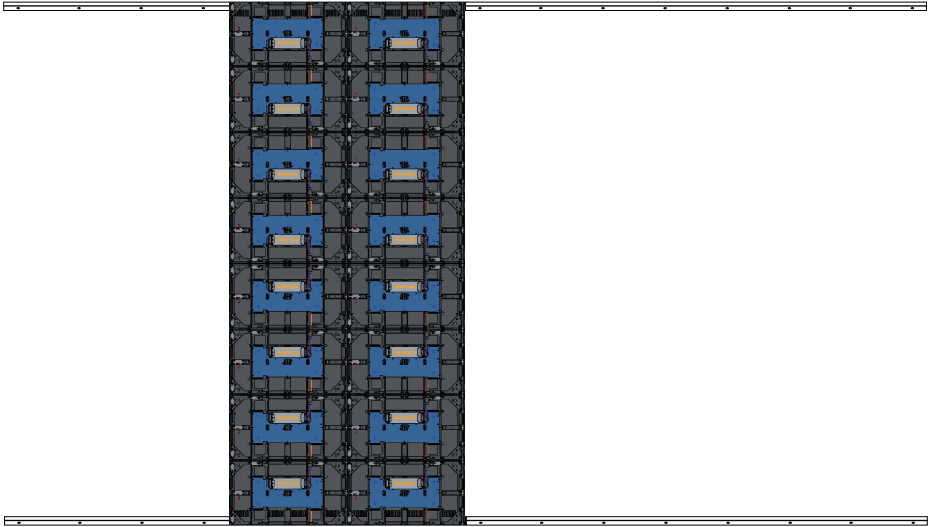

Instalar el armario izquierdo y derecho

1. Asegúrese de que los *soportes de instalación* situados en el *armario izquierdo y derecho* se encuentran colocados en las posiciones de instalación superior e inferior tal y como se muestra a continuación:

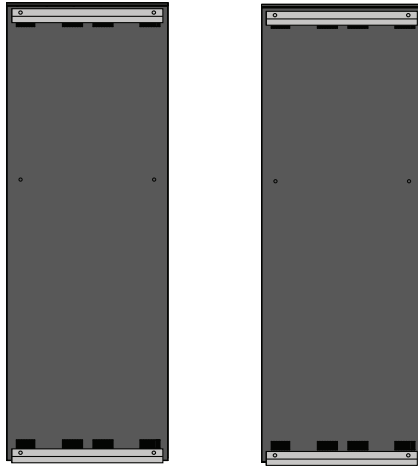

2. Levante con cuidado el *armario izquierdo y derecho* hasta los *soportes para instalación en pared* superiores, asegurándose de que los *soportes de instalación* se asientan de forma segura en los *soportes para instalación en pared*.

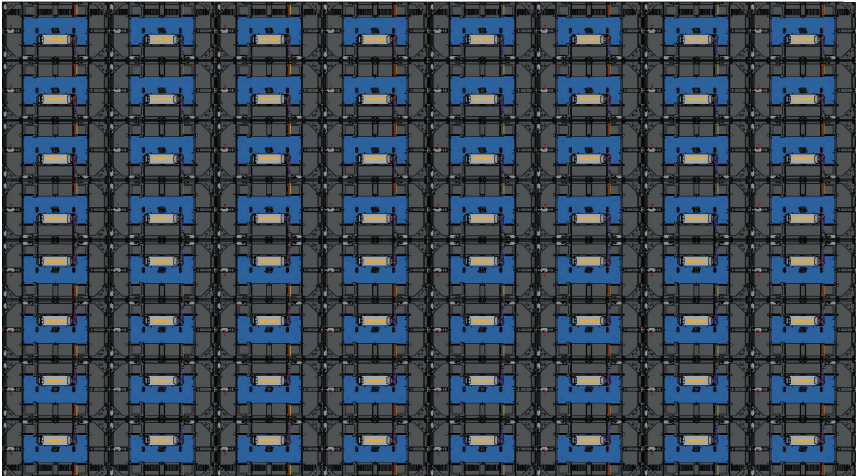

3. Ajuste el *armario izquierdo o derecho* de forma que encajen sin problemas con los *armarios centrales*.

4. Empuje cada *tornillo de bloqueo* y bloquee cada *gancho* con la llave Allen para conectar de forma segura los *armarios izquierdo y derecho*. Puede ser necesario alinear el orificio con una llave Allen para enganchar el tornillo de bloqueo.

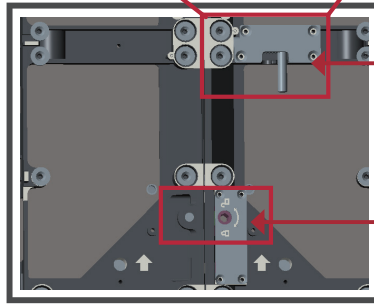
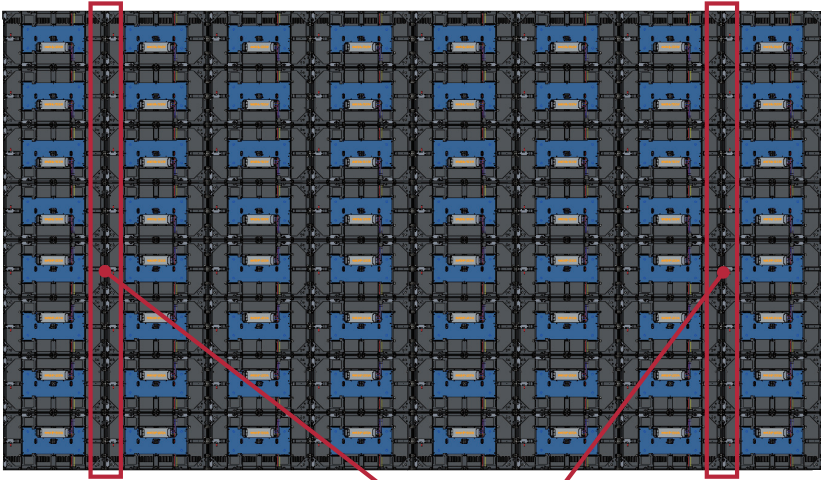

Empuje el *tornillo de bloqueo*.



Bloquee cada *gancho* con la llave Allen.

NOTA: Hay 8 *tornillos de bloqueo* y 16 *ganchos* entre cada armario.

Conectar la caja de control del sistema

1. Despliegue con cuidado el panel de la *caja de control del sistema*. Asegúrese de que la tarjeta de la caja de control del sistema está a la izquierda.

NOTA: Extremar las precauciones, ya que el panel de la *caja de control del sistema* se separará en dos piezas y los cables seguirán conectados.

2. Alinee los orificios del *armario* con la *caja de control del sistema* para realizar el acoplamiento.

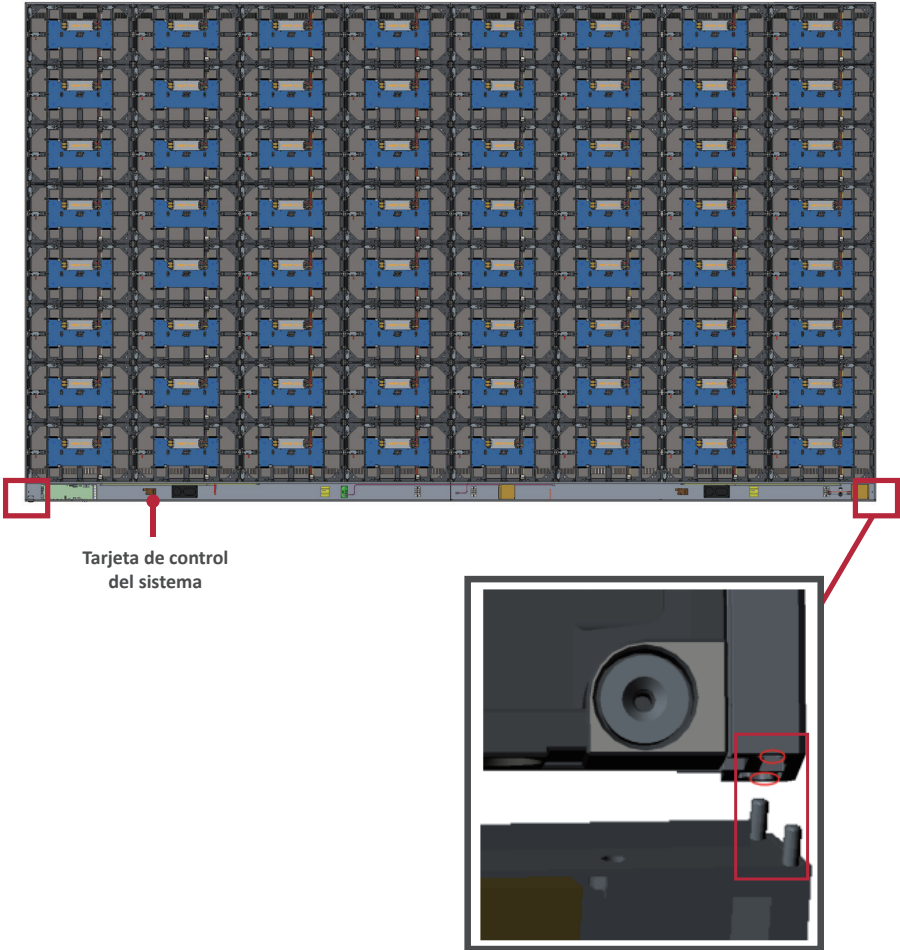

3. También puede volver a instalar el cable de alimentación para proporcionar una apariencia atractiva. Afloje los tres (3) tornillos PWM de 4x6 mm, extraiga el cable de alimentación, páselo por el orificio posterior y luego apriete los tornillos firmemente.

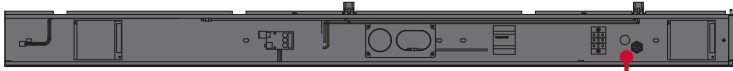

Orificio trasero para cable de alimentación oculto

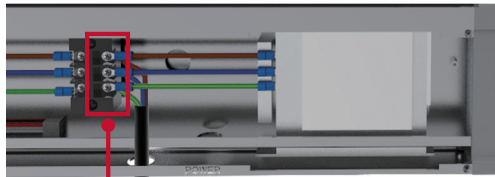

Tres (3) tornillos PWM de 4x6 mm

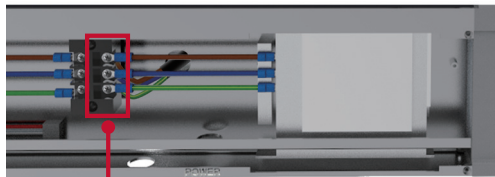

Tres (3) tornillos PWM de 4x6 mm

! Solo lo debe utilizar un profesional.

4. Asegure aún más la *caja de control del sistema* a los *armarios* con los 32 tornillos proporcionados (M6x16 mm)

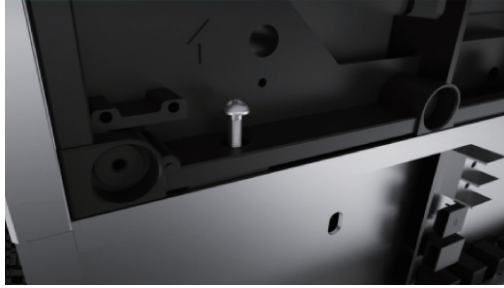

5. Conecte los cables de red y alimentación de los *armarios* a la *caja de control del sistema*.

NOTA: Hay 4 cables de red y 8 cables de alimentación para conectar.

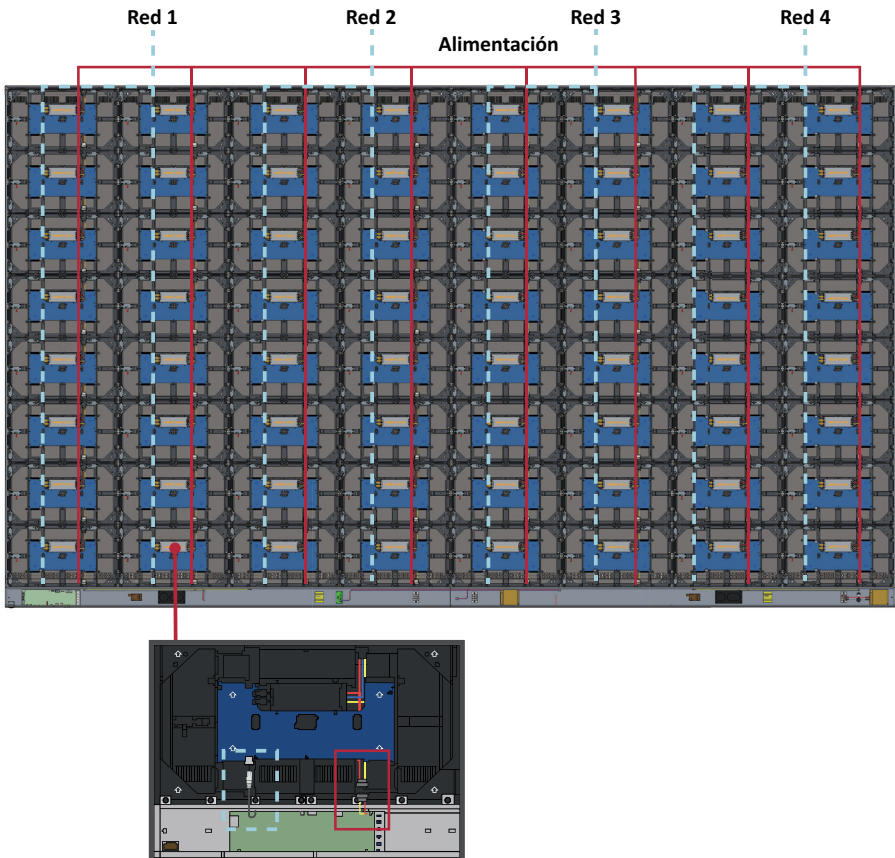

Instalar los módulos de LED

Instale cada *módulo de LED* en los *armarios*, asegurándose de que coincidan los números correspondientes del *módulo* y del *armario*.

❗ Póngase unos guantes antiestéticos antes de manipular los módulos de LED.



Asegúrese de que los *módulos* están alineados entre sí y que apenas hay separación entre cada uno de ellos. Puede que sea necesario golpear suavemente el módulo para que quede al ras.

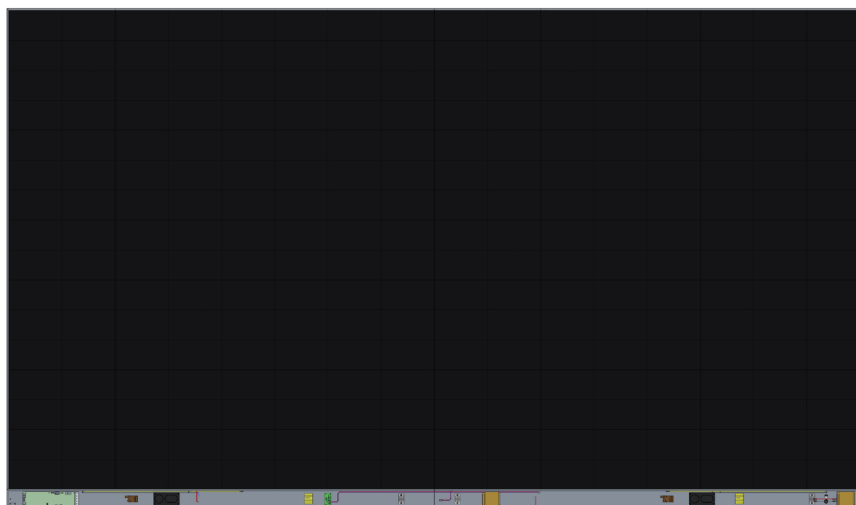

Instalar las cubiertas de la caja de control del sistema

Hay tres (3) cubiertas de caja de control del sistema: Izquierda, central y derecha.



1. Comience instalando la *cubierta derecha* en la *caja de control del sistema*.

NOTA: Asegúrese de que el cable del **botón de alimentación** está conectado al cable de alimentación de la *caja de control del sistema* antes de fijar la *cubierta*.

2. Después de conectar el cable del **botón de alimentación**, asegúrese de que la *cubierta derecha* está correctamente alineada con la *caja de control del sistema*; a continuación, asegúrela con los 18 tornillos KM3x6 mm proporcionados.



3. Pepita los pasos anteriores para la *cubierta central e izquierda*.





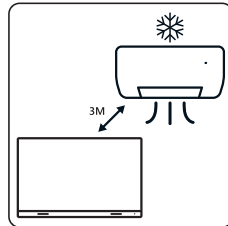
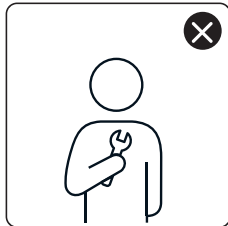
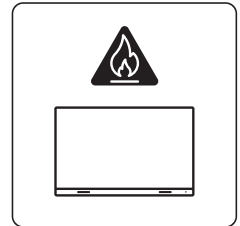
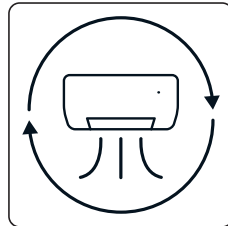
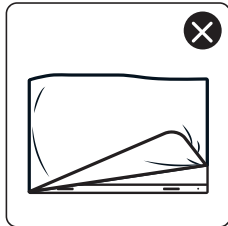
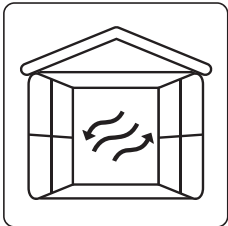
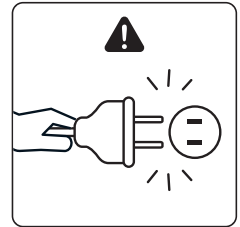
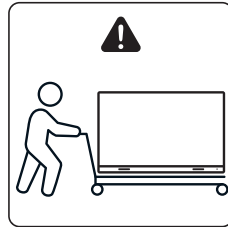
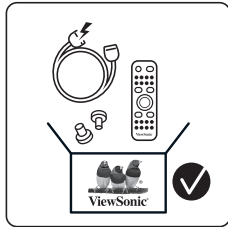
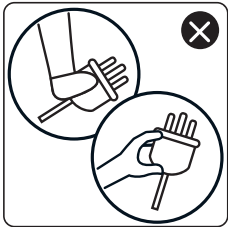
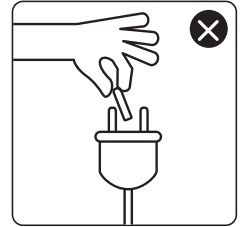
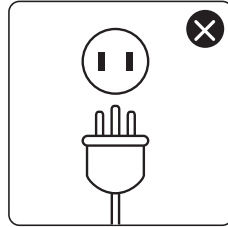
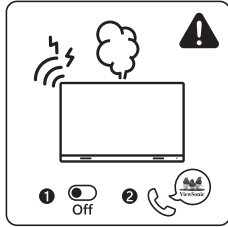
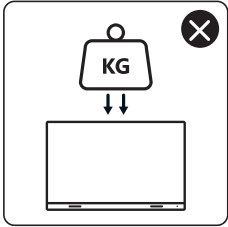
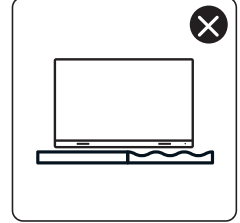
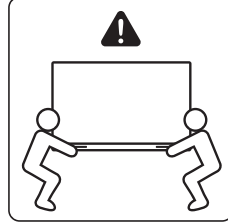
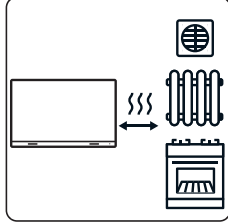
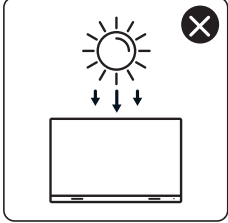
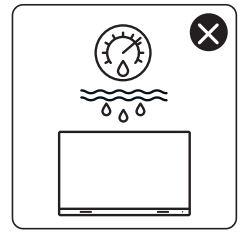
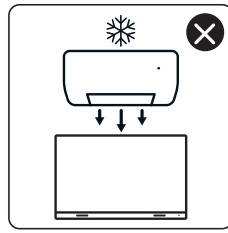
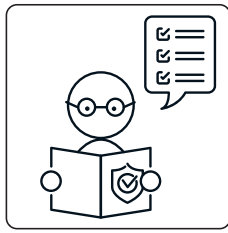
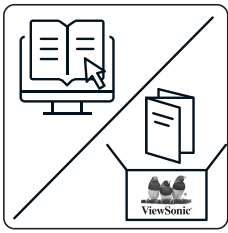

4. Su pantalla ahora está lista para encenderse.



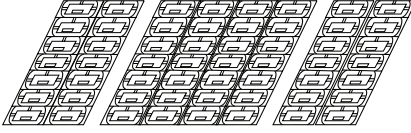
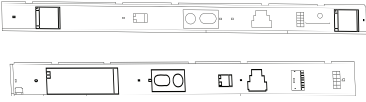
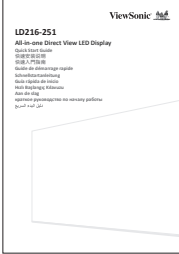
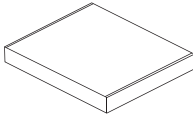

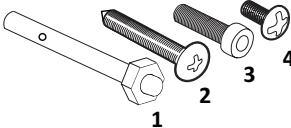
Paket İeriđi

Öge	Miktar	Not	
Kasanın Kısımları		Toplam 8 kısım	
Sistem Kontrol Kutusu (Sol ve Sağ taraflar)		2 taraf	
Hızlı Başlangı Kılavuzu		1	
LED Modüller		128 modül	Yedek LED modüllerinin adedi ülkeye göre farklılık gösterir.
Uzaktan Kumanda		1	
Vidalar		48 x M6x50mm Genişletme (1) 48 x TA6x30mm (2) 32 x M6x16mm (3) 18 x KM3x6mm (4)	
Allen Anahtarı		2 1 x 5 mm 1 x 8 mm	

Öge	Miktar	Not
Sistem Kontrol Kutusu Kapakları (Sol, Orta ve Sağ taraflar)	3	
Duvara Montaj Braketleri	4	
Vakumlu Emme Aracı	1	
Antistatik Eldivenler	2 çift	
USB-A - USB-B Kablosu (5 m)	1	
Güç Kablosu	2	Güç tüketimi çok fazladır, bu nedenle iki güç kablosu ve iki ayrı güç prizi gereklidir.

NOT:

- Bu ürün hava ulaşımı kutusuna paketlenmiştir.
- Boyut ve ağırlık nedeniyle, iki veya daha fazla kişinin taşınması önerilir.

Ürüne Genel Bakış

Ön Panel

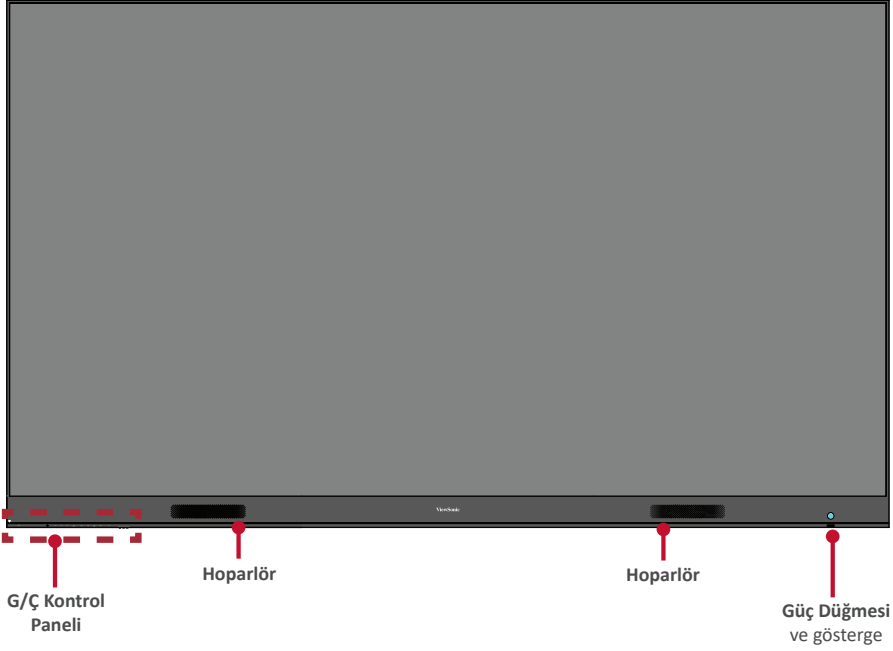

Arka Panel

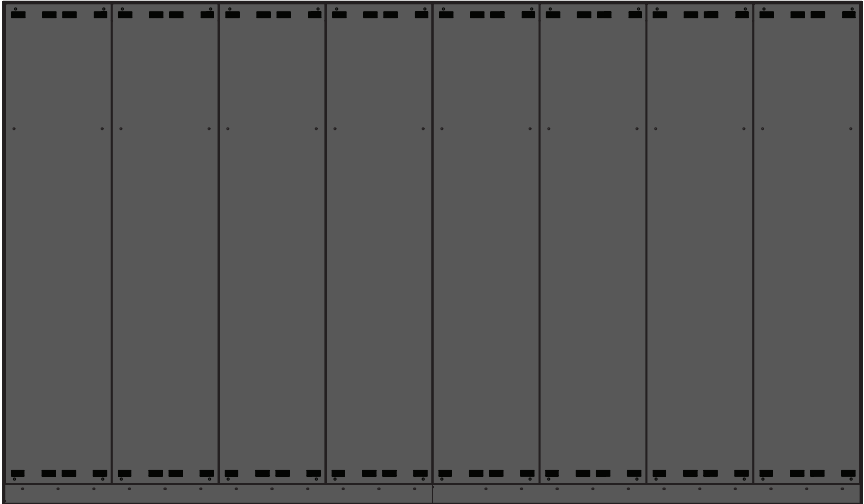

Giriş

Kurmadan Önce

- ! Uygun havalandırma için ekranın arkası ve duvar arasında yeterli hava boşluğunu koruyun.
- ! Klimadan ve ısıtma hava deliklerinden ekran üzerine esen doğrudan hava akışı olmadığından emin olun.
- ! Ekranı çok nemli yerlere yüklemekten kaçının.
- ! Yüksek güç kullanımı nedeniyle her zaman özellikle bu ürün için tasarlanmış güç kabloları kullanın.

Duvara Kurulum

Üst ve Alt Duvara Montaj Braketlerini Takma

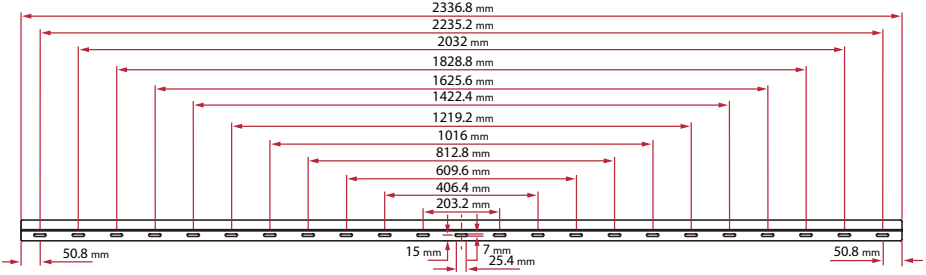

1. Duvar alanı ve boyutun kurulum alanı için uygun olduğundan emin olun.

NOT: Üst Duvara Montaj Braketlerinin yerden yüksekliği 129,92" (3,3 metre)'den az olmamalıdır.

2. *Duvara Montaj Braketi*'ni (yukarıda resmedilen) bir kılavuz olarak kullanarak en az 12 deliği işaretleyin ve önceden delin.
3. İlk *Üst Duvara Montaj Braketi*'ni sağlanan vidalarla takın (duvar işi için M6x50 mm Genişletme; yük taşıma ahşabı için TA6x30 mm).
4. İkinci *Üst Duvara Montaj Braketinin* ilk üst braketle aynı seviyede olduğundan emin olarak **Adım 2**'yi tekrarlayın.



5. Alt Duvara Montaj Braketlerini Üst Duvara Montaj Braketleri ile aynı şekilde takın. Üst ve Alt Duvara Montaj Braketleri arasındaki mesafe 103,94" (2640 mm)'dir.

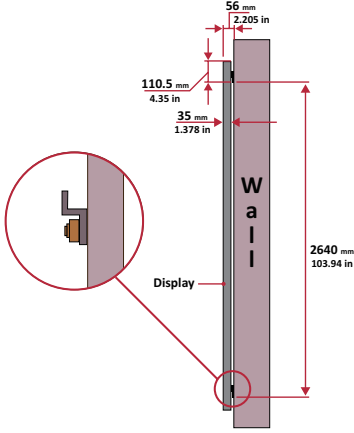

NOT: Ayrıca Üst Duvara Montaj Braketlerini takabilir, ekranı asabilir ve sonra daha düzgün yerleşmesi için Alt Duvara Montaj Braketlerini takabilirsiniz.

❗ Duvarın 749,57 lb'yi (340 kg) güvenli bir şekilde desteklediğinden emin olun.

❗ Duvar yüzeyinin sapsmasının <5mm (0,197 inç) olduğundan emin olun.

6. Hem Üst hem de Alt Duvara Montaj Braketlerini taktıktan sonra yükleme duvarı şu şekilde görünmelidir:

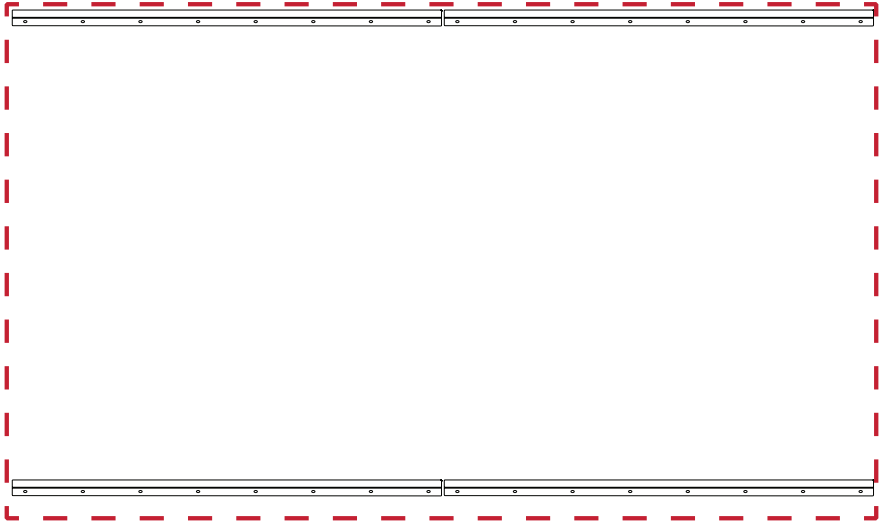

Orta Kasaları Takma

1. 6 Orta Kasanın arkasındaki Montaj Braketlerinin aşağıda gösterildiği gibi üst ve alt konumlarda bulunduğundan emin olun:

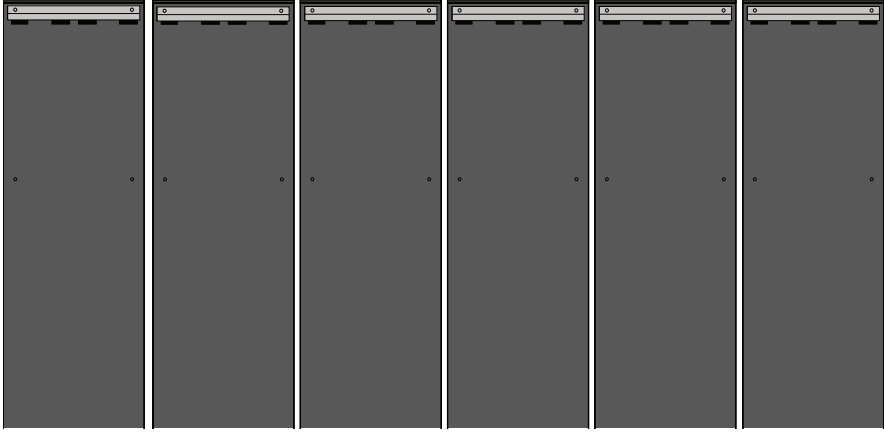

2. Her bir *Orta Kasayı* dikkatli bir şekilde *Üst Duvara Montaj Braketleri* üzerine yukarı kaldırın.

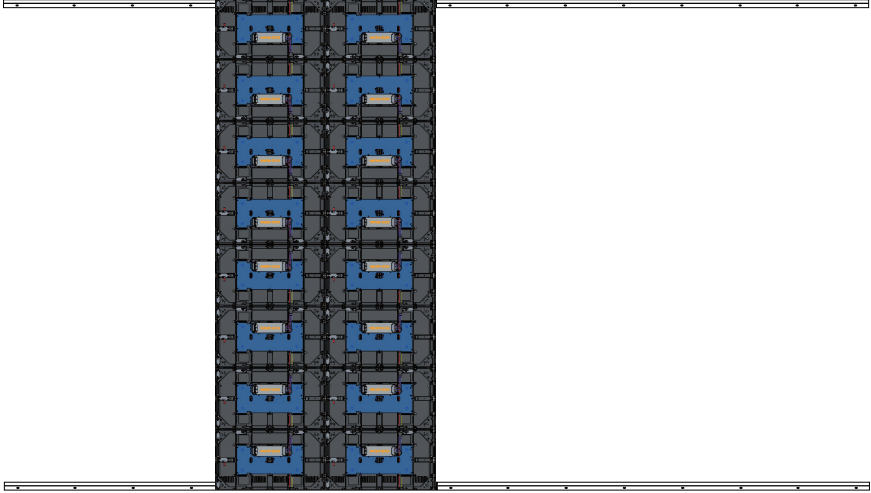

3. Montaj Braketlerinin gösterildiği gibi Duvara Montaj Braketleri üzerine güvenli bir şekilde oturduğundan emin olun.

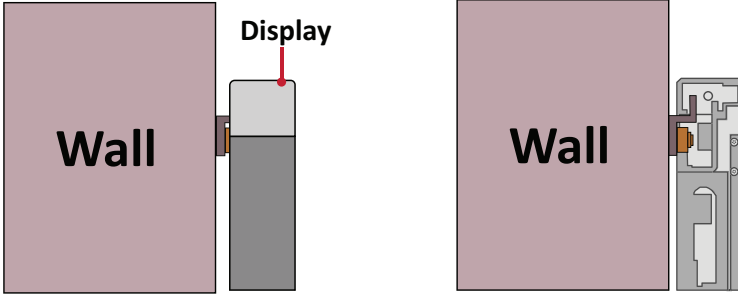

4. Her bir Kilitleme Cıvatasını itin ve her bir kasayı sıkıca birbirine bağlamak için her bir Kancayı allen anahtarı ile kilitleyin. Kilitleme Cıvatasını etkin hale getirmek için deliği alyan anahtarıyla hizalamak gerekebilir.

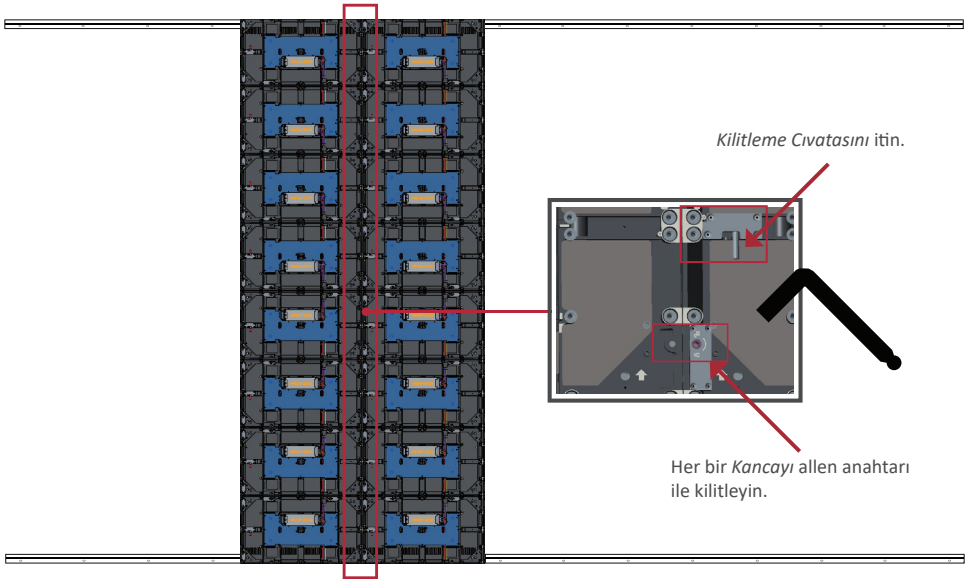

NOT: Her bir kabin arasında 8 Kilitleme Cıvatası ve 16 Kanca bulunur.

5. Montaj Braketlerinin Duvar Montaj Braketlerine sıkıca oturduğundan emin olarak kalan Orta Kabini Üst Duvar Montaj Braketlerine kaldırın.
6. Dolapları her bir Kilitleme Cıvatası ve Kancası ile sabitleyerek Adım 4'ü tekrar edin.

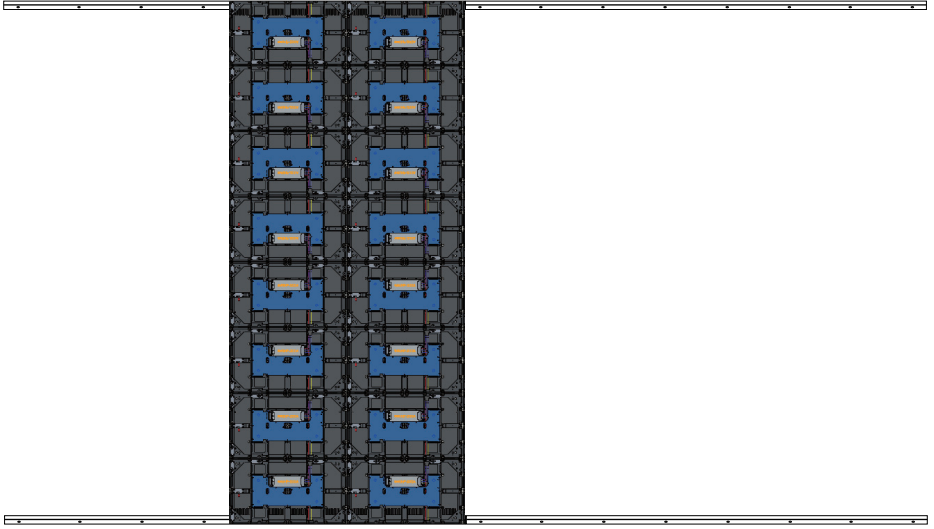

Sol ve Sağ Kabini Takma

1. *Sol ve Sağ Kasa* arkasındaki *Montaj Braketlerinin* aşağıda gösterildiği gibi üst ve alt montaj konumlarına yerleştirildiğinden emin olun:

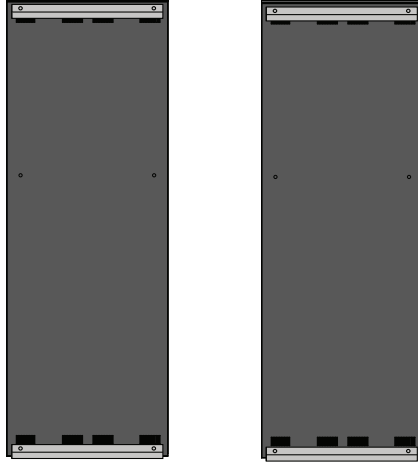

2. *Sol ve Sağ Kasa'yı* dikkatle *Üst Duvara Montaj Braketleri* üzerine kaldırın, *Montaj Braketlerinin Duvara Montaj Braketleri* üzerine iyice oturduğundan emin olun.

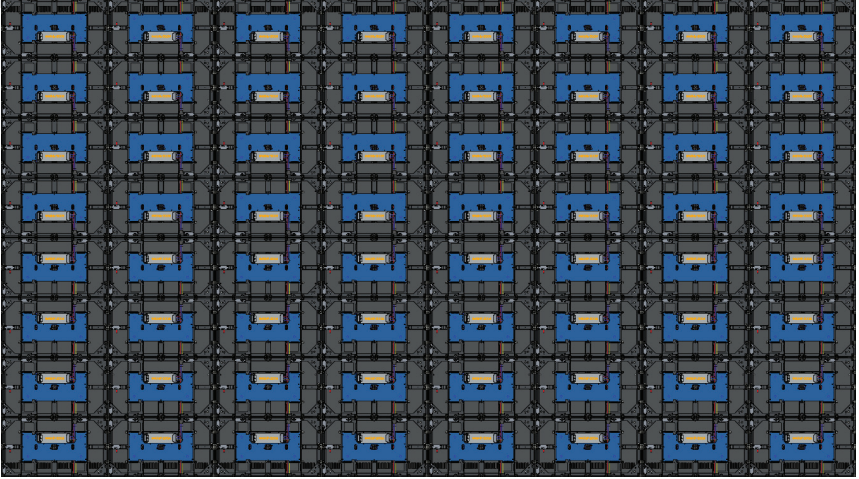

3. *Orta Kasalara* kusursuz şekilde oturacak şekilde *Sol* veya *Sağ Kasayı* ayarlayın.

4. Her bir *Kilitleme Cıvatasını* itin ve *Sol* ve *Sağ Kasaları* sıkıca sabitlemek için her bir *Kanca*yı allen anahtarı ile kilitleyin. Kilitleme Cıvatasını etkin hale getirmek için deliği alyan anahtarıyla hizalamak gerekebilir.

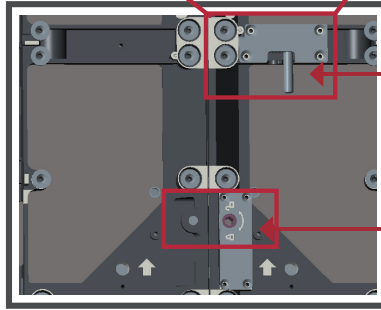
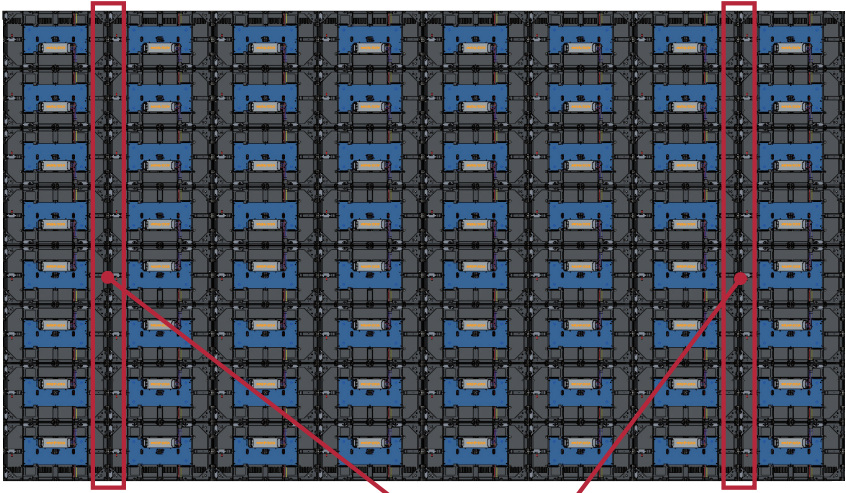

Kilitleme Cıvatasını itin.

Her bir *Kanca*yı allen anahtarı ile kilitleyin.

NOT: Her bir kabin arasında 8 *Kilitleme Cıvatası* ve 16 *Kanca* bulunur.

Sistem Kontrol Kutusunu Baęlama

1. Dikkatli bir şekilde *Sistem Kontrol Kutusu* panelinin katını aęın. Ana sistem kontrol panosunun solda olduęundan emin olun.

NOT: *Sistem Kontrol Kutusu* panelinin takılı kablolarla iki paręaya ayrıldıęına dikkat edin.

2. Takmak için *Kasanın* deliklerini *Sistem Kontrol Kutusu* ile hizalayın.

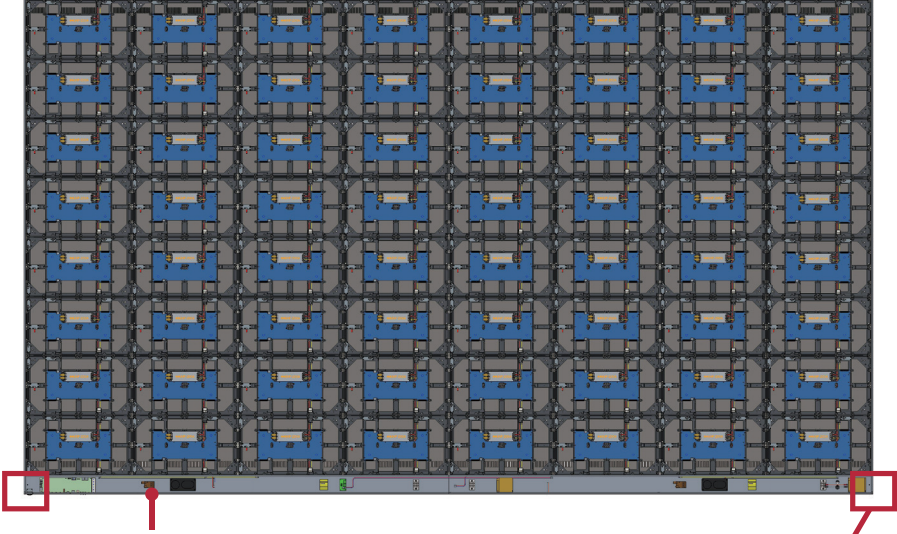

Sistem Kontrol Panosu

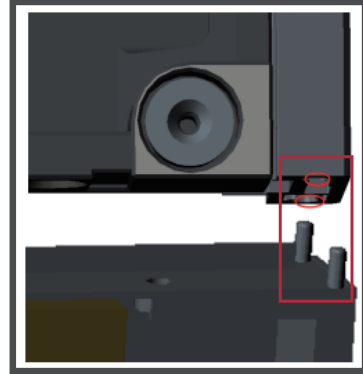

3. Ayrıca çekici bir görünüm için güç kablosunu yeniden takabilirsiniz; üç (3) PWM 4x6mm vidayı gevşetin, güç kablosunu çekin, güç kablosunu arka delikten geçirin ve vidaları sıkıca sabitleyin.

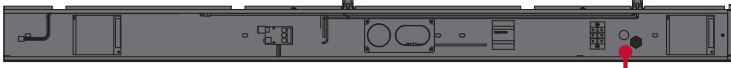

Gizli güç kablosu için arka delik

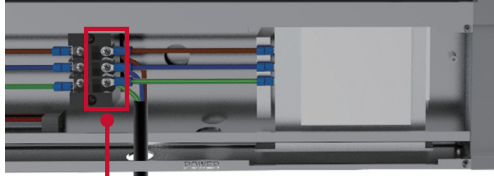

Üç(3) PWM 4x6mm Vida

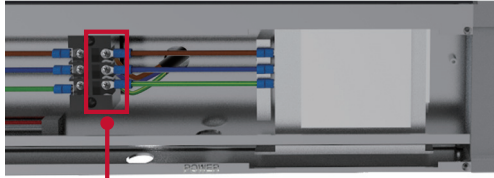

Üç(3) PWM 4x6mm Vida

! Yalnızca profesyonel tarafından çalıştırılmalıdır.

4. Ayrıca *Sistem Kontrol Kutusunu Kasalara* ürünle birlikte verilen 32 vidayla (M6x16 mm) sabitleyin.

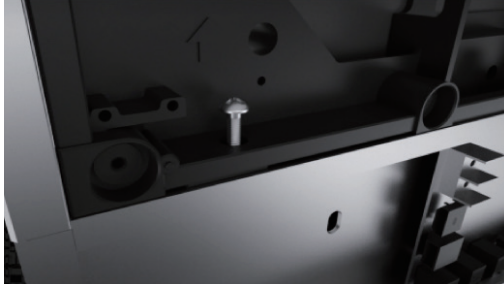

5. *Kasaların Ağ ve Güç kablolarını Sistem Kontrol Kutusuna* bağlayın.

NOT: Bağlanacak 4 Ağ ve 8 Güç kablosu vardır.

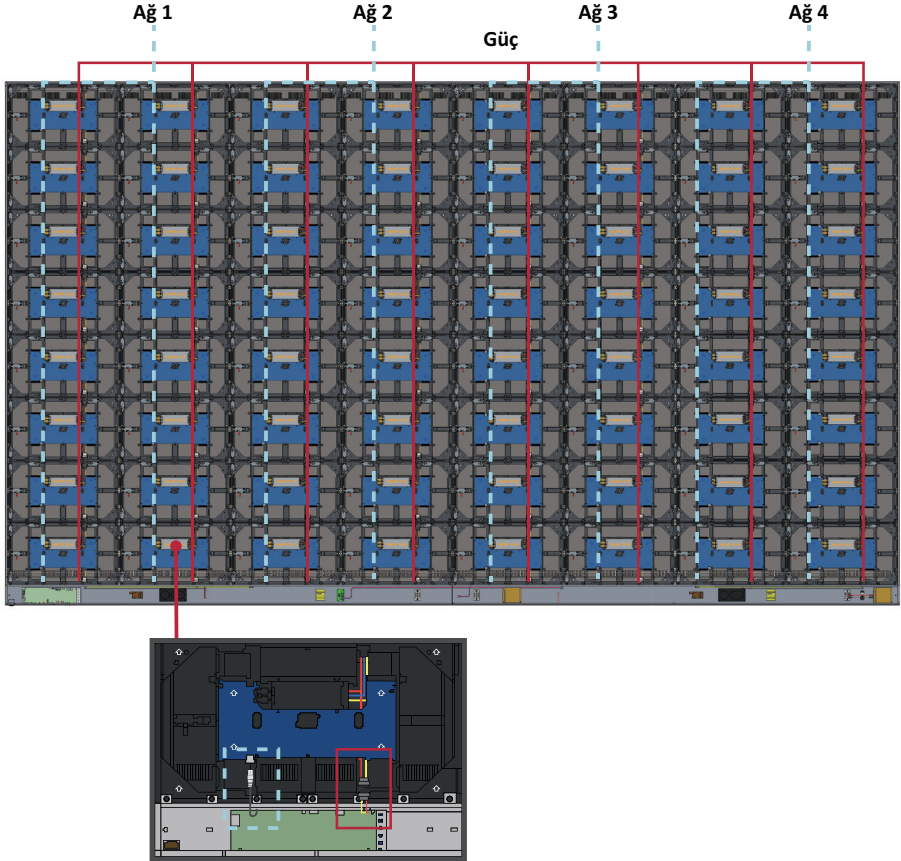

LED Modüllerini Takma

Modül üzerindeki ilgili sayıların *Kasa* ile eşleştiğinden emin olarak her bir *LED Modülünü* *Kasalar* üzerine takın.

❗ LED modülleri tutmadan önce lütfen Antistatik Eldivenler takın.



Her bir *Modülü* boşalttığınızdan ve birbiri arasında hiç boşluk olmadığından ya da az boşluk olduğundan emin olun. Boşaltmak için modüle hafifçe dokunmak gerekebilir.



Sistem Kontrol Kutusu Kapaklarını Takma

Üç (3) Sistem Kontrol Kutusu Kapağı vardır: Sol, Orta ve Sağ.



1. *Sağ Kapağı Sistem Kontrol Kutusu* üzerine takın.

NOT: *Kapağı* sabitlemeden önce **Güç Düğmesi** kablosunun *Sistem Kontrol Kutusu* Güç kablosuna bağlandığından emin olun.

2. **Güç Düğmesi** kablosunu bağladıktan sonra *Sağ Kapağın* *Sistem Kontrol Kutusu* ile düzgün hizalandığından emin olun; sonra ürünle birlikte verilen 18 KM3x6 mm vidayla sabitleyin.



3. *Orta ve Sol Kapak* için yukarıdaki adımları tekrarlayın.

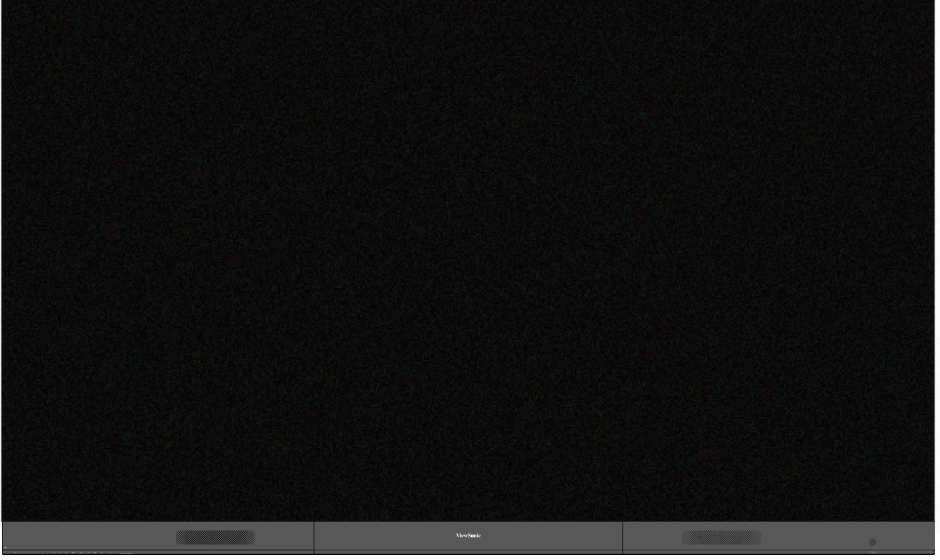





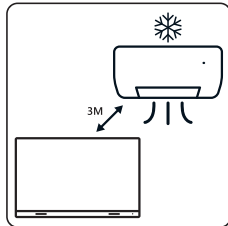
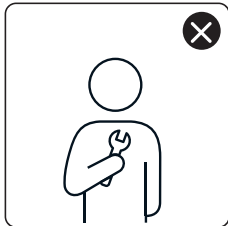
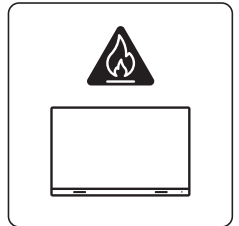
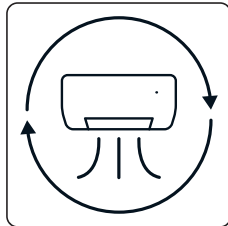
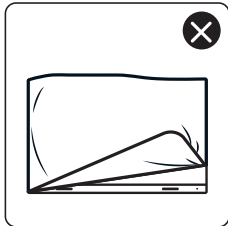
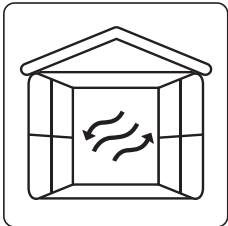
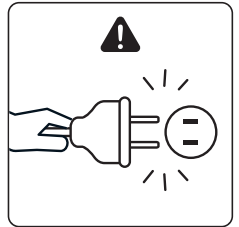
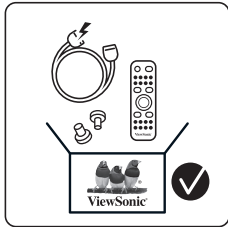
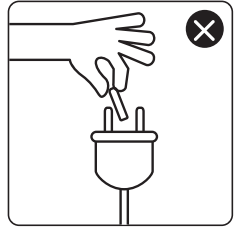
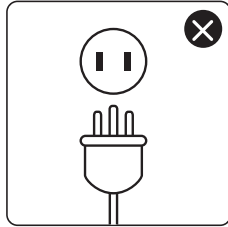
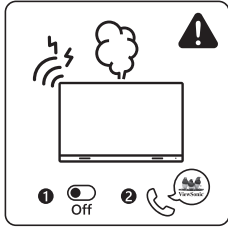
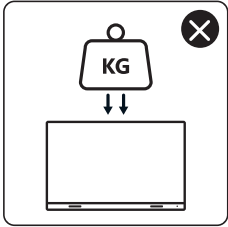
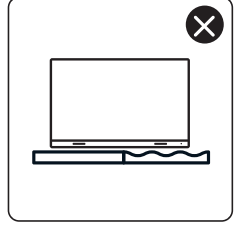
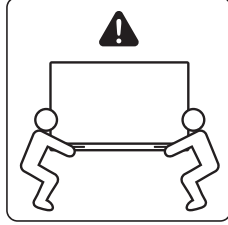
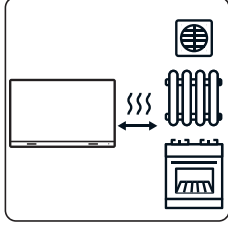
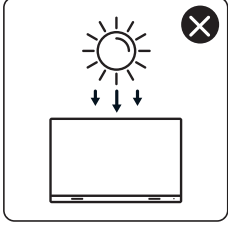
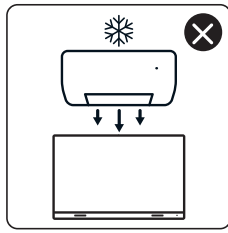
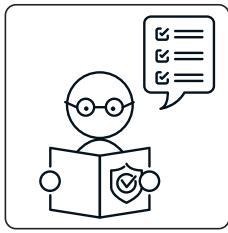
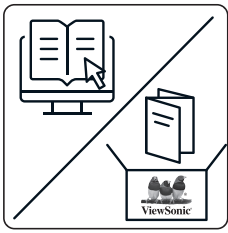

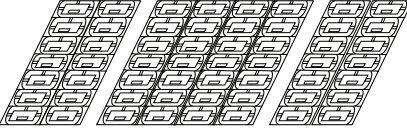
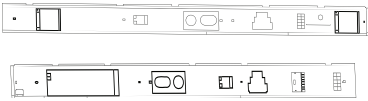
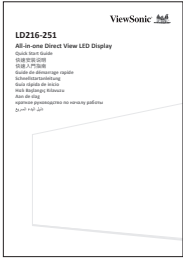
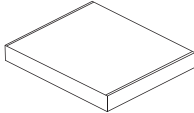

4. Ekranınız şimdi açılmaya hazırdır.

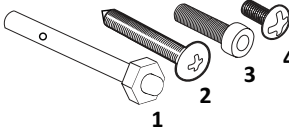

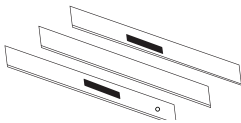

Inhoud verpakking

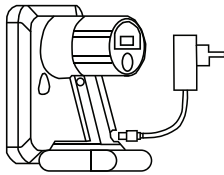
Item		Aantal	Opmerking
Kastsecties		8 secties in totaal	
Systeembesturingskast (Links en rechts)		2 zijden	
Snelle gebruikshandleiding		1	
LED-modules		128 modules	Het aantal reserve LED-modules varieert per land.
Afstandsbediening		1	
Schroeven		48 x M6x50mm Uitbreiding (1) 48 x TA6x30mm (2) 32 x M6x16mm (3) 18 x KM3x6mm (4)	
Inbussleutel		2	1 x 5 mm 1 x 8 mm

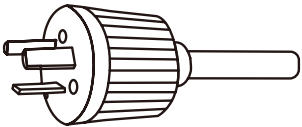
Item		Aantal	Opmerking
Covers systeem- besturingskast (Linker, midden en rechterkant)		3	
Wandmontage- beugels		4	
Vacuüm- zuiggereedschap		1	
Anti-statische handschoenen		2 paren	
USB-A naar USB-B Kabel (5m)		1	
Netsnoer		2	Het stroomverbruik is groot, dus u hebt twee netsnoeren en twee eigen stopcontacten nodig.

OPMERKING:

- Dit product is verpakt in een luchttransportdoos.
- Vanwege de grootte en het gewicht is het aan te raden dat twee of meer personen dit verplaatsen.

Productoverzicht

Voorpaneel

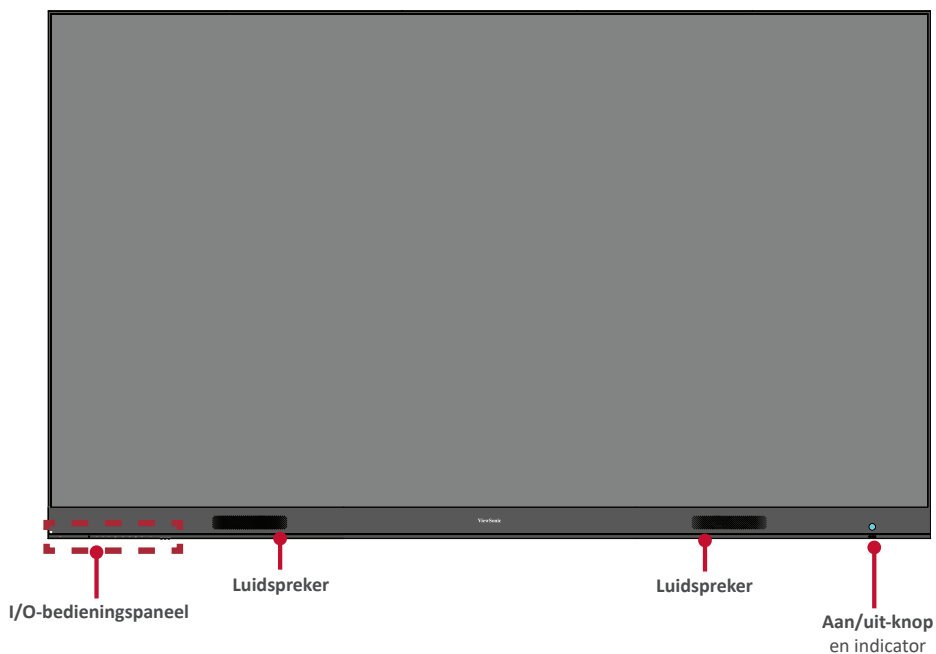

Achterpaneel

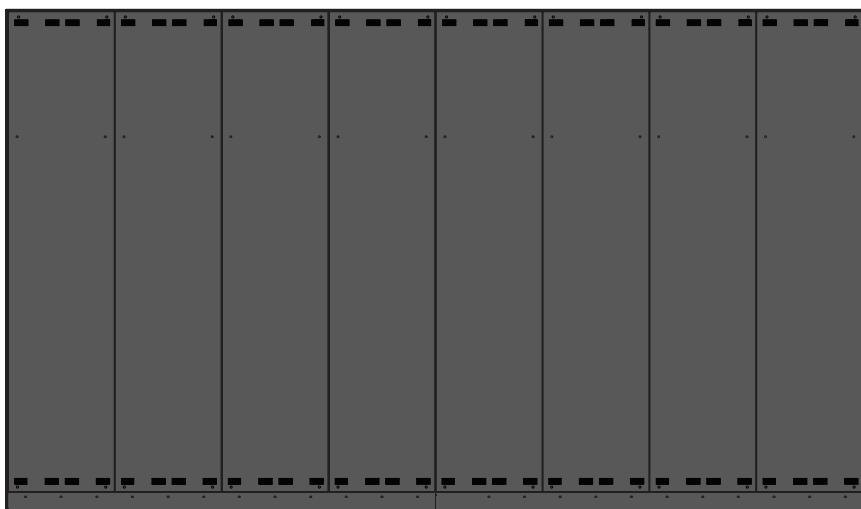

Inleiding

Vòòr de installatie

- ! Zorg voor voldoende ruimte voor lucht tussen de achterkant van het scherm en de wand voor een goede ventilatie.
- ! Zorg ervoor dat er geen directe luchtstroom van de airconditioning of verwarmingsroosters op het beeldscherm waait.
- ! Vermijd installatie van het beeldscherm op plaatsen met een hoge luchtvochtigheid.
- ! Gebruik vanwege het hoge stroomverbruik altijd stroomkabels die speciaal voor dit product zijn ontworpen.

Wandmontage

Installatie van de bovenste en onderste wandmontagebeugels

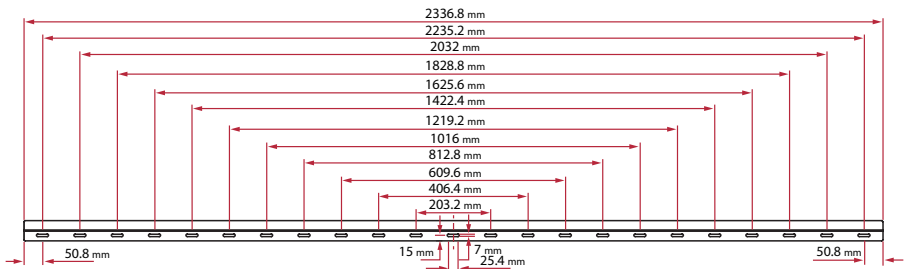

1. Zorg ervoor dat het wandgedeelte en de ruimte geschikt zijn voor installatie.

OPMERKING: De hoogte van de bovenste wandmontagebeugels mag niet lager zijn dan 129,92" (3,3 meter) van de grond.

2. Gebruik de wandmontagebeugel (zie afbeelding hierboven) als richtlijn en markeer alle 8 gaten en boor ze voor.
3. Installeer de eerste bovenste *wandmontagebeugel* met de bijgeleverde schroeven (M6x50mm Uitbreiding voor metselwerk; TA6x30mm voor lastdragend hout).
4. Herhaal **Stap 2** en zorg ervoor dat de tweede bovenste *wandmontagebeugel* waterpas staat met de eerste bovenste beugel.

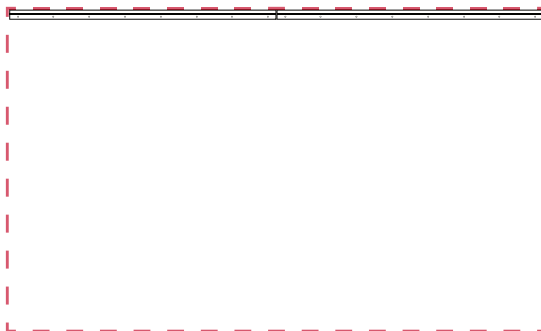

5. Installeer de onderste *wandmontagebeugels* op dezelfde manier als de bovenste *wandmontagebeugels*. De afstand tussen de bovenste en onderste *wandmontagebeugels* is 103,94" (2640 mm).

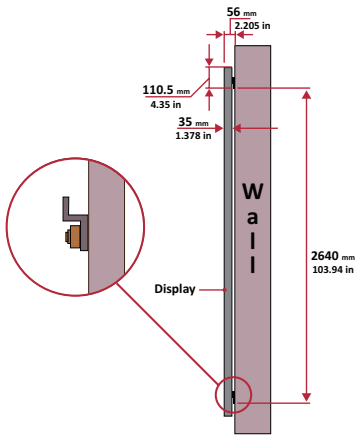

OPMERKING: U kunt ook beginnen met het installeren van de bovenste *wandmontagebeugels*, het scherm ophangen, en de onderste *wandmontagebeugels* daarna installeren voor een nauwkeurige pasvorm.

- ! Zorg ervoor dat de wand stevig genoeg is om 749,57 lbs te dragen. (340 kg).
 - ! Zorg dat de afwijking van het wandoppervlak < 5 mm (0,197 inches) is.
6. Na het installeren van de bovenste en onderste *wandmontagebeugels*, zou de installatiewand er als volgt uit moeten zien:

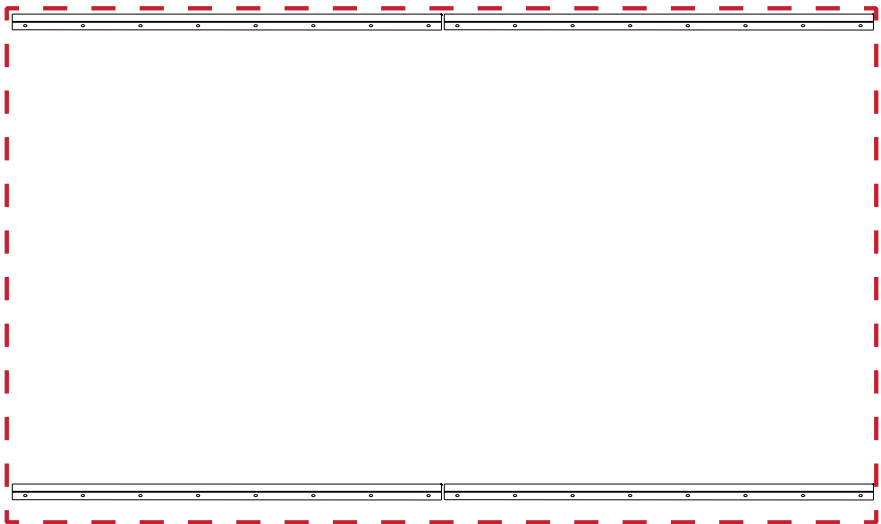

Installatie van de middenkasten

1. Zorg ervoor dat de montagebeugels aan de achterkant van de 6 middenkasten zijn gepositioneerd op de bovenste en onderste montageposities zoals hieronder weergegeven:



2. Til elke *middenkast* voorzichtig op de bovenste *wandmontagebeugels*.

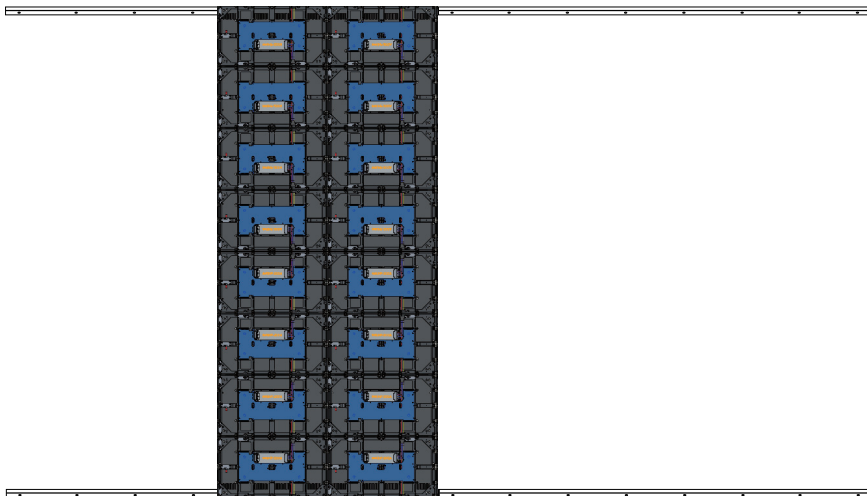

3. Zorg ervoor dat de *montagebeugels* veilig op de *wandmontagebeugels* rusten zoals hieronder weergegeven.

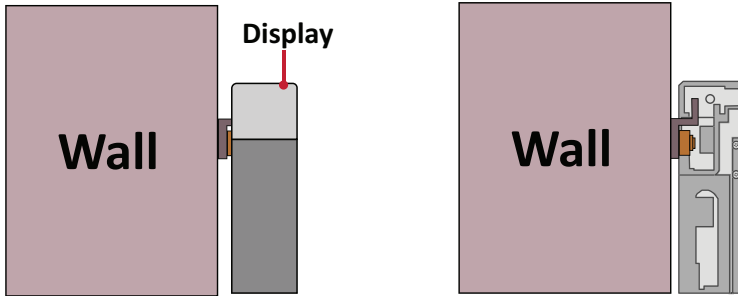

4. Duw elke *vergrendelingspen* en vergrendel iedere *haak* met de inbussleutel om iedere kast veilig met elkaar te verbinden. Het kan nodig zijn om het gat uit te lijnen met een inbussleutel voor het koppelen van de vergrendelingspen.

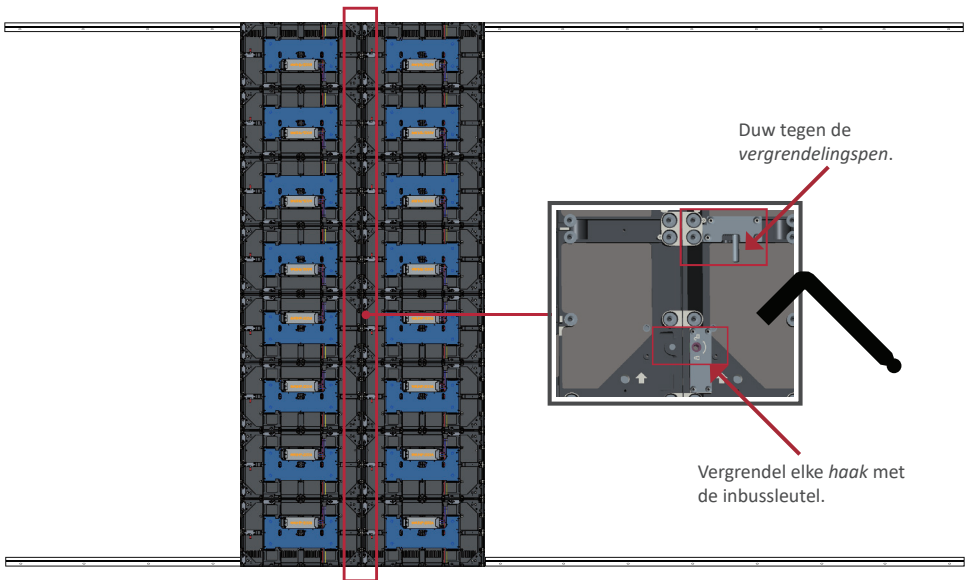

OPMERKING: Er zitten 8 vergrendelingspennen en 16 haken tussen elke kast.

5. Til de resterende middelste kast op tot op de bovenste wandmontagebeugels en controleer of de montagebeugels stevig op de wandmontagebeugels rusten.
6. Herhaal Stap 4 en maak de kasten aan elkaar vast met elke vergrendelingsbout en haak.

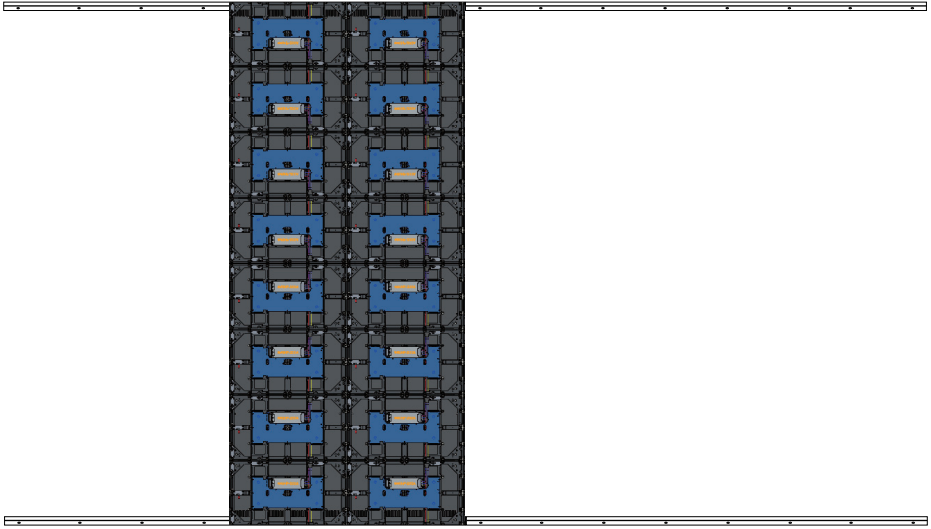

Installatie van de linker en rechter kast

1. Zorg ervoor dat de *montagebeugels* aan de achterkant van de *linker* en *rechter kast* zijn gepositioneerd op de bovenste en onderste montageposities zoals hieronder weergegeven:

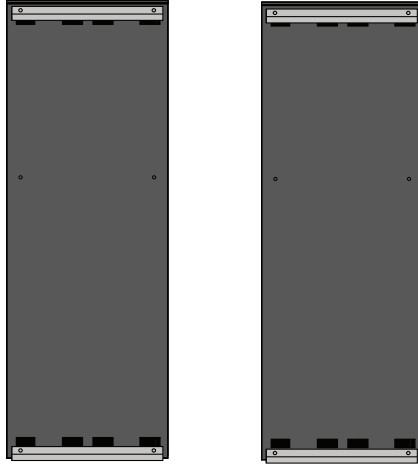

2. Til voorzichtig de *linker* en *rechter kast* bovenop de bovenste *wandmontagebeugels*, en zorg ervoor dat de *montagebeugels* veilig op de *wandmontagebeugels* rusten.



3. Pas de *linker* of *rechter kast* zo aan dat ze naadloos aansluiten op de *middenkasten*.

4. Duw elke *vergrendelingspen* aan en vergrendel elke *haak* met de inbussleutel om de *linker* en *rechter kasten* veilig met elkaar te verbinden. Het kan nodig zijn om het gat uit te lijnen met een inbussleutel voor het koppelen van de vergrendelingspen.

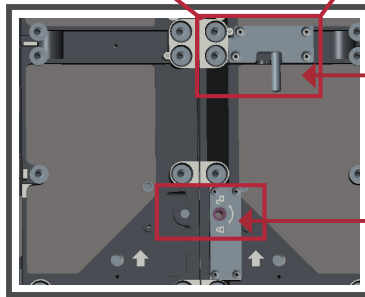
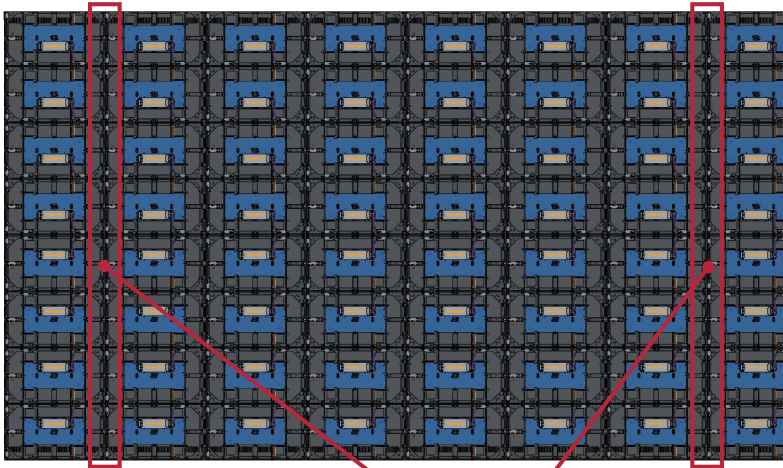

Duw tegen de *vergrendelingspen*.

Vergrendel elke *haak* met de inbussleutel.



OPMERKING: Er zitten 8 *vergrendelingspennen* en 16 *haken* tussen elke kast.

Aansluiten van de systeembesturingskast

1. Vouw het paneel van de *systeembesturingskast* voorzichtig uit. Zorg ervoor dat het hoofdbedieningspaneel van het systeem zich aan de linkerkant bevindt.

OPMERKING: Wees voorzichtig, want het paneel van de *systeembesturingskast* is in tweeën gedeeld met de draden bevestigd.

2. Lijn de gaten van de *kast* uit met de *systeembesturingskast* om deze te bevestigen.

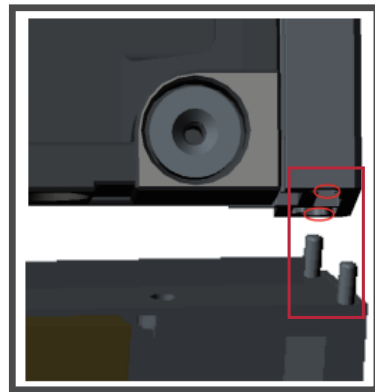
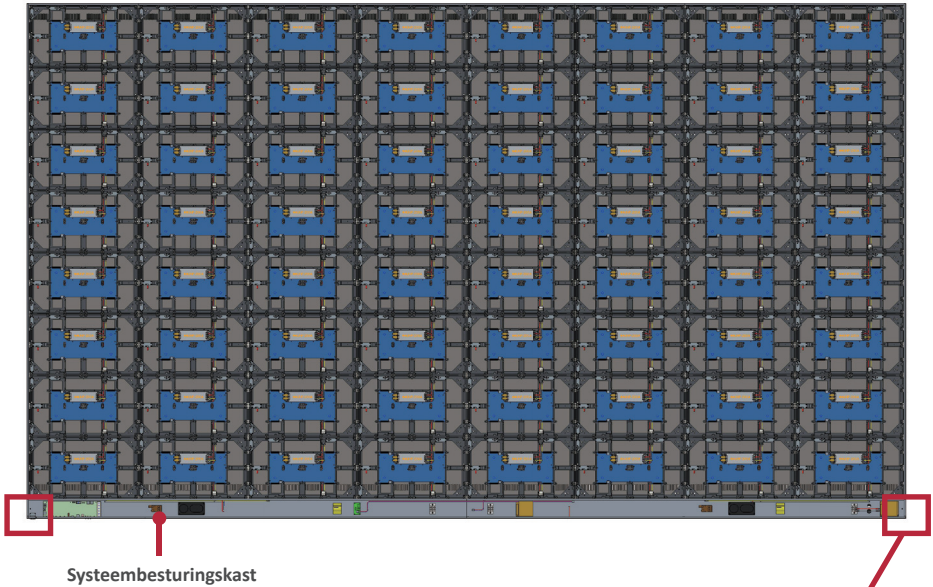

3. U kunt de stroomkabel ook opnieuw installeren voor een aantrekkelijk uiterlijk. Maak de drie (3) PWM 4x6mm schroeven los, trek de stroomkabel eruit, voer de stroomkabel door het achterste gat en draai de schroeven vervolgens stevig vast.

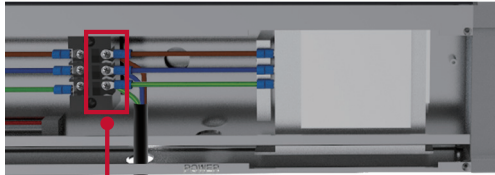
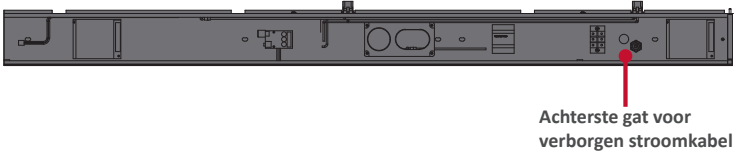

Drie (3) PWM 4x6mm schroeven

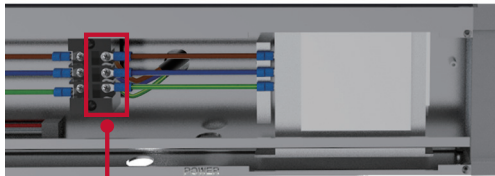

Drie (3) PWM 4x6mm schroeven

! Bediening alleen door professionals.

4. Zet de *systembesturingskast* verder vast aan de *kasten* met de 32 bijgeleverde M6x16mm schroeven.

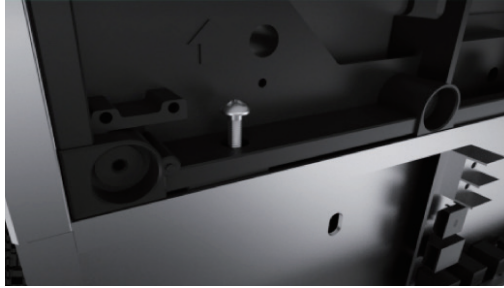

5. Sluit de netwerk- en stroomkabels van de *kasten* aan op de *systembesturingskast*.
OPMERKING: Er zijn 4 netwerk- en 8 stroomkabels om aan te sluiten.

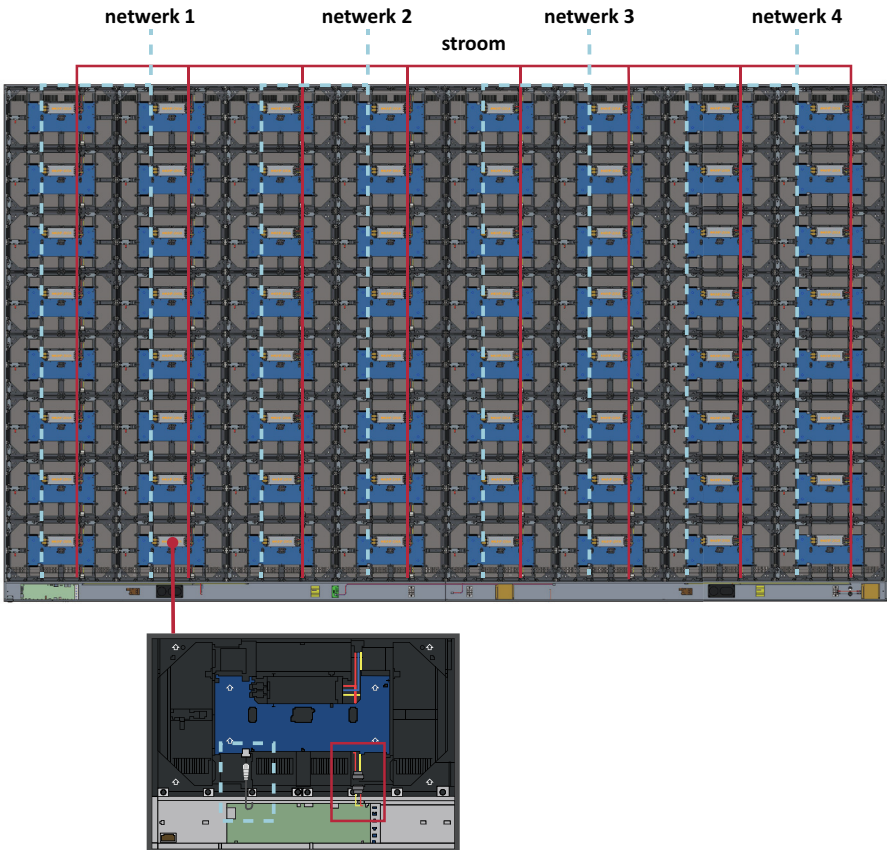

Installatie van de LED-modules

Installeer iedere *LED-module* op de *kasten*, en zorg ervoor dat de nummers op de *module* overeenkomen met de *kast*.

❗ Draag antistatische handschoenen voordat u de LED-modules behandelt.



Zorg ervoor dat elke *module* vlak staat en dat er weinig tot geen ruimte is tussen de modules. Het kan nodig zijn om lichtjes te tikken op de module zodat het gelijk komt te staan.

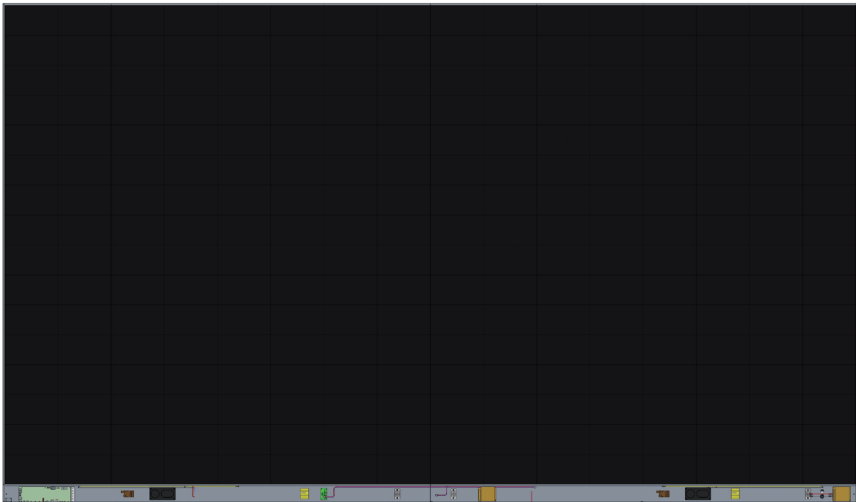

Installatie covers systeembesturingskast

Er zijn drie (3) covers van de systeembesturingskast: Links, Midden en Rechts



1. Begin met het installeren van de *rechter cover* op de *systeembesturingskast*.

OPMERKING: Zorg ervoor dat de **voedingskabel** is aangesloten op de *systeembesturingskast* voordat u de *cover* vastmaakt.

2. Controleer na het aansluiten van de **voedingskabel** of de *rechter cover* op één lijn ligt met de *systeembesturingskast*; maak het vervolgens vast met de 18 bijgeleverde KM3x6mm schroeven.



3. Herhaal de bovenstaande stappen voor de *middelste* en *linker cover*.







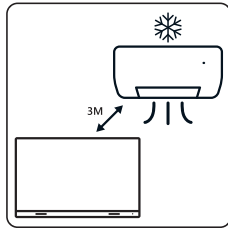
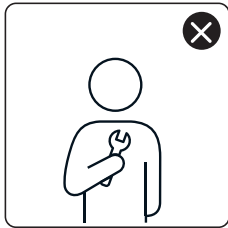
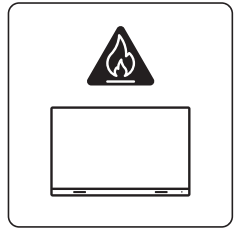
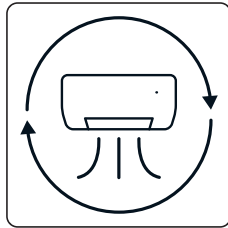
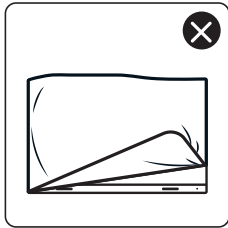
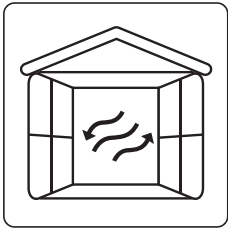
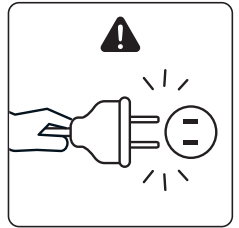
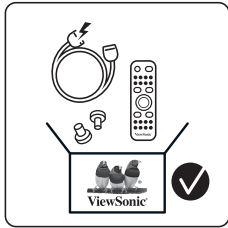
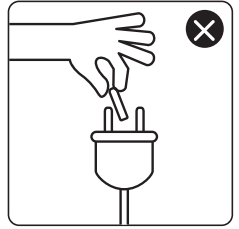
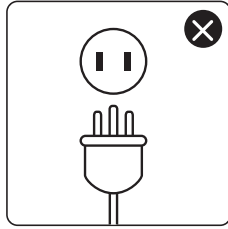
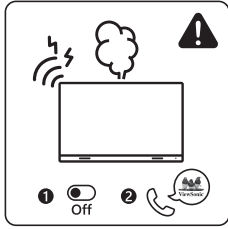
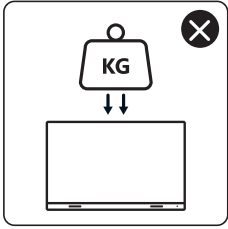
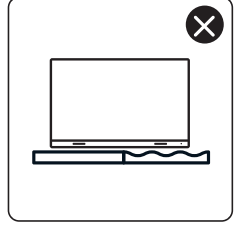
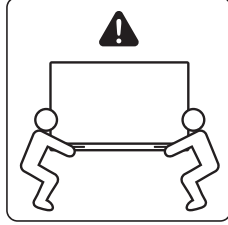
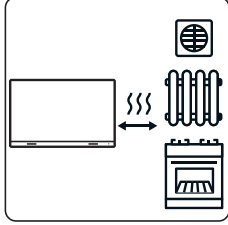
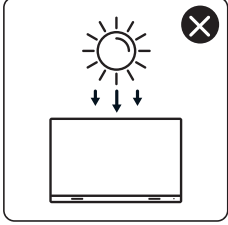
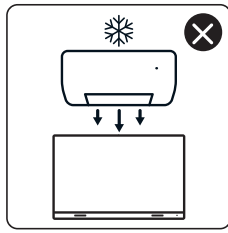
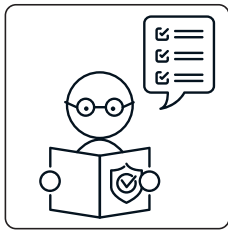
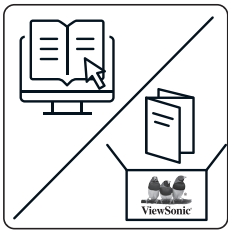



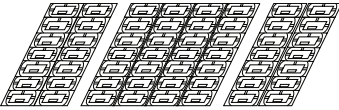
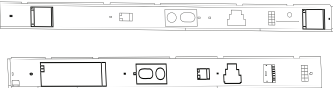

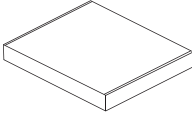
4. Uw beeldscherm is nu klaar voor gebruik.

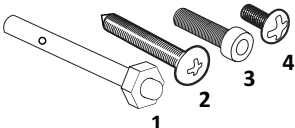

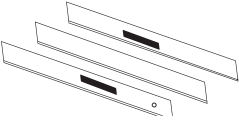

Комплектация

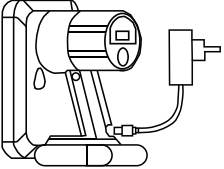
Пункт		Количество	Примечание
Отсеки корпуса		Всего 8 отсеков	
Системная коробка управления (Слева и справа)		2 стороны	
Краткое руководство		1	
Светодиодные модули		128 модулей	Количество запасных светодиодных модулей зависит от страны.
Пульт ДУ		1	
Винты			48 x M6x50mm Расширение (1) 48 x TA6x30mm (2) 32 x M6x16mm (3) 18 x KM3x6mm (4)

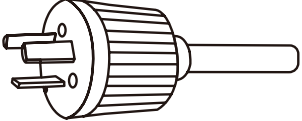
Пункт		Количество	Примечание
Шестигранный ключ (ключ Аллена)		2	1 x 5 mm 1 x 8 mm
Крышки системной коробки управления (Слева, посередине и справа)		3	
Кронштейны для настенного монтажа		4	
Устройство для вакуумной очистки		1	
Антистатические перчатки		2 пары	
Кабель USB-A - USB-B (5 м)		1	
Шнур питания		2	В связи с высоким энергопотреблением потребуется два шнура питания и две специальные электрические розетки.

ПРИМЕЧАНИЕ.

- Данное устройство упаковано в коробку для авиаперевозки.
- Из-за размера и веса устройства рекомендуется поднимать и перемещать его силами двух и более человек.

Описание изделия

Лицевая панель

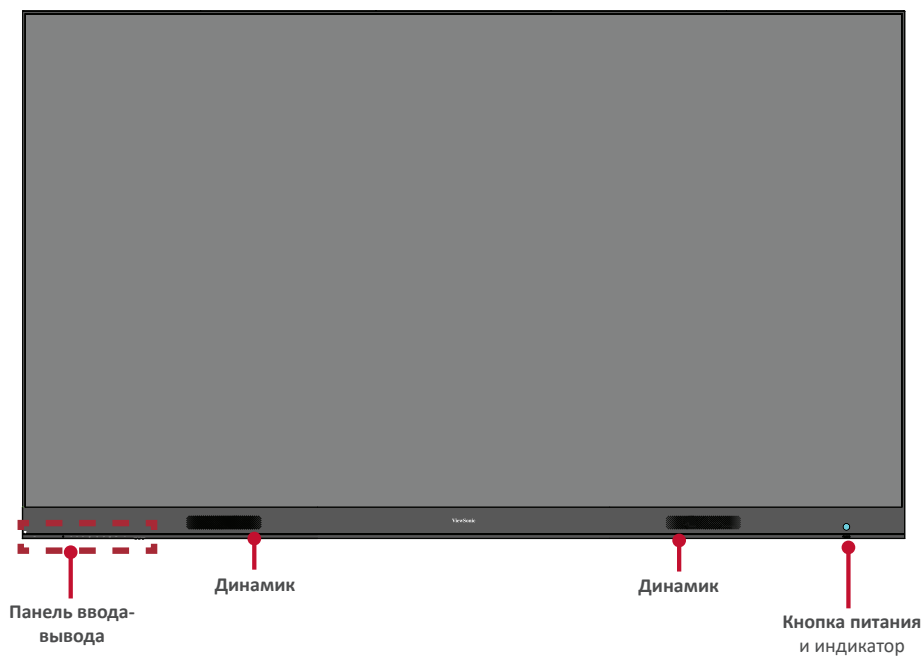

Задняя панель

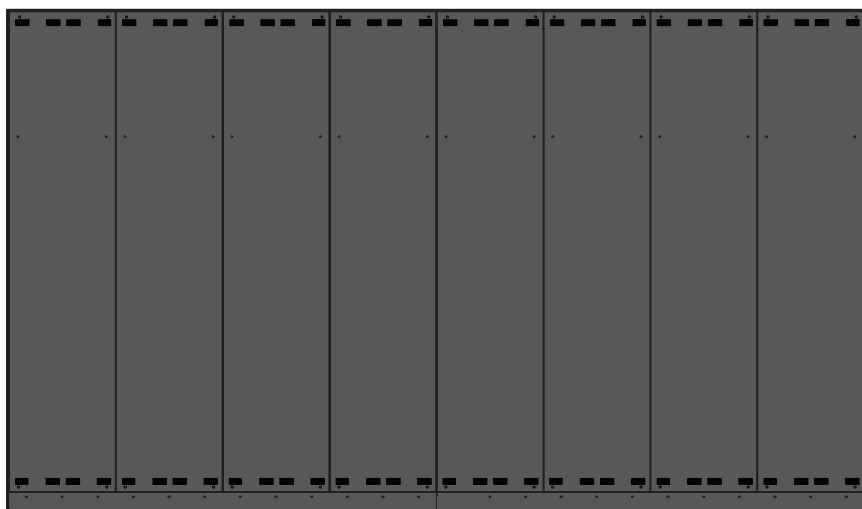

Введение

Подготовка к установке

- ❗ Оставьте воздушный зазор между задней панелью дисплея и стеной, достаточный для надлежащей вентиляции.
- ❗ Убедитесь, что на дисплей не попадает прямой поток воздуха от кондиционера или обогревателей.
- ❗ Избегайте установки дисплея в местах с высокой влажностью.
- ❗ В связи с высоким энергопотреблением всегда используйте только те шнуры питания, которые специально предназначены для данного устройства.

Настенный монтаж

Установка верхнего и нижнего кронштейна для настенного монтажа

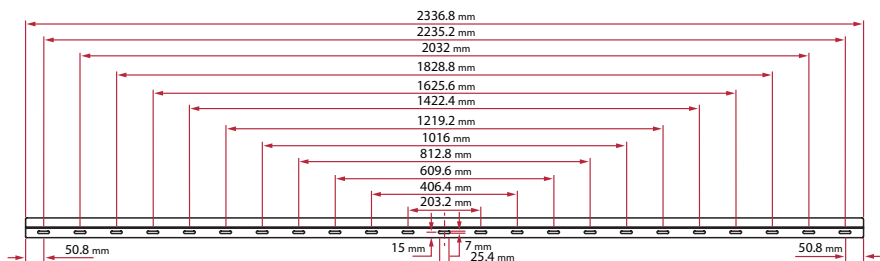

1. Убедитесь, что область и размер стены подходят для установки устройства.

ПРИМЕЧАНИЕ. Высота верхних кронштейнов для настенного монтажа должна составлять не менее 3,3 метров (129.92" дюйма) от уровня земли.

2. Используя *кронштейн для настенного монтажа* (показан на рисунке выше) в качестве шаблона, отметьте как минимум 8 отверстий и начерно просверлите их.
3. Установите первый верхний *кронштейн для настенного монтажа* с помощью входящих в комплект винтов (бетонный анкерный болт M6x50 мм; TA6x30 мм для несущих деревянных конструкций).
4. Повторите **Шаг 2**, установив второй верхний *кронштейн для настенного монтажа* параллельно первому верхнему кронштейну.



5. Установите нижние кронштейны для настенного монтажа так же, как и верхние кронштейны для настенного монтажа. Расстояние между верхними и нижними кронштейнами для настенного монтажа составляет 2640 мм (103,94 дюйма).

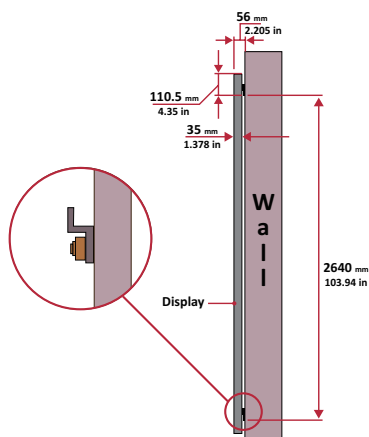

ПРИМЕЧАНИЕ. Можно также установить верхние кронштейны для настенного монтажа, повесить экран, а затем установить нижние кронштейны для настенного монтажа, чтобы добиться более точного прилегания.

- ❗ Проследите, чтобы стена могла безопасно выдержать нагрузку в 340 кг (749,57 фунта).
 - ❗ Отступ от поверхности стены не должен превышать 5 мм (0,197 дюйма).
6. После установки верхних и нижних кронштейнов для настенного монтажа стена должна иметь следующий вид:

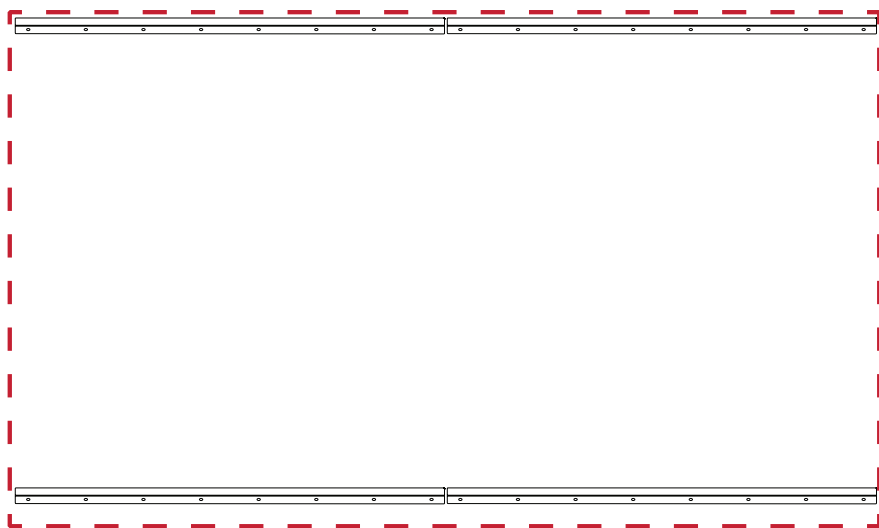

Установка средних корпусов

1. Проследите, чтобы монтажные кронштейны на задней панели 6 средних корпусов были расположены в верхнем и нижнем монтажных положениях, как это показано ниже.



2. Аккуратно поднимите каждый из *средних корпусов* на верхние *кронштейны* для *настенного монтажа*.

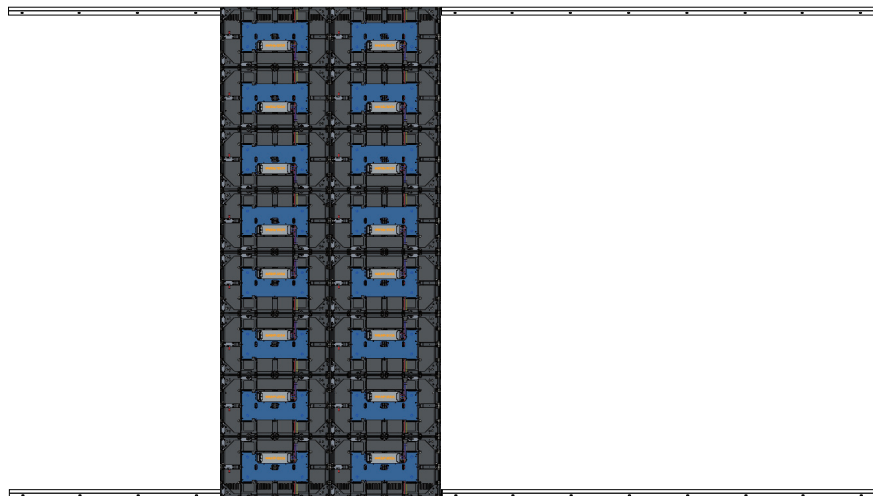

3. Убедитесь, что *монтажные кронштейны* прочно стоят на *кронштейнах для настенного монтажа*, как показано ниже.

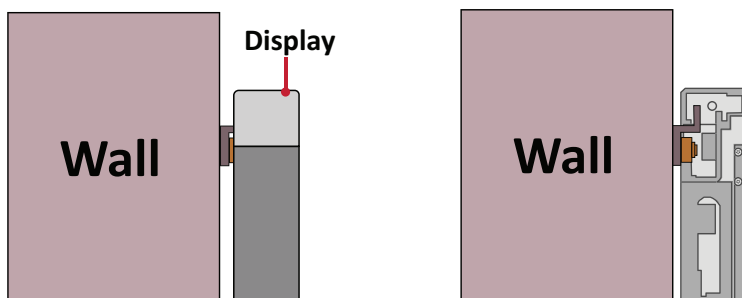

4. Нажмите на *стопорные болты* и зафиксируйте все *крючки* шестигранным инструментом, чтобы надежно соединить все корпуса между собой. Может потребоваться совместить отверстия, чтобы зафиксировать стопорный болт с помощью шестигранного ключа.

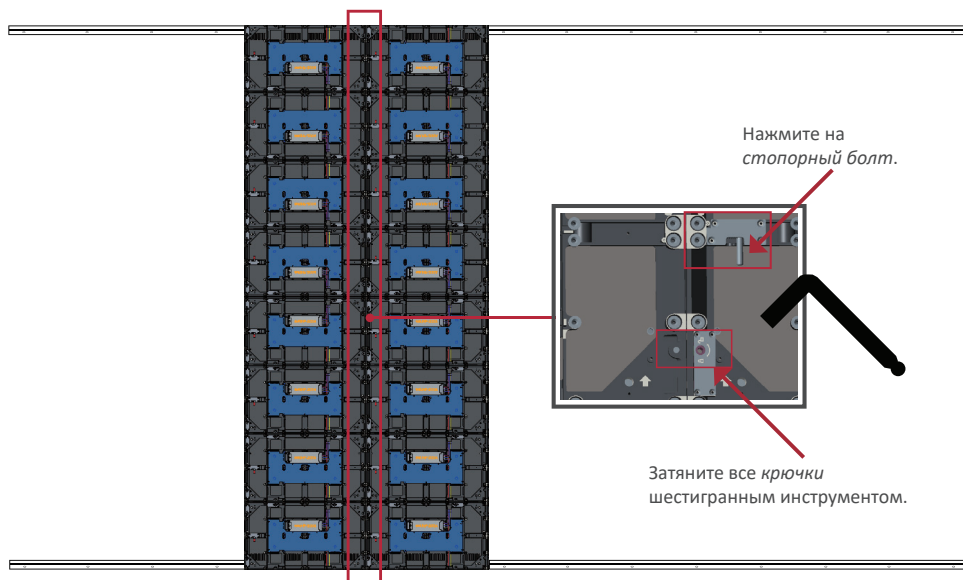

ПРИМЕЧАНИЕ. Между корпусами находится по 8 стопорных болта и 16 крюков.

5. Поднимите оставшийся средний корпус на верхние настенные кронштейны, убедившись, что монтажные кронштейны надежно зафиксированы на настенных креплениях.
6. Повторите действие 4, скрепив корпуса между собой стопорными болтами и крюками.

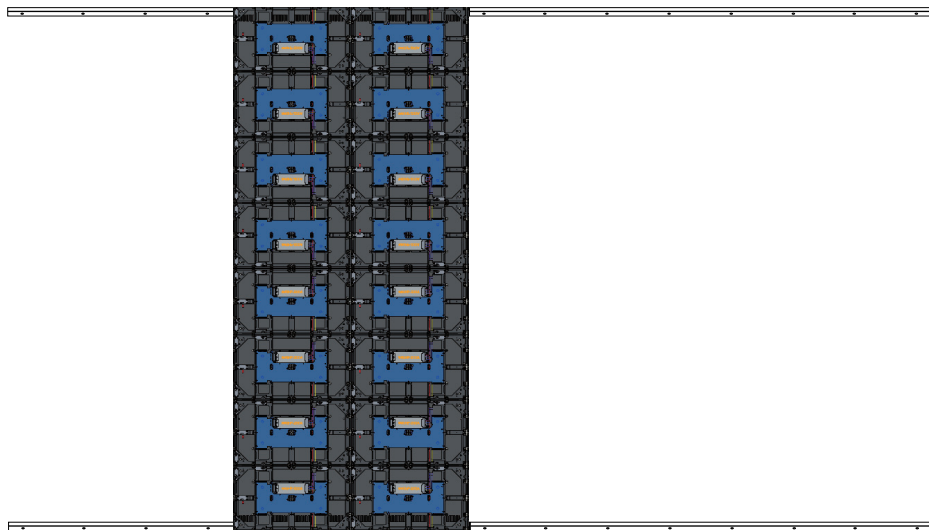

Установка левого и правого корпуса

1. Убедитесь, что *монтажные кронштейны* на задней панели *левого и правого корпуса* расположены в верхнем и нижнем монтажных положениях, показанных ниже.

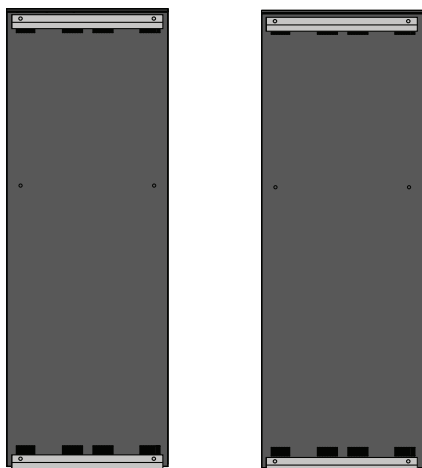

2. Аккуратно поднимите *левый и правый корпуса* и поставьте их на верхние *кронштейны для настенного монтажа*, убедившись, что *монтажные кронштейны* прочно стоят на *кронштейнах для настенного монтажа*.



3. Отрегулируйте положение *левого или правого корпуса*, чтобы добиться *безупречного соединения со средними корпусами*.

4. Нажмите на *стопорные болты* и зафиксируйте все *крючки* шестигранным инструментом, чтобы надежно соединить *левый и правый корпус* между собой. Может потребоваться совместить отверстия, чтобы зафиксировать стопорный болт с помощью шестигранного ключа.

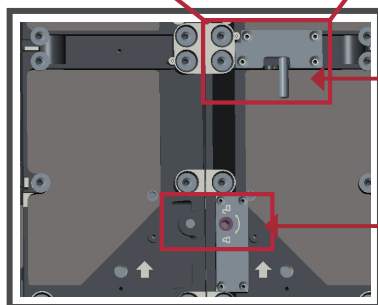
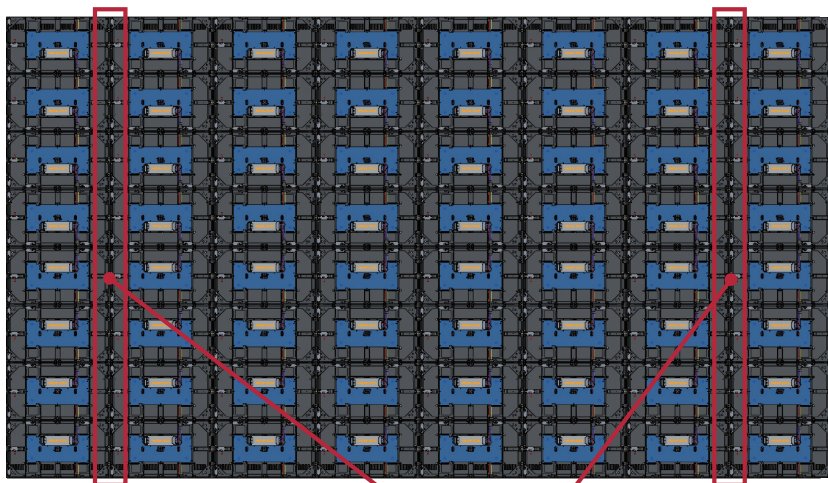

Нажмите на
стопорный болт.



Затяните все *крючки*
шестигранным
инструментом.

ПРИМЕЧАНИЕ. Между корпусами находится по 8 *стопорных болта* и 16 *крюков*.

Подключение системной коробки управления

1. Осторожно разверните панель *системной коробки управления*. Убедитесь, что главная системная плата управления находится слева.

ПРИМЕЧАНИЕ. Будьте осторожны, так как панель *системной коробки управления* разделена на две части, которые соединяются проводами.

2. Совместите отверстия в *корпусе с системной коробкой управления* и присоедините ее.

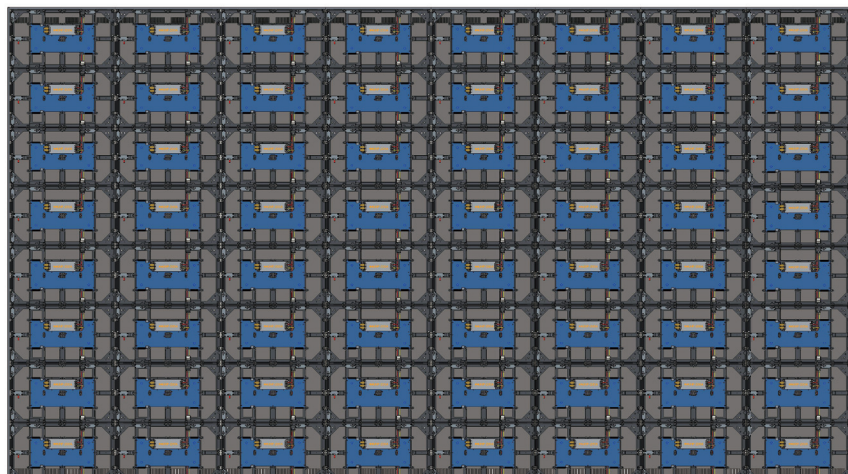

Системная плата управления

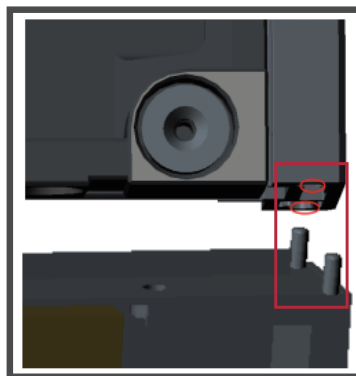

3. Вы также можете переустановить кабель питания, чтобы добиться привлекательного внешнего вида. Ослабьте три (3) винта PWM 4x6 мм, вытащите кабель питания, проденьте кабель питания через заднее отверстие и затем плотно затяните винты.

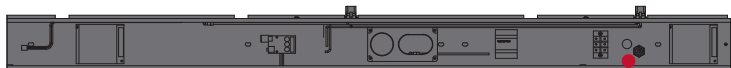

Заднее отверстие для
скрытого кабеля питания

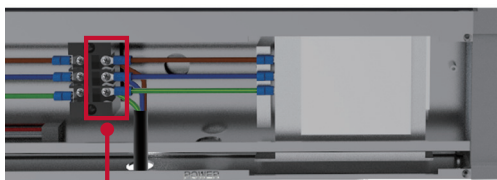

Три (3) винта PWM 4x6 мм

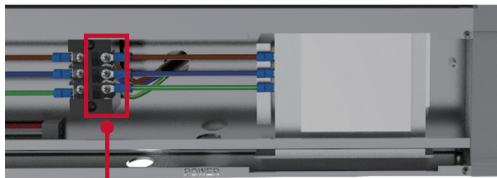

Три (3) винта PWM 4x6 мм

 Эксплуатация осуществляется только специалистами.

4. Затем прикрепите *системную коробку управления* к корпусам с помощью 32 входящих в комплект винтов (М6х16 мм).

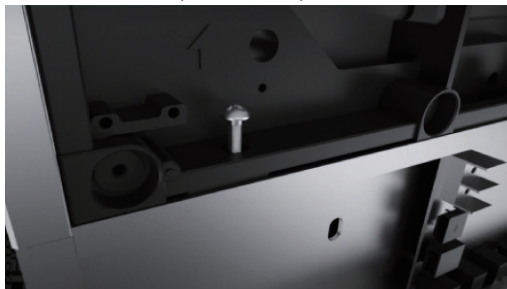

5. Подключите сетевые шнуры и кабели питания от корпусов к *системной коробке управления*.

ПРИМЕЧАНИЕ. Имеется 4 сетевых шнура и 8 кабеля питания для подключения.

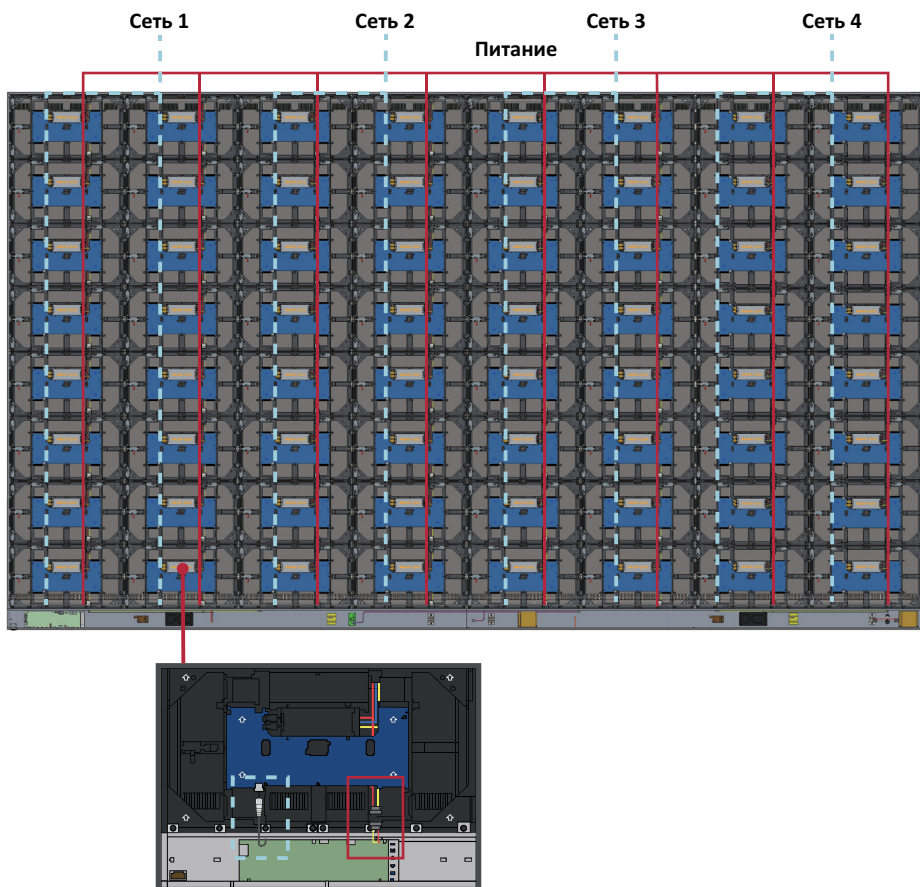

Установка светодиодных модулей

Установите каждый *светодиодный модуль* в корпуса согласно номерам на *модулях* и *корпусах*.

- ! Перед работой со светодиодными модулями наденьте антистатические перчатки.



Все *модули* должны быть утоплены в корпуса, и между ними практически не должно быть зазоров. Может потребоваться осторожно постучать по модулю, чтобы выровнять его.

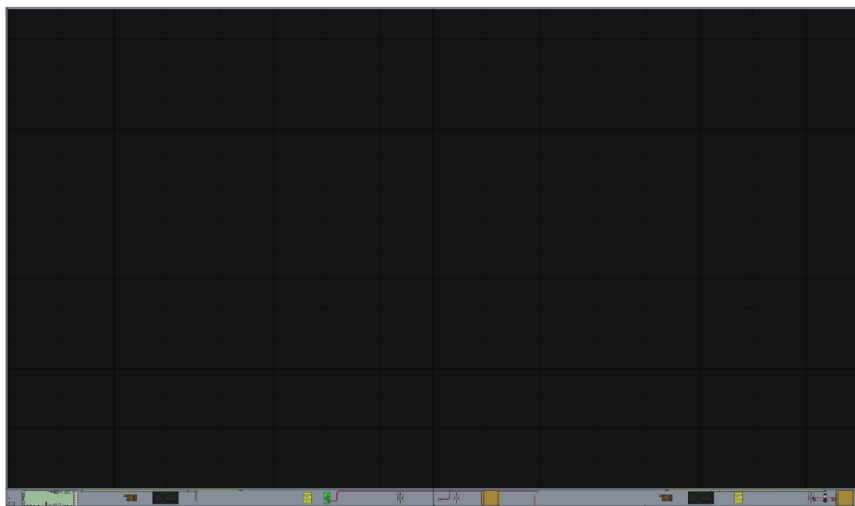

Установка крышек системной коробки управления

Имеется 3 (три) крышки системной коробки управления: Левая, Средняя и Правая.



1. Начните с установки *правой крышки* на *системную коробку управления*.

ПРИМЕЧАНИЕ. Убедитесь, что кабель **кнопки питания** подключен к кабелю питания *системной коробки управления*, и закрепите крышку.

2. После подключения кабеля **кнопки питания** убедитесь, что *правая крышка* надлежащим образом совмещена с *системной коробкой управления*; затем закрепите ее с помощью 18 входящих в комплект винтов (КМЗх6 мм).



3. Повторите вышеуказанные действия для *средней* и *левой крышки*.





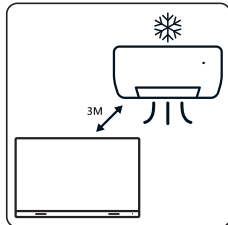
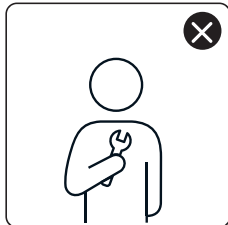
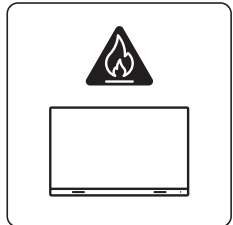
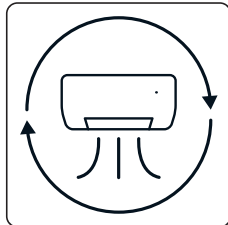
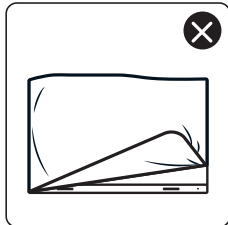
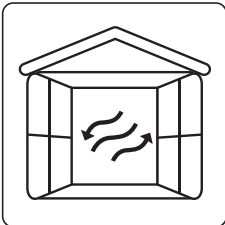
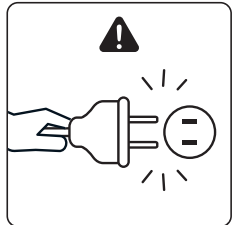
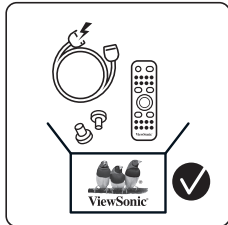
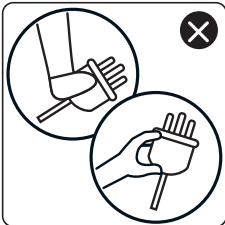
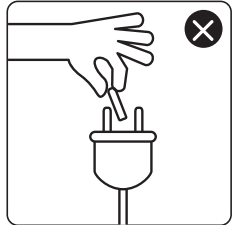
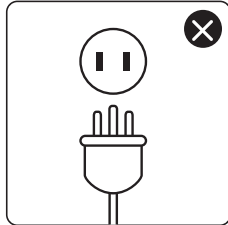
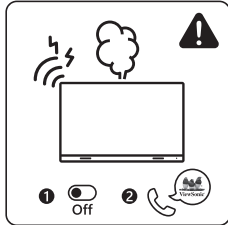
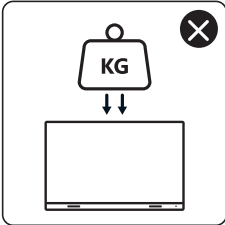
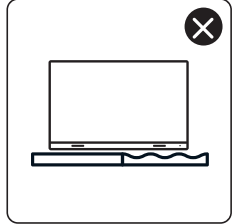
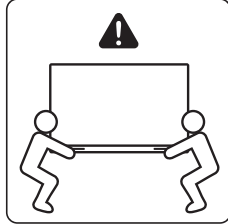
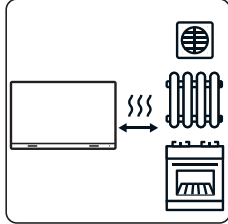
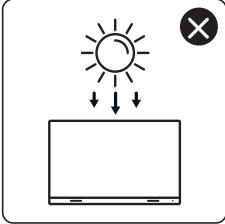
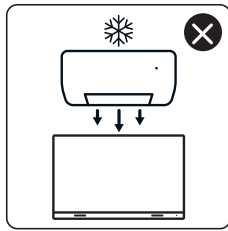
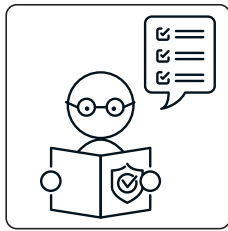
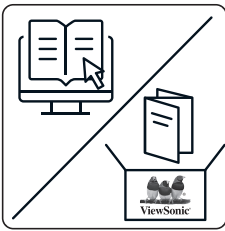

4. Теперь ваш дисплей готов к включению.



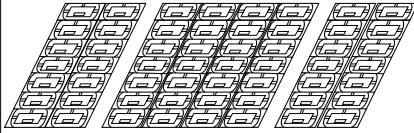
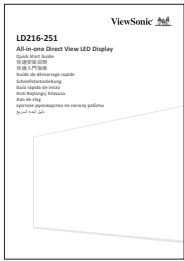
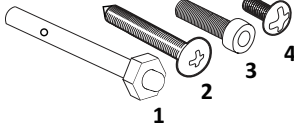

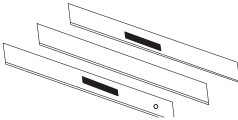
محتويات العبوة

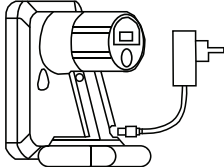
العنصر	الكمية	ملاحظة
مقاطع الغلاف الخارجي	٨ مقاطع	
صندوق التحكم في النظام (الجانبين الأيسر والأيمن)	جانبان	
دليل التشغيل السريع	١	
وحدات LED	١٢٨ وحدة	
تختلف كمية وحدات LED الاحتياطية من بلد لآخر.		
وحدة التحكم عن بعد	١	
براغي	٤٨ x M6 x ٥٠ ملم تمديد (١) ٤٨ x TA6 x ٣٠ ملم (٢) ٣٢ x M6 x ١٦ ملم (٣) ١٨ x KM3 x ٦ ملم (٤)	
أداة ربط سداسية (مفتاح ألن)	٢	
١ x ٥٠ mm		
١ x ٨ mm		

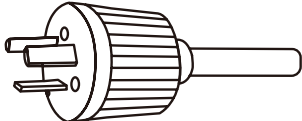
العنصر	الكمية	ملاحظة
أغطية صندوق التحكم في النظام (الجانب الأيسر والأوسط والأيمن)	٣	
دعائم التثبيت الحائطي	٤	
أداة التفريغ بالشفط	١	
قفازات مضادة للكهرباء الإستاتيكية	زوجين	
كبل USB-A إلى USB-B (٣٥)	١	
سلك الطاقة	٢	
استهلاك الطاقة كبير للغاية؛ ومن ثم يجب استخدام سلكي طاقة ومأخذي طاقة مخصصين لهذا الغرض.		

ملاحظة:

- يتم تعبئة هذا المنتج في صندوق نقل جوي.
- نظرًا لوزن الجهاز وحجمه، ينصح بأن يحملة شخصان أو أكثر.

نظرة عامة على المنتج

اللوحة الأمامية



لوحة التحكم في الدخل/
الخرج

مكبر الصوت

مكبر الصوت

زر الطاقة والمؤشر

اللوحة الخلفية

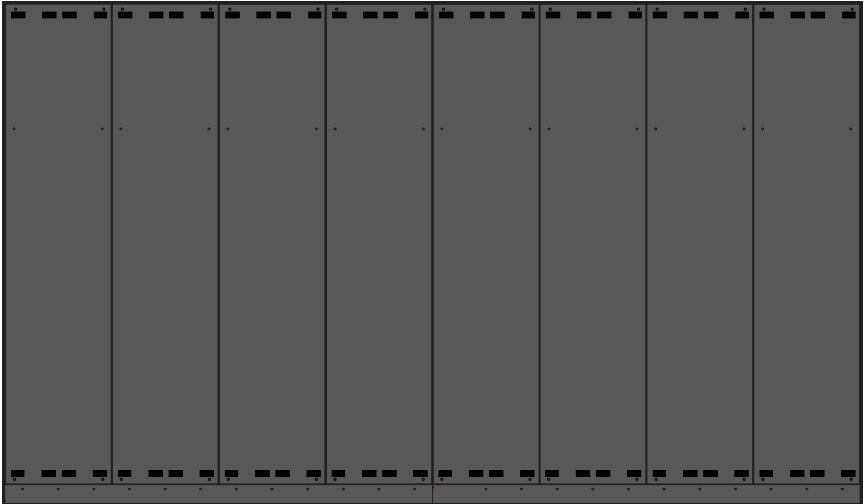

مقدمة

قبل التركيب

- ! حافظ على وجود حيز كافٍ بين الجزء الخلفي من الشاشة وأي جدار لتهوية الشاشة بصورة مناسبة.
- ! تأكد من عدم وجود تيار هواء مباشر يندفع من مكيف الهواء أو فتحات التدفئة إلى الشاشة.
- ! تجنب تركيب الشاشة في أماكن ذات رطوبة عالية.
- ! احرص دائمًا على استخدام أسلاك طاقة مصممة خصيصًا لهذه الشاشة نظرًا لأنها تستهلك قدر كبير من الطاقة.

التثبيت على الحائط

تركيب الدعائم العلوية والسفلية للتثبيت على الحائط

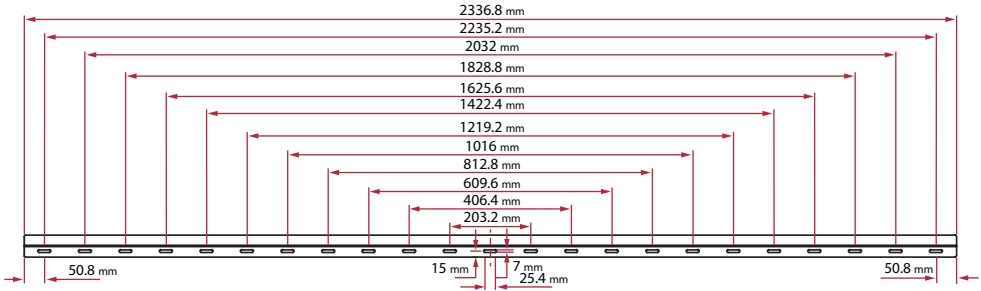

١- تأكد من أن المساحة المخصصة لتثبيت الشاشة على الحائط هي موقع تثبيت مناسب.

ملاحظة: يجب ألا يقل ارتفاع الدعائم العلوية للتثبيت على الحائط عن ١٢٩,٩٢ بوصة (٣,٣ متر) عن سطح الأرض.

٢- استخدم دعامة التثبيت على الحائط (موضحة بالصورة أعلاه) كدليل، وضع علامة لكل فتحة من الفتحات ١٢ واتقب كلاً منها مسبقاً.

٣- قم بتركيب الداعم العلوي الأول للتثبيت على الحائط من خلال المسامير المرفقة (تمديد ٥٠xM6 ملم لحجارة البناء؛ ٣٠xTA6 ملم لأخشاب حمل الجهاز).

٤- كرر الخطوة الثانية مع التأكد من أن الداعم الثاني للتثبيت على الحائط على نفس ارتفاع الداعم العلوي الأول.



٥- قم بتركيب الدعائم السفلية للتثبيت على الحائط بنفس طريقة تركيب الدعائم العلوية للتثبيت على الحائط. تكون المسافة بين الدعائم العلوية والسفلية للتثبيت على الحائط هي ١٠٣,٩٤ بوصة (٢٦٤٠ ملم).

ملاحظة: يمكنك أيضًا تركيب الدعائم العلوية للتثبيت على الحائط ومن ثم تعليق الشاشة ثم تركيب الدعائم السفلية للتثبيت على الحائط من أجل ملائمة الجهاز بصورة أكثر دقة.

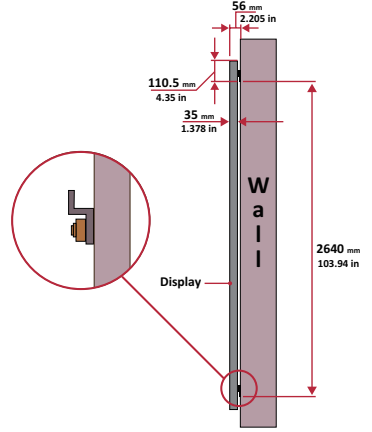

! تأكد من الحائط يمكنه حمل ٧٤٩,٥٧ رطل (٣٤٠ كجم) بأمان.

! تأكد من أن مسافة انحراف سطح الجدار أقل من ٥ مم (٠,١٩٧ بوصة).

٦- بعد تركيب كل من الدعائم العلوية والسفلية للتثبيت على الحائط، يجب أن يبدو حائط التعليق كما يلي:

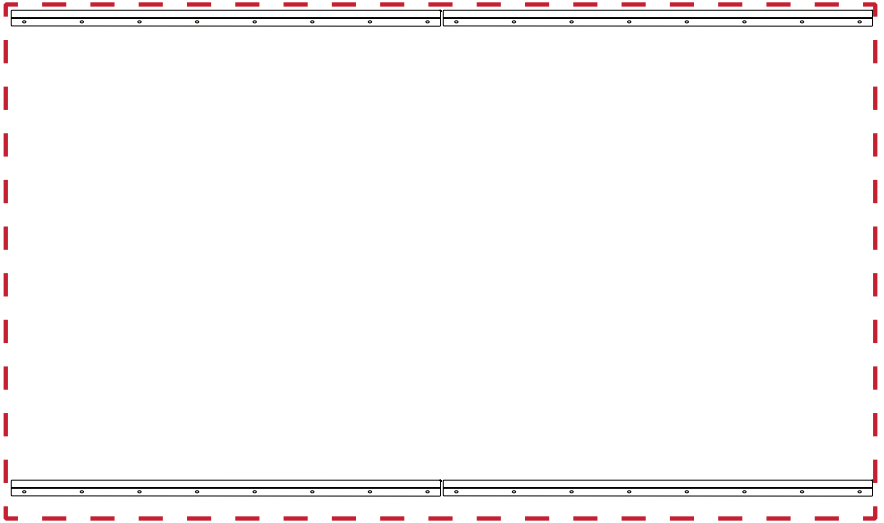

تركيب الخزانات الوسطى

١- تأكد من أن دعائم التثبيت الموجودة على الجزء الخلفي من الخزانتين الوسطيين (٦) تم وضعها في مواضع التثبيت العلوية والسفلية كما هو موضح أدناه:



٢- قم برفع كل جزء من أجزاء الغلاف الخارجي الأوسط حتى يصل إلى الدعائم العلوية للتثبيت على الحائط.

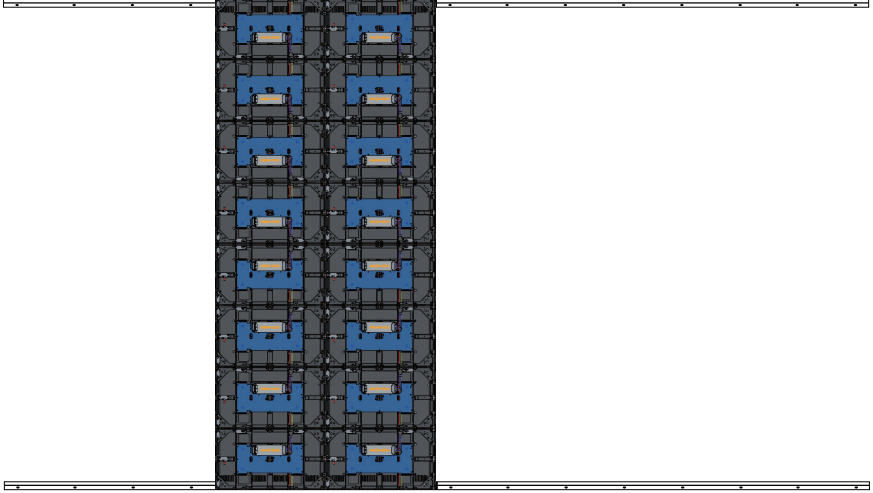

٣- تأكد من ارتكاز دعائم التثبيت بإحكام على دعائم التثبيت على الحائط كما هو موضح أدناه.

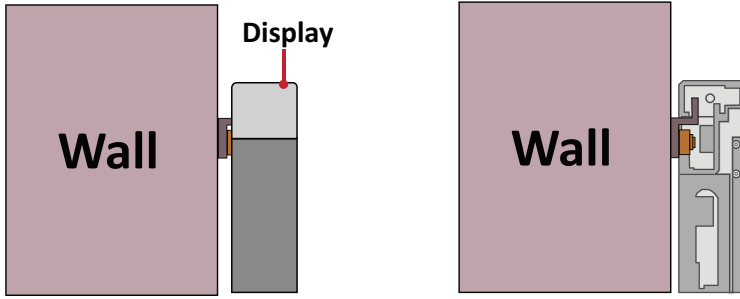

٤- قم بدفع كل برغي قفل وأغلق كل خطاف بأداة مسدسة لربط كل جزء من أجزاء الغلاف الخارجي ببعضها بإحكام. وقد تلتزم محاذاة الفتحة باستخدام مفتاح ألن لتعشيق لسان الإرتاج.

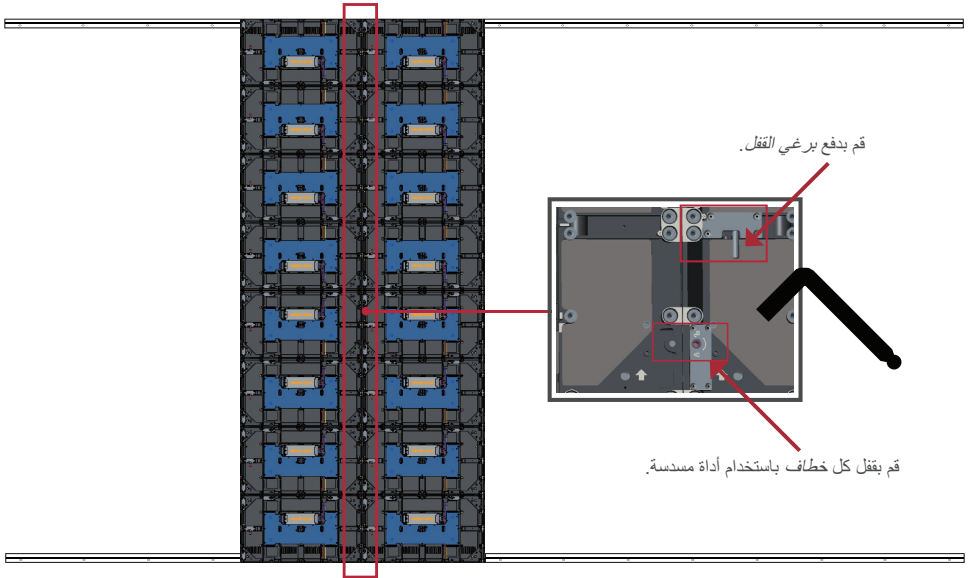

قم بدفع برغي القفل.

قم بفتح كل خطاف باستخدام أداة مسدسة.

ملاحظة: توجد ٨ السنة إرتاج ١٦ خطاطيف بين كل خزانة وأخرى.

- ٥- ارفع الخزانة الوسطى المتبقية لأعلى على كتيفات التثبيت الحائطي العلوية، وتأكد من استقرار كتيفات التثبيت بإحكام على كتيفات التثبيت الحائطي.
- ٦- كرر الخطوة ٤، وأحكم تثبيت الخزانات معاً باستخدام كل لسان إرتاج وخطاف.

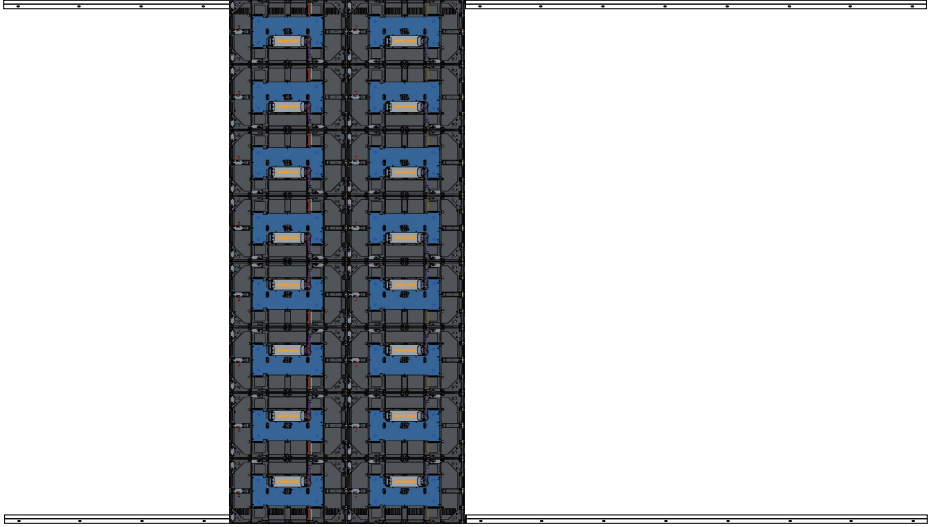

تركيب الخزانتين اليسرى واليمنى

١- تأكد من أن دعائم التثبيت الموجودة على الجزء الخلفي للجزأين الأيمن والأيسر من الغلاف الخارجي تم وضعها في مواضع التثبيت العلوية والسفلية كما هو موضح أدناه:

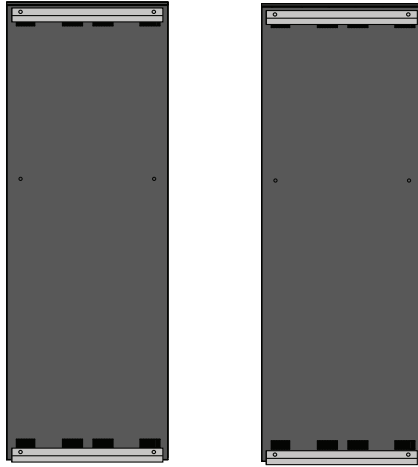

٢- قم برفع الجزأين الأيسر والأيمن من الغلاف الخارجي لتصل إلى الدعائم العلوية للتثبيت على الحائط وتأكد من ارتكاز دعائم التثبيت بأمان على دعائم التثبيت على الحائط.

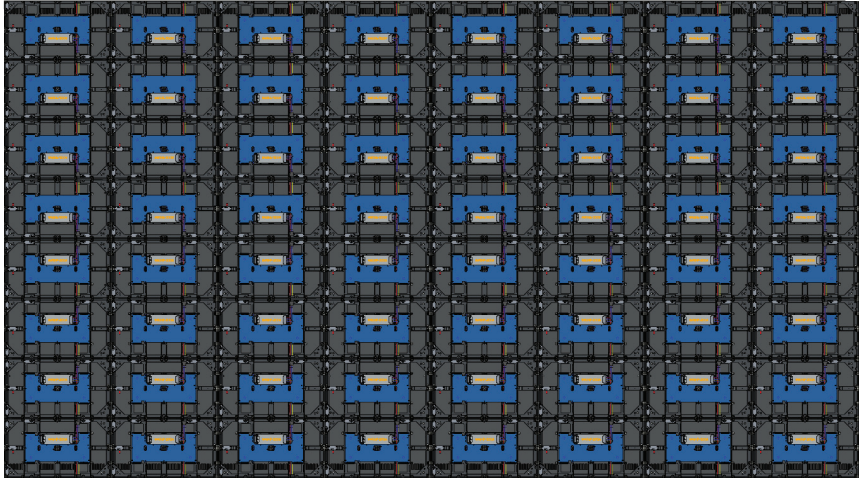

٣- اضبط الخزانة اليسرى أو اليمنى كي تتناسب بسلاسة مع الخزانات الوسطى.

٤- قم بدفع كل برغي قفل وأغلق كل خطاف بأداة مسدسة لربط الجزأين الأيسر والأيمن من الغلاف الخارجي بأمان. وقد تلزم محاذاة الفتحة باستخدام مفتاح الن لتعشيق لسان الإرتاج.

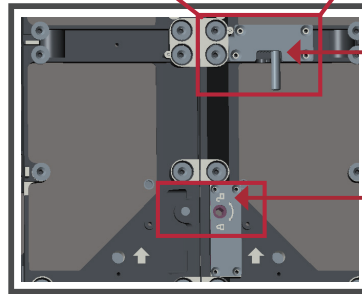
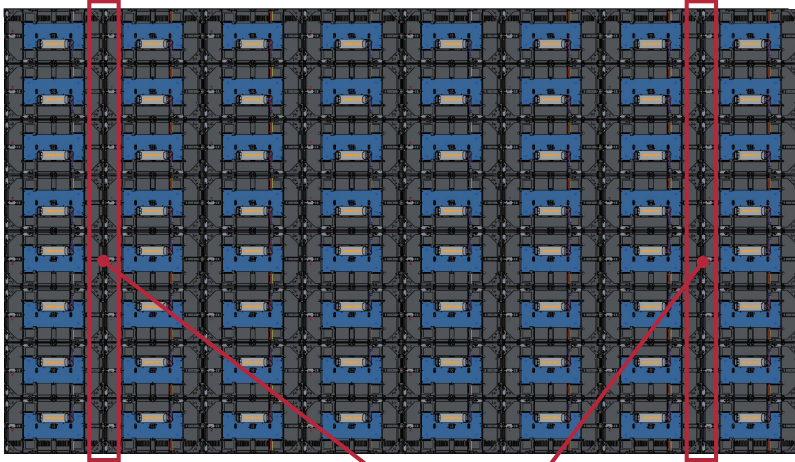

قم بدفع برغي القفل.

قم بفتح كل خطاف باستخدام أداة مسدسة.

ملاحظة: توجد ٨ ألسنة إرتاج ١٦ خطاطيف بين كل خزانة وأخرى.

توصيل صندوق التحكم في النظام

١- قم بكشف لوحة صندوق التحكم في النظام بحرص، وتأكد من أن اللوحة الأساسية للتحكم في النظام تقع على الجانب الأيسر.

ملاحظة: توخ الحرص؛ إذ أن لوحة صندوق التحكم في النظام مفصولة إلى قطعتين بالأسلاك المثبتة.
٢- قم بمحاذاة فتحات الغلاف الخارجي مع صندوق التحكم في النظام لتوصيله.



لوحة التحكم في النظام

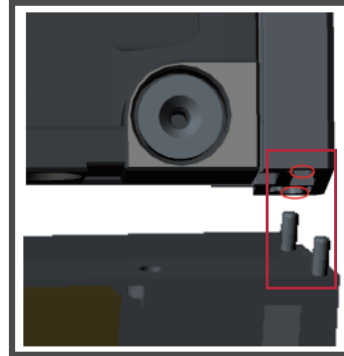

٣- يمكنك أيضًا إعادة تركيب كبل الطاقة للحصول على مظهر جذاب، وإرخاء مسامير PWM 6×4 مم الثلاثة (٣) وسحب كبل الطاقة للخارج وتميرير كبل الطاقة عبر الفتحة الخلفية ثم إحكام ربط المسامير.

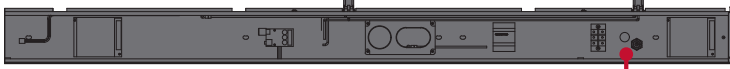

فتحة خلفية لكبل الطاقة المخفي

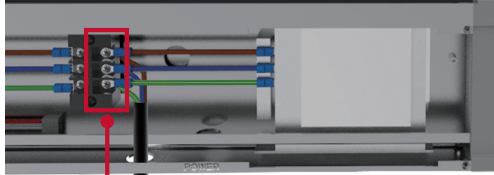

ثلاثة (٣) مسامير PWM 6×4 مم

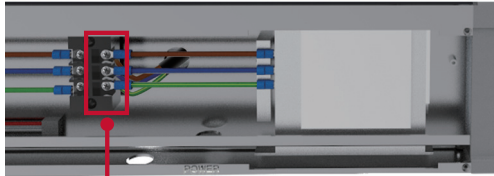

ثلاثة (٣) مسامير PWM 6×4 مم

! التشغيل من قِبَل فني مهني فقط.

٤- أحكم تثبيت صندوق التحكم في النظام في الخزانات باستخدام مسامير ١٦×M6 مم الـ ٣٢ المرفقة.

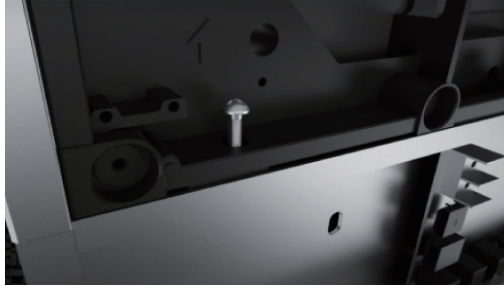

٥- قم بتوصيل كبلات الشبكة والطاقة الخاصة بأجزاء الغلاف الخارجي بصندوق التحكم في النظام.

ملاحظة: توجد ٤ كبلات شبكة و ٨ كبلات طاقة يلزم توصيلها.

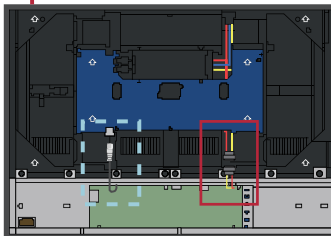
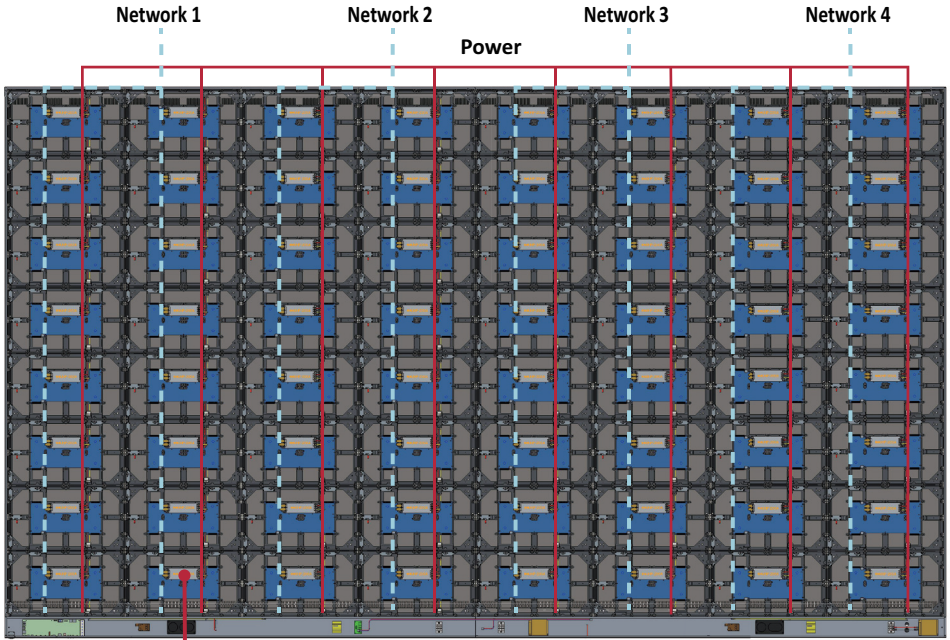

تركيب وحدات LED

قم بتركيب كل وحدة LED داخل أجزاء الغلاف الخارجي مع التأكد من مطابقة الأرقام الموجودة على الوحدة بما يقابلها في الغلاف الخارجي.
يرجى ارتداء قفازات مضادة للكهرباء الإستاتيكية قبل التعامل مع وحدات LED. !

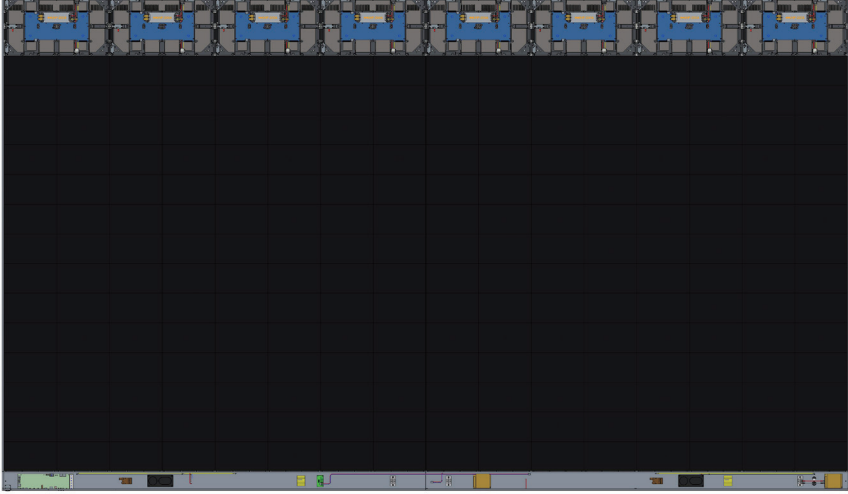

تأكد من تسطح كل وحدة وأن هناك فجوة ضئيلة أو معدومة بين كل وحدة. قد يلزم الطرق برفق على الوحدة لتصبح متساوية.



تركيب أغطية صندوق التحكم في النظام

توجد ثلاثة (٣) أغطية لصندوق التحكم في النظام: أيسر وأوسط وأيمن.



١- ابدأ بتركيب الغطاء الأيمن على صندوق التحكم في النظام.

ملاحظة: تأكد من توصيل كبل التشغيل بكبل تشغيل صندوق التحكم في النظام قبل إحكام تثبيت الغطاء.

٢- بعد توصيل كبل زر التشغيل، تأكد من صحة محاذاة الغطاء الأيمن مع صندوق التحكم في النظام، ثم أحكم تثبيته باستخدام مسامير 6×KM3 مم الـ ١٨ المرفقة.



٣- كرر الخطوات أعلاه لكل من الغطاء الأوسط والأيسر.

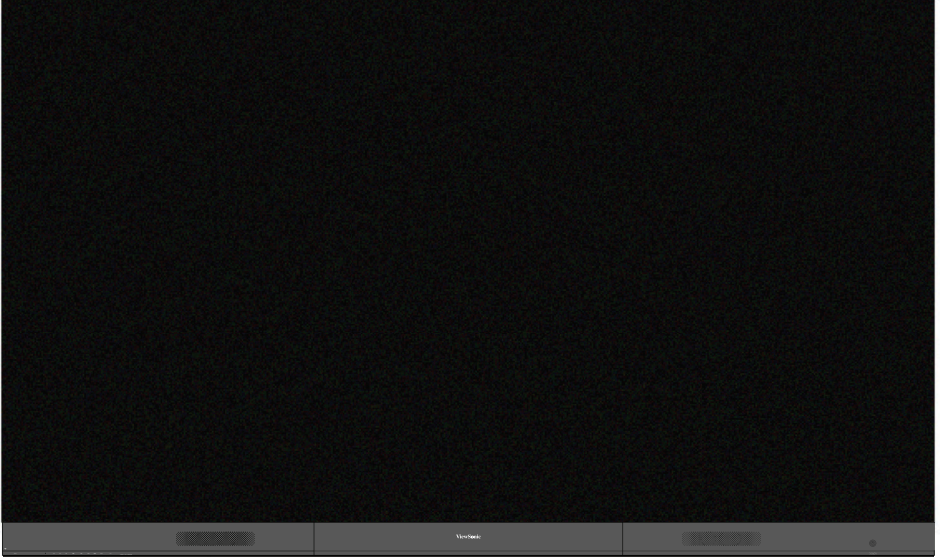

٣- تصيح الشاشة عندئذ جاهزة للتشغيل.





ViewSonic®