

English

Quick Setup Guide

Please read this manual carefully before operating your set and retain it for future reference.

Français

Guide de configuration rapide

Veuillez lire ce guide de configuration rapide attentivement avant d'utiliser votre produit et conservez-le pour pouvoir vous y reporter ultérieurement.

Español

Guía Rápida de Configuración

Lea atentamente este manual antes de poner en funcionamiento el equipo y consérvelo para futuras consultas.

+ English Depending on country / **Français** Selon les pays / **Español** En función del país



* M B M 6 7 5 1 4 9 8 2 *

(2207-REV00)



- English** It is recommended that use the supplied components.
- Français** Il est recommandé d'utiliser les composants fournis.
- Español** Se recomienda utilizar los componentes suministrados.



www.lg.com

- English** You can download manuals from the LGE website.
- Français** Vous pouvez télécharger les guides pour ce produit à partir du site Web de LGE.
- Español** Puede descargar los manuales del sitio web de LGE.



- English** - For EPEAT (EPEAT applied model)
Spare parts are available for 5 years after the end of production.
Spare parts include base assembly, adapter and cables.
It may differ by model, you can get the more information by visiting to this website:
<https://lgparts.com/>
- Français** - Pour EPEAT (modèles pour lesquels s'applique EPEAT)
Les pièces de rechange sont disponibles jusqu'à cinq ans après la fin de la production.
Elles comprennent les pièces pour l'assemblage de la base, l'adaptateur et les câbles.
Les pièces de rechange peuvent varier selon le modèle. Vous pouvez obtenir plus de renseignements en visitant le site Web
<https://lgparts.com/>

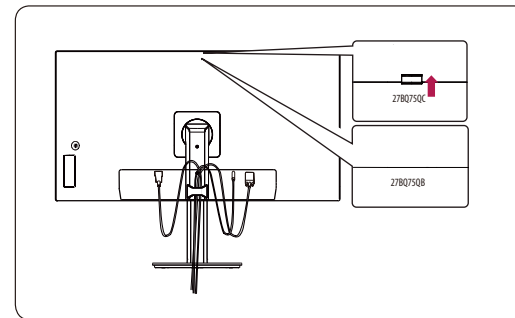
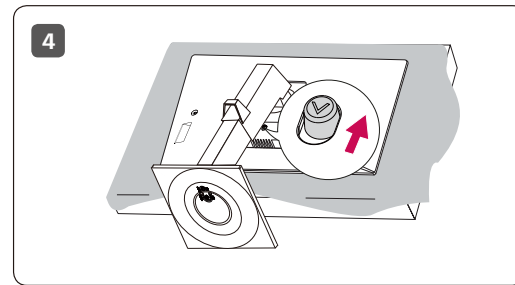
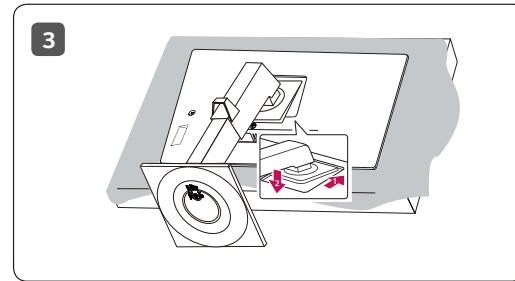
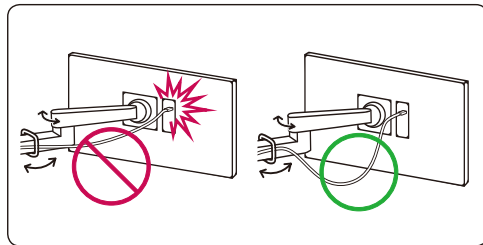
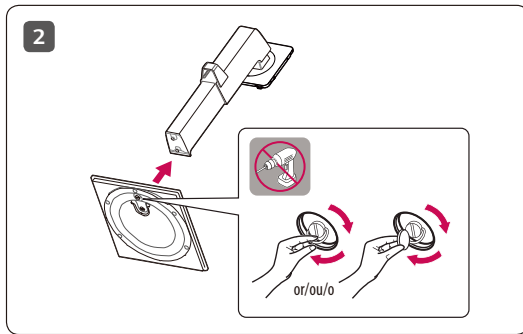
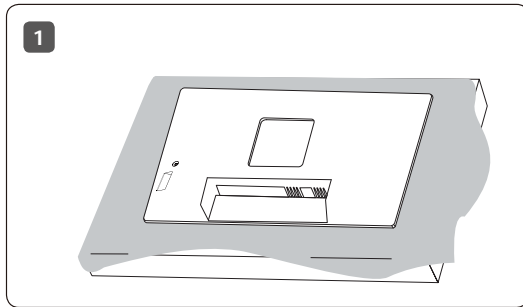



27BQ75QC

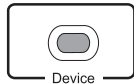
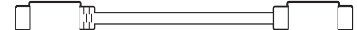
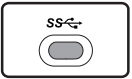
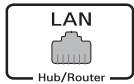
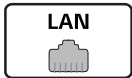
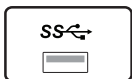
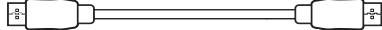
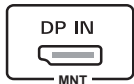
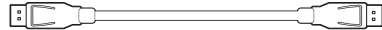
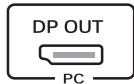
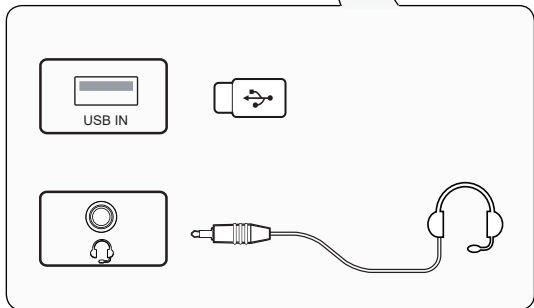
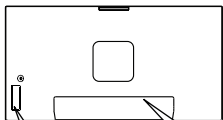



27BQ75QB

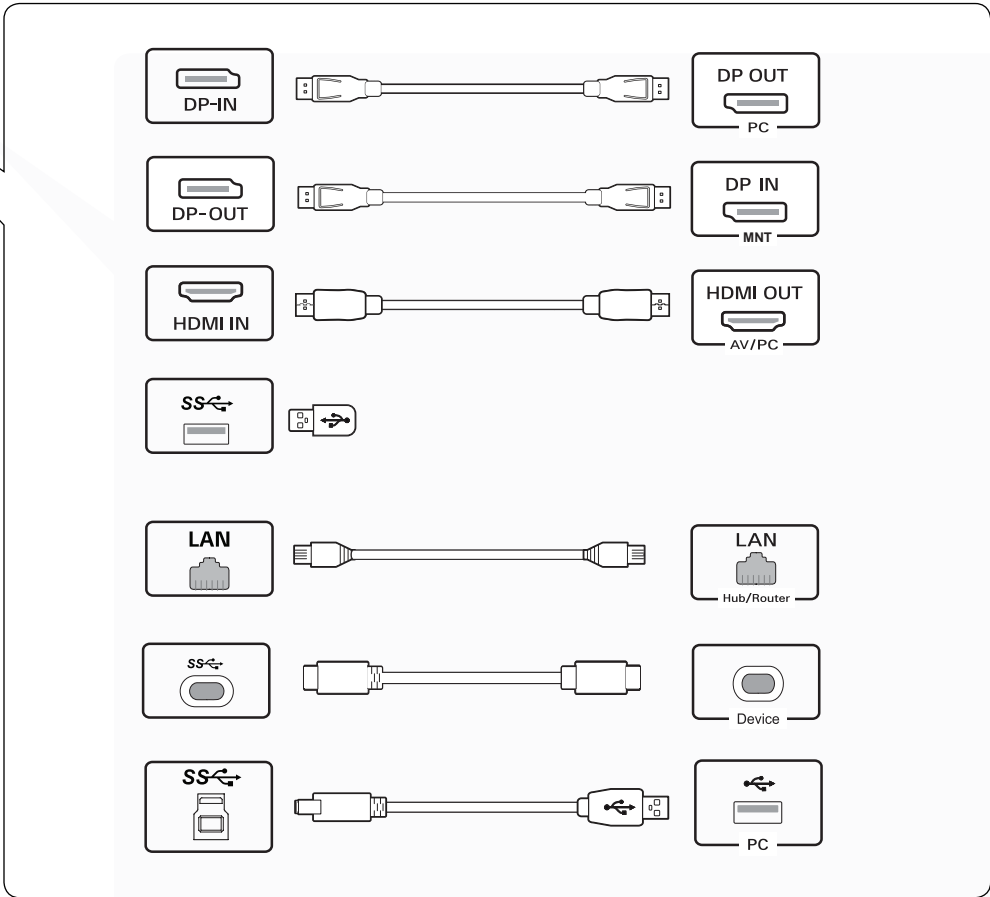
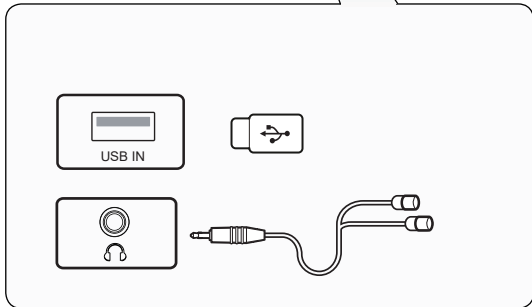
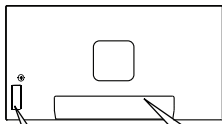

**English**

- Using a DVI to HDMI / DP (DisplayPort) to HDMI cable may cause compatibility issues.
- The USB port on the product functions as a USB hub.
- Make sure to use the supplied cable. Otherwise, this may cause the device to malfunction.

Français

- L'utilisation d'un câble DVI à HDMI/DP (DisplayPort) à HDMI peut présenter des problèmes de compatibilité.
- Le port USB du produit fonctionne comme un concentrateur USB.
- Assurez-vous d'utiliser le câble fourni avec le produit. Le non-respect de cette consigne peut entraîner un dysfonctionnement du périphérique.

Español

- El uso de un cable de DVI a HDMI / DP (DisplayPort) a HDMI puede causar problemas de compatibilidad.
- El puerto USB en el producto funciona como un concentrador USB.
- Asegúrese de utilizar el cable suministrado con el producto. De lo contrario, puede provocar que el dispositivo no funcione correctamente.



27BQ75QC

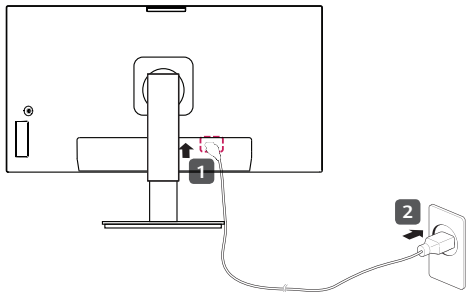

27BQ75QB

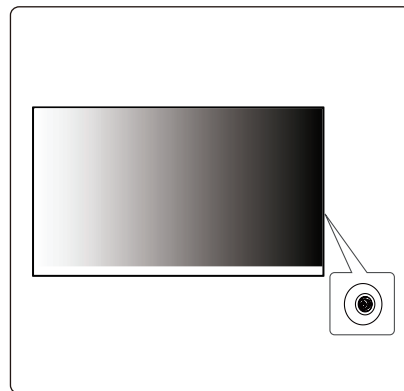
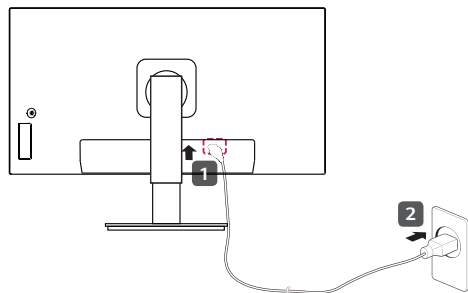



English	Dimensions (Width x Height x Depth)		Weight		Recommended Resolution	Vertical Frequency
	With Stand 613.5 x 527.6 x 239.6 (mm) 24.1 x 20.7 x 9.4 (inches)	Without Stand 613.5 x 363.5 x 63.0 (mm) 24.1 x 14.3 x 2.4 (inches)	With Stand 8.2 (kg) 18.0 (lbs)	Without Stand 6.1 (kg) 13.4 (lbs)		
Français	Dimensions (largeur x hauteur x profondeur)		Poids		Résolution recommandée	Fréquence verticale
	Avec socle 613,5 x 527,6 x 239,6 (mm) 24,1 x 20,7 x 9,4 (po)	Sans socle 613,5 x 363,5 x 63,0 (mm) 24,1 x 14,3 x 2,4 (po)	Avec socle 8,2 (kg) 18,0 (lb)	Sans socle 6,1 (kg) 13,4 (lb)		
Español	Dimensiones (anchura x altura x profundidad)		Peso		Resolución recomendada	Frecuencia vertical
	Soporte incluido 613,5 x 527,6 x 239,6 (mm)	Soporte no incluido 613,5 x 363,5 x 63,0 (mm)	Soporte incluido 8,2 (kg)	Soporte no incluido 6,1 (kg)		
	Clasificación de potencia		100-240 V~ 50/60 Hz 2,5 A			