



LCD Monitor Quick Start Guide

DesignVue Designer Monitor | PD Series



DN: PD2506Q-EQ-V0

© 2022 BenQ Corporation. All rights reserved. Rights of modification reserved.

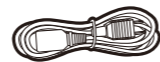
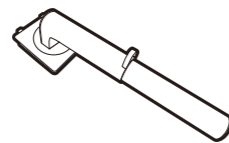
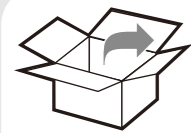

DP

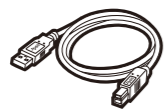

USB



USB-C™



Quick Start Guide



Regulatory Statements



Safety Instructions

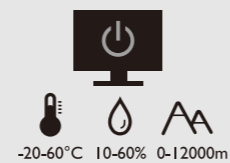
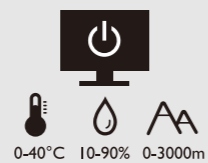

(For models with HDMI inputs)



P/N: 4J.XXXXX.XXX

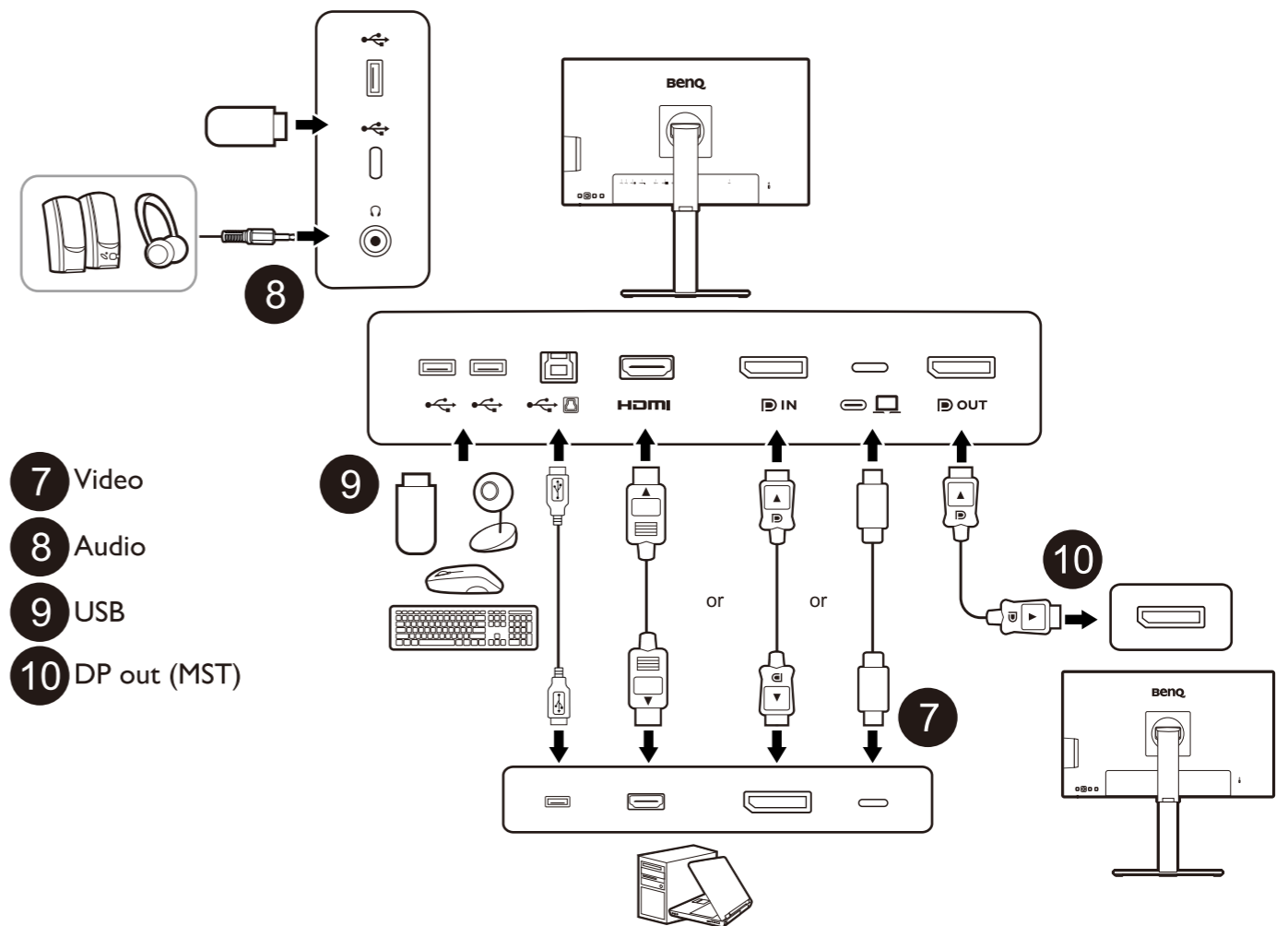
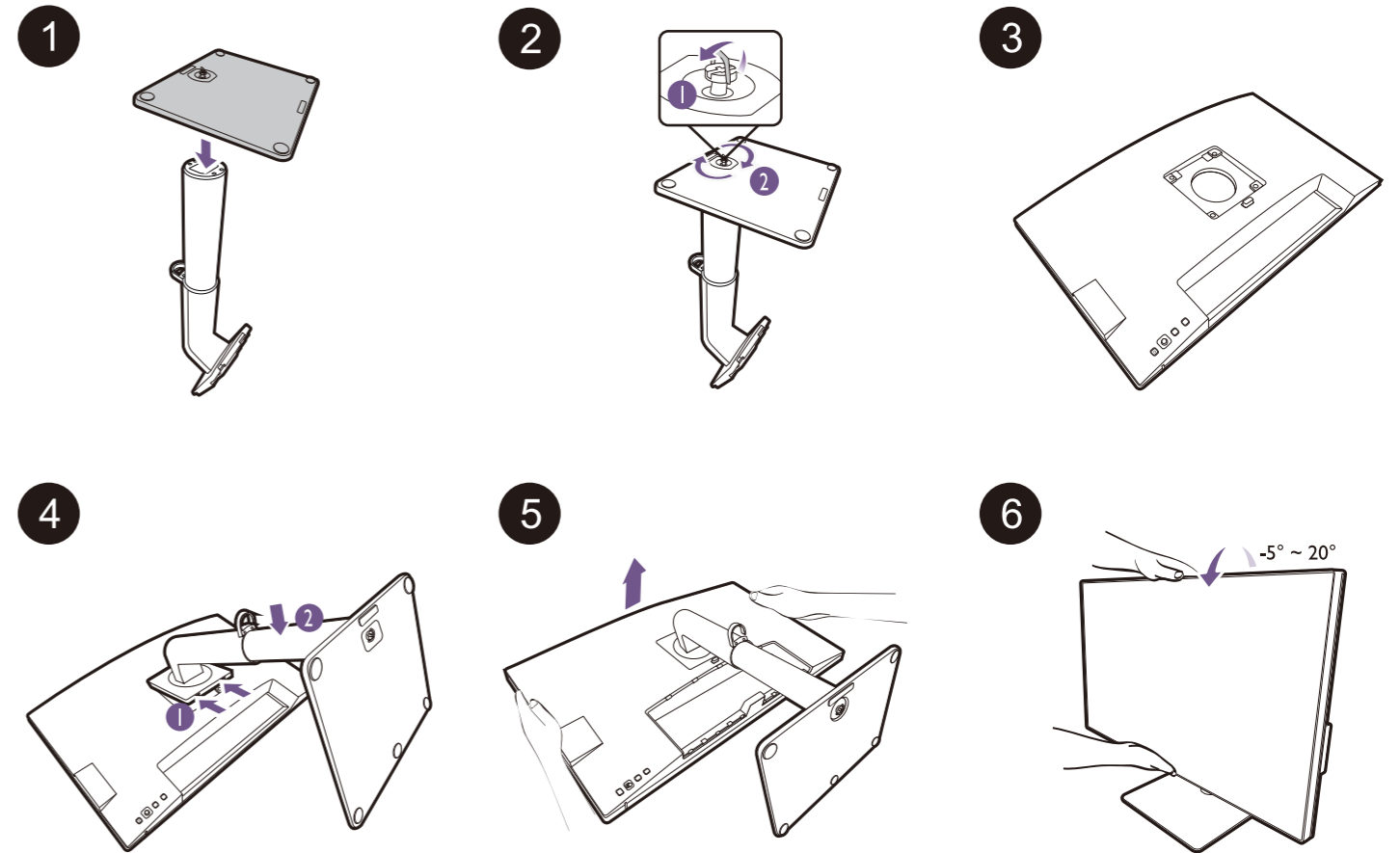

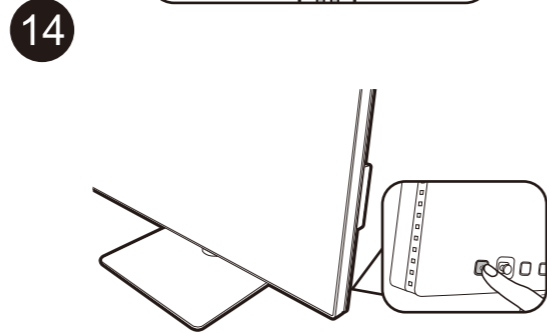
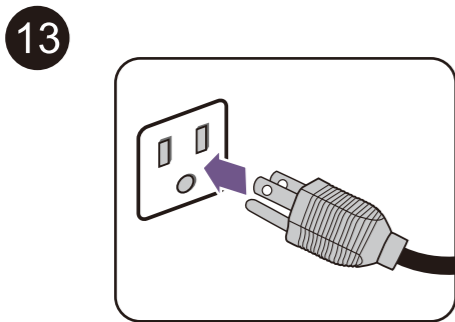
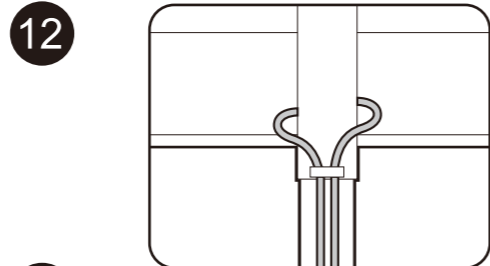
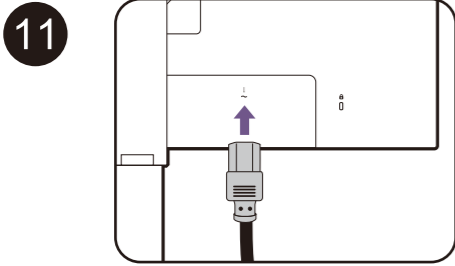

Software installation

Display Pilot: for display arrangement & color matching (ICCsyntax)

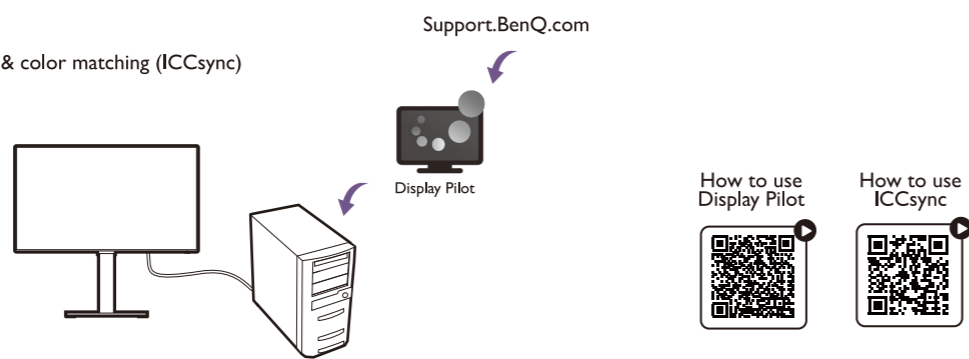

Working with multiple inputs with one set of keyboard and mouse (KVM Switch)

Connections

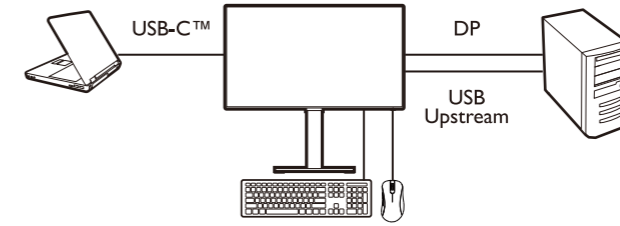

Switch of KVM sources

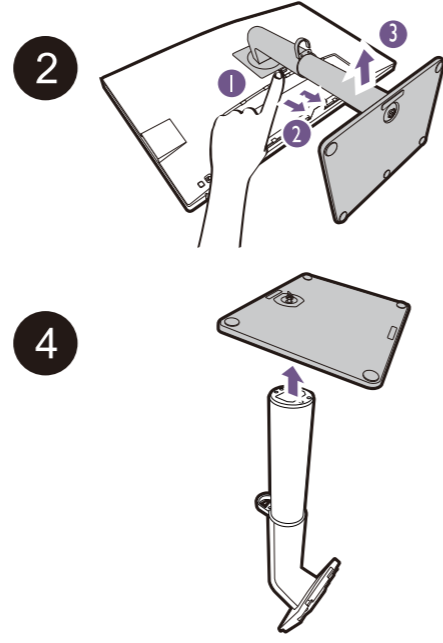
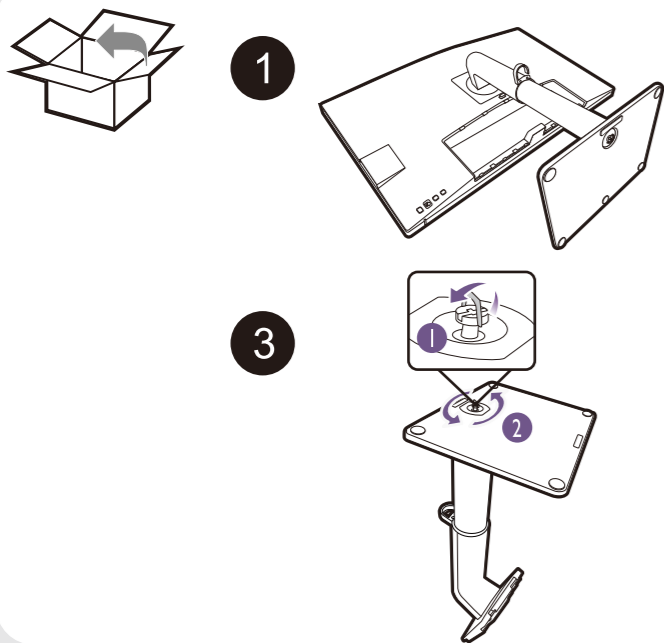
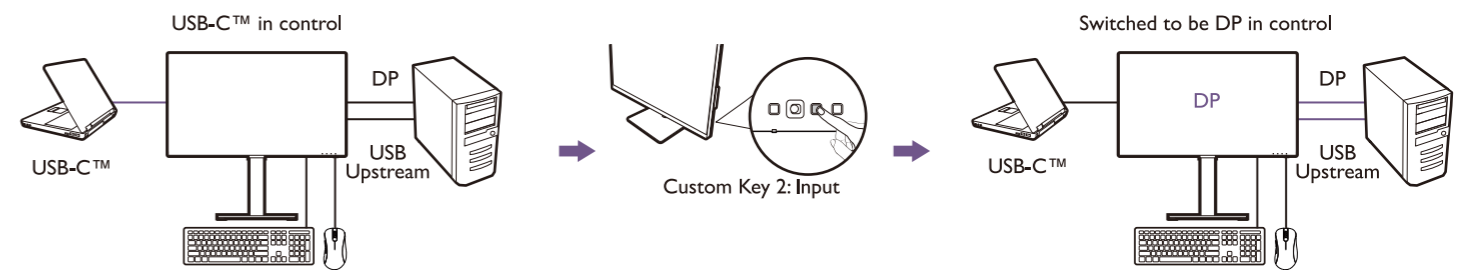

Connecting multiple monitors (DP MST)

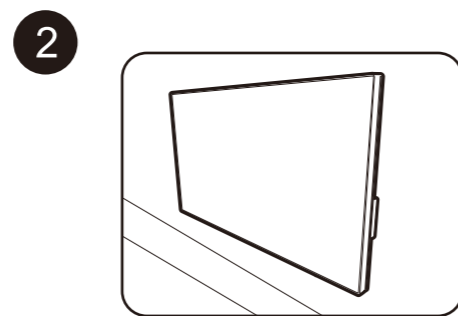
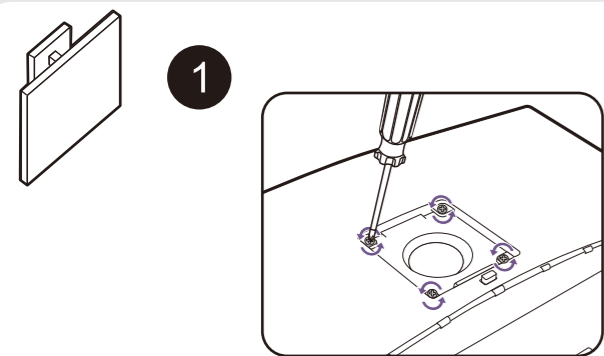
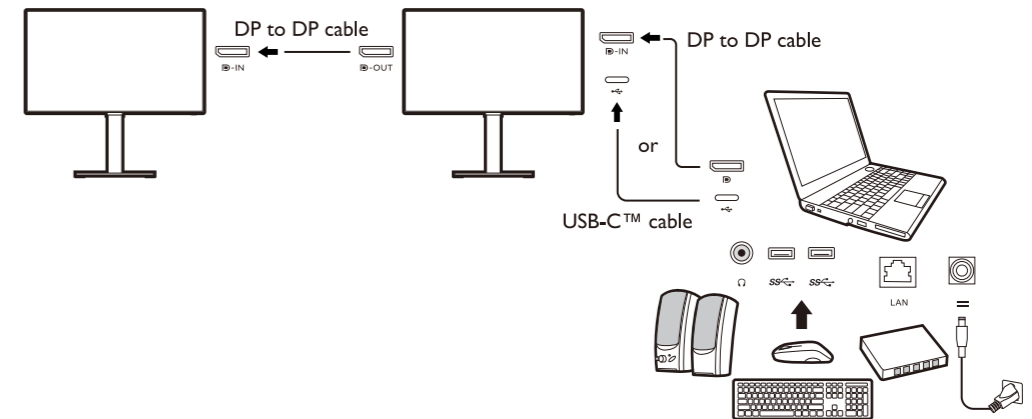

Online Manual

Product Support

Software Download

For professional color display



CAD / CAM Mode

Animation Mode

For work efficiency



KVM Switch