

The QNAP logo is located in the top right corner of the image. It consists of the letters 'QNAP' in a bold, white, sans-serif font, with a stylized white line above the 'Q'.

TS-h1090FU

All-flash 1U 10-bay rackmount NAS

ZFS-based, U.2 NVMe PCIe Gen 4 / SATA
6Gbps SSD storage with 25GbE & PCIe Gen4
for low-latency file servers, virtualized workloads,
data centers, and 4K/8K streams



25GbE
2.5GbE

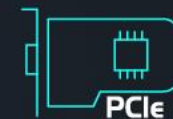

High efficiency enterprise storage trend for all flash SSD NAS w/ NVMe 、 PCIe Gen4 、 and 25GbE

Decreasing (8~13%) NVMe PCIe Gen4 SSD price trend enables all flash NAS for business storage agility

“High-performance metadata databases, database engines, and NVMe SSDs deliver the performance needed... Additionally, beyond compression, PCI-Express 4.0 specification for bandwidth improvements...and significant price declines, has made it economically feasible to deploy at large scale”

<https://www.networkworld.com/article/3666956/8-enterprise-storage-trends-to-watch.html>

“TrendForce predicts NAND flash prices will decline 8-13 percent in the third quarter of 2022, and may continue into the fourth quarter”

https://www.theregister.com/2022/07/19/nand_flash_decline/

Virtualization



Database

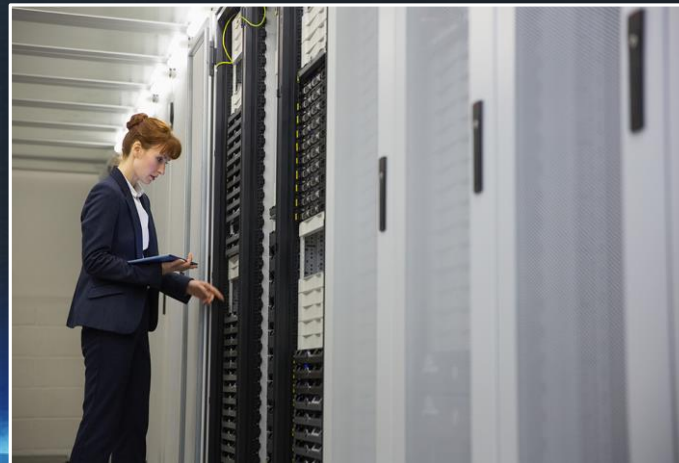

Media & Entertainment



Performance bottleneck in SAS all-flash NAS

SAS all flash storage servers may experience performance bottlenecks.

A Multiple SAS controllers

Each SSD gets 1 full PCIe lane bandwidth (8Gb/s)

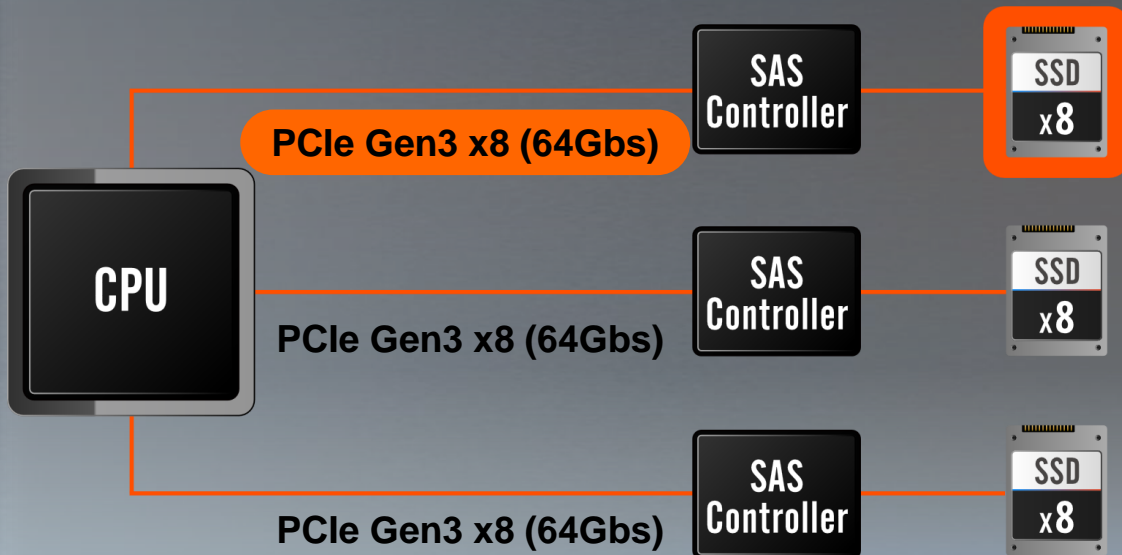

B SAS controller + expander

Each SSD gets 0.3 PCIe lane bandwidth (2.4Gb/s)



The next-gen TS-h1090FU NVMe all flash NAS

Each NVMe PCIe SSD has full 64Gb/s bandwidth

2nd gen AMD EPYC (ROME) 7002 series provides 128 PCIe lanes
Each SSD gets 4X PCIe lane bandwidth (64 Gb/s)

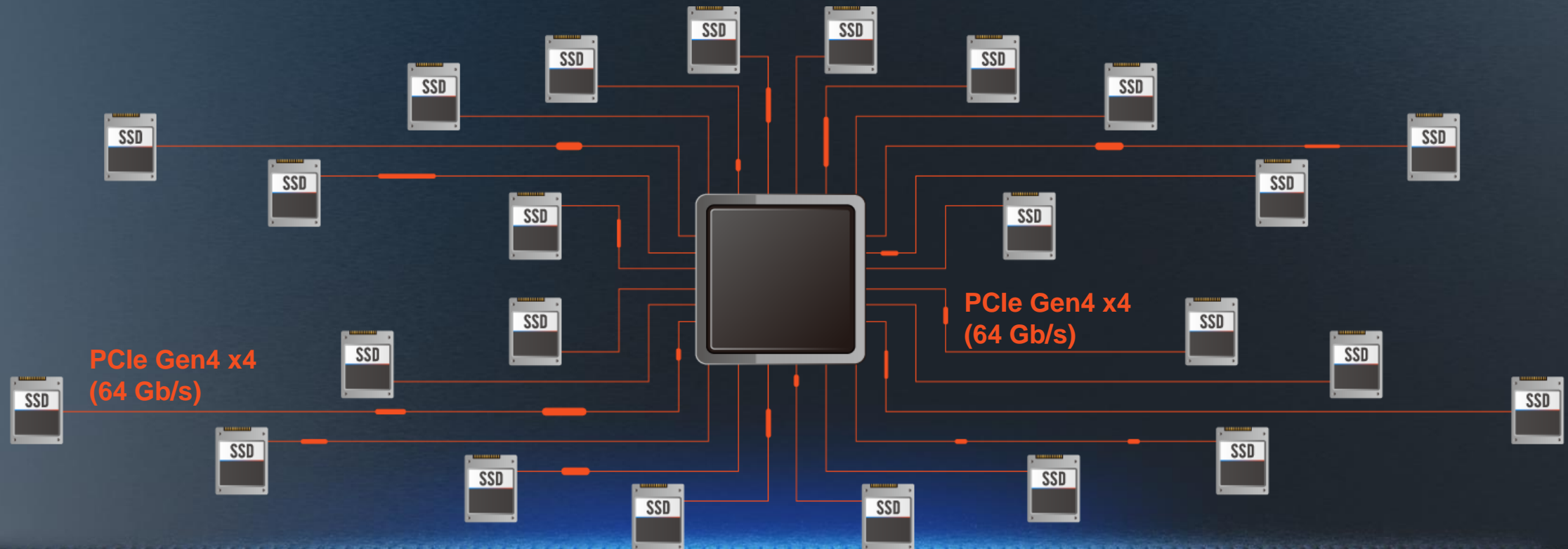

TS-h1090FU with AMD EPYC 7002 (Rome) enterprise CPU built for datacenters

The 2nd gen AMD EPYC is designed for data center for the intensive workload. With its 7nm manufacturing technology, up to 64 cores, and better efficiency, it provides 4X the performance of floating points operations and 2X the CPU socket performance.

- TS-h1090FU is equipped with an 8-core/16-thread 7232P or 16-core/32-thread 7302P processor
 - AMD EPYC 7232P 8C / 16T up to 3.2 GHz
 - AMD EPYC 7302P 16C / 32T up to 3.3 GHz
- CPU with 128 PCIe Gen4 high-speed lanes
- 12 x 8-channel DDR4 RDIMM ECC memory slots

1U 10-bay TS-h1090FU all-flash NAS front view

Dimension (H x W x D): 44 x 430 x 582 mm / 1.73 x 16.96 x 22.91 inches

LED indicators
Status, LAN, expansion

10 x 2.5" U.2 NVMe PCIe Gen4 x4
(compatible w/ U.3 & PCIe Gen3 SSD)
or SATA 6Gb/s SSD hot-swap drive bays



Lockable SSD trays,
2 keys are included



2.5-inch NVMe / SATA SSD installation

1. Remove the SSD tray

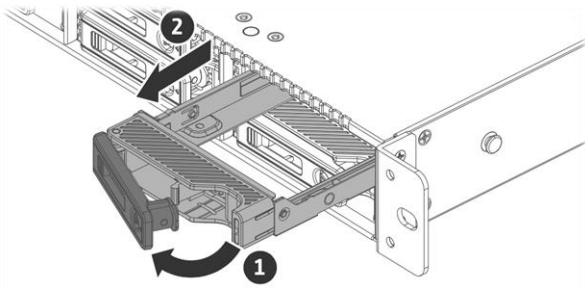

2. Install an SSD

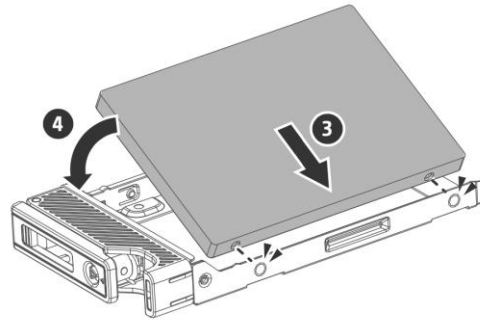

3. Fasten the screws with a screw driver

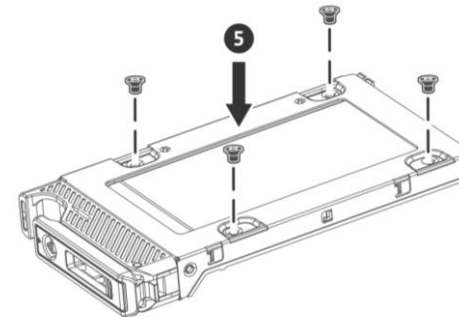

4. Insert the SSD tray

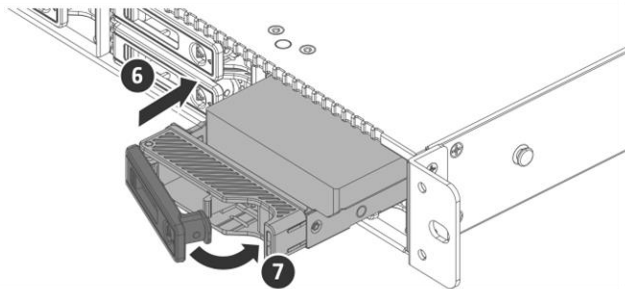

5. Lock the trays w/
a key (optional step)

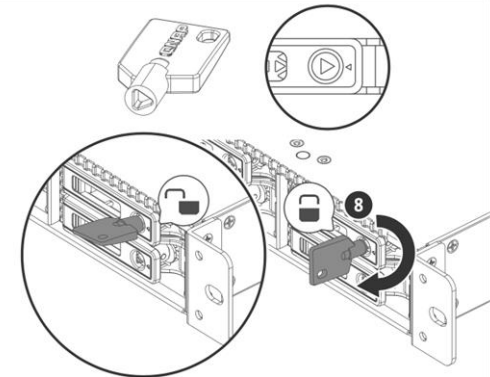

What if U.2 NVMe SSDs are not available in your country or if the cost is over your IT budget?

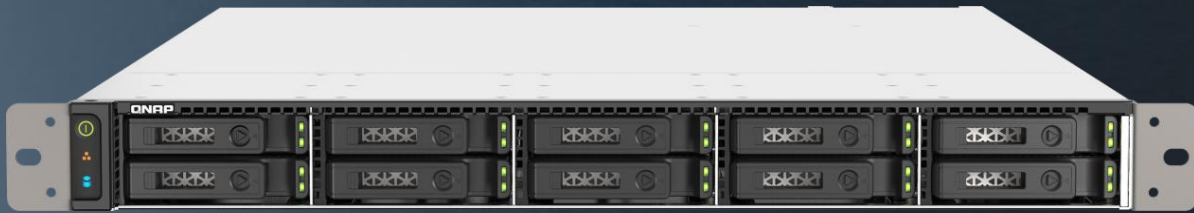

10 x U.2 NVMe SSD in the all flash
NAS TS-h1090FU



Not available for
sale or long lead
time?



Too expensive
and over your IT
budget?

Economically use M.2 NVMe SSDs with QNAP QDA-UAMP4 U.2 to M.2 SSD adapter

Order P/N: QDA-UAMP4

U.2 NVMe to M.2 NVMe PCIe adapter, supporting PCIe 4.0/3.0

- Use readily available and more affordable M.2 NVMe PCIe Gen4/Gen3 SSDs
- Excellent heat-conductive metal design with thermal pads so that M.2 SSDs do not overheat. Keep the optimal performance and prolong the life.

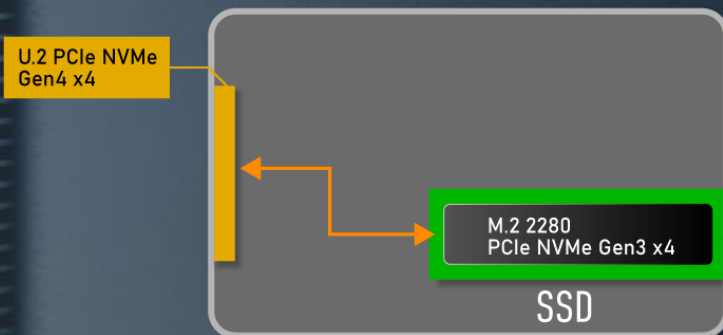
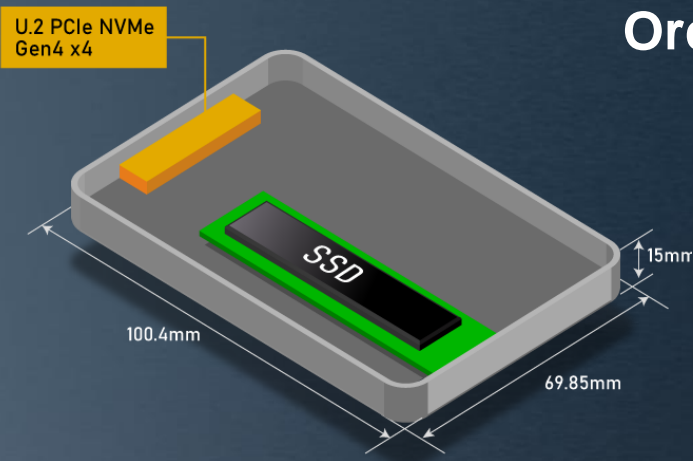

68 x 21 mm (on the top side of M.2 SSD)

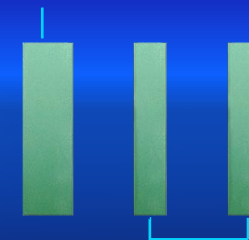

68 x 15 mm (on the bottom side of SSD. Use 2 for single sided SSDs)

12 DDR4 ECC RDIMM RAM slots, 8-channel high-speed memory, up to 1TB RAM total

AMD EPYC 7002 (Rome) server grade processors support ECC Registered memory for auto detection and corrections of error bits.

Support 1TB RDIMM ECC RAM

ECC

Registered w/ parity,
Error correction and detection

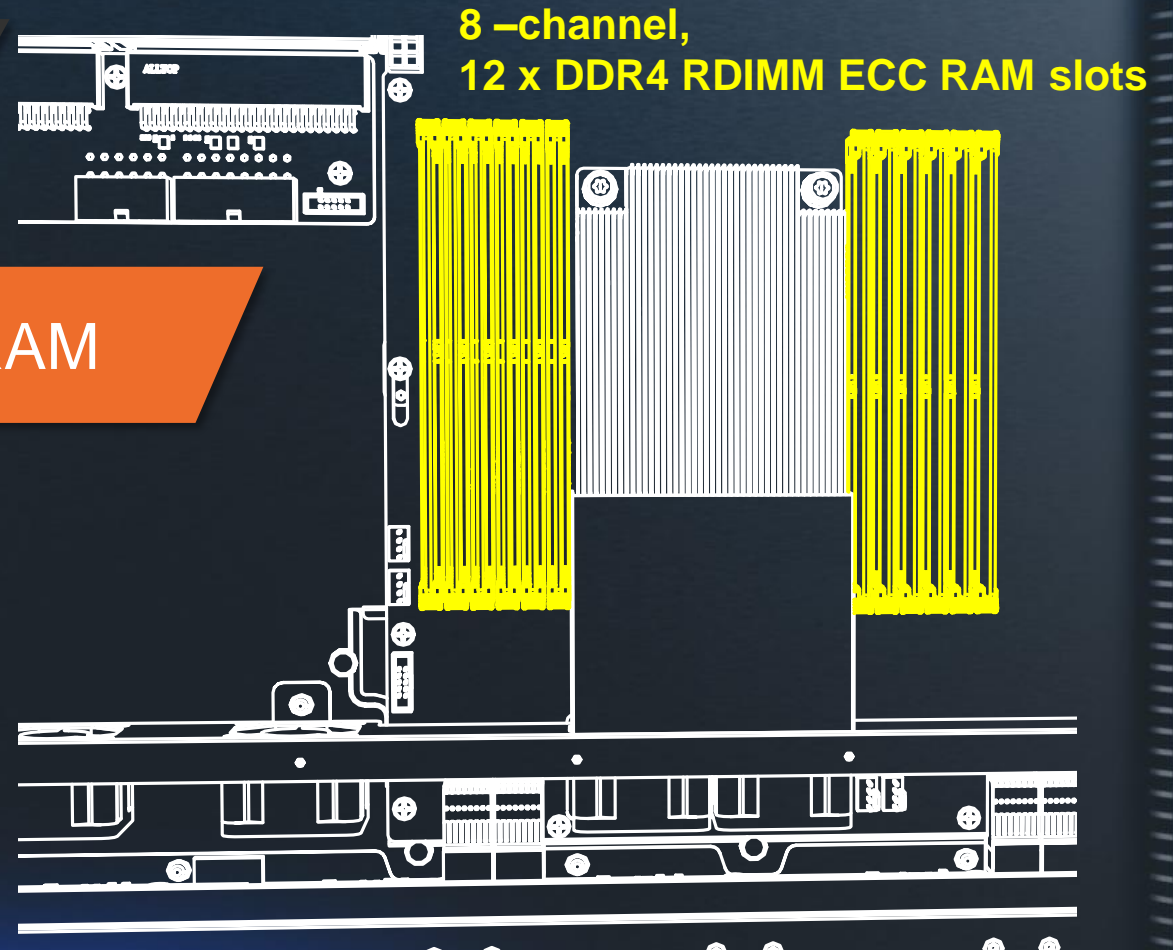
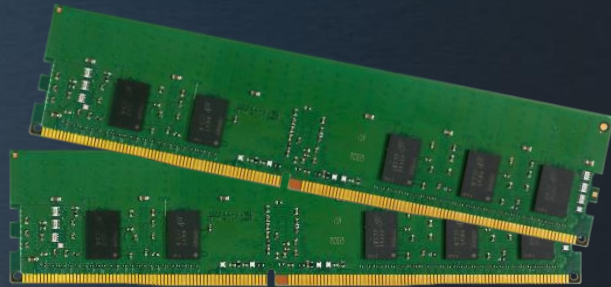

1U 10-bay TS-h1090FU all-flash NAS rear view

2 x 25GbE SFP28 LAN ports
(compatible with 10GbE SFP+/1GbE SFP)

2 x 2.5GbE RJ45 LAN ports
(compatible with 1GbE RJ45)

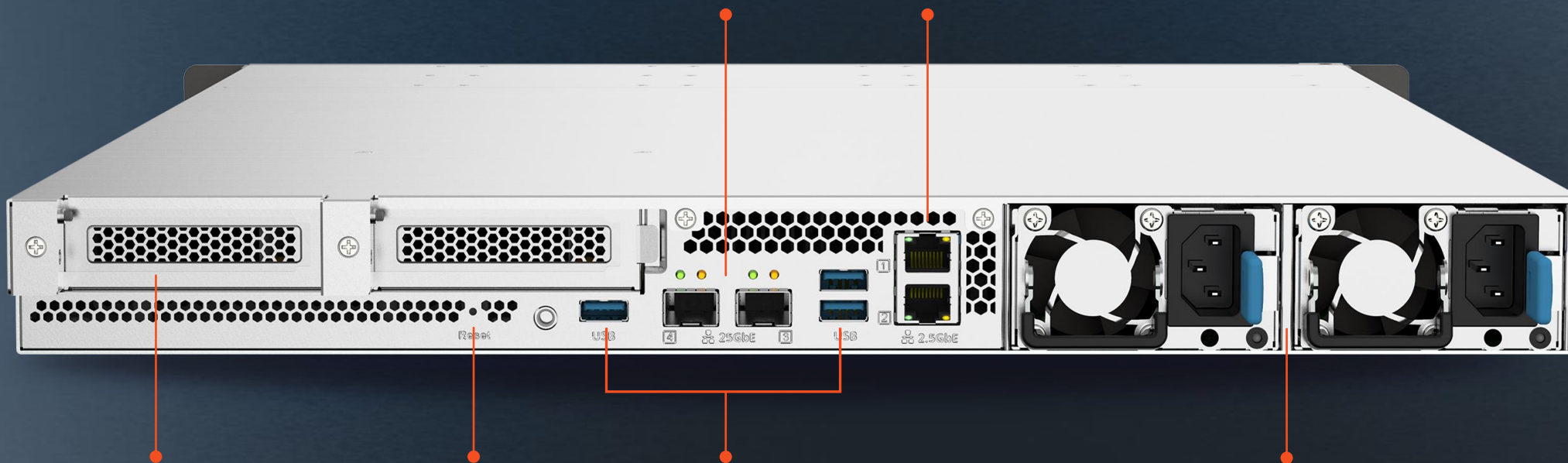

2 x PCIe Gen4 x16
half-height slots

Reset button

3 x USB-A 3.2 Gen1
5Gbps ports

2 x 550W redundant PSUs

Dual 2.5GbE (2.5G/1G) Multi-Gig ports for speedy transfer & management right away

2 x 2.5 GbE RJ45 LAN ports

Integrated dual 2.5GbE LAN ports for auto negotiation of 2.5GbE / 1GbE / 100MbE. Reach 5Gbp with Port Trunking setup for dual client concurrent transfer.



No need to change wiring infrastructure. CAT 5e can provide 2.5X speed.

	CAT 5e	CAT 6	CAT 6A
100M	✓	✓	✓
1G	✓	✓	✓
2.5G	✓	✓	✓
5G	✓	✓	✓
10G	X	(55m)	✓

Note: clients and switch must also support 2.5GbE to achieve the 2.5GbE link speed.



Dual 25GbE SFP28 ports for next-gen speed and future business growth

- Integrated 2 x 25GbE SFP28 SmartNIC ports
- Link Aggregation for increased performance

Supports 25GbE
SFP28 transceivers
& LC cable

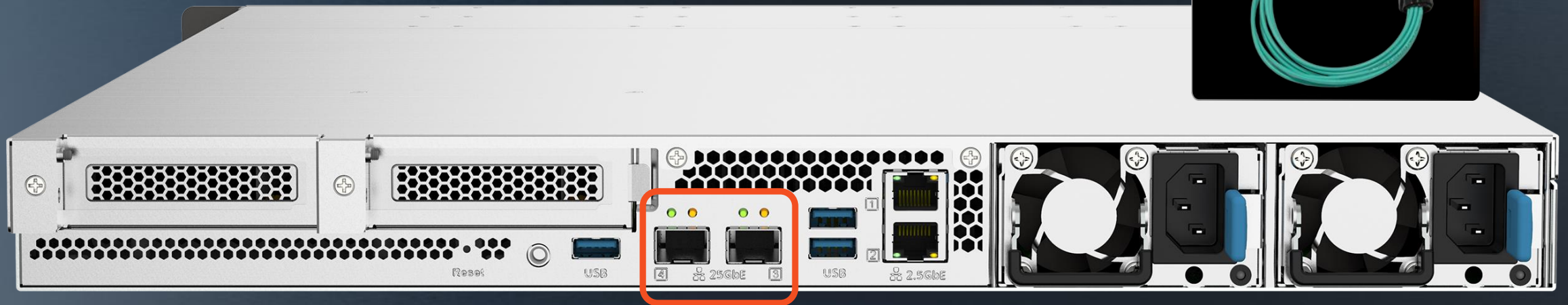

Flexible Ethernet configuration 25GbE is also compatible with 10GbE and 1GbE environment

- The 25GbE SFP28 Ethernet ports support transceivers or DAC cables
- Compatible with **10GbE** and **1GbE** networks by using corresponding SFP+/SFP transceivers or DAC cables
- Auto-negotiation the link speed

10GbE SFP+ transceiver



with LC cable

1GbE SFP transceiver



With LC cable



10GbE Switch
QSW 10GbE switch series

10GbE SFP+



QNAP QSW-M5216-1T 16-port 25GbE switch

25GbE SFP28



PCIe Gen4 x16 slots for 100GbE Ethernet

- Install the QNAP **QXG-100G2SF-E810** network card with a 100GbE switch for 100GbE network adaptation and future proof your storage investment.
- Support port-configuration mode to connect to 4 x 25GbE port.
- Connect your 100GbE server to **4 x 25GbE** or **8 x 10GbE** end devices with native port-configure mode

CAB-DAC15M-Q28B4



CAB-DAC15M-Q28



25GbE SFP28

Mellanox 25 / 100 GbE Switch (SN2010)

Full-height
bracket included



QNAP QXG-100G2SF-E810

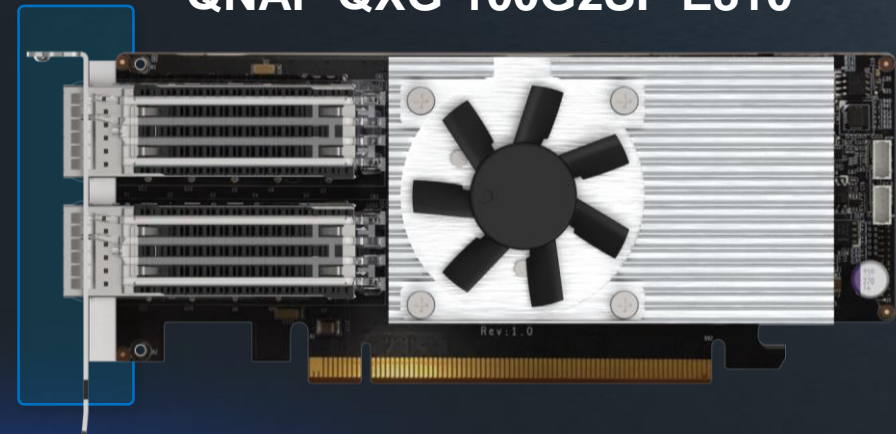

Pre-installed low-profile bracket

Abundant 100GbE/40GbE/25GbE/10GbE/5GbE/2.5GbE high-speed network cards with plug and use support

10GbE NIC

2 x RJ45

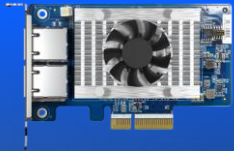

LAN-10G2T-X710

2 x RJ45

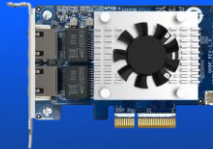

QXG-10G2TB

1 x RJ45

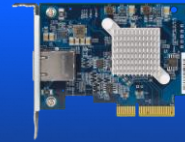

QXG-10G1TB

5GbE NIC

1/2/4 x RJ45

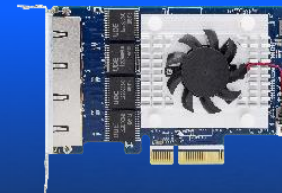

QXG-5G1T-111C
QXG-5G2T-111C
QXG-5G4T-111C

40/25GbE NIC

2 x QSFP+ 40Gb/s



LAN-40G2SF-MLX

2 x SFP28 25Gb/s



QXG-25G2SF-CX6

100GbE NIC

2 x QSFP28

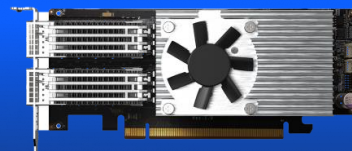

QXG-100G2SF-E810

2.5GbE NIC

1/2/4 x RJ45



QXG-2G1T-I225
QXG-2G2T-I225
QXG-2G4T-I225

Best-in-class performance of 8-core TS-h1090FU-7232P-64G with 6 x 25GbE clients

6 x 25GbE iSCSI, Random IOPS (4K), Compression On, Dedupe Off

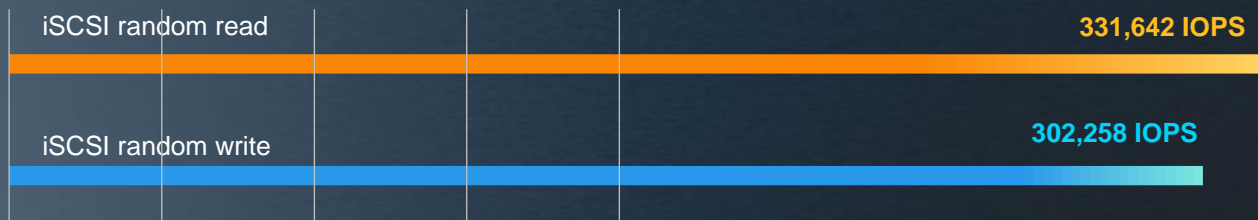

- Up to iSCSI 4K random read 331,624 IOPS & random write 302,258 IOPS!
- Up to SMB sequential read 12,769 MB/s & write 10,281 MB/s!

6 x 25GbE SAMBA, Sequential Throughput (1MB), Compression On, Dedupe Off

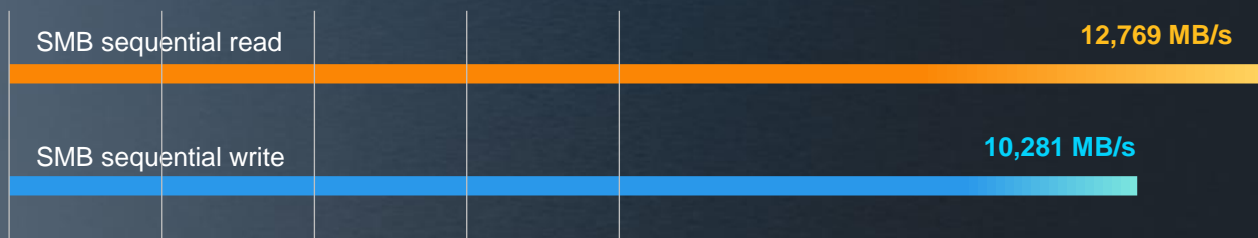

6 x 25GbE clients concurrent access

Tested in QNAP Labs. Figures may vary by environment.

Test Environment:

NAS: TS-h1090FU-7232P-64G with QuTS hero 5.0.0

Volume type: Samsung PM9A3 960G Gen4 U.2 NVMe SSD x24 (RAID 50); Intel QXG-100G2SF-E810; QXG-25G2SF-CX4

Client PC: 6* Client PC simultaneously read and write 16GB file (= 96GB totally)

Intel Core™ i7-7700 4.20GHz CPU, 32GB DDR4 RAM, QXG-25G2SF-CX4, Windows® Server 2016, and Intel Core™ i3-8100 3.60GHz CPU, 4GB DDR4 RAM, QXG-25G2SF-CX4, Windows® Server 2016

Add more M.2 NVMe PCIe SSD slots with QM2

QM2 cards help to add more M.2 NVMe SSD slots via PCIe expansion



Add more M.2 2280/22110 NVMe PCIe SSDs

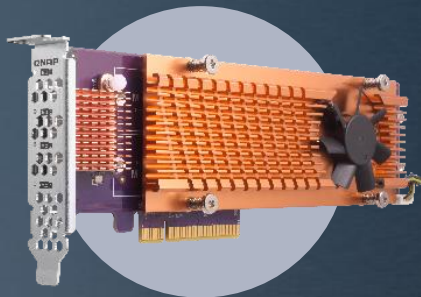

QM2-4P-384 (Gen 3 x8)

4 x M.2 2280 PCIe Gen 3 x4 NVMe SSD slots

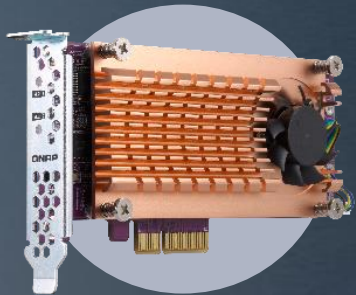

QM2-2P-384 (Gen 3 x8)

2 x M.2 22110/2280 PCIe Gen 3 x4 NVMe SSD slots

Add 10GbE and M.2 NVMe PCIe Gen4 SSD slots with PCIe Gen4 version of QM2 cards

Expand both Ethernet and M.2 NVMe SSD slots with the PCIe 4.0 QM2 series cards



PCIe 4.0 high speed bandwidth for M.2 & 10GbE

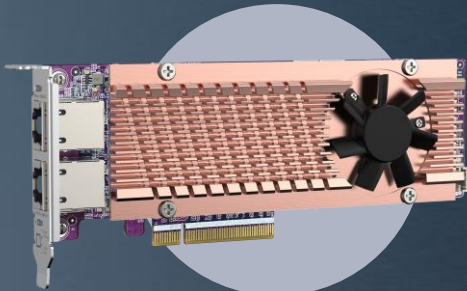

QM2-2P410G2T (Gen 4 x8)

4 x M.2 2280 PCIe **Gen 4 x4** NVMe SSD slots
+ 2 x 10GbE RJ45 ports

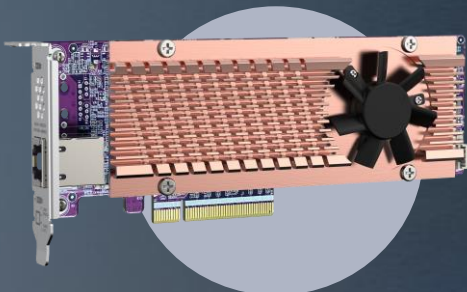

QM2-2P410G1T (Gen 4 x8)

2 x M.2 2280 PCIe **Gen 4 x4** NVMe SSD slots
+ 1 x 10GbE RJ45 port

Fibre Channel SAN 32Gb/s & 16Gb/s storage & backup with affordable NAS solution



QXP-32G2FC

2-port 32Gbps FC card

QXP-16G2FC

2-port 16Gbps FC card

Designed for **NAS**, high-performance and efficient **QNAP FC expansion cards***

* Installation on Windows/Linux hosts is not supported

Includes 2 optical FC transceivers.
Additional ones are available for purchase:



- **TRX-32GFCSFP-SR**

32Gb/16Gb/8Gb

- **TRX-16GFCSFP-SR**

16Gb/8Gb/4Gb

Note: cables are not included.



Reach PB storage capacity with multiple QNAP SAS 12Gb/s 12-bay & 16-bay JBOD units

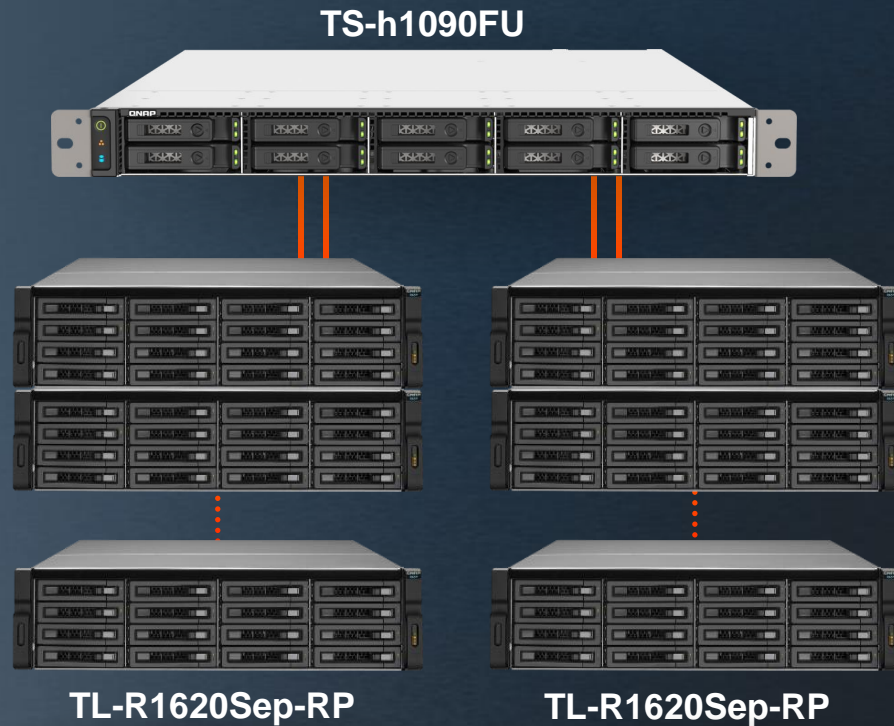

SAS HBA (optional purchase)

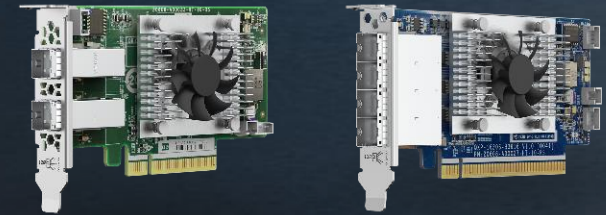

	QXP-820S-B3408	QXP-1620S-B3616W
PCIe bus	PCIe 3.0 x8	PCIe 3.0 x16
IOPS	1.2X	1.8X
Bandwidth	6,850 MB/s*	13,700 MB/s*
Ports	External 8 ports	External 16 ports
Connectors	2 x SFF8644	4 x SFF8644

NAS supports up to **16** QNAP SAS JBOD enclosures

- **12-bay TL-R1220Sep-RP** or **16-bay TL-R1620Sep-RP**
- Each NAS with **hundreds of HDDs** · **1~3PB** raw HDD capacity
- SAS JBOD can expand NAS existing storage pools

*The above data is for reference only based on IC vendor's data sheets. Actual performance could be different due to host, expansion unit or drives.

QNAP NAS x Seagate JBOD partnership for PB-level massive storage capacity



SEAGATE



QNAP TS-h1090FU NAS



Seagate JBOD



Huge Capacity

Tackle the massive storage requirements of 4K/8K multimedia, big data storage, critical backups, and more.

High Density

Seagate Exos E 5U84, the 5U rackmount enclosure, can house 84 drives for storing up to 1.5 PB.

Management

QNAP **Storage & Snapshots** Manager simplifies NAS and JBOD management, effectively minimizing IT operational workloads.

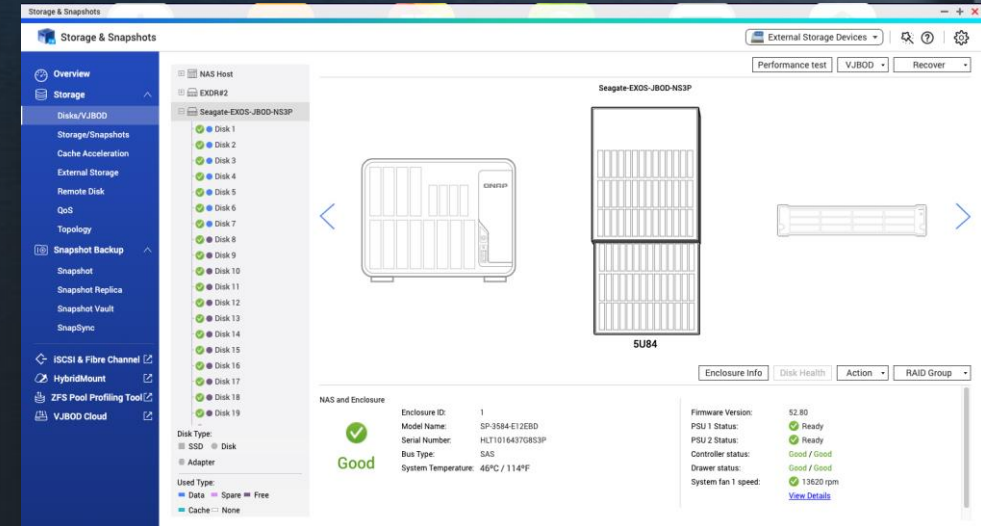

- QNAP NAS supports **Seagate Exos E SAS JBOD units** and **100+ drives** to provide **petabytes (PBs)** of raw capacity.

Note:

1. Optional purchase of SAS HBA is required for the NAS.
2. Seagate's JBODs can only be used as an individual storage pool or volume. Its storage pool/volume cannot be combined into the connected NAS. NAS applications cannot be installed on Seagate's JBODs.

Scale up NAS capacity with optimized cost by using Seagate Exos E JBOD enclosures



Exos E 2U12

- Up to 216 TB
- 12 x 18 TB 3.5" SAS HDD



SEAGATE

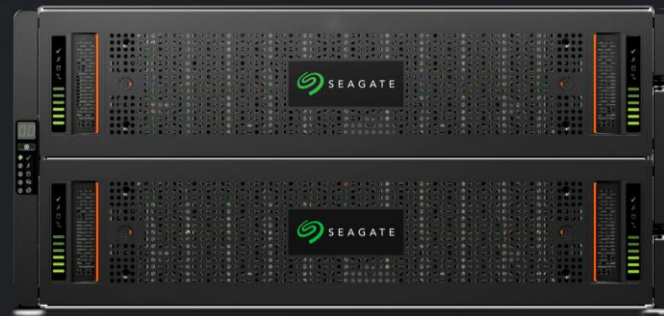

Exos E 5U84

- Up to 1.5 PB
- 84 x 18 TB 3.5" SAS HDD

Note: New JBOD models and the maximum connected numbers will be tested and added throughout 2022 H2. Refer to the latest compatibility table before purchase. <https://www.qnap.com/en/compatibility-expansion>



TS-h1090FU

Live Demo

TS-h1090FU with powerful data reduction technologies to extend SSD endurance

Only available when during inline data process before writing

ZFS file system with inline deduplications and compression feature

It's the best choice to pair with the all-flash and SSD storage because it reduces the data size and pattern that need to be written to the SSD directly.

Storage Settings:

Capacity: Compression Deduplication *i*

Performance: SSD Cache Fast Clone *i* Synchronous I/O *i*

Reduces the amount of storage space needed by eliminating duplicate copies of repeated data. Please note that the system required at least 16 GB of RAM to enable data deduplication and this function will obviously reduce storage performance.

Usage Summary:

Total Folders	Total Files	Original Used	After Compression
1	124	80.00 GB	50.00 GB

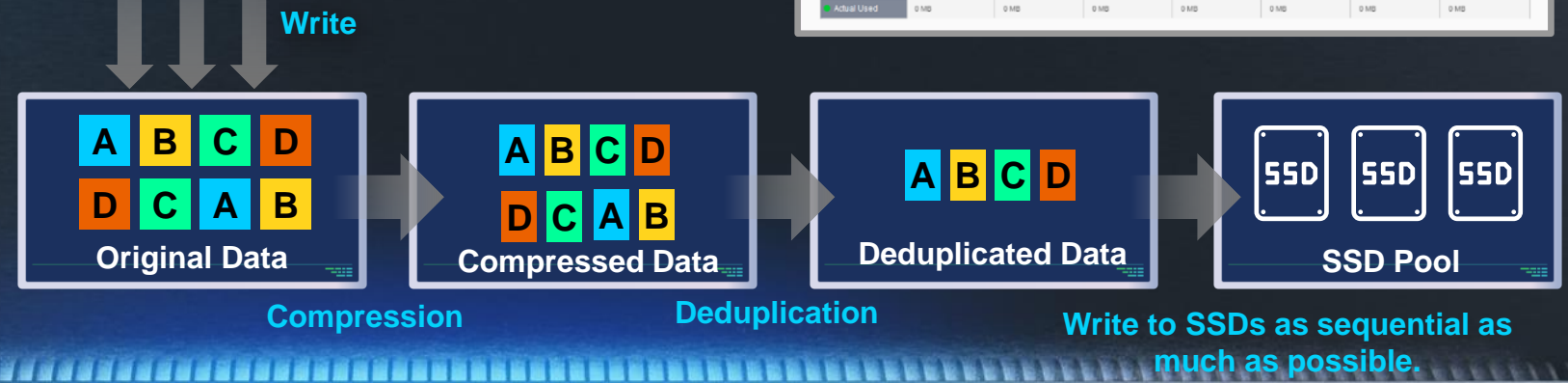
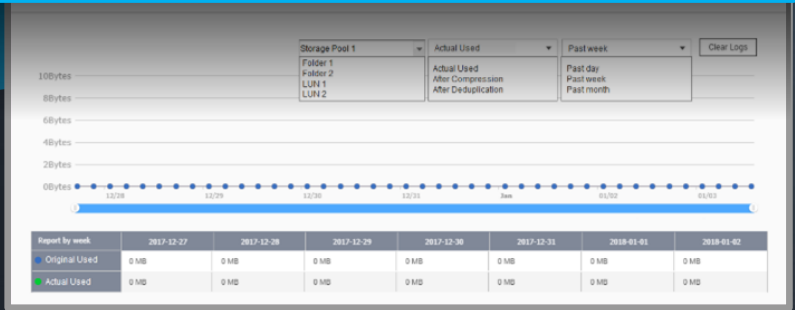
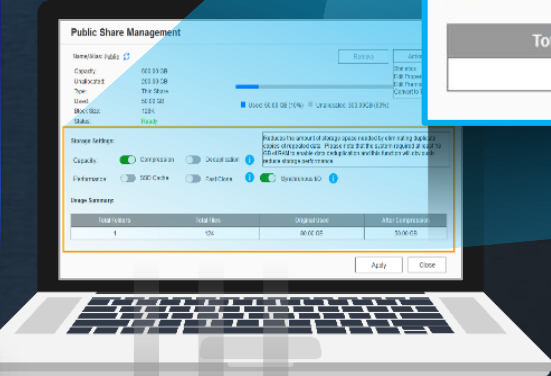

Patented QSAL technology: preventing multiple SSD malfunctioning at the same time

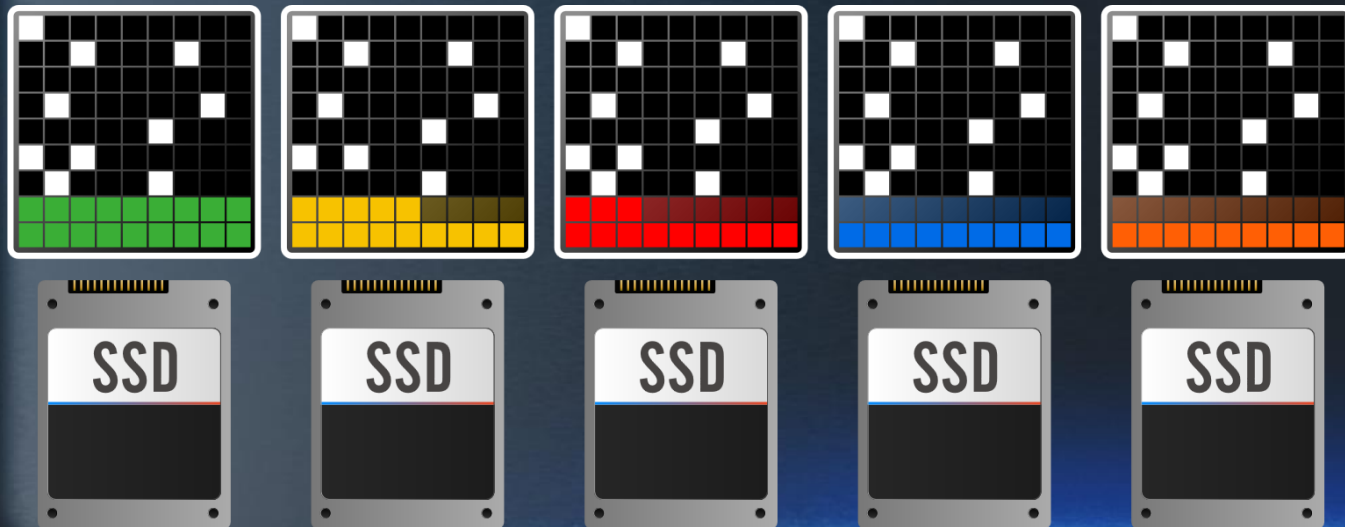
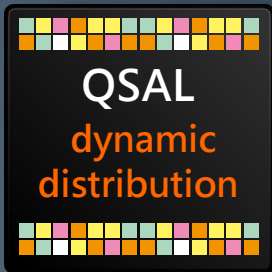

Corresponding to SSD RAID 5 / 6 / 50 / 60 / TP(Triple Parity) will be enabled by default automatically.

SSD 0 SSD 1 SSD 2 SSD 3 SSD 4 SSD 5 SSD 6

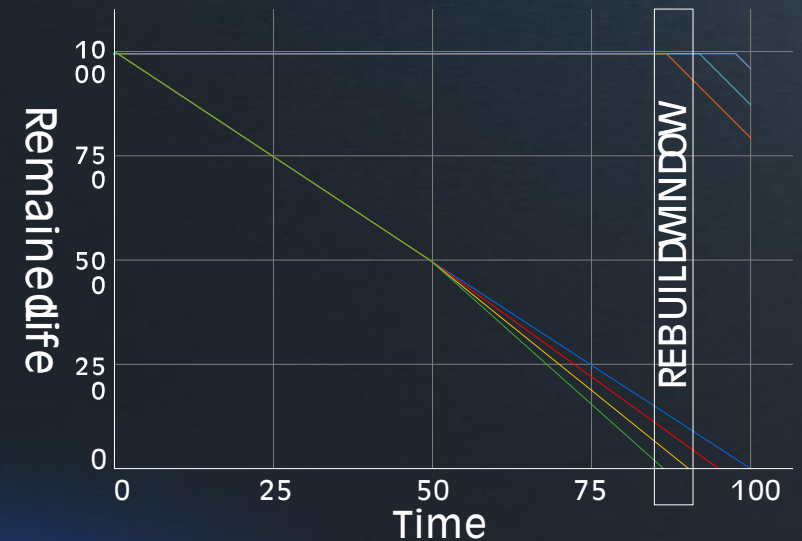

Kernel 5.10 LTS

The QuTS hero operating system is based on the ZFS file system. It can provide the data integrity, safety, and efficiency required for all flash storage.

User friendly interface

QuTS hero combines the app-based QTS with a 128-bit ZFS file system to provide flexible storage management, comprehensive data protection and optimized performance to meet the needs of business-critical applications.

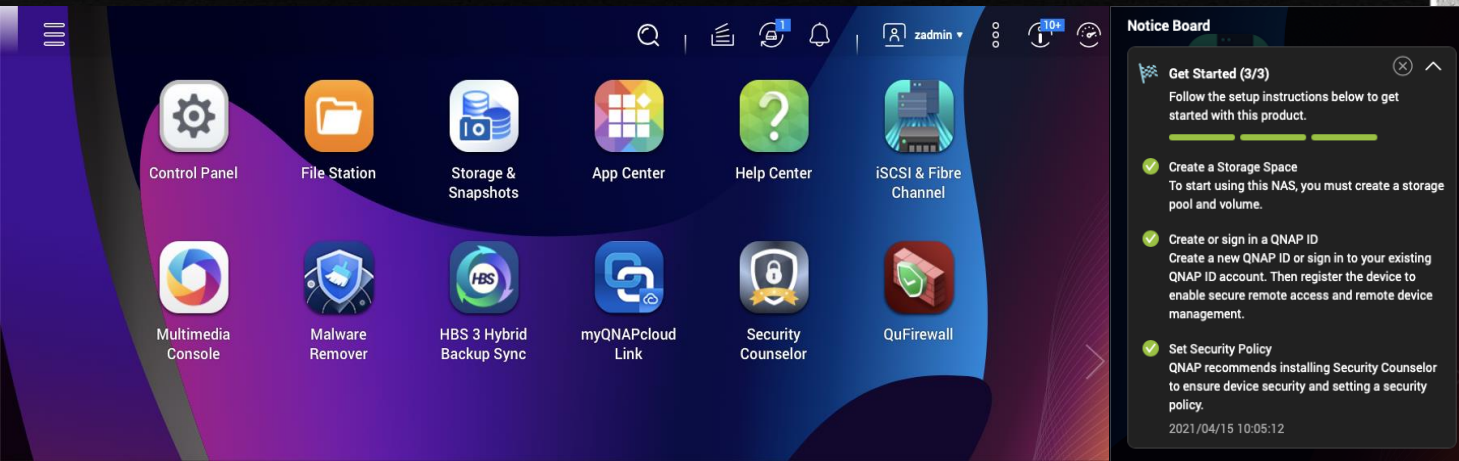

Prevent silent data corruption & self-healing

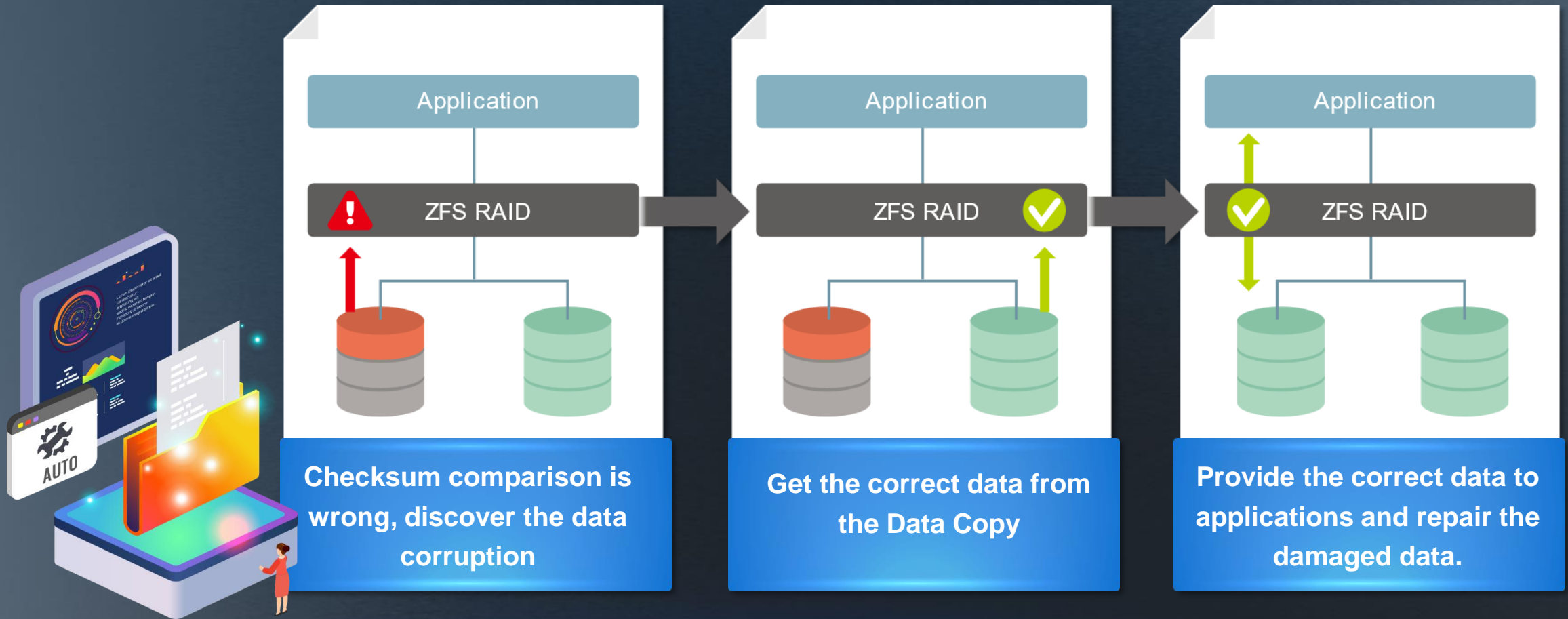

Avoid silent data corruption that occurred on the running system.

Protect data and service security

- Complete folder permissions, Azure Active Directory Domain Services (Azure AD DS), Windows AD, LDAP, and Windows ACL
- **QuFirewall**: allow/deny IP addresses and regions to prevent unauthorized access and brute force attacks for safeguarding data and service security
- **Security Counselor**: A security portal to check for weaknesses and receive recommendations for enhancing the security of your NAS. It also integrates anti-virus and anti-malware scanning software.
- **Malware Remover**: Regularly scan your QNAP NAS using the latest malware definitions. If infected files are detected, they will be immediately removed to ensure NAS data security.
- Firmware and app auto update

Convenient file search with Windows® Search Protocol (WSP) support for NAS shared folders

Windows® 10/ Windows Server® 2016 (or later) users can easily search NAS shared folders via Windows® when an SMB drive is mounted to the NAS. Advanced file search by time, file type, or size is supported for greater convenience.

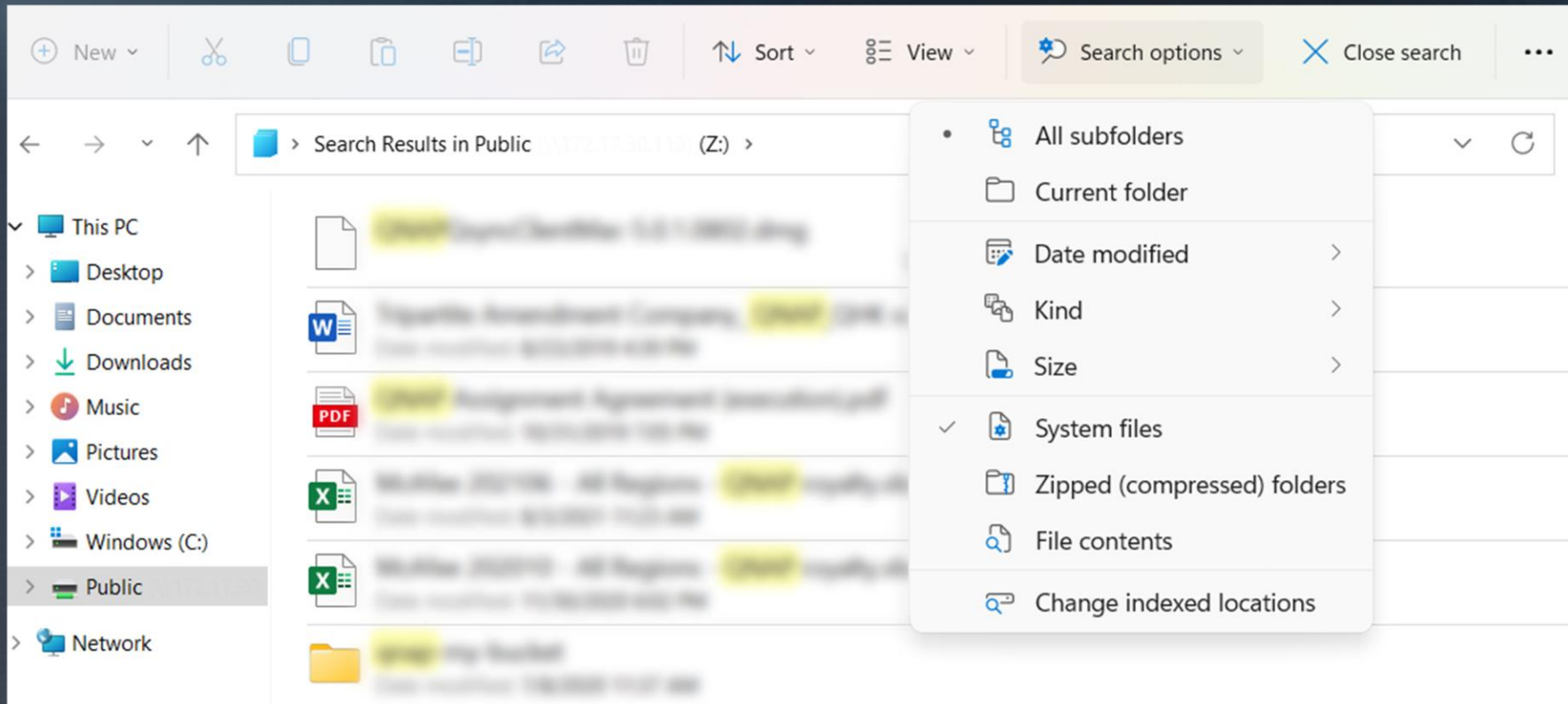

For an optimized full-text search experience, we recommend [Qsirch PC Edition!](#)

**Qsirch
PC Edition**

The most powerful search engine that integrate with NAS and PC local search.



The NAS provides a productive office file management flow with useful apps

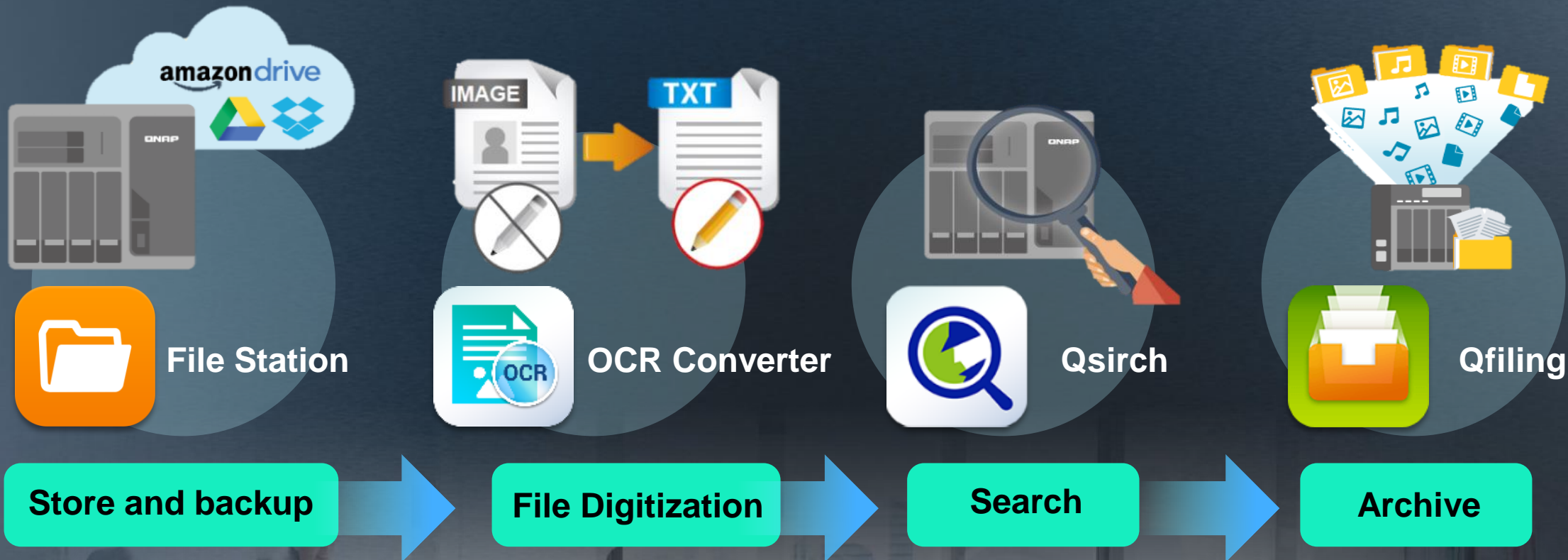

Accelerate large file sharing with free built-in exFAT file system support for external devices

exFAT is natively supported free of charge on TS-h1090FU. exFAT is a file system optimized for flash storage (such as SD cards and USB devices) and helps accelerate large media file transfer.



File System	exFAT	NTFS	FAT32
Maximum File Size	16EB	16TB	4GB
Typical Usage	Next-generation USB drives and SD cards (such as SDXC) that require higher capacities and faster speeds	The file system used by Windows	The standard file system used by normal USB drives

License-free backup solutions to provide the most complete data backup protection



RPO : daily / scheduled



HBS 3 (Hybrid Backup Sync 3):

File level, multi-version management: RTRR, Rsync, FTP, WebDAV, and CIFS/SMB protocols.



RPO : hourly / daily / yearly



Snapshot & Replica:

File level, multi-version management.
Lightweight snapshot w/o performance impact.



RPO : real-time



SnapSync:

Block level, Mirror the data copy and always kept up to date.

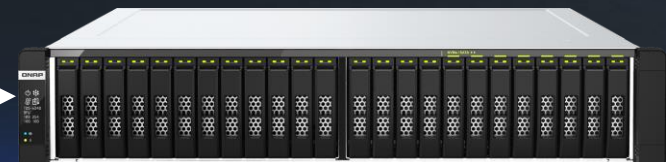

Easy to use HBS 3.0 app fulfilling backup 3-2-1 practice with deduplication



HBS 3 (Hybrid Backup Sync 3)



Local NAS access
(via HBS 3)

Remote NAS access
(via File Station)

Portable use
(QuDedup Extract Tool)

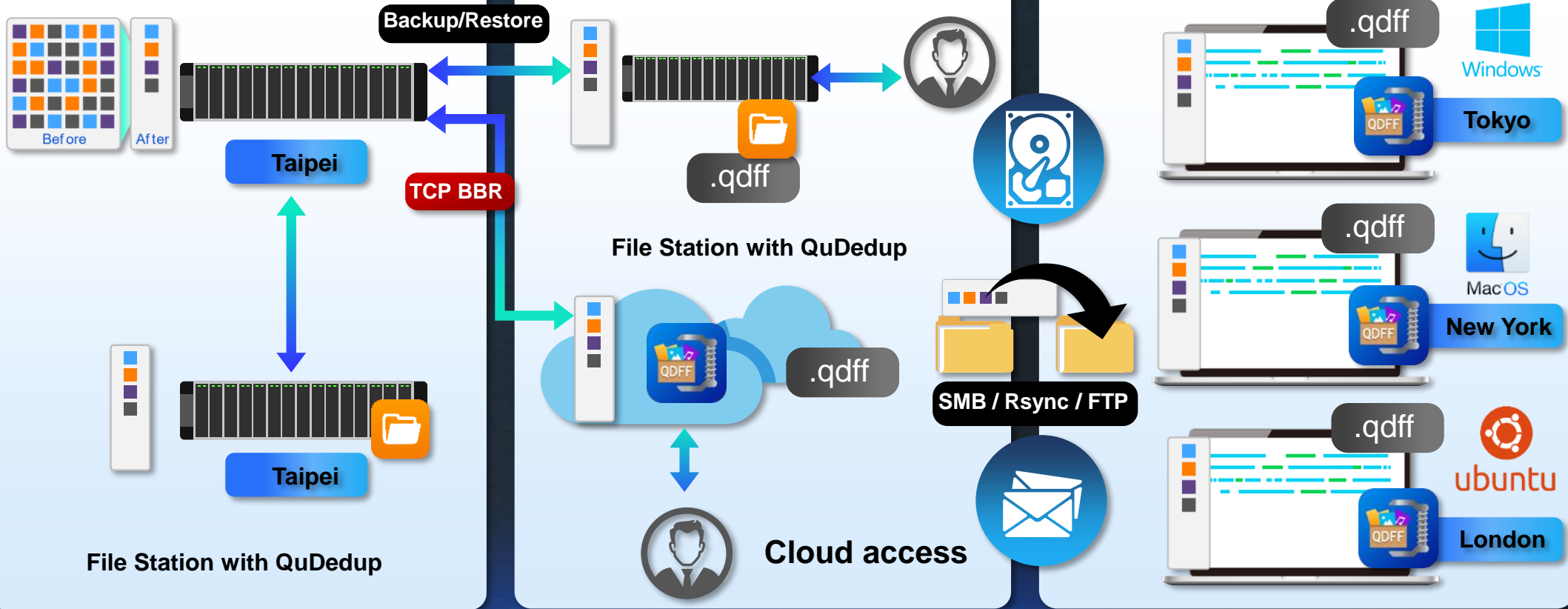

Real-time SnapSync ensures minimal RPO with real-time disaster recovery

Back up data from the local NAS to another QNAP NAS using block-level replication in real time.

Schedule SnapSync: 5min~60min

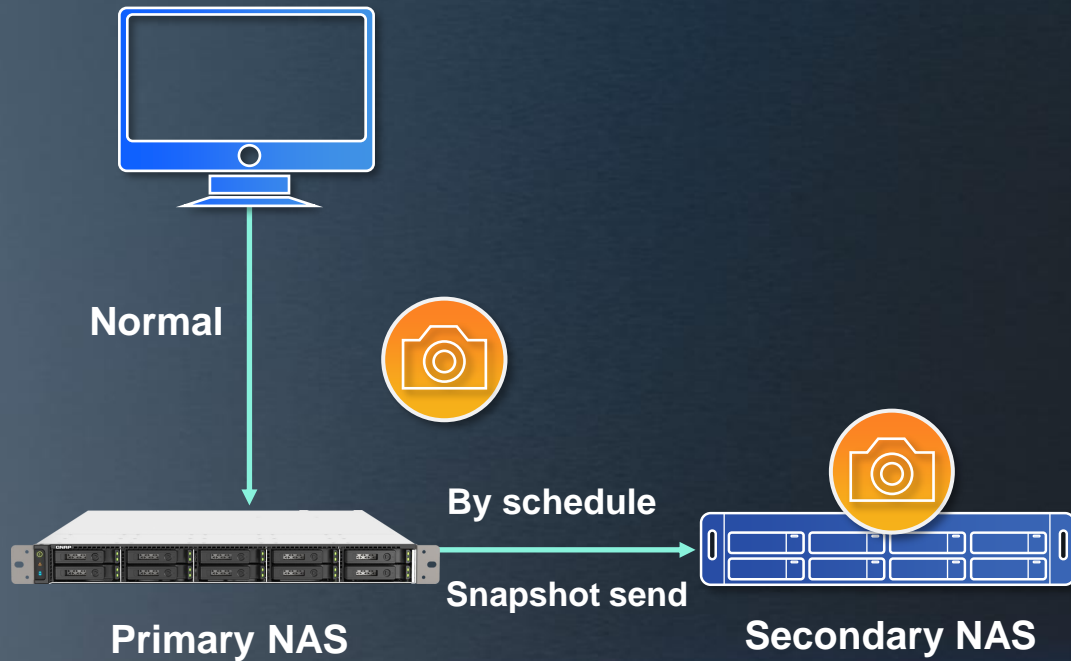

Realtime SnapSync: RPO=0

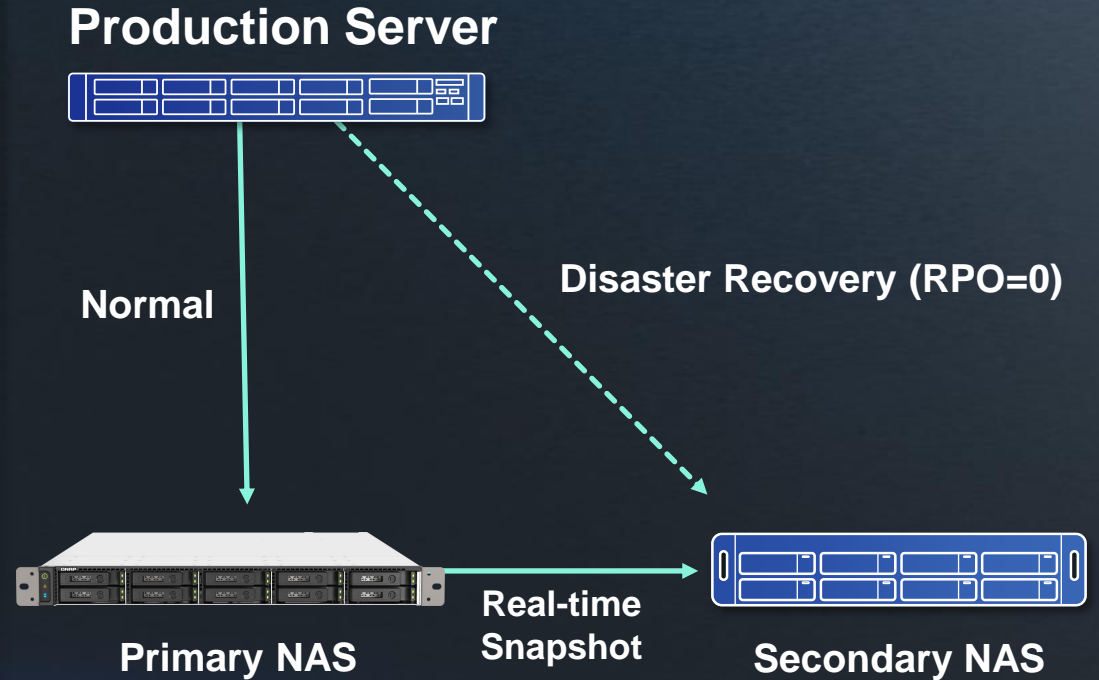

Direct connected via 25GbE
(Round Trip Latency < 5ms)

SnapSync + Instant Clone

Economical & efficient CDM (Copy Data Management) solution

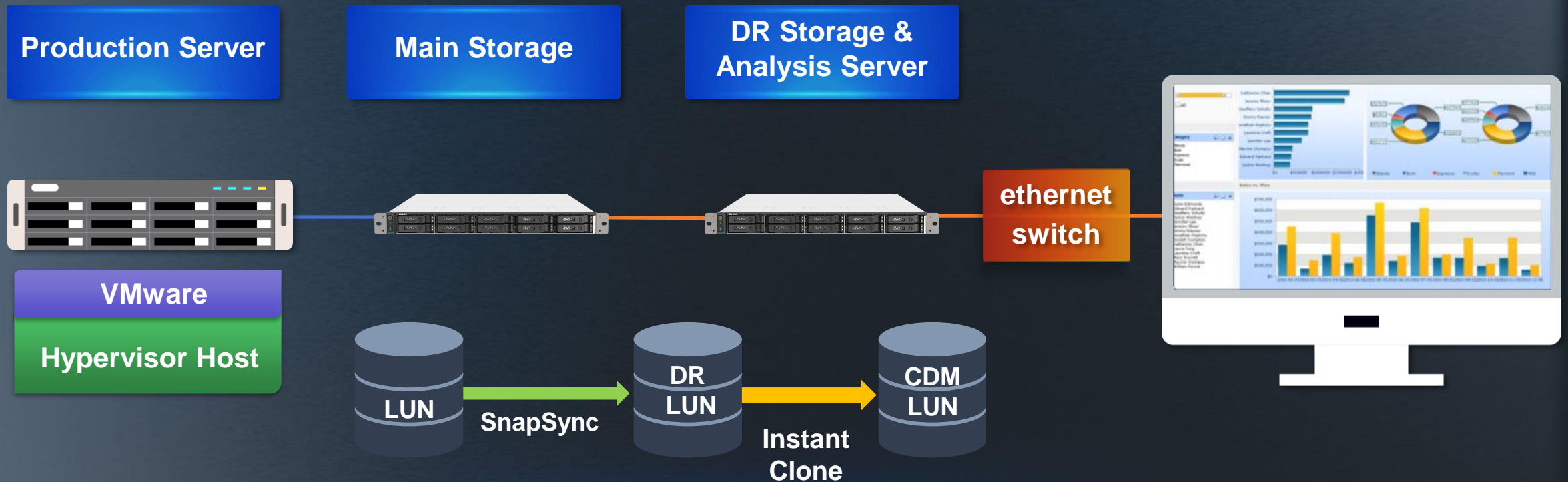

Easily set up a secure FTP server for file sharing and exchange with QNAP QuFTP

QuFTP Service consolidates all FTP related activities into a single App. With its user-friendly interface and detailed permissions settings, QuFTP Service leverages FTP's efficiency with high security and easy management.

- Folder-level permissions
- QoS (Quality of Service) settings
- Instant event notifications
- Access time restrictions
- Limit access to only the FTP root folder
- Watermark for images & videos
- Detailed logs
- Remotely connect to other NAS

QuFTP Service

Overview

Server Name: TS-653D

Status: Enabled

Monitor

Speed (KB/s)

Online Sessions (Sessions)

U/D Speeds: 0/0 (KB/s) — Upload — Download

Online Sessions

User	Login Time	Source IP	Upload Spe...	Download Spe...	Applied Rules
zadmin	2021/04/09 16:51:43	172.17.30.37	0 (KB/s)	0 (KB/s)	--
zadmin	2021/04/09 16:51:43	172.17.30.37	0 (KB/s)	0 (KB/s)	--
zadmin	2021/04/09 16:51:49	172.17.30.37	0 (KB/s)	0 (KB/s)	--

QVPN Service enables secure virtual private network (VPN) connections between QNAP devices & users

QVPN Service integrates both VPN server and client capabilities – providing the ability to create a VPN client that connects to a remote server or third-party provider to access contents or services. It also allows using QNAP devices as VPN servers with WireGuard®, PPTP, OpenVPN, L2TP/IPSec, and QNAP's proprietary QBelt VPN protocols.



WAN

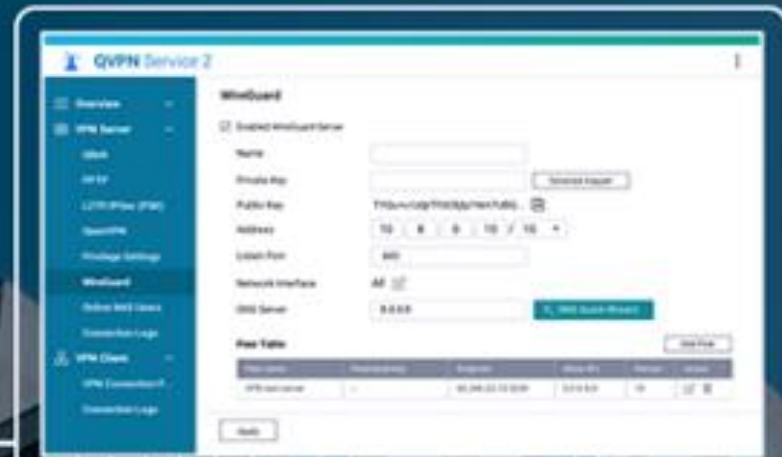

LAN

VPN

VPN



QuWAN is SD-WAN Solution for Resilient IT Infrastructure

QNAP's QuWAN SD-WAN solution features Auto Mesh VPN, IPsec encryption, cloud-centric management and QVPN Service for multi-site network. Compatible with a wide range of QNAP products and Hypervisor Platforms such as VMware ESXi, QuWAN enables SMBs to efficiently build a dependable network at a cost-effective price, and to facilitate digital transformation, multi-site expansion and remote working.



**Automated
VPN
Deployment**

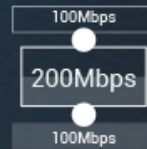

**Smart
Bandwidth
Prioritization**



**Centralized
Cloud
Management**



**Secure
Network
Protection**

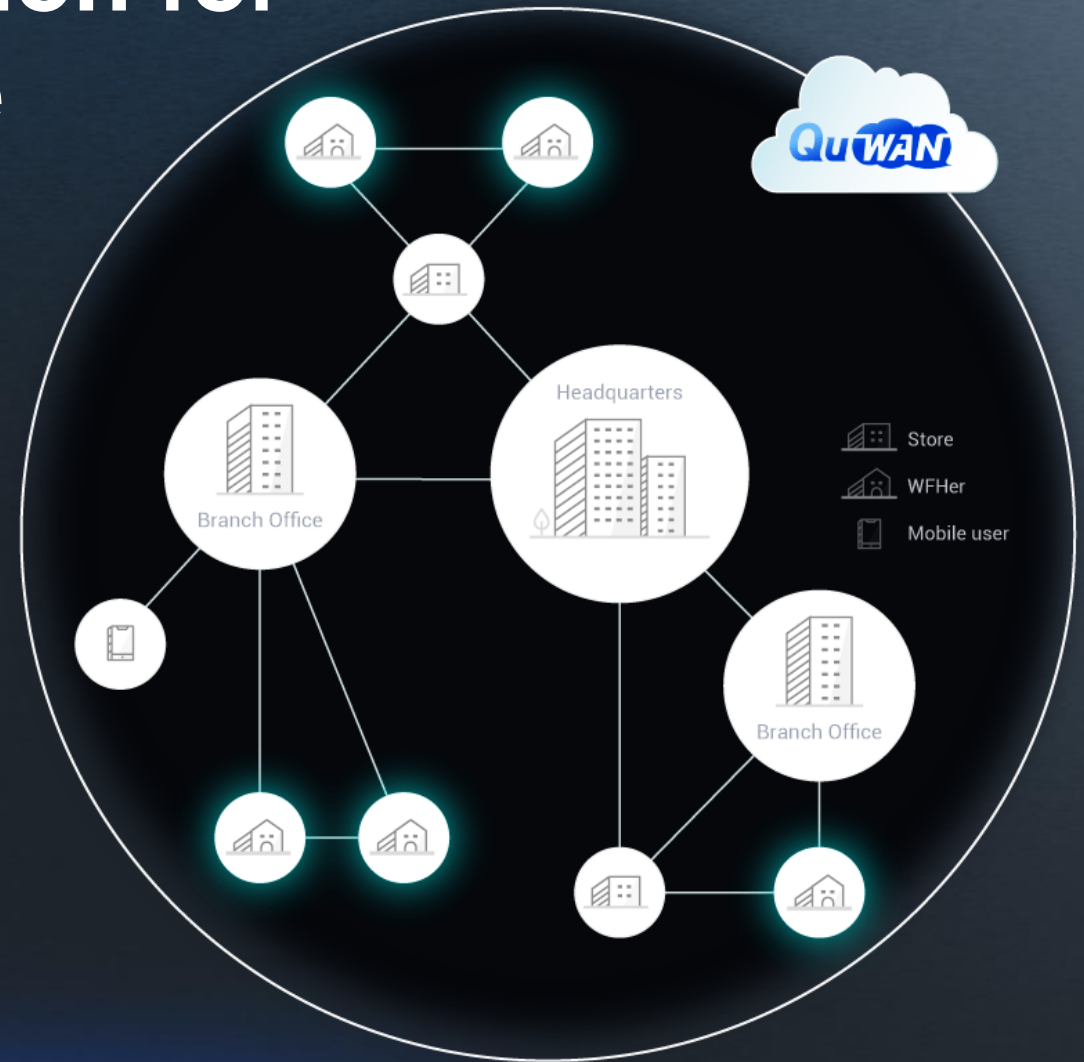

Hyper Data Protector is a license-free VMware® and Hyper-V backup appliance. Unlimited.

COMING SOON

With only one QNAP NAS required and with no license fees to pay, you can backup unlimited VMware® and Hyper-V environments. Hyper Data Protector provides you with a cost-effective and reliable disaster recovery plan, ensuring 24/7 operation of your services.

Windows10 / Server2016/ Server 2019

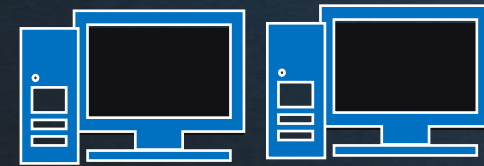

QuObjects for object storage development & testing, and backing up cold data from the cloud

Designed for object service developers, QuObjects allows for creating high-performance S3 compatible development environments on a QNAP NAS. It's also ideal on-premises storage for backing up cold data from the cloud to reduce cloud storage costs.



S3 Compatible

<https://calvin1.s3.ap-east-1.amazonaws.com/test1/292557.jpg>

bucket

Cloud service provider

Folder

File name

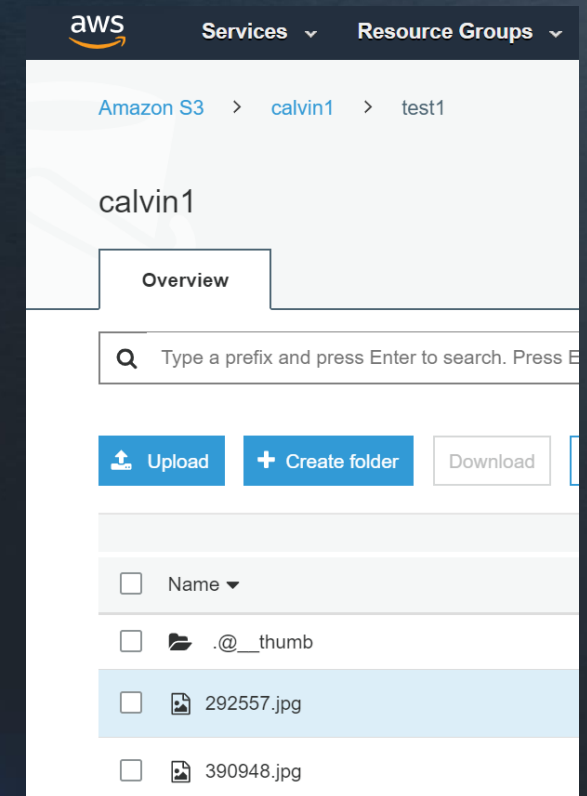
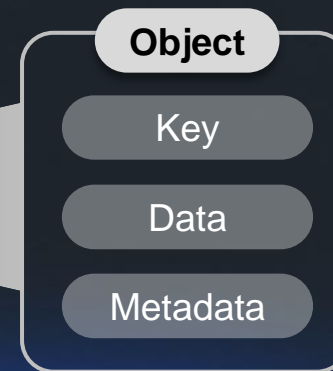
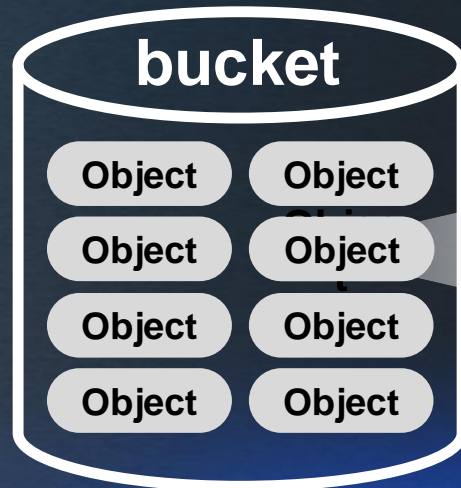

Back up business data to the cloud. Flexible, economical, and safe with VJBOD Cloud

Connect your QNAP NAS with cloud object storage and back up business data to the cloud with reduced bandwidth usage, backup time, and optimized storage usage.

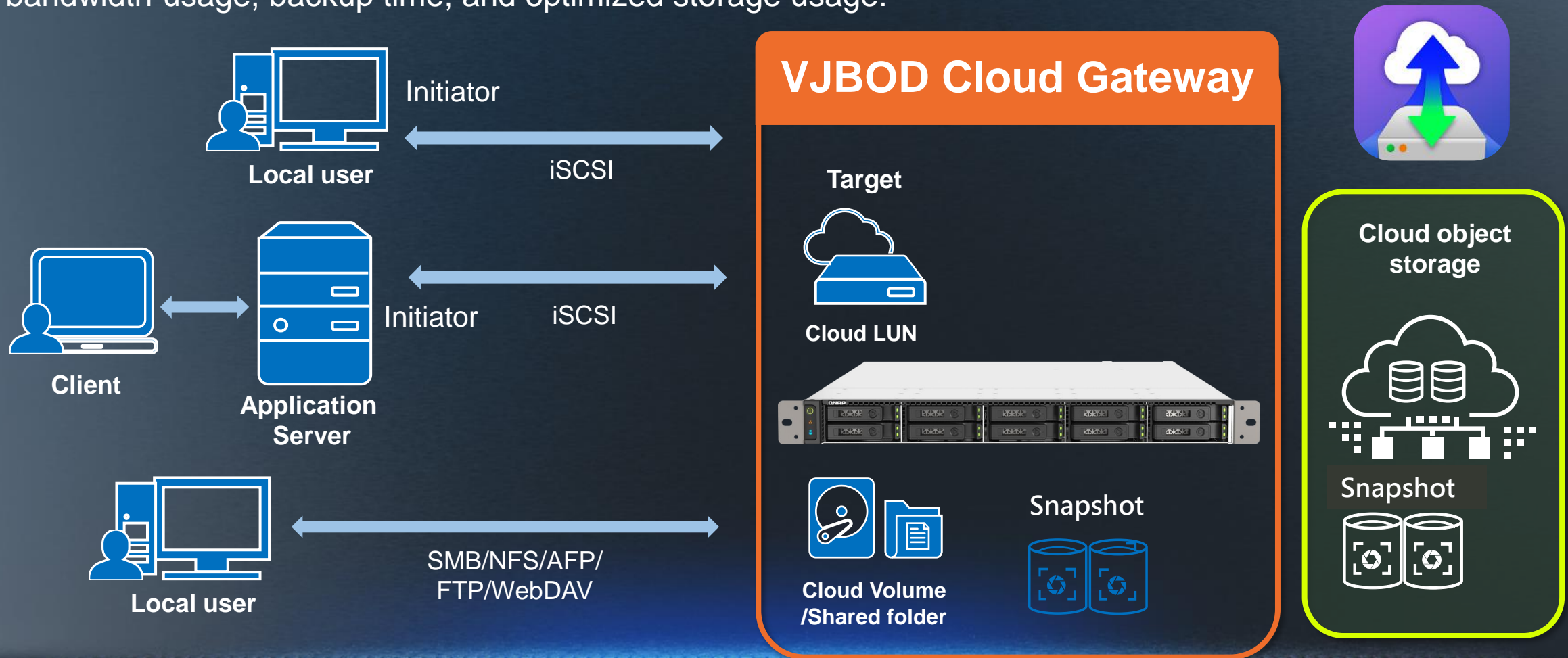

Google™ Workspace and Microsoft 365® total backup solution with Boxafe



With Boxafe, you do not need to worry about data loss. You can backup files, emails, calendars and contacts from Google™ Workspace and Microsoft 365® into the QNAP NAS.

Google™ Workspace



Gmail

Backup all your emails and attachments in Gmail



Google Drive

Backup all your file versions in Google Drive and supports My Drive and Shared Drive



Contacts

Backup all your contacts in Google Contacts



Calendar

Backup all your events and attachments in Google Calendar

Microsoft 365®



Outlook

Backup all your emails and attachments in Outlook



Contacts (People)

Backup all your contacts in Outlook People



Calendar

Backup all your events and attachments in Outlook Calendar



SharePoint & OneDrive

Backup your SharePoint and OneDrive files including OneNote.

All-in-one solution for hosting virtual machines and containerized apps



Virtualization Station

Virtualization Station allows you to create virtual machines (VM) on Turbo NAS, supporting Windows、Linux[®]、UNIX[®]、Android、QuTScloud operating systems.



Container Station

Experience LXD and Docker[®] lightweight virtualization technologies, download apps from the Docker Hub Registry[®], import/export containers, and create abundant microservices.

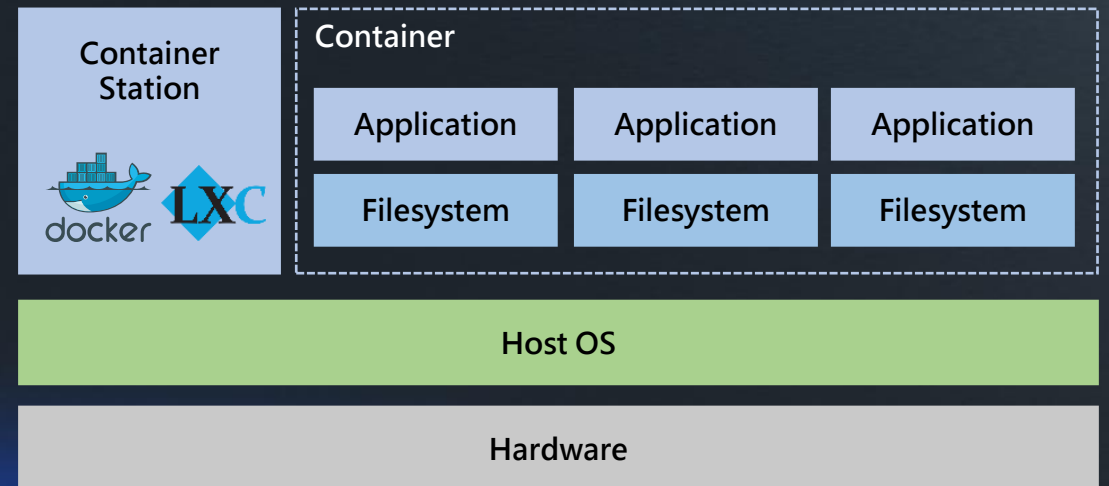

SR-IOV improves the network performance of virtual machines by 20% with HW acceleration

SR-IOV (Single-Root Input/Output Virtualization) let the services on your virtual machine enjoy the physical network speed.

- If you need real-time service needs, such as ticket booking service, cash flow service, audio-visual service, you can directly enjoy the speed of the hardware network card, reducing network delay.
- Reduce the usage of the host's CPU.
- Increase network efficiency by at least 20%

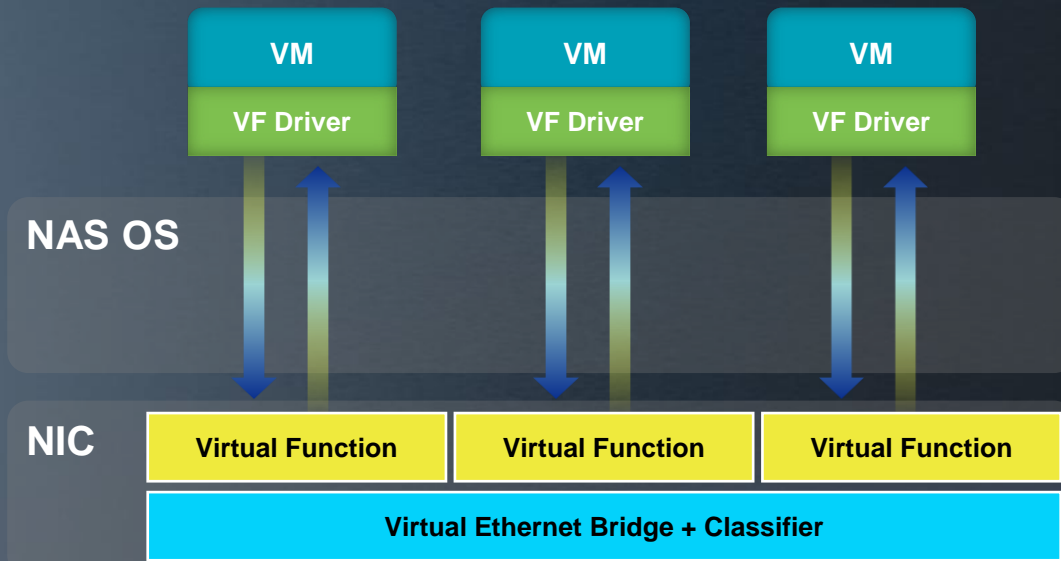

Note: NAS must install SR-IOV supported NICs.

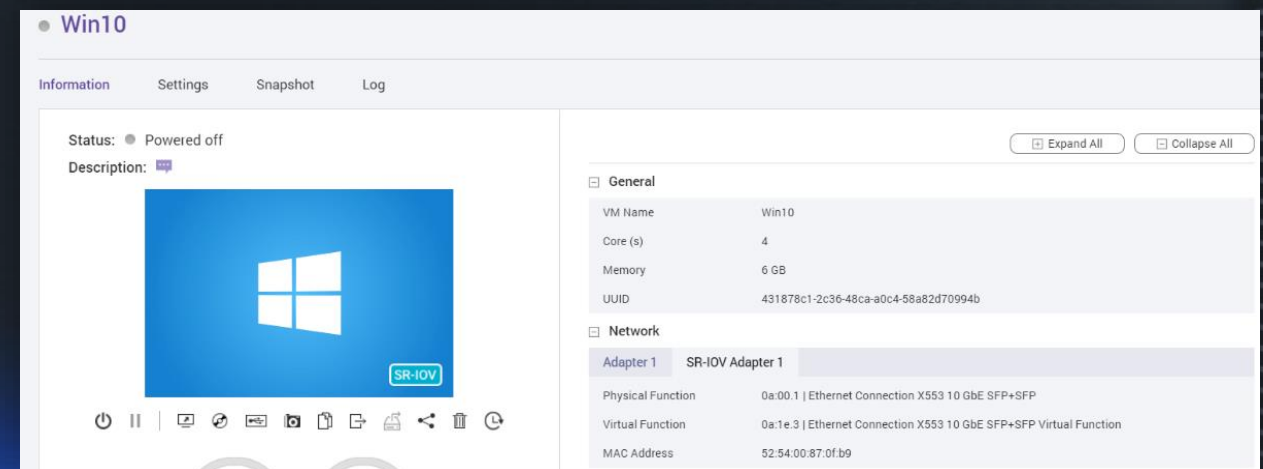
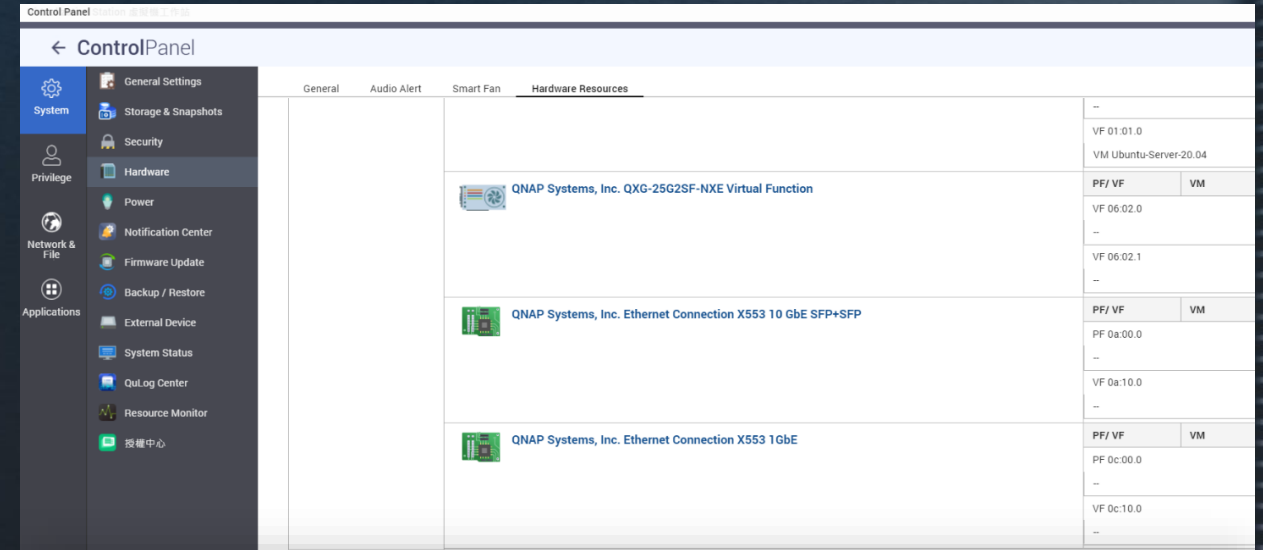

A QuTScLOUD virtual NAS solution suited for Enterprises and Workgroups

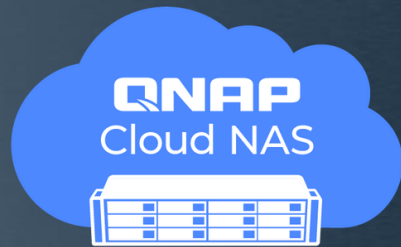

QuTScLOUD is a virtual appliance based on QNAP's QTS Operating system, can be quickly launched on QNAP Virtualization Station.

Organizations can increase their budget flexibility by using existing virtual environments, saving hardware space and additional maintenance efforts, and by leveraging the application advantages of the app-ware QuTScLOUD operating system.

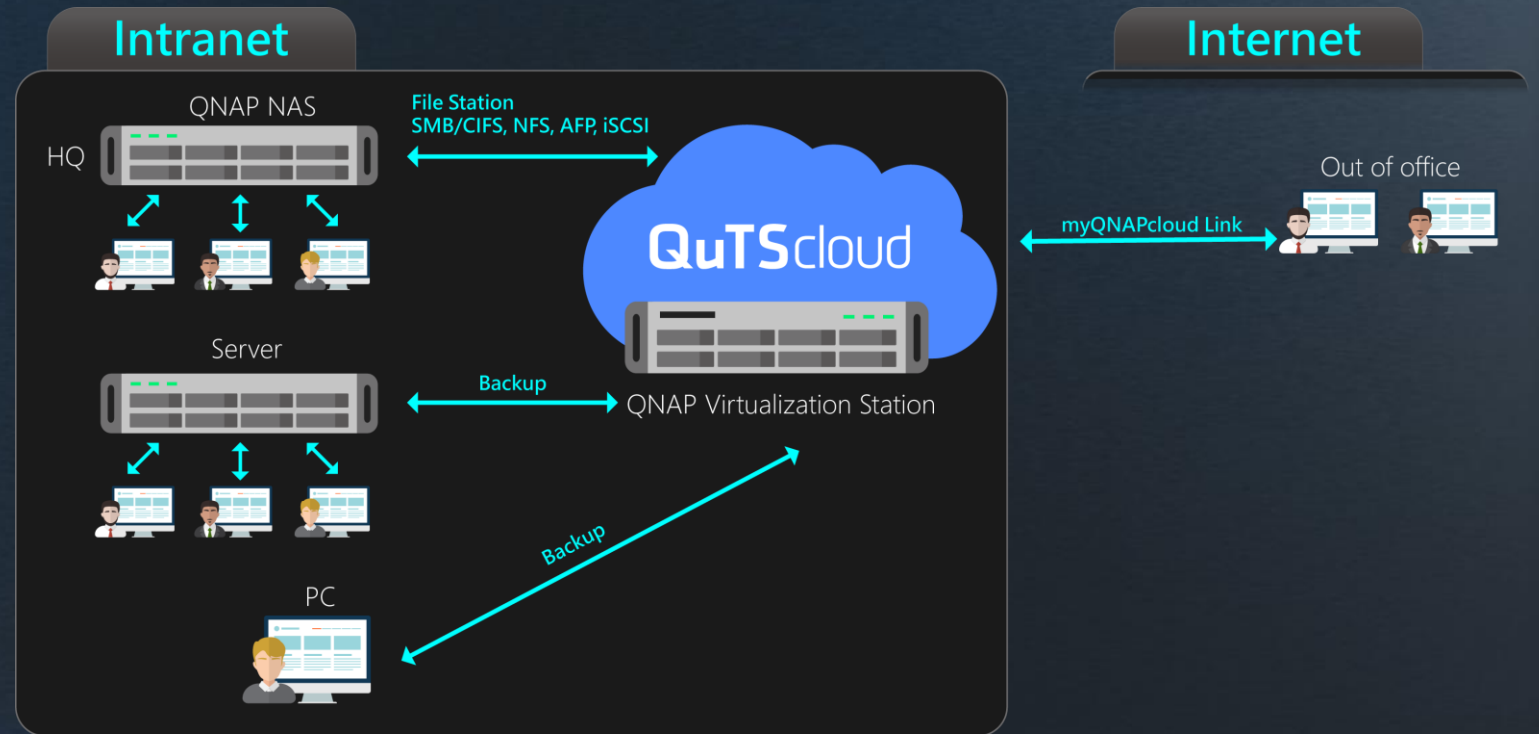

Reliable, high-performance storage for virtualization

The TS-h1090FU supports block-based iSCSI LUN as a reliable, high-performance, and affordable storage solution for mainstream virtualization environments. It supports VMware® VAAI and Microsoft® ODX to increase performance by offloading server loading for ESXi server and Hyper-V respectively as well as Citrix® XenServer™ and Veeam Ready certifications.

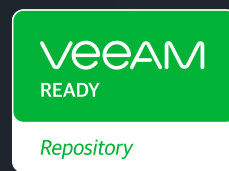

Build a comprehensive surveillance system with a QNAP NAS, QVR Elite, and IP cameras



QNAP QVR Elite is a subscription-based smart surveillance solution, allowing you to easily build a surveillance system with lower TCO (subscriptions starting from only US \$1.99 per month) and higher scalability. It also integrates multiple QNAP AI-based video analytics solutions to build smart facial recognition for retail and door access systems with QNAP NAS.

- Windows/macOS/iOS/Android QVR Pro client

Flexible subscription

An icon showing a hand pointing to a 'Monthly' button, with an 'Annually' button next to it. Above the buttons is a small cube icon.

Monthly Annually

Capacity expansion

An icon showing two blue database cylinders connected by a line, representing storage expansion.

AI enhancements

An icon showing a blue circuit board with the letters 'AI' in the center, representing artificial intelligence.

Standard MP4 format

An icon showing a blue film strip with a camera icon and the text 'MP4' and 'REC' on it, representing video recording format.

A screenshot of the QVR Pro Client Beta software interface. The main window shows a live video feed of a warehouse with high ceilings and metal shelving units. On the left, there is a sidebar with a tree view showing folders like 'QIoT', 'RTMP', and 'test', and a list of cameras including '1. RTMP', '2. Asia_PS343', '3. vivo_fshoye', '4. Share', '5. BB-SC284', '6. Camera', '7. D12CHT', and '8. VVOTEDK_IP8132'. At the bottom, there are 'Live' and 'Playback' buttons. The interface also shows a timeline at the bottom with a playhead.

A screenshot of the QVR Pro Client Beta mobile app interface on an iPhone. The screen shows a live video feed of a modern building interior. Below the video, there are playback controls including play/pause, stop, and a circular navigation pad. There are also buttons for 'AUTO CRUISING' and 'PRESET POINT'.

A screenshot of the QVR Pro Client Beta mobile app interface on an Android phone. The screen shows a live video feed of a dining area with tables and chairs. Below the video, there are playback controls and a list of motion detection events with timestamps and thumbnails. A red speech bubble icon is visible in the top right corner.



<https://coral.ai/products/>



USB



M.2 2280 PCIe*

- Official certification by Google to support Coral M.2 & USB TPU devices
- Up to 4 TPU devices per NAS

With Coral
intelligence

Google

QVR Face Insight

Local Smart Facial Recognition

A facial recognition solution for small offices and residential communities that enables instant and accurate facial recognition with live AI-powered video analytics that is even capable of recognizing masked people.

- Real-Time Facial Recognition and Analytics
- Mask detection and facial recognition in one solution
- Build A Smart Facial Recognition System with One NAS
- Identity Authentication Made Easy with Profile Database
- Enhance your face recognition speed with an Edge TPU
- Empowered surveillance feeds with QVR Pro integration

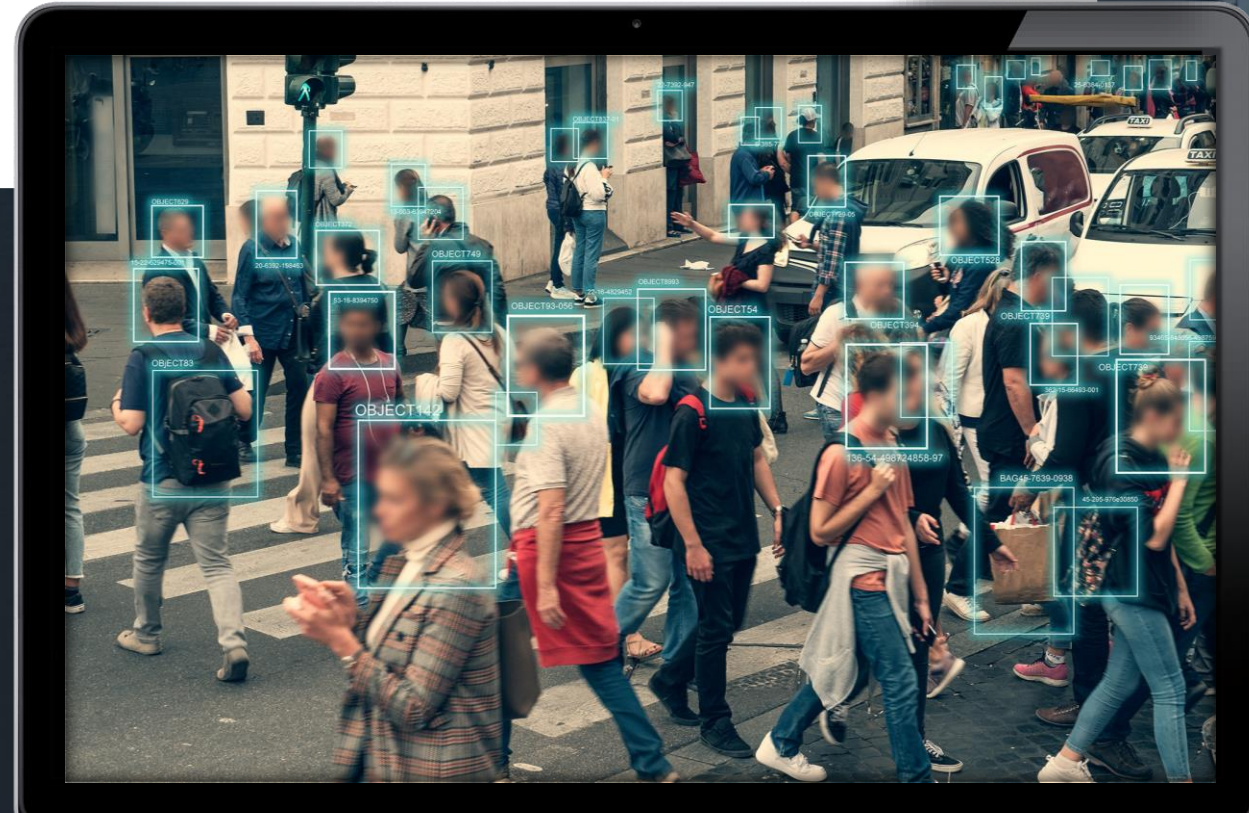

*Install M.2 2280 PCIe TPU via the optional QNAP QDA-UMP adapter.

Switch NAS operating systems between QuTS hero and QTS for higher everyday performance

The TS-h1090FU also supports QTS - QNAP's standard NAS operating system – that provides greater everyday performance, efficient memory utilization, and the advantage of Qtier auto-tiering. You can also migrate drives from your current QTS-based NAS to the TS-h1090FU.

Note:

QTS and QuTS hero use different file systems. You must remove all the drives from the TS-h1090FU before switching from QuTS hero to QTS.

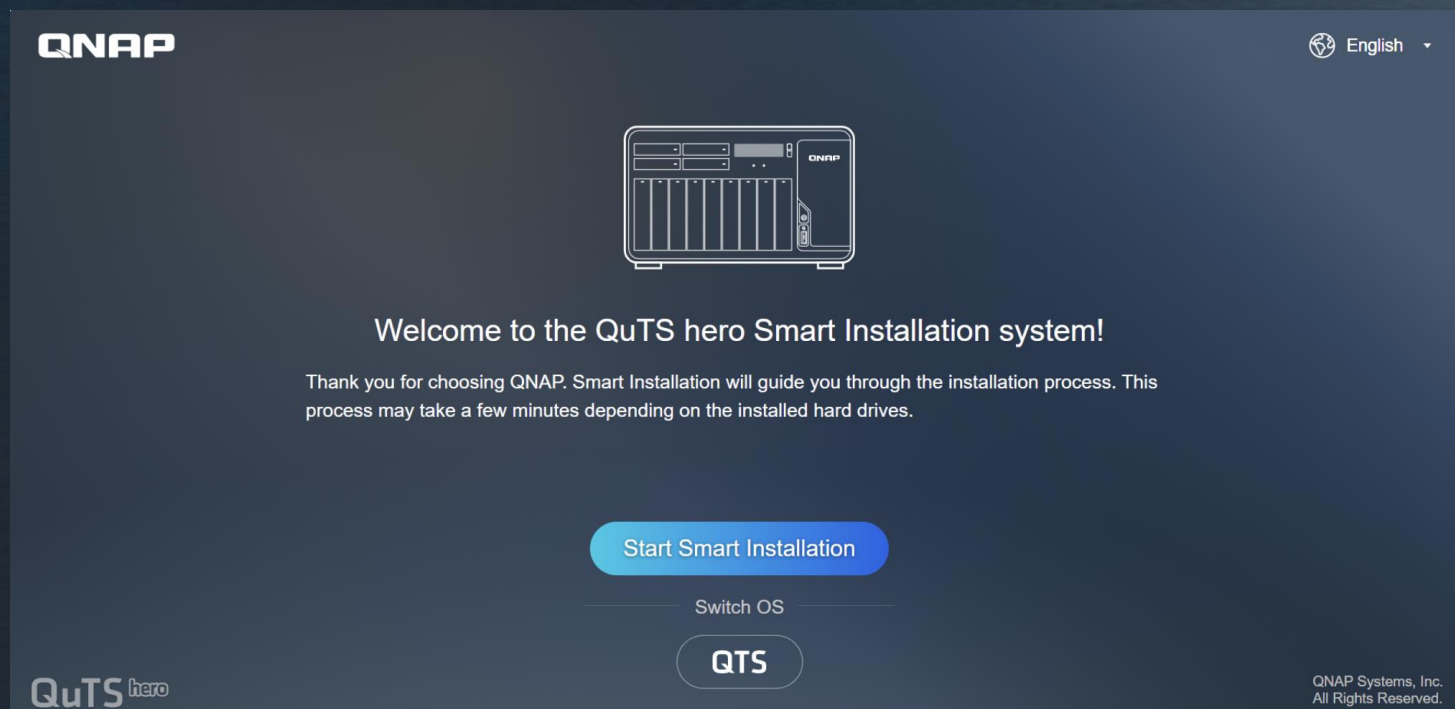

The screenshot shows the QuTS hero Smart Installation system interface. At the top left is the QNAP logo, and at the top right is a language selection menu set to "English". In the center, there is a line-art illustration of a NAS device. Below the illustration, the text reads: "Welcome to the QuTS hero Smart Installation system!" followed by "Thank you for choosing QNAP. Smart Installation will guide you through the installation process. This process may take a few minutes depending on the installed hard drives." A prominent blue button labeled "Start Smart Installation" is centered below the text. Underneath this button, the text "Switch OS" is displayed above a button labeled "QTS". In the bottom left corner, the "QuTS hero" logo is visible, and in the bottom right corner, the text "QNAP Systems, Inc. All Rights Reserved." is present.

Ordering information & the rail kit

SKUs:

- **TS-h1090FU-7232P-64G**
AMD EPYC 7232P 8C 16T up to 3.2 GHz, 8 x 8GB RDIMM ECC, 25GbE
- **TS-h1090FU-7302P-128G**
AMD EPYC 7302P 16C 32T up to 3.3 GHz, 8 x 16GB RDIMM ECC, 25GbE
- **TS-h1090FU-7302P-256G** (by request)
AMD EPYC 7302P 16C 32T up to 3.3 GHz, 8 x 32GB RDIMM ECC, 25GbE)

Optional rail kit:

RAIL-B02



5-year warranty as standard

The TS-h1090FU is backed by a 5-year warranty at no extra cost. This premier warranty demonstrates QNAP's dedication to your essential business needs for continuous operations and non-interrupted services.



The QNAP logo is located in the top left corner of the image. It consists of the letters 'QNAP' in a bold, white, sans-serif font. The background of the entire image is a server rack with a QNAP TS-h1090FU NAS unit pulled out, showing its front panel with various ports and a drive tray containing an NVMe SSD. The server rack is filled with other units, some of which have green status lights illuminated.

QNAP

TS-h1090FU

1U 10-bay lighting fast
NVMe/SATA SSD NAS
with 25GbE & PCIe Gen4

Copyright© 2022 QNAP Systems, Inc. All rights reserved. QNAP® and other names of QNAP Products are proprietary marks or registered trademarks of QNAP Systems, Inc. Other products and company names mentioned herein are trademarks of their respective holders.