



# User's Guide

**PJ-822**

**PJ-823**

**PJ-862**

**PJ-863**

**PJ-883**

## Table of Contents

<b>Before You Use Your Printer</b> .....	<b>1</b>
Definitions of Notes .....	2
Safety Precautions .....	3
General Precautions .....	4
Trademarks and Licenses .....	5
Open Source Licensing Remarks .....	6
Important Note .....	7
<b>Set Up Your Printer</b> .....	<b>8</b>
Parts Description .....	9
Control Panel Overview .....	11
LED Patterns and Indications .....	16
Install the Rechargeable Li-ion Battery .....	20
Remove the Rechargeable Li-ion Battery .....	22
Connect the Printer to External Power .....	23
Turn the Printer On or Off .....	25
Charge the Rechargeable Li-ion Battery .....	26
Load Paper in the Printer .....	28
<b>Install Software</b> .....	<b>30</b>
Install Printer Drivers and Software on a Computer .....	31
Available Applications .....	32
Connect the Printer to a Computer or Mobile Device .....	34
Connect the Printer to a Computer Using a USB Cable .....	35
Connect the Printer to a Computer Using Wi-Fi .....	36
Connect the Printer to a Computer Using Bluetooth Connection .....	43
Connect the Printer to a Mobile Device Using NFC (Android) .....	44
<b>Create and Print Documents Using Your Computer</b> .....	<b>45</b>
Create Labels Using P-touch Editor (Windows) .....	46
Main Window of P-touch Editor Express Mode (Windows) .....	47
Main Window of P-touch Editor Professional Mode (Windows) .....	48
Main Window of P-touch Editor Snap Mode (Windows) .....	49
Print Documents Using P-touch Editor (Windows) .....	50
Create and Print Custom Documents Using P-touch Editor (Mac) .....	51
Print Documents without Installing Software and Drivers .....	52
Print Using the USB Interface (Mass Storage Mode) .....	53
Notes on Printing Image Data without Using the Printer Driver .....	54
Print a Document Using the Printer Driver (Windows/Mac) .....	55
Print Settings (Windows) .....	57
Print Settings (Mac) .....	61
<b>Print Documents Using Mobile Devices</b> .....	<b>63</b>
Compatible Printing Apps .....	64
AirPrint Overview .....	66
Mopria® Print Service .....	67
Transfer Templates Created on a Computer to the Printer Using a Mobile Device .....	68
<b>Transfer Templates to the Printer (P-touch Transfer Manager) (Windows)</b> .....	<b>69</b>

Transfer Templates to the Printer Using P-touch Transfer Manager (Windows).....	70
Notes on Using P-touch Transfer Manager (Windows).....	71
About Transferring Templates from the Computer to the Printer (Windows).....	72
Back up Templates or Other Data Saved in the Printer (Windows).....	80
Delete Printer Data (Windows).....	81
Create Transfer Files and Transfer Package Files (Windows).....	82
Distribute Templates to be Transferred to Users Without Using P-touch Transfer Manager (Windows) .....	84
<b>Store and Manage Templates (P-touch Library).....</b>	<b>88</b>
Edit Templates Using P-touch Library (Windows).....	89
Print Templates Using P-touch Library (Windows).....	90
Search Templates Using P-touch Library (Windows).....	91
<b>Network.....</b>	<b>93</b>
Important Information for Security.....	94
Wireless Network Settings .....	95
Use the Wireless Network .....	96
Enable or Disable Wi-Fi.....	98
Brother Management Tools.....	99
<b>Security.....</b>	<b>100</b>
Before Using Network Security Features.....	101
Configure Certificates for Device Security .....	102
Supported Security Certificate Features .....	103
How to Create and Install a Certificate .....	104
Create a Self-signed Certificate .....	105
Create a Certificate Signing Request (CSR) and Install a Certificate from a Certificate Authority (CA).....	106
Import and Export the Certificate and Private Key .....	110
Import and Export a CA Certificate.....	113
Manage Multiple Certificates .....	116
Use SSL/TLS .....	117
Introduction to SSL/TLS .....	118
Manage Your Network Printer Securely Using SSL/TLS.....	121
Print Documents Securely Using SSL/TLS .....	126
Use SNMPv3.....	128
Manage Your Network Printer Securely Using SNMPv3.....	129
Use IEEE 802.1x Authentication for a Wireless Network.....	130
What Is IEEE 802.1x Authentication? .....	131
Configure IEEE 802.1x Authentication for a Wireless Network Using Web Based Management (Web Browser).....	132
IEEE 802.1x Authentication Methods.....	134
<b>Update.....</b>	<b>135</b>
Update P-touch Editor.....	136
Update the Firmware.....	138
<b>Printer Settings .....</b>	<b>140</b>
Change Printer Settings Using the Printer Setting Tool (Windows) .....	141
Communication Settings of the Printer Setting Tool (Windows).....	143
Device Settings of the Printer Setting Tool (Windows).....	149
P-touch Template Settings of the Printer Setting Tool (Windows).....	155





Apply Setting Changes to Multiple Printers (Windows).....	157
Change Printer Settings Using the Printer Setting Tool (Mac) .....	158
Setting Dialog Box of Printer Setting Tool (Mac) .....	159
Apply Setting Changes to Multiple Printers (Mac).....	163
Change Printer Settings Using Web Based Management .....	164
Set or Change a Login Password for Web Based Management .....	165
Confirm Printer Settings .....	166
<b>Routine Maintenance .....</b>	<b>167</b>
Maintenance.....	168
<b>Troubleshooting .....</b>	<b>170</b>
If You Are Having Difficulty with Your Printer .....	171
Printing Problems .....	172
Network Problems .....	178
Version Information .....	181
Reset the Printer .....	182
<b>Appendix .....</b>	<b>183</b>
Specifications .....	184
Software Development Kit.....	187
Product Dimensions .....	188
Brother Help and Customer Support.....	193

## Before You Use Your Printer

- [Definitions of Notes](#)
- [Safety Precautions](#)
- [General Precautions](#)
- [Trademarks and Licenses](#)
- [Open Source Licensing Remarks](#)
- [Important Note](#)

## Definitions of Notes

We use the following symbols and conventions throughout this User's Guide:

 <b>DANGER</b>	DANGER indicates an imminently hazardous situation which, if not avoided, will result in death or serious injuries.
 <b>WARNING</b>	WARNING indicates a potentially hazardous situation which, if not avoided, could result in death or serious injuries.
 <b>CAUTION</b>	CAUTION indicates a potentially hazardous situation which, if not avoided, may result in minor or moderate injuries.
<b>IMPORTANT</b>	IMPORTANT indicates a potentially hazardous situation which, if not avoided, may result in damage to property or loss of product functionality.
<b>NOTE</b>	NOTE specifies the operating environment, conditions for installation, or special conditions of use.
	The tips icon indicates helpful hints and supplementary information.
<b>Bold</b>	Bold style identifies buttons on the printer's control panel or computer screen.
<i>Italics</i>	Italicized style emphasizes an important point or refers you to a related topic.

### Related Information

- [Before You Use Your Printer](#)

## Safety Precautions

### IMPORTANT

- DO NOT remove the labels affixed to the printer. These labels provide operational information and indicate the printer's model number.
- DO NOT push the power button or LED indicator with an object that has a sharp point, such as a pen. This could damage the button or LED.
- DO NOT transport the printer while cables are connected to the AC/DC Connector or USB port. The connector and ports could be damaged.
- DO NOT store the printer in an area exposed to high temperatures, high humidity, direct sunlight, or dust. These could cause discoloration or a malfunction.



### Related Information

- [Before You Use Your Printer](#)
-

## General Precautions

### Rechargeable Li-ion Battery

- At the time of purchase, the Rechargeable Li-ion Battery is slightly charged so that the operation of the printer can be verified; however, before you use the printer for the first time, you must fully charge the Rechargeable Li-ion Battery using the AC Adapter.
- If the printer is not in use for long periods, remove the battery and disconnect the cord before storing.
- If you notice anything unusual about the Rechargeable Li-ion Battery the first time it is used, for example overheating or rust, immediately stop using the Rechargeable Li-ion Battery. Contact Brother Customer Service.

### Printer

- If the Bluetooth and wireless LAN functions are both turned on, the communication speed may decrease due to radio wave interference. If this occurs, turn off the function you are not using (the Bluetooth or wireless LAN function).
- DO NOT cover, or insert foreign objects into the Paper Outlet Slot, AC/DC Connector, or USB port.
- DO NOT use paint thinner, benzene, alcohol, or any other organic solvent to clean the printer. Doing so may damage the casing finish. Use a soft, dry cloth to clean the printer.
- When using optional accessories, use them as described in their instruction manuals.
- This printer uses thermal paper. If the printed paper is marked with ink, for example written on or stamped, the ink may cause the printed text to fade or become discolored. In addition, the applied ink may take some time to dry.

Printed text may fade or become discolored if the label comes into contact with any of the following: vinyl chloride products, leather goods such as wallets and purses, organic compounds such as alcohol, ketones, or esters, adhesive tape, erasers, rubber mats, magic marker ink, permanent marker ink, correction fluid, carbon, glue, diazo sensitized paper, hand lotion, hair care products, cosmetics, water, or sweat.

- DO NOT touch the printer with wet hands.
- DO NOT use folded, wet or damp paper, otherwise a paper misfeed or malfunction may occur.
- DO NOT touch paper or labels with wet hands, otherwise a malfunction may occur.
- DO NOT leave the Release Cover open. Internal parts of the printer may collect dust and result in printing failure or paper jams.



### Related Information

- [Before You Use Your Printer](#)



## Trademarks and Licenses

- Apple, App Store, Mac, Safari, AirPrint, the AirPrint logo, iPad, iPhone, iPod touch, macOS, and iPadOS are trademarks of Apple Inc., registered in the United States and other countries.
- Android and Google Chrome are trademarks of Google LLC.
- The Bluetooth® word mark and logos are registered trademark owned by Bluetooth SIG, Inc. and any use of such marks by Brother Industries, Ltd. is under license. Other trademarks and trade names are those of their respective owners.
- Mopria®, the Mopria® Logo, the Mopria Alliance™ word mark and logo, and the Print. Scan. Go.™ tagline are registered and/or unregistered trademarks and service marks of Mopria Alliance, Inc. in the United States and other countries. Unauthorized use is strictly prohibited.
- QR Code is a registered trademark of DENSO WAVE INCORPORATED.
- Epson ESC/P is a registered trademark of Seiko Epson Corporation.
- Wi-Fi® is a registered trademark of Wi-Fi Alliance®.
- Wi-Fi Protected Setup™ is a trademark of Wi-Fi Alliance®.
- Mozilla and Firefox are registered trademarks of the Mozilla Foundation.
- QR Code Generating Program Copyright © 2008 DENSO WAVE INCORPORATED.
- BarStar Pro Encode Library (PDF417, Micro PDF417, DataMatrix, MaxiCode, AztecCode, GS1 Composite, GS1 Databar, Code93, MSI/Plessey, POSTNET, Intelligent Mail Barcode)  
Copyright © 2007 AINIX Corporation. All rights reserved.
- Blue SDK  
Copyright © 1995-2021 OpenSynergy GmbH.  
All rights reserved. All unpublished rights reserved.
- Portions of this software are copyright © 2014 The FreeType Project ([www.freetype.org](http://www.freetype.org)). All rights reserved.
- USB Type-C® is a registered trademark of USB Implementers Forum.

**Any trade names and product names of companies appearing on Brother products, related documents and any other materials are all trademarks or registered trademarks of those respective companies.**



### Related Information

- [Before You Use Your Printer](#)

## Open Source Licensing Remarks

This product includes open source software.

To see the Open Source Licensing Remarks, go to your model's **Manuals** page on the Brother support website at [support.brother.com](http://support.brother.com).



### Related Information

- [Before You Use Your Printer](#)
-

## Important Note

- The contents of this document and the specifications of this product are subject to change without notice.
- Brother reserves the right to make changes without notice in the specifications and materials contained herein and shall not be responsible for any damages (including consequential) caused by the reliance on the materials presented, including, but not limited to, typographical and other errors relating to the publications.
- For Windows 11 Users:  
This printer supports Microsoft Windows 11.  
All features in Windows 8.1 and Windows 10 are available in the Windows 11 environment and work in a similar way.
- Screen images in this document may differ depending on your computer's operating system, your product model, and software version.
- Before using the printer, make sure you read all the documents included with the printer for information about safety and operation.
- The printer shown in the illustrations may be different from your printer.
- The available supplies may vary depending on your country or region.
- We recommend using the latest version of P-touch Editor.
- To keep your printer's performance up to date, visit [support.brother.com](http://support.brother.com) to check for the latest firmware updates. Otherwise, some of your printer's functions may not be available.
- When replacing or disposing of your printer, Brother strongly recommends resetting it to its factory settings to remove all personal information.



### Related Information

- [Before You Use Your Printer](#)
-

## Set Up Your Printer

- [Parts Description](#)
- [Control Panel Overview](#)
- [LED Patterns and Indications](#)
- [Install the Rechargeable Li-ion Battery](#)
- [Remove the Rechargeable Li-ion Battery](#)
- [Connect the Printer to External Power](#)
- [Turn the Printer On or Off](#)
- [Charge the Rechargeable Li-ion Battery](#)
- [Load Paper in the Printer](#)





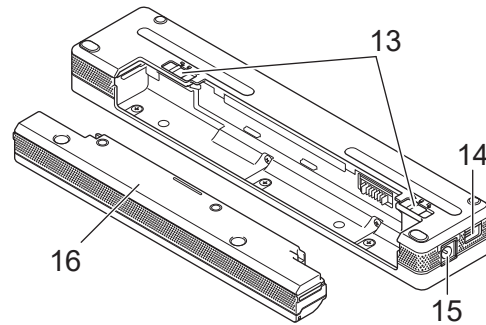
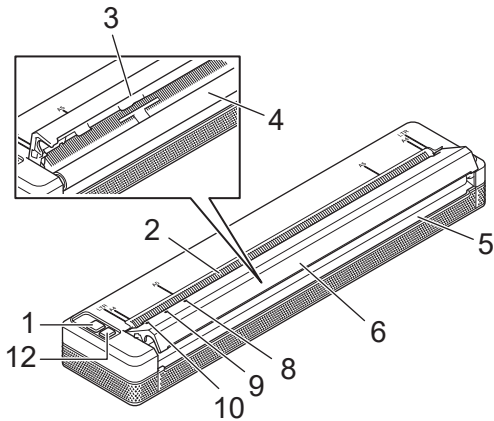

## Parts Description

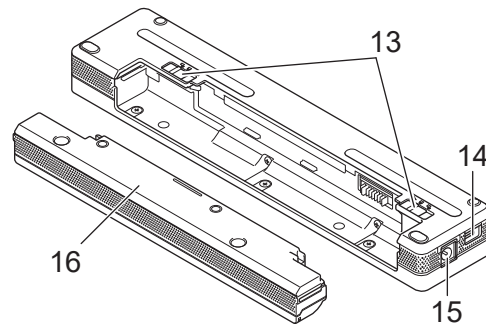
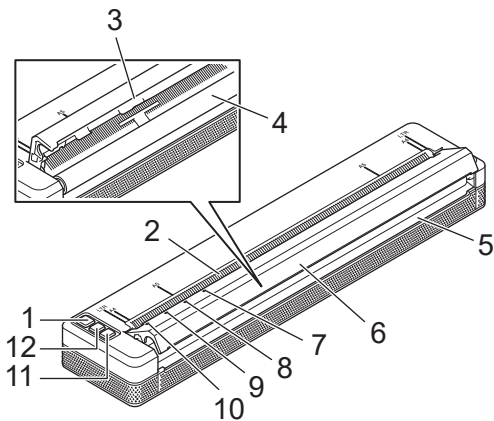
### PJ-822/PJ-823



### PJ-862/PJ-863/PJ-883



1.  Power Button
2. Paper Input Slot
3. Tear Bar
4. Platen Roller
5. Paper Outlet Slot
6. Release Cover
7.  Bluetooth Indicator (PJ-862/PJ-863)  
 Bluetooth and Wi-Fi Indicator (PJ-883)
8. Status Indicator
9. Data Indicator
10. Power Indicator
11.  Bluetooth Button (PJ-862/PJ-863)  
 Bluetooth and Wi-Fi Button (PJ-883)
12.  Feed Button
13. Battery Latches
14. USB Port

---

15. DC Connector

16. Battery Cavity Mounting Block



### Related Information

- [Set Up Your Printer](#)

#### **Related Topics:**

- [Control Panel Overview](#)
-



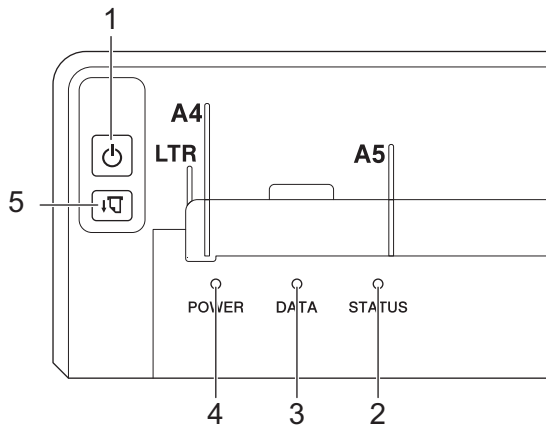

## Control Panel Overview

- >> [PJ-822/PJ-823](#)
- >> [PJ-862/PJ-863](#)
- >> [PJ-883](#)



### PJ-822/PJ-823



#### 1. Power Button

Function	Operation
Turn on the printer	Press and hold the Power button  for about one second until the Power LED lights up.
Turn off the printer	Press and hold the Power button  for about one second. (If the <b>Auto Power Off</b> feature is enabled in the Printer Setting Tool, the printer will turn off automatically after the selected period of inactivity.) For more information, see <i>Related Topics: Change Printer Settings Using the Printer Setting Tool (Windows)</i> . For more information, see <i>Related Topics: Change Printer Settings Using the Printer Setting Tool (Mac)</i> .
Start the printer in Mass Storage Mode	Press and hold the Power button  and press the Feed button  simultaneously. For more information about Mass Storage Mode, see <i>Related Topics: Print Using the USB Interface (Mass Storage Mode)</i> .

- 2. Status Indicator
- 3. Data Indicator
- 4. Power Indicator
- 5.  Feed Button



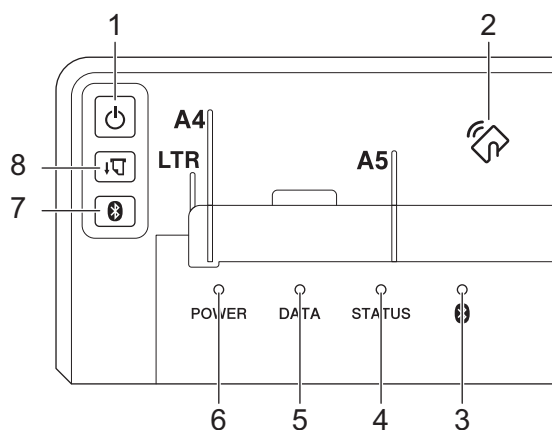

Function	Operation
Feed the paper	Load the paper and press the Feed button  to feed the paper.  If you continue to press and hold the Feed button  after about 2.17 in. (55 mm) of paper has been fed, approximately one page length of paper is fed at high speed.  The amount of paper fed is determined by the <b>Form Feed Mode</b> setting in the Printer Setting Tool.

Function	Operation
	<p>For more information, see <i>Related Topics: Change Printer Settings Using the Printer Setting Tool (Windows)</i>.</p> <p>For more information, see <i>Related Topics: Change Printer Settings Using the Printer Setting Tool (Mac)</i>.</p> <p>To ensure that printing is complete, wait five seconds after the printer has received the data before using a form feed command.</p>
Print the configuration report	<p>You can print a configuration report without connecting the printer to a computer or mobile device.</p> <p>For more information, see <i>Related Topics: Confirm Printer Settings</i>.</p>

## PJ-862/PJ-863



### 1. Power Button

Function	Operation
Turn on the printer	Press and hold the Power button  for about one second until the Power LED lights up.
Turn off the printer	<p>Press and hold the Power button  for about one second. (If the <b>Auto Power Off</b> feature is enabled in the Printer Setting Tool, the printer will turn off automatically after the selected period of inactivity.)</p> <p>For more information, see <i>Related Topics: Change Printer Settings Using the Printer Setting Tool (Windows)</i>.</p> <p>For more information, see <i>Related Topics: Change Printer Settings Using the Printer Setting Tool (Mac)</i>.</p>
Start the printer in Mass Storage Mode	<p>Press and hold the Power button  and press the Feed button  simultaneously.</p> <p>For more information about Mass Storage Mode, see <i>Related Topics: Print Using the USB Interface (Mass Storage Mode)</i>.</p>

### 2. Near-Field Communication (NFC) Sensor

### 3. Bluetooth Indicator

### 4. Status Indicator

### 5. Data Indicator



### 6. Power Indicator

### 7. Bluetooth Button



Function	Operation
Enable/Disable the Bluetooth function	Press the Bluetooth button  .



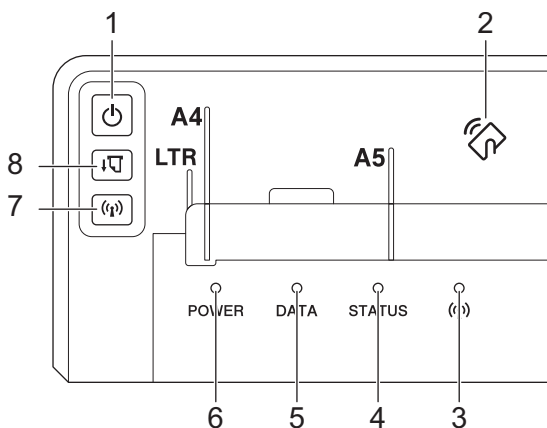

8.  Feed Button

Function	Operation
Feed the paper	<p>Load the paper and press the Feed button  to feed the paper.</p> <p>If you continue to press and hold the Feed button  after about 2.17 in. (55 mm) of paper has been fed, approximately one page length of paper is fed at high speed.</p> <p>The amount of paper fed is determined by the <b>Form Feed Mode</b> setting in the Printer Setting Tool.</p> <p>For more information, see <i>Related Topics: Change Printer Settings Using the Printer Setting Tool (Windows)</i>.</p> <p>For more information, see <i>Related Topics: Change Printer Settings Using the Printer Setting Tool (Mac)</i>.</p> <p>To ensure that printing is complete, wait five seconds after the printer has received the data before using a form feed command.</p>
Print the configuration report	<p>You can print a configuration report without connecting the printer to a computer or mobile device.</p> <p>For more information, see <i>Related Topics: Confirm Printer Settings</i>.</p>



## PJ-883











1.  Power Button



Function	Operation
Turn on the printer	Press and hold the Power button  for about one second until the Power LED lights up.
Turn off the printer	<p>Press and hold the Power button  for about one second. (If the <b>Auto Power Off</b> feature is enabled in the Printer Setting Tool, the printer will turn off automatically after the selected period of inactivity.)</p> <p>For more information, see <i>Related Topics: Change Printer Settings Using the Printer Setting Tool (Windows)</i>.</p> <p>For more information, see <i>Related Topics: Change Printer Settings Using the Printer Setting Tool (Mac)</i>.</p>
Start the printer in Mass Storage Mode	Press and hold the Power button  and press the Feed button  simultaneously.

Function	Operation
	For more information about Mass Storage Mode, see <i>Related Topics: Print Using the USB Interface (Mass Storage Mode)</i> .

2. Near-Field Communication (NFC) Sensor
3.  Bluetooth and Wi-Fi Indicator
4. Status Indicator
5. Data Indicator
6. Power Indicator
7.  Bluetooth and Wi-Fi Button

Function	Operation
Enable/Disable the Bluetooth and Wi-Fi function	<p>Press the Bluetooth and Wi-Fi button  to enable or disable the Bluetooth and Wi-Fi functions of the printer.</p> <p>To toggle between connection modes, press and hold the Bluetooth and Wi-Fi button  for about three seconds. The connection mode changes each time you press and hold the Bluetooth and Wi-Fi button .</p> <p>The Bluetooth and Wi-Fi indicator  color shows the wireless connection:</p> <ul style="list-style-type: none"> <li>• Blue : Bluetooth</li> <li>• Green : Wi-Fi</li> <li>• Cyan : Both Bluetooth and Wi-Fi</li> </ul>
Use WPS to configure Wi-Fi settings easily	Press and hold the Bluetooth and Wi-Fi button  for about five seconds to configure the Wi-Fi settings using WPS.
Use WLAN Assistant Wizard to configure Wi-Fi settings	Press and hold the Bluetooth and Wi-Fi button  for about 10 seconds to configure the Wi-Fi settings using WLAN Assistant Wizard.

8.  Feed Button

Function	Operation
Feed the paper	<p>Load the paper and press the Feed button  to feed the paper.</p> <p>If you continue to press and hold the Feed button  after about 2.17 in. (55 mm) of paper has been fed, approximately one page length of paper is fed at high speed.</p> <p>The amount of paper fed is determined by the <b>Form Feed Mode</b> setting in the Printer Setting Tool.</p> <p>For more information, see <i>Related Topics: Change Printer Settings Using the Printer Setting Tool (Windows)</i>.</p> <p>For more information, see <i>Related Topics: Change Printer Settings Using the Printer Setting Tool (Mac)</i>.</p> <p>To ensure that printing is complete, wait five seconds after the printer has received the data before using a form feed command.</p>
Print the configuration report	<p>You can print a configuration report without connecting the printer to a computer or mobile device.</p> <p>For more information, see <i>Related Topics: Confirm Printer Settings</i>.</p>



---

## Related Information





- [Set Up Your Printer](#)











































### **Related Topics:**









- [Change Printer Settings Using the Printer Setting Tool \(Windows\)](#)
  - [Change Printer Settings Using the Printer Setting Tool \(Mac\)](#)
  - [Confirm Printer Settings](#)
  - [Print Using the USB Interface \(Mass Storage Mode\)](#)
-







## LED Patterns and Indications

Your printer features three LED indicators labeled POWER, DATA, and STATUS that light and flash to indicate the printer's status. Each LED indicator may light or flash in a color shown below. The symbols used in this section explain the meaning of the different indicator colors and patterns.



















LED Indicator Color	Description
	Indicator is lit in the color shown.
	Indicator is flashing in the color shown.
	Indicator is off, lit, or flashing in any color.
	Indicator is off.

Power	Data	Status	 Bluetooth (PJ-862/PJ-863)  Bluetooth and Wi-Fi (PJ-883)	Description
				Battery charge completed with the AC Adapter, Car Adapter, or USB Type-C <sup>®</sup> AC Adapter connected
				Battery charging in progress
				Rechargeable Li-ion Battery in use, battery charge is full
		 (Once every four seconds)		Rechargeable Li-ion Battery in use, battery charge is half-full
		 (Twice every four seconds)		Rechargeable Li-ion Battery in use, battery charge is low
		 (Once every second)		Rechargeable Li-ion Battery in use, charge the battery
				Battery charging while printer is turned off
				Printer in idle mode
 (Once every 3.5 seconds)				Printer in Sleep mode (Battery charging)
 (Once every 3.5 seconds)				Printer in Sleep mode (Battery not charging)





























Power	Data	Status	 Bluetooth (PJ-862/PJ-863)  Bluetooth and Wi-Fi (PJ-883)	Description
	 (Once every two seconds)			Receiving data
				Printing
				Buffer contains unprinted data
	 (Once every two seconds)			Transferring data
				Maintenance/ configuration report printing /Cleaning mode
				Printer in Boot mode
				Printer in Cooling Down mode
 (Once every second)				Communication error
				No template error
				Memory full error
				BLF file error
				Maximum print length exceeded error
				Disconnected adapter error (this error appears only if the <b>Hybrid Power Supply</b> setting is enabled)
				ESC/P Memory full error
				JPEG file error
				Remaining battery error
 (Once every second)	 (Once every second)			Mass Storage Mode error













Power	Data	Status	 Bluetooth (PJ-862/PJ-863)  Bluetooth and Wi-Fi (PJ-883)	Description
 (Once every second)	 (Once every second)	 (Once every second)		System error

### PJ-862/PJ-863/PJ-883

Power	Data	Status	 Bluetooth (PJ-862/PJ-863)  Bluetooth and Wi-Fi (PJ-883)	Description
				Bluetooth on, connected
			 (Once every second)	Pairing with Bluetooth
			 (Once every three seconds)	Bluetooth on, not connected (during auto re-pairing)
 (Once every second)	 (Once every second)	 (Once every second)	 (Once every second)	Bluetooth error

### PJ-883

Power	Data	Status	 Bluetooth and Wi-Fi	Description
			 (Once every three seconds)	Wi-Fi on, not connected
				Wi-Fi on, connected
			 (Once every second)	WPS setup in progress
		 (Once every second)	 (Once every second)	WPS setup unsuccessful
 (Once every second)	 (Once every second)	 (Once every second)	 (Once every second)	Wi-Fi error
			 (Once every three seconds)	Bluetooth and Wi-Fi on, not connected
				Bluetooth and Wi-Fi on, either one or both connected

Power	Data	Status	 Bluetooth and Wi-Fi	Description
		 (Two times every 2.5 seconds)	 (Two times every 2.5 seconds)	Access point search error
		 (Three times every 3.5 seconds)	 (Three times every 3.5 seconds)	Access point connection error
		 (Once every second)	 (Once every second)	Security error



### Related Information

- [Set Up Your Printer](#)

## Install the Rechargeable Li-ion Battery

1. Slide Battery Latch 1 (a) to the unlocked position.
2. While holding Battery Latch 2 (b) in the unlocked position, remove the Battery Cavity Mounting Block (c).

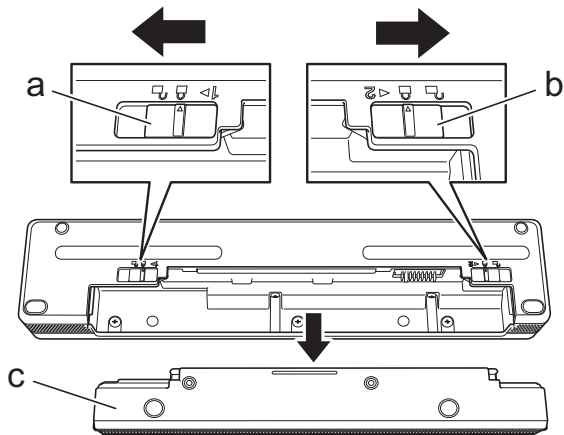

- a. Battery Latch 1
- b. Battery Latch 2
- c. Battery Cavity Mounting Block

3. Release Battery Latch 2.
4. Insert the Rechargeable Li-ion Battery (a) into the Battery Cavity (b) until it locks into place.

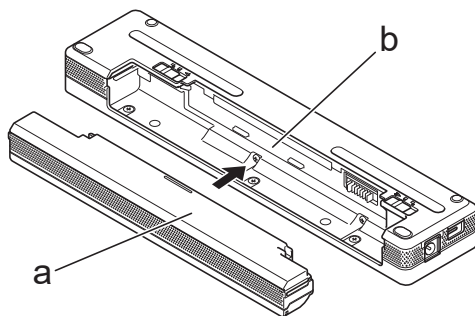

- a. Rechargeable Li-ion Battery
- b. Battery Cavity

5. Slide Battery Latch 1 to the locked position.

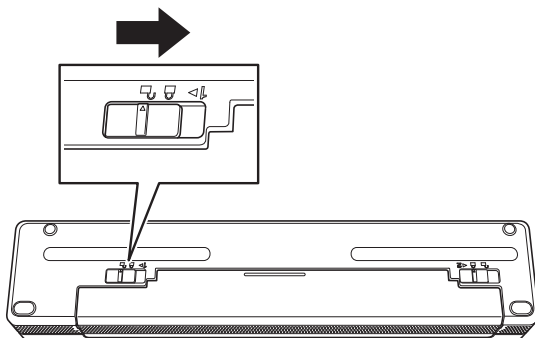

- The voltage supplied by the Rechargeable Li-ion Battery may vary. The printing speed may also vary depending on the voltage.
- When using the Rechargeable Li-ion Battery, the Battery Cavity Mounting Block is not required. Keep it in a safe place to avoid losing it.





## Related Information

- [Set Up Your Printer](#)
-

## Remove the Rechargeable Li-ion Battery

1. Slide Battery Latch 1 (a) to the unlocked position.
2. While holding Battery Latch 2 (b) in the unlocked position, remove the Rechargeable Li-ion Battery (c).

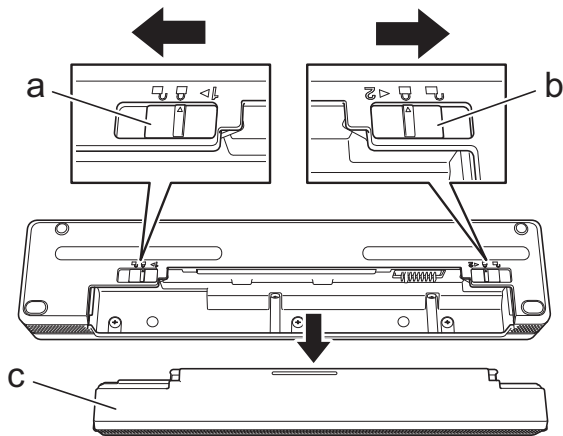

- a. Battery Latch 1
- b. Battery Latch 2
- c. Rechargeable Li-ion Battery

3. Release Battery Latch 2.
4. Insert the Battery Cavity Mounting Block (a) into the Battery Cavity (b) until it locks into place.

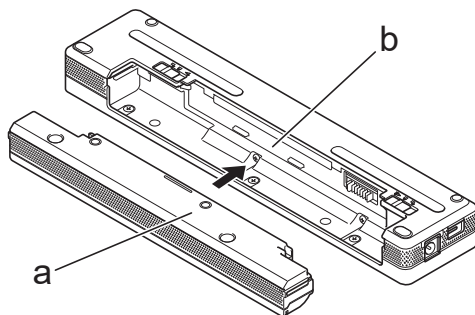

- a. Battery Cavity Mounting Block
- b. Battery Cavity

5. Slide Battery Latch 1 to the locked position.

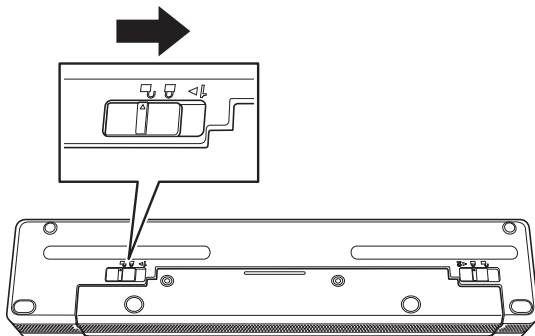

### ✓ Related Information

- [Set Up Your Printer](#)

## Connect the Printer to External Power



Connecting the printer to a power supply while the printer is off automatically turns the printer on for a system check. If **Auto Power On** is set to **Off**, the printer turns off after the system check.

- >> [Connect to an AC Power Outlet \(Optional\)](#)
- >> [Connect to a DC Power Outlet \(Optional\)](#)
- >> [Connect to an AC Power Outlet Using the AC Adapter for USB Type-C \(Optional\)](#)

### Connect to an AC Power Outlet (Optional)

Connect the printer to a nearby AC power outlet to power the printer or charge the Rechargeable Li-ion Battery using AC power. When purchasing the printer, purchase the correct AC Adapter and AC power cord for the region where the printer will be used.



The AC Adapter and AC power cord are optional accessories.

1. Connect the AC Adapter (a) to the printer.
2. Connect the AC power cord (b) to the AC Adapter.
3. Connect the AC power cord to a nearby AC power outlet (100 V AC - 240 V AC, 50/60 Hz).

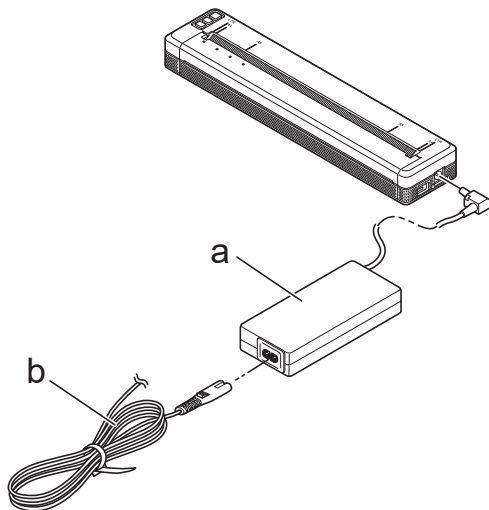

- a. AC Adapter
- b. AC power cord

### Connect to a DC Power Outlet (Optional)

Connect the printer to your vehicle's 12 V DC power outlet (cigarette lighter or similar) to charge the Rechargeable Li-ion Battery.



- The Car Adapter is an optional accessory.
- The voltage supplied by a vehicle may fluctuate, and printing speed may vary.
- The Car Adapter plug is not compatible with other outlets that are not the 12 V cigarette type.

1. Connect the Car Adapter to the vehicle's 12 V DC power outlet.

2. Connect the Car Adapter (a) to the printer.

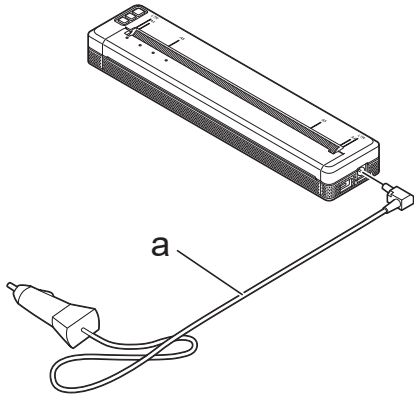

a. Car Adapter

### Connect to an AC Power Outlet Using the AC Adapter for USB Type-C (Optional)

Connect the printer to a nearby AC power outlet to charge the Rechargeable Li-ion Battery using the AC Adapter for USB Type-C. When purchasing the printer, purchase the correct AC Adapter for USB Type-C and AC power cord for the region where the printer will be used.



- The AC Adapter for USB Type-C and AC power cord are optional accessories.
- The AC Adapter for USB Type-C is for charging only. If the Rechargeable Li-ion Battery is not installed, power cannot be supplied to the printer.

1. Connect the AC Adapter for USB Type-C (a) to the printer.
2. Connect the AC power cord (b) to the AC Adapter for USB Type-C.
3. Connect the AC power cord to a nearby AC power outlet (100 V AC - 240 V AC, 50/60 Hz).

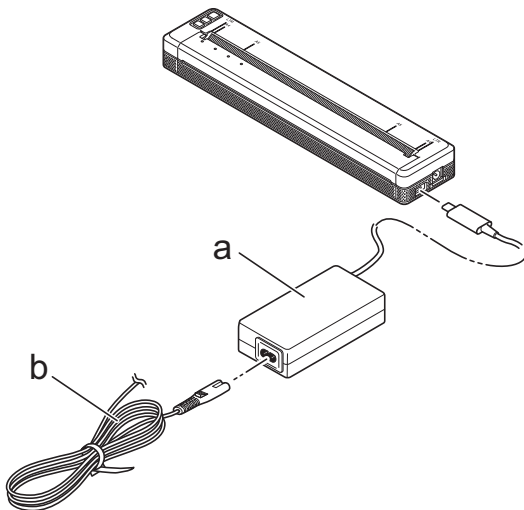

a. AC Adapter for USB Type-C  
b. AC power cord

### ✓ Related Information

- [Set Up Your Printer](#)



## Turn the Printer On or Off

>> [Turn On the Printer](#)

>> [Turn Off the Printer](#)

### Turn On the Printer

1. Use a fully charged battery, or connect the printer to an AC or DC power outlet to power your printer.
2. Press and hold the Power button  (a).

The Power indicator (b) lights in green  (if the printer is connected to an AC or DC power outlet) or in orange  (if using the Rechargeable Li-ion Battery).

PJ-822/PJ-823

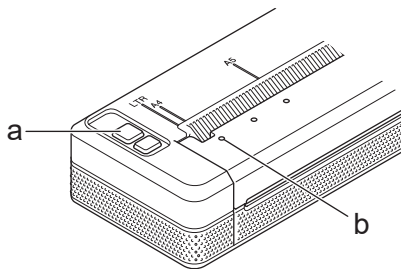

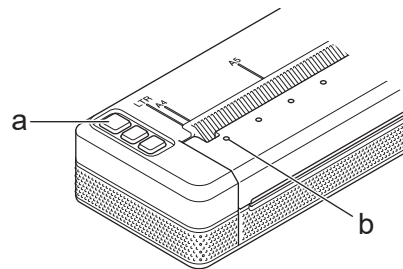

PJ-862/PJ-863/PJ-883



- a.  Power button
- b. Power Indicator

### Turn Off the Printer

Press and hold the Power button  until the Power and Status indicators light in orange , then all LEDs turn off.

### NOTE

When turning the printer off, do NOT remove the battery or disconnect the AC Adapter or Car Adapter until the Power and Status indicators turn off.

### Related Information

- [Set Up Your Printer](#)

## Charge the Rechargeable Li-ion Battery

>> [Tips on Using the Rechargeable Li-ion Battery](#)

>> [Charge the Rechargeable Li-ion Battery](#)

>> [Stop Charging the Rechargeable Li-ion Battery](#)

### Tips on Using the Rechargeable Li-ion Battery

Fully charge the Rechargeable Li-ion Battery before using the printer.



- High-density (dark) printing discharges the Rechargeable Li-ion Battery faster than low-density printing. Adjust the print density setting in the printer driver's dialog box, or in the Printer Setting Tool.  
For more information, see *Related Topics*: Device Settings of the Printer Setting Tool (Windows).  
For more information, see *Related Topics*: Change Printer Settings Using the Printer Setting Tool (Mac).
- Charge the Rechargeable Li-ion Battery in an environment with a temperature between 32°F and 104°F (0°C and 40°C), otherwise the battery will not charge.
- The recommended charging temperature range for the Rechargeable Li-ion Battery is between 41°F to 95°F (5°C to 35°C).
- If you use the printer when both the Rechargeable Li-ion Battery is installed and the AC Adapter or Car Adapter is connected, the Status indicator may turn off and charging may stop even if the Rechargeable Li-ion Battery has not been fully charged.
- To prevent deterioration of the Rechargeable Li-ion Battery, charging will not occur when the remaining charge in the battery is sufficient, even if the AC Adapter or AC Adapter for USB Type-C is connected.

### Rechargeable Li-ion Battery Characteristics

To ensure the highest performance and longest life from the Rechargeable Li-ion Battery:

- Do not use or store the Rechargeable Li-ion Battery in a location exposed to extreme high or low temperatures as it may deteriorate more quickly.
- Remove the Rechargeable Li-ion Battery when storing the printer for long periods of time.
- Store the Rechargeable Li-ion Batteries with less than a 50% charge in a cool dry place and out of direct sunlight.
- Recharge the Rechargeable Li-ion Battery every six months if it is stored for long periods of time.

### Charge the Rechargeable Li-ion Battery

Charge the Rechargeable Li-ion Battery as soon as you set up your printer.

1. Turn off the printer.
2. Do one of the following:
  - Use the AC Adapter and AC power cord to connect the printer to an AC power outlet.
  - Use the Car Adapter to connect the printer to a DC power outlet.
  - Use the AC Adapter for USB Type-C and AC power cord to connect the printer to an AC power outlet.
  - Use a USB Type-C cable to connect the printer to your computer or a compatible USB charger.



- Charging with a USB Type-C cable will take longer than other charging methods.
- The USB charger must be 5 V 0.5 A or higher.
- If a USB Type-C cable is not included, use a USB Type-C cable that matches the voltage and electrical current of the USB charger.

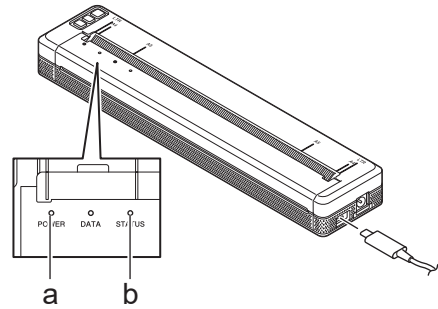
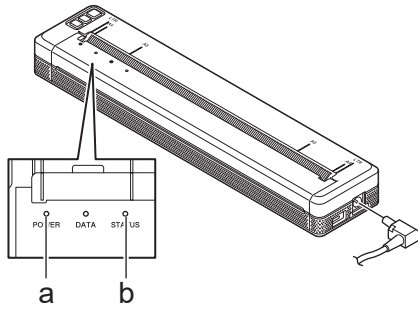

- a. Power Indicator
- b. Status Indicator

When the battery is fully charged, the Status indicator turns off.

3. Disconnect the power source from the printer.



When using the dedicated adapter, charge the Rechargeable Li-ion Battery for two hours to fully charge the battery. When fully charged, the Rechargeable Li-ion Battery will print about 600 pages.

## Stop Charging the Rechargeable Li-ion Battery

To stop charging the Rechargeable Li-ion Battery, disconnect the printer from the power source.



### Related Information

- [Set Up Your Printer](#)

#### Related Topics:

- [Device Settings of the Printer Setting Tool \(Windows\)](#)
- [Change Printer Settings Using the Printer Setting Tool \(Mac\)](#)

## Load Paper in the Printer

>> Load Paper in the Printer

>> Cut Paper

### Load Paper in the Printer

1. Use both hands to hold the paper straight.
2. Insert the paper carefully, *print surface face down*, into the printer's input slot until the roller pulls it into the starting position.

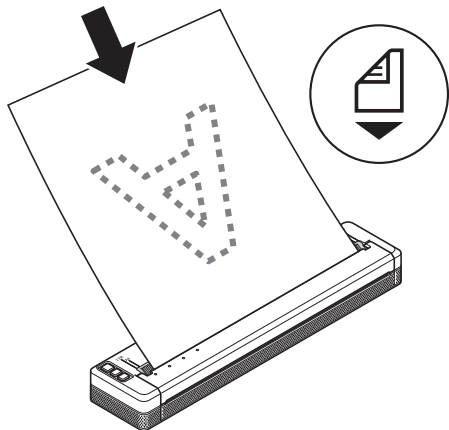

For fanfold paper

Insert the fanfold paper with the black marks positioned as shown in the illustration.

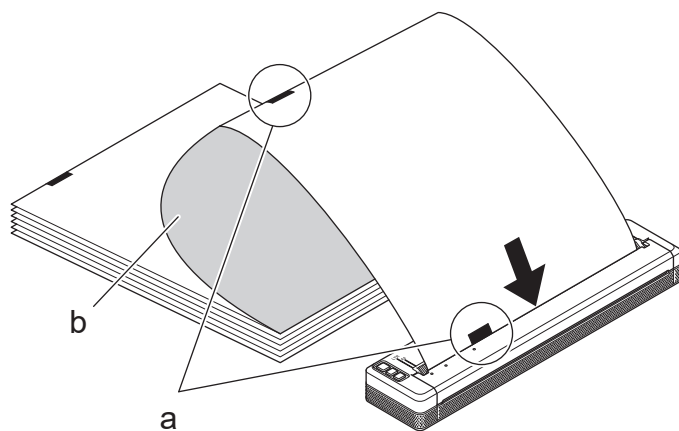

- a. Black marks
- b. Print surface





- The bottom edge of the paper must be parallel to the roller.
- Only one side of the paper can be printed. Check the paper, and load it so that the smooth, thermal side faces down.
- When loading A4-size paper, align the paper with the A4 Indicators on the printer. When loading Letter-size paper, align the paper with the LTR Indicators on the printer.

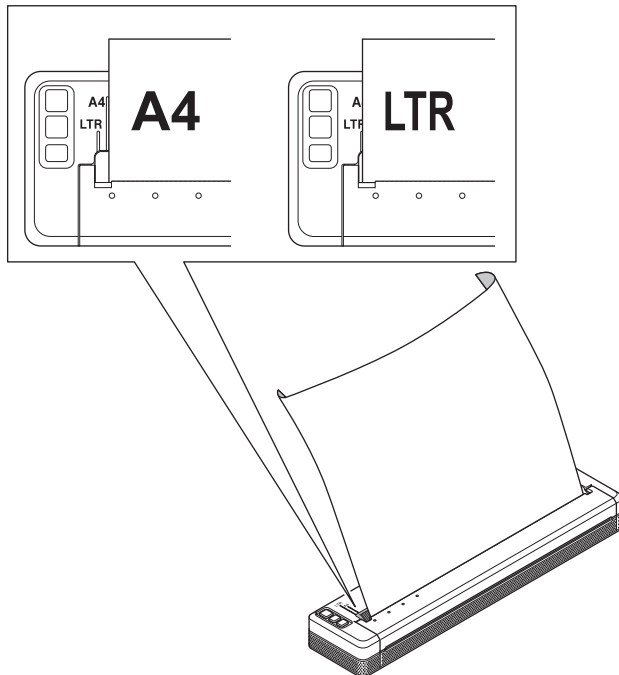

## Cut Paper

You can set the paper type to **Cut Sheet**, **Roll**, or **Perforated Roll** in the printer driver.

1. Use the printer's Tear Bar to cut the paper.
2. Pull one edge of the ejected paper up and towards the other edge diagonally.

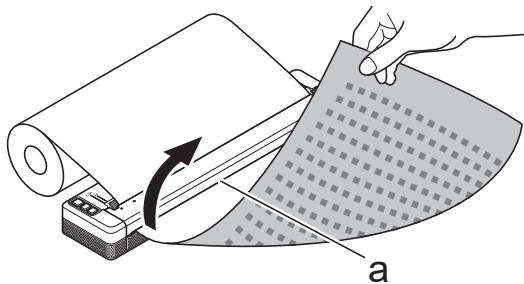

a. Tear Bar

### CAUTION

The Tear Bar is sharp. To avoid injury, do not touch the Tear Bar.



### Related Information

- [Set Up Your Printer](#)

## Install Software

- [Install Printer Drivers and Software on a Computer](#)
- [Connect the Printer to a Computer or Mobile Device](#)

## Install Printer Drivers and Software on a Computer

To print from your computer, install the printer driver and P-touch Editor on your computer.

1. In the address bar, type [install.brother](http://install.brother) and download the Software/Documentation installer.

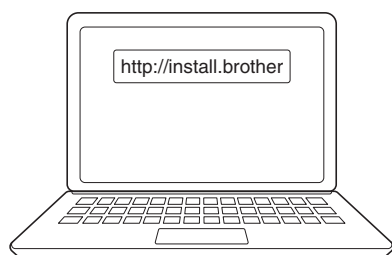

2. Double-click the downloaded installer, and follow the on-screen instructions.

### NOTE

To use your printer's advanced features, select the additional software you want during installation.



- **PJ-883:**

To connect the printer to a computer using a wireless connection, we recommend the following:

- Write down your wireless network's SSID (Network Name) and Password (Network Key) before you begin. If you cannot find this information, contact your network administrator or wireless router/access point manufacturer.
  - To connect the printer to a computer using Wireless Direct, select "USB connection" during installation. When installation finishes, click the Wireless Direct link.
- **PJ-883:**

To use the printer with a different connection method than the one you selected during installation, run the installer again, reinstall the software and printer drivers, and select a different connection method.



### Related Information

- [Install Software](#)
  - [Available Applications](#)

## Available Applications

### Windows

Application	Features
P-touch Editor	Allows you to design and print custom documents using built-in drawing tools to create various font and text styles, import images, and insert barcodes.
P-touch Transfer Manager	Allows you to transfer templates and other data to the printer and save backups of your data on the computer. This application is installed with P-touch Editor.
P-touch Library	Manages and prints P-touch Editor templates. You can use P-touch Library to print templates. This application is installed with P-touch Editor.
P-touch Transfer Express	Allows you to transfer documents to the printer. To download the installer, go to your model's <b>Downloads</b> page on the Brother support website at <a href="http://support.brother.com">support.brother.com</a> .
P-touch Update Software	Updates software and firmware to the latest version.
Printer Setting Tool	Allows you to set the printer's settings from a computer. <ul style="list-style-type: none"> <li>• <b>Communication Settings</b></li> <li>• <b>Device Settings</b></li> <li>• <b>P-touch Template Settings</b></li> </ul>
BRAdmin Light (PJ-883)	Finds the printer on your network and allows you to configure basic settings from your computer.
BRAdmin Professional (PJ-883)	Finds the printer on your network and allows you to configure advanced settings and updates from your computer.
Font Manager	Allows you to transfer fonts and delete fonts from the printer. Use various print commands to access and print transferred fonts.   <b>Font Permissions</b> When using fonts, you must abide by all the terms and conditions set forth by each rightful font owner. Before downloading fonts, you must confirm that you have legitimate licences to use the fonts and comply with their terms and conditions.
Web Based Management (PJ-883)	Allows you to use a standard web browser to manage a printer on your network using HTTPS.

### Mac

Application	Features
P-touch Editor	Allows you to design and print custom documents using built-in drawing tools to create various font and text styles, import images, and insert barcodes.
Transfer Express <sup>1</sup>	Updates firmware to the latest version and allows you to transfer templates to the printer.
Printer Setting Tool <sup>1</sup>	Allows you to set the printer's settings from a computer.
Wireless Device Setup Wizard (PJ-883)	Allows you to configure your printer for a wireless network.

<sup>1</sup> Available with the USB connection only.



## Related Information

- [Install Printer Drivers and Software on a Computer](#)

### **Related Topics:**

- [Compatible Printing Apps](#)
-

## Connect the Printer to a Computer or Mobile Device

- [Connect the Printer to a Computer Using a USB Cable](#)
- [Connect the Printer to a Computer Using Wi-Fi](#)
- [Connect the Printer to a Computer Using Bluetooth Connection](#)
- [Connect the Printer to a Mobile Device Using NFC \(Android\)](#)

## Connect the Printer to a Computer Using a USB Cable

A USB Type-C cable is required for connecting the printer to your computer. It may be included with your printer, depending on your country.

### NOTE

The USB connection alone is not sufficient to power your printer. Make sure you install a Rechargeable Li-ion Battery or connect the printer to an external power supply, such as an AC Adapter or Car Adapter.

1. Turn off the printer.
2. Connect the USB cable to the USB Port on the printer, and then to your computer.

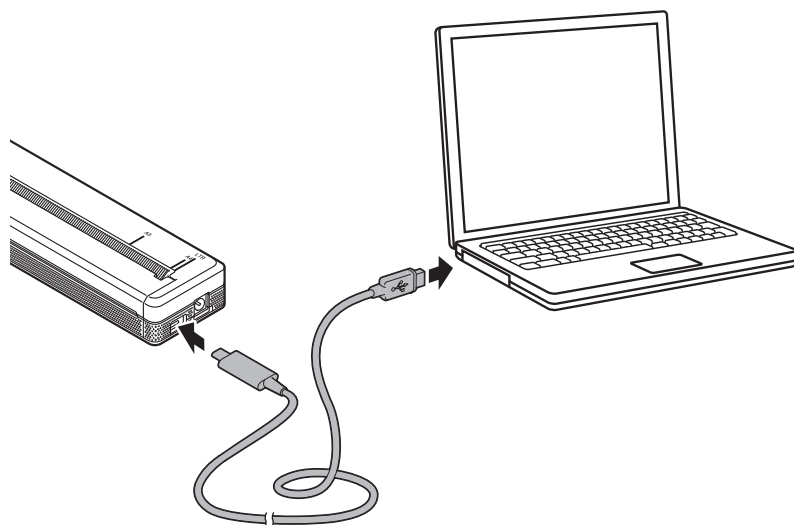

3. Turn on the printer.

### ✓ Related Information

- [Connect the Printer to a Computer or Mobile Device](#)

## Connect the Printer to a Computer Using Wi-Fi

**Related Models:** PJ-883

- [Connect the Printer to a Computer Using a Wi-Fi Router/Access Point \(Infrastructure Mode\)](#)
- [Connect the Printer to a Computer without Using a Wi-Fi Router/Access Point \(Wireless Direct\)](#)
- [Connect the Printer to a Computer Using Infrastructure Mode and Wireless Direct Simultaneously](#)
- [Connect the Printer to a Computer Using WPS \(Wi-Fi Protected Setup™\)](#)







## Connect the Printer to a Computer Using a Wi-Fi Router/Access Point (Infrastructure Mode)

**Related Models:** PJ-883

Infrastructure Mode allows you to connect the printer to a computer or mobile device via a Wi-Fi router/access point.

### Before You Begin









Configure the printer's Wi-Fi settings to communicate with your Wi-Fi router/access point. After the printer is configured, the computers and mobile devices on your network will have access to the printer.

- Before connecting the printer to your network, contact your system administrator to confirm your Wi-Fi network settings.
- To reconfigure the Wi-Fi settings, or if the status of the printer's Wi-Fi connection is unknown, reset the printer's Wi-Fi settings.
  1. Turn off the printer.
  2. Press and hold the Feed button  and the Power button  for about two seconds.
  3. While holding down the Feed button , press the Power button  two times, and then release the Feed button .

The Power indicator starts flashing in orange .

4. Press the Feed button  twice.
- To achieve the best results with normal everyday printing, use the printer as close to the Wi-Fi router/access point as possible with minimal obstructions. Large objects and walls between the two devices, as well as interference from other electronic devices, can affect the transfer speed of print data.

### Connect the Printer to Your Wi-Fi Router/Access Point

1. Write down the SSID (Network Name) and Password (Network Key) of your Wi-Fi router/access point.
2. Connect the printer and computer using a USB cable.
3. Press the Bluetooth and Wi-Fi button  on your printer to turn the Wi-Fi function on.
  - Make sure the Bluetooth and Wi-Fi indicator  starts flashing in green  or cyan  once every three seconds.
  - If the Bluetooth and Wi-Fi indicator  is flashing in blue , press and hold the Bluetooth and Wi-Fi button  for about three seconds. The flashing color changes each time you press and hold the Bluetooth and Wi-Fi button .
4. Configure the Infrastructure Mode settings of the printer.
  - Using a Windows computer:
    - a. Start the Printer Setting Tool on your computer, and click the **Communication Settings** button.
    - b. Click the **General** tab, and in the **Selected Interface** section, select **Infrastructure**.
    - c. Click the **Wireless LAN** tab, and in the **Wireless Settings** section, go to **Communication Mode** and select **Infrastructure**.
    - d. Click the **Wireless LAN** tab and select **Wireless Settings**. Type the SSID that you wrote down, or click **Search** and select the SSID from the list that appears.
    - e. In the **Password** field, type **Passphrase**.



---

The required information depends on the authentication method and encryption mode; enter only the information relevant to your network environment.

---

- f. Click **Apply**.
- Using a Mac computer:
  - a. Start the Wireless Device Setup Wizard included in the Printer Driver Package, and then follow the on-screen instructions.
  - b. If you have not downloaded the Printer Driver Package, go to your model's **Downloads** page on the Brother support website at [support.brother.com](http://support.brother.com) to download the package. Double-click the downloaded file. The Wireless Device Setup Wizard can be found in the **Utilities** folder.

When the connection between the printer and your Wi-Fi router/access point is established, the Bluetooth and Wi-Fi indicator (📶) lights in green ● or cyan ●. Computers and mobile devices that are on the same network as the printer will have access to the printer.



---

To change any other network settings, use the Printer Setting Tool.

---



### Related Information

- [Connect the Printer to a Computer Using Wi-Fi](#)

#### Related Topics:









- [Change Printer Settings Using the Printer Setting Tool \(Windows\)](#)
  - [Communication Settings of the Printer Setting Tool \(Windows\)](#)
-

## Connect the Printer to a Computer without Using a Wi-Fi Router/Access Point (Wireless Direct)

**Related Models:** PJ-883

Wireless Direct allows you to connect the printer to your computer or mobile device directly, without a Wi-Fi router/access point. The printer serves as a Wi-Fi access point.

1. Confirm the Wireless Direct settings of the printer.
  - Using a Windows computer:
    - a. Connect the printer and computer using a USB cable.
    - b. Start the Printer Setting Tool on your computer, and click the **Communication Settings** button.
    - c. Confirm that **Wireless Direct** is selected for **Selected Interface** in the **General** tab.
  - Using a Mac computer:

Connect the printer and computer with a USB cable. Start the Printer Setting Tool on your computer, and confirm that **WirelessDirect** is set to **On** in the **Wireless LAN** tab.
2. Press the Bluetooth and Wi-Fi button  on your printer to turn on the Wi-Fi function.
  - Make sure the Bluetooth and Wi-Fi indicator  starts flashing in green  or cyan  once every three seconds.
  - If the Bluetooth and Wi-Fi indicator  is flashing in blue , press and hold the Bluetooth and Wi-Fi button  for about three seconds. The flashing color changes each time you press and hold the Bluetooth and Wi-Fi button .
3. Use your computer or mobile device to select the SSID of the printer. If required, enter the Password.



The default SSID and Password are as follows:

- SSID: "DIRECT-\*\*\*\*\*\_PJ-883" where \*\*\*\*\* is the last five digits of the printer's serial number.
  - Password: 883 \*\*\*\*\*
- \*\*\*\*\* is the last five digits of the serial number located on the printer's base.

### NOTE

- The serial number label is located on the base of the printer. You can also confirm the serial number by printing the configuration report.

For more information, see *Related Topics*: Confirm Printer Settings.
- Use the Printer Setting Tool to change the printer's network settings.
- The Printer Setting Tool also allows you to apply the network settings to multiple printers.
- You cannot connect to the Internet via Wi-Fi while using Wireless Direct. To use the Internet, connect using a Wi-Fi router/access point (Infrastructure Mode).
- We recommend setting a new Wireless Direct password using the Printer Setting Tool to protect your printer from unauthorized access.



### Related Information

- [Connect the Printer to a Computer Using Wi-Fi](#)

---

**Related Topics:**

- [Change Printer Settings Using the Printer Setting Tool \(Windows\)](#)
  - [Communication Settings of the Printer Setting Tool \(Windows\)](#)
  - [Change Printer Settings Using the Printer Setting Tool \(Mac\)](#)
  - [Confirm Printer Settings](#)
-

## Connect the Printer to a Computer Using Infrastructure Mode and Wireless Direct Simultaneously

**Related Models:** PJ-883

1. Launch the **Printer Setting Tool** on your Windows computer.
2. Click the **Communication Settings** button.
3. Click **General** > **Communication Settings**.
4. Confirm that the **Infrastructure and Wireless Direct** option is selected for the **Selected Interface** setting.



### Related Information

- [Connect the Printer to a Computer Using Wi-Fi](#)

#### Related Topics:

- [Change Printer Settings Using the Printer Setting Tool \(Windows\)](#)
- [Communication Settings of the Printer Setting Tool \(Windows\)](#)



## Connect the Printer to a Computer Using WPS (Wi-Fi Protected Setup™)



**Related Models:** PJ-883

1. Confirm that your Wi-Fi router/access point displays the WPS symbol.



2. Place the printer within the range of your Wi-Fi router/access point.  
The range may differ depending on your environment. See the instructions provided with your Wi-Fi router/access point.
3. Press the WPS button on your Wi-Fi router/access point.
4. Press and hold the Bluetooth and Wi-Fi button () on your printer for about five seconds.

The Bluetooth and Wi-Fi indicator () on the printer flashes in green  once every second.

When the connection is established, the Bluetooth and Wi-Fi indicator () lights in green . Computers and mobile devices that are on the same network as the printer will have access to the printer. For more information, see the instructions provided with your Wi-Fi router/access point.



The printer will try to connect using WPS for two minutes. If the Bluetooth and Wi-Fi button () is pressed for another five seconds during that time, the printer will continue trying to connect for an additional two minutes.

### Related Information

- [Connect the Printer to a Computer Using Wi-Fi](#)

## Connect the Printer to a Computer Using Bluetooth Connection

**Related Models:** PJ-862/PJ-863/PJ-883

Follow the manufacturer's recommendations for your Bluetooth-equipped devices (computers and mobile devices) or Bluetooth adapter, and install any necessary hardware and software.

### NOTE



- You can also use the Printer Setting Tool to change the printer's communication settings.  
For more information, see *Related Topics*: [Communication Settings of the Printer Setting Tool \(Windows\)](#).  
For more information, see *Related Topics*: [Change Printer Settings Using the Printer Setting Tool \(Mac\)](#).
- We recommend setting a new Bluetooth PIN code using the Printer Setting Tool to protect your printer from unauthorized access.

>> [PJ-862/PJ-863](#)

>> [PJ-883](#)

### PJ-862/PJ-863

1. Press the Bluetooth button  on your printer to turn the Bluetooth function on.



The Bluetooth indicator  starts flashing in blue  once every three seconds.





2. Use your device's Bluetooth management software to discover the printer. Select the printer's name.

When the connection is established, the Bluetooth indicator  lights in blue .



### PJ-883

1. Press the Bluetooth and Wi-Fi button  on your printer to turn the Bluetooth function on.

- Make sure the Bluetooth and Wi-Fi indicator  starts flashing in blue  or cyan  once every three seconds.

- If the Bluetooth and Wi-Fi indicator  is flashing in green , press and hold the Bluetooth and Wi-Fi button  for about three seconds. The flashing color changes each time you press and hold the Bluetooth and Wi-Fi button .

2. Use your device's Bluetooth management software to discover the printer. Select the printer's name.

When the connection is established, the Bluetooth and Wi-Fi indicator  lights in blue  or cyan .

### ✓ Related Information

- [Connect the Printer to a Computer or Mobile Device](#)

#### Related Topics:

- [Communication Settings of the Printer Setting Tool \(Windows\)](#)
- [Change Printer Settings Using the Printer Setting Tool \(Mac\)](#)

## Connect the Printer to a Mobile Device Using NFC (Android)

**Related Models:** PJ-862/PJ-863/PJ-883

1. Confirm that the printer's Bluetooth settings and the mobile device's Bluetooth and NFC settings are enabled.
2. Touch your mobile device to the NFC symbol on printer.

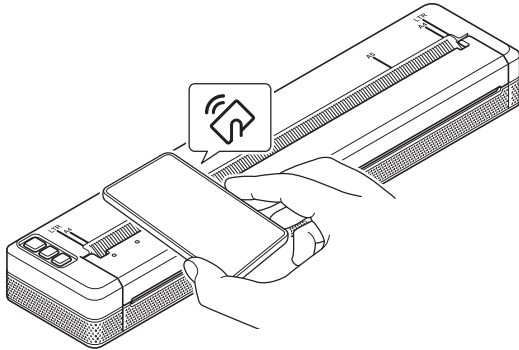

Not all Android devices may connect to your printer successfully. Check with your mobile device's User's Guide for more information.



### Related Information

- [Connect the Printer to a Computer or Mobile Device](#)





## Create and Print Documents Using Your Computer

- [Create Labels Using P-touch Editor \(Windows\)](#)
- [Print Documents Using P-touch Editor \(Windows\)](#)
- [Create and Print Custom Documents Using P-touch Editor \(Mac\)](#)
- [Print Documents without Installing Software and Drivers](#)
- [Print a Document Using the Printer Driver \(Windows/Mac\)](#)

## Create Labels Using P-touch Editor (Windows)

To use your printer with your computer, install P-touch Editor and the printer driver on your computer. For the latest drivers and software, go to your model's **Downloads** page on the Brother support website at [support.brother.com](http://support.brother.com).

1. Start P-touch Editor .
  - **Windows 10/Windows Server 2016/Windows Server 2019/Windows Server 2022:**  
Click **Start > Brother P-touch > P-touch Editor**, or double-click the **P-touch Editor** icon on the desktop.
  - **Windows 8.1/Windows Server 2012/Windows Server 2012 R2:**  
Click the **P-touch Editor** icon on the **Apps** screen, or double-click the **P-touch Editor** icon on the desktop.
2. Do one of the following:
  - To open an existing layout, click **Open** (1).
  - To connect a preset layout to a database, select the checkbox next to **Connect Database** (2).
  - To create a new layout, click **New Layout** (3), and then click  (4).

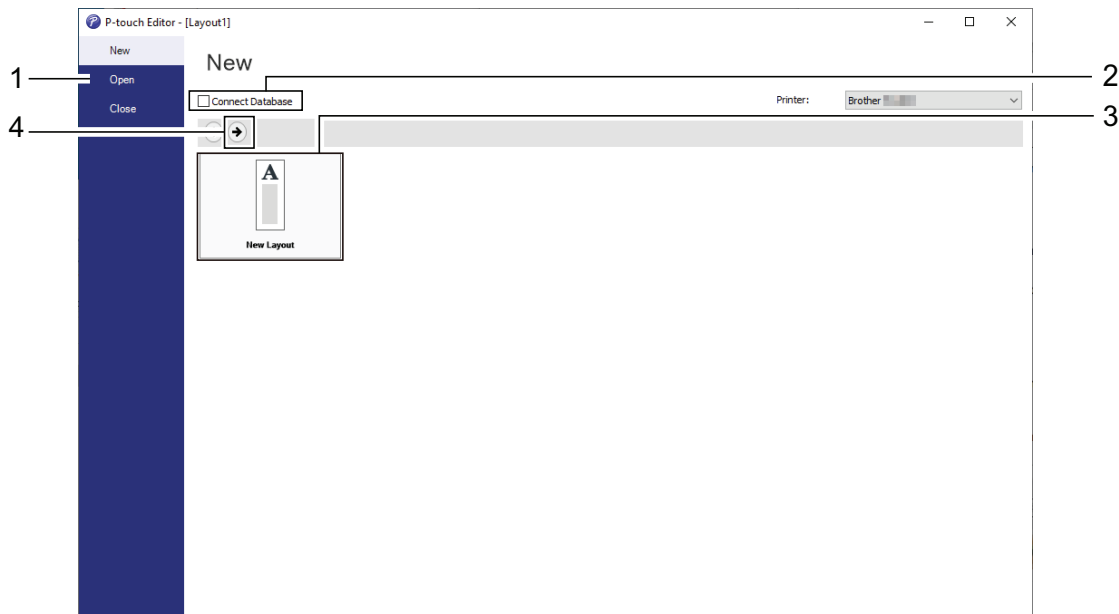

To customize the appearance of P-touch Editor's startup screen, click **Tools > Options** in the P-touch Editor menu bar to display the **Options** dialog box. On the left side, select the **General** heading, and then the setting you want in the **Operations** list box under **Startup Settings**.



### Related Information

- [Create and Print Documents Using Your Computer](#)
  - [Main Window of P-touch Editor Express Mode \(Windows\)](#)
  - [Main Window of P-touch Editor Professional Mode \(Windows\)](#)
  - [Main Window of P-touch Editor Snap Mode \(Windows\)](#)

## Main Window of P-touch Editor Express Mode (Windows)

Express mode allows you to quickly create layouts including text and images.

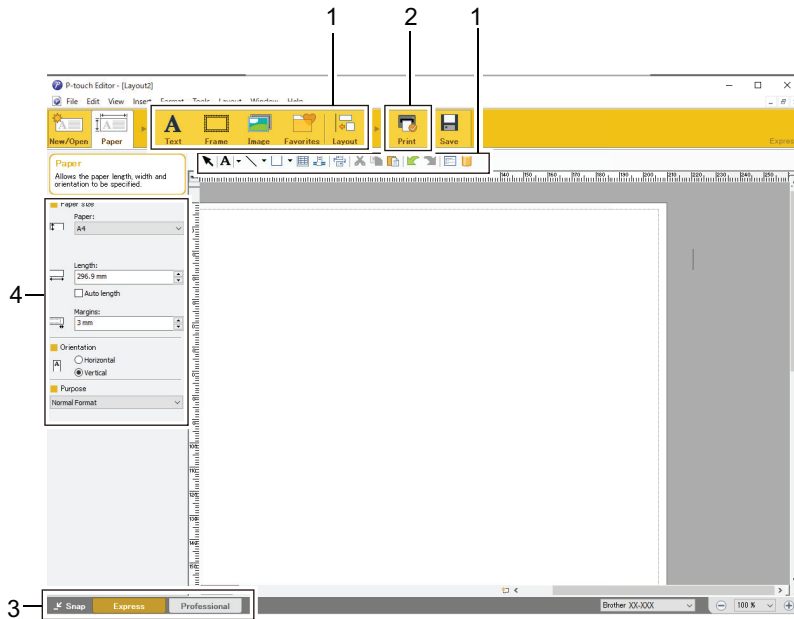

1. Edit Buttons
2. Print Button
3. Operation Mode Selection Buttons
4. Property Palettes



### Related Information

- [Create Labels Using P-touch Editor \(Windows\)](#)

## Main Window of P-touch Editor Professional Mode (Windows)

Professional mode allows you to create layouts using a wide-range of advanced tools and options.

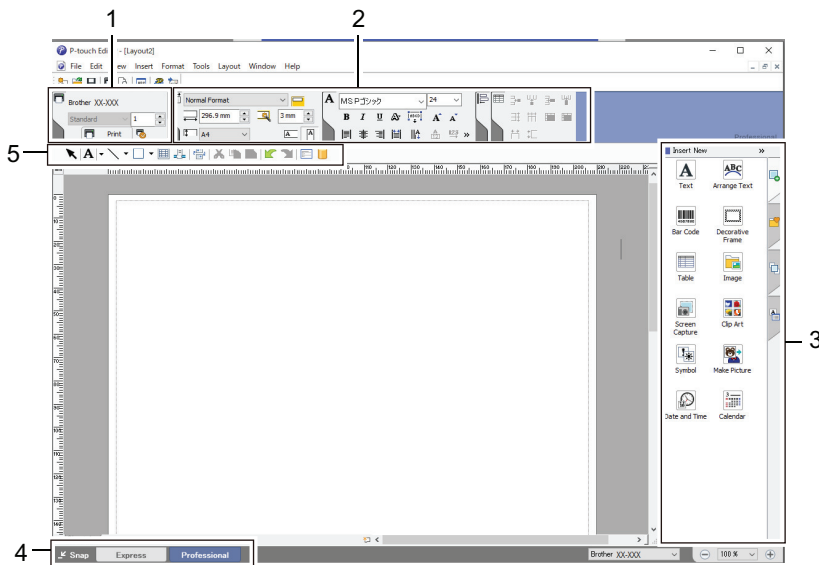

1. Print Menu
2. Property Palettes
3. Sidebar
4. Operation Mode Selection Buttons
5. Edit Toolbars

### ✓ Related Information

- [Create Labels Using P-touch Editor \(Windows\)](#)

## Main Window of P-touch Editor Snap Mode (Windows)

Snap mode allows you to capture all or a portion of your computer screen and print it as an image.

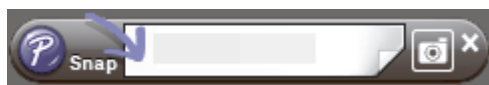
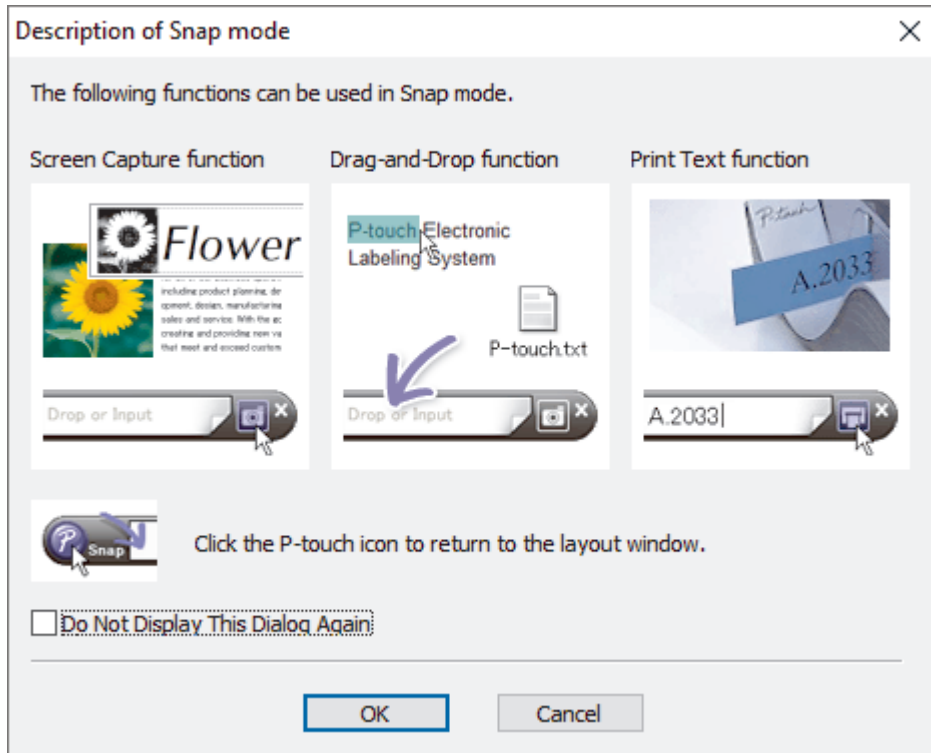

### ✓ Related Information

- [Create Labels Using P-touch Editor \(Windows\)](#)

## Print Documents Using P-touch Editor (Windows)

- >> [Express Mode](#)
- >> [Professional Mode](#)
- >> [Snap Mode](#)

### Express Mode



Configure the settings in the Print screen before printing.

Click **File** > **Print** from the menu bar, or click  (**Print**).

### Professional Mode

Configure the settings in the Print screen before printing.

Click **File** > **Print** from the menu bar, or click .

 Click  to start printing without changing the settings.

### Snap Mode

Enter the text, and then click .

### ✓ Related Information

- [Create and Print Documents Using Your Computer](#)

## Create and Print Custom Documents Using P-touch Editor (Mac)

Download and install P-touch Editor from the App Store on your Mac.

1. Double-click **Macintosh HD > Applications**, and then double-click the **Brother P-touch Editor** icon.
2. When P-touch Editor starts, click **New** to create a new layout or open an existing layout.

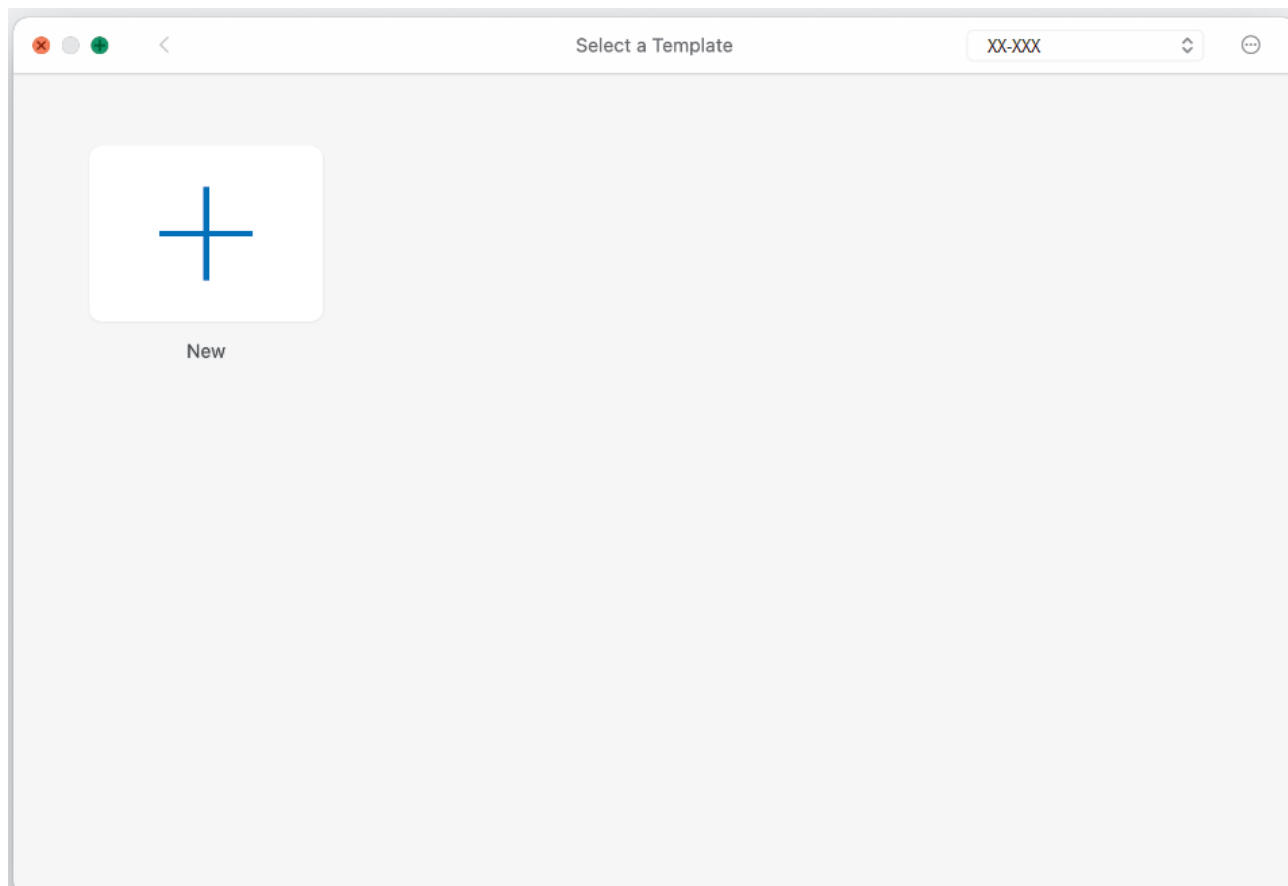

3. Click the **Print** icon.

### ✓ Related Information

- [Create and Print Documents Using Your Computer](#)

## **Print Documents without Installing Software and Drivers**

- [Print Using the USB Interface \(Mass Storage Mode\)](#)
- [Notes on Printing Image Data without Using the Printer Driver](#)







## Print Using the USB Interface (Mass Storage Mode)

Mass Storage mode allows you to send a file to the printer using the USB interface, without installing the printer driver. This feature supports only BIN, BLF, and JPG files, and can store a maximum of 16 MB.

This feature is useful for:

- Applying printer settings saved in a command file (BIN file format) and adding templates (BLF file format) into your printer without using any software tools. Both types of files must be distributed by an administrator.
- Executing commands without installing the printer driver.
- Using a device with an operating system (including non-Windows operating systems) supporting a USB host feature to print and transmit data.

1. Confirm that the printer is turned off.
2. Press the Feed button  and the Power button  at the same time.

The printer starts up in Mass Storage mode. The Power and Data indicators light in green  (if the battery is used to power the printer, the Power indicator lights in orange ).

3. Connect the computer or mobile device to the printer using a USB cable.  
The printer's mass storage area appears as a folder on the computer's or device's screen.



If the mass storage area does not appear automatically, see the instructions for the operating system of your computer or mobile device for information about accessing the mass storage area.

4. Drag and drop the file you want to copy to the mass storage area.
5. Load paper and press the Power button .

The command file is executed. The Data indicator flashes in green .

6. To deactivate the Mass Storage mode, turn off the printer.  
The printer restarts in its normal operating mode.

### NOTE

- When the printer is turned off, Mass Storage mode is deactivated and any files in the mass storage area are deleted.
- Do not create folders in the mass storage area. If a folder is created, the files in the folder cannot be accessed.
- Depending on file size, commands may fail. If this happens, work with one file at a time.
- Only the USB connection mode is available while the printer is in Mass Storage mode.
- Do not access other files in the mass storage area while copying a file to or from that area.



### Related Information

- [Print Documents without Installing Software and Drivers](#)

## Notes on Printing Image Data without Using the Printer Driver

Mass Storage mode supports JPEG image printing. The printer converts color JPEG files to black and white using the dithering process, which could result in fuzzy images. To improve image quality, avoid or turn off any functions that preprocess images.



PJ-862/PJ-863/PJ-883:

Your printer supports an Object Push Profile (OPP) when printing via Bluetooth.

- Only JPEG images can be printed, that is, this function is limited to files with the .jpg extension.
- The maximum file size is 15.8 MB.
- The maximum resolutions are as follows:
  - PJ-822/PJ-862  
Height × Width = 1600 × 2200 dots
  - PJ-823/PJ-863/PJ-883  
Height × Width = 2400 × 3300 dots

If these limits are exceeded, the data received by the printer is discarded and not printed.

- Print is at 1 pixel = 1 dot.
- The printer performs binary processing (simple binary) to print the image.
- The image is printed with the height-to-width proportions of the received data.



### Related Information

- [Print Documents without Installing Software and Drivers](#)

## Print a Document Using the Printer Driver (Windows/Mac)

>> Windows

>> Mac

### Windows

1. Open the document you want to print.
2. Connect the printer to a computer using USB, Bluetooth or Wi-Fi.
3. Load paper.
4. Select the print command in your application.
5. Select your printer, and then click the printing properties or preferences button.  
The printer driver window appears.
6. Change the printer driver settings, if needed.
7. Click **OK**.
8. Complete your print operation.

The Data indicator flashes in green  to indicate that the printer is receiving data.



- If paper is loaded and the Data indicator remains green  without flashing, the printer has not received enough data to print an entire page. Turn the printer off, and then turn it on again.
- If the paper is skewed after the printer pulls it into the starting position, open the Release Cover completely, remove the paper, and then close the cover and load the paper again.
- To print a JPEG image without using the printer driver, see *Related Topics*: Notes on Printing Image Data without Using the Printer Driver.

### Making Prints Lighter or Darker

You can make prints lighter or darker by adjusting the print density setting in the printer driver's dialog box, or in the Printer Setting Tool.

For more information, see *Related Topics*: Change Printer Settings Using the Printer Setting Tool (Windows).

### Mac



#### PJ-883:

If the AirPrint printer driver is selected, select the CUPS printer driver.

1. Select **System Preferences** from the Apple menu.
2. Click **Printers & Scanners**.
3. Select your printer from the printer list and check the printer driver in use.
  - a. Click the + button below the printer list.
  - b. Select your printer, and then select "a model name + CUPS" from the **Use** pop-up menu.
  - c. Click **Add**.

1. Open the document you want to print.
2. Connect the printer to a computer using USB, Bluetooth or Wi-Fi.
3. Load paper.
4. Select the print command in your application.
5. Select your printer, and then click the printing properties or preferences button.  
The printer driver window appears.
6. Change the printer driver settings, if needed.

- 
7. Click **OK**.
  8. Complete your print operation.

The Data indicator flashes in green  to indicate that the printer is receiving data.



- 
- If paper is loaded and the Data indicator remains green  without flashing, the printer has not received enough data to print an entire page. Turn the printer off, and then turn it on again.
  - The paper can be loaded after the print job has been sent. If the paper is skewed after the printer pulls it into the starting position, open the Release Cover completely, remove the paper, and then close the cover and load the paper again.
  - To print a JPEG image without using the printer driver, see *Related Topics: Notes on Printing Image Data without Using the Printer Driver*.
- 

### **Making Prints Lighter or Darker**

You can make prints lighter or darker by adjusting the print density setting in the printer driver's dialog box, or in the Printer Setting Tool.

For more information, see *Related Topics: Change Printer Settings Using the Printer Setting Tool (Mac)*.



### **Related Information**

- [Create and Print Documents Using Your Computer](#)
  - [Print Settings \(Windows\)](#)
  - [Print Settings \(Mac\)](#)

#### **Related Topics:**

- [Notes on Printing Image Data without Using the Printer Driver](#)
  - [Change Printer Settings Using the Printer Setting Tool \(Windows\)](#)
  - [Change Printer Settings Using the Printer Setting Tool \(Mac\)](#)
-

## Print Settings (Windows)

- >> Basic Tab
- >> Advanced Tab
- >> Print Profiles Tab

### Basic Tab

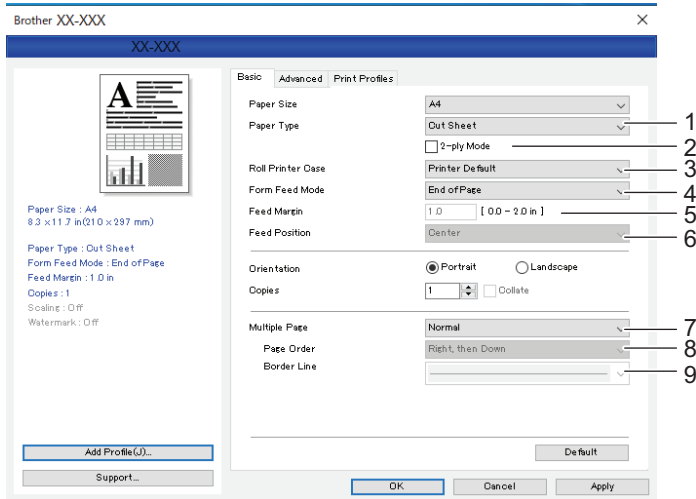

#### 1. Paper Type

Specify the type of paper that is loaded.

#### 2. 2-ply Mode

Specify the setting for using 2-ply paper.

#### 3. Roll Printer Case

Specify the setting for using the optional roll printer case. Depending on the selected option, you can adjust the feed value or amount of paper retraction for the roll printer case.

Option	Description
<b>Printer Default</b>	Select this option when using the printer settings as-is.
<b>None</b>	Select this option when not using the roll printer case.
<b>PA-RC-001</b>	Select this option when using the anti-curl mechanism while using the roll printer case.
<b>PA-RC-001 (Without Anti Curl)</b>	Select this option when not using the anti-curl mechanism while using the roll printer case.
<b>PA-RC-001 (Short Feed)</b>	Using the roll printer case with paper passed through the anti-curl mechanism causes the paper to have pressure marks. Use this option to make sure the pressure marks are not printed.

#### 4. Form Feed Mode

Specify how the printer responds to form feed commands received from any source.

##### No Feed/Feed Margin

If **Feed Margin** is set to **0**, paper is not fed at the end of a job. If a value is entered for **Feed Margin**, paper is fed at the end of the job in the amount of that value. Use this setting when printing on non-perforated roll paper. Make sure to set **Paper Type** to **Roll**.

## Fixed Page

Paper is fed at the end of a job to suit the vertical length of the selected page size (for example: letter, legal, A4, or user-defined size). Select this setting when using roll paper. Make sure to set **Paper Type** to **Roll**.

## End of Page

Paper is fed until the paper sensor detects a pre-printed end-of-page mark on the paper or the end of the sheet, or until 14" (355.6 mm) of paper has been fed. Use this setting when **Paper Type** is set to **Cut Sheet** or **Perforated Roll**.

## End of Page Retract

Paper is fed until the paper sensor detects a pre-printed end-of-page mark on the paper. Then, the paper is fed back to the starting position before the next page is printed. Use this setting when **Paper Type** is set to **Perforated Roll**.

## 5. Feed Margin

Specify the feed margin of the print job. Use this setting when **Form Feed Mode** is set to **No Feed/Feed Margin**.

## 6. Feed Position

Specify the paper feed position for printing on custom paper.

## 7. Multiple Page

Select to print more than one page on a single sheet of paper.

## 8. Page Order

Specify the page order when a setting other than **Normal** is specified for **Multiple Page**.

## 9. Border Line

Specify the border line between pages when a setting other than **Normal** is specified for **Multiple Page**.

## Advanced Tab

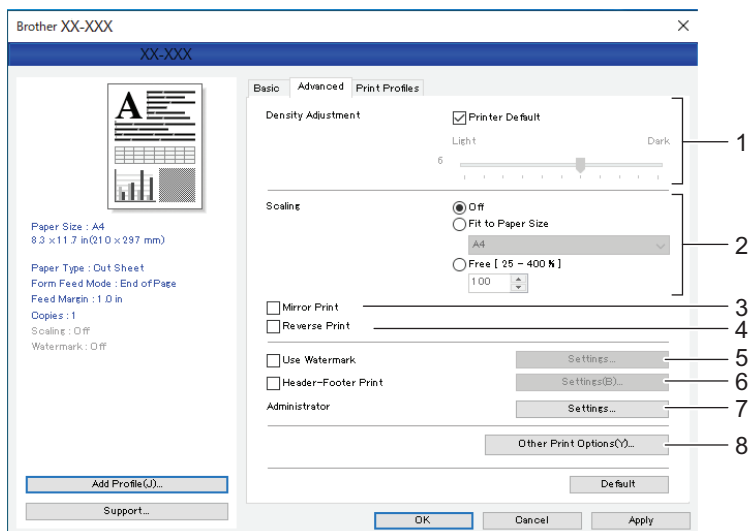

## 1. Density Adjustment

Select the printing density.

## 2. Scaling

Specify the reduction or enlargement ratio for printing.

## 3. Mirror Print

Select to print your document in reverse.

## 4. Reverse Print

Select to rotate your document 180 degrees.

## 5. Use Watermark

Select to print a logo or text as a watermark on your document. You can use preset watermarks, add a new watermark, or use an image file you have created.

## 6. Header-Footer Print

Select to print the date, time, and ID in the header or footer.

## 7. Administrator

Select to lock the following settings so that they cannot be changed.

- Copy Count
- Multi Page & Scaling
- Watermark
- Header-Footer Print

## 8. Other Print Options

### Print Text in Black

Select to print color text in black.

### Halftoning

Select a halftone processing method.

### Dash Line Print

Select to print dash lines between pages, which is useful when printing on roll paper. Set **Form Feed Mode** to **Fixed Page** and **Paper Type** to **Roll**, and then select the **Dash Line Print** checkbox. Note that dash lines are printed on the paper; they are not punched into the paper.

### Automatically Switch Command Mode

Specify whether the mode switching command is automatically sent when the commands are switched while using the printer.

We recommend that you enable this mode by selecting the checkbox.

### Print Speed

Select the printer's printing speed. Reducing the printing speed improves the print quality.

Option	Description
1.1 ips / 27 mm/s	Select these options when you want to prioritize image quality.
1.9 ips / 48 mm/s	
2.7 ips / 70 mm/s	
3.5 ips / 90 mm/s	This setting balances speed and image quality. Select this option when printing standard documents.
Fast (Draft Quality)	Speed priority mode. Select this option when printing documents containing bold text.
Fast (Line Conversion)	Speed priority mode. Select this option when printing documents with ruled pages or bold text.

### Data Compression

Select to compress print data and send it to the printer.

We recommend you select the checkbox for this item.

### Roll Paper Pause

During the pause before printing the next sheet, a message appears for you to confirm if you want to proceed with printing.

### Print Archive

Select to save print data as a PDF file to your computer.

## Print Profiles Tab

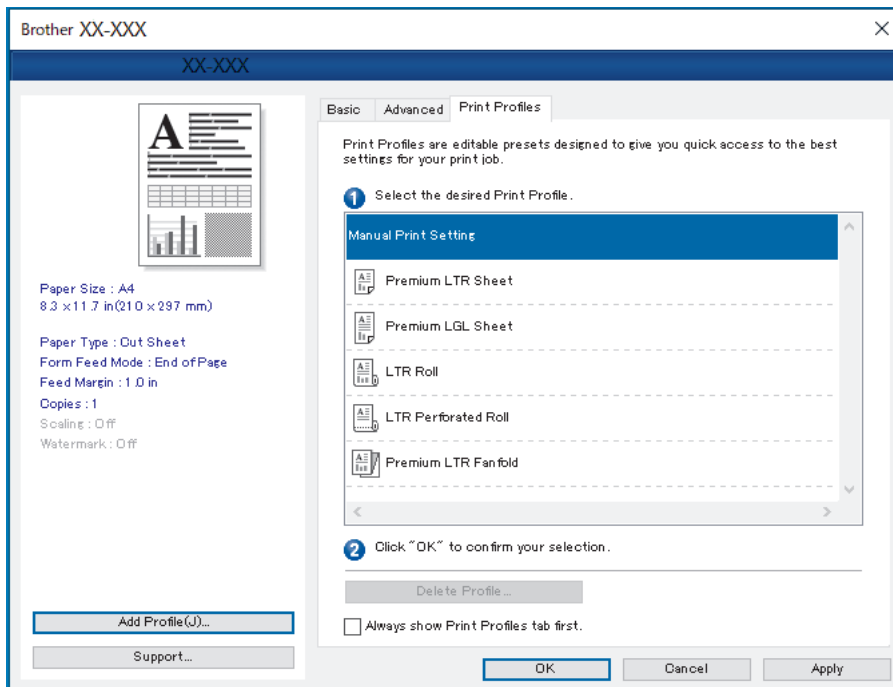

Print Profiles are presets designed to give you quick access to frequently used printing configurations. Frequently used printing settings can be added as Print Profiles.



### Related Information

- [Print a Document Using the Printer Driver \(Windows/Mac\)](#)



## Print Settings (Mac)

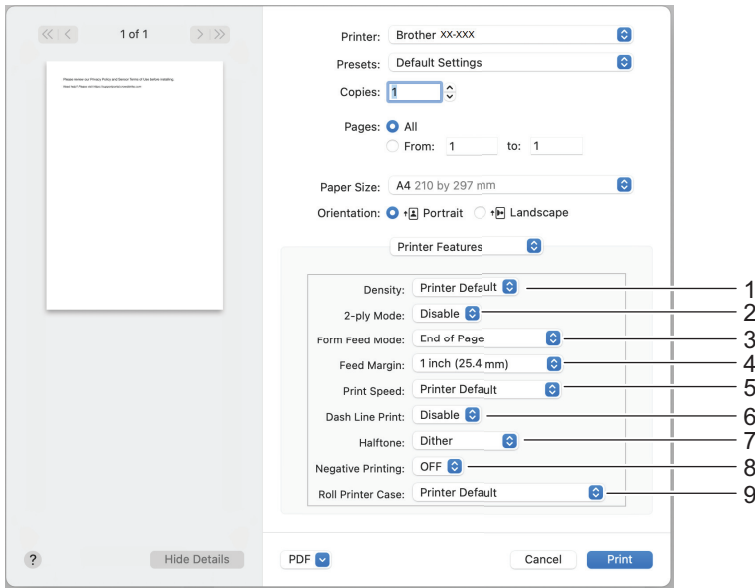

### 1. Density

Select the printing density.

### 2. 2-ply Mode

Specify the setting for using 2-ply paper.

### 3. Form Feed Mode

Specify how the printer responds to form feed commands received from any source.

### 4. Feed Margin

Specify the feed margin of the print job. Use this setting when **Form Feed Mode** is set to **No Feed / Feed Margin**.

### 5. Print Speed

Select the printer's printing speed. Reducing the printing speed improves the print quality.

Option	Description
<b>1.1 ips / 27 mm/s</b>	Select these options when you want to prioritize image quality.
<b>1.9 ips / 48 mm/s</b>	
<b>2.7 ips / 70 mm/s</b>	
<b>3.5 ips / 90 mm/s</b>	This setting balances speed and image quality. Select this option when printing standard documents.
<b>Fast (Draft Quality)</b>	Speed priority mode. Select this option when printing documents containing bold text.
<b>Fast (Line Conversion)</b>	Speed priority mode. Select this option when printing documents with ruled pages or bold text.

### 6. Dash Line Print

Select to print dash lines between pages, which is useful when printing on roll paper. Set **Form Feed Mode** to **Fixed Page** and paper type to **Roll**, and then select **Enable**. Note that dash lines are printed on the paper; they are not punched into the paper.

### 7. Halftone

Select a halftone processing method.

### 8. Negative Printing

Select to print with black and white inverted.

---

## 9. Roll Printer Case

Specify the setting for using the optional roll printer case. Depending on the selected option, you can adjust the feed value or amount of paper retraction for the roll printer case.

Option	Description
Printer Default	Select this option when using the printer settings as-is.
None	Select this option when not using the roll printer case.
PA-RC-001	Select this option when using the anti-curl mechanism while using the roll printer case.
PA-RC-001 (Without Anti Curl)	Select this option when not using the anti-curl mechanism while using the roll printer case.
PA-RC-001 (Short Feed)	Using the roll printer case with paper passed through the anti-curl mechanism causes the paper to have pressure marks. Use this option to make sure the pressure marks are not printed.



### Related Information

- [Print a Document Using the Printer Driver \(Windows/Mac\)](#)
-

## Print Documents Using Mobile Devices

- [Compatible Printing Apps](#)
- [AirPrint Overview](#)
- [Mopria® Print Service](#)
- [Transfer Templates Created on a Computer to the Printer Using a Mobile Device](#)

## Compatible Printing Apps

- PJ-822/PJ-823:

You can use your printer as a stand-alone printer or connect it to an Android™ mobile device. To create and print documents directly from your mobile device, install the Brother mobile apps, and then connect your printer to your mobile device via a USB cable. You can also transfer data, such as templates, symbols, and databases created using a computer, to your printer from your mobile device via a USB cable. The cable is sold separately.
- PJ-862/PJ-863/PJ-883:

Brother offers various free apps for use with your printer, including apps to print directly from your iPhone, iPad, iPod touch, and Android™ mobile devices, and apps to wirelessly transfer data, such as templates, symbols, and databases created using a computer, to your stand-alone printer.

For more information about the mobile apps available for your printer, visit <https://support.brother.com/g/d/f5f9>.

### iOS Devices

Software	Features
Brother iPrint&Scan (PJ-862/PJ-863/PJ-883)	Brother iPrint&Scan allows you to use features of your printer directly from your mobile device. Use your iOS device to download iPrint&Scan from the App Store. Scanning is not available for your printer.
Print SDK (PJ-862/PJ-863/PJ-883)	Download the Software Development Kit (SDK) from the Brother Developer Center ( <a href="https://support.brother.com/g/s/es/dev/en/index.html">https://support.brother.com/g/s/es/dev/en/index.html</a> ).
Mobile Transfer Express (PJ-862/PJ-863/PJ-883)	This application allows you to use a mobile device to download databases and layout, which were created on a computer using P-touch Editor and saved to a cloud service, and send them to your printer. Download this Brother app from the App Store.
AirPrint (PJ-883)	Allows you to print from an Apple device (iPad, iPhone, or iPod touch) without installing additional software.
Mobile Deploy (PJ-862/PJ-863/PJ-883)	Allows you to perform updates for the settings and firmware of printers using a mobile device.  This software will send printer update files uploaded to DropBox or an HTTP(S) server to target printers. Download this Brother app from the App Store.

### Android Devices

Software	Features
Brother iPrint&Scan	Brother iPrint&Scan allows you to use features of your printer directly from your mobile device. Use your Android™ device to download iPrint&Scan from Google Play™. Scanning is not available for your printer.
Print SDK	Download the Software Development Kit (SDK) from Brother Developer Center ( <a href="https://support.brother.com/g/s/es/dev/en/index.html">https://support.brother.com/g/s/es/dev/en/index.html</a> ).
Mobile Transfer Express	This app allows you to use a mobile device to download databases and layouts, which were created on a computer using P-touch Editor and saved to a cloud service, and send them to your printer. Download this Brother app from Google Play™.
Mopria® Print Service (PJ-883)	Mopria® Print Service provides print functionality on Android™ mobile devices (Android™ version 4.4 or later) developed by the Mopria Alliance™. With this app, you can connect to the same network as the printer and print without additional setup.
Print Service Plugin	Allows you to print from an Android device.
Mobile Deploy	Allows you to perform updates for the settings and firmware of printers using a mobile device.

---

Software	Features
	This software will send printer update files uploaded to DropBox or an HTTP(S) server to target printers. Download this Brother app from Google Play™.



### Related Information

- [Print Documents Using Mobile Devices](#)
-

## AirPrint Overview

**Related Models:** PJ-883

AirPrint is a printing solution for Apple operating systems that allows you to wirelessly print photos, email, web pages and documents from your iPad, iPhone and iPod touch without the need to install a driver.

For more information, visit Apple's website.

Use of the Works with Apple badge means that an accessory has been designed to work specifically with the technology identified in the badge and has been certified by the developer to meet Apple performance standards.



### Related Information

- [Print Documents Using Mobile Devices](#)

## Mopria® Print Service

**Related Models:** PJ-883

Mopria® Print Service is a print feature on Android™ mobile devices developed by the Mopria Alliance™. With this service, you can connect to the same network as your printer and print without additional setup.

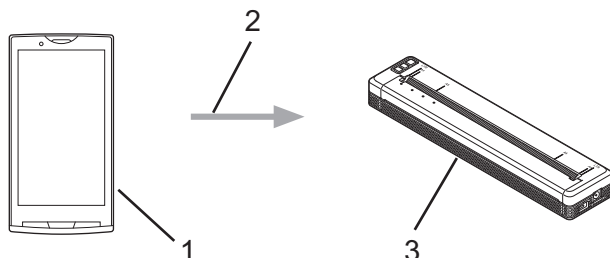

1. Android™ Mobile Device
2. Wi-Fi® Connection
3. Your Printer

You must download the Mopria® Print Service from Google Play™ and install it on your Android™ device.



### Related Information

- [Print Documents Using Mobile Devices](#)

## Transfer Templates Created on a Computer to the Printer Using a Mobile Device

Use P-touch Transfer Manager to save template data created using P-touch Editor in either BLF or PDZ format. Use Mobile Transfer Express to send the saved file from your mobile device to the printer and print it.

### NOTE

Make sure Mobile Transfer Express is installed on your mobile device.

1. Save the template data using P-touch Transfer Manager.



For more information, see *Related Topics*: [Create Transfer Files and Transfer Package Files \(Windows\)](#)

2. Do one of the following:
  - Save the file in a cloud storage service, and then share the file using the Mobile Transfer Express app on your mobile device.
  - Send the file as an email attachment from the computer to the mobile device, and then save the file to the mobile device.
3. Connect the printer to your mobile device, and then start Mobile Transfer Express.  
The template data appears.
4. Select the template you want to print, and then tap **Transfer** to transfer the template to the printer.



To download a file from a cloud storage service to your mobile device, connect your mobile device to the printer using Infrastructure Mode. This allows you to transfer downloaded files (BLF files only) faster.



### Related Information

- [Print Documents Using Mobile Devices](#)

#### Related Topics:

- [Create Transfer Files and Transfer Package Files \(Windows\)](#)
- [Connect the Printer to a Computer Using Wi-Fi](#)



## **Transfer Templates to the Printer (P-touch Transfer Manager) (Windows)**

- [Transfer Templates to the Printer Using P-touch Transfer Manager \(Windows\)](#)
- [Distribute Templates to be Transferred to Users Without Using P-touch Transfer Manager \(Windows\)](#)

## **Transfer Templates to the Printer Using P-touch Transfer Manager (Windows)**

- [Notes on Using P-touch Transfer Manager \(Windows\)](#)
- [About Transferring Templates from the Computer to the Printer \(Windows\)](#)
- [Back up Templates or Other Data Saved in the Printer \(Windows\)](#)
- [Delete Printer Data \(Windows\)](#)
- [Create Transfer Files and Transfer Package Files \(Windows\)](#)

## Notes on Using P-touch Transfer Manager (Windows)

Some P-touch Editor functions are not available with the printer, so keep the following points in mind when using P-touch Editor to create templates.

You can preview created templates before they are transferred to the printer.

### Creating Templates

- Some of the text in the templates transferred to the printer may be printed using similar fonts and character sizes loaded in the printer. As a result, the printout may differ from the image of the template created in P-touch Editor.
- Depending on the text object setting, the character size may be automatically reduced or some of the text may not be printed. If this occurs, change the Text Object setting.
- Although character styles can be applied to individual characters in P-touch Editor, styles can be applied to a block of text only from the printer. In addition, some character styles are not available on the printer.
- Backgrounds specified in P-touch Editor are not compatible with the printer.
- The P-touch Editor layout using the split printing function (enlarging the document and printing it on two or more papers) cannot be transferred.
- Only the portion of the document within the printable area is printed.

### Transferring Templates

- The printout may differ from the image appearing in the preview area of P-touch Transfer Manager.
- If a two-dimensional barcode other than a QR code not loaded on the printer is transferred to the printer, the barcode is converted into an image. The image of the converted barcode cannot be edited.
- All transferred objects that cannot be edited by the printer are converted into images.
- Grouped objects are converted into a single bitmap.
- If objects overlap, only the bottom object is printed.

### Transferring Data Other Than Templates

If the number or order of fields in a database is changed and only the database (CSV file) is transferred to update it, the database may not link correctly with the template. In addition, the first line of data in the transferred file must be recognized by the printer as "field names."



#### Related Information

- [Transfer Templates to the Printer Using P-touch Transfer Manager \(Windows\)](#)

---

Home > [Transfer Templates to the Printer \(P-touch Transfer Manager\) \(Windows\)](#) > [Transfer Templates to the Printer Using P-touch Transfer Manager \(Windows\)](#) > About Transferring Templates from the Computer to the Printer (Windows)

## About Transferring Templates from the Computer to the Printer (Windows)

You can transfer templates and other data to the printer and save backups of your data on the computer.

To use P-touch Transfer Manager, you must first transfer templates created in P-touch Editor to P-touch Transfer Manager.

### Related Information

- [Transfer Templates to the Printer Using P-touch Transfer Manager \(Windows\)](#)
    - [Transfer a Template to P-touch Transfer Manager \(Windows\)](#)
    - [Main Window of P-touch Transfer Manager \(Windows\)](#)
    - [Transfer Templates or Other Data from the Computer to the Printer \(Windows\)](#)
-



## Main Window of P-touch Transfer Manager (Windows)

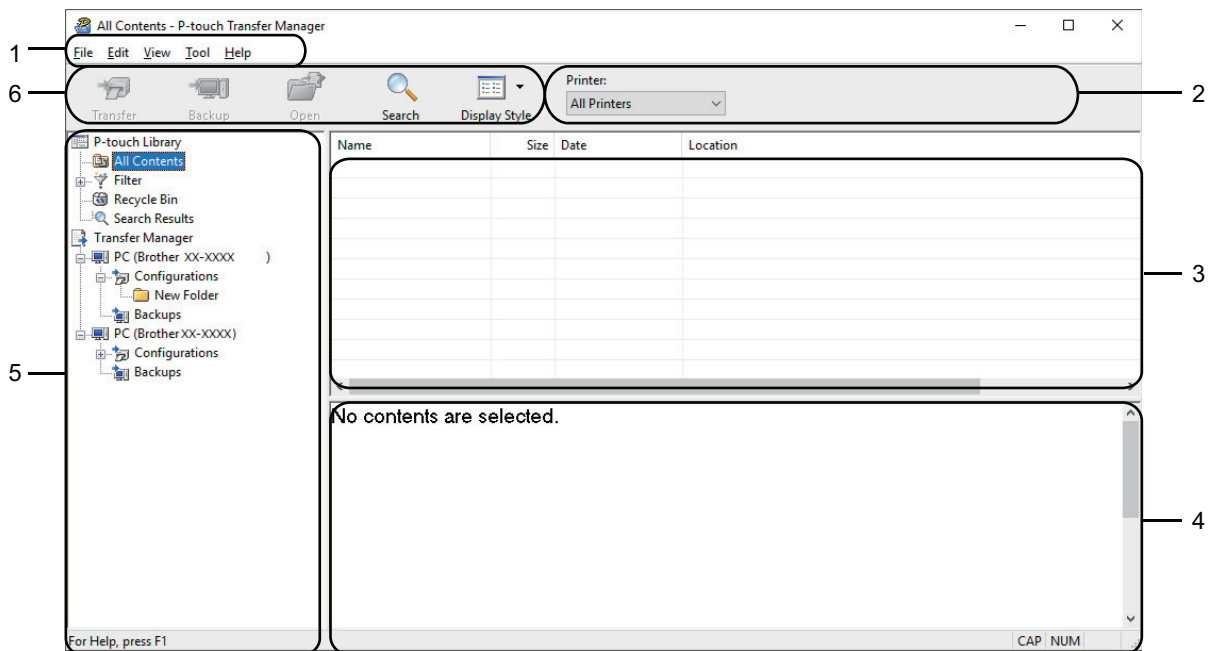

### 1. Menu Bar

Provides access to various commands grouped under each menu title (the **File**, **Edit**, **View**, **Tool**, and **Help** menus) according to their functions.

### 2. Printer Selector

Allows you to select a printer to transfer the data to. When you select a printer, only the data that can be sent to the selected printer appears in the data list.

### 3. Template List

Displays a list of templates in the selected folder.

### 4. Preview

Displays a preview of the templates in the templates list.

### 5. Folder List

Displays a list of folders and printers. When you select a folder, the templates in the selected folder appear in the template list. If you select a printer, the current templates and other data stored in the printer appear.



### 6. Toolbar

Provides access to frequently used commands.

## Toolbar Icons

Icon	Button name	Function
	<b>Transfer</b>	Click to transfer templates and other data from the computer to the printer.
	<b>Save Transfer File</b> (When not connected to a printer)	Click to change the file type of the data to be transferred to other applications. Select <b>PDZ</b> when transferring the data using Transfer Express (USB). The available interfaces may differ depending on your model.
	<b>Backup</b>	Click to retrieve the templates and other data saved in the printer and saves it on the computer.
	<b>Open</b>	Click to open the selected template.

---

Icon	Button name	Function
	<b>Search</b>	Click to search for templates or other data registered to P-touch Library.
	<b>Display Style</b>	Click to change the file display style.



### Related Information

- [About Transferring Templates from the Computer to the Printer \(Windows\)](#)
-

## Transfer Templates or Other Data from the Computer to the Printer (Windows)



To transfer templates from a mobile device to the printer, see *Related Topics*.

1. Connect the printer and the computer using a USB cable, and then turn on the printer.  
The printer model name appears next to a printer icon in the folder view.  
If you select the printer in the folder view, the current templates and other data stored in the printer appear.



If a printer is disconnected or offline, it does not appear in the folder view.

2. Select the printer you want to transfer the template or other data to.

Transfer Name	Size	Layout	Time	Key Assign	Name
name	1KB	Layout	24/10/2018 11:22:32 AM	-	name.lbx
CD	1KB	Layout	24/10/2018 3:13:35 PM	-	CD.lbx
address	1KB	Layout	24/10/2018 3:15:15 PM	-	address.lbx



3. Right-click the **Configurations** folder, select **New**, and then create a new folder.

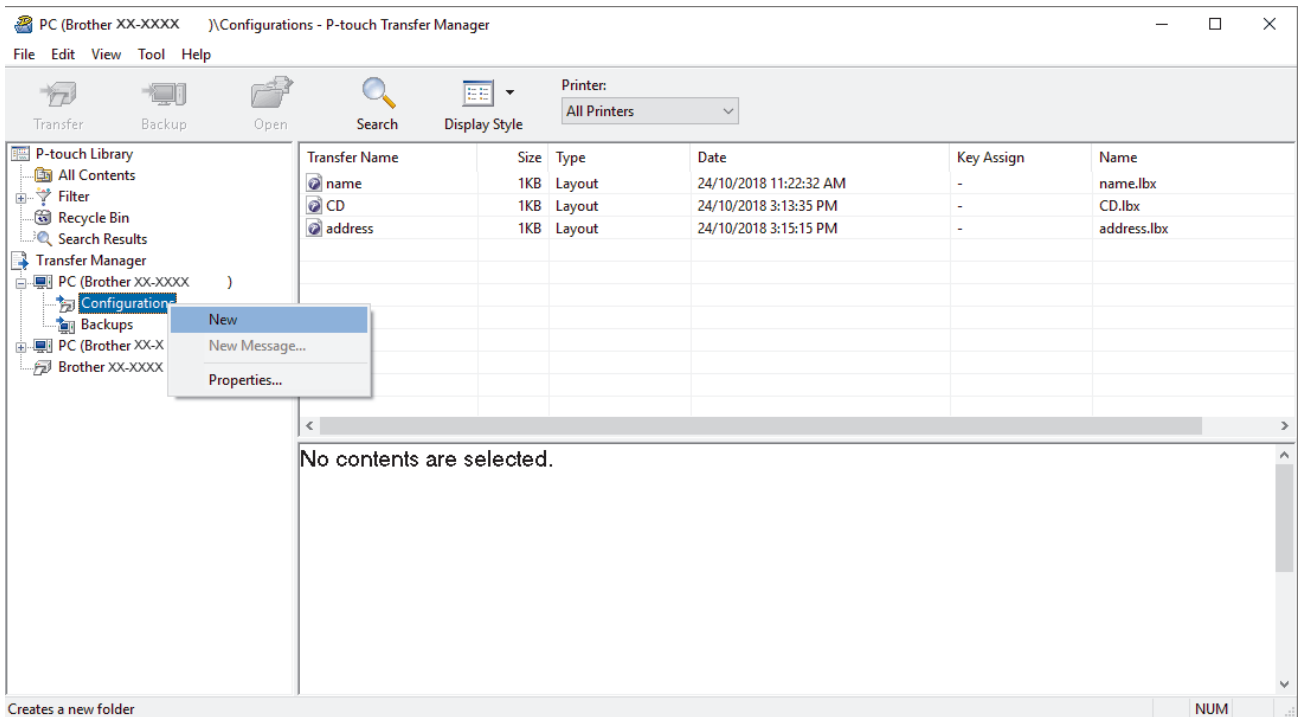

4. Do one of the following:

- Drag the template or other data you want to transfer and place it in the new folder.
- To transfer multiple templates or other data, drag the files you want to transfer, and then place them in the new folder. Each file is assigned a Key Assign number (memory location in the printer) when it is placed in the new folder.

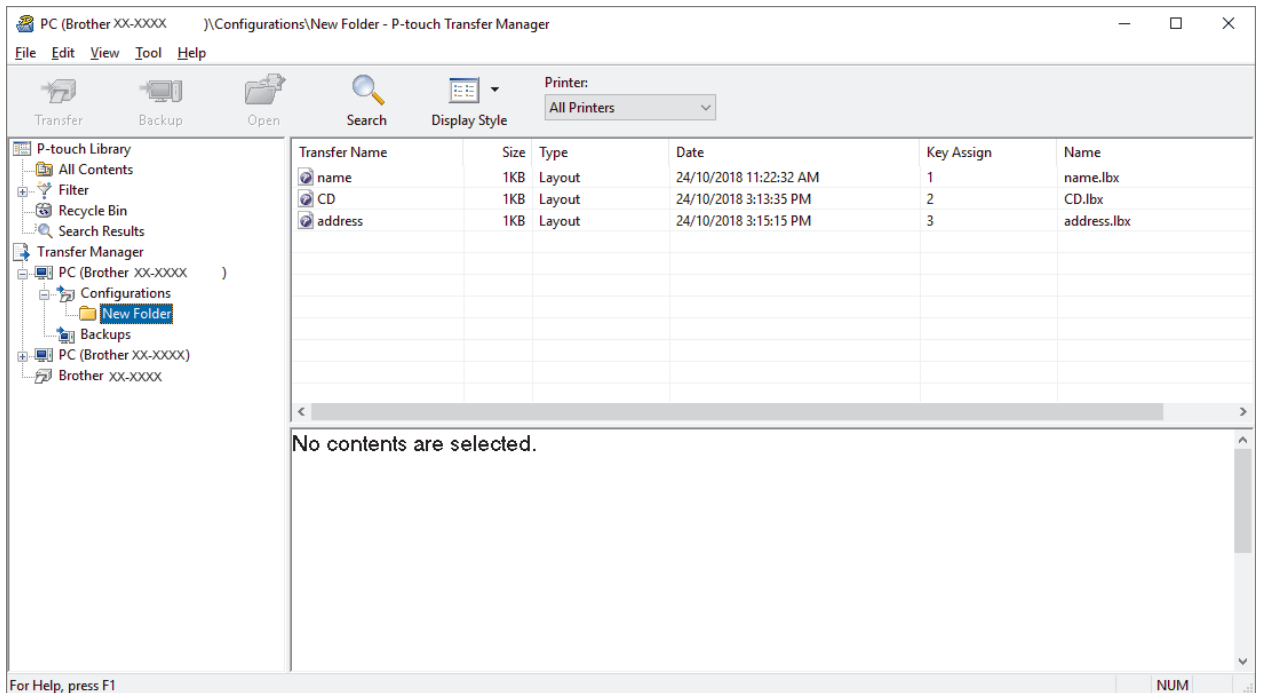

Data type	Maximum number of transferable items	Restriction details
Template	255	<ul style="list-style-type: none"> <li>• Each template can contain a maximum of 255 objects.</li> <li>• Each object can contain a maximum of seven lines.</li> </ul>
Database	20	<ul style="list-style-type: none"> <li>• Only CSV files can be transferred.</li> <li>• Each CSV file can contain a maximum of 255 fields and 65000 records.</li> </ul>

Data type	Maximum number of transferable items	Restriction details
Image (User-defined character)	99	<ul style="list-style-type: none"> <li>Only BMP files can be transferred.</li> <li>Monochrome BMP files are recommended.</li> <li>The size limit is 1632 × 1632 pixels. (PJ-822/PJ-862)</li> <li>The size limit is 2464 × 2464 pixels. (PJ-823/PJ-863/PJ-883)</li> <li>Wide images may be cropped.</li> </ul>



- You can confirm the available space in the transfer file memory by printing the configuration report. See **Available memory** in the report for the available space. The available space appearing in **Available memory: \*\*\*\*B** may be different from the actual available space.
- You can view the templates and other data by selecting:
  - The folder in the **Configurations** folder
  - All Contents**
  - One of the categories under **Filter**, such as **Layouts**

- To change the Key Assign number assigned to an item, right-click the item, select the **Key Assign** menu, and then select the Key Assign number you want.

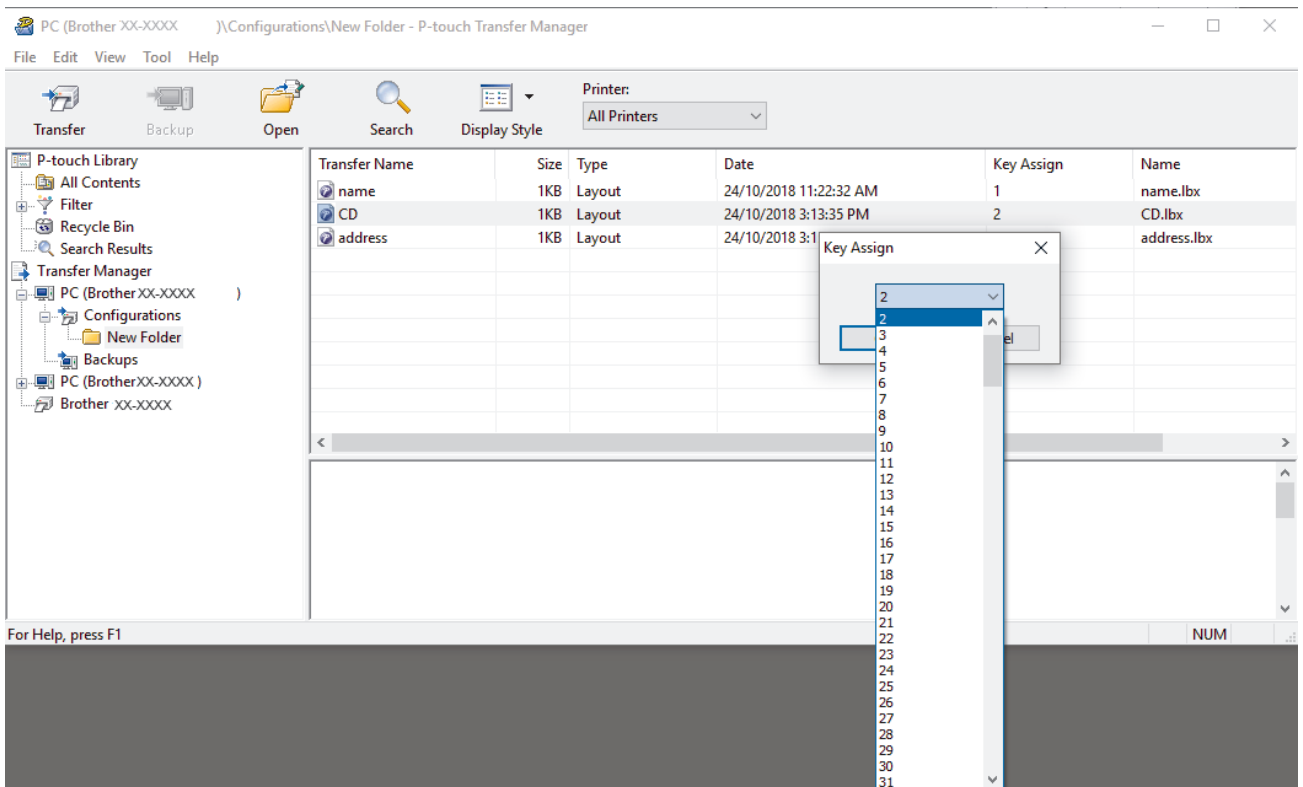

- Except for the data in databases, all data transferred to the printer is assigned a key number.
- If the template or other data transferred to the printer has the same key number as another template already saved in the printer, the new template overwrites the old one. You can confirm the assigned template numbers saved in the printer by backing up the templates or other data.
- If the printer memory is full, remove one or more templates from the printer's memory.

- To change the template names or other data you want to transfer, click the item you want, and then type the new name.

The number of characters used for the template names may be limited depending on the printer model.

7. Select the folder containing the templates or other data you want to transfer, and then click **Transfer**.

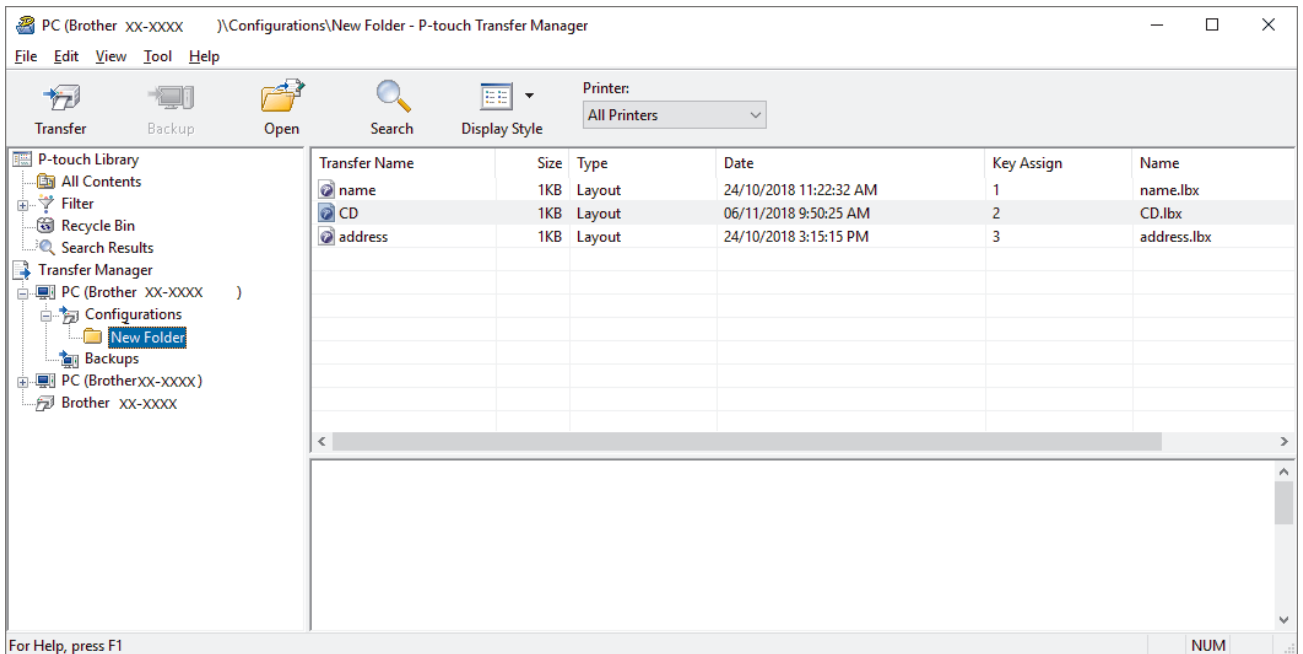

A confirmation message appears.



- You can also transfer individual items to the printer without adding them to a folder. Select the template or other data you want to transfer, and then click **Transfer**.
- Multiple items and folders can be selected and transferred in one operation.

8. Click **OK**.

The selected items are transferred to the printer.



### Related Information

- [About Transferring Templates from the Computer to the Printer \(Windows\)](#)

#### Related Topics:

- [Transfer Templates Created on a Computer to the Printer Using a Mobile Device](#)

## Back up Templates or Other Data Saved in the Printer (Windows)



- Backed up templates or other data cannot be edited on the computer.
- Depending on the printer model, backed up templates or data may not be transferable between different models.

1. Connect the computer and the printer and turn on the printer.

The printer model name appears next to a printer icon in the folder view. If you select the printer in the folder view, the current templates and other data stored in the printer appear.

2. Select the printer to back up from, and then click **Backup**.

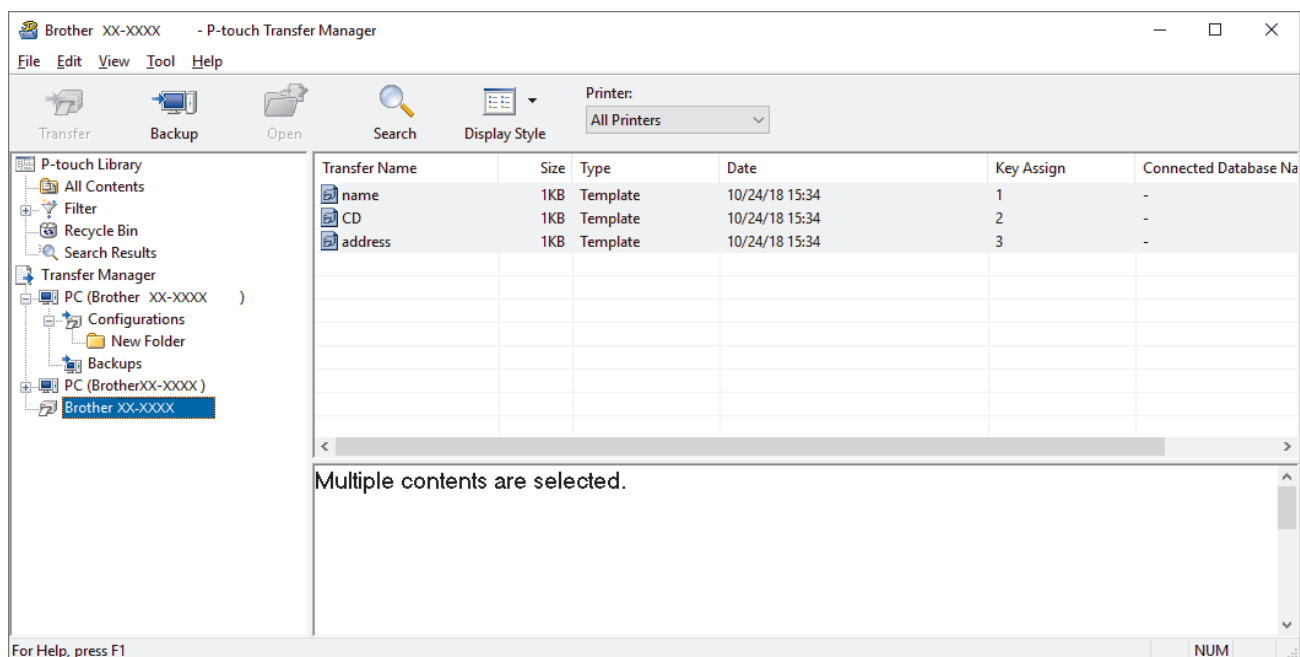

A confirmation message appears.

3. Click **OK**.

A new folder is created under the printer in the folder view. The folder name is based on the date and time of the backup. All of the printer's templates and other data are transferred to the new folder and saved on the computer.



### Related Information

- [Transfer Templates to the Printer Using P-touch Transfer Manager \(Windows\)](#)

## Delete Printer Data (Windows)

To delete all templates and other data saved on the printer, do the following:

1. Connect the computer and the printer and turn on the printer.  
The printer model name appears next to a printer icon in the folder view.
2. Right-click the printer, and then select the **Delete All** menu.

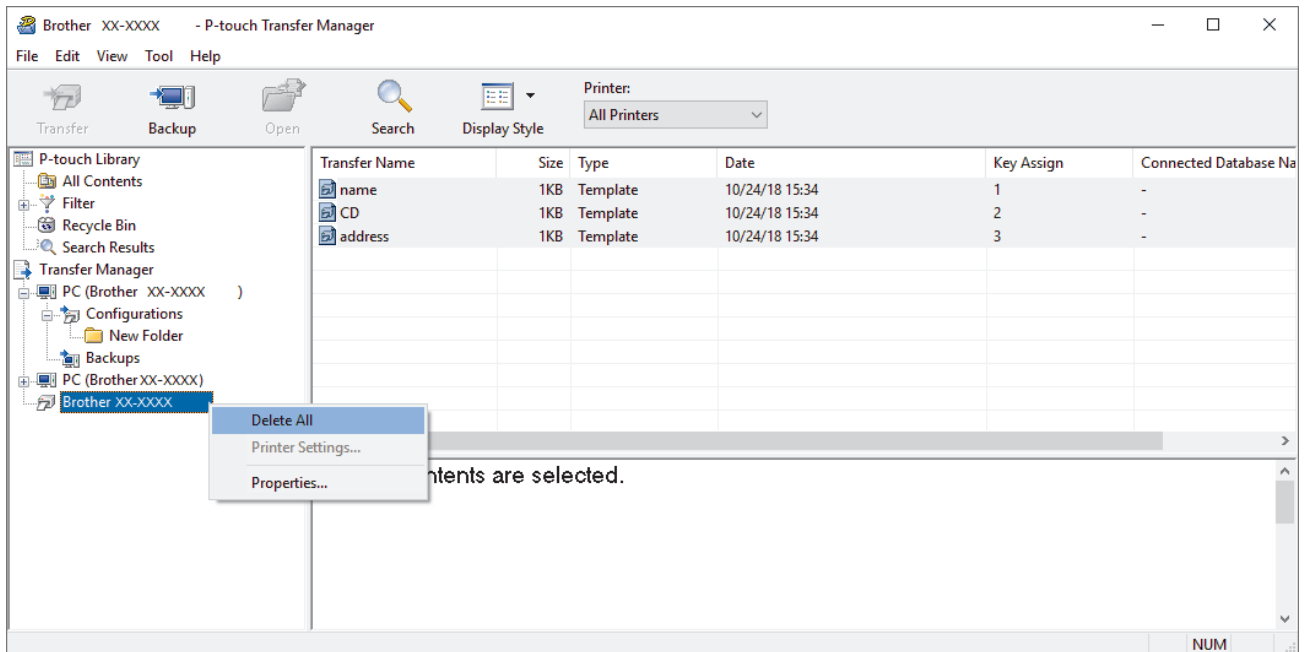

A confirmation message appears.

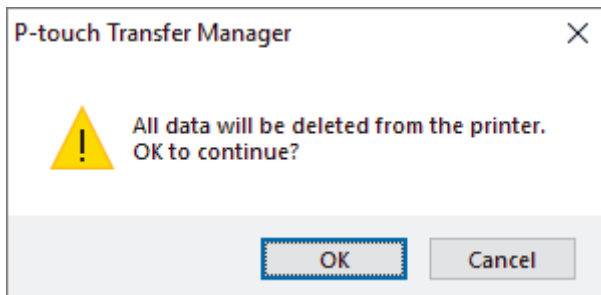

3. Click **OK**.  
All templates and other data saved on the printer are deleted.

### ✓ Related Information

- [Transfer Templates to the Printer Using P-touch Transfer Manager \(Windows\)](#)

## Create Transfer Files and Transfer Package Files (Windows)

Use P-touch Transfer Manager to save template data created using P-touch Editor in BLF or PDZ format, and transfer the files in this format to a printer from a computer or mobile device.

You can also print files in the BLF format using mass storage mode.

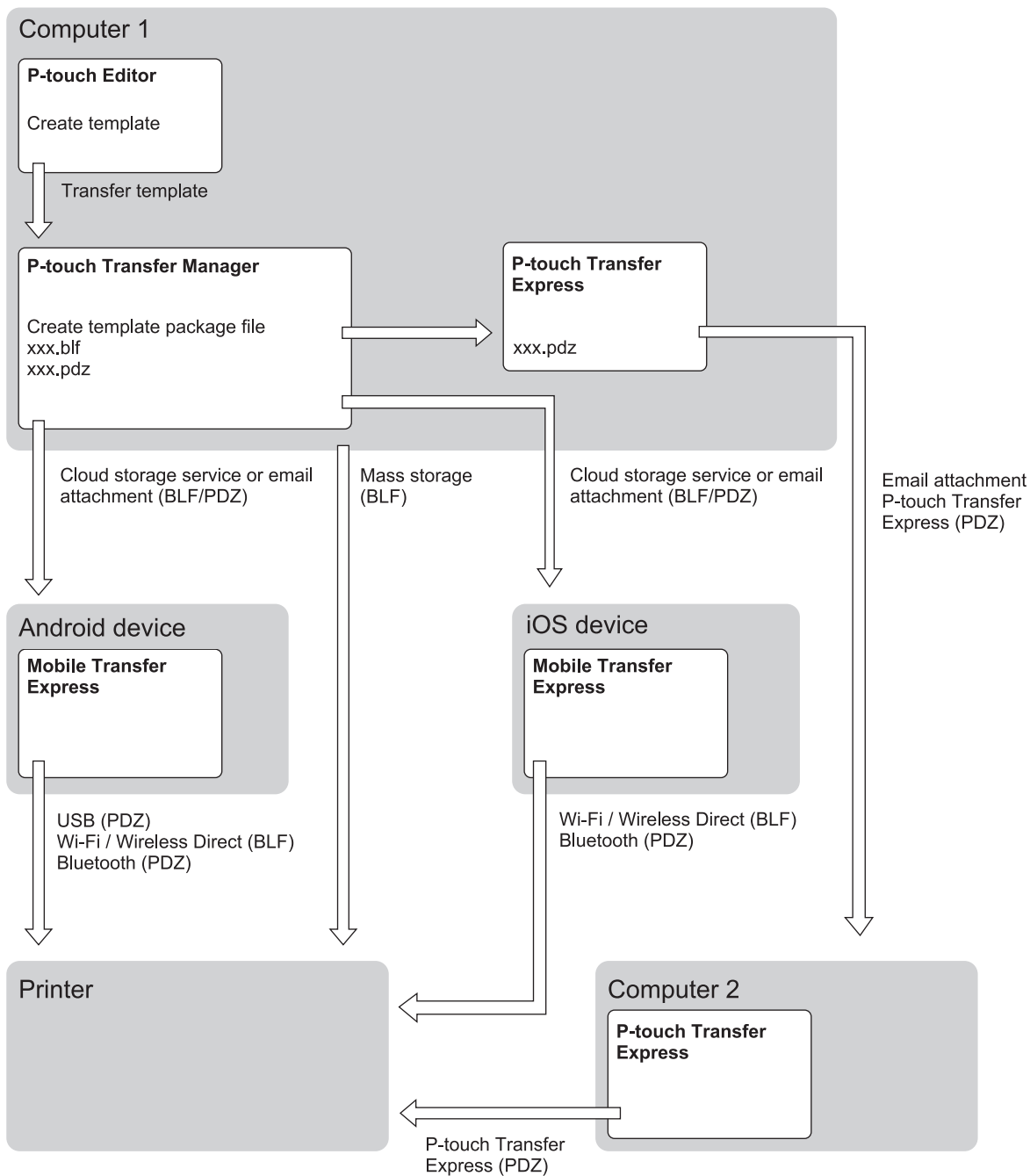

Template Transfer Method		File Format
From a mobile device (Using Mobile Transfer Express)	via USB	PDZ
	via Wi-Fi (PJ-883)	BLF
	via Wireless Direct (PJ-883)	BLF

Template Transfer Method		File Format
	via Bluetooth (PJ-862/PJ-863/PJ-883)	PDZ
	Mass storage	BLF
From a computer	P-touch Transfer Express	PDZ
	Mass storage	BLF

1. Create the template using P-touch Editor, and then transfer it to P-touch Transfer Manager.



- For more information, see *Related Topics*.
- When transferring a new template, make sure you specify a Key Assign number (in P-touch Transfer Manager) that is not currently used. If the specified Key Assign number is already being used, the existing template will be overwritten with the new one.

2. Without connecting the printer to the computer, select the **Configurations** folder in the P-touch Transfer Manager window, and then select the template to save.



You can select multiple templates at the same time.

3. Click **File > Save Transfer File**.

## NOTE

The **Save Transfer File** button appears when the printer is disconnected from the computer or offline.



- If you click the **Save Transfer File** button after selecting **Configurations**, all templates in the folder are saved as the Transfer file (BLF) or Transfer Package file (PDZ).
- You can combine multiple templates into a single Transfer file (BLF) or Transfer Package file (PDZ).

4. In the **Save as type** field, select the template format you want, and then type in the name and save the template.



## Related Information

- [Transfer Templates to the Printer Using P-touch Transfer Manager \(Windows\)](#)

### Related Topics:

- [Transfer a Template to P-touch Transfer Manager \(Windows\)](#)

## Distribute Templates to be Transferred to Users Without Using P-touch Transfer Manager (Windows)

Transfer templates to the printer using P-touch Transfer Express.

To download the latest version of P-touch Transfer Express, go to your model's **Downloads** page on the Brother support website at [support.brother.com](http://support.brother.com).



- When transferring a new template, make sure you specify a Key Assign number (in P-touch Transfer Manager) that is not currently used. If the specified Key Assign number is already being used, the existing template will be overwritten with the new one.
- This function requires a USB connection.

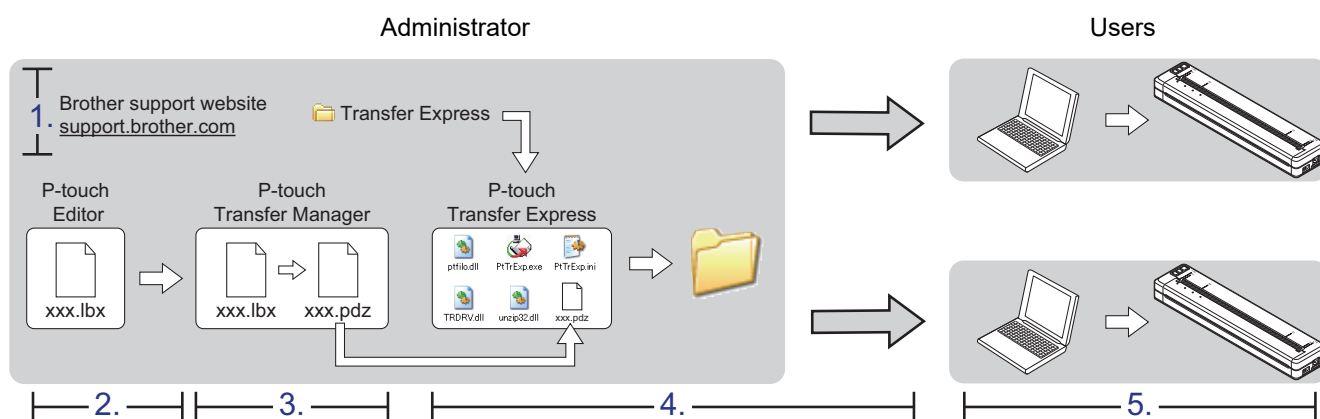

- >> [Administrator Tasks](#)
- >> [User Tasks](#)

### Administrator Tasks

- >> [Preparing P-touch Transfer Express](#)
- >> [Transfer a Template to P-touch Transfer Manager](#)
- >> [Save the Template as a Transfer Package File \(PDZ\)](#)
- >> [Distribute the Transfer Package File \(PDZ\) and P-touch Transfer Express to Others](#)

### Preparing P-touch Transfer Express

The printer driver must be installed before using P-touch Transfer Express.



P-touch Transfer Express is available only in English.

1. Download P-touch Transfer Express to any location on the computer.
2. Decompress the downloaded file (ZIP).

### Transfer a Template to P-touch Transfer Manager

1. Start P-touch Editor 
  - **Windows 10/Windows Server 2016/Windows Server 2019/Windows Server 2022:**  
Click **Start > Brother P-touch > P-touch Editor**, or double-click the **P-touch Editor** icon on the desktop.
  - **Windows 8.1/Windows Server 2012/Windows Server 2012 R2:**  
Click the **P-touch Editor** icon on the **Apps** screen, or double-click the **P-touch Editor** icon on the desktop.



2. Open the template you want.
3. Click **File > Transfer Template > Transfer**.

The following dialog box shows Express Mode, but the process to transfer the template is the same with Professional Mode.

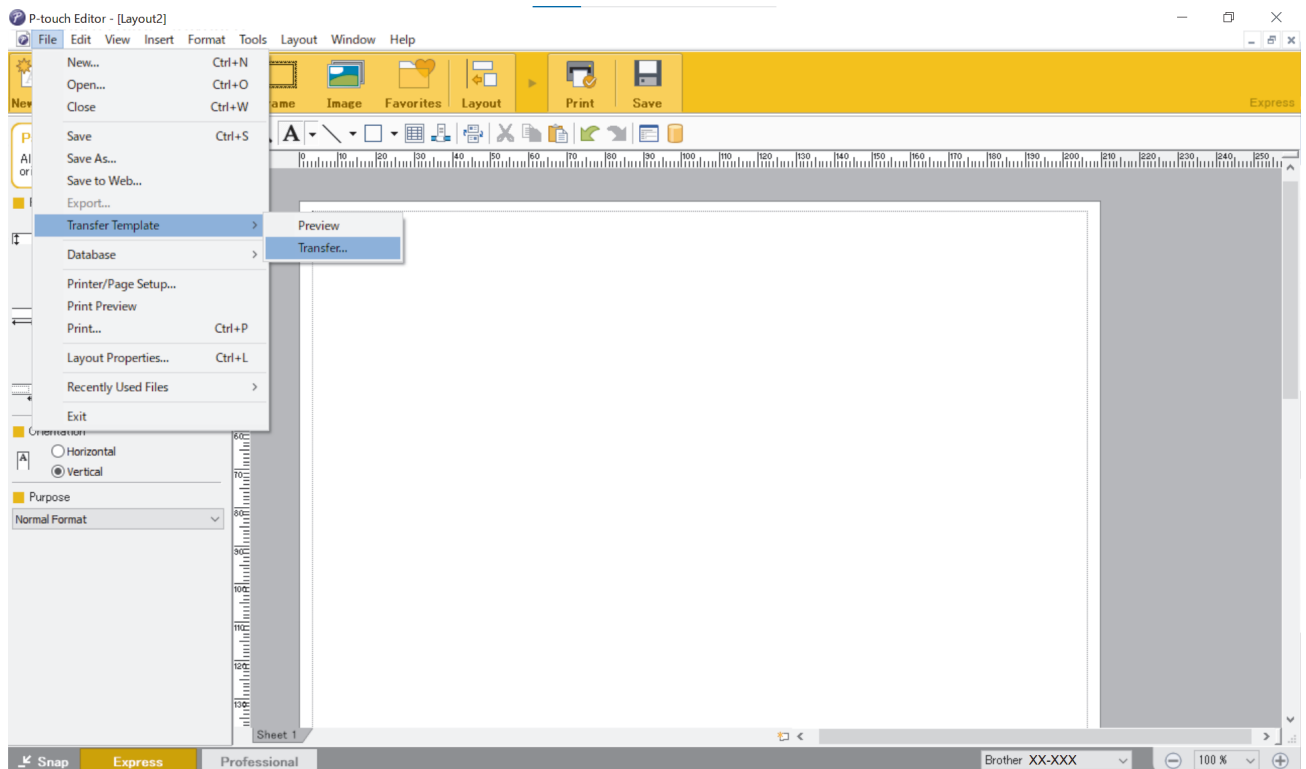

The template is transferred to P-touch Transfer Manager. P-touch Transfer Manager starts.

## Save the Template as a Transfer Package File (PDZ)

To create a file in a format that can be used by P-touch Transfer Express, save the template as a Transfer Package file (PDZ).

1. Select the **Configurations** folder in the P-touch Transfer Manager window.
2. Select the templates you want to distribute.
3. Click **File > Save Transfer File**.



- The **Save Transfer File** option appears only if the printer is disconnected from the computer or offline.
- If you click the **Save Transfer File** option after selecting the **Configurations** folder or a created folder, all templates in the folder are saved as the Transfer Package file (PDZ).
- You can combine multiple templates into a single Transfer Package file (PDZ).

4. Type the name, and then click **Save**.

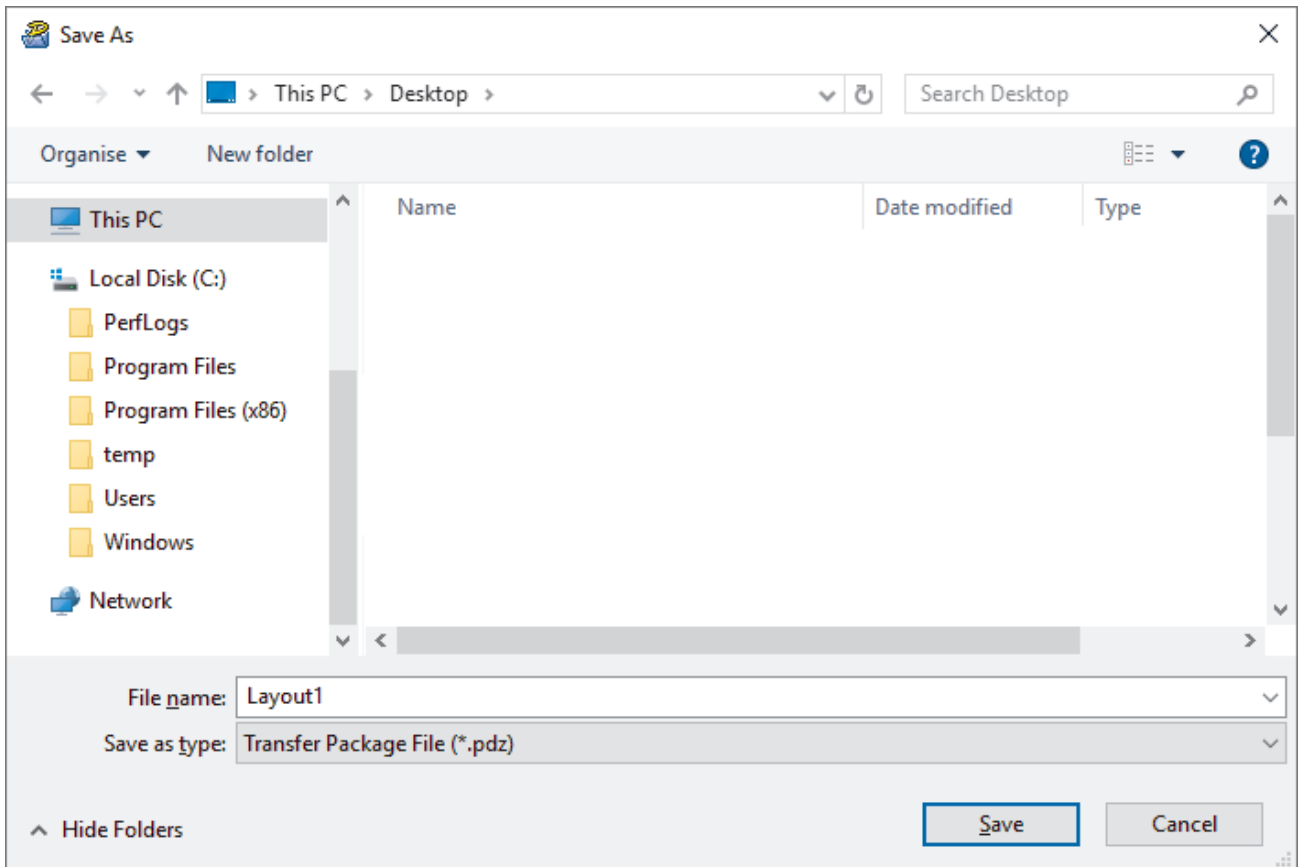

The template is saved as a Transfer Package file (PDZ).

## Distribute the Transfer Package File (PDZ) and P-touch Transfer Express to Others



If you already downloaded P-touch Transfer Express, it is not necessary for the administrator to send the Transfer Express folder. In this case, you can simply move the distributed Transfer Package file to the downloaded folder, and then double-click the **PtTrExp.exe** file.

1. Move the Transfer Package file (PDZ) to the downloads folder.

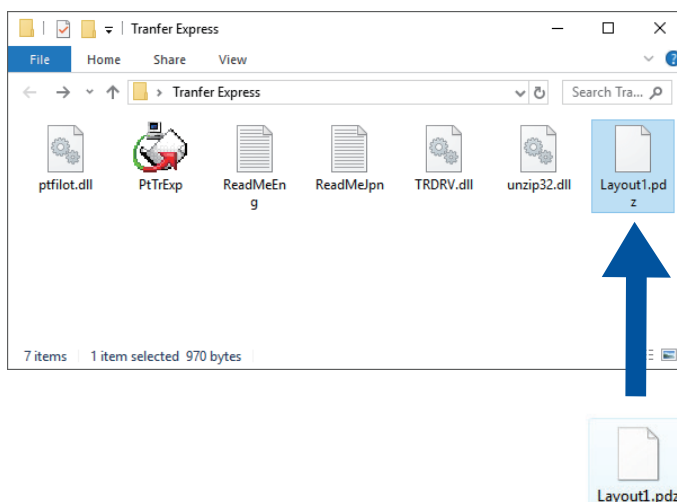

2. Distribute all the files in the downloads folder to others.

## User Tasks

### Transfer the Transfer Package File (PDZ) to Your Printer



Do not turn off the power when transferring templates.

1. Turn on the printer.
2. Connect the printer to the computer using a USB cable.
3. Double-click the **PtTrExp.exe** file received from the administrator.
4. Do one of the following:
  - To transfer a single Transfer Package file (PDZ) within the folder containing the **PtTrExp.exe** file, click **Transfer**.
  - To transfer multiple Transfer Package files (PDZ) within the folder containing the **PtTrExp.exe** file, do the following:
    - a. Click **Browse**.

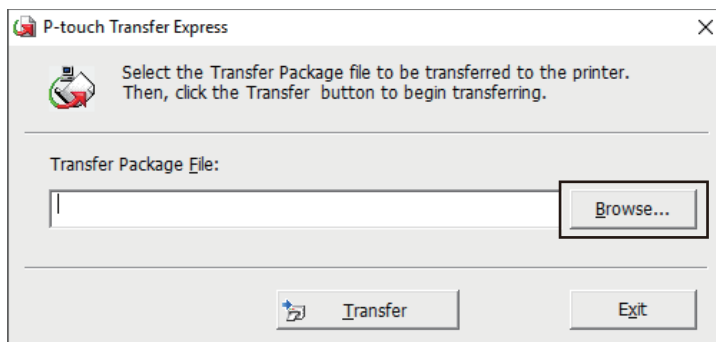

- b. Select the Transfer Package file you want to transfer, and then click **Open**.
  - c. Click **Transfer**.
  - d. Click **Yes**.
5. When completed, click **OK**.



### Related Information

- [Transfer Templates to the Printer \(P-touch Transfer Manager\) \(Windows\)](#)

## Store and Manage Templates (P-touch Library)

- [Edit Templates Using P-touch Library \(Windows\)](#)
- [Print Templates Using P-touch Library \(Windows\)](#)
- [Search Templates Using P-touch Library \(Windows\)](#)

## Edit Templates Using P-touch Library (Windows)

1. Start the P-touch Library.
  - **Windows 10/Windows Server 2016/Windows Server 2019/Windows Server 2022:**  
Click **Start > Brother P-touch > P-touch Library**.
  - **Windows 8.1/Windows Server 2012/Windows Server 2012 R2:**  
Click the **P-touch Library** icon on the **Apps** screen.

The main window appears.

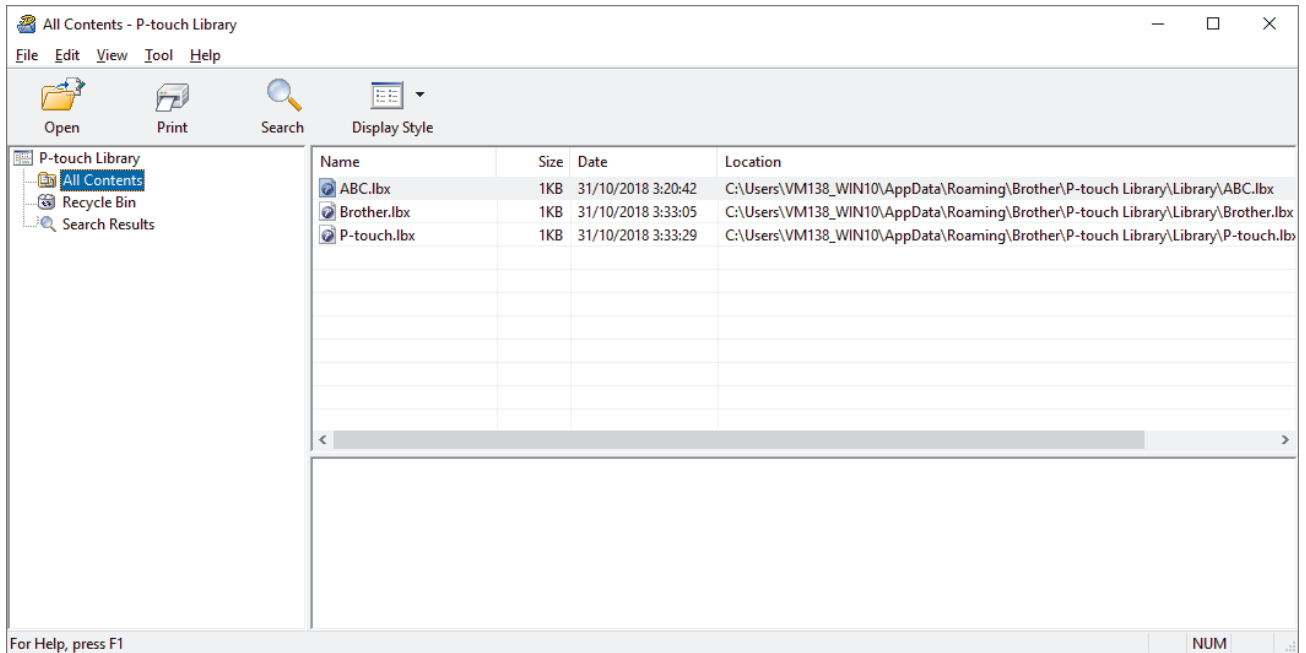

### Overview of the Toolbar Icons

Icon	Button name	Function
	<b>Open</b>	Click to open the selected template.
	<b>Print</b>	Click to print the selected template.
	<b>Search</b>	Click to search for templates registered to P-touch Library.
	<b>Display Style</b>	Click to change the file display style.

2. Select the template you want to edit, and then click **Open**.  
You can now edit the template.



### Related Information

- [Store and Manage Templates \(P-touch Library\)](#)

## Print Templates Using P-touch Library (Windows)

1. Start the P-touch Library.

- **Windows 10/Windows Server 2016/Windows Server 2019/Windows Server 2022:**  
Click **Start > Brother P-touch > P-touch Library**.
- **Windows 8.1/Windows Server 2012/Windows Server 2012 R2:**  
Click the **P-touch Library** icon on the **Apps** screen.

The main window appears.

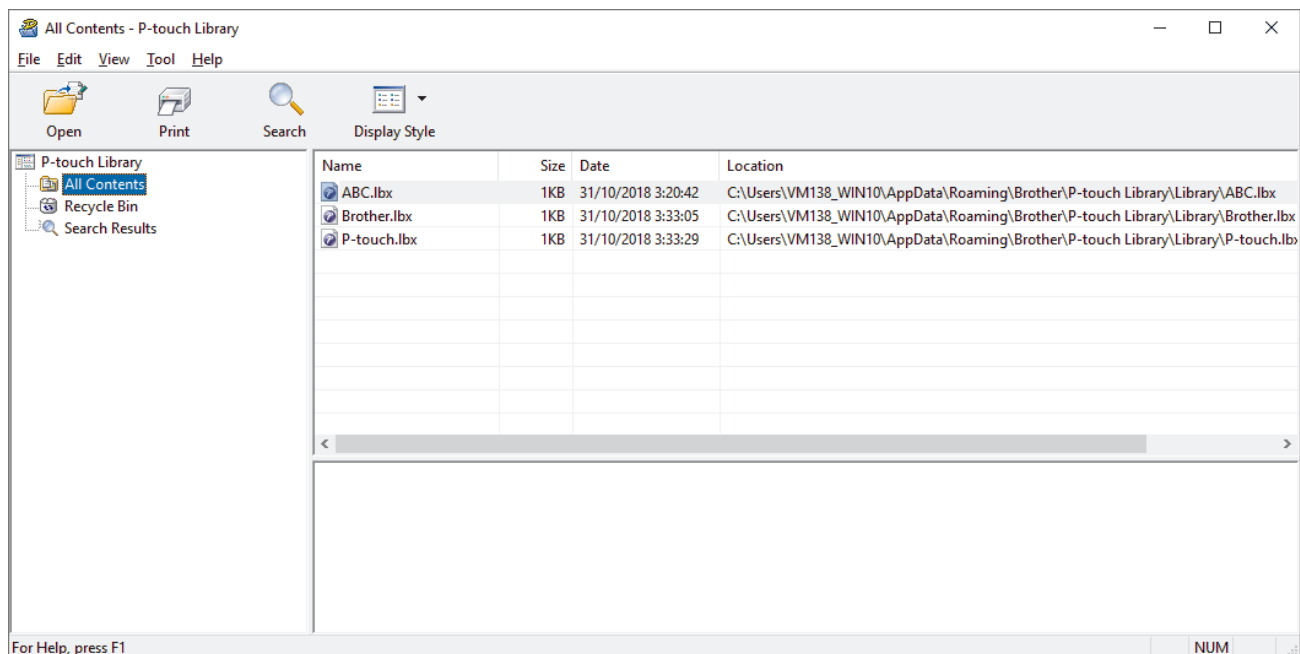

2. Select the template you want to print, and then click **Print**.

The connected printer prints the template.

### ✓ Related Information

- [Store and Manage Templates \(P-touch Library\)](#)

## Search Templates Using P-touch Library (Windows)

1. Start the P-touch Library.

- **Windows 10/Windows Server 2016/Windows Server 2019/Windows Server 2022:**  
Click **Start > Brother P-touch > P-touch Library**.
- **Windows 8.1/Windows Server 2012/Windows Server 2012 R2:**  
Click the **P-touch Library** icon on the **Apps** screen.

The main window appears.

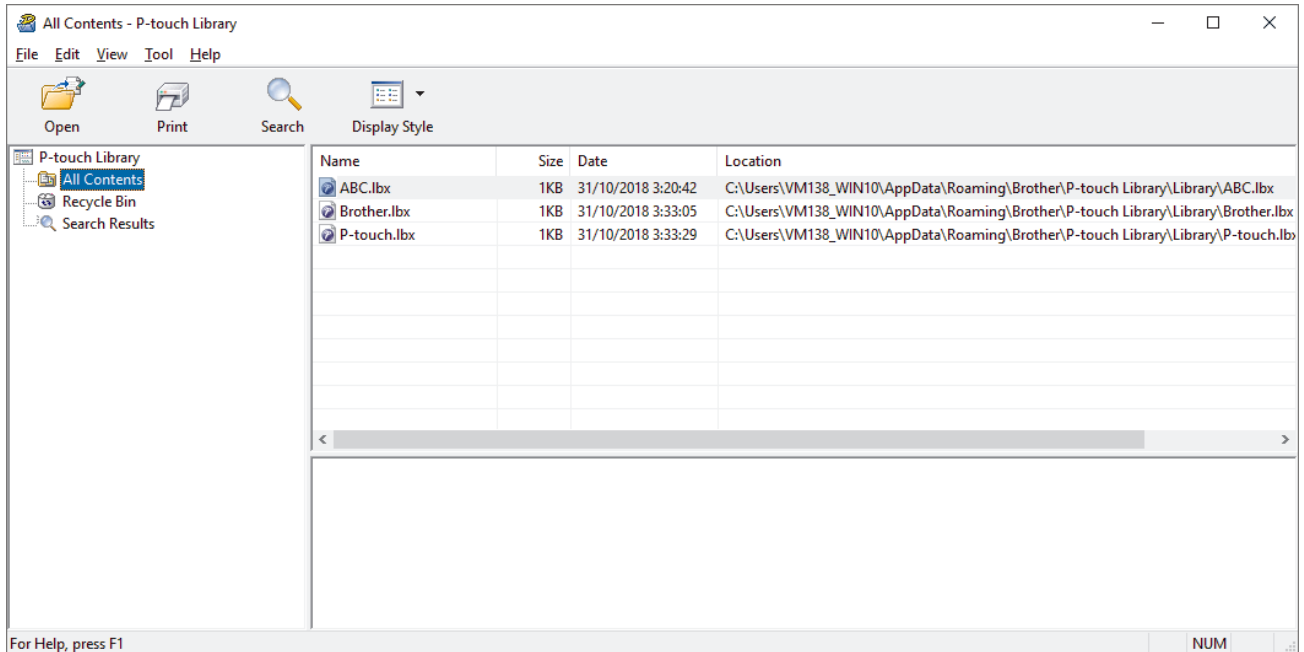

2. Click **Search**.

The **Search** dialog box appears.

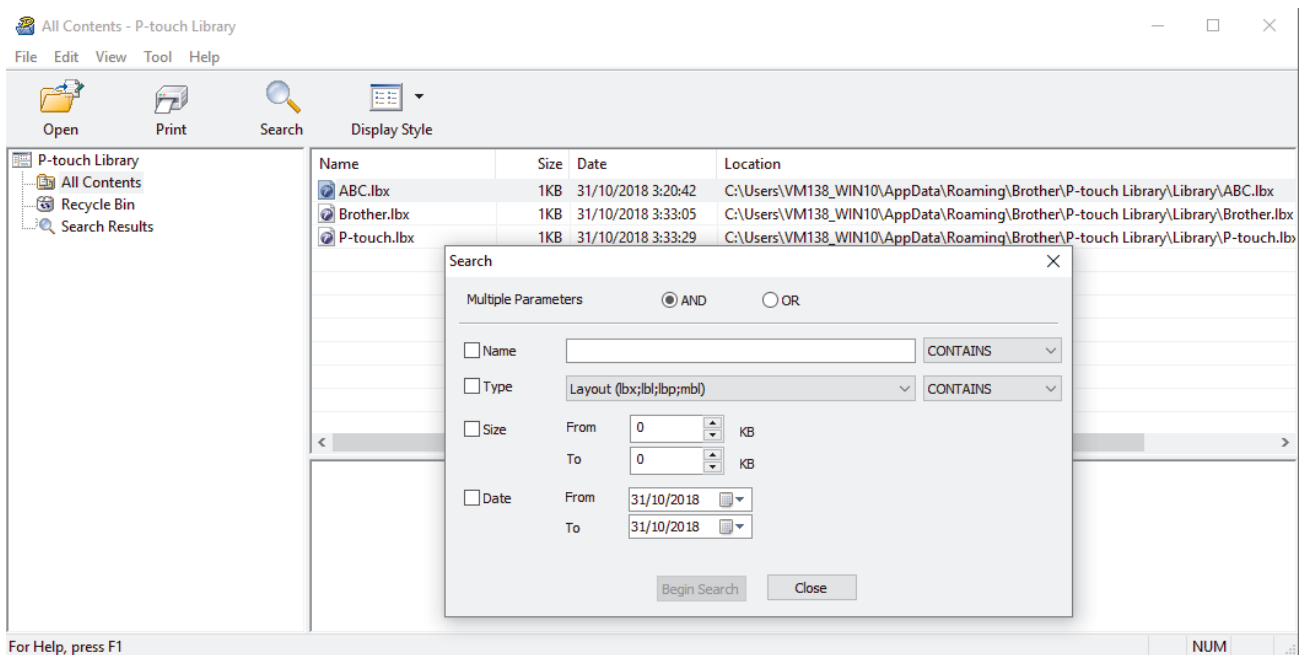

3. Specify the search criteria.

The following search criteria are available:

Settings	Details
<b>Multiple Parameters</b>	Determines how the program searches when multiple criteria are specified. If you select <b>AND</b> , the program searches for files meeting all of the criteria. If you select <b>OR</b> , the program searches for files meeting any of the criteria.
<b>Name</b>	Search for a template by specifying the file name.
<b>Type</b>	Search for a template by specifying the file type.
<b>Size</b>	Search for a template by specifying the file size.
<b>Date</b>	Search for a template by specifying the file date.

- Click **Begin Search**.

The search begins and the search results are displayed.

- Close the **Search** dialog box.

To confirm the search results, click **Search Results** in the folder view.



You can register templates to P-touch Library by dragging and dropping them into the **All Contents** folder or to the folder list.



### Related Information

- [Store and Manage Templates \(P-touch Library\)](#)



## Network

**Related Models:** PJ-883

- [Important Information for Security](#)
- [Wireless Network Settings](#)
- [Brother Management Tools](#)

## Important Information for Security

### Related Models: PJ-883

- The default password to manage this printer's settings is located in the battery cavity and marked "**Pwd**". We recommend immediately changing the default password to protect your printer from unauthorized access.
- When connecting your printer to an outside network such as the Internet, make sure your network environment is protected by a separate firewall or other means in order to prevent information leaks due to inadequate settings or unauthorized access by malicious third parties.
- If there is a signal in the vicinity, wireless LAN allows you to freely make a LAN connection. However, if security settings are not correctly configured, the signal may be intercepted by malicious third parties, possibly resulting in:
  - Theft of personal or confidential information
  - Improper transmission of information to parties impersonating the specified individuals
  - Dissemination of transcribed communication contents that were intercepted



### Related Information

- [Network](#)
-

## Wireless Network Settings

**Related Models:** PJ-883

- [Use the Wireless Network](#)
- [Enable or Disable Wi-Fi](#)

## Use the Wireless Network

**Related Models:** PJ-883

- [Before Configuring Your Printer for a Wireless Network](#)

## Before Configuring Your Printer for a Wireless Network

**Related Models:** PJ-883

Before attempting to configure a wireless network, confirm the following:

- If you are using an enterprise wireless network, you must know the User ID and Password.
- To achieve optimum results with normal everyday document printing, place your printer as close to the wireless LAN access point/router as possible with minimal obstructions. Large objects and walls between the two devices and interference from other electronic devices can affect the data transfer speed of your documents.

Due to these factors, wireless may not be the best method of connection for all types of documents and applications.

- If there is a signal in the vicinity, wireless LAN allows you to freely make a LAN connection. However, if security settings are not correctly configured, the signal may be intercepted by malicious third parties, possibly resulting in:
  - Theft of personal or confidential information
  - Improper transmission of information to parties impersonating the specified individuals
  - Dissemination of transcribed communication contents that were intercepted



Make sure you know your wireless router/access point's Network Name (SSID) and Network Key (Password). If you cannot find this information, consult the manufacturer of your wireless router/access point, your system administrator, or Internet provider. Brother cannot provide this information.



### Related Information





- [Use the Wireless Network](#)





## Enable or Disable Wi-Fi

**Related Models:** PJ-883

Follow these steps to enable or disable Wi-Fi or Bluetooth and Wi-Fi:

Press the Bluetooth and Wi-Fi button  to enable or disable the printer's Wi-Fi function.

When the Wi-Fi function is enabled, the Bluetooth and Wi-Fi indicator  is lit or flashing in green  /  or cyan  / .

If the Bluetooth and Wi-Fi indicator  is flashing in blue , press and hold the Bluetooth and Wi-Fi button  for about three seconds. The flashing color changes each time you press and hold the Bluetooth and Wi-Fi button . Press Bluetooth and Wi-Fi button  for three seconds to toggle between connection modes.



### Related Information

- [Wireless Network Settings](#)

## Brother Management Tools

**Related Models:** PJ-883

Use one of Brother's management tools to configure your Brother printer's network settings.  
Go to your model's **Downloads** page at [support.brother.com](http://support.brother.com) to download the tools.



### Related Information

- [Network](#)
-

## Security

**Related Models:** PJ-883

- [Before Using Network Security Features](#)
- [Configure Certificates for Device Security](#)
- [Use SSL/TLS](#)
- [Use SNMPv3](#)
- [Use IEEE 802.1x Authentication for a Wireless Network](#)



## Before Using Network Security Features

**Related Models:** PJ-883

Your printer employs some of the latest network security and encryption protocols available today. These network features can be integrated into your overall network security plan to help protect your data and prevent unauthorized access to the printer.



We recommend disabling the FTP server and TFTP protocols. Accessing the printer using these protocols is not secure.



### Related Information

- [Security](#)

## Configure Certificates for Device Security

**Related Models:** PJ-883

You must configure a certificate to manage your networked printer securely using SSL/TLS. You must use Web Based Management to configure a certificate.

- [Supported Security Certificate Features](#)
- [How to Create and Install a Certificate](#)
- [Create a Self-signed Certificate](#)
- [Create a Certificate Signing Request \(CSR\) and Install a Certificate from a Certificate Authority \(CA\)](#)
- [Import and Export the Certificate and Private Key](#)
- [Import and Export a CA Certificate](#)
- [Manage Multiple Certificates](#)

## Supported Security Certificate Features

**Related Models:** PJ-883

Your printer supports the use of multiple security certificates, which allows secure management, authentication, and communication with the printer. The following security certificate features can be used with the printer:

- SSL/TLS communication
- IEEE 802.1x authentication

Your printer supports the following:

- Pre-installed certificate

Your printer has a pre-installed self-signed certificate. This certificate enables you to use SSL/TLS communication without creating or installing a different certificate.



The pre-installed self-signed certificate protects your communication up to a certain level. We recommend using a certificate that is issued by a trusted organization for better security.

- Self-signed certificate

This print server issues its own certificate. Using this certificate, you can easily use the SSL/TLS communication without creating or installing a different certificate from a CA.

- Certificate from a Certificate Authority (CA)

There are two methods for installing a certificate from a CA. If you already have a certificate from a CA or if you want to use a certificate from an external trusted CA:

- When using a Certificate Signing Request (CSR) from this print server.
- When importing a certificate and a private key.

- Certificate Authority (CA) Certificate

To use a CA certificate that identifies the CA and owns its private key, you must import that CA certificate from the CA before configuring the security features of the Network.



- If you are going to use SSL/TLS communication, we recommend contacting your system administrator first.
- When you reset the print server back to its default factory settings, the certificate and the private key that are installed will be deleted. If you want to keep the same certificate and the private key after resetting the print server, export them before resetting, and then reinstall them.



### Related Information

- [Configure Certificates for Device Security](#)

## How to Create and Install a Certificate

**Related Models:** PJ-883

There are two options when choosing a security certificate: use a self-signed certificate or use a certificate from a Certificate Authority (CA).

### Option 1

#### Self-Signed Certificate

1. Create a self-signed certificate using Web Based Management.
2. Install the self-signed certificate on your computer.

### Option 2

#### Certificate from a CA

1. Create a Certificate Signing Request (CSR) using Web Based Management.
2. Install the certificate issued by the CA on your Brother printer using Web Based Management.
3. Install the certificate on your computer.



#### Related Information

- [Configure Certificates for Device Security](#)

## Create a Self-signed Certificate

Related Models: PJ-883

1. Start your web browser.
2. Type "https://printer's IP address" in your browser's address bar.

For example:

https://192.168.1.2



If you are using a Domain Name System or enable a NetBIOS name, you can type another name, such as "SharedPrinter" instead of the IP address.

For example:

https://SharedPrinter

If you enable a NetBIOS name, you can also use the node name.

For example:

https://brnxxxxxxxxxxxx

3. If required, type the password in the **Login** field, and then click **Login**.



The default password to manage this printer's settings is located in the battery cavity and marked "**Pwd**".

4. Go to the navigation menu, and then click **Network > Security > Certificate**.



Start from  if the navigation menu is not shown on the left side of the screen.

5. Click **Create Self-Signed Certificate**.
6. Enter a **Common Name** and a **Valid Date**.
  - The length of the **Common Name** is less than 64 bytes. Enter an identifier, such as an IP address, node name, or domain name to use when accessing this printer through SSL/TLS communication. The node name is displayed by default.
  - A warning will appear if you use the IPPS or HTTPS protocol and enter a different name in the URL than the **Common Name** that was used for the self-signed certificate.
7. Select your setting from the **Public Key Algorithm** drop-down list. The default setting is **RSA(2048bit)**.
8. Select your setting from the **Digest Algorithm** drop-down list. The default setting is **SHA256**.
9. Click **Submit**.



### Related Information

- [Configure Certificates for Device Security](#)

## Create a Certificate Signing Request (CSR) and Install a Certificate from a Certificate Authority (CA)

**Related Models:** PJ-883

If you already have a certificate from an external trusted Certificate Authority (CA), you can store the certificate and private key on the printer and manage them by importing and exporting. If you do not have a certificate from an external trusted CA, create a Certificate Signing Request (CSR), send it to a CA for authentication, and install the returned certificate on your printer.

- [Create a Certificate Signing Request \(CSR\)](#)
- [Install a Certificate on Your Printer](#)

## Create a Certificate Signing Request (CSR)

**Related Models:** PJ-883

A Certificate Signing Request (CSR) is a request sent to a Certificate Authority (CA) to authenticate the credentials contained within the certificate.

We recommend installing a Root Certificate from the CA on your computer before creating the CSR.

1. Start your web browser.
2. Type "https://printer's IP address" in your browser's address bar.

For example:

https://192.168.1.2



If you are using a Domain Name System or enable a NetBIOS name, you can type another name, such as "SharedPrinter" instead of the IP address.

For example:

https://SharedPrinter

If you enable a NetBIOS name, you can also use the node name.

For example:

https://brnxxxxxxxxxxxx

3. If required, type the password in the **Login** field, and then click **Login**.



The default password to manage this printer's settings is located in the battery cavity and marked "**Pwd**".

4. Go to the navigation menu, and then click **Network > Security > Certificate**.



Start from  if the navigation menu is not shown on the left side of the screen.

5. Click **Create CSR**.
6. Type a **Common Name** (required) and add other information about your **Organization** (optional).



- Your company details are required so that a CA can confirm your identity and verify it to the outside world.
- The length of the **Common Name** must be less than 64 bytes. Enter an identifier, such as an IP address, node name, or domain name to use when accessing this printer through SSL/TLS communication. The node name is displayed by default. The **Common Name** is required.
- A warning will appear if you type a different name in the URL than the Common Name that was used for the certificate.
- The length of the **Organization**, the **Organization Unit**, the **City/Locality** and the **State/Province** must be less than 64 bytes.
- The **Country/Region** should be a two character ISO 3166 country code.
- If you are configuring an X.509v3 certificate extension, select the **Configure extended partition** checkbox, and then select **Auto (Register IPv4)** or **Manual**.

7. Select your setting from the **Public Key Algorithm** drop-down list. The default setting is **RSA(2048bit)**.
8. Select your setting from the **Digest Algorithm** drop-down list. The default setting is **SHA256**.
9. Click **Submit**.

The CSR appears on your screen. Save the CSR as a file or copy and paste it into an online CSR form offered by a Certificate Authority.

10. Click **Save**.



- 
- Follow your CA's policy regarding the method to send a CSR to your CA.
  - If you are using the Enterprise root CA of Windows Server 2012/2012 R2/2016/2019/2022, we recommend using the Web Server for the certificate template to securely create the Client Certificate. If you are creating a Client Certificate for an IEEE 802.1x environment with EAP-TLS authentication, we recommend using User for the certificate template.

For more information, visit [support.brother.com](https://support.brother.com), to see the **FAQs & Troubleshooting** page of your model.

Search for "SSL".

---



### Related Information

- [Create a Certificate Signing Request \(CSR\) and Install a Certificate from a Certificate Authority \(CA\)](#)
-



## Install a Certificate on Your Printer

**Related Models:** PJ-883

When you receive a certificate from a CA, follow the steps below to install it into the print server:

Only a certificate issued with your printer's CSR can be installed onto the printer. When you want to create another CSR, make sure that the certificate is installed before creating another CSR. Create another CSR only after installing the certificate on the printer. Otherwise, the CSR you created before installing will be invalid.

1. Start your web browser.
2. Type "https://printer's IP address" in your browser's address bar.

For example:

https://192.168.1.2



If you are using a Domain Name System or enable a NetBIOS name, you can type another name, such as "SharedPrinter" instead of the IP address.

For example:

https://SharedPrinter

If you enable a NetBIOS name, you can also use the node name.

For example:

https://brnxxxxxxxxxxxx

3. If required, type the password in the **Login** field, and then click **Login**.



The default password to manage this printer's settings is located in the battery cavity and marked "**Pwd**".

4. Go to the navigation menu, and then click **Network > Security > Certificate**.



Start from  if the navigation menu is not shown on the left side of the screen.

5. Click **Install Certificate**.
6. Browse to the file that contains the certificate issued by the CA, and then click **Submit**.

The certificate has been created and saved in your printer's memory successfully.

To use SSL/TLS communication, the Root Certificate from the CA must be installed on your computer. Contact your network administrator.



### Related Information

- [Create a Certificate Signing Request \(CSR\) and Install a Certificate from a Certificate Authority \(CA\)](#)

## Import and Export the Certificate and Private Key

**Related Models:** PJ-883

Store the certificate and private key on your printer and manage them by importing and exporting them.

- [Import a Certificate and Private Key](#)
- [Export the Certificate and Private Key](#)

## Import a Certificate and Private Key

**Related Models:** PJ-883

1. Start your web browser.
2. Type "https://printer's IP address" in your browser's address bar.

For example:

https://192.168.1.2



If you are using a Domain Name System or enable a NetBIOS name, you can type another name, such as "SharedPrinter" instead of the IP address.

For example:

https://SharedPrinter

If you enable a NetBIOS name, you can also use the node name.

For example:

https://brnxxxxxxxxxxxx

3. If required, type the password in the **Login** field, and then click **Login**.



The default password to manage this printer's settings is located in the battery cavity and marked "**Pwd**".

4. Go to the navigation menu, and then click **Network > Security > Certificate**.



Start from  if the navigation menu is not shown on the left side of the screen.

5. Click **Import Certificate and Private Key**.
6. Browse to the file you want to import.
7. Type the password if the file is encrypted, and then click **Submit**.

The certificate and private key are imported to your printer.



### Related Information

- [Import and Export the Certificate and Private Key](#)

## Export the Certificate and Private Key

Related Models: PJ-883

1. Start your web browser.
2. Type "https://printer's IP address" in your browser's address bar.  
For example:  
https://192.168.1.2



If you are using a Domain Name System or enable a NetBIOS name, you can type another name, such as "SharedPrinter" instead of the IP address.

For example:

https://SharedPrinter

If you enable a NetBIOS name, you can also use the node name.

For example:

https://brnxxxxxxxxxxxx

3. If required, type the password in the **Login** field, and then click **Login**.



The default password to manage this printer's settings is located in the battery cavity and marked "**Pwd**".

4. Go to the navigation menu, and then click **Network > Security > Certificate**.



Start from  if the navigation menu is not shown on the left side of the screen.

5. Click **Export** shown with **Certificate List**.
6. Enter the password if you want to encrypt the file.  
If a blank password is used, the output is not encrypted.
7. Enter the password again for confirmation, and then click **Submit**.
8. Click **Save**.

The certificate and private key are exported to your computer.

You can also import the certificate to your computer.



### Related Information

- [Import and Export the Certificate and Private Key](#)

## Import and Export a CA Certificate

**Related Models:** PJ-883

You can import, export, and store CA certificates on your Brother printer.

- [Import a CA Certificate](#)
- [Export a CA Certificate](#)

## Import a CA Certificate

Related Models: PJ-883

1. Start your web browser.
2. Type "https://printer's IP address" in your browser's address bar.

For example:

https://192.168.1.2



If you are using a Domain Name System or enable a NetBIOS name, you can type another name, such as "SharedPrinter" instead of the IP address.

For example:

https://SharedPrinter

If you enable a NetBIOS name, you can also use the node name.

For example:

https://brnxxxxxxxxxxxx

3. If required, type the password in the **Login** field, and then click **Login**.



The default password to manage this printer's settings is located in the battery cavity and marked "**Pwd**".

4. Go to the navigation menu, and then click **Network > Security > CA Certificate**.



Start from  if the navigation menu is not shown on the left side of the screen.

5. Click **Import CA Certificate**.
6. Browse to the file you want to import.
7. Click **Submit**.



### Related Information

- [Import and Export a CA Certificate](#)

## Export a CA Certificate

Related Models: PJ-883

1. Start your web browser.
2. Type "https://printer's IP address" in your browser's address bar.

For example:

https://192.168.1.2



If you are using a Domain Name System or enable a NetBIOS name, you can type another name, such as "SharedPrinter" instead of the IP address.

For example:

https://SharedPrinter

If you enable a NetBIOS name, you can also use the node name.

For example:

https://brnxxxxxxxxxxxx

3. If required, type the password in the **Login** field, and then click **Login**.



The default password to manage this printer's settings is located in the battery cavity and marked **Pwd**.

4. Go to the navigation menu, and then click **Network > Security > CA Certificate**.



Start from  if the navigation menu is not shown on the left side of the screen.

5. Select the certificate you want to export and click **Export**.
6. Click **Submit**.
7. Click ▼ next to **Save**, and then specify the location where you want to save the file.



### Related Information

- [Import and Export a CA Certificate](#)

## Manage Multiple Certificates

**Related Models:** PJ-883

The multiple certificate feature allows you to use Web Based Management to manage each certificate installed on your printer. In Web Based Management, navigate to the **Certificate** or **CA Certificate** screen to view certificate content, delete, or export your certificates.

	Maximum Number of Certificates Stored on Brother Printer
Self-signed Certificate or Certificate Issued by a CA	5
CA Certificate	6

We recommend storing fewer certificates than allowed, reserving an empty spot in case of certificate expiration. When a certificate expires, import a new certificate into the reserved spot, and then delete the expired certificate. This ensures that you avoid configuration failure.



When you use HTTPS/IPPS, or IEEE 802.1x, you must select which certificate you are using.



### Related Information

- [Configure Certificates for Device Security](#)



## Use SSL/TLS

**Related Models:** PJ-883

- [Introduction to SSL/TLS](#)
- [Manage Your Network Printer Securely Using SSL/TLS](#)
- [Print Documents Securely Using SSL/TLS](#)

## Introduction to SSL/TLS

**Related Models:** PJ-883

Secure Socket Layer (SSL) or Transport Layer Security (TLS) is an effective method of protecting data sent over a local or wide area network (LAN or WAN). It works by encrypting data, such as a print job, sent over a network, so anyone trying to capture it will not be able to read it.

SSL/TLS will work with other forms of security such as WPA keys and firewalls.



### Related Information

- [Use SSL/TLS](#)
  - [Brief History of SSL/TLS](#)
  - [Benefits of Using SSL/TLS](#)

## Brief History of SSL/TLS

**Related Models:** PJ-883

SSL/TLS was originally created to secure web traffic information, particularly data sent between web browsers and servers. For example, when you use Internet Explorer for Internet Banking and you see https:// and the little padlock icon in the web browser, you are using SSL. SSL is now used with additional applications, such as Telnet, printer, and FTP software, in order to become a universal solution for online security. Its original design intentions are still being used today by many online retailers and banks to secure sensitive data, such as credit card numbers, customer records, etc.

SSL/TLS uses extremely high levels of encryption and is trusted by banks all over the world.



### Related Information

- [Introduction to SSL/TLS](#)

## Benefits of Using SSL/TLS

**Related Models:** PJ-883

The primary benefit of using SSL/TLS is to guarantee secure printing over an IP network by restricting unauthorized users from reading data sent to the printer. SSL's most important benefit is that it can be used to print confidential data securely. For example, a Human Resource (HR) Department in a large company may be printing wage slips on a regular basis. Without encryption, the data contained on these wages slips can be read by other network users. However, with SSL/TLS, anyone trying to capture the data will see a page of code and not the actual wage slip.



### Related Information

- [Introduction to SSL/TLS](#)

## Manage Your Network Printer Securely Using SSL/TLS

**Related Models:** PJ-883

- [Configure a Certificate for SSL/TLS and Available Protocols](#)
- [Access Web Based Management Using SSL/TLS](#)
- [Install the Self-signed Certificate for Windows Users with Administrator Rights](#)

## Configure a Certificate for SSL/TLS and Available Protocols

**Related Models:** PJ-883

Configure a certificate on your printer using Web Based Management before you use SSL/TLS communication.

1. Start your web browser.
2. Type "https://printer's IP address" in your browser's address bar.

For example:

https://192.168.1.2



If you are using a Domain Name System or enable a NetBIOS name, you can type another name, such as "SharedPrinter" instead of the IP address.

For example:

https://SharedPrinter

If you enable a NetBIOS name, you can also use the node name.

For example:

https://brnxxxxxxxxxxxx

3. If required, type the password in the **Login** field, and then click **Login**.



The default password to manage this printer's settings is located in the battery cavity and marked "**Pwd**".

4. Go to the navigation menu, and then click **Network > Network > Protocol**.



Start from  if the navigation menu is not shown on the left side of the screen.

5. Click **HTTP Server Settings**.
6. Select the certificate you want to configure from the **Select the Certificate** drop-down list.
7. Click **Submit**.
8. Click **Yes** to restart your print server.



### Related Information

- [Manage Your Network Printer Securely Using SSL/TLS](#)

## Access Web Based Printer Using SSL/TLS

Related Models: PJ-883

To manage your network printer securely, use Web Based Management with the HTTPS protocol.



- To use HTTPS protocol, HTTPS must be enabled on your printer. The HTTPS protocol is enabled by default.
- You can change the HTTPS protocol settings using Web Based Management.

1. Start your web browser.
2. Type "https://Common Name" in your browser's address bar (where "Common Name" is the Common Name that you assigned to the certificate; this could be your IP address, node name, or domain name).
3. If required, type the password in the **Login** field, and then click **Login**.



The default password to manage this printer's settings is located in the battery cavity and marked "**Pwd**".

4. You can now access the printer using HTTPS.







### Related Information

- [Manage Your Network Printer Securely Using SSL/TLS](#)

## Install the Self-signed Certificate for Windows Users with Administrator Rights

Related Models: PJ-883

The following steps are for Microsoft Internet Explorer. If you use another web browser, consult the documentation for your web browser to get help with installing certificates.

1. Do one of the following:
  - Windows 10, Windows Server 2016, Windows Server 2019, and Windows Server 2022  
Click  > **Windows Accessories**.
  - Windows 8.1  
Right-click the  (**Internet Explorer**) icon on the taskbar.
  - Windows Server 2012 and Windows Server 2012 R2  
Click  (**Internet Explorer**), and then right-click the  (**Internet Explorer**) icon that appears on the taskbar.

2. Right-click **Internet Explorer**, and then click **Run as administrator**.



If the **More** option appears, click **More**.

If the **User Account Control** screen appears, click **Yes**.

3. Type "https://printer's IP address" in your browser's address bar to access your printer (where "printer's IP address" is the printer's IP address or the node name that you assigned for the certificate).
4. Click **More information**.
5. Click **Go on to the webpage (not recommended)**.
6. Click **Certificate error**, and then click **View certificates**.

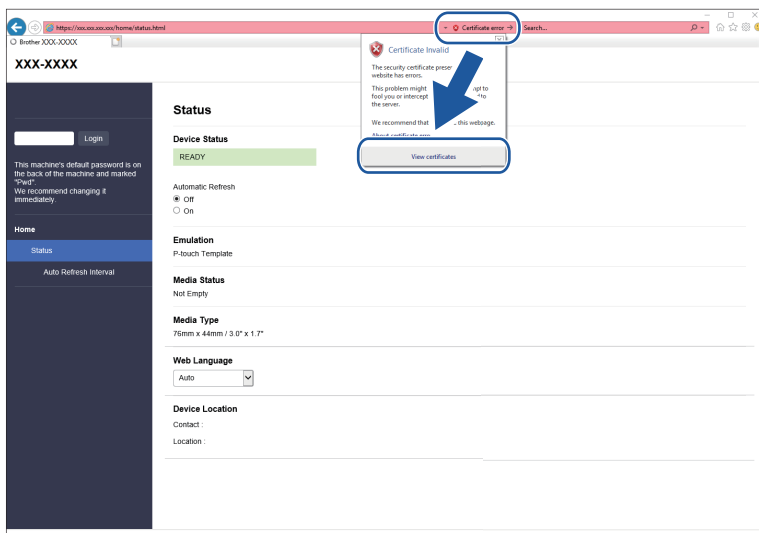

7. Click **Install Certificate...**
8. When the **Certificate Import Wizard** appears, click **Next**.
9. Select **Place all certificates in the following store**, and then click **Browse...**
10. Select **Trusted Root Certification Authorities**, and then click **OK**.
11. Click **Next**.
12. Click **Finish**.



---

13. Click **Yes**, if the fingerprint (thumbprint) is correct.

14. Click **OK**.



### Related Information

- [Manage Your Network Printer Securely Using SSL/TLS](#)
-

## Print Documents Securely Using SSL/TLS

**Related Models:** PJ-883

- [Print Documents Using SSL/TLS](#)

## Print Documents Using SSL/TLS

Related Models: PJ-883

To print documents securely with IPP protocol, use the IPPS protocol.

1. Start your web browser.
2. Type "https://printer's IP address" in your browser's address bar.

For example:

https://192.168.1.2



If you are using a Domain Name System or enable a NetBIOS name, you can type another name, such as "SharedPrinter" instead of the IP address.

For example:

https://SharedPrinter

If you enable a NetBIOS name, you can also use the node name.

For example:

https://brnxxxxxxxxxxxx

3. If required, type the password in the **Login** field, and then click **Login**.



The default password to manage this printer's settings is located in the battery cavity and marked "**Pwd**".

4. Go to the navigation menu, and then click **Network > Network > Protocol**.



Start from  if the navigation menu is not shown on the left side of the screen.

5. Make sure the **IPP** checkbox is selected.



If the **IPP** checkbox is not selected, select the **IPP** checkbox, and then click **Submit**.

Restart your printer to activate the configuration.

After the printer restarts, return to the printer's web page, type the password, go to the navigation menu, and then click **Network > Network > Protocol**.

6. Click **HTTP Server Settings**.
7. Select the **HTTPS(Port 443)** checkbox in the **IPP** area, and then click **Submit**.
8. Restart your printer to activate the configuration.

Communication using IPPS cannot prevent unauthorized access to the print server.



### Related Information

- [Print Documents Securely Using SSL/TLS](#)

## Use SNMPv3

**Related Models:** PJ-883

- [Manage Your Network Printer Securely Using SNMPv3](#)

## Manage Your Network Printer Securely Using SNMPv3

**Related Models:** PJ-883

The Simple Network Management Protocol version 3 (SNMPv3) provides user authentication and data encryption to manage network devices securely.

1. Start your web browser.
2. Type "https://Common Name" in your browser's address bar (where "Common Name" is the Common Name that you assigned to the certificate; this could be your IP address, node name, or domain name).
3. If required, type the password in the **Login** field, and then click **Login**.





The default password to manage this printer's settings is located in the battery cavity and marked "**Pwd**".

4. Go to the navigation menu, and then click **Network > Network > Protocol**.



Start from  if the navigation menu is not shown on the left side of the screen.

5. Make sure the **SNMP** setting is enabled, and then click **Advanced Settings**.
6. Configure the SNMP settings.

Option	Description
<b>SNMP v1/v2c read-write access</b>	The print server uses version 1 and version 2c of the SNMP protocol. You can use all of your printer's applications in this mode. However, it is not secure since it will not authenticate the user and data will not be encrypted.
<b>SNMPv3 read-write access and v1/v2c read-only access</b>	The print server uses the read-write access of version 3 and the read-only access of version 1 and version 2c of the SNMP protocol.  When you use the <b>SNMPv3 read-write access and v1/v2c read-only access</b> mode, some of your printer's applications that access the print server do not work correctly since they authorize the read-only access of version 1 and version 2c. If you want to use all applications, we recommend using the <b>SNMP v1/v2c read-write access</b> mode.
<b>SNMPv3 read-write access</b>	The print server uses version 3 of the SNMP protocol. If you want to manage the print server securely, use this mode.  When you use the <b>SNMPv3 read-write access</b> mode, note the following: Except for BRAdmin Professional, all applications that use SNMPv1/v2c will be restricted. To allow the use of SNMPv1/v2c applications, use the <b>SNMPv3 read-write access and v1/v2c read-only access</b> or <b>SNMP v1/v2c read-write access</b> mode.

7. Click **Submit**.



If your printer displays the protocol setting options, select the options you want.

8. Restart your printer to activate the configuration.



### Related Information

- [Use SNMPv3](#)

## Use IEEE 802.1x Authentication for a Wireless Network

**Related Models:** PJ-883

- [What Is IEEE 802.1x Authentication?](#)
- [Configure IEEE 802.1x Authentication for a Wireless Network Using Web Based Management \(Web Browser\)](#)
- [IEEE 802.1x Authentication Methods](#)

## What Is IEEE 802.1x Authentication?

**Related Models:** PJ-883

IEEE 802.1x is an IEEE standard for wireless networks that limits access from unauthorized network devices. Your Brother printer (supplicant) sends an authentication request to a RADIUS server (Authentication server) through your access point. After your request has been verified by the RADIUS server, your printer can access the network.

### Related Information

- [Use IEEE 802.1x Authentication for a Wireless Network](#)
-

## Configure IEEE 802.1x Authentication for a Wireless Network Using Web Based Management (Web Browser)

**Related Models:** PJ-883

- If you configure your printer using EAP-TLS authentication, you must install the client certificate issued by a CA before you start configuration. Contact your network administrator about the client certificate. If you have installed more than one certificate, we recommend writing down the certificate name you want to use.
- Before you verify the server certificate, you must import the CA certificate issued by the CA that signed the server certificate. Contact your network administrator or your Internet Service Provider (ISP) to confirm whether a CA certificate import is necessary.

1. Start your web browser.
2. Type "https://printer's IP address" in your browser's address bar.

For example:

https://192.168.1.2



If you are using a Domain Name System or enable a NetBIOS name, you can type another name, such as "SharedPrinter" instead of the IP address.

For example:

https://SharedPrinter

If you enable a NetBIOS name, you can also use the node name.

For example:

https://brnxxxxxxxxxxxx

3. If required, type the password in the **Login** field, and then click **Login**.



The default password to manage this printer's settings is located in the battery cavity and marked "**Pwd**".

4. Go to the navigation menu, and then click **Network**.



Start from  if the navigation menu is not shown on the left side of the screen.

5. Click **Wireless > Wireless (Enterprise)**.
6. Configure the IEEE 802.1x authentication settings.



- If you are using **EAP-TLS** authentication, you must select the client certificate installed (shown with certificate name) for verification from the **Client Certificate** drop-down list.
- If you select **EAP-FAST**, **PEAP**, **EAP-TTLS**, or **EAP-TLS** authentication, select the verification method from the **Server Certificate Verification** drop-down list. Verify the server certificate using the CA certificate, imported to the printer in advance, issued by the CA that signed the server certificate.

Select one of the following verification methods from the **Server Certificate Verification** drop-down list:

Option	Description
<b>No Verification</b>	The server certificate can always be trusted. The verification is not performed.
<b>CA Cert.</b>	The verification method to check the CA reliability of the server certificate, using the CA certificate issued by the CA that signed the server certificate.



---

Option	Description
<b>CA Cert. + ServerID</b>	The verification method to check the common name <sup>1</sup> value of the server certificate, in addition to the CA reliability of the server certificate.

---

<sup>1</sup> The common name verification compares the common name of the server certificate to the character string configured for the **Server ID**. Before you use this method, contact your system administrator about the server certificate's common name and then configure **Server ID**.

7. When finished with configuration, click **Submit**.



### Related Information

- [Use IEEE 802.1x Authentication for a Wireless Network](#)

#### Related Topics:

- [Configure Certificates for Device Security](#)
-

## IEEE 802.1x Authentication Methods

Related Models: PJ-883

### EAP-FAST

Extensible Authentication Protocol-Flexible Authentication via Secured Tunneling (EAP-FAST) has been developed by Cisco Systems, Inc., which uses a user ID and password for authentication, and symmetric key algorithms to achieve a tunneled authentication process.

Your Brother printer supports the following inner authentication methods:

- EAP-FAST/NONE
- EAP-FAST/MS-CHAPv2
- EAP-FAST/GTC

### PEAP

Protected Extensible Authentication Protocol (PEAP) is a version of EAP method developed by Cisco Systems, Inc., Microsoft Corporation and RSA Security. PEAP creates an encrypted Secure Sockets Layer (SSL)/Transport Layer Security (TLS) tunnel between a client and an authentication server, for sending a user ID and password. PEAP provides mutual authentication between the server and the client.

Your Brother printer supports the following inner authentication methods:

- PEAP/MS-CHAPv2
- PEAP/GTC

### EAP-TTLS

Extensible Authentication Protocol-Tunneled Transport Layer Security (EAP-TTLS) has been developed by Funk Software and Certicom. EAP-TTLS creates a similar encrypted SSL tunnel to PEAP, between a client and an authentication server, for sending a user ID and password. EAP-TTLS provides mutual authentication between the server and the client.

Your Brother printer supports the following inner authentication methods:

- EAP-TTLS/CHAP
- EAP-TTLS/MS-CHAP
- EAP-TTLS/MS-CHAPv2
- EAP-TTLS/PAP

### EAP-TLS

Extensible Authentication Protocol-Transport Layer Security (EAP-TLS) requires digital certificate authentication both at a client and an authentication server.



### Related Information

- [Use IEEE 802.1x Authentication for a Wireless Network](#)

## Update

- [Update P-touch Editor](#)
- [Update the Firmware](#)

## Update P-touch Editor

Before updating P-touch Editor, install the printer driver.

>> Windows

>> Mac

### Windows

1. Start the P-touch Update Software.
  - **Windows 10/Windows Server 2016/Windows Server 2019/Windows Server 2022:**  
Click **Start > Brother P-touch > P-touch Update Software**, or double-click the **P-touch Update Software** icon on the desktop.
  - **Windows 8.1/Windows Server 2012/Windows Server 2012 R2:**  
Click the **P-touch Update Software** icon on the **Apps** screen, or double-click the **P-touch Update Software** icon on the desktop.
2. Click the **Computer software update** icon.

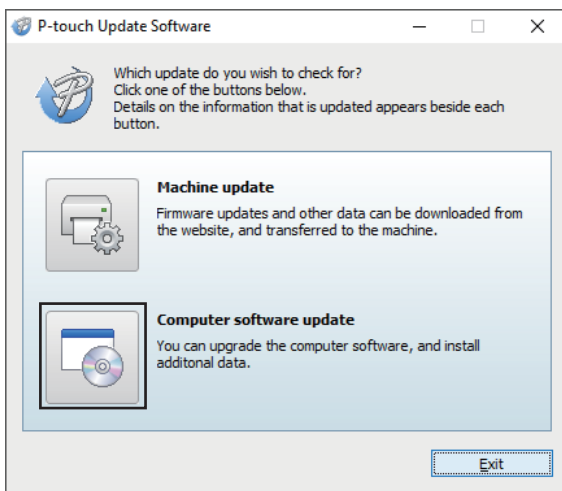

3. Select the **Printer** and **Language** options using the drop-down lists.
4. Select the P-touch Editor checkbox and click **Install**.

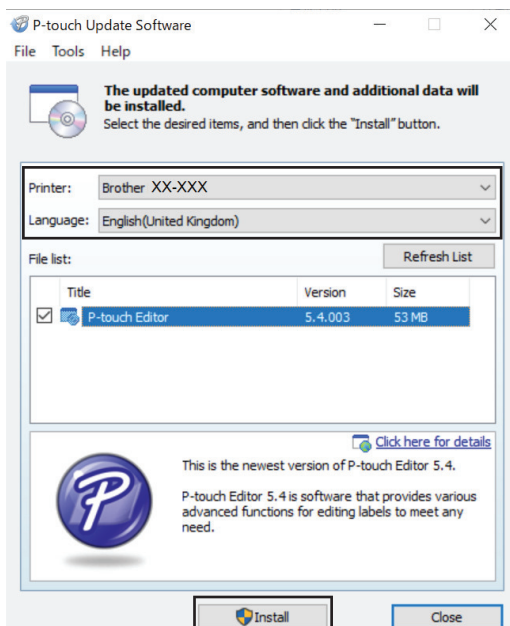

When finished, a message on the screen confirms that the installation is complete.

5. Click **OK**.

---

## Mac

To update P-touch Editor for Mac, visit <http://appstore.com/mac/brotherindustriesltd/brotherptoucheditor>.



## Related Information

- [Update](#)
-

## Update the Firmware

- Before updating the firmware, you must first install the printer driver.
- Do not turn off the power when transferring data or updating firmware.
- If any other application is running, exit the application.

>> [Windows](#)

>> [Mac](#)

### Windows

1. Turn on the printer and connect the USB cable.
2. Start the P-touch Update Software.
  - **Windows 10/Windows Server 2016/Windows Server 2019/Windows Server 2022:**  
Click **Start > Brother P-touch > P-touch Update Software**, or double-click the **P-touch Update Software** icon on the desktop.
  - **Windows 8.1/Windows Server 2012/Windows Server 2012 R2:**  
Click the **P-touch Update Software** icon on the **Apps** screen, or double-click the **P-touch Update Software** icon on the desktop.
3. Click the **Machine update** icon.

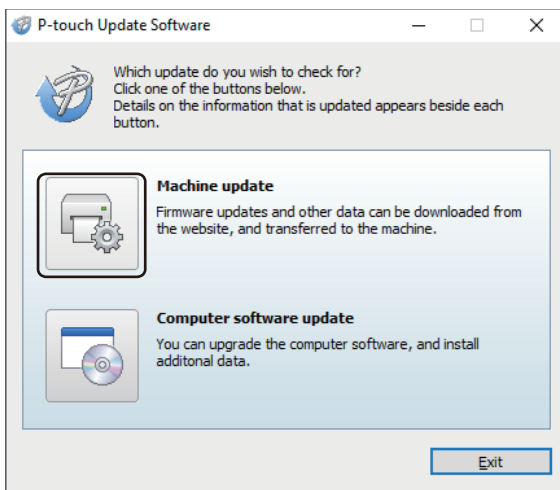

4. Select the **Printer** option, make sure the printer is connected correctly, and then click **OK**.

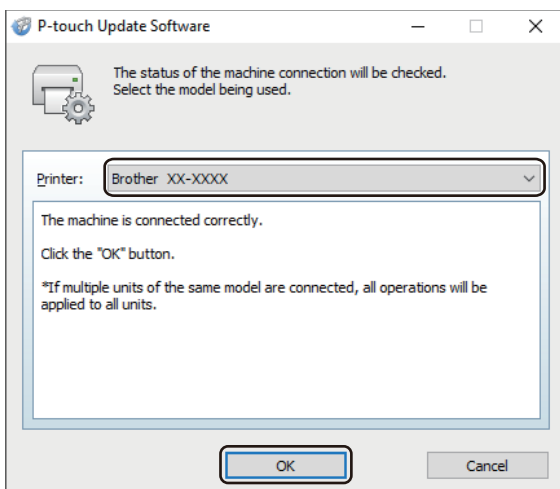

5. Select **Language** from the drop-down list.

6. Select the checkbox next to the firmware you want to update, and then click **Transfer**.

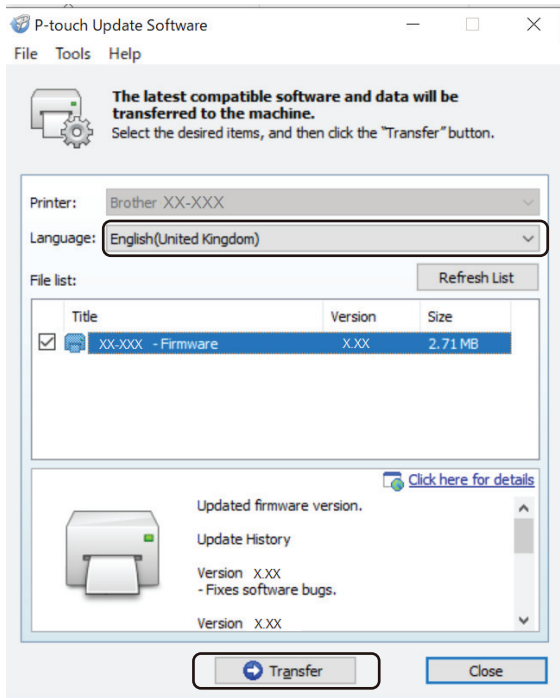

## NOTE

Do not turn off the printer or disconnect the cable during the update process and data transfer.

7. Check the content to be updated, and then click **Start** to begin the update.

The firmware update begins.

## Mac

Download and install Transfer Express from the App Store to update the firmware.

1. Turn on the printer and connect the USB cable.
2. Double-click **Macintosh HD > Applications**, and then double-click the **Transfer Express** icon.
3. Click the **Choose a printer** pop-up menu, and then select your printer from the printer list.
4. Click the **Download and Update** button.

The firmware update begins.

## NOTE

Do not turn off the printer or disconnect the cable during the update process and data transfer.

## ✓ Related Information

- [Update](#)

## Printer Settings

- [Change Printer Settings Using the Printer Setting Tool \(Windows\)](#)
- [Apply Setting Changes to Multiple Printers \(Windows\)](#)
- [Change Printer Settings Using the Printer Setting Tool \(Mac\)](#)
- [Apply Setting Changes to Multiple Printers \(Mac\)](#)
- [Change Printer Settings Using Web Based Management](#)
- [Confirm Printer Settings](#)
- [Print a Document Using the Printer Driver \(Windows/Mac\)](#)



## Change Printer Settings Using the Printer Setting Tool (Windows)

- Make sure the printer driver has been installed correctly and you can print.
- Connect the printer to a computer with a USB cable.



The Printer Setting Tool is installed in addition to the printer driver and other software when using the installer.

1. Connect the printer you want to configure to the computer.
2. Start the Printer Setting Tool.
  - **Windows 10/Windows Server 2016/Windows Server 2019/Windows Server 2022:**  
Click **Start > Brother > Printer Setting Tool**.
  - **Windows 8.1/Windows Server 2012/Windows Server 2012 R2:**  
Click the **Printer Setting Tool** icon on the **Apps** screen.

The main window appears.

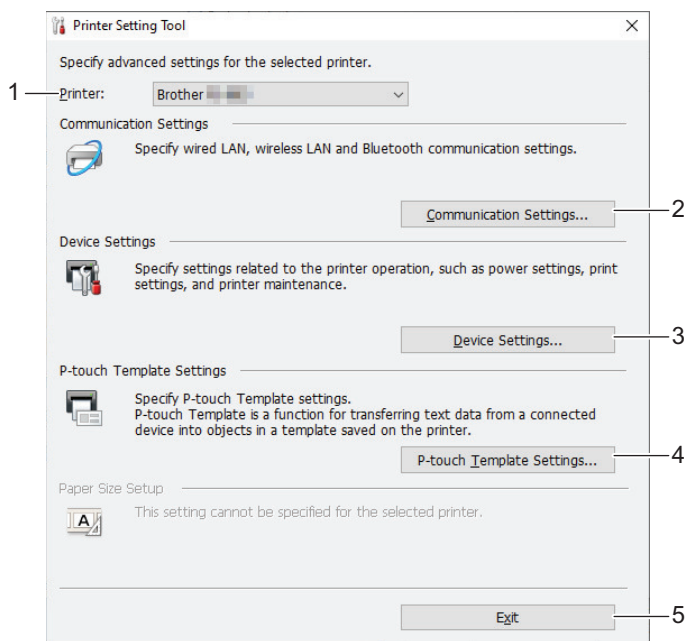

- 1. Printer**  
Lists the connected printers.
  - 2. Communication Settings (PJ-862/PJ-863/PJ-883)**  
Specify communication settings.
  - 3. Device Settings**  
Specify device settings.
  - 4. P-touch Template Settings**  
Specify P-touch Template settings.  
For more information, see the *P-touch Template Manual/Command Reference* (English only). You can download the latest version from the Brother support website at [support.brother.com/manuals](http://support.brother.com/manuals).
  - 5. Exit**  
Click to close the window.
3. Make sure the printer you want to configure appears next to **Printer**.  
If a different printer appears, select the printer you want from the drop-down list.
  4. Select the settings you want to change, and then specify or change the settings in the dialog box.

- 
5. Click **Apply** to apply the settings to the printer.
  6. Click **Exit** in the main window to finish specifying settings.



---

Use the Printer Setting Tool to configure the printer only when the printer is idle. The printer may malfunction if you try to configure it while it is processing or printing a print job.

---



### Related Information

- [Printer Settings](#)
    - [Communication Settings of the Printer Setting Tool \(Windows\)](#)
    - [Device Settings of the Printer Setting Tool \(Windows\)](#)
    - [P-touch Template Settings of the Printer Setting Tool \(Windows\)](#)
-

## Communication Settings of the Printer Setting Tool (Windows)

**Related Models:** PJ-862/PJ-863/PJ-883

Use Communication Settings in the Printer Setting Tool to specify or change the printer communication information, when connecting the printer and computer with a USB cable or via a Bluetooth connection. Not only can you change the communication settings for one printer, but you can also apply the same settings to multiple printers.

- >> [Settings Dialog Box](#)
- >> [Menu Bar](#)
- >> [General Tab](#)
- >> [Wireless LAN Tab \(PJ-883\)](#)
- >> [Wireless Direct Tab \(PJ-883\)](#)
- >> [Bluetooth Tab](#)

### Settings Dialog Box

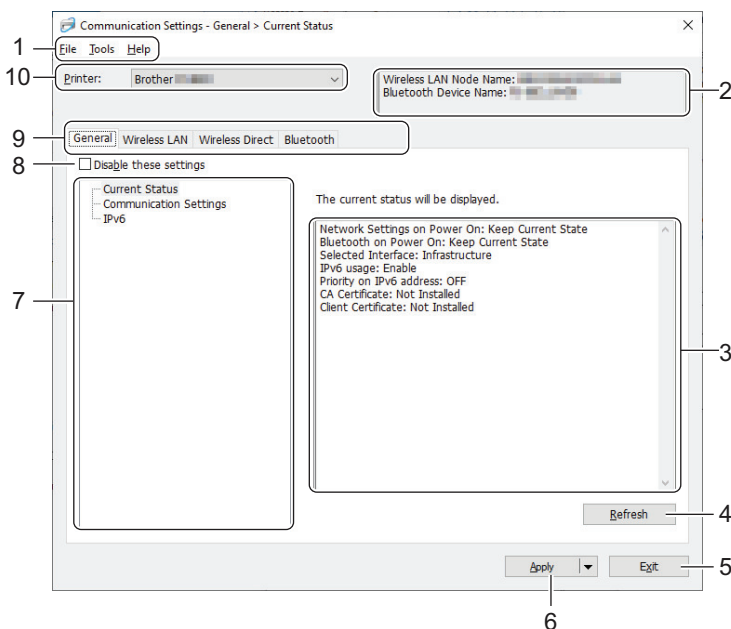

#### 1. Menu Bar

Provides access to various commands grouped under each menu title (the **File**, **Tools**, and **Help** menus) according to their functions.

#### 2. Device Name

Displays the device name.

#### 3. Settings Display/Change Area

Displays the current settings for the selected item.

#### 4. Refresh

Click to update the displayed settings with the most recent information.

#### 5. Exit

Click to exit the **Communication Settings** window and return to the main window of the Printer Setting Tool.



Settings are not applied to printers if **Exit** is clicked without clicking the **Apply** button after changing the settings.

---

## 6. Apply

Click to apply the settings to the printer. To save the specified settings in a command file, select the **Save in Command File** command from the drop-down list. The saved command file can be used with the mass storage mode to apply the settings to a printer.



---



Clicking **Apply** applies all settings in all tabs to the printer. If the **Disable these settings** checkbox is selected, the settings are not applied.

---

## 7. Items

When the **Current Status** menu is selected, the current settings appear in the settings display/change area. Select the item for the settings you want to change.

## 8. Disable these settings

When this checkbox is selected,  appears in the tab, and the settings can no longer be specified or changed. Settings in a tab where  appears are not applied to the printer even if **Apply** is clicked. In addition, the settings in the tab are not saved or exported when the **Save in Command File** or **Export** command is used. To apply the settings to the printer, or to save or export them, make sure you clear the checkbox.

## 9. Settings Tabs

Contains settings that may be specified or changed. If  appears in the tab, the settings are not applied to the printer.

## 10. Printer

Lists the connected printers.

# Menu Bar

## File Menu Options

### Apply Settings to the Printer

Apply the settings to the printer.

### Save Settings in Command File

Save the specified settings in a command file. The file extension is BIN. The saved command file can be used with the mass storage mode to apply the settings to a printer.



- 
- If the **Disable these settings** checkbox is selected, the settings are not saved.
  - The following information is not saved with the command file:
    - Node name
    - IP address, subnet mask, and default gateway (when the IP address is set to **STATIC**)
  - The saved communication settings commands are intended to be used only for applying settings to a printer. To apply the settings to the printer using this command file, use the mass storage mode.
  - Saved command files contain authentication keys and passwords. Take necessary measures to protect saved command files, such as saving them in a location that cannot be accessed by other users.
  - Do not send command files to a different printer model.
- 

### Install Certificates (PJ-883)

Some network authentication methods may require a certificate.

Install a certificate on the connected printer or save a certificate as a command file that can be distributed to the same printer models.

### Import

#### Import from the current computer wireless settings (PJ-883)

Imports the settings from the computer.



- When importing the computer's wireless settings, administrator privileges for the computer are needed.
- Only personal security authentication settings (open system, public key authentication, WPA/WPA2-PSK, and WPA3 SAE up to 63 characters) can be imported. Enterprise security authentication (such as EAP-FAST), WPA2-PSK (TKIP) and WPA-PSK (AES) settings cannot be imported.
- If multiple wireless LANs are enabled for the computer you use, the first detected wireless settings (only personal settings) are considered for the import data.
- Only the settings from the **Wireless LAN** tab - **Wireless Settings** pane can be imported (communication mode, SSID, authentication method, encryption mode and authentication key).

### Select a Profile to import

Imports the exported file and applies the settings to a printer. Click **Browse** and select the file you want to import. The settings in the selected file appear in the settings display/change area.



- All settings can be imported, except for node names.
- Only the profiles compatible with the selected printer can be imported.
- If the imported profile's IP address is set to **STATIC**, change the IP address of the imported profile, if needed, so that it does not duplicate the IP address of an existing configured printer on the network.

### Export

Save the current settings in a file. If the **Disable these settings** checkbox is selected, the settings are not saved.



Exported files are not encrypted.

## Tools Menu Options

### Option Settings

#### Automatically restart the printer after applying new settings

If this checkbox is selected, the printer automatically restarts after communication settings are applied. If this checkbox is cleared, you must restart the printer manually.



When configuring multiple printers, you can reduce the time needed to change settings by clearing this checkbox. In this case, we recommend selecting this checkbox when configuring the first printer so that you can confirm that each setting is operating as intended.

#### Automatically detects the connected printer, and retrieves the current settings

If this checkbox is selected and a printer is connected to the computer, the printer is automatically detected and the printer's current settings are displayed in the **Current Status** pane.



If the connected printer is different from the printer shown in the **Printer** drop-down list, the settings available on all tabs change to match the connected printer.

### Change Node Name/Bluetooth Device Name

Allows renaming a node name and Bluetooth device name.

### Reset to Default Communication Settings

Reset the communication settings to their factory settings.

## Help Menu Options

### Display Help

Displays the Help topics.

---

## General Tab

### Communication Settings

#### Network Settings on Power On (PJ-883)

Specify the conditions for connecting via network when the printer is turned on.

#### Selected Interface (PJ-883)

Select the **Infrastructure**, **Infrastructure and Wireless Direct**, or **Wireless Direct** option.

#### Bluetooth on Power On

Specify the conditions for connecting via Bluetooth when the printer is turned on. Select the **On by Default**, **Off by Default**, or **Keep Current State** option.

### IPv6 (PJ-883)

#### IPv6 usage

Select **Enable** or **Disable**.

#### Priority on IPv6 address

Select to give priority to an IPv6 address.

### AirPrint Settings (PJ-883)

Enable or disable AirPrint, and configure the settings.

## Wireless LAN Tab (PJ-883)

### TCP/IP (Wireless)

#### Boot Method

Select the **AUTO**, **BOOTP**, **DHCP**, **RARP**, or **STATIC** option.

#### IP Address/Subnet Mask/Gateway

Specify the various networking values. You can enter these settings only when the IP address is set to **STATIC**.

#### DNS Server Method

Select the **AUTO** or **STATIC** option.

#### Primary DNS Server IP Address/Secondary DNS Server IP Address

You can enter these settings only when the DNS server is set to **STATIC**.

### IPv6

#### Static IPv6 Address

Specify a permanent IPv6 address.

#### Enable this address

Enables the specified static IPv6 address.

#### Primary DNS Server IPv6 Address/Secondary DNS Server IPv6 Address

Specify the DNS server IPv6 addresses.

#### IPv6 Address List

Displays the list of IPv6 addresses.

### Wireless Settings

#### Communication Mode

Displays communication mode.

## SSID (Network Name)

Clicking **Search** displays the available SSIDs in a separate dialog box.

## Channel

Displays the automatically selected channel.

## Authentication Method/Encryption Mode

The supported encryption modes for the authentication methods are shown in the table below.

Authentication Method	Encryption Mode
Open System	None / WEP
Shared Key	WEP
WPA3-SAE	AES
WPA/WPA2-PSK/WPA3-SAE	TKIP+AES / AES
EAP-FAST/NONE	TKIP+AES / AES
EAP-FAST/MS-CHAPv2	TKIP+AES / AES
EAP-FAST/GTC	TKIP+AES / AES
PEAP/MS-CHAPv2	TKIP+AES / AES
PEAP/GTC	TKIP+AES / AES
EAP-TTLS/CHAP	TKIP+AES / AES
EAP-TTLS/MS-CHAP	TKIP+AES / AES
EAP-TTLS/MS-CHAPv2	TKIP+AES / AES
EAP-TTLS/PAP	TKIP+AES / AES
EAP-TLS	TKIP+AES / AES



To specify higher level security settings: When performing certificate verification with EAP-FAST, PEAP, EAP-TTLS, or EAP-TLS authentication methods, the certificate cannot be specified from the Printer Setting Tool. After the printer is configured to connect to the network, specify the certificate by accessing the printer from a web browser. Installation of the authentication certificate can also be performed with the Printer Setting Tool by going to the menu bar: **File > Install Certificates**.

## WEP Key

You can specify a setting only when WEP is selected as the encryption mode.

## Passphrase

You can specify a setting only when WPA/WPA2-PSK/WPA3-SAE is selected as the authentication method.

## User ID/Password

You can specify settings only when EAP-FAST, PEAP, EAP-TTLS, or EAP-TLS is selected as the authentication method. In addition, with EAP-TLS, it is not necessary to register a password, but a client certificate must be registered. To register a certificate, connect to the printer from a web browser, and then specify the certificate.

## Display the key and password on-screen

If this checkbox is selected, keys and passwords are displayed in plain (non-encrypted) text.

## Wireless Direct Tab (PJ-883)

### Wireless Direct Settings

#### SSID/Network Key Generation

Select the **AUTO** or **STATIC** option.

---

### SSID (Network Name)/Network Key

Specify the SSID (25 ASCII characters or fewer) and the network key (63 characters or fewer) you want to use in the Wireless Direct mode.



---

The default SSID and Password are as follows:

- SSID: "DIRECT-\*\*\*\*\*\_PJ-883" where \*\*\*\*\* is the last five digits of the printer's serial number.
- Password: 883 \*\*\*\*\*

\*\*\*\*\* is the last five digits of the serial number located on the printer's base.

---

### Channel

Specify the channel to use for the Wireless Direct mode.

## Bluetooth Tab

### Bluetooth Settings

#### Bluetooth Mode

Select the control mode when Bluetooth is enabled.

#### Classic

##### Visible to Other Devices

Allows the printer to be discovered by other Bluetooth devices.

##### Change PIN code

Changes the PIN.

##### Display the PIN code on-screen

Displays the PIN on your computer.

##### Pairing requires user confirmation on printer

If this checkbox is selected when using Classic Bluetooth mode, it is necessary to perform additional printer button operations when pairing with devices running Bluetooth 2.1 or later.

##### Auto re-pairing

Sets whether to automatically reconnect to a previously connected Apple device (iPad, iPhone or iPod touch).

#### Low Energy

##### Minimum Security Mode

Select the minimum security level when using the **Low Energy Only** mode.

##### Pairing requires user confirmation on printer

If this checkbox is selected when using the **Low Energy Only** mode, it is necessary to perform additional printer button operations when pairing with Low Energy compatible devices.



### Related Information

- [Change Printer Settings Using the Printer Setting Tool \(Windows\)](#)
-



## Device Settings of the Printer Setting Tool (Windows)

- PJ-822/PJ-823:  
Use **Device Settings** in the Printer Setting Tool to specify or change printer settings when connecting the printer and computer with a USB cable.
- PJ-862/PJ-863/PJ-883:  
Use **Device Settings** in the Printer Setting Tool to specify or change printer settings when connecting the printer and computer with a USB cable or via a Bluetooth connection.

Not only can you change the device settings for one printer, but you can also apply the same settings to multiple printers.

When printing from a computer application, various print settings can be specified from the printer driver; however, using the Device Settings tool in the Printer Setting Tool, more advanced settings can be specified. When you open the **Device Settings** window, the printer's current settings are retrieved and displayed. If the current settings cannot be retrieved, the previous settings are displayed. If the current settings cannot be retrieved and previous settings were not specified, the printer's factory settings appear.

- >> [Settings Dialog Box](#)
- >> [Menu Bar](#)
- >> [Basic Tab](#)
- >> [Advanced \(1\) Tab](#)
- >> [Advanced \(2\) Tab](#)
- >> [ESC/P Legacy \(1\) Tab](#)
- >> [ESC/P Legacy \(2\) Tab](#)

### Settings Dialog Box

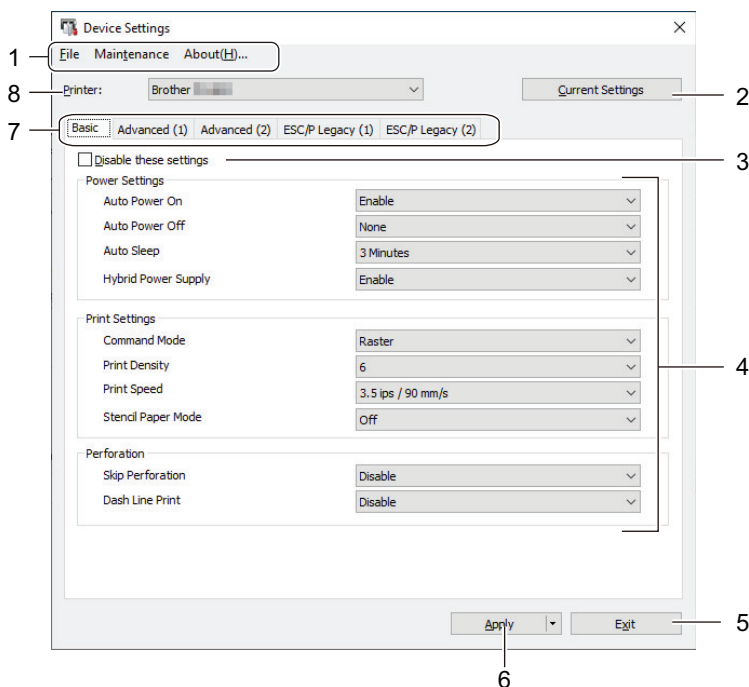

#### 1. Menu Bar



Provides access to various commands grouped under each menu title (the **File**, **Maintenance**, and **About** menus) according to their functions.

#### 2. Current Settings

Retrieves the settings from the currently connected printer and displays them in the dialog box. Settings can also be retrieved for the parameters on tabs with .

---

### 3. Disable these settings

When this checkbox is selected,  appears on the tab, and the settings can no longer be specified or changed. Settings in a tab where  appears are not applied to the printer even if **Apply** is clicked. In addition, the settings in the tab are not saved or exported when you use the **Save in Command File** or **Export** command.

### 4. Parameters

Displays the current settings.

### 5. Exit

Click to exit the **Device Settings** window and return to the main window of the Printer Setting Tool.

### 6. Apply

Apply the settings to the printer. To save the specified settings in a command file, select the **Save in Command File** option from the drop-down list.

The saved command file can be used with the mass storage mode to apply the settings to a printer.

### 7. Settings Tabs

Contains settings that may be specified or changed.



---

If  appears in the tab, the settings cannot be changed. In addition, the settings in the tab with the icon are not applied to the printer even if you click **Apply**. The settings in the tab are not saved when you use the **Save in Command File** command.

---

### 8. Printer

Select the printer you want to configure.

## Menu Bar

### File Menu Options

#### Apply Settings to the Printer

Apply the settings to the printer.

#### Check Setting

Displays the current settings.

#### Save Settings in Command File

Saves the specified settings in a command file.

#### Import

Imports an exported file.

#### Export

Saves the current settings in a file.

#### Exit

Click to exit the **Device Settings** window and return to the main window of the Printer Setting Tool.

### Maintenance Menu Options



---

You must have administrator privileges for the computer or the printer to display some items. Check if you have administrator privileges for the printer by clicking the **Printer properties** menu, and then clicking the **Security** tab.

---

#### Clean Unit

Select to clean the platen roller of the printer by feeding the dedicated cleaning sheet.

#### Auto Sensor Adjustment

Adjusts the paper detection sensor automatically.

## Print Unit Settings

Print a report containing firmware version, paper size, and configuration information.

### Factory Reset

(PJ-822/PJ-823) Reset all the settings to the factory settings, including device settings, and transferred data.

(PJ-862/PJ-863/PJ-883) Reset all the settings to the factory settings, including device settings, transferred data, and network settings.

### Reset only Device Settings

Reset the settings that can be changed in the Device Settings to the factory settings.

### Delete Template

Delete all the templates stored in the printer.

### Option Settings

If the **Do not display an error message if the current settings cannot be retrieved at startup** checkbox is selected, an error message is not displayed next time.

## Basic Tab

### Auto Power On

Specify how the printer responds when connected to a USB, an AC or DC power outlet.

### Auto Power Off

Specify the amount of time that passes before the printer turns off automatically.

### Auto Sleep

Specify the amount of time to pass before the printer automatically goes into sleep mode.



- The printer will automatically enter sleep mode when the specified time elapses under the following conditions:
  - The printer does not receive data.
  - In idle mode.
- Sleep mode is cancelled when the following operations are performed:
  - A printer button is pressed.
  - The printer receives data.
  - The USB cable is disconnected and then reconnected.
  - The AC Adapter is disconnected and then reconnected.
  - The Rechargeable Li-ion Battery is removed and then reinserted.

### Hybrid Power Supply

Use the AC Adapter (PA-AD-600A) along with the Rechargeable Li-ion Battery (PA-BT-002) to increase the printing speed.

### Command Mode

Specify the printer's command format.

### Print Density

Adjusts the printer's printing density.

### Print Speed

Select the printer's printing speed.

Option	Description
1.1 ips / 27 mm/s	Select these options when you want to prioritize image quality.

Option	Description
1.9 ips / 48 mm/s	
2.7 ips / 70 mm/s	
3.5 ips / 90 mm/s	
<b>Fast (Draft Quality)</b>	Speed priority mode. Select this option when printing documents containing bold text.
<b>Fast (Line Conversion)</b>	Speed priority mode. Select this option when printing documents with ruled pages or bold text.

### Stencil Paper Mode

This mode is suitable for printing on stencil paper. Turn this setting on when printing on stencil paper.

### Skip Perforation

Leaves a one-inch (25.4 mm) margin at the top and bottom of the paper. Use it when printing on perforated roll paper so that the printer does not print on the perforation.

### Dash Line Print

Prints dash lines between pages, which is useful when printing on roll paper. Set **Form Feed Mode** to **Fixed Page**, and then select **Enable**. Note that dash lines are printed on the paper; they are not punched into the paper.

## Advanced (1) Tab

### Roll/Fanfold Option

Specify the setting for using the optional roll printer case. Depending on the selected option, you can adjust the feed value or amount of paper retraction for the roll printer case.

Option	Description
<b>Roll Printer Case (With Anti Curl)</b>	Select this option when using the anti-curl mechanism while using the roll printer case.
<b>Roll Printer Case (Without Anti Curl)</b>	Select this option when not using the anti-curl mechanism while using the roll printer case.
<b>Roll Printer Case (Short Feed)</b>	Using the roll printer case with paper passed through the anti-curl mechanism causes the paper to have pressure marks. Use this option to make sure the pressure marks are not printed.
<b>Custom Option</b>	When using a case other than the roll printer case, you can customize the feed distance before and after printing starts.
<b>No</b>	Select this option when not using the roll printer case.

### Tear Distance Adjust

Adjust the Tear Bar tear-off position for paper media. This setting is available when **Roll/Fanfold Option** is set to **Roll Printer Case (With Anti Curl)**, **Roll Printer Case (Without Anti Curl)**, or **Roll Printer Case (Short Feed)**.

### Feed Distance Adjust

Specify the amount of paper fed after printing. This setting is available when **Roll/Fanfold Option** is set to **Custom Option**.

### Start Position Adjust

Specify the adjustment value to align the leading edge of the paper with the appropriate position. This setting is available when **Roll/Fanfold Option** is set to **Custom Option**.

### Cut Pause Time

Specify the waiting time for cutting between pages.

---

## Print Length Scaling

Specify the reduction or enlargement ratio for printing.

## Form Feed Mode

Specify how the printer responds to form feed commands received from any source.

## Paper Grip Time

Specify the delay before the printer grabs the paper.

## Pre-Feed

When you select **Enable**, the printer ejects a short length of paper when the printer turns on. When using perforated roll paper or roll paper that is pre-printed, we recommend setting this parameter to **Disable**.

## Blackmark Threshold

Adjusts the threshold value for determining black marks on paper with black marks. If the black marks are too light to recognize the stop position, set a value that is smaller than the current value.

## Page Overrun

If the print data does not fit on one page and runs onto the second page, select whether to cancel or print the data on the second page.

## Advanced (2) Tab

### Print Data after Printing

Allows to erase print data after it is printed.

### JPEG Printing Setting

Select the method of image processing when printing JPEG images.

### Simple Binary Threshold

Specify the simple binary threshold when **JPEG Printing Setting** is set to **Simple Binary**.

### Scale JPEG images to fit media

Allows enlarging or reducing a JPEG image to fit the paper size.

### Airplane Mode

Allows disabling the Bluetooth or Wi-Fi interfaces. This function is useful when you use the printer in a place where signal transmissions are not allowed.

## ESC/P Legacy (1) Tab

### Paper Size

Select the default paper size.



If this parameter is changed in the printer driver's dialog box, it has priority.

### Form Length

This parameter can be set only when **Paper Size** is set to **Custom**.

Form length is determined by specifying the number of lines per page, or the length in inches of each page. The available settings differ depending on the selected **Text Line Spacing** settings.

### Bottom Margin

The setting specified for this parameter takes effect only when **Paper Size** is set to **Custom**.

The height of the bottom margin is expressed in lines of text. The available settings differ depending on the selected **Text Line Spacing** settings.

### Text Line Spacing

Specify the height of each line of text.

---

**Left Margin**

Specify the left margin.

**Right Margin**

Specify the right margin.

**Default Pitch**

Specify character width.

**CR-LF Mode**

Specify how the printer responds when LF (line feed) and CR (carriage return) commands (ASCII characters 10 and 13) are received.

## ESC/P Legacy (2) Tab

**Extended Characters**

Specify which characters are used when printing ASCII characters 128 to 255.

**Character Set Map**

Specify which character set is used, allowing you to print special characters appropriate for the language selected.

**Default Font**

Specify which built-in font is used.

**Reduce Character Size**

Specify whether text is printed at a reduced size.

**Character Attributes**

Specify the attributes used for printed text.

## Related Information

- [Change Printer Settings Using the Printer Setting Tool \(Windows\)](#)

## P-touch Template Settings of the Printer Setting Tool (Windows)

P-touch Template mode allows you to insert data into text and barcode objects from a downloaded template using other devices connected to the printer. The available options and supplies may vary depending on your country. Use P-touch Template Settings in the Printer Setting Tool to specify or change P-touch Template functions.



- P-touch Template mode is also compatible with other input devices like a scale, testing printer, controller, or a programmable logic device.
- For more information on P-touch Template Settings, see the *P-touch Template Manual/Command Reference* (English only). You can download the latest version from the Brother support website at [support.brother.com/manuals](http://support.brother.com/manuals).

The screenshot shows the 'P-touch Template Settings' dialog box for a Brother printer. It contains the following fields and options:

- 1. Default Command Mode: P-touch Template (dropdown)
- 2. Default Template Number: 1 (spin box)
- 3. Data Delimiter for P-touch Template: \09 (text box)
- 4. Trigger for P-touch Template Printing:
  - Command Character: ^FF (radio button selected, text box)
  - Data Insertion into All the Objects: (radio button)
  - Received Data Size: 10 bytes (radio button, spin box)
- 5. Character Code Table: Windows 1252 (dropdown)
- 6. International Character Set: United States (dropdown)
- 7. Command Prefix Character: ^ (text box)
- 8. Non-Printed Character: (text box)
- 9. Available Return Code: ^CR (dropdown)
- 10. Replace FNC1: (checkbox)
- 11. Default Print Option:
  - Number of Copies: 1 (spin box)
  - Inverted 180 Degrees: (checkbox)
- 13. Default (button)
- 14. Cancel (button)
- 15. Set (button)

### 1. Default Command Mode

Specify the P-touch Template mode as the default mode.

### 2. Default Template Number

Select a default template number that the printer sets when it is turned on. If you do not want to transfer a template to the printer, do not specify a template number.

### 3. Data Delimiter for P-touch Template

Displays a symbol used to indicate the boundaries between groups of data in a file (maximum of 20 characters).

### 4. Trigger for P-touch Template Printing

Specify a trigger to begin printing from a number of options.

- **Command Character:** Printing starts when the command character specified here is received.
- **Data Insertion into All the Objects:** Printing starts when the delimiter for the last object is received.

- 
- **Received Data Size:** Printing starts when the number of characters specified here is received. However, delimiters are not counted in the number of characters.

#### 5. Character Code Table

Select one of the character code sets.

#### 6. International Character Set

Lists character sets for specific countries. The following codes vary depending on the selected country:

**23h 24h 40h 5Bh 5Ch 5Dh 5Eh 60h 7Bh 7Ch 7Dh 7Eh**

To change the characters, see the *P-touch Template Manual/Command Reference* (English only). You can download the latest version from the Brother support website at [support.brother.com/manuals](http://support.brother.com/manuals).

#### 7. Command Prefix Character

Specify the prefix character code identifying commands used in P-touch Template mode.

#### 8. Non-Printed Character

Characters specified here are not printed when data is received (maximum of 20 characters).

#### 9. Available Return Code

The line feed code is used when feeding data to indicate that the following data should be moved to the next line in a text object. Select one of four line feed codes or type the line feed code you want (maximum of 20 characters).

#### 10. Replace FNC1

Replaces GS codes with FNC1.

#### 11. Number of Copies

Sets the number of copies (maximum of 99 copies).

#### 12. Inverted 180 Degrees

If this checkbox is selected, the data will be printed after it has been rotated 180 degrees.

#### 13. Default

Returns all setting values in the P-touch Template Settings dialog box to the default values.

#### 14. Cancel

Cancels the settings and closes the dialog box. The settings remain unchanged.

#### 15. Set

Applies the settings to the printer. To save the specified settings to a command file to reuse in the future, select the **Save in Command File** command from the drop-down list.

The saved command file can be used with the mass storage mode to apply the settings to a printer.



### Related Information

- [Change Printer Settings Using the Printer Setting Tool \(Windows\)](#)

#### Related Topics:

- [Print Using the USB Interface \(Mass Storage Mode\)](#)
-



## Apply Setting Changes to Multiple Printers (Windows)

>> [Communication Settings \(PJ-862/PJ-863/PJ-883\)](#)

>> [Device Settings](#)

### Communication Settings (PJ-862/PJ-863/PJ-883)

1. After applying settings to the first printer, disconnect the printer from the computer, and then connect the second printer to the computer.
2. Select the newly connected printer from the **Printer** drop-down list.  
If the **Automatically detects the connected printer, and retrieves the current settings** checkbox in the **Option Settings** dialog box is selected, the printer connected with the USB cable is automatically selected.
3. Click **Apply**.  
PJ-883: We recommend selecting the **Automatically restart the printer after applying new settings** checkbox when configuring the first printer so that you can confirm that the printer can be correctly connected to the wireless router/access point with the new settings.  
The same settings that were applied to the first printer are applied to the second printer.
4. Repeat these steps for all printers whose settings you want to change.



- PJ-883: If the IP address is set to **STATIC**, the printer's IP address is changed to the same address as the first printer. Change the IP address if needed.
- The same settings can be applied to another computer by clicking **File > Import**, and then selecting the exported settings file.

### Device Settings

1. After applying settings to the first printer, disconnect the printer from the computer, and then connect the second printer to the computer.
2. Select the newly connected printer from the **Printer** drop-down list.
3. Click **Apply**.  
The same settings that were applied to the first printer are applied to the second printer.
4. Repeat these steps for all printers whose settings you want to change.



The same settings can be applied to another computer by clicking **File > Import**, and then selecting the exported settings file.

### ✓ Related Information

- [Printer Settings](#)

## Change Printer Settings Using the Printer Setting Tool (Mac)

- Make sure the printer driver has been installed correctly and you can print.
- Connect the printer to a computer with a USB cable.  
PJ-883: Settings cannot be specified via Wi-Fi when using this tool.  
PJ-862/PJ-863/PJ-883: Settings cannot be specified via Bluetooth when using this tool.



The Printer Setting Tool is installed in addition to the printer driver and other software when using the installer.

1. Connect the printer you want to configure to the computer.
2. Double-click **Macintosh HD > Applications > Brother > Printer Setting Tool > Printer Setting Tool.app**.  
The **Printer Setting Tool** window appears.
3. Check that the printer you want to configure appears next to **Printer**.  
If a different printer appears, select the printer you want from the pop-up menu.
4. Specify or change the settings in the Settings tabs.
5. Click the **Apply Settings to the Printer** button to apply the settings to the printer.
6. Click **Exit**.



Use the Printer Setting Tool to configure the printer only when the printer is idle. The printer may malfunction if you try to configure it while it is processing or printing.



### Related Information

- [Printer Settings](#)
  - [Setting Dialog Box of Printer Setting Tool \(Mac\)](#)

## Setting Dialog Box of Printer Setting Tool (Mac)

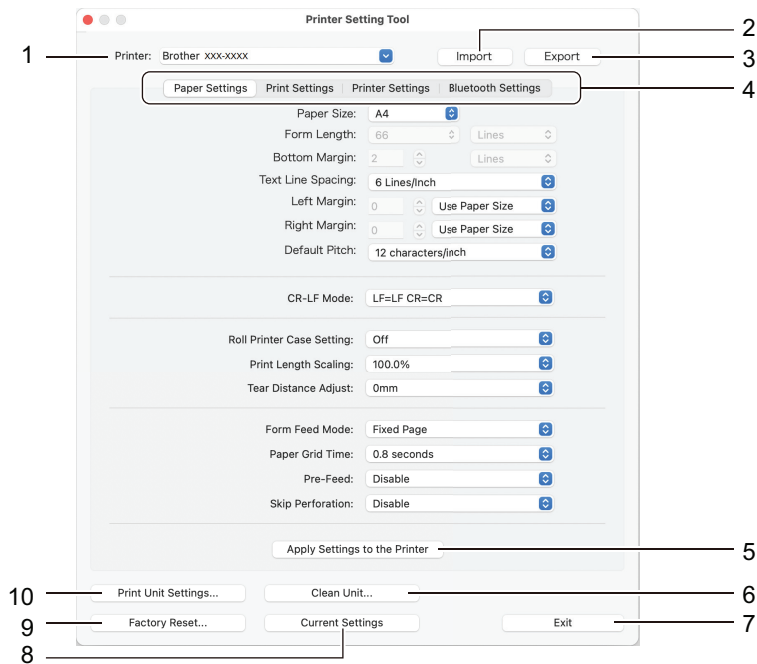

### 1. Printer

Lists the connected printers.

### 2. Import

Imports settings from a file.

### 3. Export

Saves the current settings in a file.

### 4. Settings Tabs

Contains settings to specify or change.

### 5. Apply Settings to the Printer

Apply the settings to the printer.

### 6. Clean Unit

Select to clean the platen roller of the printer by feeding the dedicated cleaning sheet.

### 7. Exit

Click to exit the Printer Setting Tool.

### 8. Current Settings

Retrieves the settings from the currently connected printer and displays them in the dialog box.

### 9. Factory Reset

Reset all the settings to the factory settings, including device settings.

### 10. Print Unit Settings

Print a report containing firmware version, paper size, and configuration information.

>> [Paper Settings Tab](#)

>> [Print Settings Tab](#)

>> [Printer Settings Tab](#)

>> [Bluetooth Settings Tab \(PJ-862/PJ-863/PJ-883\)](#)

>> [Wireless LAN Tab \(PJ-883\)](#)

## Paper Settings Tab

### Paper Size

Select the default paper size.

### Form Length

This parameter can be set only when **Paper Size** is set to **Custom**.

Form length is determined by specifying the number of lines per page, or the length in inches of each page. The available settings differ depending on the selected **Text Line Spacing** settings.

### Bottom Margin

The setting specified for this parameter takes effect only when **Paper Size** is set to **Custom**.

The height of the bottom margin is expressed in lines of text. The available settings differ depending on the selected **Text Line Spacing** settings.

### Text Line Spacing

Specify the height of each line of text.

### Left Margin

Specify the left margin.

### Right Margin

Specify the right margin.

### Default Pitch

Specify character width.

### CR-LF Mode

Specify how the printer responds when LF (line feed) and CR (carriage return) commands (ASCII characters 10 and 13) are received.

### Roll Printer Case Setting

Specify the setting for using the optional roll printer case. Depending on the selected option, you can adjust the feed value or amount of paper retraction for the roll printer case.

Option	Description
Off	Select this option when not using the roll printer case.
On (Without Anti Curl)	Select this option when not using the anti-curl mechanism while using the roll printer case.
On (With Anti Curl)	Select this option when using the anti-curl mechanism while using the roll printer case.
On (Short Feed)	Using the roll printer case with paper passed through the anti-curl mechanism causes the paper to have pressure marks. Use this option to make sure the pressure marks are not printed.

### Print Length Scaling

Specify the reduction or enlargement ratio for printing.

### Tear Distance Adjust

Adjust the Tear Bar tear-off position for paper media.

### Form Feed Mode

Specify how the printer responds to form feed commands received from any source.

### Paper Grip Time

Specify the delay before the printer grabs the paper.

## Pre-Feed

When you select **Enable**, the printer ejects a short length of paper when the printer turns on. When using perforated roll paper or roll paper that is pre-printed, we recommend setting this parameter to **Disable**.

## Skip Perforation

Leaves a one-inch (25.4 mm) margin at the top and bottom of the paper. Use it when printing on perforated roll paper so that the printer does not print on the perforation.

## Print Settings Tab

### Command Mode

Specify the printer's command format.

### Print Density

Select the printing density.

### Print Speed

Select the printer's printing speed.

Option	Description
1.1 ips / 27 mm/s	Select these options when you want to prioritize image quality.
1.9 ips / 48 mm/s	
2.7 ips / 70 mm/s	
3.5 ips / 90 mm/s	This setting balances speed and image quality. Select this option when printing standard documents.
Fast (Draft Quality)	Speed priority mode. Select this option when printing documents containing bold text.
Fast (Line Conversion)	Speed priority mode. Select this option when printing documents with ruled pages or bold text.

### Extended Characters

Specify which characters are used when printing ASCII characters 128 to 255.

### Character Set Map

Specify which character set is used, allowing you to print special characters appropriate for the language selected.

### Default Font

Specify which built-in font is used.

### Character Attributes

Specify the attributes used for printed text.

### Dash Line Print

Prints dash lines between pages, which is useful when printing on roll paper. Set **Form Feed Mode** to **Fixed Page**, and then select **Enable**. Note that dash lines are printed on the paper; they are not punched into the paper.

### Stencil Paper Mode

This mode is suitable for printing on stencil paper. Turn this setting on when printing on stencil paper.

## Printer Settings Tab

### Auto Power On

Specify how the printer responds when connected to a USB, an AC or DC power outlet.

### Auto Power Off

Specify the amount of time that passes before the printer turns off automatically.

---

### Blackmark Threshold

Adjusts the threshold value for determining black marks on paper with black marks. If the black marks are too light to recognize the stop position, set a value that is smaller than the current value.

### Print Data after Printing

Specify whether print data is erased after printing.

### JPEG Printing Setting

Select the method of image processing when printing JPEG images.

### Scale JPEG images to fit media

Allows enlarging or reducing a JPEG image to fit the paper size.

### Airplane Mode

Allows disabling the Bluetooth or Wi-Fi interfaces. This function is useful when you use the printer in a place where signal transmissions are not allowed.

## Bluetooth Settings Tab (PJ-862/PJ-863/PJ-883)

### Bluetooth Device Name

Displays the Bluetooth device name.

### Bluetooth Address

Displays the acquired Bluetooth address.

### Visible to Other Devices

Allows the printer to be discovered by other Bluetooth devices.

### Change PIN code

If **On** is selected, you can change the compliant PIN code with Bluetooth 2.0 or earlier.

### Request Secure Simple Pairing (SSP) settings during pairing

If this checkbox is selected, pairing can be performed using the printer buttons for compliant devices with Bluetooth 2.1 or later.

## Wireless LAN Tab (PJ-883)

### WirelessDirect

Turns the Wireless Direct function on or off.

### SSID/Network Key Generation

Select the **AUTO** or **STATIC** option.

### SSID(Network Name)/Network Key

Specify the SSID (3 to 25 ASCII characters) and the network key you want to use in the Wireless Direct mode. You can specify a setting only when the **STATIC** option is selected as **SSID/Network Key Generation**.

### Display current settings

Displays the current settings for Wireless Direct. Click the **Current Settings** button to update the displayed settings with the most recent information.

## Related Information

- [Change Printer Settings Using the Printer Setting Tool \(Mac\)](#)

## Apply Setting Changes to Multiple Printers (Mac)

1. After applying settings to the first printer, disconnect the printer from the computer, and then connect the second printer to the computer.
2. Select the newly connected printer from the **Printer** pop-up menu.
3. Click **Apply Settings to the Printer**.  
The same settings that were applied to the first printer are applied to the second printer.
4. Repeat these steps for all printers whose settings you want to change.



### Related Information

- [Printer Settings](#)
-

## Change Printer Settings Using Web Based Management

**Related Models:** PJ-883

You can use a standard web browser to change your printer's settings using the Hyper Text Transfer Protocol (HTTP) or Hyper Text Transfer Protocol over Secure Socket Layer (HTTPS).

When using Web Based Management, the following operations are available:

- Displaying your printer status information
- Changing network settings, such as TCP/IP information
- Displaying the printer's software version information
- Changing network and printer configuration details



- We recommend Microsoft Internet Explorer 11/Microsoft Edge for Windows, Safari 10/11 for Mac, Google Chrome™ for Android (4.x or later), and Google Chrome™/Safari for iOS (10.x or later). Make sure that JavaScript and Cookies are always enabled in whichever browser you use.
- The default login password to manage printer settings is located on your printer and marked "Pwd". We recommend you change it to protect your printer from unauthorized access.

To use Web Based Management, your network must use TCP/IP, and the printer and computer must have a valid IP address.

1. Start your web browser.
2. Type "https://printer's IP address" in your browser's address bar.

For example:

https://192.168.1.2



If you are using a Domain Name System or enable a NetBIOS name, you can type another name, such as "SharedPrinter" instead of the IP address.

For example:

https://SharedPrinter

If you enable a NetBIOS name, you can also use the node name.

For example:

https://brnxxxxxxxxxxxx

3. If required, type the password in the **Login** field, and then click **Login**.
4. Change the printer settings.

Every time you access Web Based Management, type the password in the **Login** field, and then click **Login**. After configuring the settings, click **Logout**.



### Related Information

- [Printer Settings](#)
- [Set or Change a Login Password for Web Based Management](#)



## Set or Change a Login Password for Web Based Management

**Related Models:** PJ-883

The default password to manage this printer's settings is located in the battery cavity and marked "**Pwd**". We recommend immediately changing the default password to protect your printer from unauthorized access.

1. Start your web browser.
2. Type "https://printer's IP address" in your browser's address bar.

For example:

https://192.168.1.2



If you are using a Domain Name System or enable a NetBIOS name, you can type another name, such as "SharedPrinter" instead of the IP address.

For example:

https://SharedPrinter

If you enable a NetBIOS name, you can also use the node name.

For example:

https://brnxxxxxxxxxxxx

3. Do one of the following:
  - If you have previously set your own password, type it, and then click **Login**.
  - If you have not previously set your own password, type the default login password, and then click **Login**.
4. Go to the navigation menu, and then click **Administrator** > **Login Password**.



- The default password to manage this printer's settings is located in the battery cavity and is marked "**Pwd**".
- Start from  if the navigation menu is not shown on the left side of the screen.

5. To change the password, type your current password in the **Enter Old Password** field.
6. Following the on-screen **Login Password** guidelines, type your new password in the **Enter New Password** field.
7. Retype the new password in the **Confirm New Password** field.
8. Click **Submit**.



You can also change the lockout settings in the **Login Password** menu.





### Related Information

- [Change Printer Settings Using Web Based Management](#)

## Confirm Printer Settings

To confirm the printer settings, you can print a Letter-size configuration report without connecting the printer to a computer or mobile device. (The report will fit on A4-size paper.)

1. Turn on the printer.
2. Make sure no paper is loaded.
3. Press and hold the Feed button  until the Data indicator lights in red .
4. Insert a piece of genuine Brother thermal paper into the printer's paper input slot.

The report starts printing.



The report indicates the model name, serial number, and more detailed information on the printer's configuration and parameter settings.

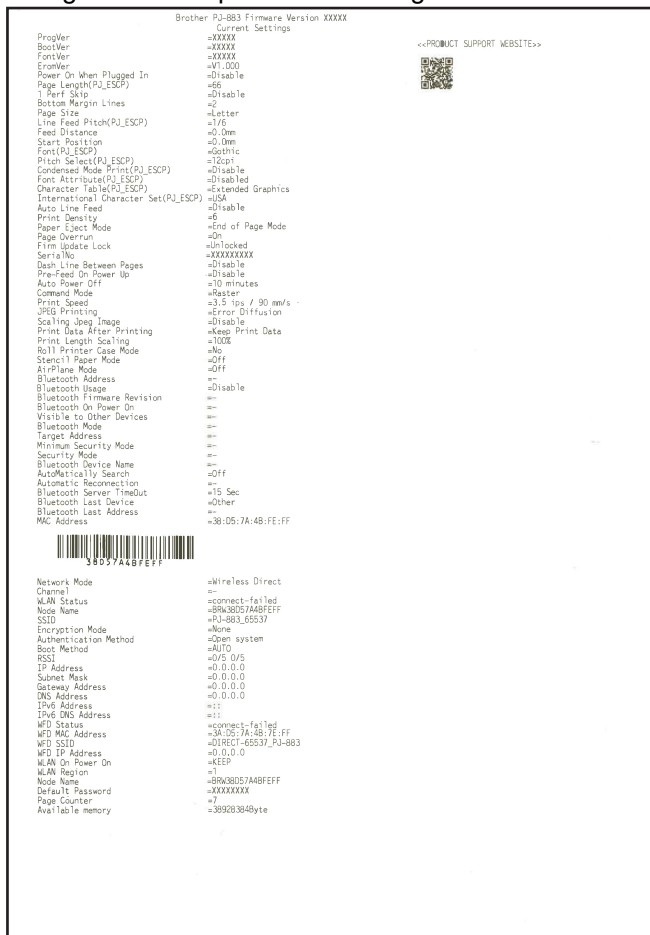

### Related Information

- [Printer Settings](#)

## Routine Maintenance

- [Maintenance](#)

## Maintenance

Maintenance of the printer may be carried out as required. However, some environments may require more frequent maintenance (for example, dusty environments).

- >> [Clean the Platen Roller](#)
- >> [Clean the Printer's Surface](#)
- >> [Clear a Paper Jam](#)

### Clean the Platen Roller

Dirt and debris on the Platen Roller can cause the paper to be fed incorrectly (skewing the print image) and degrade the print quality (distorting the print image).

1. Turn on the printer and make sure no paper is loaded.
2. Insert the cleaning sheet into the Paper Input Slot.

The text "CLEANING SHEET" should be upright and face the front of the printer, as shown. The roller will pull the cleaning sheet into the starting position.

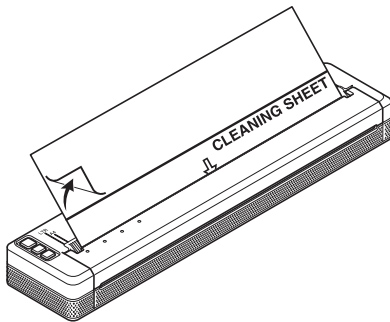

3. Remove the backing paper on the upper half of the cleaning sheet, as shown.

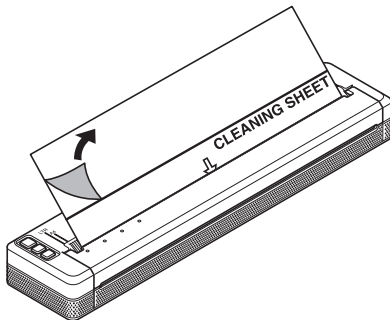

---

Do not remove the backing paper from the lower half of the cleaning sheet.

---

4. Press the Feed button  for more than two seconds.

The printer will feed and eject the cleaning sheet.



- 
- Do not attempt to clean the Platen Roller with any material other than the cleaning sheet.
  - The cleaning sheet is for cleaning the Platen Roller only. Do not use it to clean any other part of the printer.
  - Contact Brother or your Brother dealer for a replacement cleaning sheet.
-

---

## Clean the Printer's Surface

Wipe the printer's surface with a dry cloth.

### IMPORTANT

- Do not use a wet cloth or allow water to enter the printer.
- Do not use benzene, alcohol, paint thinner, or cleaners that are abrasive, alkaline, or acidic. Such cleaners may damage the printer's surface.

---

## Clear a Paper Jam

1. Carefully lift the Release Cover up to open it.

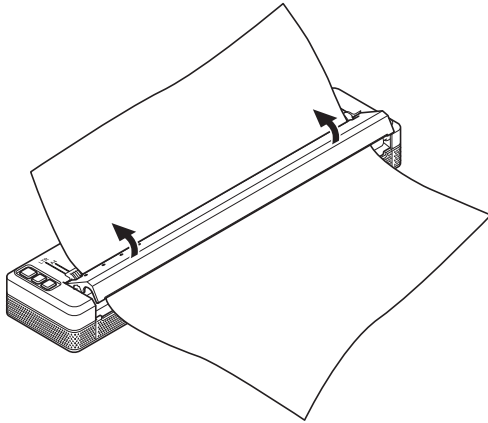

2. Carefully pull the paper out of the printer in either direction.

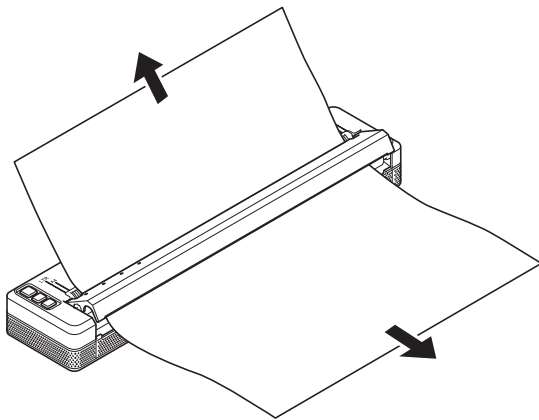

3. Close the Release Cover.
4. Insert paper and print again.

### ✓ Related Information

- [Routine Maintenance](#)

## Troubleshooting

- [If You Are Having Difficulty with Your Printer](#)
- [Printing Problems](#)
- [Network Problems](#)
- [Version Information](#)
- [Reset the Printer](#)

## If You Are Having Difficulty with Your Printer

This chapter explains how to resolve typical problems you may encounter when using the printer. If you have any problems with the printer, first make sure you have performed the following tasks correctly:

- Install the Rechargeable Li-ion Battery or connect the printer to an AC or DC power outlet.  
For more information, see *Related Topics*: [Install the Rechargeable Li-ion Battery](#).  
For more information, see *Related Topics*: [Connect the Printer to External Power](#).
- Remove all protective packaging from the printer.
- Install and select the correct printer driver.  
For more information, see *Related Topics*: [Install Printer Drivers and Software on a Computer](#).
- Connect the printer to a computer or mobile device.  
For more information, see *Related Topics*: [Connect the Printer to a Computer or Mobile Device](#).
- Close the Release Cover completely.
- Load the paper correctly.  
For more information, see *Related Topics*: [Load Paper in the Printer](#).

If you still have problems, see *Related Information*. If after reading the topics you are unable to resolve the problem, visit the Brother support website at [support.brother.com](http://support.brother.com).



### Related Information

- [Troubleshooting](#)

#### Related Topics:

- [Install the Rechargeable Li-ion Battery](#)
- [Connect the Printer to External Power](#)
- [Connect the Printer to a Computer or Mobile Device](#)
- [Install Printer Drivers and Software on a Computer](#)
- [Load Paper in the Printer](#)

## Printing Problems

- >> Indicator Warnings
- >> Paper Problems
- >> Printed Image Problems
- >> Pages Do Not Print
- >> Pages Are Partially Printed

### Indicator Warnings

Problem	Solution
The Power Indicator does not light.	<p>The printer is receiving no power.</p> <p>If you are using AC or DC power, connect the AC Adapter or Car Adapter correctly and turn the AC or DC power outlet on.</p> <p>For more information, see <i>Related Topics</i>: Connect the Printer to External Power.</p> <p>If you are using a Rechargeable Li-ion Battery, make sure the battery is firmly installed in the printer and is fully charged.</p>
Received data in buffer	<p>Print data is saved in the buffer. If the printer receives incomplete data (for example because of a lost Wi-Fi connection), printing will not start. Turn off the printer, and then turn it on again.</p>
Head, motor, or Rechargeable Li-ion Battery is cooling down.	<p>The thermal head, motor, or Rechargeable Li-ion Battery is too hot.</p> <p><b>Head:</b></p> <p>The printer stops and resumes printing only after the thermal head has cooled down. The head may become too hot if you are printing a large number of documents with high text content.</p> <p>If the thermal head becomes too hot, it may produce imaging on the paper in areas not intended to be printed.</p> <p>To avoid or delay this condition, print using a lighter density setting, reduce the amount of black space being printed (for example, remove background shading and colors in graphs and presentation documents), and make sure that the printer has adequate ventilation and is not located in an enclosed space.</p> <p><b>Motor or Rechargeable Li-ion Battery:</b></p> <p>Do not use the printer continuously. If the printer is used continuously, the motor or Rechargeable Li-ion Battery will become too hot. In this case, the printer will stop and resume printing after the motor or Rechargeable Li-ion Battery has cooled down.</p> <div style="background-color: #e6f2ff; padding: 5px; margin-top: 10px;"> <p><b>NOTE</b></p> <p>This condition may occur more often when the printer is used at high altitude (more than 10,000 ft (3,048 m)) due to a lower air density available to cool the printer.</p> </div>
Data reception error	<p>With unstable communication, it may not be possible to receive data correctly. Improve the communication conditions, and then establish the connection again.</p>
Printer is in boot mode.	<p>To resolve the issue, contact your Brother dealer or Brother Customer Service for assistance.</p>

### Paper Problems





















Problem	Solution
The paper is jammed in the printer.	See <i>Related Topics</i> : Maintenance.



Problem	Solution
The paper feeds through the printer, but nothing appears on the paper.	<ul style="list-style-type: none"> <li>• Make sure you are using thermal paper.</li> <li>• The print surface must face the back, when looking from the front of the printer.</li> <li>• Check the print density setting using the Printer Setting Tool.</li> </ul> <p>For more information, see <i>Related Topics: Change Printer Settings Using the Printer Setting Tool (Windows)</i>.</p> <p>For more information, see <i>Related Topics: Change Printer Settings Using the Printer Setting Tool (Mac)</i>.</p>
The paper does not feed even though the motor is running.	<ul style="list-style-type: none"> <li>• The Release Cover must be completely closed.</li> <li>• Make sure you are using genuine Brother thermal paper. Other paper may not feed through the printer correctly.</li> <li>• Clean the Platen Roller.</li> </ul> <p>For more information, see <i>Related Topics: Maintenance</i>.</p> <p>If you still have problems, the printer may be damaged. Contact your Brother dealer or Brother Customer Service for assistance.</p>







## Printed Image Problems

















Problem	Solution
The printed image is out of alignment.	<p>Make sure you are using genuine Brother thermal paper and the paper is loaded correctly.</p> <p>For more information, see <i>Related Topics: Load Paper in the Printer</i>.</p> <p>Check whether the Platen Roller is dirty. If it is dirty, clean it.</p> <p>For more information, see <i>Related Topics: Maintenance</i>.</p>
Print quality is poor, and the printed image is too light or too dark.	<p>Adjust the print density setting in the printer driver's dialog box, or in the Printer Setting Tool.</p> <p>For more information, see <i>Related Topics: Change Printer Settings Using the Printer Setting Tool (Windows)</i>.</p> <p>For more information, see <i>Related Topics: Change Printer Settings Using the Printer Setting Tool (Mac)</i>.</p> <p>Make sure you are using genuine Brother thermal paper.</p>
The image is compressed and stretched in many places.	<p>Make sure the Release Cover was not left open during printing. If it is open, close it completely.</p> <p>Check if the paper is slipping in the printer. If it is slipping, make sure the Platen Roller is clean.</p> <p>For more information, see <i>Related Topics: Maintenance</i>.</p> <p>You must use genuine Brother thermal paper. Before loading paper, make sure it is not wrinkled.</p>
The top margin is incorrect.	<p>Make sure the correct margins have been set in the Printer Setting Tool or your application. Adjust the top and bottom margins as needed.</p> <p>Make sure you are not forcefully inserting the paper into the Paper Input Slot. Always insert paper carefully.</p>
The side margins are incorrect.	<p>Make sure the correct margins have been set in the Printer Setting Tool or your application. Adjust the left margin as needed.</p> <p>Make sure the application, the printer, and the printer driver have been set to match the paper size of the paper that is loaded in the printer. If the application or printer driver has been set to a different paper width, the image will not be printed in the proper horizontal position. Adjust the settings as needed.</p>
The printed page contains incorrect characters.	<p>Make sure you have defined the correct character set (font) in the application. Try changing the font used in the document.</p>

Problem	Solution
<p>This printer is not detected when establishing a Bluetooth connection. (PJ-862/PJ-863)</p>	<ol style="list-style-type: none"> <li>1. Check that the Bluetooth indicator  is lit in blue .</li> </ol> <p>If the Bluetooth indicator  is flashing or turned off, the Bluetooth connection is not established.</p> <p>To establish a Bluetooth connection, see <i>Related Topics: Connect the Printer to a Computer Using Bluetooth Connection</i>.</p> <hr/> <p> Depending on your computer's or mobile device's operating system, the printer connects via Bluetooth only when receiving data. The Bluetooth indicator is lit in blue  while receiving data, and it will start flashing when data reception is complete.</p> <hr/> <ol style="list-style-type: none"> <li>2. Check the Bluetooth settings.</li> </ol> <p>To print the configuration report, see <i>Related Topics: Confirm Printer Settings</i>.</p> <p>Specify the correct Bluetooth settings in the Printer Setting Tool.</p> <p>For more information, see <i>Related Topics: Change Printer Settings Using the Printer Setting Tool (Windows)</i>.</p> <p>For more information, see <i>Related Topics: Change Printer Settings Using the Printer Setting Tool (Mac)</i>.</p>
<p>This printer is not detected when establishing a Bluetooth connection. (PJ-883)</p>	<ol style="list-style-type: none"> <li>1. Check that the Bluetooth and Wi-Fi indicator  is lit in blue  or cyan .</li> </ol> <p>When the Bluetooth and Wi-Fi indicator  is lit in cyan , Wi-Fi may be connected, but Bluetooth may not be connected.</p> <p>If the Bluetooth and Wi-Fi indicator  is flashing or turned off, the Bluetooth connection is not established.</p> <p>To establish a Bluetooth connection, see <i>Related Topics: Connect the Printer to a Computer Using Bluetooth Connection</i>.</p> <hr/> <p> Depending on your computer's or mobile device's operating system, the printer connects via Bluetooth only when receiving data. The Bluetooth and Wi-Fi indicator is lit in blue  or cyan  while receiving data, and it will start flashing when data reception is complete.</p> <hr/> <ol style="list-style-type: none"> <li>2. Check the Bluetooth settings.</li> </ol> <p>To print the configuration report, see <i>Related Topics: Confirm Printer Settings</i>.</p> <p>Specify the correct Bluetooth settings in the Printer Setting Tool.</p> <p>For more information, see <i>Related Topics: Change Printer Settings Using the Printer Setting Tool (Windows)</i>.</p> <p>For more information, see <i>Related Topics: Change Printer Settings Using the Printer Setting Tool (Mac)</i>.</p>
<p>This printer is not detected when establishing a Wi-Fi connection. (PJ-883)</p>	<ol style="list-style-type: none"> <li>1. Check that the Bluetooth and Wi-Fi indicator  is lit in green  or cyan .</li> </ol> <p>When the Bluetooth and Wi-Fi indicator  is lit in cyan , Bluetooth may be connected, but Wi-Fi may not be connected.</p> <p>If the Bluetooth and Wi-Fi indicator  is flashing or turned off, the Wi-Fi connection is not established.</p> <p>To establish a Wi-Fi connection, see <i>Related Topics: Connect the Printer to a Computer Using Wi-Fi</i>.</p>

Problem	Solution
	<p>2. Check the Wi-Fi settings.</p> <p>To print the configuration report, see <i>Related Topics: Confirm Printer Settings</i>.</p> <p>Consult with the network administrator and specify the correct Wi-Fi settings in the Printer Setting Tool.</p> <p>For more information, see <i>Related Topics: Change Printer Settings Using the Printer Setting Tool (Windows)</i>.</p> <p>For more information, see <i>Related Topics: Change Printer Settings Using the Printer Setting Tool (Mac)</i>.</p>
The Wi-Fi connection is taking too long to establish. (PJ-883)	From initialization to completing the connection takes time, so it may take a minute or more to establish the Wi-Fi connection. Since this differs depending on the device you use with your Brother printer and environment, check with the device manufacturer.
I want to reset the printer/delete the data transferred from a computer or mobile device.	See <i>Related Topics: Reset the Printer</i> .

## Pages Do Not Print



Problem	Solution
<p>The Data Indicator remains lit in green  but the printer does not print.</p>	<ul style="list-style-type: none"> <li>Printing of all received data is not completed. Wait until it is finished.</li> <li>If paper is not loaded, load the paper.</li> <li>If the printer does not print even though paper is loaded, remove the paper, and then load it again.</li> <li>Try printing again after turning the printer off, and then on again.</li> </ul> <hr/> <p> If the printer is connected via Wi-Fi, the connection is lost when the printer is turned off. When the printer is turned on again, it will take up to 15 seconds for Wi-Fi to become functional. (PJ-883)</p> <hr/> <ul style="list-style-type: none"> <li>There may be problems with sending simple ASCII text data to the printer. If the CR/LF command is not at the end of lines or the form feed command is not at the end of the last line, the printer may be waiting for this data to be sent. Print another page, or press the Feed button  to feed the paper.</li> <li>The printer may have been started up in mass storage mode. For more information, see <i>Related Topics: Print Using the USB Interface (Mass Storage Mode)</i>. Turn off the printer, and then turn it on again.</li> </ul>
<p>The application should be sending data to the printer, but the Data Indicator does not light in green .</p>	<p>With a USB connection:</p> <ol style="list-style-type: none"> <li>Connect the USB cable firmly and correctly.</li> <li>Try using another USB cable.</li> </ol> <p>With a Bluetooth connection (PJ-862/PJ-863/PJ-883):</p> <ol style="list-style-type: none"> <li>- (PJ-862/PJ-863) Check that the Bluetooth indicator  is lit in blue .</li> </ol> <p>If the Bluetooth indicator  is flashing or turned off, the Bluetooth connection is not established.</p> <p>To establish a Bluetooth connection, see <i>Related Topics: Connect the Printer to a Computer Using Bluetooth Connection</i>.</p>

Problem	Solution
	<p> Depending on your computer's or mobile device's operating system, the printer connects via Bluetooth only when receiving data. The Bluetooth indicator is lit in blue  while receiving data, and it will start flashing when data reception is complete.</p> <hr/> <p>- (PJ-883) Check that the Bluetooth and Wi-Fi indicator () is lit in blue  or cyan .</p> <p>When the Bluetooth and Wi-Fi indicator () is lit in cyan , Wi-Fi may be connected, but Bluetooth may not be connected.</p> <p>If the Bluetooth and Wi-Fi indicator () is flashing or turned off, the Bluetooth connection is not established.</p> <p>To establish a Bluetooth connection, see <i>Related Topics: Connect the Printer to a Computer Using Bluetooth Connection</i>.</p> <hr/> <p> Depending on your computer's or mobile device's operating system, the printer connects via Bluetooth only when receiving data. The Bluetooth and Wi-Fi indicator is lit in blue  or cyan  while receiving data, and it will start flashing when data reception is complete.</p> <hr/> <p>2. Specify the correct Bluetooth settings in the Printer Setting Tool. For more information, see <i>Related Topics: Change Printer Settings Using the Printer Setting Tool (Windows)</i>. For more information, see <i>Related Topics: Change Printer Settings Using the Printer Setting Tool (Mac)</i>.</p> <p>With a Wi-Fi connection (PJ-883):</p> <p>1. Check that the Bluetooth and Wi-Fi indicator () is lit in green  or cyan .</p> <p>When the Bluetooth and Wi-Fi indicator () is lit in cyan , Bluetooth may be connected, but Wi-Fi may not be connected.</p> <p>If the Bluetooth and Wi-Fi indicator () is flashing or turned off, the Wi-Fi connection is not established.</p> <p>To establish a Wi-Fi connection, see <i>Related Topics: Connect the Printer to a Computer Using Wi-Fi</i>.</p> <p>2. Specify the correct Wi-Fi settings in the Printer Setting Tool. For more information, see <i>Related Topics: Change Printer Settings Using the Printer Setting Tool (Windows)</i>. For more information, see <i>Related Topics: Change Printer Settings Using the Printer Setting Tool (Mac)</i>.</p>

## Pages Are Partially Printed

Problem	Solution
The Data indicator turns off while a page remains in the printer.	<ul style="list-style-type: none"> <li>• The computer or mobile device may not have sent a full page of data. Try printing the document again.</li> <li>• The computer or mobile device may have sent the wrong page size information, or the size of the loaded paper is wrong. Check the paper size settings in the application, the Printer Setting Tool, and printer driver to make sure the specified paper size matches the paper that is loaded.</li> <li>• Try pressing the Feed button  to feed the paper manually.</li> </ul>

---

Problem	Solution
The printer ejects a partially printed page, and the Data indicator remains lit or flashing in green  /  .	Use the correct paper size setting.



## Related Information

- [Troubleshooting](#)

### Related Topics:





- [Connect the Printer to External Power](#)
  - [Maintenance](#)
  - [Change Printer Settings Using the Printer Setting Tool \(Windows\)](#)
  - [Change Printer Settings Using the Printer Setting Tool \(Mac\)](#)
  - [Load Paper in the Printer](#)
  - [Connect the Printer to a Computer Using Bluetooth Connection](#)
  - [Confirm Printer Settings](#)
  - [Connect the Printer to a Computer Using Wi-Fi](#)
  - [Reset the Printer](#)
  - [Print Using the USB Interface \(Mass Storage Mode\)](#)
-

## Network Problems

**Related Models:** PJ-862/PJ-863/PJ-883





- >> [Network Setup Problems](#)
- >> [Cannot Print over the Network / Printer Is Not Found on the Network Even after Successful Installation](#)
- >> [Security Software Problems](#)
- >> [Check the Operation of Network Devices](#)

### Network Setup Problems

Problem	Solution
You are using security software.	<ul style="list-style-type: none"> <li>• Confirm your settings in the printer driver installer dialog box.</li> <li>• Allow access when the security software alert message appears during the printer driver installation.</li> </ul>
Your security settings (SSID/ Network Key) are incorrect.	<p>Make sure the network security settings are correct:</p> <ul style="list-style-type: none"> <li>• See the instructions supplied with your Wi-Fi access point/router for information on how to find the security settings.</li> <li>• The default SSID (Network Name) may be your Wi-Fi access point/router's manufacturer name or model number.</li> <li>• Contact the manufacturer of your Wi-Fi access point/router or ask your Internet provider or network administrator.</li> </ul>
The printer is placed too far from your mobile device.	Move the printer within about 3.3 feet (one meter) of the mobile device when you configure the Wi-Fi network settings.
There are obstructions (walls or furniture, for example) between your printer and the mobile device.	Move the printer to an obstruction-free area.
A wireless computer, Bluetooth supported device, microwave oven or digital cordless phone is near the printer or the Wi-Fi access point/router.	Move other devices away from the printer.
You are using MAC Address filtering.	<p>Confirm the MAC address by printing the configuration report.</p> <p>For more information, see <i>Related Topics</i>: <a href="#">Confirm Printer Settings</a>.</p>
Your Wi-Fi access point/router is in stealth mode (not broadcasting the SSID).	<ul style="list-style-type: none"> <li>• Enter the correct SSID name during the installation or when using the Printer Setting Tool.</li> <li>• Check the SSID name in the instructions supplied with your Wi-Fi access point/router and set up your wireless network again.</li> </ul>
The printer is not connected correctly to the network. (PJ-883)	<p>Check the Bluetooth and Wi-Fi indicator  on the printer.</p> <p>Green : The network is correctly connected.</p> <p>Green  or cyan  (flashes once every three seconds): The network is not connected correctly, and the Wi-Fi settings must be reconfigured.</p> <p>Cyan : Bluetooth may be connected, but Wi-Fi may not be connected.</p> <p>To establish a Wi-Fi connection, see <i>Related Topics</i>: <a href="#">Connect the Printer to a Computer Using Wi-Fi</a>.</p>
I have checked and tried all of the above, but still cannot complete the wireless configuration.	Turn off the printer, and then turn it on again. Then try to configure the Wi-Fi settings again.

Problem	Solution
If the Bluetooth connection to my Apple device (iPad, iPhone, or iPod touch) is interrupted, I cannot reconnect to the printer.	Turn on the Auto Reconnect function. You can set it from the Printer Setting Tool. For more information, see <i>Related Topics: Change Printer Settings Using the Printer Setting Tool (Windows)</i> . For more information, see <i>Related Topics: Change Printer Settings Using the Printer Setting Tool (Mac)</i> .

## Cannot Print over the Network / Printer Is Not Found on the Network Even after Successful Installation





Problem	Solution
You are using security software.	<ul style="list-style-type: none"> <li>Confirm your settings in the printer driver installer dialog box.</li> <li>Allow access when the security software alert message appears during the printer driver installation.</li> </ul>
The printer is not assigned with an available IP address.	<ul style="list-style-type: none"> <li>Confirm the IP address and the Subnet Mask. Verify that both the IP addresses and Subnet Masks of your computer and the printer are correct and located on the same network. For more information on how to verify the IP address and the Subnet Mask, contact your network administrator.</li> <li>Confirm your IP address, Subnet Mask and other network settings using the Printer Setting Tool. For more information, see <i>Related Topics: Change Printer Settings Using the Printer Setting Tool (Windows)</i>. For more information, see <i>Related Topics: Change Printer Settings Using the Printer Setting Tool (Mac)</i>.</li> </ul>
The print job failed.	If the print job is still in your computer's print queue, delete it. For example, when using Windows 10: Click <b>Start &gt; Settings &gt; Devices &gt; Printers &amp; scanners</b> . Click your printer, and then click <b>Open queue</b> . Click <b>Printer &gt; Cancel All Documents</b> .
The printer is not connected correctly to the network. (PJ-883)	Check the Bluetooth and Wi-Fi indicator (📶) on the printer. Green  : The network is correctly connected. Green  or cyan  (flashes once every three seconds): The network is not connected correctly, and the Wi-Fi settings must be reconfigured. Cyan  : Bluetooth may be connected, but Wi-Fi may not be connected. To establish a Wi-Fi connection, see <i>Related Topics: Connect the Printer to a Computer Using Wi-Fi</i> .
I have checked and tried all the above, but my printer does not print.	Uninstall the printer driver and software, and then reinstall them.

## Security Software Problems

Problem	Solution
You did not select to allow access when the security alert dialog box appeared during either the standard installation, BRAdmin Light installation, or when printing.	If you did not select to accept the security alert dialog box, the firewall function of your security software may be rejecting access. Some security software may block access without showing a security alert dialog box. To allow access, see the instructions of your security software or contact the manufacturer.
Incorrect port numbers are being used for the Brother network features	The following port number is used for Brother network features: BRAdmin Light: Port number 161 / Protocol UDP

Problem	Solution
	For more information about how to open the port, see the instructions for the security software or contact its manufacturer.

## Check the Operation of Network Devices

Problem	Solution
The printer and Wi-Fi access point/router are not turned on.	Make sure you have read and followed all the instructions provided in the Related Information topics.
I do not know my printer's network settings, such as the IP address.	<p>Check the Printer Setting Tool.</p> <p>For more information, see <i>Related Topics: Change Printer Settings Using the Printer Setting Tool (Windows)</i>.</p> <p>For more information, see <i>Related Topics: Change Printer Settings Using the Printer Setting Tool (Mac)</i>.</p>
The printer is not connected correctly to the network. (PJ-883)	<p>Check the Bluetooth and Wi-Fi indicator () on the printer.</p> <p>Green : The network is correctly connected.</p> <p>Green  or cyan  (flashes once every three seconds): The network is not connected correctly, and the Wi-Fi settings must be reconfigured.</p> <p>Cyan : Bluetooth may be connected, but Wi-Fi may not be connected.</p> <p>To establish a Wi-Fi connection, see <i>Related Topics: Connect the Printer to a Computer Using Wi-Fi</i>.</p>

### Related Information

- [Troubleshooting](#)

#### Related Topics:

- [Confirm Printer Settings](#)
- [Change Printer Settings Using the Printer Setting Tool \(Windows\)](#)
- [Change Printer Settings Using the Printer Setting Tool \(Mac\)](#)
- [Connect the Printer to a Computer Using Wi-Fi](#)



## Version Information

Problem	Solution
I do not know the current version of the printer's firmware.	<p>You can confirm the version number of the firmware by printing the configuration report.</p> <p>For more information, see <i>Related Topics</i>: Device Settings of the Printer Setting Tool (Windows).</p> <p>For more information, see <i>Related Topics</i>: Change Printer Settings Using the Printer Setting Tool (Mac).</p>
I want to confirm whether I am using the latest version of the software.	<ul style="list-style-type: none"><li>• Windows Use the P-touch Update Software to confirm whether you have the latest version. For more information, see <i>Related Topics</i>: Update P-touch Editor.</li><li>• Mac Receive Transfer Express and P-touch Editor upgrade notifications from the App Store.</li></ul>



### Related Information

- [Troubleshooting](#)

#### Related Topics:

- [Device Settings of the Printer Setting Tool \(Windows\)](#)
- [Change Printer Settings Using the Printer Setting Tool \(Mac\)](#)
- [Update P-touch Editor](#)





## Reset the Printer

Reset the internal memory of your printer to delete the data transferred from a computer or mobile device, or if the printer is not operating correctly.



>> [Reset All Settings to the Factory Settings Using the Printer Buttons](#)

>> [Reset Data Using the Printer Setting Tool](#)

### Reset All Settings to the Factory Settings Using the Printer Buttons

1. Turn off the printer.
2. Press and hold the Feed button  and the Power button  for about two seconds.
3. While holding down the Feed button , press the Power button  two times, and then release the Feed button .

The Power Indicator starts flashing in orange .

4. Do one of the following:
  - Press Feed button  three times to reset the printer's device settings to their factory settings and delete all the data transferred to the printer.
  - Press Feed button  four times to reset the printer's communication and device settings to their factory settings and delete all the data transferred to the printer.

### Reset Data Using the Printer Setting Tool

You can use the Printer Setting Tool from a computer to:

- Delete the templates and databases
- (PJ-862/PJ-863/PJ-883) Reset communication settings
- Reset all printer settings to the factory settings

### Related Information

- [Troubleshooting](#)

#### Related Topics:

- [Change Printer Settings Using the Printer Setting Tool \(Windows\)](#)
- [Change Printer Settings Using the Printer Setting Tool \(Mac\)](#)

## Appendix

- [Specifications](#)
- [Software Development Kit](#)
- [Product Dimensions](#)
- [Brother Help and Customer Support](#)

## Specifications

- >> [Printing](#)
- >> [Printer Size](#)
- >> [Interface](#)
- >> [Environment](#)
- >> [Power Supply](#)
- >> [Media Specification](#)
- >> [Software](#)
- >> [Compatible Operating Systems](#)

### Printing

<b>Printing Technology</b>	Direct Thermal
<b>Print Speed</b> <sup>1</sup>	Maximum: 3 ips <sup>2</sup> , 13.5 ppm <sup>3</sup> (76.2 mm/s <sup>2</sup> , 13.5 ppm <sup>3</sup> )
<b>Print Resolution</b>	(PJ-822/PJ-862) 203 x 200 dpi (PJ-823/PJ-863/PJ-883) 300 x 300 dpi
<b>Printable Area (Cut Sheet)</b>	Configure with printer driver (PJ-822/PJ-862) min. 3.73" x 1.67"/94.7 mm x 42.2 mm - max. 8.16" x 99.67"/207.2 mm x 2531.4 mm (PJ-823/PJ-863/PJ-883) min. 3.73" x 1.67"/94.8 mm x 42.3 mm - max. 8.21" x 99.67"/208.6 mm x 2531.5 mm

### Printer Size

<b>Dimensions</b>	Approximately 10.04" (W) x 2.17" (D) x 1.18" (H) (Approximately 255 mm (W) x 55 mm (D) x 30 mm (H))
<b>Weight</b>	<ul style="list-style-type: none"> <li>• Approximately 1.06 lb. (Approximately 480 g) (including dummy battery, excluding paper)</li> <li>• Approximately 1.34 lb. (Approximately 610 g) (including the battery, excluding paper)</li> </ul>

### Interface

<b>USB</b>	USB Ver.2.0 (Full Speed) (Type C) Printer class: Mass storage (16 MB of memory)
<b>Bluetooth</b> (PJ-862/PJ-863/PJ-883)	Bluetooth Ver.5.2 (Classic + LE) SPP, OPP, HCRP (Bluetooth Classic), GATT (Bluetooth Low Energy) Supported protocol: iAP
<b>Wireless LAN (2.4 GHz)</b> (PJ-883)	IEEE 802.11 b/g/n (Infrastructure Mode) IEEE 802.11 g/n (Wireless Direct Mode)
<b>Wireless LAN (5 GHz)</b> (PJ-883)	IEEE 802.11 a/n (Infrastructure Mode)

<sup>1</sup> These figures vary by environment. Our standard environment is as follows:

When printing with a USB connection using a new Rechargeable Li-ion Battery that is fully charged in an environment with a temperature of 73.4°F (23°C) using the JEITA J1 pattern.

<sup>2</sup> When printing on A4-size paper.

<sup>3</sup> When the **Form Feed Mode** setting is set to **Fixed Page** (paper size: A4) and printing continuously on roll paper.

<b>Protocol (IPv4)</b> (PJ-883)	ARP, RARP, BOOTP, DHCP, APIPA (Auto IP), WINS/NetBIOS name resolution, DNS Resolver, mDNS, LLNMR responder, LPR, LPD, Custom Raw Port/Port9100, IPP/IPPS, FTP Client and Server, SNMPv1/v2c/v3, HTTP/HTTPS Client and Server, TFTP Server, ICMP, Web Services (Print), SNTP Client
<b>Protocol (IPv6)</b> (PJ-883)	NDP, RA, DNS Resolver, mDNS, LLNMR responder, LPR, LPD, Custom Raw Port/Port9100, IPP/IPPS, FTP Client and Server, SNMPv1/v2c/v3, HTTP/HTTPS Client and Server, TFTP Server, ICMP, Web Services (Print), SNTP Client
<b>Network Security (Wireless)</b> (PJ-883)	SSL/TLS 1.0/1.1/1.2/1.3 (HTTPS, IPPS) SNMPv3, 802.1x (EAP-FAST, PEAP, EAP-TLS, EAP-TTLS)
<b>Wireless Network Security</b> (PJ-883)	WEP 64/128 bit, WPA-PSK (TKIP/AES), WPA2-PSK (TKIP/AES), WPA3-SAE (AES)
<b>Wireless Certification</b> (PJ-883)	Wi-Fi Certification Mark License (WPA™/WPA2™/WPA3™ - Enterprise, Personal), Wi-Fi Protected Setup™ (WPS) Identifier Mark License

## Environment

<b>Operating Temperature</b>	Operation: Rechargeable Li-ion Battery (Optional): Between 14°F and 122°F (Between -10°C and 50°C) AC Adapter (Optional): Between 14°F and 104°F (Between -10°C and 40°C) Car Adapter (Optional): Between 14°F and 122°F (Between -10°C and 50°C) Charging: Between 32°F and 104°F (Between 0°C and 40°C)
<b>Operating Humidity</b>	Between 20% and 80% (without condensation)

## Power Supply

<b>Rechargeable Li-ion Battery (Optional)</b>	10.8 V
<b>Adapter (Optional)</b>	AC Adapter (15 V) AC Adapter for USB Type-C (for charging only)
<b>Car Adapter (Optional)</b>	Cigarette car adapter or Wired type (12V (DC))
<b>Battery Yield</b> <sup>4</sup>	Approximately 600 sheets
<b>Charging Time</b> <sup>5</sup>	About 2 hours

## Media Specification

<b>Paper Size</b>	A5 (5.83" x 8.27"/148 x 210 mm), A4 (8.27" x 11.69"/210 x 297 mm), Letter (8.5" x 11"/216 x 279 mm), Legal (8.5" x 14"/216 x 356 mm), continuous
-------------------	--

## Software

<b>Printer Font Size</b>	See the Command Reference on the Brother support website at <a href="https://support.brother.com">support.brother.com</a> .
<b>Printer Font Face</b>	

<sup>4</sup> These figures vary by environment. Our standard environment is as follows:  
JEITA J1 pattern printed continuously on A4 size paper when connected by the USB interface and the fully-charged battery is installed  
Print density: 6  
Environment temperature: 77 °F / 25°C

<sup>5</sup> When using an AC adapter, AC Adapter for a USB Type-C cable, or Car Adapter.

---

## Compatible Operating Systems

For the latest list of compatible software, visit [support.brother.com](http://support.brother.com).

### Related Information

- [Appendix](#)
-

## Software Development Kit

Software Development Kit (SDK) is available from the Brother Developer Center (<https://support.brother.com/g/s/es/dev/en/index.html>).

(PJ-862/PJ-863/PJ-883) The b-PAC SDK and the SDKs for mobile devices (Android™, iPhone, and iPad) can also be downloaded. (The SDKs available are subject to change without notice.)

(PJ-822/PJ-823) The b-PAC SDK and the SDKs for mobile devices (Android™ only) can also be downloaded. (The SDKs available are subject to change without notice.)



### Related Information

- [Appendix](#)





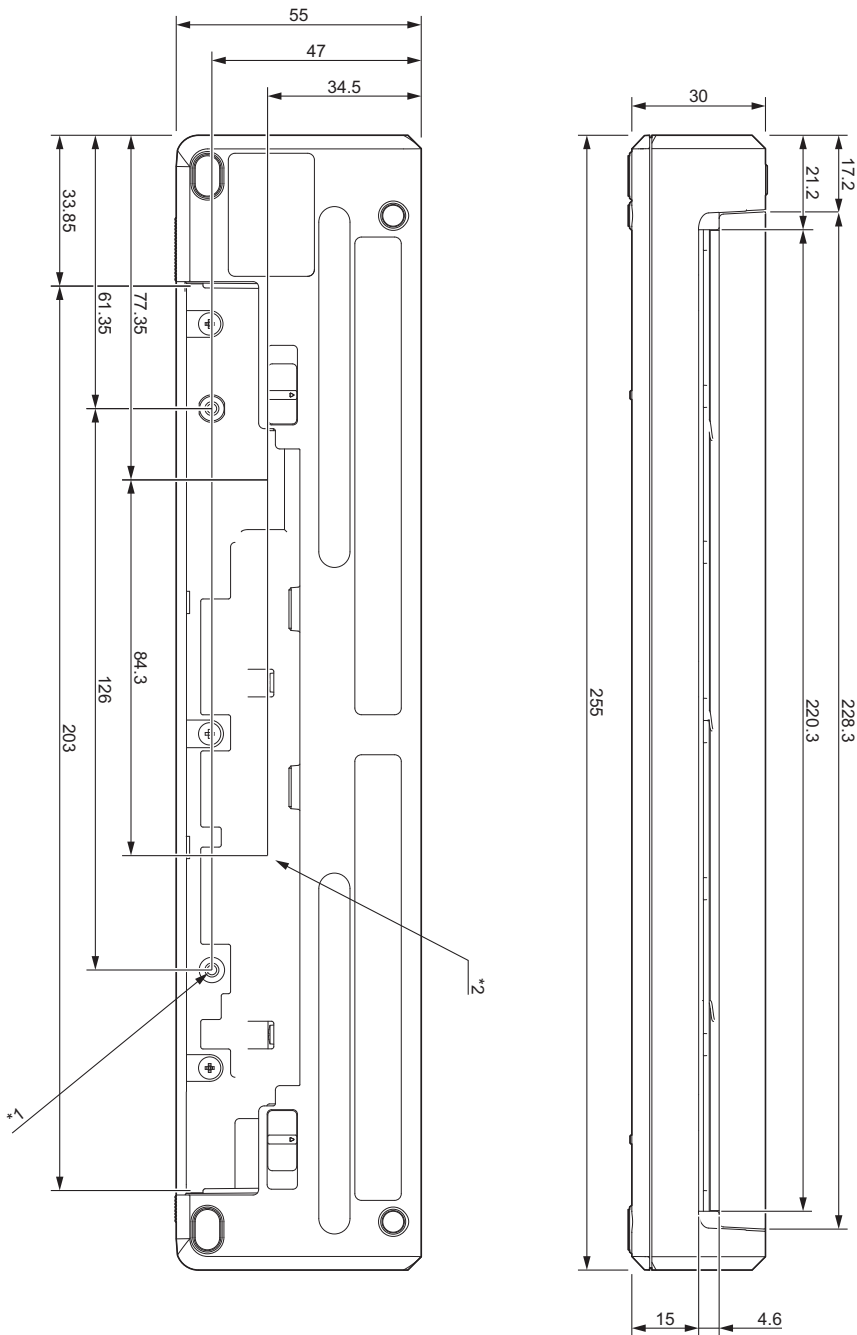

## Mounting Notes

- \*1 Secure the Battery Cavity Mounting Block to the printer first.
- \*2 Secure the Battery Cavity Mounting Block to the desired surface.

## Brother Testing Conditions

These values are not guaranteed. When mounting the printer for use, make sure the printer is mounted securely.

- \*1 Size: Use M2.6 tapping screws; Screw hole depth: 6 mm; Tightening torque: 2.2 kgf-cm; Material: Steel
- \*2 Size: Use M2.6 screws; Screw hole depth: 6 mm; Tightening torque: 3.5 kgf-cm; Material: Steel

Using binding head screws coated with a thread-locking agent is effective at preventing the screws from becoming loose.

## Mounting plate

Thickness: 2 mm; Material: Steel

# Roll Printer Case

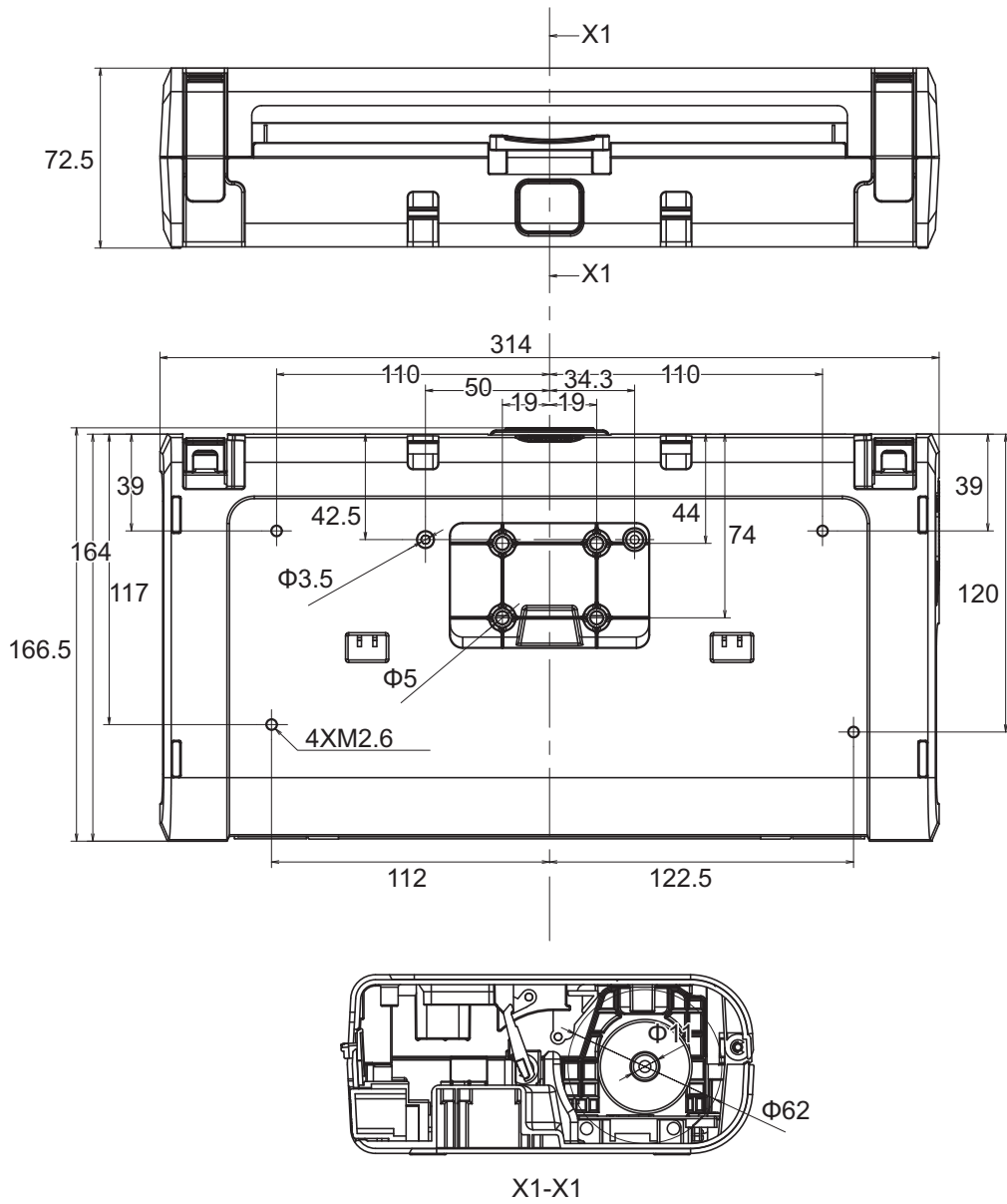

# Paper Guide

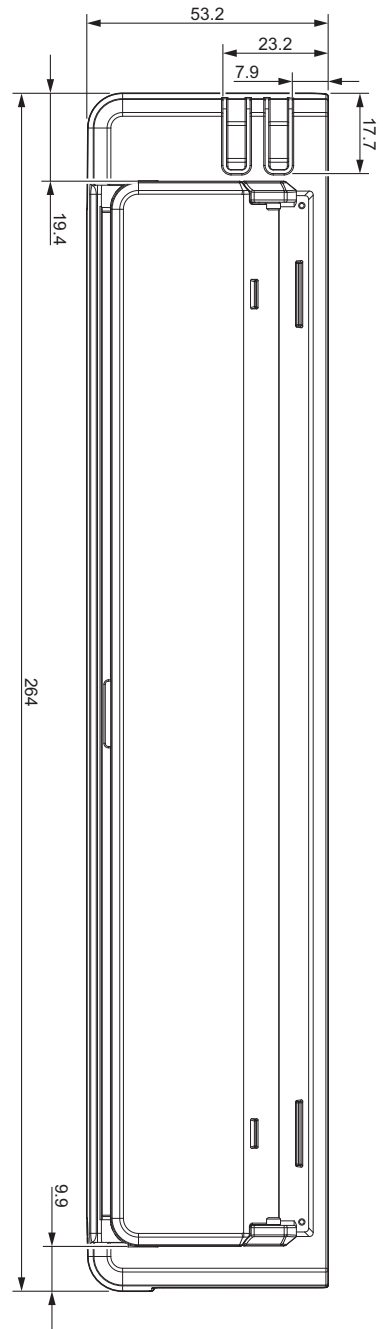
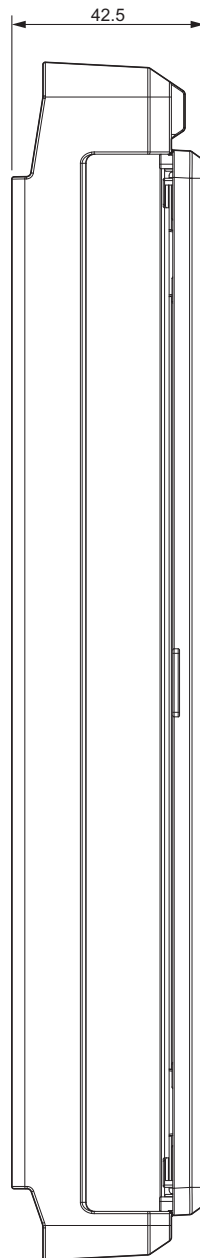
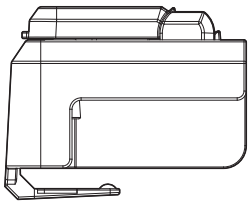
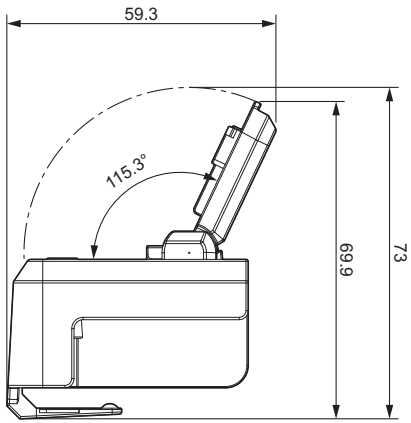

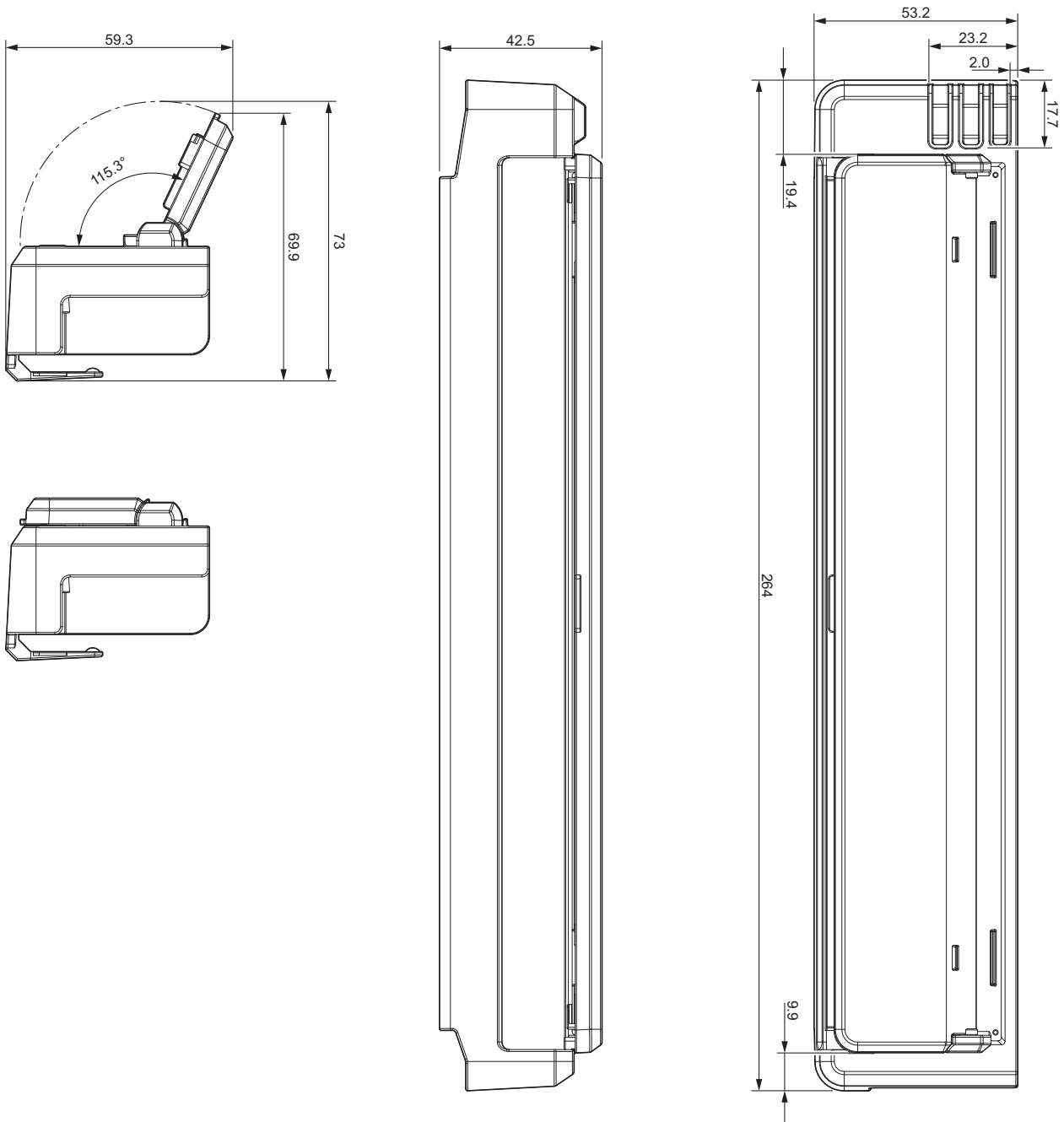

## Paper Roll Holder

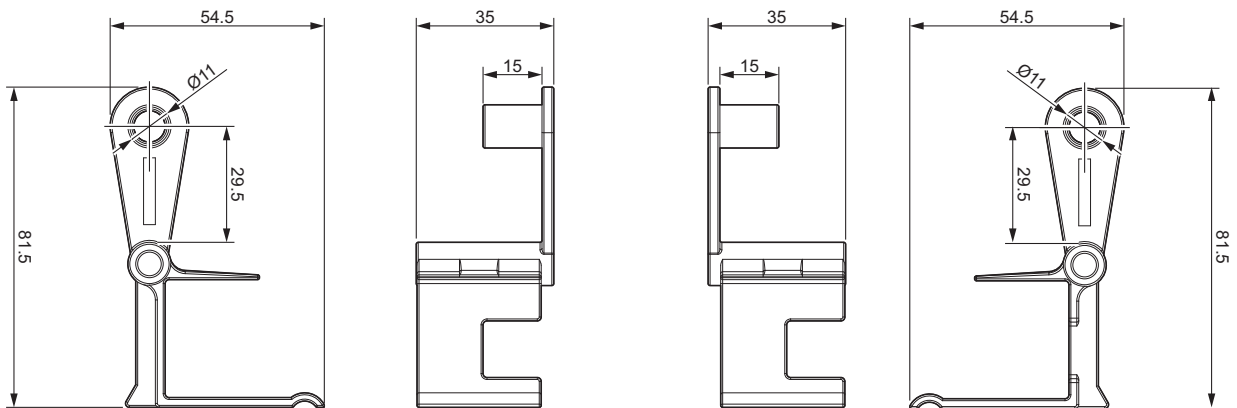

## ✓ Related Information

- [Appendix](#)

## Brother Help and Customer Support

### IMPORTANT

For technical help, you must call the country where you bought the printer. Calls must be made **from within** that country.

>> [FAQs \(Frequently Asked Questions\)](#)

>> [For Customer Service](#)

>> [Ordering Accessories and Supplies](#)

### FAQs (Frequently Asked Questions)

For more information on your Brother printer, visit the Brother support website at [support.brother.com](http://support.brother.com). For additional help and tips, go to your model's **FAQs & Troubleshooting** page; for the latest drivers and software, go to your model's **Downloads** page.

### For Customer Service

#### In USA:

[www.brother-usa.com/support](http://www.brother-usa.com/support) (Self-Service/Email/Chat)

1-877-BROTHER (1-877-276-8437)

#### In Canada:

[www.brother.ca/support](http://www.brother.ca/support)

(Self-Service Videos, Email, Chat, Facebook and Twitter Help)

### Service Center Locator (USA only)

For the location of a Brother authorized service center, call 1-877-BROTHER (1-877-276-8437) or visit [www.brother-usa.com/support](http://www.brother-usa.com/support).

### Service Center Locations (Canada only)

For the location of a Brother authorized service center, visit [www.brother.ca/support](http://www.brother.ca/support).

### Ordering Accessories and Supplies

For best quality results use only genuine Brother supplies, which are available at most Brother retailers. If you cannot find the supplies you need and have a Visa, MasterCard, Discover, American Express credit card, or PayPal account, you can order directly from Brother. Visit us online for a complete selection of the Brother accessories and supplies that are available for purchase.

### NOTE

In Canada, only Visa and MasterCard are accepted.

#### In USA:

1-877-BROTHER (1-877-276-8437)

[www.brother-usa.com/support](http://www.brother-usa.com/support)

#### In Canada:

[www.brother.ca](http://www.brother.ca)



## Related Information

- [Appendix](#)

Brother International Corporation  
200 Crossing Boulevard  
P.O. Box 6911  
Bridgewater, NJ 08807-0911 USA

Brother International Corporation (Canada) Ltd.  
1 rue Hôtel de Ville,  
Dollard-des-Ormeaux, QC, Canada H9B 3H6

**brother**



USA/CAN  
Version 0