

Owner's Manual

4 10/100/1000Base-T ports + 2 100FX/Gigabit SFP slots Lite Managed Industrial Ethernet Switch

Model: NGI-S04C2

WARRANTY REGISTRATION

Register your product today and be automatically entered to win an ISOBAR® surge protector in our monthly drawing!

triplite.com/warranty

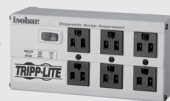

1111 W. 35th Street, Chicago, IL 60609 USA • triplite.com/support

Copyright © 2021 Tripp Lite. All rights reserved.

COPYRIGHT

All rights reserved. No part of this publication may be reproduced, stored in a retrieval system, or transmitted in any form or by any means, whether electronic, mechanical, photo copying, recording or otherwise, without the prior written permission of the publisher.

FCC WARNING



This equipment has been tested and found to comply with the limits for a class A device, pursuant to part 15 of FCC rules. These limits are designed to provide reasonable protection against harmful interference in a commercial installation. This equipment generates, uses and can radiate radio frequency energy and, if not installed and used in accordance with the instructions, may cause harmful interference to radio communication. Operation of this equipment in a residential area is likely to cause harmful interference, in which case, the user will be required to correct the interference at the user's own expense.



This is a Class A product. In a domestic environment, this product may cause radio interference in which case the user may be required to take adequate measures.



Warning

Take special care to read and understand all the content in the warning boxes.



Warning

Do not work on the system or connect or disconnect cables during periods of lightning activity.



Warning

Before working on equipment that is connected to power lines, remove jewelry (including rings, necklaces, and watches). Metal objects will heat up when connected to power and ground and can cause serious burns or weld the metal object to the terminals.



Warning

Do not stack the chassis on any other equipment. If the chassis falls, it can cause severe bodily injury and equipment damage.



Warning

An exposed wire lead from a DC-input power source can conduct harmful levels of electricity. Be sure that no exposed portion of the DC-input power source wire extends from the terminal block plug.



Warning

Ethernet cables must be shielded when used in a central office environment.



Warning

If a redundant power system (RPS) is not connected to the switch, install an RPS connector cover on the back of the switch.



Warning

Read the wall-mounting instructions carefully before beginning installation. Failure to use the correct hardware or to follow the correct procedures could result in a hazardous situation to people and damage to the system.



Warning

Before performing any of the following procedures, ensure that power is removed from the DC circuit.



Warning

Read the installation instructions before connecting the system to the power source.



Warning

To prevent bodily injury when mounting or servicing this unit in a rack, you must take special precautions to ensure that the system remains stable. The following guidelines are provided to ensure your safety:

- This unit should be mounted at the bottom of the rack if it is the only unit in the rack.
- When mounting this unit in a partially filled rack, load the rack from the bottom to the top with the heaviest component at the bottom of the rack.
- If the rack is provided with stabilizing devices, install the stabilizers before mounting or servicing the unit in the rack.



Warning

This unit might have more than one power supply connection. All connections must be removed to de-energize the unit.



Warning

Only trained and qualified personnel should be allowed to install, replace or service this equipment.



Warning

When installing or replacing the unit, the ground connection must always be made first and disconnected last.



Warning

Voltages that present a shock hazard may exist on Power over Ethernet (PoE) circuits if interconnections are made using uninsulated exposed metal contacts, conductors, or terminals. Avoid using such

interconnection methods, unless the exposed metal parts are located within a restricted access location and users and service people who are authorized within the restricted access location are made aware of the hazard. A restricted access area can be accessed only through the use of a special tool, lock and key or other means of security.



Warning

No user-serviceable parts inside. Do not open.



Warning

This equipment must be grounded. Never defeat the ground conductor or operate the equipment in the absence of a suitably installed ground conductor. Contact the appropriate electrical inspection authority or an electrician if you are uncertain that suitable grounding is available.

Table of Contents

<u>1. ABOUT THIS MANUAL</u>	10
1.1. WELCOME	10
1.2. PURPOSE	10
1.3. TERMS/ USAGE	10
<u>2. ABOUT THE SWITCH</u>	11
2.1. FEATURES	11
2.2. SPECIFICATIONS	11
<u>3. HARDWARE DESCRIPTION</u>	13
3.1. CONNECTORS	13
3.2. INSTALLATION	14
3.3. LED INDICATORS	19
<u>4. CONFIGURATION</u>	21
4.1. WIZARD SETTINGS	21
4.1. DASHBOARD SETTINGS	24
4.2. PORT CONFIGURATION	26
4.2.1. PORT SETTINGS	26
4.2.1.1. CLI CONFIGURATION.....	28
4.2.1.2. WEB CONFIGURATION	29
4.2.2. LOOP DETECTION CONFIGURATION.....	30
4.2.2.1. CLI CONFIGURATION.....	31
4.2.2.2. WEB CONFIGURATION	32
4.2.3. PORT PRIORITY	34
4.2.3.1. CLI CONFIGURATION.....	34
4.2.3.2. WEB CONFIGURATION	35
4.3. RING CONFIGURATION	35
4.3.1. ERPS	35
4.3.1.1. CLI CONFIGURATION.....	38
4.3.1.2. WEB CONFIGURATION	39
4.3.1.3. WEB CONFIGURATION	41
4.3.2. STP/RSTP	42
4.3.2.1. CLI CONFIGURATION.....	46
4.3.2.2. WEB CONFIGURATION	49
4.3.2.3. WEB CONFIGURATION	50
4.4. SYSTEM SETTINGS.....	52
4.4.1. SYSTEM SETTINGS	52
4.4.1.1. CLI CONFIGURATION.....	52
4.4.1.2. MODBUS TCP SETTINGS.....	52
4.4.1.3. CLI CONFIGURATION.....	52

4.4.2.	IGMP SNOOPING	53
4.4.2.1.	CLI CONFIGURATION.....	54
4.4.3.	IPV4 SETTINGS.....	55
4.4.3.1.	CLI CONFIGURATION.....	55
4.4.3.2.	WEB CONFIGURATION	57
5.	<u>NETWORK TOPOLOGY</u>	59
5.1.	MAP SETTINGS	59
5.1.1.	CLI CONFIGURATION.....	59
5.1.2.	WEB CONFIGURATION	60
5.2.	NEIGHBOR DEVICES	63
5.2.1.	LLDP.....	63
5.2.1.1.	CLI CONFIGURATION.....	63
5.2.1.2.	WEB CONFIGURATION.....	64
5.2.2.	MANUAL REGISTRATION	65
5.2.2.1.	CLI CONFIGURATION.....	65
5.2.2.2.	WEB CONFIGURATION	65
5.2.3.	ONVIF.....	67
5.2.3.1.	CLI CONFIGURATION.....	67
5.2.3.2.	WEB CONFIGURATION	68
5.3.	TOPOLOGY MAP.....	69
5.3.1.	CLIENT SWITCH MANAGEMENT	71
5.3.2.	QUICK CONFIGURATION MENU	72
5.3.2.1.	IP CONFIGURATION.....	73
5.3.2.2.	LOOP DETECTION CONFIGURATION.....	74
5.3.2.3.	PORT CONFIGURATION.....	75
5.3.2.4.	PORT MIRROR CONFIGURATION	76
5.3.2.5.	PORT PRIORITY CONFIGURATION.....	76
5.3.2.6.	STORM CONTROL CONFIGURATION	77
5.3.2.7.	SAVE CONFIGURATION.....	78
5.3.2.8.	SAVE ALL DEVICE LOCATION	78
5.3.2.9.	SAVE ALL DEVICE LOCATION	78
5.3.2.10.	LOGIN HOMEPAGE	78
6.	<u>SECURITY.....</u>	79
6.1.	802.1X.....	79
6.1.1.	CLI CONFIGURATION.....	81
6.1.2.	WEB CONFIGURATION	83
6.1.3.	WEB CONFIGURATION	85
6.2.	ACL.....	87
6.2.1.	CLI CONFIGURATION	87
6.2.2.	WEB CONFIGURATION	90
6.3.	PORT SECURITY.....	91
6.3.1.	CLI CONFIGURATION.....	92
6.3.2.	WEB CONFIGURATION	92
6.4.	SERVER CONTROL.....	93
6.4.1.	CLI CONFIGURATION.....	93
6.4.2.	WEB CONFIGURATION	94

6.5. STORM CONTROL	95
6.5.1. ALARM THRESHOLD	95
6.5.1.1. WEB CONFIGURATION	95
6.5.2. STORM CONTROL.....	96
6.5.2.1. CLI CONFIGURATION.....	96
6.5.2.2. WEB CONFIGURATION.....	97
6.6. VLAN.....	98
6.6.1. PORT ISOLATION	98
6.6.1.1. CLI CONFIGURATION.....	98
6.6.1.2. WEB CONFIGURATION	99
6.6.2. VLAN SETTINGS	100
6.6.2.1. CLI CONFIGURATION.....	102
6.6.2.2. WEB CONFIGURATION	104
<u>7. DIAGNOSIS.....</u>	<u>105</u>
7.1. ALARM INFORMATION	105
7.1.1. CLI COMMAND.....	105
7.1.2. WEB CONFIGURATION	105
7.2. PORT MIRROR	106
7.2.1. CLI CONFIGURATION.....	106
7.2.2. WEB CONFIGURATION	107
7.3. PORT STATISTICS.....	108
7.3.1. CLI CONFIGURATION.....	108
7.3.2. WEB INFORMATION.....	108
7.4. PORT UTILIZATION	109
7.4.1. CLI CONFIGURATION.....	109
7.4.2. WEB PORT UTILIZATION	109
7.5. SYSLOG	110
7.5.1. CLI CONFIGURATION.....	110
7.5.2. WEB CONFIGURATION	111
7.6. UTILIZATION THRESHOLD.....	112
7.6.1. CLI CONFIGURATION.....	112
7.6.2. WEB CONFIGURATION	113
<u>8. MANAGEMENT</u>	<u>114</u>
8.1. SNMPv1/v2c.....	114
8.1.1. SNMP CONFIGURATION.....	114
8.1.1.1. CLI CONFIGURATION.....	114
8.1.1.2. WEB CONFIGURATION	115
8.1.2. SNMP COMMUNITY NAME.....	115
8.1.2.1. CLI CONFIGURATION.....	115
8.1.2.2. WEB CONFIGURATION	116
8.1.3. SNMP EVENT SETTINGS.....	117
8.1.3.1. CLI CONFIGURATION.....	117
8.1.3.2. WEB CONFIGURATION	118
8.1.4. PORT TRAP EVENT SETTINGS	119
8.1.4.1. CLI CONFIGURATION.....	119
8.1.4.2. WEB CONFIGURATION	119

8.1.5. SNMP TRAP RECEIVER SETTINGS.....	120
8.1.5.1. CLI CONFIGURATION.....	120
8.1.5.2. WEB CONFIGURATION	120
8.2. SNMPv3	121
8.2.1. SNMPv3 GROUP	121
8.2.1.1. CLI CONFIGURATION.....	121
8.2.1.2. WEB CONFIGURATION	122
8.2.2. SNMPv3 USER	123
8.2.2.1. CLI CONFIGURATION.....	123
8.2.2.2. WEB CONFIGURATION	124
8.2.3. SNMPv3 VIEW.....	125
8.2.3.1. CLI CONFIGURATION.....	125
8.2.3.2. WEB CONFIGURATION	126
8.3. SNTP.....	126
8.3.1. CLI CONFIGURATION.....	127
8.3.2. WEB CONFIGURATION	129
8.4. SYSTEM INFORMATION.....	131
8.4.1. CLI CONFIGURATION.....	131
8.4.2. WEB CONFIGURATION	131
8.5. SYSTEM MAINTENANCE.....	132
8.5.1. CONFIGURATION	132
8.5.1.1. CLI CONFIGURATION.....	132
8.5.1.2. WEB CONFIGURATION	133
8.5.2. FIRMWARE	133
8.5.2.1. CLI CONFIGURATION.....	133
8.5.2.2. WEB CONFIGURATION	134
8.5.3. REBOOT	134
8.5.3.1. CLI CONFIGURATION.....	134
8.5.3.2. WEB CONFIGURATION	134
8.6. USER ACCOUNT.....	134
8.6.1. CLI CONFIGURATION.....	135
8.6.2. WEB CONFIGURATION.....	135
 WARRANTY & PRODUCT REGISTRATION.....	 137

1. About this Manual

1.1. Welcome

The NGI-S04C2 is a Lite Managed Industrial Ethernet Switch specifically designed to suit your heavy industrial environments and loaded with necessary standard features to deploy in automation systems. The switch's rugged case and hardened components withstand high degree of vibration, shock and wide operating temperatures from -10°C to 60°C (-14°F to 140°F).

Switch features four 10/100/1000Base-T ports and two Gigabit SFP slots to satisfy new and evolving network demands. In addition, the switch contains dual power inputs to ensure reliability and maximize network up time. Other integrated features of the switch include Auto-negotiation and Rate limitation, which optimizes your network performance and provides a secure network, offering a cost-effective solution in a small but powerful package.

1.2. Purpose

This manual describes how to install and configure the Lite Managed Industrial Ethernet Switch.

1.3. Terms/ Usage

In this manual, the term “Switch” (first letter upper case) refers to the NGI-S04C2 Switch, and “switch” (first letter lower case) refers to other switches.

2. About the Switch

2.1. Features

Configuration

Wizard Setting
Dashboard Setting
Port Setting
Loop Detection
Port Priority
Ring Setting
ERPS
STP
System Setting
Modbus TCP
IGMP Snooping

Network Topology

LLDP
ONVIF
Topology Map

Ethernet Interface (10/100/1000Base-T interfaces)

Auto-negotiation and Auto-MDI/MDI-X
Flow control of half duplex back pressure
Flow control of full duplex

Security

802.1X Radius
ACL
Port Security
Server Control
Storm Control
VLAN Setting

Diagnostic

Alarm Information
Port Mirroring
Port Statistics
Port Utilization and Threshold
Remote System Log (Syslog)

Management

SNMP v1/v2c/v3
SNMP trap
SNTP
Firmware Upgrade & Reboot
Configuration Upload/Download
User Account Setting

2.2. Specifications

IEEE Standards

IEEE 802.3	10Base-T
IEEE 802.3u	100Base-TX/FX
IEEE 802.3ab	1000Base-T
IEEE 802.3z	1000Base-SX/LX
IEEE 802.3X	Flow Control
IEEE 802.3	Nway Auto-negotiation
IEEE 802.3az	EEE, Energy Efficient Ethernet
IEEE 802.1ab	Link Layer Discovery Protocol
IEEE 802.1p	Class of Service, priority protocols

Performance

Switching fabric 12Gbps

L2 forwarding	8.93Mpps
Packet buffer size	4.1Mbit
MAC table size	8K
Jumbo Frame Size	10K
Throughput	1,488,000pps when 1000Mbps speed

Physical ports

10/100/1000Base-T	4
100FX/Gigabit SFP slots	2

Power

Input Voltage:

- Primary inputs 20~60VDC at a maximum of 0.5A
- Redundant input 20~60VDC at a maximum of 0.5A

Connection:

- Removable 6-pin terminal block One
- 4-pin Mini-DIN connector Zero
- Overload current protection Support
- Power reverse polarity protection Support
- Relay output One with current carrying capacity of 1A @ 24V DC
- Power consumption 10W (system)

Mechanical

Dimension [W x H x D]	50 x 160 x 120 mm (1.97 x 6.3 x 4.72 in.)
Weight	385 g (0.85 lb.)
Installation	DIN rail or wall-mount (optional)

Operating Requirement

Operating Temperature	-10°C to 60°C (-14°F to 140°F)
Storage Temperature	-40°C to 75°C (-40°F to 167°F)
Operating Humidity	5 to 95% RH (non-condensing)
Storage Humidity	5 to 95% RH (non-condensing)
Altitude	Up to 2000 m (6561 ft.)
IEC	Indoor use and pollution degree II

3. Hardware Description

NGI-S04C2 Front Panel

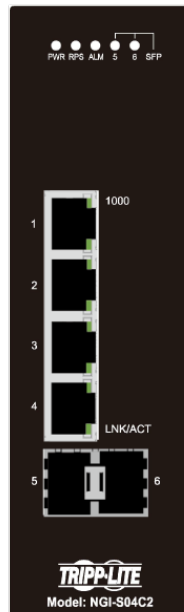

4 10/100/1000Base-T ports + 2 100FX/Gigabit SFP slots
Lite Managed Industrial Ethernet Switch

3.1. Connectors

The Switch utilizes ports with copper and SFP fiber port connectors functioning under Ethernet/Fast Ethernet/Gigabit Ethernet standards.

10/100/1000Base-T Ports

The 10/100/1000Base-T ports support network speeds of 10Mbps, 100Mbps or 1000Mbps, and can operate in half- and full-duplex transfer modes. These ports also offer automatic MDI/MDI-X crossover detection that gives true “plug-n-play” capability – just plug the network cables into the ports and the ports will adjust according to the end-node devices. The following are recommended cabling for the RJ45 connectors: (1) 10Mbps – Cat 3 or better; (2) 100/1000Mbps – Cat 5e or better.

SFP Slots for SFP modules

The two SFP slots are designed to 100/Gigabit SFP modules that support network speed of 100/1000Mbps.

Installing the SFP modules and Fiber Cable

1. Slide the selected SFP module into the selected SFP slot (Make sure the SFP module is aligned correctly with the inside of the slot)
2. Insert and slide the module into the SFP slot until it clicks into place
3. Remove any rubber plugs that may be present in the SFP module’s mouth
4. Align the fiber cable’s connector with the SFP module’s mouth and insert the connector
5. Slide the connector in until a click is heard

6. If you want to pull the connector out, first push down the release clip on top of the connector to release the connector from the SFP module.

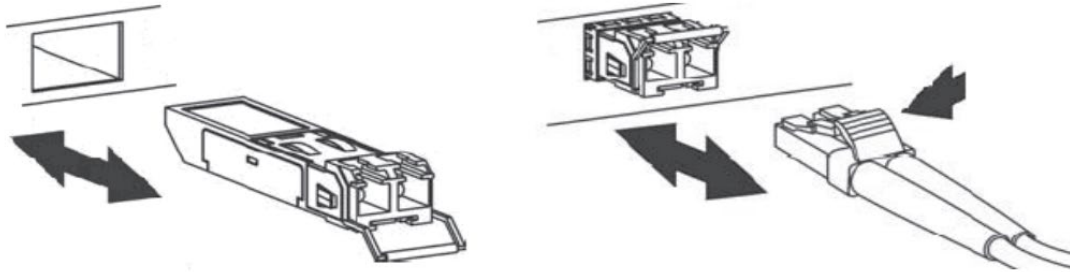

To properly connect fiber cabling: Check that the fiber terminators are clean. You can clean the cable plugs by wiping them gently with a clean tissue or cotton ball moistened with a little ethanol. Dirty fiber terminators on fiber optic cables will impair the quality of the light transmitted through the cable and lead to degraded performance on the port.

Note: When inserting the cable, be sure the tab on the plug clicks into position to ensure that it is properly seated.

Check the corresponding port LED on the Switch to be sure that the connection is valid. (Refer to the LED chart).

Attention:



The NGI-S04C2 is an open type device and NGI-S04C2 shall be DIN-Rail mounted or wall mounted (optional) in cabinet or enclosure

3.2. Installation

The location chosen for installing the Switch may greatly affect its performance. When selecting a site, we recommend considering the following rules:

- ✓ Install the Switch in an appropriate place. See Technical Specifications for the acceptable temperature and humidity ranges.
- ✓ Install the Switch in a location that is not affected by strong electromagnetic field generators (such as motors), vibration, dust, and direct sunlight.
- ✓ Leave at least 10cm of space at the front and rear of the unit for ventilation.

Hardware Installation

- ✓ **Step 1:** Unpack the device and other contents of the package.
- ✓ **Step 2:** Fasten DIN-Rail or Wall-mount kit on the rear of the NGI-S04C2
- ✓ **Step 3:** Connect the 20~60V DC power supply to the PWR & RPS terminal block on the top of the Switch (Refer to “**Wiring Power Inputs**”)
- ✓ **Step 4:** Connect the Ethernet (RJ45) port to the networking device and check the LED status to confirm the connection is established.

DIN Rail Installation

The NGI-S04C2 has a DIN rail bracket on the back of the Switch to satisfy the mounting installation.

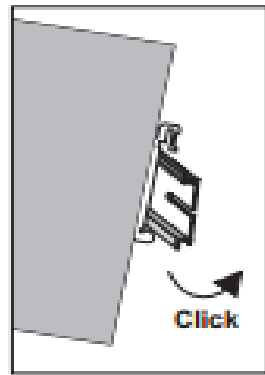

Mounting the Switch

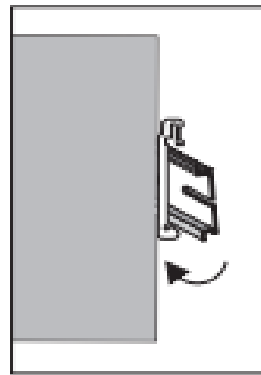

Removing the Switch

Location: The NGI-S04C2 can be DIN-Rail-mounted in cabinet or enclosure.

Mounting the Switch

Place the NGI-S04C2 on the DIN rail from above using the slot and push the front of the switch toward the mounting surface until it snaps into place with a click sound.

Dismounting the Switch

1. Push the switch down to free the bottom of the plate from the DIN rail.
2. Rotate the bottom of the device towards you and away from the DIN rail.
3. Once the bottom is clear of the DIN rail, lift the device straight up to unhook it from the DIN rail..

Wall-Mount Installation

Location: The NGI-S04C2 can be placed on a horizontal surface through wall-mounted kit

Place the switch by using mounting holes on the wall at the appropriate place

Ground the Switch: Before powering on the switch, ground the switch to earth.

Ensure the rack on which the switch is to be mounted is properly grounded and in compliance with ETSI ETS 300 253. Verify that there is a good electrical connection to the grounding point on the rack (no paint or isolating surface treatment).



Attention

This product is intended to be mounted to a well-grounded mounting surface such as a metal panel.

Caution:



The earth connection must not be removed unless all power supply connection has been disconnected.

Caution:



The device is installed in a restricted-access location it has a separate protective earthing terminal on the chassis that must be permanently connected to earth ground to adequately ground the chassis and protect the operator from electrical hazards.

Attention



The product should be mounted in an Industrial Control Panel and the ambient temperature should not exceed 60°C (140°F).

Attention



A corrosion-free mounting rail is advisable. When installing, make sure to allow for enough space to properly install the cabling.

Wiring Power Inputs

You can use “Terminal Block (PWR)” for primary power and “Terminal Block (RPS)” for secondary power source, to be a Redundant Power Input. Top views of Terminal Block are shown in picture.

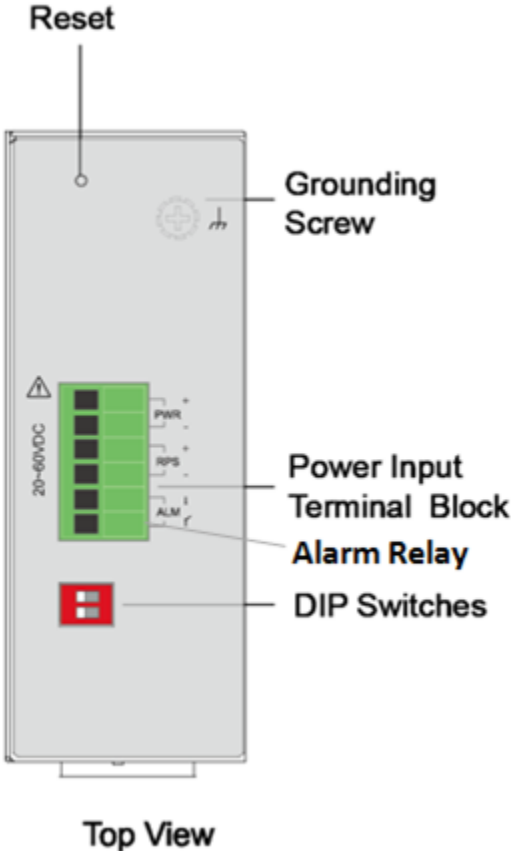

Warning



- Use **copper** conductors only, **60/75°C (140/167°F)**, tighten to **0.56 N•m (5 lb•in)**.
- The wire gauge for the terminal block should range between **12~24 AWG**.

Redundant Power Input: Choose “Terminal Block (PWR)” as primary power. If you choose “Terminal Block (PWR)”, please refer to option 1, unless follow option 2.

- ✓ **Option 1:** Insert the terminal block connector which includes “PWR” and “RPS” into the terminal block receptor.

Connect power cables to terminal block: Use your finger to press the orange plug on top of terminal block connector to insert power cables

WARNING



Safety measures should be taken before connecting the power cable. Turn off the power before connecting modules or wires. The correct power supply voltage is listed on the product label. Check the voltage of your power source to make sure that you are using the correct voltage. **DO NOT** use a voltage greater than what is specified on the product label. Calculate the maximum possible current in each power wire and common wire. Observe all electrical codes dictating the maximum current allowable for each wire size. If current exceeds the maximum rating, the wiring can overheat causing serious damage to your equipment.

Please read and follow these guidelines:

- Use separate paths to route wiring for power and devices. If power wiring and device wiring paths must cross, make sure the wires are perpendicular at the intersection point.

Note: Do not run signal or communications wiring and power wiring through the same wire conduit. To avoid interference, wires with different signal characteristics should be routed separately.

- You can use the type of signal transmitted through a wire to determine which wires should be kept separate. The rule of thumb is that wiring that shares similar electrical characteristics can be bundled together
- You should separate input wiring from output wiring
- We advise that you label the wiring to all devices in the system.

Wiring the Alarm Contact:

The Alarm Contact consists of the two middle contacts of the terminal block on switch’s top panel.

FAULT: The two middle contacts of the 6-contact terminal block connector are used to detect both power faults and port faults. The two wires attached to the Fault contacts form an open circuit when:

1. The Switch has lost power from one of the DC power inputs.

OR

2. One of the ports for which the corresponding PORT ALARM DIP Switch is set to ON is not properly connected.

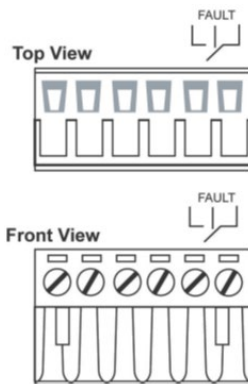

If neither of these two conditions is satisfied, the Fault circuit will be closed.

Warning



- Use **copper** conductors only, **60/75°C (140/167°F)**, tighten to **0.56 N•m (5 lb•in)**.
- The wire gauge for the terminal block should range between **12~24 AWG**.

Power on the Unit

The Switch accepts the power input voltage from 20~60VDC.

- ✓ Wiring appropriate power source as above guideline before turn on the power.
- ✓ Check the front-panel LEDs as the device is powered on to verify that the Power LED is lit. If not, check that the power cable is correctly and securely plugged in.

Notice: Turn off the power before connecting modules or wires.

- *The correct power supply voltage is listed on the product label. Check the voltage of your power source to make sure that you are using the correct voltage. Do NOT use a voltage greater than what is specified on the product label.*
- *Calculate the maximum possible current in each power wire and common wire. Observe all electrical codes dictating the maximum current allowable for each wire size. If current go above the maximum ratings, the wiring could overheat, causing serious damage to your equipment.*

Manual Reboot / Reset Switch

Switch contains “Reset” button through which you can manually reboot or reload to factory default settings.

- ✓ If pressing the “Reset” button for **more** than 2 seconds, the Switch will be rebooted.
- ✓ If pressing the “Reset” button for **more** than 5 seconds, the Switch will be return to its factory default setting

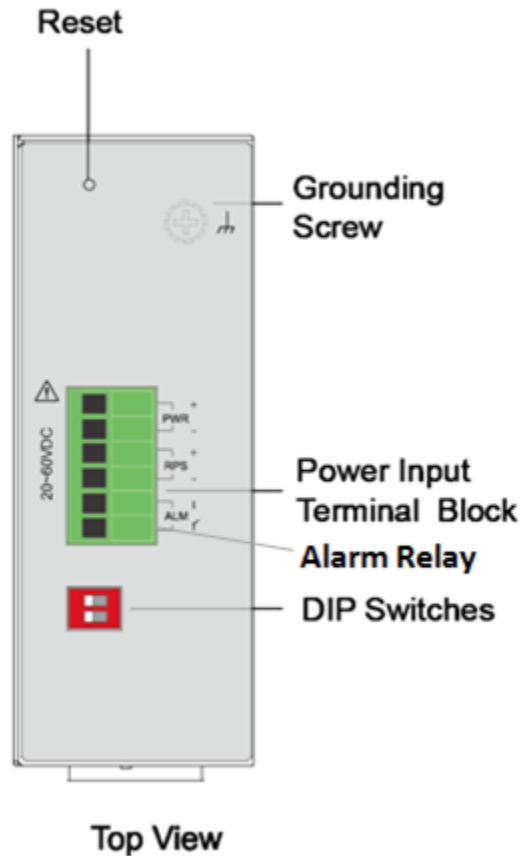

3.3. LED Indicators

This Switch is equipped with Unit LEDs to enable you to determine the status of the Switch, as well as Port LEDs to display what is happening in all your connections. They are as follows:

PWR (Green)	Illuminated	Power on by terminal block PWR/4-pin mini DIN connector at 20~60VDC.
	Off	Terminal block PWR/4-pin mini DIN connector is not available.
RPS (Green)	Illuminated	Redundant (secondary) Power on.
	Off	Redundant (secondary) Power off or failure.
ALM (Red)	Illuminated	Alarm for following conditions(when the DIP switches are turned on): <ul style="list-style-type: none"> ✓ Primary Power lost ✓ Secondary Power lost ✓ Threshold exceed ✓ Port utilization exceed
	Off	Normal operation.
1000 (Green)	Illuminated	Link speed at 1000Mbps.
	Off	Link speed at 10/100Mbps.
LNK/ACT (Green)	Illuminated	Ethernet link-up.
	Blinking	Activity (receiving or transmitting data).

	Off	Port disconnected or link failed.
SFP 5-6 (Green)	Illuminated	Ethernet link-up.
	Blinking	Activity (receiving or transmitting data).
	Off	Port disconnected or link failed.

Notice:

- ✓ *PWR: Primary Power*
- ✓ *RPS: Redundant Power Supply*
- ✓ *ALM: Alarm*

DIP Switches

DIP	Function Description
PWR	Primary power input from terminal block
	ON Primary power alarm reporting is enabled
	OFF Primary power alarm reporting is disabled
RPS	Redundant power input from terminal block
	ON Redundant power alarm reporting is enabled
	OFF Redundant power alarm reporting is disabled

Warning



Do not block air ventilation holes, as heat dissipated pass through it..

ATTENTION



This device complies with Part 15 of the FCC rules. Operation is subject to the following conditions:

1. This device may not cause harmful interference.
2. This device must accept any interference received including interference that may cause undesired operation.

ATTENTION



If the equipment is used in a manner not specified by the Tripp Lite, the protection provided by the equipment may be impaired.

4. Configuration

Initially, the new device connects the network using default IP (192.168.0.254). Access the IP address to enter the Wizard. After three seconds the “Welcome” screen will switch to the set-up screen as shown below. The following flow chart illustrates the installation and subsequent steps after plug in.

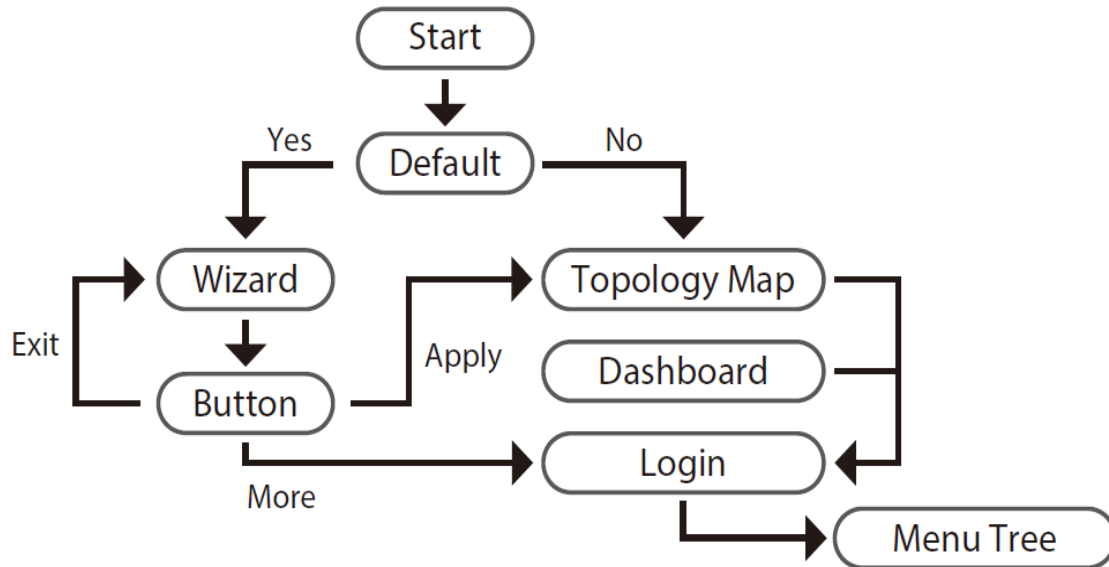

4.1. Wizard Settings

Wizard will be use full to configure basic settings in the device like switch User account with host name, management IP, And access Mode. The Wizard assisted interface covers the basic requirements for most end-users to set up the Ethernet switch in these three steps; 1) Account; 2) IP address; 3) Access Mode.

Step 1: Account Settings to configure user credentials to access the device, which will guide you the strength of security.



User Name: admin

Password: ⚠ Please enter password

A strong password contains 8 characters and at least one upper case, one lower case and one number.

Password Confirmation: ⚠ Enter password confirmation

Device Name: L2SWITCH

Rename the device for identification.

Step 2: IP Address is to configure the management IP user can select DHCP mode or static mode to configure the switch IP as shown below.



IP Source: Dynamic IP Assigned the IP address automatically to device.

IP Address: 192.168.202.187

Subnet Mask: 255.255.255.0

Default Gateway: 192.168.202.1

If no Dynamic IP (DHCP) server device won't obtain an IP address.
Press the reset button for 5 seconds to obtain default IP (192.168.0.254).

Step 3: Access Mode is to access the device have 2 options Security mode (HTTPs, SSH, and SNMPv3) and Normal mode (HTTP, TELNET, and SNMPv1/v2).



Security Mode

Provide data encryption to protect your network communication, by using security protocols (HTTPS, SSH, and SNMPv3).

Normal Mode

Enable user for easy network management by using communication protocols (HTTP, TELNET and SNMPv1/2).

It is highly recommended to choose the security mode.

Click "More" to save and proceed for advanced settings.

Apply Exit More

Default:

Username: admin

Password: admin

After successful completion of the settings, the web-link will take you to the “Topology Map” as landing page shown below where you can access the Dashboard, Login, and Information.

4.1. Dashboard Settings

The Dashboard is an intelligent system that provides real-time switch parameters that include performance, link status and data traffic information in an engaging, easy-view format for the end-users tricolor scheme as the Topology Map. The dashboard setting enables you to control the performance of the switch like CPU, Memory, Port Tx Usage, Port Rx Usage. Use the learn option to obtain port registration information.

Dashboard Settings

Port Registration Learn

Press "Learn" to obtain the Ports Registration.

Port Link Down Statistics

Press "Reset" to reset the port link down statistics.

Port: ▾

Press "Download" to download the port link down statistics log.

Critical/Alert Threshold

	Alert Threshold	Critical Threshold	Disable All
CPU Usage:	<input type="range" value="60%"/>	<input type="range" value="80%"/>	<input type="button" value="Disable"/>
Memory Usage:	<input type="range" value="60%"/>	<input type="range" value="80%"/>	<input type="button" value="Disable"/>
Port Tx Usage:	<input type="range" value="60%"/>	<input type="range" value="80%"/>	<input type="button" value="Disable"/>
Port Rx Usage:	<input type="range" value="60%"/>	<input type="range" value="80%"/>	<input type="button" value="Disable"/>

● Critical
 ● Alert
 ● Normal

Parameter	Description
Port Registration Learn	
Learn	This field is to obtain the port registration information.
Reset	Reset option to reset the port registration information.

Port Link Down Statistics	
Port	User can select individual port or all ports information to reset to default on registration information.
Download	This field will download the statistics of port down information along with date time.
Critical / Alert Threshold	
CPU Usage	User can configure threshold value to normal, alert, critical percentage or disable the feature.
Memory Usage	User can configure threshold value to normal, alert, critical percentage or disable the feature.
Port Tx Usage	User can configure threshold value to normal, alert, critical percentage of the interface Tx usage or disable the feature.
Port Rx Usage	User can configure threshold value to normal, alert, critical percentage of the interface Rx usage or disable the feature.
Apply	Click Apply to take effect the settings.
Default	This field will make above settings to default value.

4.2. Port Configuration

4.2.1. Port Settings

Introduction

State In port configuration you can enable or disable the port. If the port is disabled the port remains off without any operation. To keep it operating, place the port in enable state.

Speed It defines in which speed the port should operate. The speeds that it can operate are 10/100/1000Mbps. You can also specify whether the port should operate in what mode. The operating modes are half duplex and full duplex.

● Duplex Mode

A *duplex* communication system is a system composed of two connected parties or devices that can communicate with one another in both directions.

Half Duplex:

A *half-duplex* system provides for communication in both directions, but only one direction at a time (not simultaneously). Typically, once a party begins receiving a signal, it must wait for the transmitter to stop transmitting, before replying.

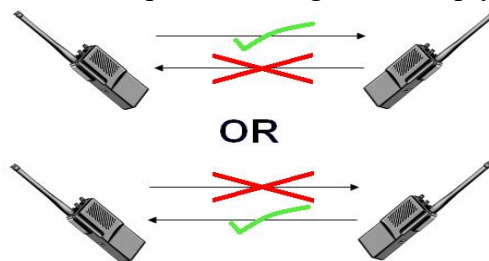

Full Duplex:

A *full-duplex*, or sometimes *double-duplex* system, allows communication in both directions, and, unlike half-duplex, allows this to happen simultaneously. Land-line telephone networks are full-duplex, since they allow both callers to speak and be heard at the same time.

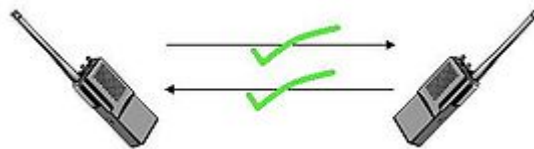

● Loopback Test

A loopback test is a test in which a signal is sent from a communications device and returned (looped back) to it as a way to determine whether the device is working right or as a way to pin down a failing node in a network. One type of loopback test is performed using a special plug, called a **wrap plug** that is inserted in a port on a communications device. The effect of a wrap plug is to cause transmitted (output) data to be returned as received (input) data, simulating a complete communications circuit using a single computer.

● Auto MDI-MDIX

Auto-MDIX (automatic medium-dependent interface crossover) is a computer networking technology that automatically detects the required cable connection type (straight-through or crossover) and configures the connection appropriately, thereby removing the need for crossover cables to interconnect switches or connecting PCs peer-to-peer. When it is enabled, either type of cable can be used or the interface automatically corrects any incorrect cabling. For Auto-MDIX to operate correctly, the speed on the interface and duplex setting must be set to "auto". Auto-MDIX was developed by HP engineers Dan Dove and Bruce Melvin.

- **Auto Negotiation**

Auto (auto negotiation) allows one port to negotiate with a peer port automatically to obtain the connection speed and duplex mode that both ends support. When auto-negotiation is turned on, a port on the Switch negotiates with the peer automatically to determine the connection speed and duplex mode.

If the peer port does not support auto-negotiation or turns off this feature, the Switch determines the connection speed by detecting the signal on the cable and using **half duplex** mode. When the Switch's auto-negotiation is turned off, a port uses the pre-configured speed and duplex mode when making a connection, thus requiring you to make sure that the settings of the peer port are the same in order to connect.

- **Flow Control**

A concentration of traffic on a port decreases port bandwidth and overflows buffer memory causing packet discards and frame losses. IEEE802.3x flow control is used in full duplex mode to send a pause signal to the sending port, causing it to temporarily stop sending signals when the receiving port memory buffers fill and resend later.

The Switch uses IEEE802.3x flow control in full duplex mode and backpressure flow control in half duplex mode. IEEE802.3x flow control is used in full duplex mode to send a pause signal to the sending port, causing it to temporarily stop sending signals when the receiving port memory buffers fill. Back Pressure flow control is typically used in half duplex mode to send a "collision" signal to the sending port (mimicking a state of packet collision) causing the sending port to temporarily stop sending signals and resend later.

Note: 1000 Base-T does not support force mode.

- **Cable Test**

This feature determines the quality of the cables, shorts, and cable impedance mismatch, bad connectors, termination mismatch, and bad magnetics. The feature can work on the copper Ethernet cable only.

Default Settings

The default port Speed & Duplex is auto for all ports.

The default port Flow Control is off for all ports

4.2.1.1. CLI Configuration

Node	Command	Description
enable	show interface IFNAME	This command displays the current port configurations.
configure	interface IFNAME	This command enters the interface configure node.
interface	show	This command displays the current port configurations.
interface	loopback (none mac)	This command tests the loopback mode of operation for the specific port.
interface	flowcontrol (off on)	This command disables / enables the flow control for the port.
interface	speed (auto 10-full 10-half 100-full 100-half 1000-full)	This command configures the speed and duplex for the port.
interface	shutdown	This command disables the specific port.
interface	no shutdown	This command enables the specific port.
interface	description STRINGs	This command configures a description for the specific port.
interface	no description	This command configures the default port description.
interface	cable test	This command diagnostics the Ethernet cable and shows the broken distance.
interface	clean cable-test result	This command cleans the test result of the Ethernet cable test.
interface	show cable-test result	This command displays the test result of the Ethernet cable test.
configure	interface range gigabitethernet1/0/ PORTLISTS	This command enters the interface configure node.
if-range	description STRINGs	This command configures a description for the specific ports.
if-range	no description	This command configures the default port description for the specific ports.
if-range	shutdown	This command disables the specific ports.
if-range	no shutdown	This command enables the specific ports.
if-range	speed (auto 10-full 10-half 100-full 100-half 1000-full)	This command configures the speed and duplex for the port.

Example:

L2SWITCH#*configure terminal*

```
L2SWITCH(config)#interface gi1/0/1
L2SWITCH(config-if)#speed auto
```

4.2.1.2. Web Configuration

Port Settings

Configuration
Loop Detection
Priority

Port Settings

Port	State	Speed/Duplex	Flow Control
From: <input type="text" value="1"/> To: <input type="text" value="1"/>	<input type="text" value="Enable"/>	<input type="text" value="Auto"/>	<input type="text" value="On"/>

Port Status

Port	State	Speed/Duplex	Flow Control	Link Status
1	Enabled	Auto	On	100M / Full / On
2	Enabled	Auto	On	Link Down
3	Enabled	Auto	On	Link Down
4	Enabled	Auto	On	Link Down
5	Enabled	Auto	On	Link Down
6	Enabled	Auto	On	Link Down

Parameter	Description
Port Settings	
Port	Selects a port or a range of ports on which to configure the port.
State	Select option to enable / disable the port.
Speed/duplex	Select a speed/duplex for port(s).
Flow Control	User can configure flow control on interface on/off
Apply	Click Apply to take effect the settings.
Refresh	Click Refresh to begin configuring this screen afresh.
Port Status	
Port	This field displays the index number of a port.
State	This field displays the state of a port.
Speed/Duplex	This field displays the speed/duplex of a port.
Flow Control	Display the status on the flow control on interface on/off
Link Status	This field displays the link status of a port.

4.2.2. Loop Detection Configuration

Introduction

Loop detection is designed to handle loop problems on the edge of your network. This can occur when a port is connected to a Switch that is in a loop state. Loop state occurs as a result of human error. It happens when two ports on a switch are connected with the same cable. When a switch in loop state sends out broadcast messages the messages loop back to the switch and are re-broadcast again and again causing a broadcast storm.

The difference between the Loop Detection and STP:

Loop Detection

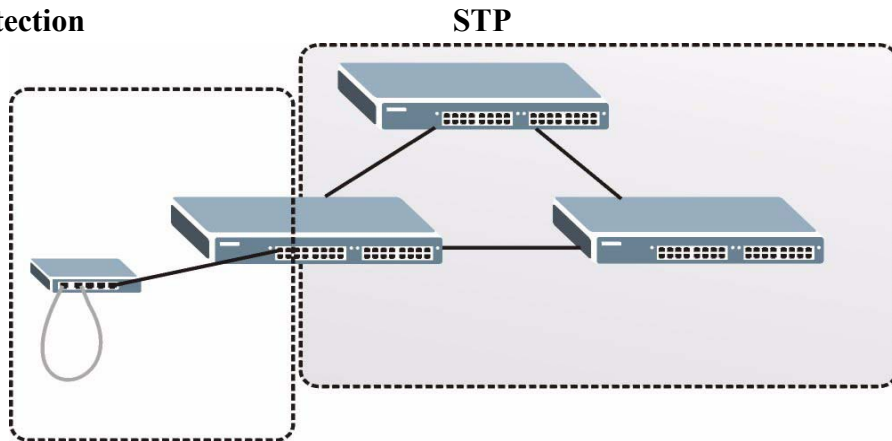

The loop detection function sends probe packets periodically to detect if the port connect to a network in loop state. The Switch shuts down a port if the Switch detects that **probe packets loop back to the same port of the Switch**.

Loop Recovery:

When the loop detection is enabled, the Switch will send one probe packets every two seconds and then wait for this packet. If it receives the packet at the same port, the Switch will disable this port. After the time period, **recovery time**, the Switch will enable this port and do loop detection again.

The Switch generates syslog, internal log messages as well as SNMP traps when it shuts down a port via the loop detection feature.

For the access Switch, it may not enable the STP function. To guarantee the network topology is loop free, the Loop detection function also need detect below scenario.

If port 1 and 2 are loop, and port 1's loop detection is enabled, the port 1 will be disabled. If both of port 1's and port 2's loop detection is enabled, both of port 1 and port 2 will be disabled.

Default Settings

- The default global Loop-Detection state is disabled.
- The default Loop Detection Destination MAC is **00:0b:04:AA:AA:AB**
- The default Port Loop-Detection state is disabled for all ports.

4.2.2.1. CLI Configuration

Node	Command	Description
enable	show loop-detection	This command displays the current loop detection configurations.
configure	loop-detection (disable enable)	This command disables / enables the loop detection on the switch.
configure	loop-detection address MACADDR	This command configures the destination MAC for the loop detection special packets.
configure	no loop-detection address	This command configures the destination MAC to default (00:0b:04:AA:AA:AB).
interface	loop-detection (disable enable)	This command disables / enables the loop detection on the port.
interface	no shutdown	This command enables the port. It can unblock port blocked by loop detection.
interface	loop-detection recovery (disable enable)	This command enables / disables the recovery function on the port.
interface	loop-detection recovery time VALUE	This command configures the recovery period time.
configure	interface range gigabitethernet1/0/ PORTLISTS	This command enters the interface configure node.
if-range	loop-detection (disable enable)	This command disables / enables the loop detection on the ports.
if-range	loop-detection recovery (disable enable)	This command enables / disables the recovery function on the port.
if-range	loop-detection recovery time VALUE	This command configures the recovery period time.

Example:

```
L2SWITCH(config)#loop-detection enable
L2SWITCH(config)#interface 1/0/1
L2SWITCH(config-if)#loop-detection enable
```

4.2.2.2. Web Configuration

Port Settings

Configuration
Loop Detection
Priority

Loop Detection Settings

State Disable ▾

MAC Address

Port	State	Recovery State	Recovery Time(min)
From: <input type="text" value="1"/> ▾ To: <input type="text" value="1"/> ▾	Disable ▾	Enable ▾	<input type="text" value="1"/> (Range: 1-60)

Loop Detection Status

Port	State	Status	Manual Recovery	Recovery State	Recovery Time(min)
1	Disabled	Normal	<input type="button" value="Unblock"/>	Enabled	1
2	Disabled	Normal	<input type="button" value="Unblock"/>	Enabled	1
3	Disabled	Normal	<input type="button" value="Unblock"/>	Enabled	1
4	Disabled	Normal	<input type="button" value="Unblock"/>	Enabled	1
5	Disabled	Normal	<input type="button" value="Unblock"/>	Enabled	1
6	Disabled	Normal	<input type="button" value="Unblock"/>	Enabled	1

Parameter	Description
State	Select this option to enable loop guard on the Switch.
MAC Address	Enter the destination MAC address the probe packets will be sent to. If the port receives these same packets the port will be shut down.
Port	Select a port on which to configure loop guard protection.
State	Select Enable to use the loop guard feature on the Switch.
Loop Recovery	Select Enable to reactivate the port automatically after the designated recovery time has passed.
Recovery Time	Specify the recovery time in minutes that the Switch will wait before reactivating the port. This can be between 1 to 60 minutes.
Apply	Click Apply to save your changes to the Switch.
Refresh	Click Refresh to begin configuring this screen afresh.
Loop Guard Status	
Port	This field displays a port number.

State	This field displays if the loop guard feature is enabled.
Status	This field displays if the port is blocked.
Loop Recovery	This field displays if the loop recovery feature is enabled.
Recovery Time (min)	This field displays the recovery time for the loop recovery feature.

4.2.3. Port Priority

Introduction

Typically, networks operate on a best-effort delivery basis, which means that all traffic has equal priority and an equal chance of being delivered in a timely manner. When congestion occurs, all traffic has an equal chance of being dropped.

Using Port Priority feature, you can select specific network traffic, and prioritize it according to its relative importance. Implementing Port Priority in your network makes network performance more predictable and bandwidth utilization more effective.

4.2.3.1. CLI Configuration

Node	Command	Description
enable	show queue cos-map	This command displays the current 802.1p priority mapping to the service queue.
enable	show qos mode	This command displays the current QoS scheduling mode of IEEE 802.1p.
configure	queue cos-map PRIORITY QUEUE ID	This command configures the 802.1p priority mapping to the service queue.
configure	no queue cos-map	This command configures the 802.1p priority mapping to the service queue to default.
configure	qos mode high-first	This command configures the QoS scheduling mode to high_first, each hardware queue will transmit all of the packets in its buffer before permitting the next lower priority to transmit its packets.
configure	qos mode wrr-queue weights VALUE VALUE VALUE VALUE VALUE VALUE VALUE VALUE	This command configures the QoS scheduling mode to Weighted Round Robin.
interface	default-priority	This command allows the user to specify a default priority handling of untagged packets received by the Switch. The priority value entered with this command will be used to determine which of the hardware priority queues the packet is forwarded to. Default: 0.
interface	no default-priority	This command configures the default priority for the specific port to default (0).
enable	show diffserv	This command displays DiffServ configurations.
configure	diffserv (disable enable)	This command disables / enables the DiffServ function.
configure	diffserv dscp VALUE priority VALUE	This command sets the DSCP-to-IEEE 802.1q mappings.

4.2.3.2. Web Configuration

Port Settings

Configuration
Loop Detection
Priority

Port Priority Settings

All Ports 802.1p priority : - ▾

Port	802.1p priority	Port	802.1p priority
1	0 ▾	2	0 ▾
3	0 ▾	4	0 ▾
5	0 ▾	6	0 ▾

Apply
Refresh

Parameter	Description
Port Priority Settings	
Port	Selects a port or a range of ports on which to configure the priority.
Priority	Select a priority for packets received by the port. Only packets without 802.1p priority tagged will be applied the priority you set here.
Apply	Click Apply to take effect the settings.
Refresh	Click Refresh to begin configuring this screen afresh.
Port Priority Status	
Port	This field displays a port number.
Priority	This field displays the priority for a port.

4.3. Ring Configuration

4.3.1. ERPS

Introduction

The ITU-T G.8032 **Ethernet Ring Protection Switching** feature implements protection switching mechanisms for Ethernet layer ring topologies. This feature uses the G.8032 **Ethernet Ring Protection (ERP)** protocol, defined in ITU-T G.8032, to provide protection for Ethernet traffic in a ring topology, while ensuring that no loops are within the ring at the Ethernet layer. The loops are prevented by blocking traffic on either a predetermined link or a failed link.

The Ethernet ring protection functionality includes the following:

- Loop avoidance
- The use of learning, forwarding, and Filtering Database (FDB) mechanisms

Loop avoidance in an Ethernet ring is achieved by guaranteeing that, at any time, traffic may flow on all but one of the ring links. This particular link is called the **ring protection link (RPL)** and under normal conditions this ring link is blocked, i.e., not used for service traffic. One designated Ethernet ring node, the **RPL owner** node, is responsible to block traffic at one end of the RPL. Under an Ethernet ring failure condition, the RPL owner node is responsible for unblocking its end of the RPL, unless the RPL has failed, allowing the RPL to be used for traffic. The other Ethernet ring node adjacent to the RPL, the **RPL neighbor** node, may also participate in blocking or unblocking its end of the RPL.

The Ethernet rings could support a multi-ring/ladder network that consists of conjoined Ethernet rings by one or more interconnection points. The protection switching mechanisms and protocol defined in this Recommendation shall be applicable for a multi-ring/ladder network, if the following principles are adhered to:

- R-APS channels are not shared across Ethernet ring interconnections;
- on each ring port, each traffic channel and each R-APS channel are controlled (e.g., for blocking or flushing) by the Ethernet ring protection control process (ERP control process) of only one Ethernet ring;
- Each major ring or sub-ring must have its own RPL.

In an Ethernet ring, without congestion, with all Ethernet ring nodes in the idle state (i.e., no detected failure, no active automatic or external command and receiving only "NR, RB" R-APS messages), with less than 1200 km of ring fiber circumference and fewer than 16 Ethernet ring nodes, the switch completion time (transfer time as defined in [ITU-T G.808.1]) for a failure on a ring link shall be less than **50ms**.

The ring protection architecture relies on the existence of an **APS protocol** to coordinate ring protection actions around an Ethernet ring.

The Switch supports up to **six** rings.

Guard timer -- All ERNs use a guard timer. The guard timer prevents the possibility of forming a closed loop and prevents ERNs from applying outdated R-APS messages. The guard timer activates when an ERN receives information about a local switching request, such as after a switch fail (SF), manual switch (MS), or forced switch (FS). When this timer expires, the ERN begins to apply actions from the R-APS it receives. This timer cannot be manually stopped.

Wait to restore (WTR) timer -- The RPL owner uses the WTR timer. The WTR timer applies to the revertive mode to prevent frequent triggering of the protection switching due to port flapping or intermittent signal failure defects. When this timer expires, the RPL owner sends a R-APS (NR, RB) through the ring.

Wait to Block (WTB) timers -- This wait-to-block timer is activated on the RPL owner. The RPL owner uses WTB timers before initiating an RPL block and then reverting to the idle state after operator-initiated commands, such as for FS or MS conditions, are entered. Because multiple FS commands are allowed to co-exist in a ring, the WTB timer ensures that the clearing of a single FS command does not trigger the re-blocking of the RPL. The WTB timer is defined to be 5 seconds longer than the guard timer, which is enough time to allow a reporting ERN to transmit two R-APS messages and allow the ring to identify the latent condition. When clearing a MS command, the WTB timer prevents the formation of a closed loop due to the RPL owner node applying an outdated remote MS request during the recovery process.

Hold-off timer -- Each ERN uses a hold-off timer to delay reporting a port failure. When the timer expires, the ERN checks the port status. If the issue still exists, the failure is reported. If the issue does not exist, nothing is reported.

ERPS revertive and non-revertive switching

ERPS considers revertive and non-revertive operation. In revertive operation, after the condition (s) causing a switch has cleared, the traffic channel is restored to the working transport entity, i.e. blocked on the RPL. In the case of clearing of a defect, the traffic channel reverts after the expiry of a WTR timer, which is used to avoid toggling protection states in case of intermittent defects. In non-revertive operation, the traffic channel continues to use the RPL, if it is not failed, after a switch condition has cleared.

Control VLAN:

The pure ERPS control packets domain only, no other packets are transmitted in this vlan to guarantee no delay for the ERPS. So when you configure a Control VLAN for a ring, the vlan should be a new one. The ERPS will create this control vlan and its member ports automatically. The member port should have the Left and Right ports only.

In ERPS, the control packets and data packets are separated in different vlans. The control packets are transmitted in a vlan which is called the Control VLAN.

Instance:

For ERPS version 2, the instance is a profile specifies a control vlan and a data vlan or multiple data vlans for the ERPS. In ERPS, it can separate the control packets and data packets in different vlans. The control packets are in the Control VLAN and the data packets can be in one or multiple data vlan. And then user can assign an instance to an ERPS ring easily.

In ERPS version 1, if a port is blocked by ERPS, all packets are blocked.

In ERPS version 2, if a port is blocked by a ring of ERPS, only the packets belong to the vlans in the instance are blocked.

Notice:

Control VLAN and Instance:

There are the Control VLAN and the Instance settings.

If the Control VLAN is configured for a ring and you want to configure an instance for the ring. The control vlan of the instance must be same as the Control VLAN; otherwise,

you will get an error. If you still want to use this instance, you can change the Control VLAN to same as the control vlan of the instance first. And then configures the instance.

4.3.1.1. CLI Configuration

Node	Command	Description
enable	show erps	This command displays the ERPS configurations.
enable	show erps instance	This command displays the ERPS instance configurations.
enable	show erps instance INSTANCE_ID	This command displays the specific ERPS instance configurations.
configure	erps enable	This command enables the global ERPS on the Switch.
configure	no erps enable	This command disables the global ERPS on the Switch.
configure	erps ring-id VALUE	This command creates an ERPS ring and its ID and enter ERPS node.
configure	erps instance	This command enters the instance configure node.
configure	no erps ring-id VALUE	This command creates an ERPS ring and enter ERPS node to configure detail ring configurations.
erps-ring	show	This command displays the configurations of the ring.
erps-ring	control-vlan	This command configures a control-vlan for the ERPS ring.
erps-ring	guard-timer	This command configures the Guard Timer for the ERPS ring. (default:500ms)
erps-ring	holdoff-timer	This command configures the Hold-off Timer for the ERPS ring. (default:0 ms)
erps-ring	left-port PORTID type [owner neighbor normal]	This command configures the left port and type for the ERPS ring.
erps-ring	mel VALUE	This command configures a Control MEL for the ERPS ring.
erps-ring	name STRING	This command configures a name for the ERPS ring.
erps-ring	revertive	This command configures the revertive mode for the ERPS ring.
erps-ring	no revertive	This command configures the non-revertive mode for the ERPS ring.
erps-ring	right-port PORTID type [owner neighbor normal]	This command configures the right port and type for the ERPS ring.
erps-ring	ring enable	This command enables the ring.
erps-ring	no ring enable	This command disables the ring.

erps-ring	version	This command configures a version for the ERPS ring.
erps-ring	wtr-timer	This command configures the WTR Timer for the ERPS ring. (default: 5 minutes)
config-erps -inst	instance INSTANCE_ID control-vlan VLAN_ID data-vlan VLAN_ID	This command configures a new instance and specifies its control vlan and data vlan.
config-erps -inst	no instance INSTANCE_ID	This command removes an instance.
config-erps -inst	show	This command displays all of the instance configurations.

4.3.1.2. Web Configuration

Ring Settings

ERPS Configuration
ERPS Instance
STP
STP Port

ERPS Global Settings

Global State Disable ▾

ERPS Ring Settings

Ring ID	<input style="width: 90%;" type="text"/> (1~255)	State	Disable ▾
Ring Name	<input style="width: 90%;" type="text"/>	Revertive	Enable ▾
Instance	<input style="width: 90%;" type="text"/> (0:Default, 0~2)	Ring Type	Major-ring ▾
Control VLAN	<input style="width: 90%;" type="text"/> (1~4094)	Version	v2 ▾
Holdoff Timer (ms)	<input style="width: 90%;" type="text"/> (0~10000)	WTR Timer (sec)	<input style="width: 90%;" type="text"/> (5~720)
MEL	<input style="width: 90%;" type="text"/> (0~7)	Guard Timer (ms)	<input style="width: 90%;" type="text"/> (10~2000)
Left Port	None ▾ Normal ▾	Right Port	None ▾ Normal ▾

Apply
Refresh

ERPS Ring Status

Parameter	Description
Global State	Enables / disables the global ERPS state.
Ring ID	Configures the ring ID. The Valid value is from 1 to 255.
State	Enables/ disables the ring state.
Ring Name	Configures the ring name.(Up to 32 characters)

Revertive	Enables / disables the revertive mode.
Instance	Configures the instance for the ring. The Valid value is from 0 to 30. 0-Disable means the ERPS is running in version 1. The control VLAN of the instance should be same as below Control VLAN.
Control VLAN	Configures the Control VLAN which is the ERPS control packets domain for the ring.
Version	Configures the version for the ring.
Hold-off Timer	Configures the Hold-off time for the ring. The Valid value is from 0 to 10000 (ms).
WTR Timer	Configures the WTR time for the ring. The Valid value is from 5 to 12 (min).
MEL	Configures the Control MEL for the ring. The Valid value is from 0 to 7. The default is 7.
Guard Timer	Configures the Guard time for the ring. The Valid value is from 10 to 2000 (ms).
Left Port	Configures the left port and its type for the ring. The valid port type is one of Owner, Neighbor or Normal.
Right Port	Configures the right port and its type for the ring. The valid port type is one of Owner, Neighbor or Normal.
ERPS Status	
Ring ID	The ring ID.
Ring Name	The ring name.
State	The ring state.
Revertive	The ring revertive mode.
Control VLAN	The ring Control VLAN.
Version	The protocol version on the ring.
Hold off Timer	The Hold-off time.
WTR Timer	The WTR time.
MEL	The Control MEL.
Guard Timer	The Guard time.
Left Port	The left port.

Left Port Type	The left port type.
Right Port	The right port.
Right Port Type	The right port type.
WTB Timer	The WTB time.
Ring Status	The current ring status.
Left Port Status	The current left port status.
Right Port Status	The current right port status.

4.3.1.3. Web Configuration

Ring Settings

ERPS Configuration
ERPS Instance
STP
STP Port

ERPS Instance Settings

Instance (1~2)

Control VLAN (1~4094) Data VLAN
(Multiple VLAN List, e.g. 1,2,5,10)

ERPS Instance Status

Parameter	Description
Instance Settings	
Instance	Configures the instance ID. The valid value is from 1 to 31.
Control VLAN	Configures the control vlan for the instance. The valid value is from 1 to 4094.
Data VLAN	Configures the data vlan for the instance. The valid value is from 1 to 4094. It can be one or multiple vlans.
Instance Status	
Instance	The instance ID.
Control VLAN	The control vlan of the instance.
Data VLAN	The data vlan of the instance.

4.3.2. STP/RSTP

Introduction

(R)STP detects and breaks network loops and provides backup links between switches, bridges or routers. It allows a Switch to interact with other (R)STP compliant switches in your network to ensure that only one path exists between any two stations on the network.

The Switch supports Spanning Tree Protocol (STP) and Rapid Spanning Tree Protocol (RSTP) as defined in the following standards.

- IEEE 802.1D Spanning Tree Protocol
- IEEE 802.1w Rapid Spanning Tree Protocol

The Switch uses IEEE 802.1w RSTP (Rapid Spanning Tree Protocol) that allows faster convergence of the spanning tree than STP (while also being backwards compatible with STP-only aware bridges). In RSTP, topology change information is directly propagated throughout the network from the device that generates the topology change. In STP, a longer delay is required as the device that causes a topology change first notifies the root bridge and then the root bridge notifies the network. Both RSTP and STP flush unwanted learned addresses from the filtering database.

In STP, the port states are Blocking, Listening, Learning, Forwarding.

In RSTP, the port states are Discarding, Learning, and Forwarding.

Note: In this document, “STP” refers to both STP and RSTP.

STP Terminology

- The root bridge is the base of the spanning tree.
- Path cost is the cost of transmitting a frame onto a LAN through that port. The recommended cost is assigned according to the speed of the link to which a port is attached. The slower the media, the higher the cost.

Table 27 STP Path Costs

	LINK SPEED	RECOMMENDED VALUE	RECOMMENDED RANGE	ALLOWED RANGE
Path Cost	4Mbps	250	100 to 1000	1 to 65535
Path Cost	10Mbps	100	50 to 600	1 to 65535
Path Cost	16Mbps	62	40 to 400	1 to 65535
Path Cost	100Mbps	19	10 to 60	1 to 65535
Path Cost	1Gbps	4	3 to 10	1 to 65535
Path Cost	10Gbps	2	1 to 5	1 to 65535

- On each bridge, the bridge communicates with the root through the root port. The root port is the port on this Switch with the lowest path cost to the root (the root path cost). If there is no root port, then this Switch has been accepted as the root bridge of the spanning tree network.
- For each LAN segment, a designated bridge is selected. This bridge has the lowest cost to the root among the bridges connected to the LAN.

Forward Time (Forward Delay):

This is the maximum time (in seconds) the Switch will wait before changing states. This delay is required because every switch must receive information about topology changes before it starts to forward frames. In addition, each port needs time to listen for conflicting information that would make it return to a blocking state; otherwise, temporary data loops might result. The allowed range is 4 to 30 seconds.

Max Age:

This is the maximum time (in seconds) the Switch can wait without receiving a BPDU before attempting to reconfigure. All Switch ports (except for designated ports) should receive BPDUs at regular intervals. Any port that ages out STP information (provided in the last BPDU) becomes the designated port for the attached LAN. If it is a root port, a new root port is selected from among the Switch ports attached to the network. The allowed range is 6 to 40 seconds.

Hello Time:

This is the time interval in seconds between BPDU (Bridge Protocol Data Units) configuration message generations by the root switch. The allowed range is 1 to 10 seconds.

PathCost:

Path cost is the cost of transmitting a frame on to a LAN through that port. It is recommended to assign this value according to the speed of the bridge. The slower the media, the higher the cost.

How STP Works

After a bridge determines the lowest cost-spanning tree with STP, it enables the root port and the ports that are the designated ports for connected LANs, and disables all other ports that participate in STP. Network packets are therefore only forwarded between enabled ports, eliminating any possible network loops.

STP-aware switches exchange Bridge Protocol Data Units (BPDUs) periodically. When the bridged LAN topology changes, a new spanning tree is constructed. Once a stable network topology has been established, all bridges listen for Hello BPDUs (Bridge Protocol Data Units) transmitted from the root bridge. If a bridge does not get a Hello BPDU after a predefined interval (Max Age), the bridge assumes that the link to the root bridge is down. This bridge then initiates negotiations with other bridges to reconfigure the network to re-establish a valid network topology.

802.1D STP

The Spanning Tree Protocol (STP) is a link layer network protocol that ensures a loop-free topology for any bridged LAN. It is based on an algorithm invented by Radia Perlman while working for Digital Equipment Corporation. In the OSI model for computer networking, STP falls under the OSI layer-2. Spanning tree allows a network design to include spare (redundant) links to provide automatic backup paths if an active

link fails, without the danger of bridge loops, or the need for manual enabling/disabling of these backup links. Bridge loops must be avoided because they result in flooding the network.

The Spanning Tree Protocol (STP) is defined in the IEEE Standard 802.1D. As the name suggests, it creates a spanning tree within a mesh network of connected layer-2 bridges (typically Ethernet switches), and disables those links that are not part of the tree, leaving a single active path between any two network nodes.

STP switch port states:

- Blocking - A port that would cause a switching loop, no user data is sent or received but it may go into forwarding mode if the other links in use were to fail and the spanning tree algorithm determines the port may transition to the forwarding state. BPDU data is still received in blocking state.
- Listening - The switch processes BPDUs and awaits possible new information that would cause it to return to the blocking state.
- Learning - While the port does not yet forward frames (packets) it does learn source addresses from frames received and adds them to the filtering database (switching database).
- Forwarding - A port receiving and sending data, normal operation. STP still monitors incoming BPDUs that would indicate it should return to the blocking state to prevent a loop.
- Disabled - Not strictly part of STP, a network administrator can manually disable a port.

802.1w RSTP

In 1998, the IEEE with document 802.1w introduced an evolution of the Spanning Tree Protocol: Rapid Spanning Tree Protocol (RSTP), which provides for faster spanning tree convergence after a topology change. Standard IEEE 802.1D-2004 now incorporates RSTP and obsoletes STP. While STP can take 30 to 50 seconds to respond to a topology change, RSTP is typically able to respond to changes within a second.

RSTP bridge port roles:

- Root - A forwarding port that is the best port from Nonroot-bridge to Rootbridge
- Designated - A forwarding port for every LAN segment
- Alternate - An alternate path to the root bridge. This path is different than using the root port.
- Backup - A backup/redundant path to a segment where another bridge port already connects.
- Disabled - Not strictly part of STP, a network administrator can manually disable a port

Edge Port:

They are attached to a LAN that has no other bridges attached. These edge ports transition directly to the forwarding state. RSTP still continues to monitor the port for BPDUs in case a bridge is connected. RSTP can also be configured to

automatically detect edge ports. As soon as the bridge detects a BPDU coming to an edge port, the port becomes a non-edge port.

Forward Delay:

The range is from 4 to 30 seconds. This is the maximum time (in seconds) the root device will wait before changing states (i.e., listening to learning to forwarding).

Transmission Limit:

This is used to configure the minimum interval between the transmission of consecutive RSTP BPDUs. This function can only be enabled in RSTP mode. The range is from 1 to 10 seconds.

Hello Time:

Set the time at which the root switch transmits a configuration message. The range is from 1 to 10 seconds.

Bridge Priority:

Bridge priority is used in selecting the root device, root port, and designated port. The device with the highest priority becomes the STA root device. However, if all devices have the same priority, the device with the lowest MAC address will become the root device.

Port Priority:

Set the port priority in the switch. Low numeric value indicates a high priority. A port with lower priority is more likely to be blocked by STP if a network loop is detected. The valid value is from 0 to 240.

Path Cost:

The valid value is from 1 to 200000000. Higher cost paths are more likely to be blocked by STP if a network loop is detected.

BPDU Guard

This is a per port setting. If the port is enabled in BPDU guard and receive any BPDU, the port will be set to disable to avoid the error environments. User must enable the port by manual.

BPDU Filter

It is a feature to filter sending or receiving BPDUs on a switch port. If the port receives any BPDUs, the BPDUs will be dropped.

Notice:

If both of the BPDU filter and BPDU guard are enabled, the BPDU filter has the high priority.

Root Guard

The Root Guard feature forces an interface to become a designated port to prevent surrounding switches from becoming a root switch. In other words, Root Guard provides a way to enforce the root bridge placement in the network. The Root Guard feature prevents a Designated Port from becoming a Root Port. If a port on which the Root Guard feature receives a superior BPDU, it moves the port into a root-inconsistent state (effectively equal to a listening state), thus maintaining the current Root Bridge status. The port can be moved to forwarding state if no superior BPDU received by this port for three hello time.

Default Settings

- STP/RSTP : disabled.
- STP/RSTP mode : RSTP.
- Forward Time : 15 seconds.
- Hello Time : 2 seconds.
- Maximum Age : 20 seconds.
- System Priority : 32768.
- Transmission Limit : 3 seconds.
- Per port STP state : enabled.
- Per port Priority : 128.
- Per port Edge port : disabled.
- Per port BPDU filter : disabled.
- Per port BPDU guard : disabled.
- Per port BPDU Root guard: disabled.
- Per port Path Cost : depend on port link speed.

Example: Bandwidth -> STP Port Cost Value

10 Mbps -> 100

100 Mbps-> 19

1 Gbps -> 4

10 Gbps -> 2

4.3.2.1. CLI Configuration

Node	Command	Description
enable	show spanning-tree active	This command displays the spanning tree information for only active port(s)
enable	show spanning-tree blockedports	This command displays the spanning tree information for only blocked port(s)
enable	show spanning-tree port detail PORT_ID	This command displays the spanning tree information for the interface port.
enable	show spanning-tree statistics PORT_ID	This command displays the spanning tree information for the interface port.
enable	show spanning-tree summary	This command displays the summary of port states and configurations
enable	clear spanning-tree	This command clears spanning-tree statistics for

	counters	all ports.
enable	clear spanning-tree counters PORT_ID	This command clears spanning-tree statistics for a specific port.
configure	spanning-tree (disable enable)	This command disables / enables the spanning tree function for the system.
configure	spanning-tree algorithm-timer forward-time TIME max-age TIME hello-time TIME	This command configures the bridge times (forward-delay,max-age,hello-time).
configure	no spanning-tree algorithm-timer	This command configures the default values for forward-time & max-age & hello-time.
configure	spanning-tree forward-time <4-30>	This command configures the bridge forward delay time (sec).
configure	no spanning-tree forward-time	This command configures the default values for forward-time.
configure	spanning-tree hello-time <1-10>	This command configures the bridge hello time(sec).
configure	no spanning-tree hello-time	This command configures the default values for hello-time.
configure	spanning-tree max-age <6-40>	This command configures the bridge message max-age time(sec).
configure	no spanning-tree max-age	This command configures the default values for max-age time.
configure	spanning-tree mode (rstp stp)	This command configures the spanning mode.
configure	spanning-tree pathcost method (short long)	This command configures the pathcost method.
configure	spanning-tree priority <0-61440>	This command configures the priority for the system.
configure	no spanning-tree priority	This command configures the default values for the system priority.
interface	spanning-tree (disable enable)	This command configures enables/disables the STP function for the specific port.
interface	spanning-tree bpdufilter (disable enable)	This command configures enables/disables the bpdufilter function for the specific port.
interface	spanning-tree bpduguard (disable enable)	This command configures enables/disables the bpduguard function for the specific port.
interface	spanning-tree rootguard (disable enable)	This command enables/disables the BPDU Root guard port setting for the specific port.
interface	spanning-tree edge-port	This command enables/disables the edge port setting for the specific port.

	(disable enable)	
interface	spanning-tree cost VALUE	This command configures the cost for the specific port. Cost range: 16-bit based value range 1-65535, 32-bit based value range 1-200000000.
interface	no spanning-tree cost	This command configures the path cost to default for the specific port.
interface	spanning-tree port-priority <0-240>	This command configures the port priority for the specific port. Default: 128.
interface	no spanning-tree port-priority	This command configures the port priority to default for the specific port.
configure	interface range gigabitethernet1/0/ PORTLISTS	This command enters the interface configure node.
if-range	spanning-tree (disable enable)	This command configures enables/disables the STP function for the specific port.
if-range	spanning-tree bpdufilter (disable enable)	This command configures enables/disables the bpdufilter function for the specific port.
if-range	spanning-tree bpduguard (disable enable)	This command configures enables/disables the bpduguard function for the specific port.
if-range	spanning-tree rootguard (disable enable)	This command enables/disables the BPDU Root guard port setting for the specific port.
if-range	spanning-tree edge-port (disable enable)	This command enables/disables the edge port setting for the specific port.
if-range	spanning-tree cost VALUE	This command configures the cost for the specific port. Cost range: 16-bit based value range 1-65535, 32-bit based value range 1-200000000.
if-range	no spanning-tree cost	This command configures the path cost to default for the specific port.
if-range	spanning-tree port-priority <0-240>	This command configures the port priority for the specific port. Default: 128.
if-range	no spanning-tree port-priority	This command configures the port priority to default for the specific port.

4.3.2.2. Web Configuration

Ring Settings

ERPS Configuration
ERPS Instance
STP
STP Port

STP Global Settings

State

Mode

STP Parameter Settings

Forward Delay (sec) (4~30)

Max Age (sec) (6~40)

Hello Time(sec) (1~10)

Priority (0~61440)

Pathcost Method

Relationships:
 $2 * (\text{Forward Delay} - 1) \geq \text{Max Age}$
 $\text{Max Age} \geq 2 * (\text{Hello Time} + 1)$

Parameter	Description
State	Select Enabled to use Spanning Tree Protocol (STP) or Rapid Spanning Tree Protocol (RSTP).
Mode	Select to use either Spanning Tree Protocol (STP) or Rapid Spanning Tree Protocol (RSTP).
Forward Delay	This is the maximum time (in seconds) the Switch will wait before changing states. This delay is required because every switch must receive information about topology changes before it starts to forward frames. In addition, each port needs time to listen for conflicting information that would make it return to a blocking state; otherwise, temporary data loops might result. The allowed range is 4 to 30 seconds.
Max Age	This is the maximum time (in seconds) the Switch can wait without receiving a BPDU before attempting to reconfigure. All Switch ports (except for designated ports) should receive BPDUs at regular intervals. Any port that ages out STP information (provided in the last BPDU) becomes the designated port for the attached LAN. If it is a root port, a new root port is selected from among the Switch ports attached to the network. The allowed range is 6 to 40 seconds.
Hello Time	This is the time interval in seconds between BPDU (Bridge Protocol Data Units) configuration message generations by the root switch. The allowed range is 1 to 10 seconds.

Priority	<p>Priority is used in determining the root switch, root port and designated port. The switch with the highest priority (lowest numeric value) becomes the STP root switch. If all switches have the same priority, the switch with the lowest MAC address will then become the root switch.</p> <p>Enter a value from 0~61440.</p> <p>The lower the numeric value you assign, the higher the priority for this bridge.</p> <p>Priority determines the root bridge, which in turn determines the Root Hello Time, Root Maximum Age and Root Forwarding Delay.</p>
Pathcost Method	<p>Path cost is the cost of transmitting a frame on to a LAN through that port. It is recommended to assign this value according to the speed of the bridge. The slower the media, the higher the cost.</p>

4.3.2.3. Web Configuration

Ring Settings

ERPS Configuration
ERPS Instance
STP
STP Port

STP Port Settings

Port	Path Cost	Priority	Edge Port	BPDU Filter	BPDU Guard	ROOT Guard
From: <input type="text" value="1"/> To: <input type="text" value="1"/>	<input type="text" value="250"/>	<input type="text" value="128"/>	<input type="text" value="Disable"/>	<input type="text" value="Disable"/>	<input type="text" value="Disable"/>	<input type="text" value="Disable"/>

STP Port Status

Port	Role	Status	Path Cost	Priority	Edge Port	BPDU Filter	BPDU Guard	ROOT Guard
1	None	Discarding	250	128	Disabled	Disabled	Disabled	Disabled
2	None	Discarding	250	128	Disabled	Disabled	Disabled	Disabled
3	None	Discarding	250	128	Disabled	Disabled	Disabled	Disabled
4	None	Discarding	250	128	Disabled	Disabled	Disabled	Disabled
5	None	Discarding	250	128	Disabled	Disabled	Disabled	Disabled
6	None	Discarding	250	128	Disabled	Disabled	Disabled	Disabled

Parameter	Description
Port	Selects a port that you want to configure.
Active	Enables/Disables the spanning tree function for the specific port.
Path Cost	Configures the path cost for the specific port.

Priority	Configures the priority for the specific port.
Edge Port	Configures the port type for the specific port. Edge or Non-Edge.
BPDU Filter	Enables/Disables the BPDU filter function for the specific port.
BPDU Guard	Enables/Disables the BPDU guard function for the specific port.
ROOT Guard	Enables/Disables the BPDU root guard function for the specific port.
Port Status	
Active	The state of the STP function.
Role	The port role. Should be one of the Alternated / Designated / Root / Backup / None.
Status	The port's status. Should be one of the Discarding / Blocking / Listening / Learning / Forwarding / Disabled.
Path Cost	The port's path cost.
Priority	The port's priority.
Edge Port	The state of the edge function.
BPDU Filter	The state of the BPDU filter function.
BPDU Guard	The state of the BPDU guard function.
ROOT Guard	The state of the BPDU Root guard function.

4.4. System Settings

4.4.1. System Settings

Host Name

The **hostname** is same as the SNMP system name. Its length is up to 64 characters.

Management VLAN

The **Management VLAN** is used to configure the switch management VLAN.

4.4.1.1. CLI Configuration

Node	Command	Description
configure	hostname STRINGS	This command sets the system's network name.
eth0	management vlan VLANID	This command configures the management vlan.

4.4.1.2. Modbus TCP Settings

MODBUS TCP supports different types of data format for reading. The primary four types of them are:

Data Access Type		Function Code	Function Name	Note
Bit access	Physical Discrete Inputs	2	Read Discrete Inputs	Not support now
	Internal Bits or Physical Coils	1	Read Coils	Not support now
Word access (16-bit access)	Physical Input Registers	4	Read Input Registers	
	Physical Output Registers	3	Read Holding Registers	Not support now

4.4.1.3. CLI Configuration

Node	Command	Description
enable	show modbus	This command displays the current Modbus configurations.
configure	modbus (disable enable)	This command disables / enables the Modbus on the switch.

4.4.2. IGMP Snooping

Introduction

The IGMP snooping is for multicast traffic. The Switch can passively snoop on IGMP packets transferred between IP multicast routers/switches and IP multicast hosts to learn the IP multicast group membership. It checks IGMP packets passing through it, picks out the group registration information, and configures multicasting accordingly. IGMP snooping allows the Switch to learn multicast groups without you having to manually configure them.

The Switch can passively snoop on IGMP packets transferred between IP multicast routers/switches and IP multicast hosts to learn the IP multicast group membership. It checks IGMP packets passing through it, picks out the group registration information, and configures multicasting accordingly. IGMP snooping allows the Switch to learn multicast groups without you having to manually configure them.

The Switch forwards multicast traffic destined for multicast groups (that it has learned from IGMP snooping or that you have manually configured) to ports that are members of that group. IGMP snooping generates no additional network traffic, allowing you to significantly reduce multicast traffic passing through your Switch.

The Switch can perform IGMP snooping on up to 4094 VLANs. You can configure the Switch to automatically learn multicast group membership of any VLANs. The Switch then performs IGMP snooping on the first VLANs that send IGMP packets. Alternatively, you can specify the VLANs that IGMP snooping should be performed on. This is referred to as fixed mode. In fixed mode the Switch does not learn multicast group membership of any VLANs other than those explicitly added as an IGMP snooping VLAN.

IGMP Snooping VLAN State

Users can enable/disable the IGMP Snooping on the Switch. Users also can enable/disable the IGMP Snooping on a specific VLAN. If the IGMP Snooping on the Switch is disabled, the IGMP Snooping is disabled on all VLANs even some of the VLAN IGMP Snooping are enabled.

Default Settings

If received packets are not received after 400 seconds, all multicast entries will be deleted.

The default global IGMP snooping state is disabled.

The default VLAN IGMP snooping state is disabled for all VLANs.

The unknown multicast packets will be dropped.

Notices: There are a global state and per VLAN states. When the global state is disabled, the IGMP snooping on the Switch is disabled even per VLAN states are enabled. When the global state is enabled, user must enable per VLAN states to enable the IGMP Snooping on the specific VLAN.

4.4.2.1. CLI Configuration

Node	Command	Description
enable	show igmp-snooping	This command displays the current IGMP snooping configurations.
enable	show igmp-snooping counters	This command displays the current IGMP snooping counters.
enable	show igmp-snooping querier	This command displays the current IGMP Queriers.
enable	show multicast	This command displays the multicast group in IP format.
configure	clear igmp-snooping counters	This command clears all of the IGMP snooping counters.
configure	igmp-snooping (disable enable)	This command disables / enables the IGMP snooping on the switch.
configure	igmp-snooping vlan VLANID	This command enables the IGMP snooping function on a VLAN or range of VLANs.
configure	no igmp-snooping vlan VLANID	This command disables the IGMP snooping function on a VLAN or range of VLANs.
configure	igmp-snooping unknown-multicast (drop flooding)	This command configures the process for unknown multicast packets when the IGMP snooping function is enabled. <i>drop</i> : Drop all of the unknown multicast packets.
interface	igmp-querier-mode (auto fixed edge)	This command specifies whether or not and under what conditions the port(s) is (are) IGMP query port(s). The Switch forwards IGMP join or leave packets to an IGMP query port, treating the port as being connected to an IGMP multicast router (or server). You must enable IGMP snooping as well. (Default: auto)
interface	igmp-immediate-leave	This command enables the IGMP Snooping immediate leave function for the specific interface.
interface	no igmp-immediate-leave	This command disables the IGMP Snooping immediate leave function for the specific interface.
interface	igmp-snooping group-limit VALUE	This command configures the maximum groups for the specific interface.
interface	no igmp-snooping group-limit	This command removes the limitation of the maximum groups for the specific interface.
configure	interface range gigabitethernet1/0/PORTLISTS	This command enters the interface configure node.
if-range	igmp-immediate-leave	This command enables the IGMP Snooping immediate leave function for the specific ports.

if-range	no igmp-immediate-leave	This command disables the IGMP Snooping immediate leave function for the specific ports.
if-range	igmp-snooping group-limit VALUE	This command configures the maximum groups for the specific ports.
if-range	no igmp-snooping group-limit	This command removes the limitation of the maximum groups for the specific ports.
if-range	igmp-querier-mode (auto fixed edge)	This command specifies whether or not and under what conditions the ports is (are) IGMP query port(s). The Switch forwards IGMP join or leave packets to an IGMP query port, treating the port as being connected to an IGMP multicast router (or server). You must enable IGMP snooping as well. (Default: auto)

4.4.3. IPV4 Settings

IPV4 Settings is used to configure the switch management IP by static or DHCP Client.

Default Settings

The default DHCP client is disabled.

The default Static IP is 192.168.0.254

Subnet Mask is 255.255.255.0

Default Gateway is 0.0.0.0

4.4.3.1. CLI Configuration

Node	Command	Description
enable	ping IPADDR [-c COUNT]	This command sends an echo request to the destination host. The -c parameter allow user to specific the packet count. The default count is 4.
enable	ping IPADDR [-s SIZE]	This command sends an echo request to the destination host. The -s parameter allow user to specific the packet size. Valid range: 0 ~ 1047 bytes.
enable	ping IPADDR [-c COUNT -s SIZE]	This command sends an echo request to the destination host. The -c parameter allow user to specific the packet count. The default count is 4. The -s parameter allow user to specific the packet size. Valid range: 0 ~ 1047 bytes.
enable	ping IPADDR [-s SIZE -c COUNT]	This command sends an echo request to the destination host. The -c parameter allow user to specific the packet count. The default count is 4. The -s parameter allow user to specific the packet size. Valid range: 0 ~ 1047 bytes.
configure	reboot	This command reboots the system.
configure	interface eth0	This command enters the eth0 interface node to configure the system IP.

configure	configure terminal	This command changes the mode to config mode.
configure	interface eth0	This command changes the mode to eth0 mode.
eth0	show	This command displays the eth0 configurations.
eth0	ip address A.B.C.D/M	This command configures a static IP and subnet mask for the system.
eth0	ip address default-gateway A.B.C.D	This command configures the system default gateway.
eth0	ip dhcp client (disable enable renew)	This command configures a DHCP client function for the system. Disable: Use a static IP address on the switch. Enable & Renew: Use DHCP client to get an IP address from DHCP server.

Example: The procedures to configure an IP address for the Switch.

To enter the configure node.

```
L2SWITCH#configure terminal
```

```
L2SWITCH(config)#
```

To enter the ETH0 interface node.

```
L2SWITCH(config)#interface eth0
```

```
L2SWITCH(config-if)#
```

To get an IP address from a DHCP server.

```
L2SWITCH(config-if)#ip dhcp client enable
```

To configure a static IP address and a gateway for the Switch.

```
L2SWITCH(config-if)#ip address 192.168.202.111/24
```

```
L2SWITCH(config-if)#ip address default-gateway 192.168.202.1
```

4.4.3.2. Web Configuration

System Settings

System Settings	
Hostname	<input type="text" value="L2SWITCH"/>
Management VLAN	<input type="text" value="1"/>
Modbus TCP Settings	
Modbus TCP State	<input type="text" value="Disable"/>
IGMP Snooping Settings	
IGMP Snooping State	<input type="text" value="Disable"/>
IGMP Snooping VLAN State	<input type="text" value="Add"/> <input style="width: 200px;" type="text"/>
Unknown Multicast Packets	<input type="text" value="Drop"/>
IPv4 Settings	
DHCP Client	<input type="text" value="Enable"/> <input type="button" value="Renew"/>
IP Address	<input type="text" value="192.168.202.165"/>
Subnet Mask	<input type="text" value="255.255.255.0"/>
Default Gateway	<input type="text" value="192.168.202.1"/>
<input type="button" value="Apply"/> <input type="button" value="Refresh"/>	

Parameter	Description
System Settings	
Hostname	Enter up to 64 alphanumeric characters for the name of your Switch. The hostname should be the combination of the digit or the alphabet or hyphens (-) or underscores (_).
Management VLAN	This field is to configure Management VLAN .
Modbus TCP Settings	
Modbus TCP State	Select option to enable / disable the Modbus TCP on the Switch.
IGMP Snooping Settings	
IGMP Snooping State	Select Enable to activate IGMP Snooping to forward group multicast traffic only to ports that are members of that group. Select Disable to deactivate the feature.
IGMP Snooping VLAN state	Select Add and enter VLANs upon which the Switch is to perform IGMP snooping. The valid range of VLAN IDs is

	between 1 and 4094. Use a comma (,) or hyphen (-) to specify more than one VLANs. Select Delete and enter VLANs on which to have the Switch not perform IGMP snooping.
Unknown Multicast Packets	Specify the action to perform when the Switch receives an unknown multicast frame. Select Drop to discard the frame(s). Select Flooding to send the frame(s) to all ports.
IPv4 Settings	
DHCP Client	Select Enable to allow the Switch to automatically get an IP address from a DHCP server. Click Renew to have the Switch re-get an IP address from the DHCP server. Select Disable if you want to configure the Switch's IP address manually.
IP Address	Configures an IPv4 address for your Switch in dotted decimal notation. For example, 192.168.0.254.
Subnet Mask	Enter the IP subnet mask of your Switch in dotted decimal notation for example 255.255.255.0.
Default Gateway	Enter the IP address of the default outgoing gateway in dotted decimal notation, for example 192.168.1.1.
Apply	Click Apply to take effect the settings.
Refresh	Click Refresh to begin configuring this screen afresh.

5. Network Topology

5.1. Map Settings

Introduction

The Topology Map is a feature to check neighbor devices' information or to configure them easily. Click the Topology Map, the system will display topology as below.

All devices connect to the Switch directly and support LLDP will be displayed on the screen. Such as below figure, the Switch is its neighbor device. When move the mouse indicator on the Device icon, it will display a few information about the connected device. If the neighbor device is a Switch which supports Lamungan Management function, click the right key of the mouse. The menu will be displayed on the screen. And then you can click an item which you want to configure the Switch.





Note: Topology map can be viewed on Google Chrome, Microsoft Edge, or Firefox browsers, IE will not be supportive as it don't have long time support from Microsoft for update.

5.1.1. CLI Configuration

Node	Command	Description
configure	lamungan-device background-type (picture color)	This command is used to configure manual registration of lamungan device background-type (picture color).

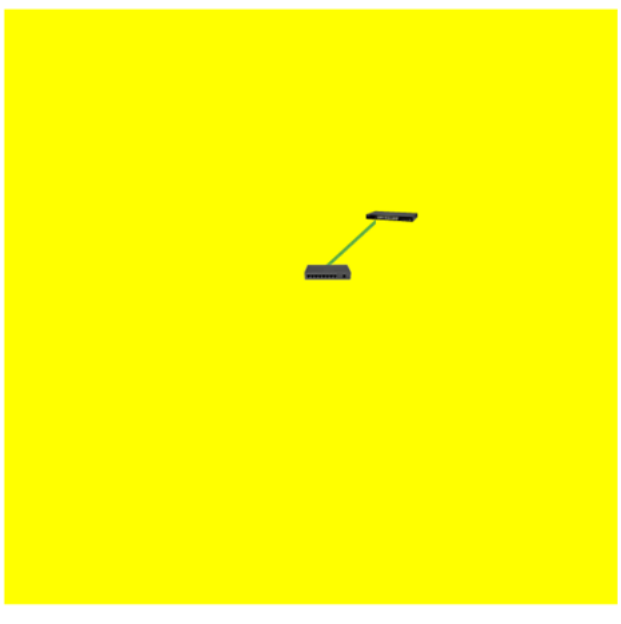

5.1.2. Web Configuration

Map Settings

<p>Background</p> <p><input type="radio"/> Picture  Upload image file in GIF/PNG/JPG/BMP format. file size upto 80 KB, 1140*625 pixels <input type="button" value="Choose File"/> No file chosen <input type="button" value="Upload"/></p> <p><input checked="" type="radio"/> Color #FFFF00 </p> <p><input type="button" value="Apply"/> <input type="button" value="Refresh"/> <input type="button" value="Default"/></p>	<p>Preview</p> 
<p>Alter Device Icon</p> <p>Port <input type="text" value="1"/> - <input type="text" value="1"/></p> <p>State <input type="text" value="Enable"/></p> <p>Image  Upload image file in GIF/PNG/JPG/BMP format. file size upto 40 KB <input type="button" value="Choose File"/> No file chosen <input type="button" value="Upload"/></p> <p><input type="button" value="Apply"/> <input type="button" value="Refresh"/></p>	

Background Settings

You can upload your company floor layout plan picture in to the background image so that you can identify easily where the switch has been placed.

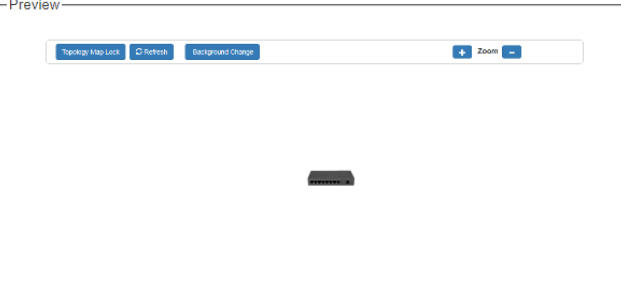
<p>Background</p> <p><input checked="" type="radio"/> Picture  Upload image file in GIF/PNG/JPG/BMP format. file size upto 40 KB, 1140*625 pixels <input type="button" value="Choose File"/> No file chosen <input type="button" value="Upgrade"/></p> <p><input type="radio"/> Color #FFFFFF </p> <p><input type="button" value="Apply"/> <input type="button" value="Refresh"/> <input type="button" value="Exit"/> <input type="button" value="Default"/></p>	<p>Preview</p> 
--	---

- **Picture**

To choice a file which you want to display it in the background and the Preview window will display your select immediately. If you click the “Upgrade” button, the file will be download to the Switch and it will be applied on next reboot.

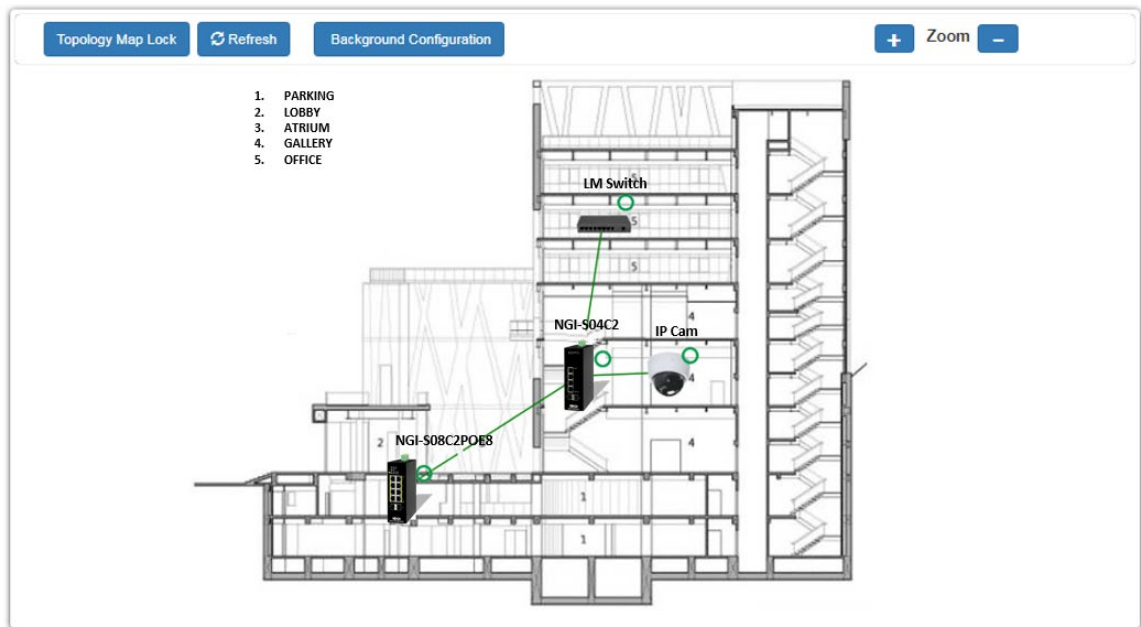

- **Color**

Allows the user to select standard color for the background. The Preview window will display your selection.

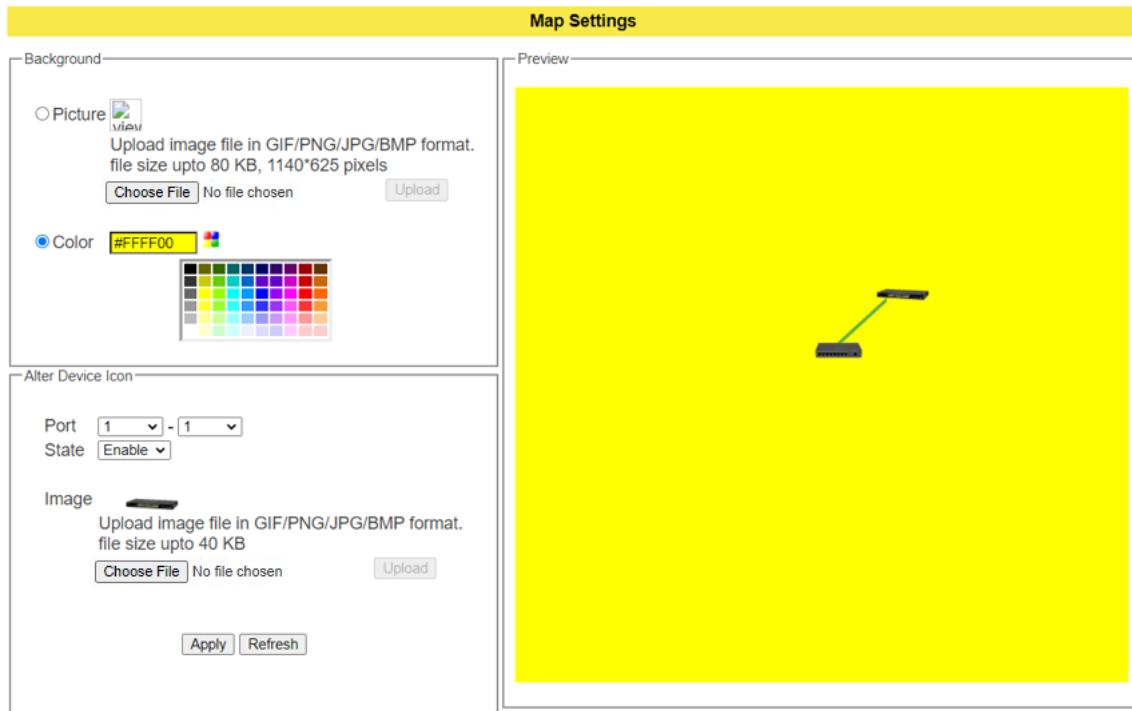

Client Switch Management

By right-clicking on the neighbor non-lite switch, this menu will appear and can configure as shown below.

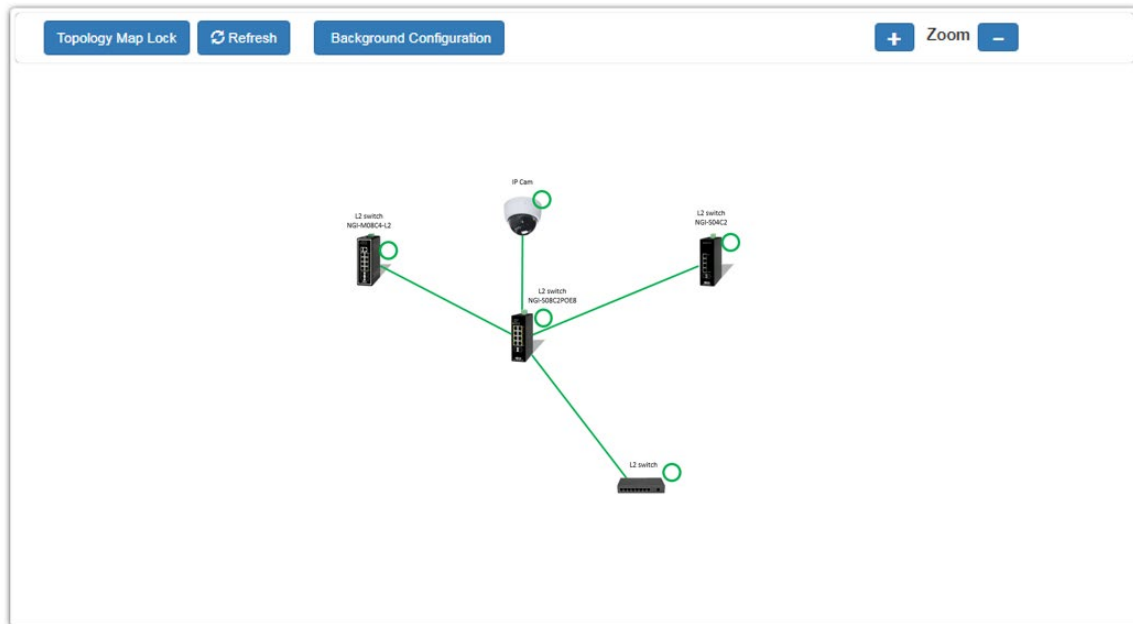

Non-Lite Switch Menu:

- **Save All Device Location**
To fix the location of all devices on the map, so that it restores its places after refresh.
- **Login Web GUI**
To log in to the client device web GUI, and make necessary changes.

By right-clicking on the neighbor lite switch, this menu will appear and you can configure as shown below.

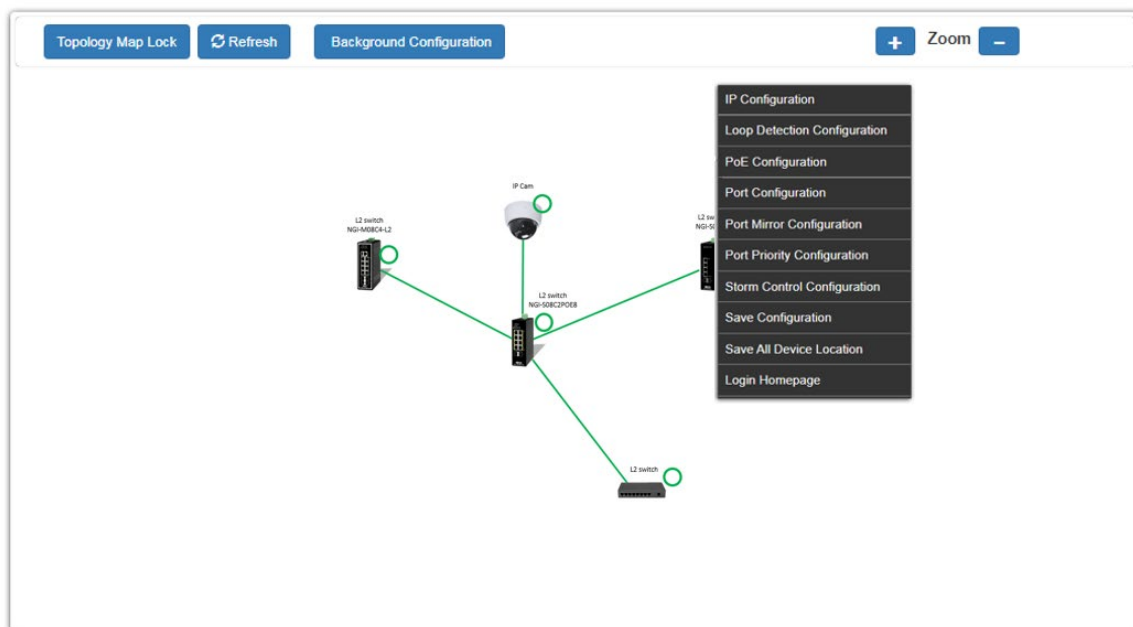

5.2. Neighbor Devices

5.2.1. LLDP

Introduction

The Link Layer Discovery Protocol (LLDP) specified in this standard allows stations attached to an IEEE 802 LAN to advertise, to other stations attached to the same IEEE 802 LAN, the major capabilities provided by the system incorporating that station, the management address or addresses of the entity or entities that provide management of those capabilities, and the identification of the station's point of attachment to the IEEE 802 LAN required by those management entity or entities.

The information distributed via this protocol is stored by its recipients in a standard Management Information Base (MIB), making it possible for the information to be accessed by a Network Management System (NMS) using a management protocol such as the Simple Network Management Protocol (SNMP).

Default Settings

The LLDP on the Switch is enabled.

Tx Interval : 30 seconds.

Tx Hold : 4 times.

Time To Live : 120 seconds.

5.2.1.1. CLI Configuration

Node	Command	Description
enable	show lldp	This command displays the LLDP configurations.
enable	show lldp neighbor	This command displays all of the ports' neighbor information.
configure	lldp (disable enable)	This command globally enables / disables the LLDP function on the Switch.
configure	lldp tx-interval	This command configures the interval to transmit the LLDP packets.
configure	lldp tx-hold	This command configures the tx-hold time which determines the TTL of the Switch's message. (TTL=tx-hold * tx-interval)
interface	lldp-agent (disable enable rx-only tx-only)	This command configures the LLDP agent function. disable – Disable the LLDP on the specific port. enable – Transmit and Receive the LLDP packet on the specific port. tx-only – Transmit the LLDP packet on the specific port only. rx-only – Receive the LLDP packet on the specific port.
configure	interface range gigabitethernet1/0/PORTLISTS	This command enters the interface configure node.

if-range	lldp-agent (disable enable rx-only tx-only)	This command configures the LLDP agent function. disable – Disable the LLDP on the specific port. enable – Transmit and Receive the LLDP packet on the specific port. tx-only – Transmit the LLDP packet on the specific port only. rx-only – Receive the LLDP packet on the specific port.
----------	--	---

5.2.1.2. Web configuration

Neighbor Devices

LLDP
Manual Registration
ONVIF

LLDP Settings

State Enable

Tx Interval seconds (Range: 1-3600)

Tx Hold times (Range: 2-100)

Time To Live 20 seconds

LLDP Neighbor Information

Local Port 2	
Remote Port ID	GigabitEthernet1/0/8
Chassis ID	00-06-87-01-22-a1
System Name	L2SWITCH
System Description	Tripp Lite Corporate./NGI-M08C4POE8-2/V1.0.0.S0/Mon May 10 10:46:40 CST 2021
System Capabilities	Bridge/Switch (enabled)
Management IP	IPv4: 192.168.202.155

Parameter	Description
LLDP Settings	
State	Globally enables / disables the LLDP on the Switch.
Apply	Click Apply to take effect the settings.
LLDP Neighbor Information	
Local Port	The local port ID.
Remote Port ID	The connected port ID.

Chassis ID	The neighbor's chassis ID.
System Name	The neighbor's system name.
System Description	The neighbor's system description.
System Capabilities	The neighbor's capability.
Management IP	The neighbor's management address.

5.2.2. Manual Registration

Introduction

If devices do not support LLDP and ONVIF, user has to enter the details of it by manually under manual registration. The function support four types, IP-Cam, PLC and Switch and PC.

5.2.2.1. CLI Configuration

Node	Command	Description
enable	show lamungan-device	This command displays the current manual registration configuration of lamungan device.
configure	lamungan-device type (ipcam plc switch pc)	This command is used to configure manual registration of lamungan device type like ((ipcam plc switch pc) .
configure	no lamungan-device mac	This command is delete configure of manual registration lamungan device using mac of ((ipcam plc switch pc) .
configure	lamungan-device background-type (picture color)	This command is used to configure manual registration of lamungan device background-type (picture color).

Example:

```
L2SWITCH(config)#lamungan-device type pc mac F8:28:19:5C:64:A3 ip 192.168.0.200
product-name maddy system-name PC
L2SWITCH#show lamungan-device
L2SWITCH(config)#lamungan-device background-type picture picture-value
ems_custom_bg.cfg color-value ffff
L2SWITCH(config)#lamungan-device background-type color picture-value custom.cfg
color-value ffff
```

5.2.2.2. Web Configuration

For devices which do not support ONVIF or LLDP, User can input the device's MAC address and then the Switch will discover the device and display it on the Lamungan Map.

Neighbor Devices

LLDP **Manual Registration** ONVIF

Manual Registration Settings

Type	MAC Address	IP	Product Name	System Name
IP-Cam ▼	<input type="text"/>	<input type="text"/>	<input type="text"/>	<input type="text"/>

Apply Refresh

Manual Registration Table

Type	MAC Address	IP	Product Name	System Name	Action
------	-------------	----	--------------	-------------	--------

Parameter	Description
Manual Registration Settings	
Type (ipcam plc switch pc)	User can select the type of the device for manual registration like (ipcam plc switch pc) connected as neighbor device to switch.
MAC Address	The MAC address of the device selected for manual registration.
IP	User can configure IP address of the manual registration device connected.
Product Name	User can configure name of the product selected for manual registration.
System Name	User can configure the system name for the manual registration.
Apply	Click Apply to take effect the settings.
Refresh	Click Refresh to begin configuring this screen afresh.
Manual Registration Table	
Type	The kind of devices connected to switch.
MAC Address	Display The MAC address of the configured device.
IP	Display the IP address of the configured device.
Product Name	Display the name of the product configured.
System Name	Display the system name assigned manually.

Action	Whether to delete entered device or not.
--------	--

5.2.3. ONVIF

ONVIF is an open industry forum that provides and promotes standardized interfaces for effective interoperability of IP-based physical security products.

The Switch uses ONVIF to discover if there is an ONVIF device connected to the Switch.

ONVIF settings and ONVIF Neighbor

The page shows detailed information about ONVIF settings and ONVIF devices connected to the Switch. The Switch displays ONVIF devices up to total port count, NGI-S04C2 shows upto 10 ONVIF devices connected to it. If one or more ONVIF devices are connected to the same port it displays the last ONVIF device gets connect to it.

5.2.3.1. CLI Configuration

Node	Command	Description
enable	show onvif neighbors	This command displays the onvif neighbor discovery.
configure	onvif enable	This command is used to enable onvif service on device .
configure	onvif disable	This command is used to disable onvif service on device .
configure	onvif binding-ports	This command is used to configure onvif binding ports .
configure	no onvif binding-ports	This command is used to delete onvif binding ports .
configure	onvif tx-interval <6-3600> Unit: second. (Default: 6)	This command is used to configure onvif tx-interval discovery time from the range of 6-3600 seconds default time is 6 seconds.
configure	no onvif tx-interval	This command is used to delete onvif tx-interval discovery time from the range of 6-3600 seconds default time is 6 seconds.

5.2.3.2. Web Configuration

Neighbor Devices

LLDP Manual Registration **ONVIF**

ONVIF Settings

State: ▼

Tx Interval: seconds (Range: 6-3600)

ONVIF Neighbors

Parameter	Description
ONVIF Settings	
State	Select option to enable / disable the ONVIF feature on the Switch.
Tx Interval	Configures the sending ONVIF discovery packet interval. Valid range is 6 ~ 3600 seconds.
Apply	Click Apply to take effect the settings.
Refresh	Click Refresh to begin configuring this screen afresh.
ONVIF Neighbor Information	
Port	The connected port of the ONVIF device.
IP Address	The IP address of the ONVIF device.
MAC Address	The MAC address on the ONVIF device.
VLAN ID	The VLAN ID of the ONVIF device join.
Product Name	Name of the product added.
Product Type	What kind of product that is added.
Model	Model of the product.
Location	Location where it is placed.
Web Service Address	Address of the web service of that camera.

5.3. Topology Map

The Topology Map is a feature to check neighbor devices' information or to configure them easily. Click the Topology Map, the system will display topology as below.

All devices connect to the Switch directly and support LLDP will be displayed on the screen. If the neighbor device is a Switch which supports Lamungan server function, click the right key of the mouse. The menu will be displayed on the screen. And then you can click an item which you want to configure the Switch.

Note: The topology map can be viewed only on Google or Firefox browsers.

Web Configuration of Topology MAP

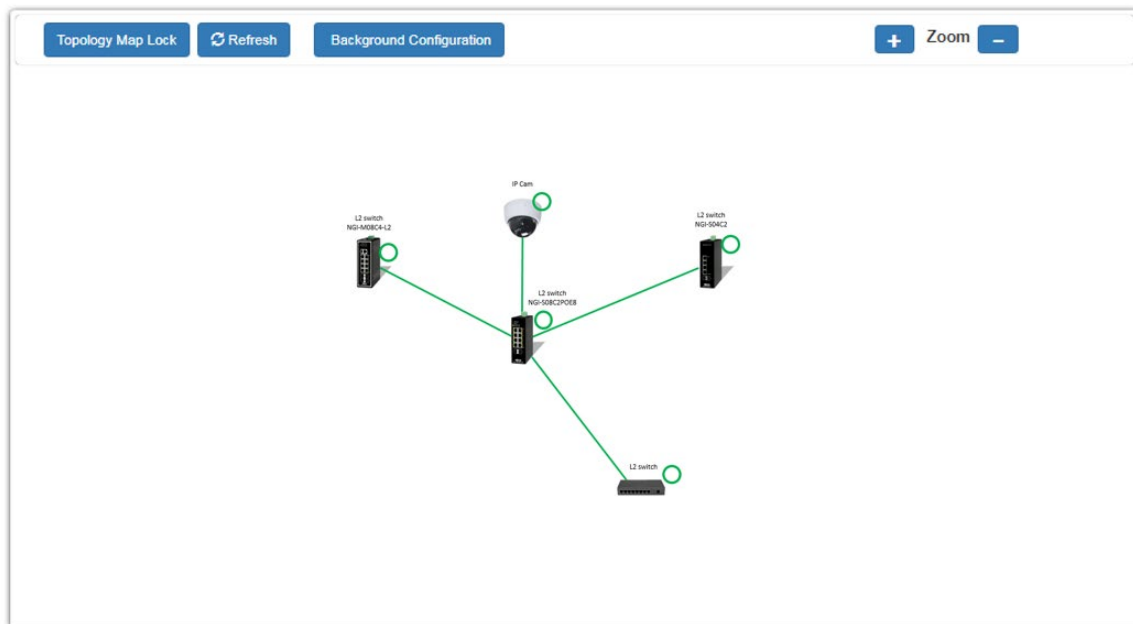

When you click the “Topology Map Lock”, the screen will appear as shown. The green circle on the devices indicates they are working normally.

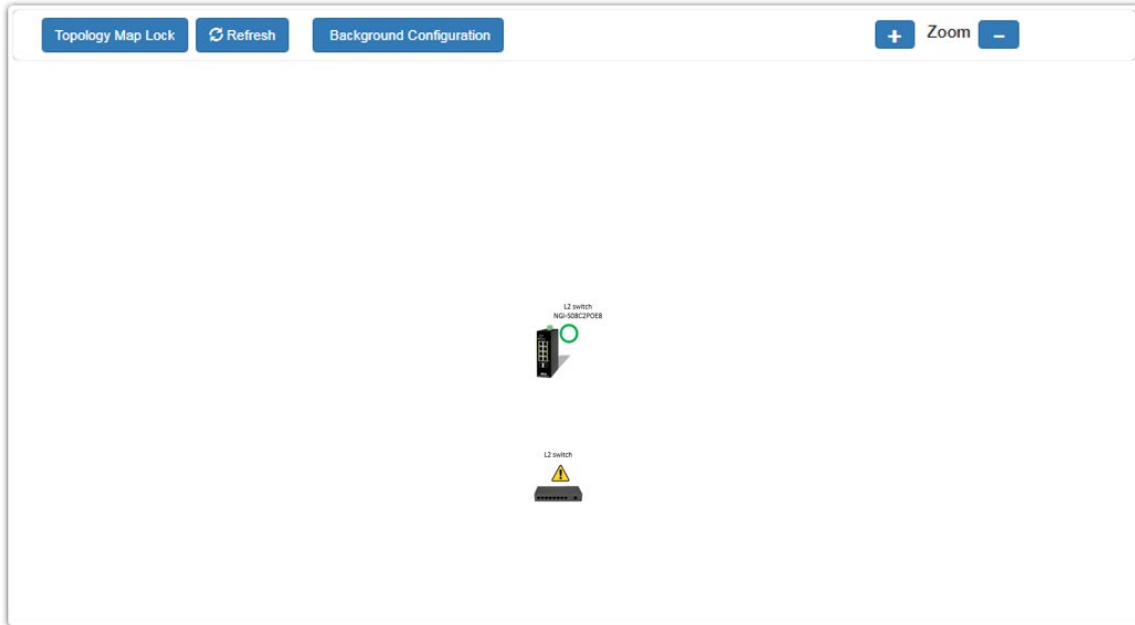

You can view the basic details of the devices connected to the host by placing the cursor on it.

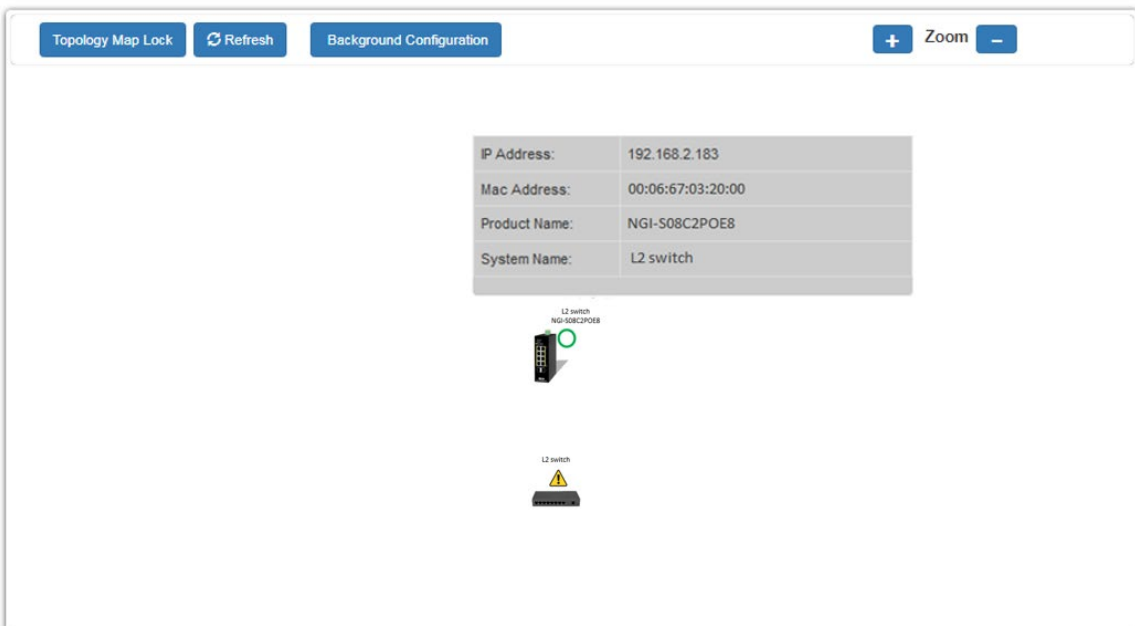

When there is something wrong with the device, the screen will appear as shown so that you can find the details of events that have gone wrong and correct them.

5.3.1. Client Switch Management

By right-clicking on the neighbor non-lite Switch, this menu will appear and you can configure as shown.

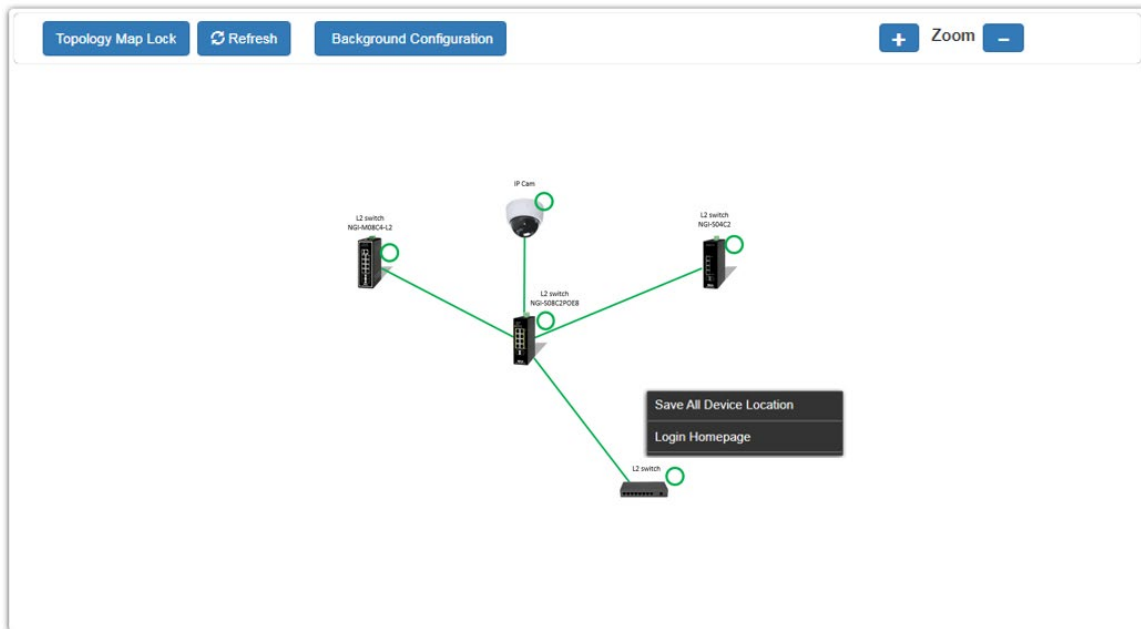

Non-Lite Switch Menu:

- **Save All Device Locations**
To fix the location of all devices on the map, so that it restores its places after refresh.
- **Login Web GUI**
To log in to the client device web GUI and make necessary changes.

By right-clicking on the neighbor lite switch, this menu will appear and you can configure as shown.

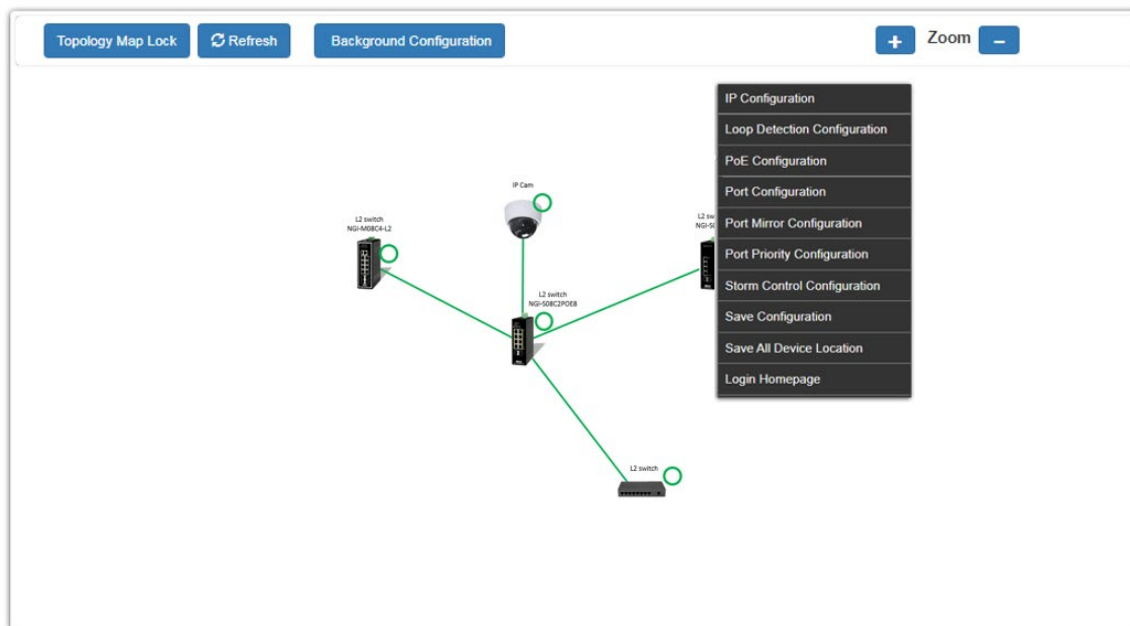

5.3.2. Quick Configuration Menu

By right-clicking on the neighbor lite management switch, this menu will appear and you can configure as shown.

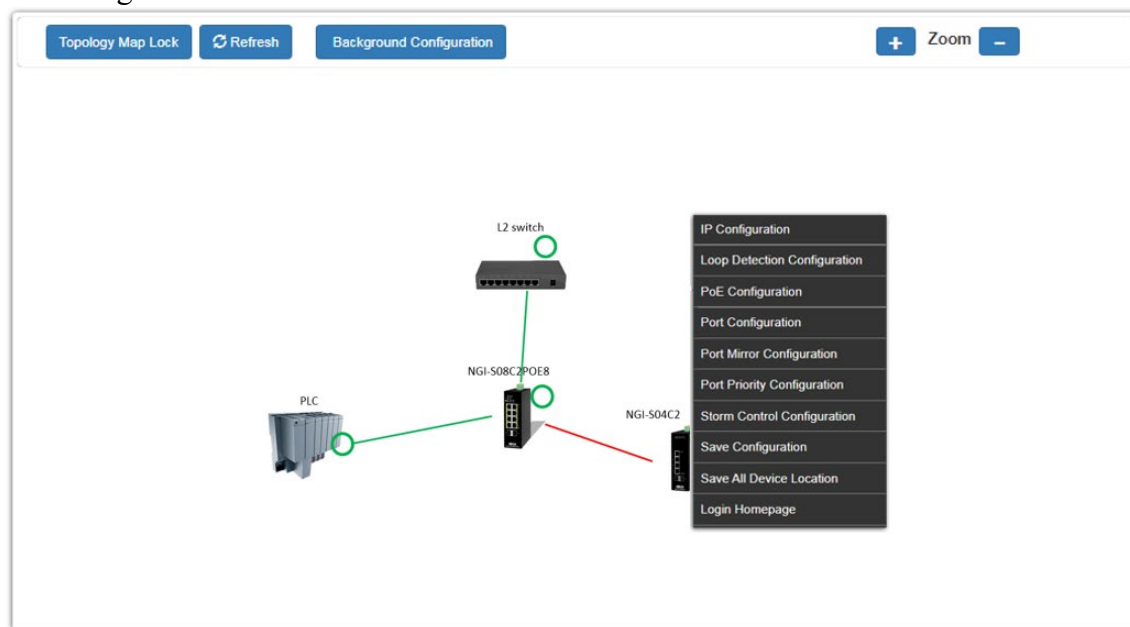

By right-clicking on the neighbor switch (only lite management switches), this menu will appear and you can configure as shown.

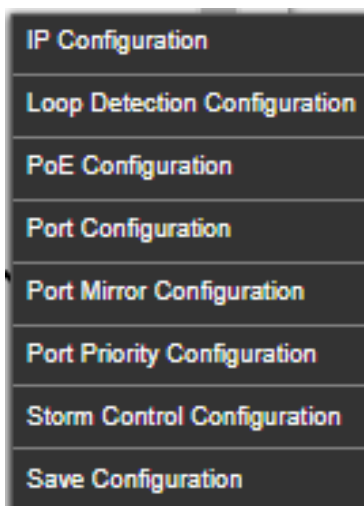

5.3.2.1. IP Configuration

IP configuration

IPv4 Settings

DHCP Client Disable ▾ Renew

IP Address 192.168.202.151

Subnet Mask 255.255.255.0

Default Gateway 192.168.202.1

Apply Refresh

Parameter	Description
IPv4 Settings	
DHCP Client	Configures the DHCP client function for your Switch. Enable means the Switch get an IP address from a DHCP server.
IP Address	Configures a static IPv4 address for your Switch in dotted decimal notation. For example, 192.168.0.254.
Subnet Mask	Configures a IP subnet mask of your Switch in dotted decimal notation for example 255.255.255.0.
Default Gateway	Configures an IP address of the default outgoing gateway in dotted decimal notation, for example 192.168.1.1.
Apply	Click Apply to take effect the settings.
Refresh	Click Refresh to begin configuring this screen afresh.

5.3.2.2. Loop Detection Configuration

Loop Detection

Loop Detection Settings

State Disable ▾

Port	State
From: 1 ▾ To: 1 ▾	Disable ▾

Loop Detection Status

Port	State	Status	Port	State	Status
1	Disabled	Normal	2	Disabled	Normal
3	Disabled	Normal	4	Disabled	Normal
5	Disabled	Normal	6	Disabled	Normal

Parameter	Description
Loop Detection Settings	
State	Select this option to enable / disable loop detection on the Switch.
Port	Select a port or a range of ports which to configure loop detection.
State	Select option to enable/disable the loop detection feature on port(s).
Apply	Click Apply to take effect the settings.
Refresh	Click Refresh to begin configuring this screen afresh.
Loop Detection Status	
Port	This field displays a port number.
State	This field displays if the loop detection feature is enabled.
Status	This field displays if the port is blocked by loop detection.

5.3.2.3. Port Configuration

Port Settings

Port Settings

Port	State
From: <input type="text" value="1"/> To: <input type="text" value="1"/>	<input type="text" value="Enable"/>

Port Status

Port	State	Link Status	Port	State	Link Status
1	Enabled	Link Up	2	Enabled	Link Down
3	Enabled	Link Down	4	Enabled	Link Down
5	Enabled	Link Down	6	Enabled	Link Down

Parameter	Description
Port Settings	
Port	Selects a port or a range of ports on which to configure the port.
State	Select option to enable / disable the port.
Apply	Click Apply to take effect the settings.
Refresh	Click Refresh to begin configuring this screen afresh.
Port Status	
Port	This field displays the index number of a port.
Stata	This field displays the state of a port.
Link Status	This field displays the link status of a port.

5.3.2.4. Port Mirror Configuration

Port Mirroring

Port Mirroring Settings

State: Disable ▾

Source Port: ▾ Destination Port: 1 ▾

Parameter	Description
Port Mirror Settings	
State	Select option to enable / disable the port mirroring feature on the Switch.
Source Port	Selects a port which packets received and transmitted by this port will be copied to the destination port.
Destination Port	Select a port which connects to a network traffic analyzer.
Apply	Click Apply to take effect the settings.
Refresh	Click Refresh to begin configuring this screen afresh.

5.3.2.5. Port Priority Configuration

Port Priority

Port Priority Settings

Port	802.1p priority
From: 1 ▾ To: 1 ▾	Low ▾

Port Priority Status

Port	802.1p priority	Port	802.1p priority
1	Low	2	Low
3	Low	4	Low
5	Low	6	Low

Parameter	Description
Port Priority Settings	
Port	Selects a port or a range of ports on which to configure the priority.
Priority	Selects “Low”, “Medium” and “High” priority for the port(s).
Apply	Click Apply to take effect the settings.
Refresh	Click Refresh to begin configuring this screen afresh.
Port Priority Status	
Port	This field displays a port number.
Priority	This field displays the priority for a port.

5.3.2.6. Storm Control Configuration

Storm Control

Storm Control Settings

Port	Type
From: 1 ▾ To: 1 ▾	<input type="checkbox"/> Multicast <input type="checkbox"/> Broadcast <input type="checkbox"/> DLF

Storm Control Status

Port	Multicast	Broadcast	DLF	Port	Multicast	Broadcast	DLF
1	Disable	Enable	Enable	2	Disable	Enable	Enable
3	Disable	Enable	Enable	4	Disable	Enable	Enable
5	Disable	Enable	Enable	6	Disable	Enable	Enable

Parameter	Description
Storm Control Settings	
Port	Select the port number for which you want to configure storm control settings.
Type	Click the check box to enable / disable the Multicast / Broadcast / DLF storm control.
Apply	Click Apply to take effect the settings.

Refresh	Click Refresh to begin configuring this screen afresh.
Storm Control Status	
Port	This field displays a port number.
Multicast	This field displays the multicast storm control state on the port.
Broadcast	This field displays the broadcast storm control state on the port.
DLF	This field displays the DLF storm control state on the port.

5.3.2.7. Save Configuration

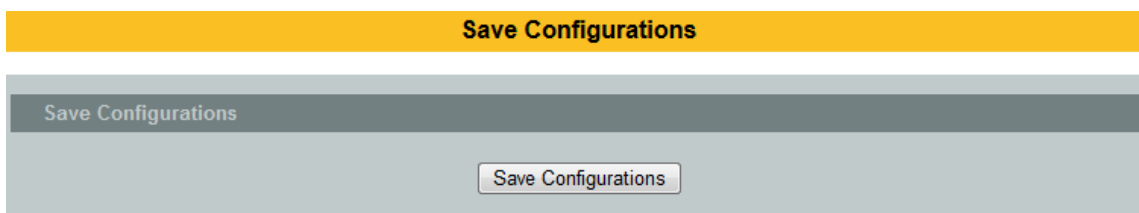

Parameter	Description
Save Configuration	
Save Configuration	Click Save Configuration to save the current running configuration to the NVRAM.

5.3.2.8. Save All Device Locations

Fixes the locations of all devices on the topology map so that it restores its places after refresh.

5.3.2.9. Save All Device Location

Fixes the location of all devices on the topology map so that it restores its places after refresh.

5.3.2.10. Login Homepage

To log in to the client device web GUI and make necessary changes

6. Security

6.1. 802.1x

IEEE 802.1X is an IEEE Standard for port-based Network Access Control ("port" meaning a single point of attachment to the LAN infrastructure). It is part of the IEEE 802.1 group of networking protocols. It provides an authentication mechanism to devices wishing to attach to a LAN, either establishing a point-to-point connection or preventing it if authentication fails. It is used for most wireless 802.11 access points and is based on the Extensible Authentication Protocol (EAP).

802.1X provides port-based authentication, which involves communications between a supplicant, authenticator, and authentication server. The supplicant is often software on a client device, such as a laptop, the authenticator is a wired Ethernet switch or wireless access point, and an authentication server is generally a RADIUS database. The authenticator acts like a security guard to a protected network. The supplicant (i.e., client device) is not allowed access through the authenticator to the protected side of the network until the supplicant's identity is authorized. An analogy to this is providing a valid passport at an airport before being allowed to pass through security to the terminal. With 802.1X port-based authentication, the supplicant provides credentials, such as user name/password or digital certificate, to the authenticator, and the authenticator forwards the credentials to the authentication server for verification. If the credentials are valid (in the authentication server database), the supplicant (client device) is allowed to access resources located on the protected side of the network.

Upon detection of the new client (supplicant), the port on the switch (authenticator) is enabled and set to the "**unauthorized**" state. In this state, only 802.1X traffic is allowed; other traffic, such as DHCP and HTTP, is blocked at the network layer (Layer 3). The authenticator sends out the EAP-Request identity to the supplicant, the supplicant responds with the EAP-response packet that the authenticator forwards to the authenticating server. If the authenticating server accepts the request, the authenticator sets the port to the "authorized" mode and normal traffic is allowed. When the supplicant logs off, it sends an EAP-logoff message to the authenticator. The authenticator then sets the port to the "unauthorized" state, once again blocking all non-EAP traffic.

The following figure illustrates how a client connecting to an IEEE 802.1x authentication enabled port goes through a validation process. The Switch prompts the client for login information in the form of a user name and password.

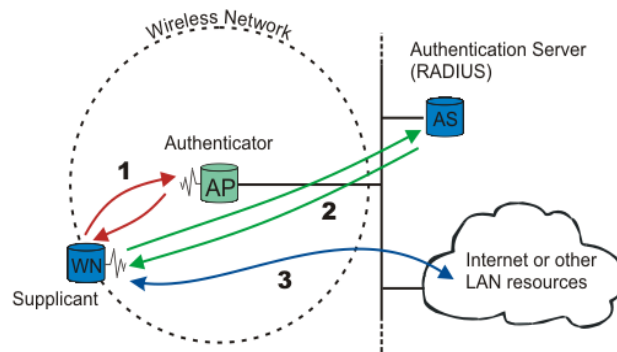

When the client provides the login credentials, the Switch sends an authentication request to a RADIUS server. The RADIUS server validates whether this client is allowed access to the port.

Local User Accounts

By storing user profiles locally on the Switch, your Switch is able to authenticate users without interacting with a network authentication server. However, there is a limit on the number of users you may authenticate in this way.

Guest VLAN:

The Guest VLAN in IEEE 802.1x port authentication on the switch to provide limited services to clients, such as downloading the IEEE 802.1x client. These clients might be upgrading their system for IEEE 802.1x authentication.

When you enable a guest VLAN on an IEEE 802.1x port, the switch assigns clients to a guest VLAN when the switch does not receive a response to its EAP request/identity frame or when EAPOL packets are not sent by the client.

Port Parameters:

- **Admin Control Direction:**

- both - drop incoming and outgoing packets on the port when a user has not passed 802.1x port authentication.
- in - drop only incoming packets on the port when a user has not passed 802.1x port authentication.

- **Re-authentication:**

Specify if a subscriber has to periodically re-enter his or her user name and password to stay connected to the port.

- **Reauth-period:**

Specify how often a client has to re-enter his or her username and password to stay connected to the port. The acceptable range for this field is 0 to 65535 seconds.

- **Port Control Mode:**

- Auto : Users can access network after authenticating.
- Force-authorized : Users can access network without authentication.
- Force-unauthorized : Users cannot access network.

- **Quiet Period:**
Specify a period of the time the client has to wait before the next re-authentication attempt. This will prevent the Switch from becoming overloaded with continuous re-authentication attempts from the client. The acceptable range for this field is 0 to 65535 seconds.
- **Server Timeout:**
The server-timeout value is used for timing out the Authentication Server.
- **Supp-Timeout:**
The supp-timeout value is the initialization value used for timing out a Supplicant.
- **Max-req Time:**
Specify the amount of times the Switch will try to connect to the authentication server before determining the server is down. The acceptable range for this field is 1 to 10 times.

6.1.1. CLI Configuration

Node	Command	Description
enable	show dot1x	This command displays the current 802.1x configurations.
enable	show dot1x username	This command displays the current user accounts for the local authentication.
enable	show dot1x accounting-record	This command displays the local accounting records.
configure	dot1x authentication (disable enable)	This command enables/disables the 802.1x authentication on the switch.
configure	dot1x authentic-method (local radius)	This command configures the authentic method of 802.1x.
configure	no dot1x authentic-method	This command configures the authentic method of 802.1x to default.
configure	dot1x radius primary-server-ip <IP> port PORTID	This command configures the primary radius server.
configure	dot1x radius primary-server-ip <IP> port PORTID key KEY	This command configures the primary radius server.
configure	dot1x radius secondary-server-ip <IP> port PORTID	This command configures the secondary radius server.
configure	dot1x radius secondary-server-ip <IP> port PORTID key KEY	This command configures the secondary radius server.
configure	no dot1x radius secondary-server-ip	This command removes the secondary radius server.

configure	dot1x username <STRING> passwd <STRING>	This command configures the user account for local authentication.
configure	no dot1x username <STRING>	This command deletes the user account for local authentication.
configure	dot1x accounting (disable enable)	This command enables/disables the dot1x local accounting records.
configure	dot1x guest-vlan VLANID	This command configures the guest vlan.
configure	no dot1x guest-vlan	This command removes the guest vlan.
interface	dot1x admin-control-direction (both in)	This command configures the control direction for blocking packets.
interface	dot1x default	This command sets the port configuration to default settings.
interface	dot1x max-req <1-10>	This command sets the max-req times of a port. (1~10).
interface	dot1x port-control (auto force-authorized force-unauthorized)	This command configures the port control mode on the port.
interface	dot1x authentication (disable enable)	This command enables/disables the 802.1x on the port.
interface	dot1x reauthentication (disable enable)	This command enables/disables re-authentication on the port.
interface	dot1x timeout quiet-period	This command configures the quiet-period value on the port.
interface	dot1x timeout server-timeout	This command configures the server-timeout value on the port.
interface	dot1x timeout reauth-period	This command configures the re-auth-period value on the port.
interface	dot1x timeout supp-timeout	This command configures the supp-timeout value on the port.
interface	dot1x guest-vlan (disable enable)	This command configures the 802.1x state on the port.

6.1.2. Web Configuration

802.1X			
Configuration		Port Settings	
Global Settings			
State	Disable ▾		
Authentication Method	Local ▾		
Guest VLAN	0		
Primary Radius Server	IP : <input type="text"/>	UDP Port : <input type="text"/>	Shared Key : <input type="text"/>
Secondary Radius Server	IP : <input type="text"/>	UDP Port : <input type="text"/>	Shared Key : <input type="text"/>
<input type="button" value="Apply"/> <input type="button" value="Refresh"/>			
Global Status			
State	Disabled		
Authentication Method	Local		
Guest VLAN	0		
Primary Radius Server	IP : -	UDP Port : -	Shared Key : -
Secondary Radius Server	IP : -	UDP Port : -	Shared Key : -

Parameter	Description
State	Select Enable to permit 802.1 x authentications on the Switch. Note: You must first enable 802.1 x authentications on the Switch before configuring it on each port.
Authentication Method	Select whether to use Local or RADIUS as the authentication method. The Local method of authentication uses the “guest” and “user” user groups of the user account database on the Switch itself to authenticate. However, only a certain number of accounts can exist at one time. RADIUS is a security protocol used to authenticate users by means of an external server instead of an internal device user database that is limited to the memory capacity of the device. In essence, RADIUS allows you to validate an unlimited number of users from a central location.
Guest VLAN	Configure the guest vlan.
Primary Radius Server	When RADIUS is selected as the 802.1x authentication method, the Primary Radius Server will be used for all authentication attempts.
IP Address	Enter the IP address of an external RADIUS server in dotted

	decimal notation.
UDP Port	The default port of a RADIUS server for authentication is 1812 .
Share Key	Specify a password (up to 32 alphanumeric characters) as the key to be shared between the external RADIUS server and the Switch. This key is not sent over the network. This key must be the same on the external RADIUS server and the Switch.
Second Radius Server	This is the backup server used only when the Primary Radius Server is down.
Global Status	
State	This field displays if 802.1x authentication is Enabled or Disabled .
Authentication Method	This field displays if the authentication method is Local or RADIUS .
Guest VLAN	The field displays the guest vlan.
Primary Radius Server	This field displays the IP address, UDP port and shared key for the Primary Radius Server . This will be blank if nothing has been set.
Secondary Radius Server	This is the backup server used only when the Primary Radius Server is down.
Apply	Click Apply to add/modify the settings.
Refresh	Click Refresh to begin configuring this screen afresh.

6.1.3. Web Configuration

802.1X

Configuration
Port Settings

Port Settings

Port: From: 1 To: 1

802.1X State: Disable

Admin Control Direction	Reauthentication	Port Control Mode	Guest VLAN	Max-req Times
Both	Disable	Auto	Disable	2
Reauth-period (sec)	Quiet-period (sec)	Supp-timeout (sec)	Server-timeout (sec)	Reset to Default
3600	20	30	16	<input type="checkbox"/>

Note : Please don't set ENABLE on all ports at the same time.

Apply
Refresh

Port Status

Port	802.1X State	Admin Control Direction	Reauthentication	Port Control Mode	Guest VLAN	Max-req Times	Reauth-period	Quiet-period	Supp-timeout	Server-timeout
1	Disabled	Both	Disabled	Auto	Disabled	2	3600	20	30	16
2	Disabled	Both	Disabled	Auto	Disabled	2	3600	20	30	16
3	Disabled	Both	Disabled	Auto	Disabled	2	3600	20	30	16
4	Disabled	Both	Disabled	Auto	Disabled	2	3600	20	30	16
5	Disabled	Both	Disabled	Auto	Disabled	2	3600	20	30	16
6	Disabled	Both	Disabled	Auto	Disabled	2	3600	20	30	16

Parameter	Description
Port	Select a port number to configure.
802.1x State	Select Enable to permit 802.1 x authentications on the port. You must first enable 802.1 x authentications on the Switch before configuring it on each port.
Admin Control Direction	Select Both to drop incoming and outgoing packets on the port when a user has not passed 802.1x port authentication. Select In to drop only incoming packets on the port when a user has not passed 802.1x port authentication.
Re-authentication	Specify if a subscriber has to periodically re-enter his or her user name and password to stay connected to the port.
Port Control Mode	Select Auto to require authentication on the port. Select Force Authorized to always force this port to be authorized. Select Force Unauthorized to always force this port to be unauthorized. No packets can pass through this port.
Guest VLAN	Select Disable to disable Guest VLAN on the port. Select Enable to enable Guest VLAN on the port.

Max-req Time	Specify the amount of times the Switch will try to connect to the authentication server before determining the server is down. The acceptable range for this field is 1 to 10 times.
Reauth period	Specify how often a client has to re-enter his or her username and password to stay connected to the port. The acceptable range for this field is 0 to 65535 seconds.
Quiet period	Specify a period of the time the client has to wait before the next re-authentication attempt. This will prevent the Switch from becoming overloaded with continuous re-authentication attempts from the client. The acceptable range for this field is 0 to 65535 seconds.
Supp timeout	Specify how long the Switch will wait before communicating with the server. The acceptable range for this field is 0 to 65535 seconds.
Server timeout	Specify how long the Switch to time out the Authentication Server. The acceptable range for this field is 0 to 65535 seconds.
Reset to Default	Select this and click Apply to reset the custom 802.1x port authentication settings back to default.
Apply	Click Apply to add/modify the settings.
Refresh	Click Refresh to begin configuring this screen afresh.
Port Status	
Port	This field displays the port number.
802.1x State	This field displays if 802.1 x authentications is Enabled or Disabled on the port.
Admin Control Direction	This field displays the Admin Control Direction. Both will drop incoming and outgoing packets on the port when a user has not passed 802.1x port authentication. In will drop only incoming packets on the port when a user has not passed 802.1x port authentication.
Re-authentication	This field displays if the subscriber must periodically re-enter his or her username and password to stay connected to the port.
Port Control Mode	This field displays the port control mode. Auto requires authentication on the port. Force Authorized forces the port to be authorized. Force Unauthorized forces the port to be unauthorized. No packets can Pass through the port.
Guest VLAN	This field displays the Guest VLAN setting for hosts that have not passed authentication.
Max-req Time	This field displays the amount of times the Switch will try to connect to the authentication server before determining the server is down.

Reauth period	This field displays how often a client has to re-enter his or her username and password to stay connected to the port.
Quiet period	This field displays the period of the time the client has to wait before the next re-authentication attempt.
Supp timeout	This field displays how long the Switch will wait before communicating with the server.
Server timeout	This field displays how long the Switch will wait before communicating with the client.

6.2. ACL

L2 Access control list (ACL) is a list of permissions attached to an object. The list specifies who or what is allowed to access the object and what operations are allowed to be performed on the object.

L2 ACL function allows user to configure a few rules to reject packets from the specific ingress ports or all ports. These rules will check the packets' source MAC address and destination MAC address. If packets match these rules, the system will do the actions "deny". "deny" means rejecting these packets.

The Action Resolution engine collects the information (action and metering results) from the hit entries: if more than one rule matches, the actions and meter/counters are taken from the policy associated with the matched rule with highest priority.

Default Settings

Maximum profile : 64.

Maximum profile name length : 16.

Notice:

The ACL name should be the combination of the digit or the alphabet.

6.2.1. CLI Configuration

Node	Command	Description
enable	show access-list	This command displays all of the access control profiles.
configure	no access-list STRING	This command deletes an access control profile.
acl	show	This command displays the current access control profile.
acl	action (disable drop permit)	This command activates this profile. disable – disable the profile. drop – If packets match the profile, the packets will be dropped. permit – If packets match the profile, the packets will be forwarded.
acl	action dscp remarking <0-63>	This command activates this profile and specifies that it is for DSCP remark. And configures the new

		DSCP value which will be override to all packets matched this profile.
acl	action 802.1p remarking <0-7>	This command actives this profile and specify that it is for 802.1p remark. And configures the new 802.1p value which will be override to all packets matched this profile.
acl	802.1p VALUE	This command configures the 802.1p value for the profile.
acl	dscp VALUE	This command configures the DSCP value for the profile.
acl	destination mac host MACADDR	This command configures the destination MAC and mask for the profile.
acl	destination mac MACADDR MACADDR	This command configures the destination MAC and mask for the profile.
acl	destination mac MACADDR MACADDR	This command configures the destination MAC and mask for the profile. The second MACADDR parameter is the mask for the profile.
acl	no destination mac	This command removes the destination MAC from the profile.
acl	ethertype STRING	This command configures the ether type for the profile. Where the STRING is a hex-decimal value. e.g.: 08AA.
acl	no ethertype	This command removes the limitation of the ether type from the profile.
acl	source mac host MACADDR	This command configures the source MAC and mask for the profile.
acl	source mac MACADDR MACADDR	This command configures the source AMC and mask for the profile.
acl	no source mac	This command removes the source MAC and mask from the profile.
acl	source ip host IPADDR	This command configures the source IP address for the profile.
acl	source ip IPADDR IPMASK	This command configures the source IP address and mask for the profile.
acl	no source ip	This command removes the source IP address from the profile.
acl	destination ip host IPADDR	This command configures a specific destination IP address for the profile.
acl	destination ip IPADDR IPMASK	This command configures the destination IP address and mask for the profile.
acl	no destination ip	This command removes the destination IP address from the profile.
acl	l4-source-port IPADDR	This command configures UDP/TCP source port for the profile.

acl	no l4-source-port IPADDR	This command removes the UDP/TCP source port from the profile.
acl	L4-destination-port PORT	This command configures the UDP/TCP destination port for the profile.
acl	no l4-destination-port	This command removes the UDP/TCP destination port from the profile.
acl	vlan VLANID	This command configures the VLAN for the profile.
acl	no vlan	This command removes the limitation of the VLAN from the profile.
acl	source interface PORT_ID	This command configures the source interface for the profile.
acl	no source interface PORT_ID	This command removes the source interface from the profile.

Where the MAC mask allows users to filter a range of MAC in the packets' source MAC or destination MAC.

For Example:

source mac 00:01:02:03:04:05 ff:ff:ff:ff:00

The command will filter source MAC range from 00:01:02:03:00:00 to 00:01:02:03:ff:ff

Where the IPMASK mask allows users to filter a range of IP in the packets' source IP or destination IP.

For Example:

source ip 172.20.1.1 255.255.0.0

The command will filter source IP range from 172.20.0.0 to 172.20.255.255

Example:

```
L2SWITCH#configure terminal
L2SWITCH(config)#access-list 111
L2SWITCH(config-acl)#vlan 2
L2SWITCH(config-acl)#source interface 1
L2SWITCH(config-acl)#show
Profile Name: 111
Activate: disabled
VLAN: 2
Source Interface: 1
Destination MAC Address: any
Source MAC Address: any
Ethernet Type: any
Source IP Address: any
Destination IP Address: any
Source Application: any
Destination Application: any
```

Note: Any: Don't care.

6.2.2. Web Configuration

Access Control List

Access Control List Settings

Profile Name	<input type="text"/>	Action	<input type="text" value="Disable"/>
Ethernet Type	<input type="text" value="Any"/>	VLAN	<input type="text" value="Any"/>
Source MAC	<input type="text" value="Any"/>	Mask of Source MAC	<input type="text"/>
Destination MAC	<input type="text" value="Any"/>	Mask of Destination MAC	<input type="text"/>
Source IP	<input type="text" value="Any"/>	Mask of Source IP	<input type="text"/>
Destination IP	<input type="text" value="Any"/>	Mask of Destination IP	<input type="text"/>
Source Application	<input type="text" value="Any"/>		
Destination Application	<input type="text" value="Any"/>		
Source Interface	<input type="text" value="Any"/> <input type="text" value="--"/>		

Access Control List Status

Parameter	Description
Profile Name	The access control profile name.
State	Selects Disables / Drop / Permits/ DSCP action for the profile.
Ethernet Type	Configures the Ethernet type of the packets that you want to filter.
VLAN	Configures the VLAN of the packets that you want to filter.
Source MAC	Configures the source MAC of the packets that you want to filter.
Mask of Source MAC	Configures the bitmap mask of the source MAC of the packets that you want to filter. If the Source MAC field has been configured and this field is empty, it means the profile will filter the one MAC configured in Source MAC field.
Destination MAC	Configures the destination MAC of the packets that you want to filter.
Mask of Destination MAC	Configures the bitmap mask of the destination MAC of the packets that you want to filter. If the Destination MAC field has been configured and this field is empty, it means the profile will filter the one MAC configured in Destination MAC field.
Source IP	Configures the source IP of the packets that you want to filter.

Mask of Source IP	Configures the bitmap mask of the source IP of the packets that you want to filter. If the Source IP field has been configured and this field is empty, it means the profile will filter the one IP configured in Source IP field.
Destination IP	Configures the destination IP of the packets that you want to filter.
Mask of Destination IP	Configures the bitmap mask of the destination IP of the packets that you want to filter. If the Destination IP field has been configured and this field is empty, it means the profile will filter the one IP configured in Destination IP field.
Source Application	Configures the source UDP/TCP ports of the packets that you want to filter.
Destination Application	Configures the destination UDP/TCP ports of the packets that you want to filter.
Source Interface(s)	Configures one or a range of the source interfaces of the packets that you want to filter.
Apply	Click Apply to add/modify the settings.
Refresh	Click Refresh to begin configuring this screen afresh.

6.3. Port Security

The Switch will learn the MAC address of the device directly connected to a particular port and allow traffic through. We will ask the question: “How do we control who and how many can connect to a switch port?” This is where port security can assist us. The Switch allow us to control which devices can connect to a switch port or how many of them can connect to it (such as when a hub or another switch is connected to the port).

Let’s say we have only one switch port left free and we need to connect five hosts to it. What can we do? Connect a hub or switch to the free port! Connecting a switch or a hub to a port has implications. It means that the network will have more traffic. If a switch or a hub is connected by a user instead of an administrator, then there are chances that loops will be created. So, it is best that number of hosts allowed to connect is restricted at the switch level. This can be done using the “port-security limit” command. This command configures the maximum number of MAC addresses that can source traffic through a port.

Port security can sets maximum number of MAC addresses allowed per interface. When the limit is exceeded, incoming packets with new MAC addresses are dropped. It can be use MAC table to check it. The static MAC addresses are included for the limit.

Note: If you configure a port of the Switch from disabled to enabled, all of the MAC learned by this port will be clear.

Default Settings

The port security on the Switch is disabled.
 The Maximum MAC per port is 5.
 The port state of the port security is disabled.

6.3.1. CLI Configuration

Node	Command	Description
enable	show port-security	This command displays the current port security configurations.
configure	port-security (disable enable)	This command enables / disables the global port security function.
interface	port-security (disable enable)	This command enables / disables the port security function on the specific port.
interface	port-security limit VALUE	This command configures the maximum MAC entries on the specific port.
configure	interface range gigabitethernet1/0/ PORTLISTS	This command enters the interface configure node.
if-range	port-security (disable enable)	This command enables / disables the port security function for the specified ports
if-range	port-security limit VALUE	This command configures the maximum MAC entries for the specified ports.

6.3.2. Web Configuration

Port Security

Port Security Settings

Port Security Disable ▾

Port	State	Maximum MAC
From: <input type="text" value="1"/> ▾ To: <input type="text" value="1"/> ▾	Disable ▾	<input type="text" value="5"/> (1~1000)

Port Security Status

Port	State	Maximum MAC	Port	State	Maximum MAC
1	Disable	5	2	Disable	5
3	Disable	5	4	Disable	5
5	Disable	5	6	Disable	5

Parameter	Description
Port Security Settings	
Port Security	Select Enable/Disable to permit Port Security on the Switch.
Port	Select a port number to configure.
State	Select Enable/Disable to permit Port Security on the port.
Maximum MAC	The maximum number of MAC addresses allowed per interface. The acceptable range is 1 to 1000.
Port Security Status	
Port	This field displays a port number.
State	This field displays if Port Security is Enabled or Disabled
Maximum MAC	This field displays the maximum number of MAC addresses

6.4. Server Control

Introduction

The function allows users to enable or disable the HTTP, HTTPS, SNMPv1/v2c, SNMPv3, SSH and Telnet service individually.

6.4.1. CLI Configuration

Node	Command	Description
enable	show server status	This command displays the current server status.
configure	ssh server	This command enables the ssh on the Switch.
configure	no ssh server	This command disables the ssh on the Switch.
configure	telnet server	This command enables the telnet on the Switch.
configure	no telnet server	This command disables the telnet on the Switch.
configure	SNMPv1/v2c	This command enables the SNMPv1/v2c on the Switch.
configure	SNMPv1/v2c	This command disables the SNMPv1/v2c on the Switch.
configure	SNMPv3	This command enables the SNMPv3 on the Switch
configure	SNMPv3	This command disables the SNMPv3 on the Switch.
configure	web server	This command enables the web on the Switch.
configure	no web server	This command disables the web on the Switch.

6.4.2. Web Configuration

Server Control

Server Control Settings

HTTP Server State	Enable ▾	HTTP Server TCP Port	80 <small>(80, 1025~9999)</small>
HTTPS Server State	Enable ▾		
SNMP v1/v2c Server State	Enable ▾		
SNMP v3 Server State	Enable ▾		
SSH Server State	Enable ▾		
TELNET Server State	Enable ▾	TELNET Server TCP Port	23 <small>(23, 1025~9999)</small>

Server Control Status

HTTP Server Status	Enabled	HTTP Server TCP Port	80
HTTPS Server Status	Enabled		
SNMP v1/v2c Server Status	Enabled		
SNMP v3 Server Status	Enabled		
SSH Server Status	Enabled		
TELNET Server Status	Enabled	TELNET Server TCP Port	23

Parameter	Description
Server Settings	
HTTP Server State	Selects Enable or Disable to enable or disable the HTTP service.
HTTPS Server State	Selects Enable or Disable to enable or disable the HTTPS service.
SNMPv1/v2c Server State	Selects Enable or Disable to enable or disable the SNMPv1/v2c service.
SNMPv3 Server State	Selects Enable or Disable to enable or disable the SNMPv3 service.
SSH Server State	Selects Enable or Disable to enable or disable the SSH service.
Telnet Server State	Selects Enable or Disable to enable or disable the Telnet service.
Apply	Click Apply to configure the settings.
Refresh	Click this button to reset the fields to the last setting.
Server Status	

HTTP Server Status	Displays the current HTTP service status.
HTTPS Server Status	Displays the current HTTPS service status.
SNMPv1/v2c Server Status	Displays the current SNMPv1/v2c service status.
SNMPv3 Server Status	Displays the current SNMPv3 service status.
SSH Server Status	Displays the current SSH service status.
Telnet Server Status	Displays the current Telnet service status.

6.5. Storm Control

6.5.1. Alarm Threshold

When the selected packet rate is over the alarm threshold, the Switch will send syslog alarm to syslog server.

6.5.1.1. Web Configuration

Storm Control

Alarm Threshold
Storm Control

Alarm Threshold Settings

State Disable ▾

Port	State	Packet Type	Packet Rate (pps)
From: 1 ▾ To: 1 ▾	Disable ▾	Broadcast ▾	100

Apply
Refresh

Alarm Threshold Status

Port	State	Status	Packet Type	Packet Rate(pps)
1	Disabled	Normal	Broadcast	100
2	Disabled	Normal	Broadcast	100
3	Disabled	Normal	Broadcast	100
4	Disabled	Normal	Broadcast	100
5	Disabled	Normal	Broadcast	100
6	Disabled	Normal	Broadcast	100

Parameter	Description
Alarm Threshold Settings	
State	Select option to enable / disable the alarm threshold feature on the Switch.

Port	Selects a port or a range of ports on which to configure the alarm threshold.
State	Selects Enable / Disable the alarm threshold for the port(s).
Packet Type	Selects packet type one of Broadcast / Multicast / Broadcast and Multicast.
Packet Rate	Select the alarm threshold packet rate in pps.
Alarm Threshold Status	
	The table display the current settings and port status.

6.5.2. Storm Control

A broadcast storm means that your network is overwhelmed with constant broadcast or multicast traffic. Broadcast storms can eventually lead to a complete loss of network connectivity as the packets proliferate.

Storm Control protects the Switch bandwidth from flooding packets, including broadcast packets, multicast packets, and destination lookup failure (DLF).

Broadcast storm control limits the number of broadcast, multicast and unknown unicast (also referred to as Destination Lookup Failure or DLF) packets the Switch receives per second on the ports. When the maximum number of allowable broadcast, multicast and unknown unicast packets is reached per second, the subsequent packets are discarded. Enable this feature to reduce broadcast, multicast and unknown unicast packets in your network.

The default rate is 300pps for Broadcast and DLF. You can set to maximum rate of 5000pps for multicast, broadcast or DLF

6.5.2.1. CLI Configuration

Node	Command	Description
enable	show storm-control	This command displays the current storm control configurations.
configure	storm-control rate RATE_LIMIT type (bcast mcast DLF bcast+mcast bcast+DLF mcast+DLF bcast+mcast+DLF) ports PORTLISTS	This command enables the bandwidth limit for broadcast or multicast or DLF packets and set the limitation.
configure	no storm-control type (bcast mcast DLF bcast+mcast bcast+DLF mcast+DLF bcast+mcast+DLF) ports PORTLISTS	This command disables the bandwidth limit for broadcast or multicast or DLF packets.

Example:

L2SWITCH#configure terminal

L2SWITCH(config)#storm-control rate 1 type broadcast ports 1-6
 L2SWITCH(config)#storm-control rate 1 type multicast ports 1-6
 L2SWITCH(config)#storm-control rate 1 type DLF ports 1-6

6.5.2.2. Web Configuration

Storm Control

Alarm Threshold
Storm Control

Storm Control Settings

Port	Rate	Type
From: <input type="text" value="1"/> To: <input type="text" value="1"/>	<input type="text" value="0"/> (pps)	<input type="text" value="Broadcast"/>

(Range:1~5000, 0:Disable)

Storm Control Status

Port	Multicast Rate(pps)	Broadcast Rate(pps)	DLF Rate(pps)	Port	Multicast Rate(pps)	Broadcast Rate(pps)	DLF Rate(pps)
1	0	300	300	2	0	300	300
3	0	300	300	4	0	300	300
5	0	300	300	6	0	300	300

Parameter	Description
Storm Control Settings	
Port	Select individual port number or range for which you want to configure storm control settings.
Rate	Configure the packet rate in pps to allow on interfaces. Disable for 0 and ranges 1 ~ 5000. .
Type	Click the check box to select Multicast / Broadcast / DLF storm control.
Apply	Click Apply to take effect the settings.
Refresh	Click Refresh to begin configuring this screen afresh.
Storm Control Status	
Port	This field displays a port number.
Multicast Rate(pps)	This field displays the multicast storm control state along with configured rate of pps on the port.
Broadcast Rate(pps)	This field displays the broadcast storm control state along with configured rate of pps on the port.

DLF Rate(pps)	This field displays the DLF storm control state along with configured rate of pps on the port.
---------------	--

6.6. VLAN

6.6.1. Port Isolation

The port isolation is a port-based virtual LAN feature. It partitions the switching ports into virtual private domains designated on a per port basis. Data switching outside of the port's private domain is not allowed. It will ignore the packets' tag VLAN information. This feature is a per port setting to configure the egress port(s) for the specific port to forward its received packets. If the CPU port (port 0) is not an egress port for a specific port, the host connected to the specific port cannot manage the Switch.

If you wish to allow two subscriber ports to talk to each other, you must define the egress port for both ports. CPU refers to the Switch management port. By default it forms a VLAN with all Ethernet ports. If it does not form a VLAN with a particular port then the Switch cannot be managed from that port.

6.6.1.1. CLI Configuration

Node	Command	Description
enable	show port-isolation	This command displays the current port isolation configurations. "V" indicates the port's packets can be sent to that port. "-" indicates the port's packets cannot be sent to that port.
interface	port-isolation ports PORTLISTS	This command configures a port or a range of ports to egress traffic from the specific port.
interface	no port-isolation	This command configures all ports to egress traffic from the specific port.

Example: If you want to allow port-1 and port-3 to talk to each other, you must configure as below:

```
L2SWITCH(config)#interface 1/0/1
L2SWITCH(config-if)#port-isolation ports 3
L2SWITCH(config-if)#exit
Allow the port-1 to send its ingress packets to port-3.
L2SWITCH(config)#interface 1/0/3
L2SWITCH(config-if)#port-isolation ports 1
L2SWITCH(config-if)#exit
Allow the port-3 to send its ingress packets to port-1
```

6.6.1.2. Web Configuration

VLAN

Port Isolation
VLAN

Port Isolation Settings

Port From: To:

Egress Port:

Select All Deselect All

6

1 2 3 4 5 0 (CPU)

Port Isolation Status

Port	Egress Port						
	0	1	2	3	4	5	6
1	v	v	v	v	v	v	v
2	v	v	v	v	v	v	v
3	v	v	v	v	v	v	v
4	v	v	v	v	v	v	v
5	v	v	v	v	v	v	v
6	v	v	v	v	v	v	v

Parameter	Description
Port	Select a port number to configure its port isolation settings. Select All Ports to configure the port isolation settings for all ports on the Switch.
Egress Port	An egress port is an outgoing port, that is, a port through which a data packet leaves. Selecting a port as an outgoing port means it will communicate with the port currently being configured.
Select All/ Deselect All	Click Select All to mark all ports as egress ports and permit traffic. Click Deselect All to unmark all ports and isolate them. Deselecting all ports means the port being configured cannot communicate with any other port.
Apply	Click Apply to configure the settings.
Refresh	Click this to reset the fields to the last setting.
Port Isolation Status	“V” indicates the port’s packets can be sent to that port. “-” indicates the port’s packets cannot be sent to that port.

6.6.2. VLAN Settings

802.1Q VLAN

A virtual LAN, commonly known as a VLAN, is a group of hosts with a common set of requirements that communicate as if they were attached to the Broadcast domain, regardless of their physical location. A VLAN has the same attributes as a physical LAN, but it allows for end stations to be grouped together even if they are not located on the same network switch. In Lite Managed switches, user can configure maximum of 5 VLAN's on each interface in the format 1,3,7,10,25. Network reconfiguration can be done through software instead of physically relocating devices.

VID- VLAN ID is the identification of the VLAN, which is basically used by the standard 802.1Q. It has 12 bits and allow the identification of 4096 (2^{12}) VLANs. Of the 4096 possible VIDs, a VID of 0 is used to identify priority frames and value 4095 (FFF) is reserved, so the maximum possible VLAN configurations are 4,094.

A tagged VLAN uses an explicit tag (VLAN ID) in the MAC header to identify the VLAN membership of a frame across bridges - they are not confined to the switch on which they were created. The VLANs can be created statically by hand or dynamically through GVRP. The VLAN ID associates a frame with a specific VLAN and provides the information that switches need to process the frame across the network. A tagged frame is four bytes longer than an untagged frame and contains two bytes of TPID (Tag Protocol Identifier, residing within the type/length field of the Ethernet frame) and two bytes of TCI (Tag Control Information, starts after the source address field of the Ethernet frame).

The CFI (Canonical Format Indicator) is a single-bit flag, always set to zero for Ethernet switches. If a frame received at an Ethernet port has a CFI set to 1, then that frame should not be forwarded as it is to an untagged port. The remaining twelve bits define the VLAN ID, giving a possible maximum number of 4,096 VLANs. Note that user priority and VLAN ID are independent of each other. A frame with VID (VLAN Identifier) of null (0) is called a priority frame, meaning that only the priority level is significant and the default VID of the ingress port is given as the VID of the frame. Of the 4096 possible VIDs, a VID of 0 is used to identify priority frames and value 4095 (FFF) is reserved, so the maximum possible VLAN configurations are 4,094.

TPID	User Priority	CFI	VLAN ID
2 bytes	3 bits	1 bit	12 bits

● Forwarding Tagged and Untagged Frames

Each port on the Switch is capable of passing tagged or untagged frames. To forward a frame from an 802.1Q VLAN-aware switch to an 802.1Q VLAN-unaware switch, the Switch first decides where to forward the frame and then strips off the VLAN tag. To forward a frame from an 802.1Q VLAN-unaware switch to an 802.1QVLAN-aware switch, the Switch first decides where to forward the frame, and then inserts a VLAN tag reflecting the ingress port's default VID. The default PVID is VLAN 1 for all ports, but this can be changed.

A broadcast frame (or a multicast frame for a multicast group that is known by the system) is duplicated only on ports that are members of the VID (except the ingress port itself), thus confining the broadcast to a specific domain.

- **802.1Q Port Base VLAN**

With port-based VLAN membership, the port is assigned to a specific VLAN independent of the user or system attached to the port. This means all users attached to the port should be members of the same VLAN. The network administrator typically performs the VLAN assignment. The port configuration is static and cannot be automatically changed to another VLAN without manual reconfiguration.

As with other VLAN approaches, the packets forwarded using this method do not leak into other VLAN domains on the network. After a port has been assigned to a VLAN, the port cannot send to or receive from devices in another VLAN without the intervention of a Layer 3 device.

The device that is attached to the port likely has no understanding that a VLAN exists. The device simply knows that it is a member of a subnet and that the device should be able to talk to all other members of the subnet by simply sending information to the cable segment. The switch is responsible for identifying that the information came from a specific VLAN and for ensuring that the information gets to all other members of the VLAN. The switch is further responsible for ensuring that ports in a different VLAN do not receive the information.

This approach is quite simple, fast, and easy to manage in that there are no complex lookup tables required for VLAN segmentation. If port-to-VLAN association is done with an application-specific integrated circuit (ASIC), the performance is very good. An ASIC allows the port-to-VLAN mapping to be done at the hardware level.

The port isolation is a port-based virtual LAN feature. It partitions the switching ports into virtual private domains designated on a per port basis. Data switching outside of the port's private domain is not allowed. It will ignore the packets' tag VLAN information.

This feature is a per port setting to configure the egress port(s) for the specific port to forward its received packets. If the CPU port (port 0) is not an egress port for a specific port, the host connected to the specific port cannot manage the Switch.

If you wish to allow two subscriber ports to talk to each other, you must define the egress port for both ports. CPU refers to the Switch management port. By default it forms a VLAN with all Ethernet ports. If it does not form a VLAN with a particular port then the Switch cannot be managed from that port.

Notice:

Maximum allowable VLAN's to configure on the device are 5.

Access port:

Allows one VLAN only which is untagged port and PVID (particular VLAN id) should be configured on interface by default VLAN 1 is PVID for all the interfaces. The port should be connected to PC device.

Trunk port:

Allows the user to configure up to 5 VLAN's maximum on the interface and always tagged where its PVID is 1 (the system configures them automatically). The port should be connected to another switch.

Default Settings

All ports join in the VLAN 1.

6.6.2.1. CLI Configuration

Node	Command	Description
enable	show vlan VLANID	This command displays the VLAN configurations.
configure	vlan <1~4094>	This command enables a VLAN and enters the VLAN node.
configure	no vlan <1~4094>	This command deletes a VLAN.
vlan	show	This command displays the current VLAN configurations.
vlan	name STRING	This command assigns a name for the specific VLAN. The VLAN name should be the combination of the digit or the alphabet or hyphens (-) or underscores (_). The maximum length of the name is 16 characters.
vlan	no name	This command configures the vlan name to default. Note: The default vlan name is "VLAN"+vlan_ID, VLAN1, VLAN2,...
vlan	add PORTLISTS	This command add a port or a range of ports to the vlan.
vlan	fixed PORTLISTS	This command assigns ports for permanent member of the vlan.
vlan	no fixed PORTLISTS	This command removes all fixed member from the vlan.
vlan	tagged PORTLISTS	This command assigns ports for tagged member of the VLAN group. The ports should be one/some of the permanent members of the vlan.
vlan	no tagged PORTLISTS	This command removes all tagged member from the vlan.
vlan	untagged PORTLISTS	This command assigns ports for untagged member of the VLAN group. The ports should be one/some of the permanent members of the vlan.
vlan	no untagged PORTLISTS	This command removes all untagged member from the vlan.

interface	acceptable frame type (all tagged untagged)	This command configures the acceptable frame type. all - acceptable all frame types. tagged - acceptable tagged frame only. untagged – acceptable untagged frame only.
interface	pvid VLANID	This command configures a VLAN ID for the port default VLAN ID.
interface	no pvid	This command configures 1 for the port default VLAN ID.
config	interface range gigabitethernet1/0/ PORTLISTS	This command enters the interface configure node.
if-range	pvid VLANID	This command configures a VLAN ID for the port default VLAN ID.
if-range	no pvid	This command configures 1 for the port default VLAN ID.
configure	vlan range STRINGS	This command configures a range of VLAN's and Maximum allowed VLAN's are 5.
configure	no vlan range STRINGS	This command removes a range of VLAN's and Maximum removable VLAN's are 5.
vlan-range	1-4	This command will allow user to create VLAN range maximum allowed VLAN's are 5
vlan-range	add PORTLISTS	This command adds a port or a range of ports to the vlans.
vlan-range	fixed PORTLISTS	This command assigns ports for permanent member of the VLAN group.
vlan-range	no fixed PORTLISTS	This command removes all fixed member from the vlans.
vlan-range	tagged PORTLISTS	This command assigns ports for tagged member of the VLAN group. The ports should be one/some of the permanent members of the vlans.
vlan-range	no tagged PORTLISTS	This command removes all tagged member from the vlans.
vlan-range	untagged PORTLISTS	This command assigns ports for untagged member of the VLAN group. The ports should be one/some of the permanent members of the vlans.
vlan-range	no untagged PORTLISTS	This command removes all untagged member from the vlans.

Example:

- L2SWITCH#configure terminal
- L2SWITCH(config)#vlan 2
- L2SWITCH(config-vlan)#fixed 1-5
- L2SWITCH(config-vlan)#untagged 1-3
- L2SWITCH(config)#vlan range 10-14

- L2SWITCH(config-vlan-range)# fixed 1-5
- L2SWITCH(config-vlan-range)# tagged 5

6.6.2.2. Web Configuration

VLAN

Port Isolation
VLAN Settings

VLAN Settings

Port	Role	VLAN
1	Access ▾	1
2	Access ▾	1
3	Access ▾	1
4	Access ▾	1
5	Access ▾	1
6	Access ▾	1

A Trunk port allows you to join multiple VLANs which must be tagged.
 An Access port allows you to set only one VLAN which must be untagged.

Apply
Refresh

Parameter	Description
Port	Select a port number to configure from the drop-down box. Select All to configure all ports at the same time.
Role	Select role on interface as access or trunk.
VLAN	User can configure maximum of 5 VLAN's on each interface in the format 1,3,7,10,25.
Apply	Click Apply to save your changes back to the Switch.
Refresh	Click Refresh to begin configuring this screen afresh.

7. Diagnosis

7.1. Alarm Information

The feature displays if there are any abnormal situation need process immediately.

Notice:

The Alarm DIP Switch allow users to configure if send alarm message when the corresponding event occurs.

For Example:

PWR: ON, The Switch will send alarm message when the main power supply disconnect.

RPS: ON, The Switch will send alarm message when the redundant power supply disconnect.

7.1.1. CLI Command

Node	Command	Description
enable	show alarm-info	This command displays alarm information.

7.1.2. Web Configuration

Alarm

Alarm Information

Alarm Status: No Alarm.

Alarm Reason(s)

Alarm DIP switch Settings:

DIP switch	Status	DIP switch	Status
PWR	Disable	RPS	Disable

Refresh

Parameter	Description
Alarm Information	
Alarm Status	This field indicates if there is any alarm events.
Alarm Reason(s)	This field displays all of the detail alarm events.
Function DIP Switch Settings	
PWR	The field display the current Power Control DIP settings. Disable – Power Control controlled by user configurations. Enable – Power control is enabled.

RPS	The field display the current Redundant Power Supply Control DIP settings. Disable – RPS Control controlled by user configurations. Enable – RPS control is enabled.
Refresh	Refresh Button will refresh the page to display the applied changes

7.2. Port Mirror

The Port-Based Mirroring is used on a network switch to send a copy of network packets sent/received on one switch ports to a network monitoring connection on another switch port (Destination Port). This is commonly used for network appliances that require monitoring of network traffic, such as an intrusion-detection system.

Port Mirroring, together with a network traffic analyzer, helps to monitor network traffic.

7.2.1. CLI Configuration

Node	Command	Description
enable	show mirror	This command displays the current port mirroring configurations.
configure	mirror (disable enable)	This command disables / enables the port mirroring on the switch.
configure	mirror destination port PORT_ID	This command specifies the monitor port for the port mirroring.
configure	mirror source ports PORT_LIST mode (both ingress egress)	This command adds a port or a range of ports as the source ports of the port mirroring.
configure	no mirror source ports PORT_LIST	This command removes a port or a range of ports from the source ports of the port mirroring.

The procedures to configure the port mirror.

- To enter the configure node.
L2SWITCH#configure terminal
L2SWITCH(config)#
- To enable the global mirror function.
L2SWITCH(config)#mirror enable
- To configure the monitor port to port 2.
L2SWITCH(config)#mirror destination port 2
- To configure the source ports which you want to check.
L2SWITCH(config)#mirror source ports 3-6 mode both

7.2.2. Web Configuration

Port Mirror

Port Mirror Settings

State:

Monitor to Port:

All Ports:

Source Port	Mirror Mode	Source Port	Mirror Mode
1	<input type="text" value="Disable"/>	2	<input type="text" value="Disable"/>
3	<input type="text" value="Disable"/>	4	<input type="text" value="Disable"/>
5	<input type="text" value="Disable"/>	6	<input type="text" value="Disable"/>

Parameter	Description
Port Mirror Settings	
State	Select option to enable / disable the port mirroring feature on the Switch globally.
Monitor to Port	Select the port which connects to a network traffic analyzer.
All Ports	<p>Settings in this field apply to all ports.</p> <p>Use this field only if you want to make some settings the same for all ports.</p> <p>Use this field first to set the common settings and then make adjustments on a port-by-port basis.</p>
Source Port	Selects a port to monitor packets received and transmit or both.
Monitor Mode	<p>Select a port to monitor as destination for the source port.</p> <p>Select Ingress, Egress or Both to only copy the ingress (incoming), egress (outgoing) or both (incoming and outgoing) traffic from the specified source ports to the monitor port.</p> <p>Select Disable to not copy any traffic from the specified source ports to the monitor port.</p>
Apply	Click Apply to take effect the settings.
Refresh	Click Refresh to begin configuring this screen afresh.

7.3. Port Statistics

This feature helps users to monitor the ports' statistics, to display the link up ports' traffic utilization only.

7.3.1. CLI Configuration

Node	Command	Description
enable	show port-statistics	This command displays the link up ports' statistics.

Example :

L2SWITCH#show port-statistics

Port	Packets		Bytes		Errors		Drops	
	Rx	Tx	Rx	Tx	Rx	Tx	Rx	Tx
7	1154	2	108519	1188	0	0	0	0

7.3.2. Web Information

Port Statistics									
Port Statistics									
Port	Receive Drops	Transmit Drops	Receive Errors	Transmit Errors	Receive Packets	Transmit Packets	Receive Bytes	Transmit Bytes	
1	2718	0	0	0	1034704	1040403	467522497	446900069	
					<input type="button" value="Refresh"/>	<input type="button" value="Clear"/>			

Parameter	Description
Port	Select a port or a range of ports to display their statistics.
Rx Packets	The field displays the received packet count.
Tx Packets	The field displays the transmitted packet count.
Rx Bytes	The field displays the received byte count.
Tx Bytes	The field displays the transmitted byte count.
Rx Errors	The field displays the received error count.
Tx Errors	The field displays the transmitted error count.
Rx Drops	The field displays the received drop count.
Tx Drops	The field displays the transmitted drop count.
Refresh	Click this button to refresh the screen quickly.

7.4. Port Utilization

This feature helps users to monitor the ports' traffic utilization, to display the link up ports' traffic utilization only.

7.4.1. CLI Configuration

Node	Command	Description
enable	show port-utilization	This command displays the link up ports' traffic utilization.

Example:

```
L2SWITCH#show port-utilization
Port Speed Utilization(%)
-----
 9     100     0.001
```

7.4.2. Web Port Utilization

Port Utilization					
Port Utilization					
Port	Speed	Rx Utilization (%)	Rx Utilization (bps)	Tx Utilization (%)	Tx Utilization (bps)
1	1000	0.01	131517	0.01	109040
<input type="button" value="Refresh"/>					

Parameter	Description
Port Utilization	
Port	The field displays the port ID.
Speed	The field displays the port's speed.
Rx Utilization (%)	The field display Rx utilization in percentage.
Rx Utilization (bps)	The field display Rx utilization in bps.
Tx Utilization (%)	The field display Tx utilization in percentage.
Tx Utilization (bps)	The field display Tx utilization in bps.

7.5. Syslog

The syslog function records some of system information for debugging purpose. Each log message recorded with one of these levels, **Alert / Critical / Error / Warning / Notice / Information**. The syslog function can be enabled or disabled. The default setting is disabled. The log message is recorded in the Switch file system. If the syslog server's IP address has been configured, the Switch will send a copy to the syslog server.

The log message file is limited in 2000 entries. If the file is full, the oldest one will be replaced.

7.5.1. CLI Configuration

Node	Command	Description
enable	show syslog	The command displays all of log message recorded in the Switch.
enable	show syslog level LEVEL	The command displays the log message with the LEVEL recorded in the Switch.
enable	show syslog server	The command displays the syslog server configurations.
configure	syslog-server (disable enable)	The command disables / enables the syslog function.
configure	syslog-server ip IPADDR	The command configures the syslog server's IP address.

Example:

- L2SWITCH#configure terminal
- L2SWITCH(config)#syslog-server ip 192.168.200.106
- L2SWITCH(config)#syslog-server enable

7.5.2. Web Configuration

Syslog

Syslog Server Setting

Server IP

Syslog

Log Level

```

<1> 2014 Jan 1 00:00:00 10001:AC/Main power source is connected!
<6> 2014 Jan 1 00:00:01 60003:System Cold Start!
<4> 2014 Jan 1 00:00:01 40005:Port 1 Link Up.
<6> 2014 Jan 1 00:00:30 7f969ab8:User(admin) Login Succeeded!
<6> 2014 Jan 1 00:01:04 60005:Save configurations to file!
<6> 2014 Jan 1 00:00:01 60003:System Cold Start!
<1> 2014 Jan 1 00:00:01 10001:AC/Main power source is connected!
<4> 2014 Jan 1 00:00:02 40005:Port 1 Link Up.
<6> 2014 Jan 1 00:01:18 60005:Save configurations to file!
<6> 2014 Jan 1 00:01:42 60001:User(admin) Login Succeeded!
<4> 2014 Jan 1 01:07:22 40004:Port 1 Link Down.
<4> 2014 Jan 1 01:08:38 40005:Port 1 Link Up.
<6> 2014 Jan 1 01:17:21 60001:User(admin) Login Succeeded!
<4> 2014 Jan 1 01:18:51 40004:Port 1 Link Down.
<4> 2014 Jan 1 01:20:06 40005:Port 1 Link Up.
<6> 2014 Jan 1 01:34:03 7f8a4ab8:User(system) Login Failed!
<6> 2014 Jan 1 02:22:23 100080f0:User(system) Login Failed!
<6> 2014 Jan 1 02:23:34 100080f0:User(system) Login Failed!
<6> 2014 Jan 1 02:24:26 100080f0:User(system) Login Failed!
<6> 2014 Jan 1 02:25:17 100080f0:User(svsystem) Login Failed!

```

Parameter	Description
Server IP	Enter the Syslog server IP address. Select Enable to activate switch sent log message to Syslog server when any new log message occurred.
Apply	Click Apply to add/modify the settings.
Refresh	Click Refresh to begin configuring this screen afresh.
Log Level	Select Alert/Critical/Error/Warning/Notice/Information to choose which log message to want to see.
Clear	Click Clear to clear all of log message.
Save	Click Save to save all of log message into NV-RAM.

7.6. Utilization Threshold

This feature alerts the user when the packet rate in the particular port is above the required rate.

7.6.1. CLI Configuration

Node	Command	Description
configure	port-utilization threshold (disable enable)	The command disables / enables the port utilization threshold function globally.
configure	interface IFNAME Ex: interface 1/0/4	This command enters the interface configure node.
interface	port-utilization threshold rate (value)	This command configures the port-utilization threshold value
interface	port-utilization threshold state (disable enable)	The command disables / enables the port utilization threshold function on interface.

Example:

```
L2SWITCH#configure terminal
L2SWITCH(config)#port-utilization threshold enable
L2SWITCH(config)#interface 1/0/4
L2SWITCH(config-if)#port-utilization threshold rate 40
L2SWITCH(config-if)#port-utilization threshold state enable
```

7.6.2. Web Configuration

Utilization Threshold

Utilization Threshold Settings

State Disable ▾

Port	State	Rx Packet Rate(%)
From: 1 ▾ To: 1 ▾	Disable ▾	100

(Range:10~100%)

Apply
Refresh

Utilization Threshold Status

Port	State	Status	Rx Packet Rate(%)
1	Disabled	Normal	100
2	Disabled	Normal	100
3	Disabled	Normal	100
4	Disabled	Normal	100
5	Disabled	Normal	100
6	Disabled	Normal	100

Parameter	Description
Alarm Threshold Settings	
State	Select option to enable / disable the alarm threshold feature on the Switch.
Port	Selects a port or a range of ports on which to configure the alarm threshold.
State	Selects Enable / Disable the alarm threshold for the port(s).
Packet Rate	Configures the threshold rate. When the port packet rate over the threshold, the Switch will send trap and syslog.
Apply	Click Apply to take effect the settings.
Refresh	Click Refresh to begin configuring this screen afresh.
Alarm Threshold Status	
Port	This field displays a port number.
State	This field displays the current alarm threshold state for the port.
Status	This field displays if alarm threshold has happened on the port.

Packet Rate	This field displays the current threshold.
-------------	--

8. Management

8.1. SNMPv1/v2c

Simple Network Management Protocol

Simple Network Management Protocol (SNMP) is used in network management systems to monitor network-attached devices for conditions that warrant administrative attention. SNMP is a component of the Internet Protocol Suite as defined by the Internet Engineering Task Force (IETF). It consists of a set of standards for network management, including an application layer protocol, a database schema, and a set of data objects. SNMP exposes management data in the form of variables on the managed systems, which describe the system configuration. These variables can then be queried (and sometimes set) by managing applications.

8.1.1. SNMP configuration

Allows user to enable and disable SNMP protocol globally, By default SNMP state will be disabled, User can change the system name with respect to their requirement also can add system location and contact location.

8.1.1.1. CLI Configuration

Node	Command	Description
enable	show snmp	This command displays the SNMP configurations.
configure	snmp (disable enable)	This command disables/enables the SNMP on the switch.
configure	snmp system-name STRING	This command configures a name for the system. (The System Name is same as the host name)
configure	snmp system-location STRING	This command configures the location information for the system.
configure	snmp system-contact STRING	This command configures contact information for the system.

Example:

- L2SWITCH#configure terminal
- L2SWITCH(config)#snmp enable
- L2SWITCH(config)#snmp system-contact IT engineer
- L2SWITCH(config)#snmp system-location Branch-Office

8.1.1.2. Web Configuration

SNMP

Configuration	Community Name	Trap Event	Port Trap Event	Trap Receiver
SNMP Settings				
SNMP State	<input type="text" value="Disable"/>			
System Name	<input type="text" value="L2SWITCH"/>			
System Location	<input type="text"/>			
System Contact	<input type="text"/>			
<input type="button" value="Apply"/> <input type="button" value="Refresh"/>				

Parameter	Description
SNMP Settings	
SNMP State	Select option to enable / disable the SNMP on the Switch.
System Name	User can configure system name.
System Location	User can configure the switch deployed location for reference.
System Contact	User can configure System Contact person information like name or number.

8.1.2. SNMP community Name

SNMP community acts like a password and is used to define the security parameters of SNMP clients in an SNMP v1 and SNMP v2c environments. The default SNMP community is “public” for both SNMP v1 and SNMP v2c.

Network ID of Trusted Host:

The IP address is a combination of the Network ID and the Host ID.

Network ID = (Host IP & Mask).

User need only input the network ID and leave the host ID to 0. If user has input the host ID, such as 192.168.1.102, the system will reset the host ID, such as 192.168.1.0

8.1.2.1. CLI Configuration

Node	Command	Description
configure	snmp community STRING (ro rw) trusted-host IPADDR/Subnet Mask	This command configures the SNMP community name, Permission(ro/rw), Trusted host IP/Subnet mask.

Example:

- L2SWITCH#configure terminal
- L2SWITCH(config)#snmp community public rw trusted-host 192.168.200.106/24

8.1.2.2. Web Configuration

The screenshot shows the SNMP web configuration interface. The main title is "SNMP". There are five tabs: "Configuration", "Community Name", "Trap Event", "Port Trap Event", and "Trap Receiver". The "Community Name" tab is selected, displaying "Community Name Settings". This section contains a table with four columns: "Community String", "Rights", "Network ID of Trusted Host", and "Number of Mask Bit". The "Rights" dropdown menu is set to "Read-Only". Below the table are "Apply" and "Refresh" buttons. At the bottom of the page is a "Community Name List" table with six columns: "No.", "Community String", "Rights", "Network ID of Trusted Host", "Number of Mask Bit", and "Action".

Parameter	Description
Community Name	
Community String	Enter a Community string; this will act as a password for requests from the management station. An SNMP community string is a text string that acts as a password. It is used to authenticate messages that are sent between the management station (the SNMP manager) and the device (the SNMP agent). The community string is included in every packet that is transmitted between the SNMP manager and the SNMP agent.
Rights	Select Read-Only to allow the SNMP manager using this string to collect information from the Switch. Select Read-Write to allow the SNMP manager using this string to create or edit MIBs (configure settings on the Switch).
Network ID of Trusted Host	Type the IP address of the remote SNMP management station in dotted decimal notation, for example 192.168.1.0.
Number of Mask Bit	Type the length of the subnet mask bits.
Apply	Click Apply to take effect the settings.
Refresh	Click Refresh to begin configuring this screen afresh.

Community Name List	
No.	This field displays the index number of an entry.
Community String	This field displays the community string of an entry.
Rights	This field displays the right of an entry.
Network ID of Trusted Host	This field displays the network ID of trusted host of an entry.
Number of Mask Bit	This field displays the length of the subnet mask bits of an entry.
Action	Click the Delete button to remove the entry.

8.1.3. SNMP Event Settings

The features allow users to enable/disable individual trap notification.

8.1.3.1. CLI Configuration

Node	Command	Description
enable	show snmp trap-event	This command displays the SNMP configurations.
configure	snmp trap-event alarm-over-heat (disable/enable)	This command enables/disables the alarm-over-heat trap.
configure	snmp trap-event alarm-over-load (disable/enable)	This command enables/disables the alarm-over-load trap.
configure	snmp trap-event alarm-power-fail (enable/enable)	This command enables/disables the alarm-power-fail trap.
configure	snmp trap-event bpdu (disable/enable)	This command enables/disables the BPDU port state change/BPDU Root Guard/BPDU Guard trap.
configure	snmp trap-event loop-detection (disable/enable)	This command enables/disables the loop-detection trap.
configure	snmp trap-event port-admin-state-change (disable/enable)	This command enables/disables the port-admin-state-change trap.
configure	snmp trap-event port-link-change (disable/enable)	This command enables/disables the port-link-change trap.
configure	snmp trap-event power-source-change	This command enables/disables the power-source-change trap.

	(disable/enable)	
configure	snmp trap-event stp-topology-change (disable/enable)	This command enables/disables the stp-topology-change trap.
configure	snmp trap-event traffic-monitor (disable/enable)	This command enables/disables thetraffic-monitor trap.

8.1.3.2. Web Configuration

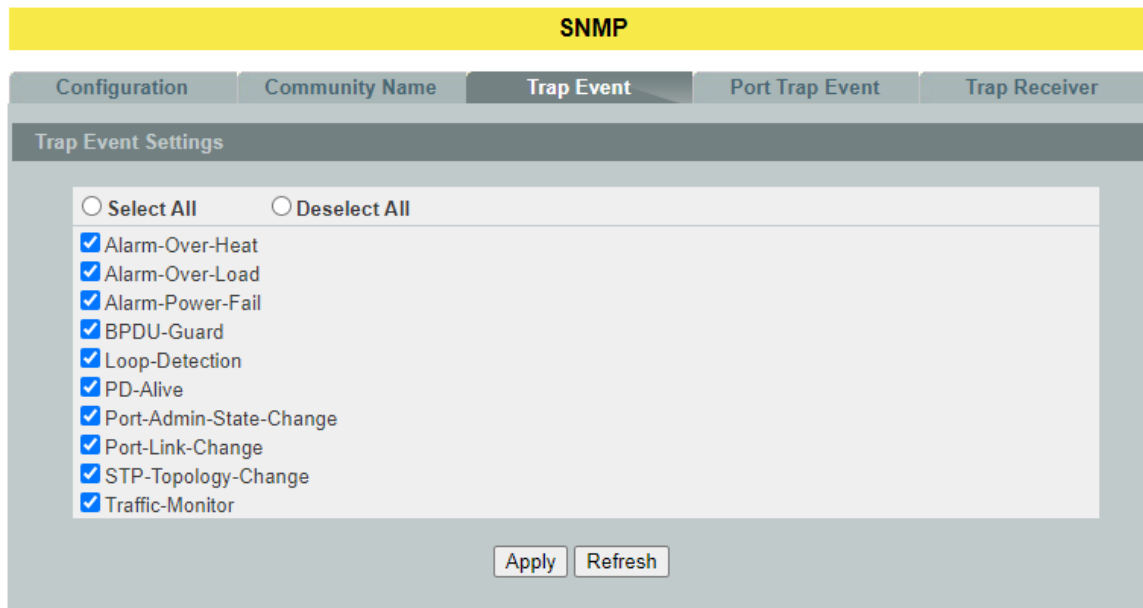

The features allow users to enable/disables individual trap notification.

- | | |
|-------------------------|--|
| Alarm-Over-Heat | - Trap when system's temperature is too high. |
| Alarm-Over-Load | - Trap when system is over load. |
| Alarm-Power-Fail | - Trap when system power is over voltage/under voltage/RPS over voltage/RPS under voltage. |
| BPDU-Guard | - Trap when port is blocked by BPDU Guard/BPDU Root Guard/BPDU port state changed. |
| Loop-Detection | - Trap when port is blocked by Loop Detection. |
| Port-Admin-State-Change | - Trap when port is enabled/disable by administrator. |
| Port-Link-Change | - Trap when port is link up/down change. |
| STP-Topology-Change | - Trap when the STP topology change. |
| Traffic-Monitor | - Trap when port is blocked by Traffic Monitor. |

Parameter	Description
Trap Event State Settings	
Select all	Enables all of trap events.
Deselect All	Disables all of trap events.

Apply	Click Apply to configure the settings.
Refresh	Click Refresh to begin configuring this screen afresh.

8.1.4. Port Trap Event Settings

The features allow users to enable/disable port-link-change trap notification by individual port.

8.1.4.1. CLI Configuration

Node	Command	Description
enable	show snmp port-link-change-trap	This command displays the SNMP port link-change trap configurations.
interface	snmp port-link-change-trap	This command enables the link change trap on the specific port.
interface	no snmp port-link-change-trap	This command disables the link change trap on the specific port.
config	interface range (fastethernet1/0/ gigabitethernet1/0/) PORTLISTS	This command enters the interface configure node.
if-range	snmp port-link-change-trap	This command enables the link change trap on the specific ports.
if-range	no snmp port-link-change-trap	This command disables the link change trap on the specific ports.

8.1.4.2. Web Configuration

SNMP

Configuration
Community Name
Trap Event
Port Trap Event
Trap Receiver

Port Link-Change Trap Settings

Port

State

From: 1 ▼ To: 1 ▼

Enable ▼

Apply
Refresh

Port Link-Change Trap Status

Port	State	Port	State
1	Enabled	2	Enabled
3	Enabled	4	Enabled
5	Enabled	6	Enabled

Parameter	Description
Trap Event State Settings	

Port	Selects the range of ports.
State	User can enable /disable trap events when port link change.
Apply	Click Apply to configure the settings.
Refresh	Click Refresh to begin configuring this screen afresh.

8.1.5. SNMP Trap Receiver Settings

The features allow users to configure trap receiver configuration.

8.1.5.1. CLI Configuration

Node	Command	Description
configure	snmp trap-receiver IPADDR VERSION COMMUNITY String	This command configures the trap receiver's configurations, including the IP address, version (v1 or v2c) and community String.

8.1.5.2. Web Configuration

SNMP

Configuration
Community Name
Trap Event
Port Trap Event
Trap Receiver

Trap Receiver Settings

IP Address	Version	Community String
<input type="text"/>	v1 ▾	<input type="text"/>

Trap Receiver List

No.	IP Address	Version	Community String	Action

Parameter	Description
IP Address	Enter the IP address of the remote trap station in dotted decimal notation.
Version	Select the version of the Simple Network Management Protocol to use. v1 or v2c .
Community String	Specify the community string used with this remote trap station.
Apply	Click Apply to configure the settings.
Refresh	Click Refresh to begin configuring this screen afresh.
Trap Receiver List	

No.	This field displays the index number of the trap receiver entry. Click the number to modify the entry.
IP Address	This field displays the IP address of the remote trap station.
Version	This field displays the version of Simple Network Management Protocol in use. v1 or v2c .
Community String	This field displays the community string used with this remote trap station.
Action	Click Delete to remove a configured trap receiver station.

8.2. SNMPv3

SNMP version 3 (SNMPv3) supports authentication and encryption. SNMPv3 uses the user-based security model (USM) for message security and the view-based access control model (VACM) for access control. USM specifies authentication and encryption.

8.2.1. SNMPv3 Group

8.2.1.1. CLI Configuration

Node	Command	Description
enable	show snmp group	This command displays all snmp v3 group.
enable	configure terminal	This command changes the node to configure node.
configure	snmp group GROUPNAME noauth (read STRINGS write STRINGS notify STRINGS)	Configures v3 group of non-authentication.
configure	snmp group GROUPNAME auth (read STRINGS write STRINGS notify STRINGS)	Configures v3 group of authentication.
configure	snmp group GROUPNAME priv (read STRINGS write STRINGS notify STRINGS)	Configures v3 group of authentication and encryption.
configure	no snmp group GROUPNAME	This command removes a v3 group from switch.

8.2.1.2. Web Configuration

SNMPv3

Group Settings
User Settings
View Settings

Group Settings

Group Name

Security Level

Read View

Write View

Notify View

Group Status

Group Name	Security Model	Security Level	Read View	Write View	Notify View	Action
Empty!						

Parameter	Description
Group Settings	
Group Name	Enter the v3 user name.
Security Level	Select the security level of the v3 group to use.
Read View	Note that if a group is defined without a read view than all objects are available to read. (default value is none .)
Write View	if no write or notify view is defined, no write access is granted and no objects can send notifications to members of the group. (default value is none .)
Notify View	By using a notify view, a group determines the list of notifications its users can receive. (default value is none .)
Apply	Click Apply to configure the settings.
Refresh	Click Refresh to begin configuring this screen afresh.
Group Status	
Group Name	This field displays the v3 user name.
Security Model	This field displays the security model of the group. Always displayed v3: User-based Security Model (USM)
Security Level	This field displays the security level to this group.
Read View	These fields display the View list of this group.

Write View	
Notify View	
Action	Click Delete to remove a v3 group.

8.2.2. SNMPv3 User

8.2.2.1. CLI Configuration

Node	Command	Description
enable	show snmp user	This command displays all snmp v3 user.
enable	configure terminal	This command changes the node to configure node.
configure	snmp user USERNAME GROUPNAME noauth	Configurs v3 user of non- authentication.
configure	snmp user USERNAME GROUPNAME auth (MD5 SHA) STRINGS	Configurs v3 user of authentication.
configure	snmp user USERNAME GROUPNAME priv (MD5 SHA) STRINGS des STRINGS	Configurs v3 user of authentication and encryption.
configure	no snmp user USERNAME GROUPNAME	This command removes a v3 user from switch.

8.2.2.2. Web Configuration

SNMPv3

Group Settings
User Settings
View Settings

User Settings

User Name

Group Name

Security Level noauth ▼

Auth Algorithm MD5 ▼

Auth Password

Priv Algorithm DES ▼

Priv Password

User Status

User Name	Group Name	Auth Protocol	Priv Protocol	Rowstatus	Action
Justin	Justin	No Auth	No Priv	Active	<input type="button" value="Delete"/>
Justin1	Justin1	MD5	No Priv	Active	<input type="button" value="Delete"/>
Justin2	Justin2	MD5	DES	Active	<input type="button" value="Delete"/>

Parameter	Description
User Settings	
User Name	Enter the v3 user name.
Group Name	Map the v3 user name into a group name.
Security Level	Select the security level of the v3 user to use. noauth means no authentication and no encryption. auth means messages are authenticated but not encrypted. priv means messages are authenticated and encrypted.
Auth Algorithm	Select MD5 or SHA Algorithm when security level is auth or priv .
Auth Password	Set the password for this user when security level is auth or priv . (pass phrases must be at least 8 characters long!)
Priv Algorithm	Select DES encryption when security level is priv .
Priv Password	Set the password for this user when security level is priv . (pass phrases must be at least 8 characters long!)
Apply	Click Apply to configure the settings.

Refresh	Click Refresh to begin configuring this screen afresh.
User Status	
User Name	This field displays the v3 user name.
Group Name	This field displays the group name which the v3 user mapping.
Auth Protocol	These fields display the security level to this v3 user.
Priv Protocol	
Rowstatus	This field displays the v3 user row status.
Action	Click Delete to remove a v3 user.

8.2.3. SNMPv3 View

8.2.3.1. CLI Configuration

Node	Command	Description
enable	show snmp view	This command displays all snmp v3 view.
enable	configure terminal	This command changes the node to configure node.
configure	snmp view VIEWNAME STRINGS (included excluded)	This command configures the v3 view name for creating an entry in the SNMPv3 MIB view table and OID defining the root of the sub-tree to add to (or exclude from) the named view and included or excluded to define sub-tree adding to the view or not.
configure	no snmp view VIEWNAME STRINGS	This command removes a v3 view from the Switch.

8.2.3.2. Web Configuration

SNMPv3

Group Settings
User Settings
View Settings

View Settings

View Name

View Subtree

View Type included ▾

View Status

View Name	View Subtree	View Type	Action
Empty!			

Parameter	Description
View Settings	
View Name	Enter the v3 view name for creating an entry in the SNMPv3 MIB view table.
View Subtree	The OID defining the root of the subtree to add to (or exclude from) the named view.
View Type	Select included or excluded to define subtree adding to the view or not.
Apply	Click Apply to configure the settings.
Refresh	Click Refresh to begin configuring this screen afresh.
View Status	
View Name	This field displays the v3 view name.
View Subtree	This field displays the subtree.
View Type	This field displays the subtree adding to the view or not.
Action	Click Delete to remove a v3 view.

8.3. SNTP

The Network Time Protocol (NTP) is a protocol for synchronizing the clocks of computer systems over packet-switched, variable-latency data networks. A less complex implementation of NTP, using the same protocol but without requiring the storage of state over extended periods of time is known as the **Simple Network Time Protocol (SNTP)**.

NTP provides Coordinated Universal Time (UTC). No information about time zones or daylight saving time is transmitted; this information is outside its scope and must be obtained separately.

UDP Port: 123.

Daylight saving is a period from late spring to early fall when many countries set their clocks ahead of normal local time by one hour to give more daytime light in the evening.

Notes:

1. *The SNTP server always replies the UTC current time.*
2. *When the Switch receives the SNTP reply time, the Switch will adjust the time with the time zone configuration and then configure the time to the Switch.*
3. *If the time server's IP address is not configured, the Switch will not send any SNTP request packets.*
4. *If no SNTP reply packets, the Switch will retry every 10 seconds forever.*
5. *If the Switch has received SNTP reply, the Switch will re-get the time from NTP server every 24 hours.*
6. *If the time zone and time NTP server have been changed, the Switch will repeat the query process.*
7. *No default SNTP server.*

Default Settings

Current Time:

Time: 0:3:51 (UTC)

Date: 1970-1-1

Time Server Configuration:

Time Zone : +00:00

IP Address: 0.0.0.0

Daylight Saving Time Configuration:

State : disabled

Start Date: None.

End Date : None.

8.3.1. CLI Configuration

Node	Command	Description
enable	show time	This command displays current time and time configurations.
configure	time HOUR:MINUTE:SECOND	Sets the current time on the Switch. <i>hour: 0-23</i>

		<i>min:</i> 0-59 <i>sec:</i> 0-59 Note: If you configure Daylight Saving Time after you configure the time, the Switch will apply Daylight Saving Time.
configure	time date YEAR/MONTH/DAY	Sets the current date on the Switch. <i>year:</i> 1970- <i>month:</i> 1-12 <i>day:</i> 1-31
configure	time daylight-saving-time	This command enables the daylight saving time.
configure	no time daylight-saving-time	This command disables daylight saving on the Switch.
configure	time daylight-saving-time start-date (first second third fourth last) (Sunday Monday Tuesday Wednesday Thursday Friday Saturday) MONTH HOUR	This command sets the start time of the Daylight Saving Time.
configure	time daylight-saving-time end-date (first second third fourth last) (Sunday Monday Tuesday Wednesday Thursday Friday Saturday) MONTH HOUR	This command sets the end time of the Daylight Saving Time.
configure	time ntp-server (disable enable)	This command disables / enables the NTP server state.
configure	time ntp-server IP_ADDRESS	This command sets the IP address of your time server.
configure	time timezone STRING	Configures the time difference between UTC (formerly known as GMT) and your time zone. Valid value: -1200 ~ +1200.

8.3.2. Web Configuration

SNTP

Current Time and Date

Current Time 02:26:12 (UTC)
Current Date 2014-01-01

Time and Date Settings

Manual

New Time - - / : : (yyyy.mm.dd / hh:mm:ss)

Enable Network Time Protocol

NTP Server ntp0.fau.de - Europe
 IP

Time Zone

Daylight Saving Settings

State

Start Date of at o'clock

End Date of at o'clock

Parameter	Description
Current Time and Date	
Current Time	This field displays the time you open / refresh this menu.
Current Date	This field displays the date you open / refresh this menu.
Time and Date Setting	
Manual	Select this option if you want to enter the system date and time manually.
New Time	Enter the new date in year, month and day format and time in hour, minute and second format. The new date and time then appear in the Current Date and Current Time fields after you click Apply .
Enable Network Time Protocol	Select this option to use Network Time Protocol (NTP) for the time service.
NTP Server	Select a pre-designated time server or type the IP address or type the domain name of your time server. The Switch searches

	for the timeserver for up to 60 seconds.
Time Zone	Select the time difference between UTC (Universal Time Coordinated, formerly known as GMT, Greenwich Mean Time) and your time zone.
Daylight Saving Settings	
State	Select Enable if you want to use Daylight Saving Time. Otherwise, select Disable to turn it off.
Start Date	<p>Configure the day and time when Daylight Saving Time starts if you enabled Daylight Saving Time. The time is displayed in the 24 hour format. Here are a couple of examples:</p> <p>Daylight Saving Time starts in most parts of the United States on the second Sunday of March. Each time zone in the United States starts using Daylight Saving Time at 2 A.M. local time. So in the United States you would select Second, Sunday, 3(March) and 2:00.</p> <p>Daylight Saving Time starts in the European Union on the last Sunday of March. All of the time zones in the European Union start using Daylight Saving Time at the same moment (1 A.M. GMT or UTC). So in the European Union you would select Last, Sunday, 3(March) and the last field depends on your time zone. In Germany for instance, you would select 2:00 because Germany's time zone is one hour ahead of GMT or UTC (GMT+1).</p>
End Date	<p>Configure the day and time when Daylight Saving Time ends if you enabled Daylight Saving Time. The time field uses the 24 hour format.</p> <p>Here are a couple of examples:</p> <p>Daylight Saving Time ends in the United States on the last Sunday of October. Each time zone in the United States stops using Daylight Saving Time at 2 A.M. local time. So in the United States you would select First, Sunday, 11(November) and 2:00.</p> <p>Daylight Saving Time ends in the European Union on the last Sunday of October. All of the time zones in the European Union stop using Daylight Saving Time at the same moment (1 A.M. GMT or UTC). So in the European Union you would select Last, Sunday, 10(October) and the last field depends on your time zone. In Germany for instance, you would select 2:00</p>

	because Germany's time zone is one hour ahead of GMT or UTC (GMT+1).
Apply	Click this button to take effect the settings.
Refresh	Click this button to reset the fields to the last setting.

8.4. System Information

The System Information window appears each time you log into the program. Alternatively, this window can be accessed by clicking System Information.

8.4.1. CLI Configuration

Node	Command	Description
enable	show model	This command will display information of switch like vendor, product, mac-address, serial boot code, firmware version etc...

8.4.2. Web Configuration

System Information

System Information

Model Name	NGI-S04C2
Hostname	L2SWITCH
Boot Code Version	V1.2.6.S0
Firmware Version	V1.0.0.S0
Built Date	Mon Apr 26 17:29:32 CST 2021
DHCP Client	Enabled
IP Address	192.168.202.220
Subnet Mask	255.255.255.0
Default Gateway	192.168.202.1
MAC Address	00:06:87:03:20:00
Serial Number	3119AVOCN896A00001
Management VLAN	1
CPU Loading	<div style="display: inline-block; width: 20%; height: 10px; background: linear-gradient(to right, blue, gray);"></div> 20.95 %
Memory Information	Total: 127864 KB, Free: 113752 KB, Usage: 10.9 %
Current Time	2021-5-10, 0:40:50
System Uptime	0 days, 0 hours, 41 minutes, 4 seconds

Parameter	Description
System Information	
Model Name	This field displays the model name of the Switch.

Host name	This field displays the host name of the Switch.
Boot Code Version	This field displays the boot code version.
Firmware Version	This field displays the firmware version.
Built Date	This field displays the built date of the firmware.
DHCP Client	This field displays whether the DHCP client is enabled on the Switch.
IP Address	This field indicates the IP address of the Switch.
Subnet Mask	This field indicates the subnet mask of the Switch.
Default Gateway	This field indicates the default gateway of the Switch.
MAC Address	This field displays the MAC (Media Access Control) address of the Switch.
Serial Number	The serial number assigned by manufacture for identification of the unit.
Refresh	Click Refresh to begin configuring this screen afresh.

8.5. System Maintenance

8.5.1. Configuration

Upload and Download Configuration

8.5.1.1. CLI Configuration

Node	Command	Description
configure	write memory	This command writes current operating configurations to the configuration file.
configure	archive download-config <URL PATH>	This command downloads a new copy of configuration file from TFTP server. Where <URL PATH> can be: ftp://user:pass@192.168.1.1/file http://192.168.1.1/file tftp://192.168.1.1/file
configure	archive upload-config <URL PATH>	This command uploads the current configurations file to a TFTP server. Where <URL PATH> can be: ftp://user:pass@192.168.1.1/file http://192.168.1.1/file tftp://192.168.1.1/file
configure	reload default-config	This command copies a default-config file to replace the current one. Note: The system will reboot automatically to take effect the configurations.

8.5.1.2. Web Configuration

Click the “**Choose File**” button to select the new configuration file which you want to upgrade it to the Switch.

Click the “**Upload**” button to start the upgrade procedures.

Click the “**Download**” button to download the current configurations to local host.

Reset Configuration

Click the “**Reset**” button to reset the system configurations to default values.

The screenshot shows a web interface titled "System Maintenance" with three tabs: "Configuration", "Firmware", and "Reboot". The "Configuration" tab is selected. It contains three main sections:

- Save Configuration:** A section with the text "Save the parameter settings of the Switch :" and a "Save" button.
- Upload and Download Configuration:** A section with two radio button options:
 - Upload configuration file to your Switch. Below this is a "File path" field with a "Browse..." button and the text "No file selected.", followed by an "Upload" button.
 - Press "Download" to save configuration file to your PC. Below this is a "Download" button.
- Reset Configuration:** A section with the text "Reset the factory default settings of the Switch :
- IP address will be 192.168.0.254" and a "Reset" button.

8.5.2. Firmware

Upgrade Firmware

8.5.2.1. CLI Configuration

Node	Command	Description
configure	archive download-fw <URL PATH>	This command downloads a new copy of firmware file from TFTP / FTP / HTTP server. Where <URL PATH> can be: ftp://user:pass@192.168.1.1/file http://192.168.1.1/file tftp://192.168.1.1/file

8.5.2.2. Web Configuration

Click the “**Choose File**” button to select the new firmware which you want to upgrade it to the Switch.

Click the “**Upgrade**” button to start the upgrade procedures.

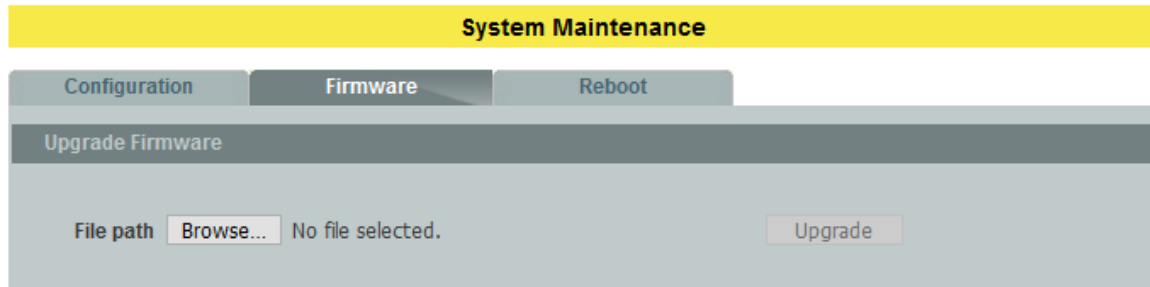

8.5.3. Reboot

8.5.3.1. CLI Configuration

Node	Command	Description
configure	reboot	This command reboots the system.

8.5.3.2. Web Configuration

Click the “**Reboot**” button to restart the Switch.

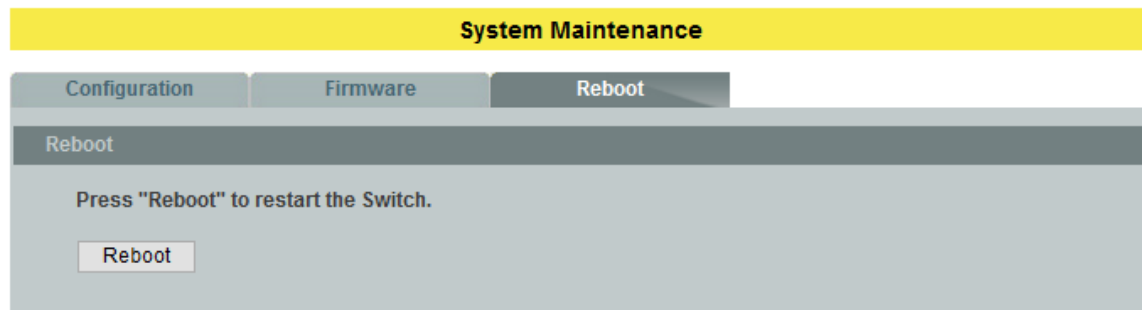

8.6. User Account

The Switch allows users to create up to 6 user accounts. The username and password should be the combination of the digits or the alphabet. The last admin user account cannot be deleted. Users should input a valid user account to login the CLI or web management.

User Authority:

The Switch supports two types of the user account, admin and normal. The **default** users account is **username (admin) / password (admin)**.

- Admin - read / write.
- Normal - read only.
; Cannot apply any configurations in web.

The Switch also supports backdoor user account. In the event the user forgot their username or password, the Switch can generate a backdoor account with the system's

MAC. Users can use the new user account to enter the Switch and then create a new user account.

Default Settings

- Maximum user account : 6.
- Maximum user name length : 32.
- Maximum password length : 32.
- Default user account for privileged mode : admin / admin.

Notices

- The Switch allows users to create up to 6 user accounts.
- The user name and the password should be the combination of digits and the alphabet.
- The last admin user account cannot be deleted.
- The maximum length of the username and password is 32 characters.

8.6.1. CLI Configuration

Node	Command	Description
enable	show user account	This command displays the current user accounts.
configure	add user USER_ACCOUNT PASSWORD (normal admin dot1x)	This command adds a new user account with choice of privileges normal/admin/dot1x.
configure	delete user USER_ACCOUNT	This command deletes a present user account.

8.6.2. Web configuration

User Account

User Account Settings

User Name

User Password

User Authority Admin ▾

User Account List

No.	Name	Authority	Action
1	admin	Admin	
2	admin	dot1x	

Parameter	Description
-----------	-------------

User Account Settings	
User Name	Type a new username or modify an existing one.
User Password	Type a new password or modify an existing one. Enter up to 32 alphanumeric or digit characters.
User Authority	Select with which group the user associates. admin (read and write) or normal (read only) for this user account Dot1x user for radius.
Apply	Click Apply to take effect the settings.
Refresh	Click Refresh to begin configuring this screen afresh.
User Account List	
No.	This field displays the index number of an entry.
Name	This field displays the name of a user account.
Authority	This field displays the associated group.
Action	Click the Delete button to remove the user account. Note: You cannot delete the last admin accounts.

WARRANTY & PRODUCT REGISTRATION

3-Year Limited Warranty

TRIPP LITE warrants its products to be free from defects in materials and workmanship for a period of three (3) years from the date of initial purchase. TRIPP LITE's obligation under this warranty is limited to repairing or replacing (at its sole option) any such defective products. To obtain service under this warranty, you must obtain a Returned Material Authorization (RMA) number from TRIPP LITE or an authorized TRIPP LITE service center. Products must be returned to TRIPP LITE or an authorized TRIPP LITE service center with transportation charges prepaid and must be accompanied by a brief description of the problem encountered and proof of date and place of purchase. This warranty does not apply to equipment which has been damaged by accident, negligence or misapplication or has been altered or modified in any way.

EXCEPT AS PROVIDED HEREIN, TRIPP LITE MAKES NO WARRANTIES, EXPRESS OR IMPLIED, INCLUDING WARRANTIES OF MERCHANTABILITY AND FITNESS FOR A PARTICULAR PURPOSE. Some states do not permit limitation or exclusion of implied warranties; therefore, the aforesaid limitation(s) or exclusion(s) may not apply to the purchaser.

EXCEPT AS PROVIDED ABOVE, IN NO EVENT WILL TRIPP LITE BE LIABLE FOR DIRECT, INDIRECT, SPECIAL, INCIDENTAL OR CONSEQUENTIAL DAMAGES ARISING OUT OF THE USE OF THIS PRODUCT, EVEN IF ADVISED OF THE POSSIBILITY OF SUCH DAMAGE. Specifically, TRIPP LITE is not liable for any costs, such as lost profits or revenue, loss of equipment, loss of use of equipment, loss of software, loss of data, costs of substitutes, claims by third parties, or otherwise.

PRODUCT REGISTRATION

Visit www.tripplite.com/warranty today to register your new Tripp Lite product. You'll be automatically entered into a drawing for a chance to win a FREE Tripp Lite product!*

* No purchase necessary. Void where prohibited. Some restrictions apply. See website for details.

Regulatory Compliance Identification Numbers

For the purpose of regulatory compliance certifications and identification, your Tripp Lite product has been assigned a unique series number. The series number can be found on the product nameplate label, along with all required approval markings and information.

When requesting compliance information for this product, always refer to the series number. The series number should not be confused with the marketing name or model number of the product.

FCC Notice, Class A

This device complies with part 15 of the FCC Rules. Operation is subject to the following two conditions: (1) This device may not cause harmful interference, and (2) this device must accept any interference received, including interference that may cause undesired operation.

Note: This equipment has been tested and found to comply with the limits for a Class A digital device, pursuant to part 15 of the FCC Rules. These limits are designed to provide reasonable protection against harmful interference when the equipment is operated in a commercial environment. This equipment generates, uses, and can radiate radio

frequency energy and, if not installed and used in accordance with the instruction manual, may cause harmful interference to radio communications. Operation of this equipment in a residential area is likely to cause harmful interference in which case the user will be required to correct the interference at his own expense. The user must use shielded cables and connectors with this equipment. Any changes or modifications to this equipment not expressly approved by Tripp Lite could void the user's authority to operate this equipment.

Tripp Lite has a policy of continuous improvement. Specifications are subject to change without notice. Photos and illustrations may differ slightly from actual products.



Manufacturing
Excellence.

1111 W. 35th Street, Chicago, IL 60609 USA • triplite.com/support

21-04-334 93-3EE5_RevA